

Antenna Technologies for NASA Applications

This presentation addresses the efforts being performed at GRC to develop antenna technology in support of NASA's Exploration Vision. In particular, the presentation discusses the communications architecture asset-specific data services, as well as wide area coverage, high gain, low mass deployable antennas. Phased array antennas as well as electrically small, lightweight, low power, multifunctional antennas will be also discussed.



Antenna Technologies for NASA Applications

Félix A. Miranda
NASA Glenn Research Center, Cleveland, OH 44135

Felix.A.Miranda@nasa.gov
Tel: 216-433-6589

IDGA's Military Antenna Systems Conference
Westin Arlington Gateway, Arlington, VA
September 19-20, 2006



Outline of Presentation

- The Vision for Space Exploration
- Communications Architecture for Exploration
- Asset-Specific Communications Requirements
- Technology Development at Glenn Research Center
- Summary



A Bold Vision for Space Exploration

- ◆ **Complete the International Space Station**
- ◆ **Safely fly the Space Shuttle until 2010**
- ◆ **Develop and fly the Crew Exploration Vehicle no later than 2014 (goal of 2012)**
- ◆ **Return to the Moon no later than 2020**
- ◆ **Extend human presence across the solar system and beyond**
- ◆ **Implement a sustained and affordable human and robotic program**
- ◆ **Develop supporting innovative technologies, knowledge, and infrastructures**
- ◆ **Promote international and commercial participation in exploration**



"It is time for America to take the next steps.

Today I announce a new plan to explore space and extend a human presence across our solar system. We will begin the effort quickly, using existing programs and personnel. We'll make steady progress – one mission, one voyage, one landing at a time"

*President George W. Bush –
January 14, 2004*

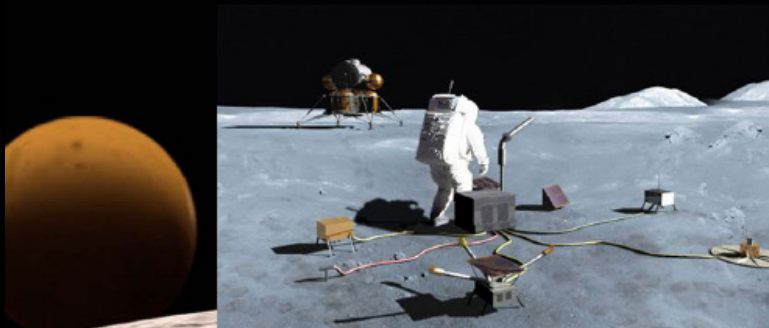



Communications Architecture



Assessment of Existing NASA Communications Capability



- Limited lunar coverage
- Existing Earth-based Tracking and Data Relay Satellite System (TDRSS) can presently provide limited Low Earth Orbit (LEO) and translunar backup systems for critical communications in lunar vicinity due to area coverage limitations
- Ground Networks (GN) can provide LEO and translunar short pass duration communications
- Large aperture Deep Space Network (DSN) antennas (26m, 34m, 70m) can provide excellent high-rate coverage in lunar vicinity
- Limited Mars communications data rates and numbers of connections
- Limited precision Mars navigation capability



Space Communication Architecture Working Group (SCAWG)

NASA Space Communication and Navigation Architecture
Recommendations for 2005-2030

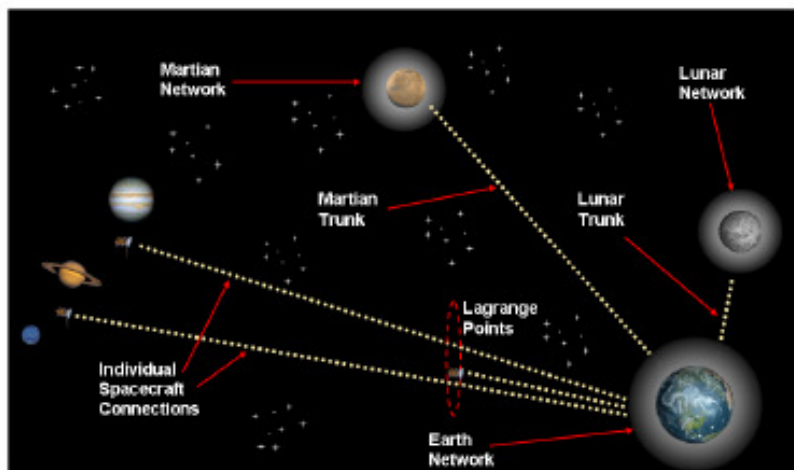

15 May 2006
Final Report

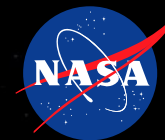

**Space
Communications
Architecture Final
Report is available.**

[https://www.spacecomm.
nasa.gov/spacecom/](https://www.spacecomm.nasa.gov/spacecom/)

Top Level Conceptual Communication Architecture ~2030

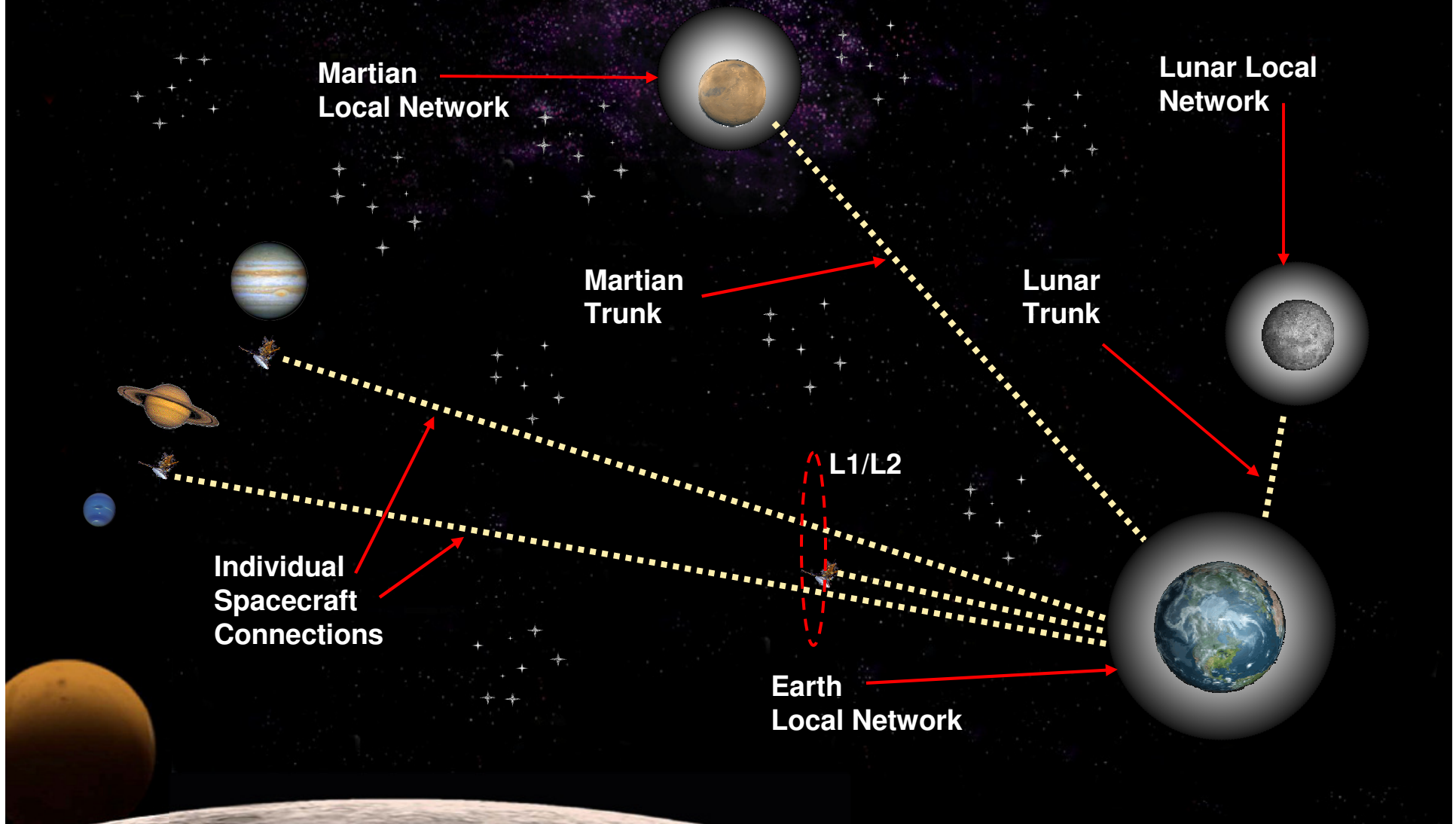

Lunar Communications Assets

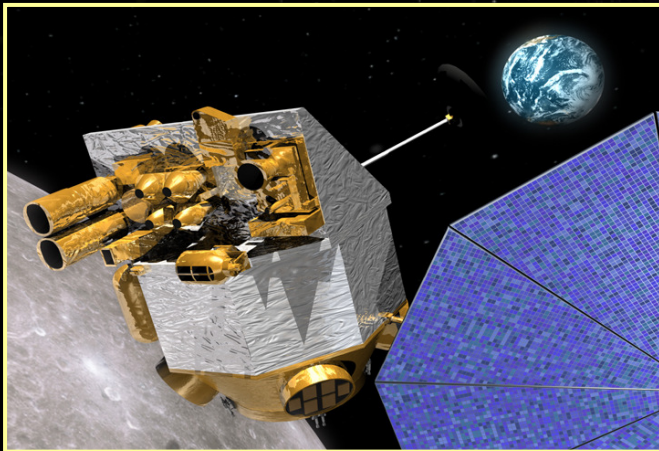
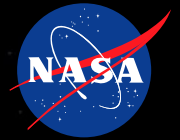

Lunar Reconnaissance Orbiter (LRO)

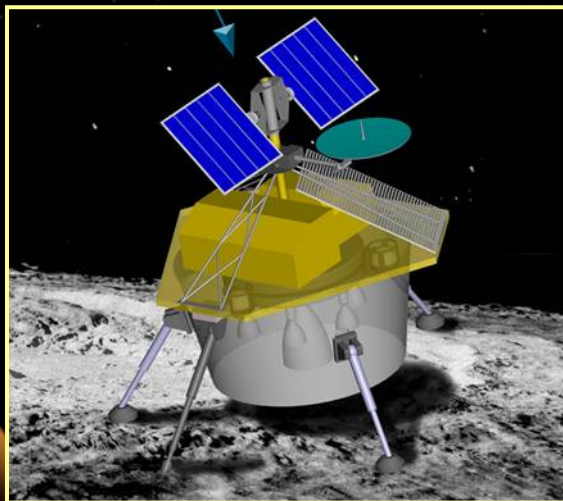

Robotic Lunar Lander

UHF&S-Band

Tx/Rx to Moon

125 bps to 256 kbps

S-Band

Tx/Rx direct to Earth

2.186 Mbps QPSK

Ka-Band

Tx to Earth

>100 Mbps

VHF/UHF*

Surface Comm.

(Data Rates: TBD)

S-Band*

Surface Comm.

Tx/Rx relay to Earth

(Data Rates: TBD)

Ka-Band*

Tx to Earth

(Data Rates: TBD)

** Probable communications frequencies*

Mars Communications Assets

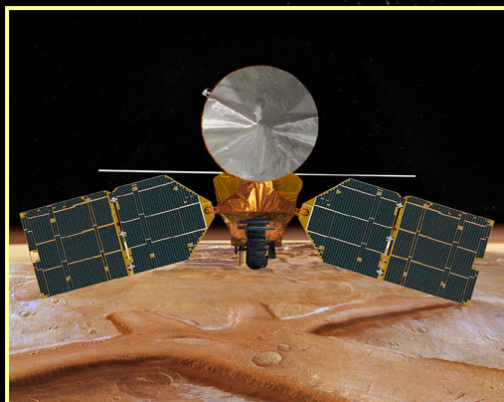

UHF Tx/Rx to Mars
100 kbps - 1 Mbps

X-Band Tx/Rx to Earth
300 kbps

Ka-Band Tx to Earth
5 Mbps BPSK

Mars Reconnaissance Orbiter (MRO)

Arrival Date: March 10, 2006



UHF Tx/Rx to Mars
128 kbps

X-Band Tx/Rx to Earth
128 kbps

Mars Odyssey

Arrived October 24, 2001



UHF Tx/Rx to Mars
128 kbps

X-Band Tx/Rx to Earth
20 kbps

Ka-Band Tx to Earth
85 kbps (max)

Mars Global Surveyor (MGS)

Arrived September 12, 1997

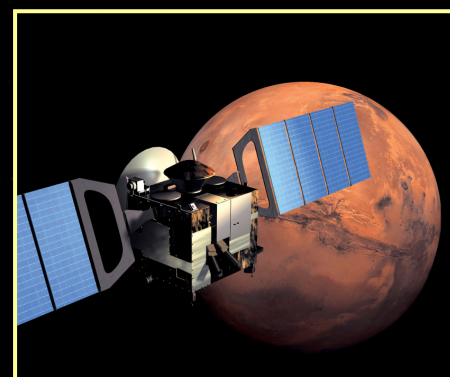

UHF Tx/Rx to Mars
128 kbps

S-Band Rx from Earth
up to 2 kbps

X-Band Tx to Earth
230 kbps

Mars Express (ESA)

Arrived December 25, 2003



Asset-Specific Communications Nominal Specifications



Surface Communications Architecture (~2030)



- Surface assets (e.g., nodes) communicate via each other and a centralized hub
- Surface Wireless Local Area Network (SWLAN) infrastructure to connect astronauts with rovers, probes, habitat, and each other
- Ad-hoc proximity networking amongst assets
- Access point (relay) towers to extend communication capabilities range

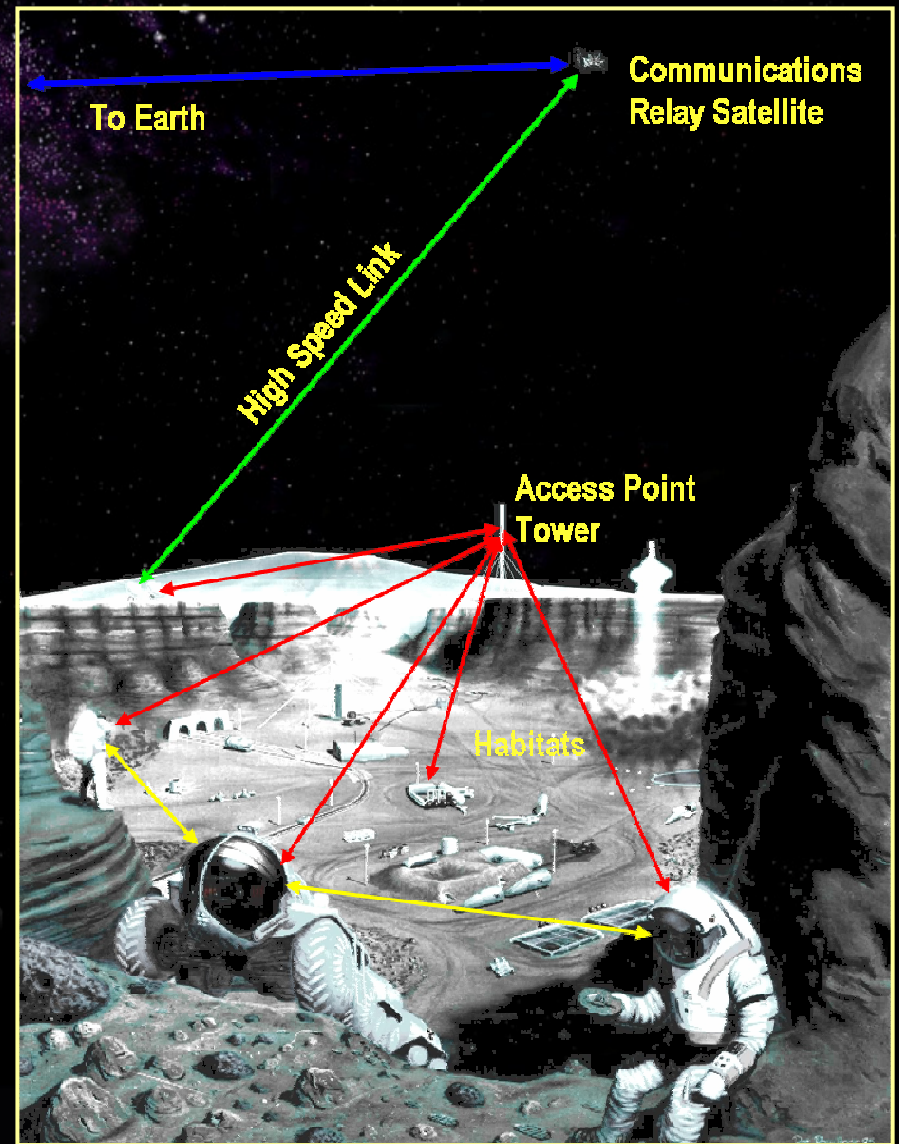

Surface Communications Assets



Astronaut EVA Suit

Data Services

Audio*	8-64 kbps/channel (at least 4 channels)
TT&C*	< 100 kbps
SDTV Video	6 Mbps
HDTV Video	19 Mbps
Biomedical Control*	70 kbps
Biomedical Monitoring*	122 kbps

*Must be Reliable Links

Limited power/space availability

UHF/S-Band surface comm. frequencies

- *Reliable links require low BER*
- *Antennas should be small, efficient, and wideband/multiband to accommodate desired frequencies and data services in a restricted space.*
- *Multiband important for Software Defined Radio (SDR) to reduce size, weight, and Power (SWaP)*

Surface Communications Assets



Habitat

- Mobile Nodes with data-intensive mission requirements for surface-based exploration.
 - Characterized by entities of moderate size and free to move about the lunar surface (e.g., rovers, pressurized vehicles, astronauts, robots)
 - Tightly constrained by power, mass and volume.
- ***Antennas should be low/self-powered, small, and efficient, and compatible with communication equipment that can provide high data rate coverage at short ranges (~1.5-3 km, horizon for the moon for EVA).***
- Small Nodes: support fixed and mobile nodes, and connect to the network by wired or wireless interface.
 - Sensors, small probes, instruments and subsystems of very small size, limited power levels, and short range (~10 m) low data rate communications.
- ***Antennas should be low/self-powered, small, and efficient.***
- Large, fixed nodes: Serves as base for surface activities.
 - Centralized Hub/Habitat for immediate area coverage
 - Transmission of data to surface and space assets
 - Can support larger communication hardware and higher data rates over long distances.
- ***Smart/reconfigurable antennas, multibeam antennas, lightweight deployable antennas are viable technologies (10-30 Km)***

Space Communications Assets

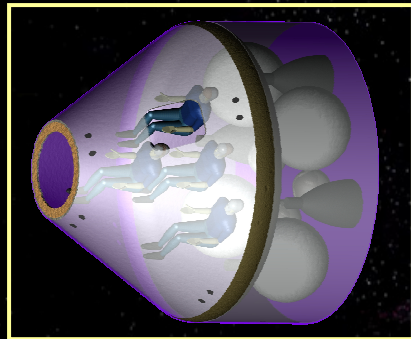

Crew Exploration Vehicle
(CEV)

- Robotic Lunar Exploration Program (RLEP-1,2)
- Lunar Reconnaissance Orbiter (LRO) (RLEP-1)
- Crew Launch Vehicle (CLV)
- Crew Exploration Vehicle (CEV)

➤ *Antenna Requirements: Conformal, Reconfigurable or Multiband antennas, phased arrays (most likely S-band for Initial CEV, with omni or patch antennas).*

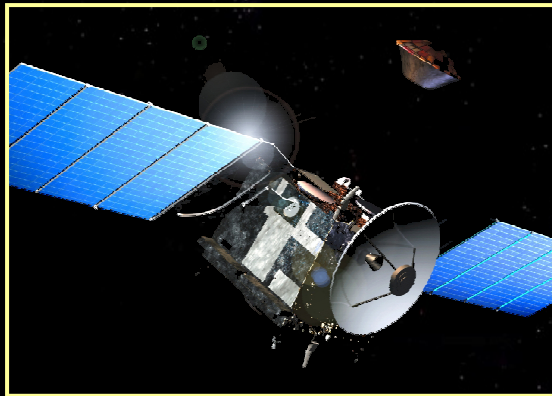

Satellite Systems

- Relay satellites (around the moon (e.g., LRO after its initial prospecting mission, it could be elevated to elliptical orbit for relay purposes); around Mars; etc.)
- Relay satellites (L1/L2)
- The intended orbit will drive the type of antenna technology.

➤ *In Orbit: Gimbled dish? (slew rate driven), reflectarrays, phased array antennas, deployable/inflatable arrays*

Antenna Technology Summary



Surface/ Surface Communications	Potential Frequencies	Desirable Antenna Technologies	
EVA Suit	UHF/VHF S-band	<ul style="list-style-type: none"> • Miniature Antennas • Multi-directional (to support mobility) • Wearable Antennas 	<ul style="list-style-type: none"> • Dipole/Monopole (omni-directional coverage)
Rovers	UHF/VHF S-band	<ul style="list-style-type: none"> • Miniature Antennas • Omni antennas 	<ul style="list-style-type: none"> • Phased Arrays (pitch/roll compensation)
Probes	UHF/VHF S-band	<ul style="list-style-type: none"> • Miniature Antennas • Dielectric Resonator Antennas • Wideband Antennas 	<ul style="list-style-type: none"> • Solar Cell Integrated Antennas • Retrodirective Antenna
Habitat/Surface Relays	HF (OTH Propagation) S-band X-band	<ul style="list-style-type: none"> • Deployable Antennas • Multi-directional coverage (to support mobility) • Smart/reconfigurable Antennas 	<ul style="list-style-type: none"> • Multi-beam Antennas (to support connectivity to different nodes) • Citizen band antennas



Antenna Technology Summary

Surface/Orbit Communications	Potential Frequencies	Desirable Antenna Technologies	
CEV	S-band X-band Ku/Ka-band	<ul style="list-style-type: none">• Phased Arrays• Wideband/Multiband• Conformal Antennas	<ul style="list-style-type: none">• Frequency Selective Surface (FSS) Antennas
Satellites	UHF S-band X-band Ku/Ka-band	<ul style="list-style-type: none">• Gimbaled Dish• Phased Arrays• Deployable Antennas• Multi-Beam antennas	<ul style="list-style-type: none">• High Gain Antennas
Rovers	UHF S-band	<ul style="list-style-type: none">• Miniature Antennas	<ul style="list-style-type: none">• Phased Arrays
Probes	UHF	<ul style="list-style-type: none">• Miniature Antennas• Solar Cell Integrated Antennas	<ul style="list-style-type: none">• Patch antennas• Retro-directive Antenna



Antenna Technology Development at Glenn Research Center

GRC Antenna Research Heritage



Rcv Array / Boeing
20 GHz (MASCOM)

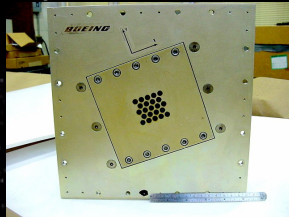
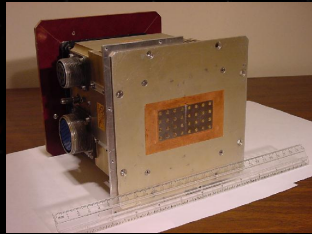

Rcv Array / Boeing
20 GHz (ICAPA)

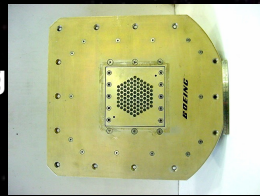

Rcv Array / Martin
20 GHz

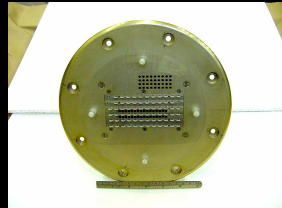

Rcv/Xmt Array
AATT/WINCOM
Ku-Band / Boeing



Multibeam
Antenna

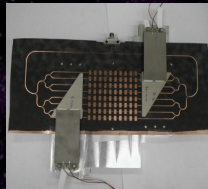

Reflectarray Antenna
SCDS 615 Element
Prototype + Ka-Band
Space Qualifiable

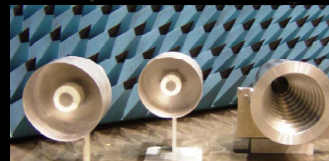
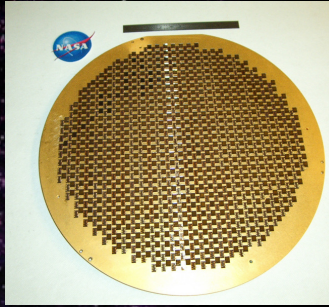

TDRS C Candidate
Cup Waveguide

Space Fed Lens
Array EO-1 in
Collaboration with
GSFC



Ka-band 256 Element
Boeing Phased Array

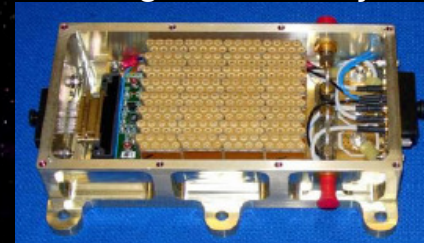

Shape
Memory
Polymer
Reflector



Large
Inflatable
Gossamer
Antennas

*Phased Array Prototypes
Technology Demonstrations,
and SATCOM On-The-Move*

*Advanced Phased Array Concepts
and Materials + Large Gossamer
Deployable Antennas*

*Space Quality Phased Arrays,
Deployable Antennas with Articulated
Feeds, Space Experiments, Lunar and
Mars Exploration and Earth Science*

1990's

2000

2020

Technology Readiness Level

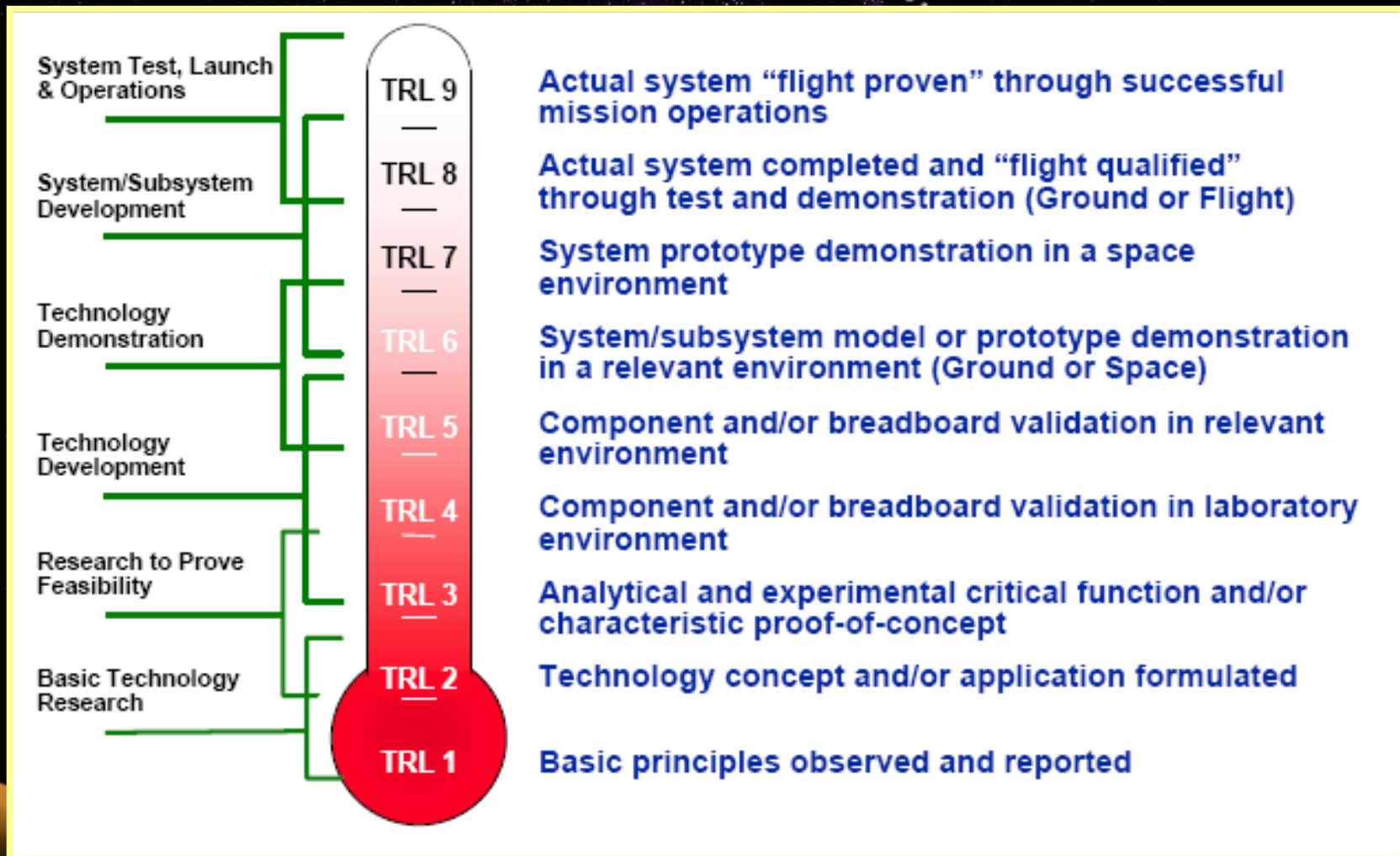

Large Aperture Deployable Antennas



(X-, and Ka-Band: TRL 4)

Benefits

- Reduced mass ($\sim 1 \text{ kg/m}^2$)
- Low fabrication costs
- High packaging efficiencies (as high as 50:1)
- Proven performance at S-Band & L-Band frequencies

Issues

- Stringent RMS surface accuracy requirements at high frequencies (i.e. Ka-Band)
- Development of reliable deployment mechanisms
- Thermal response
- Rigidization

Potential Applications

- Deep space relay station concept
- Backup satellite antenna systems
- Erectable surface communications relays

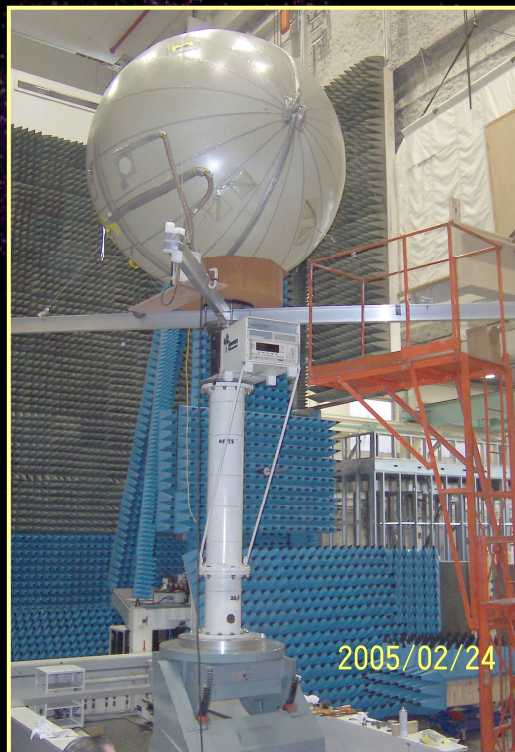

2.5 m "Beach Ball" Antenna



4 x 6 m offset parabolic

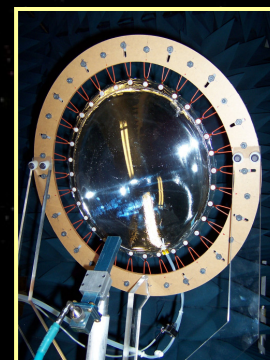

0.3 m Parabolic Antenna

Large Aperture Inflatable Antennas



Space Applications

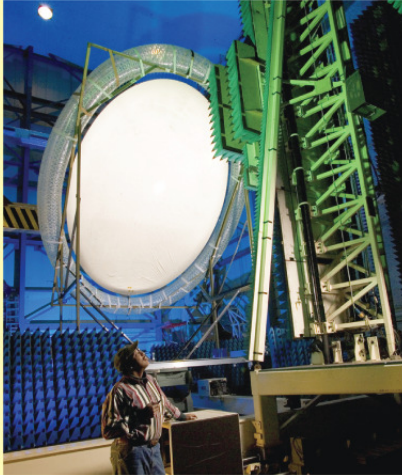

4- by 6-m inflatable offset parabolic membrane antenna test in GRC near-field facility

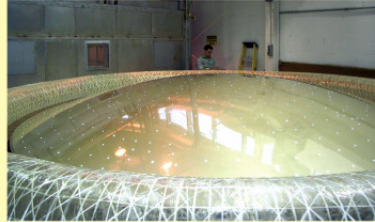

4- by 6-m inflatable offset parabolic membrane antenna inflation test (human in the background)

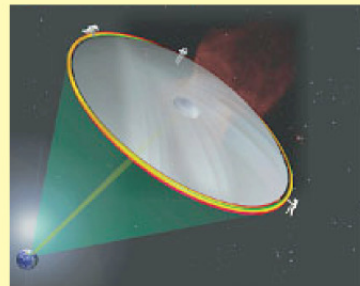

Deep-space relay station concept



Overhead photograph of 4- by 6-m inflatable reflector in GRC near field facility

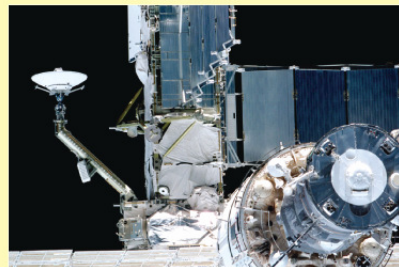

Backup 2-m inflatable Cassegrain reflector for ISS Ku-band system

Surface Applications

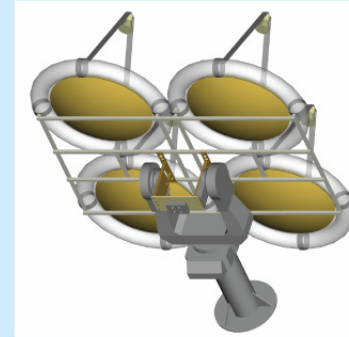

Low-cost tracking ground station experiment in collaboration with Goddard Space Flight Center planned for May 2005

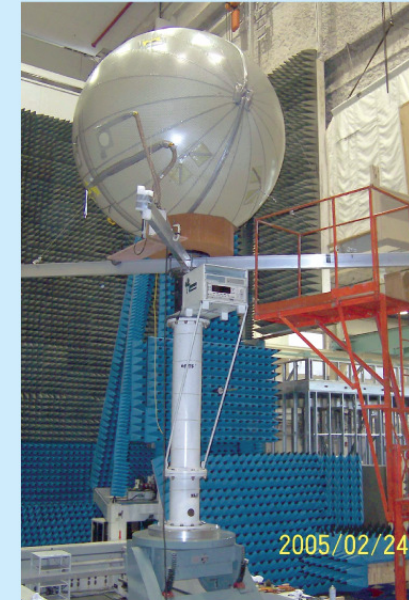

2.5-m inflatable membrane antenna in inflatable radome for ground applications

Goals:

- Develop large, lightweight reflector antennas with areal densities $< 0.75 \text{ kg/m}^2$, for Lunar, Mars, and deep-space relay exploration applications.
- Develop rigidization techniques (e.g., ultraviolet curing) to eliminate the need for makeup inflation gas.
- Demonstrate a ratio package to deploy volume greater than 1:75.
- Demonstrate quick deployment of large apertures for ground-based and planetary surface applications.

“Terrestrial” Deployable Antennas

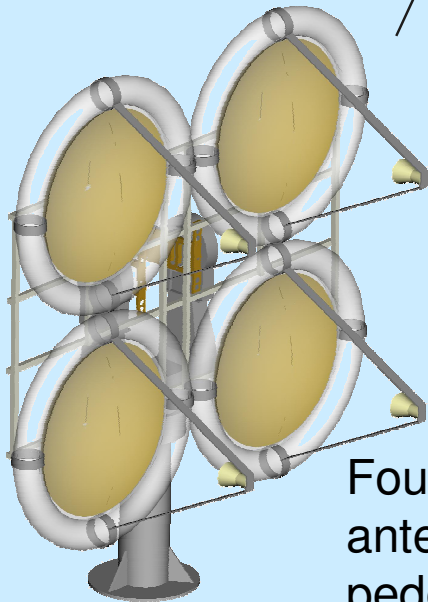
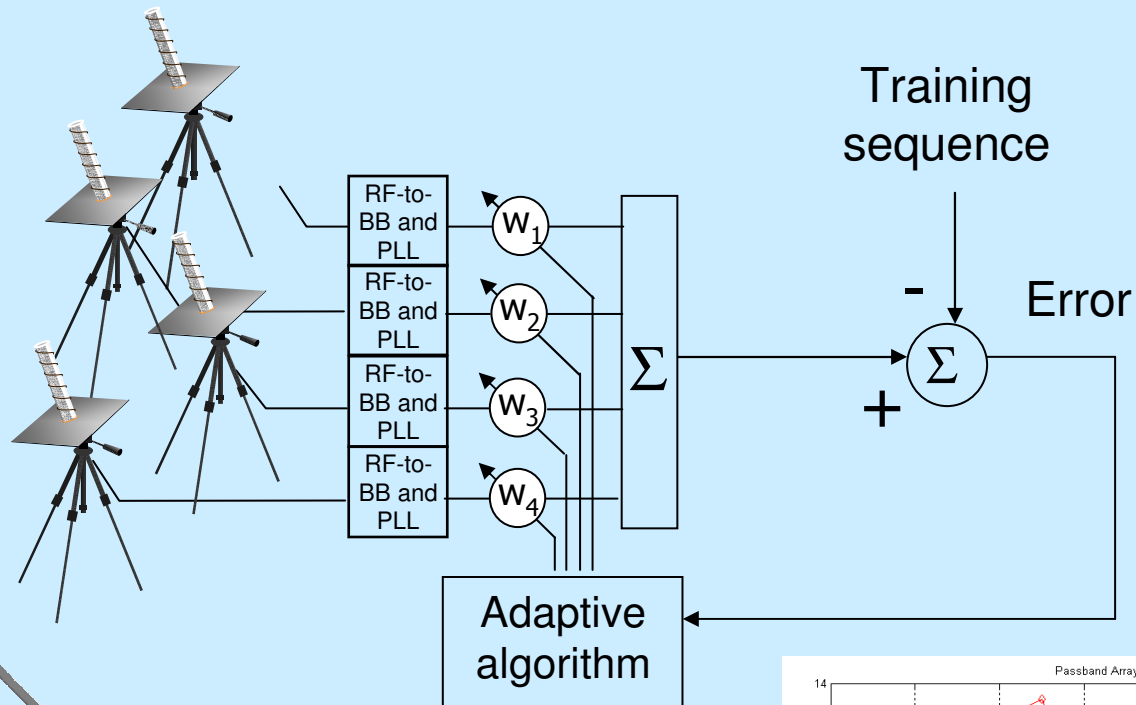

Four 1-meter inflatable membrane antennas under assembly and pedestal array concept

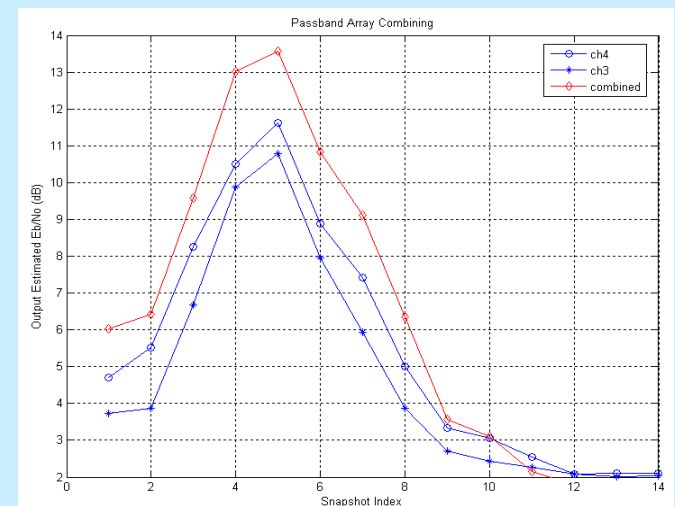

4 Element Inflatable Antenna Array

August 2005



- Georgia Tech “GCATT” building adaptive array algorithm verification Experiment with the SAC-C satellite August 22-25, 2005

Large Aperture Deployable Antennas



(X-band: TRL 3)

Hybrid Inflatable Antenna

- Combines traditional fixed parabolic dish with an inflatable reflector annulus
- Redundant system prevents “all-or-nothing” scenarios
- Based on novel shape memory composite structure
- High packing efficiency

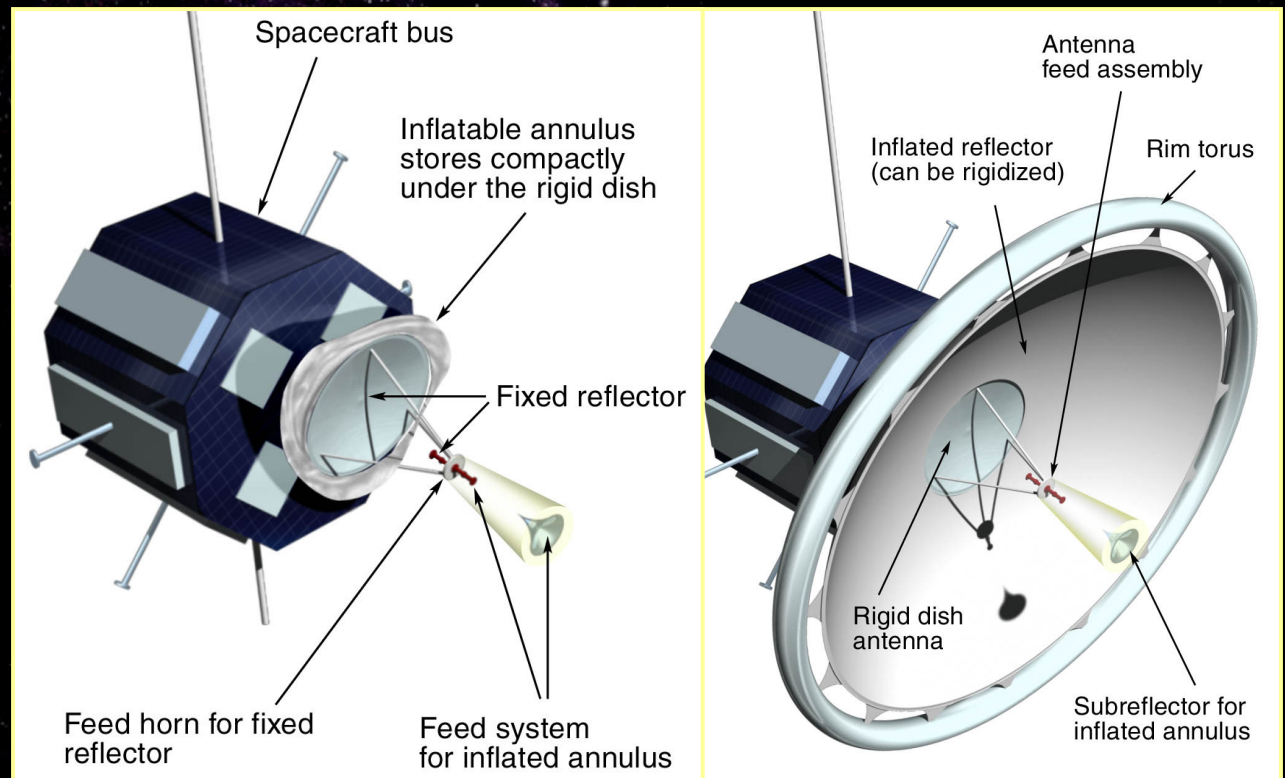

JHU/APL under NASA Grant

- (1) Low cost fabrication and inflation of an annulus antenna
- (2) Overall surface accuracy 1 mm
- (3) Negligible gravity effects
- (4) Elimination of large curve distortions across the reflector surface (i.e. Hencky curve)

Phased Array Antennas

(K-, and Ka-Band: TRL 9)

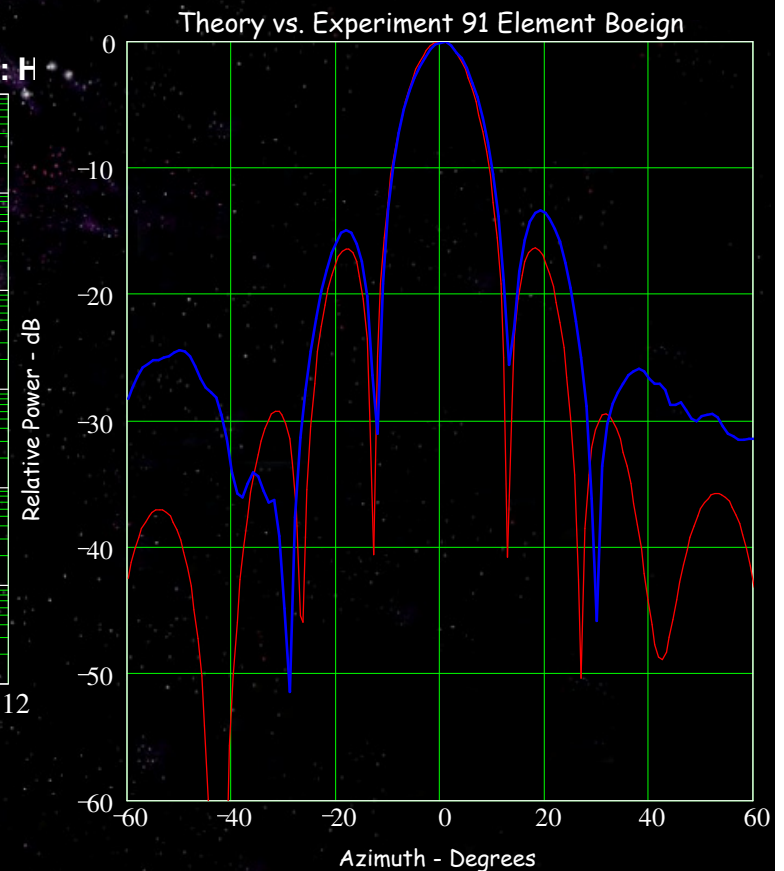
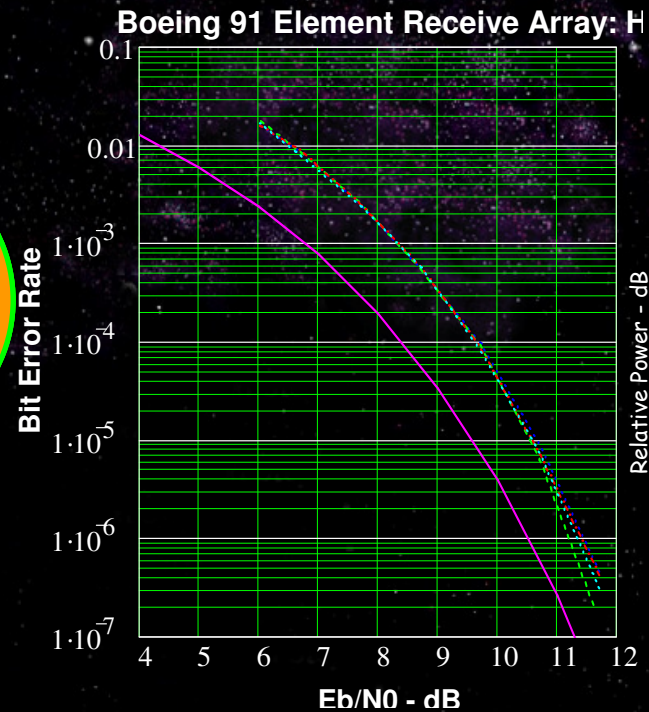
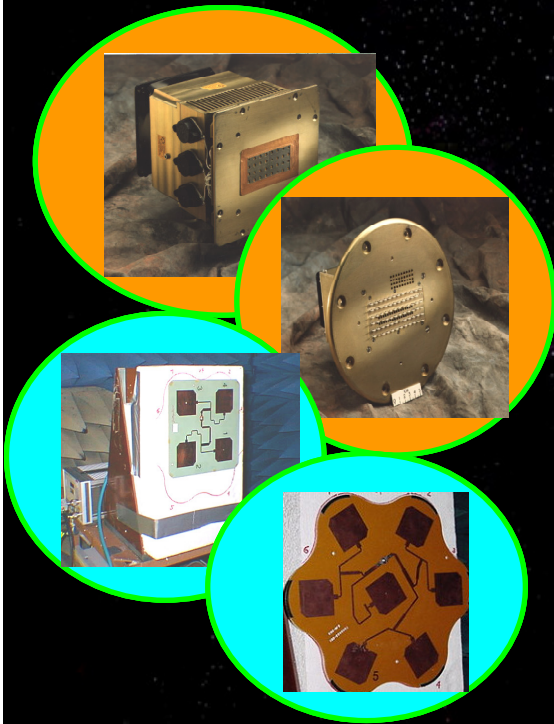

Benefits

- Electrically Steerable
- Conformal
- Graceful degradation
- Multi-Beam
- Fast Scanning/acquisition
- S-, X-, Ku-, K-, and Ka-Band

Issues

- Low MMIC efficiency (thermal management problems)
- Cost per module
- FOV (limited to +/- 60°)

Potential Applications

- CLV, CEV
- Robotic Rovers
- Satellite Systems
- Surface Communications

GRC Low Cost Electrically Steerable Array Antenna Road Map



1990 - 1998

2000 - 2006

Past Significant GRC Ka-band phased array developments

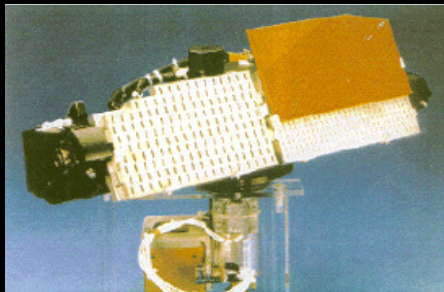

Mechanically steered Array
proof-of-concept



32 element breadboard proof-of-concept

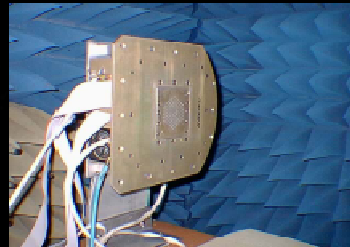

91 element breadboard proof-of-concept

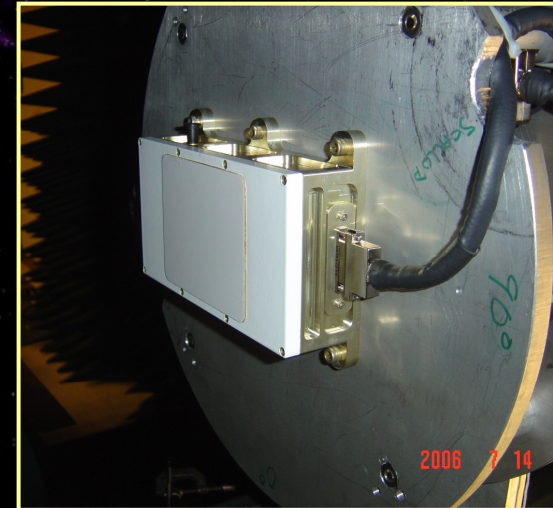

Parameter	Forward Link	Return Link
Ka-band Frequency Plan	30	20
Channel Bandwidth	9.6Kbps (NB) 1.5Mbps (WB)	9.6 – 128 Kbps (NB) 1.5Mbps (WB)

Parameter	Forward Link	Return Link
Ka-band Frequency Plan	22.555 – 23.545	25.545 – 27.195
Channel Bandwidth	50 MHz	650 MHz

- 1990-1998 : Funding Source ACTS
- 2000-2003 : Funding Source SCDS

256-Element Ka-Band Phased Array Antenna (PAA)



Summary Array Specification (Boeing)

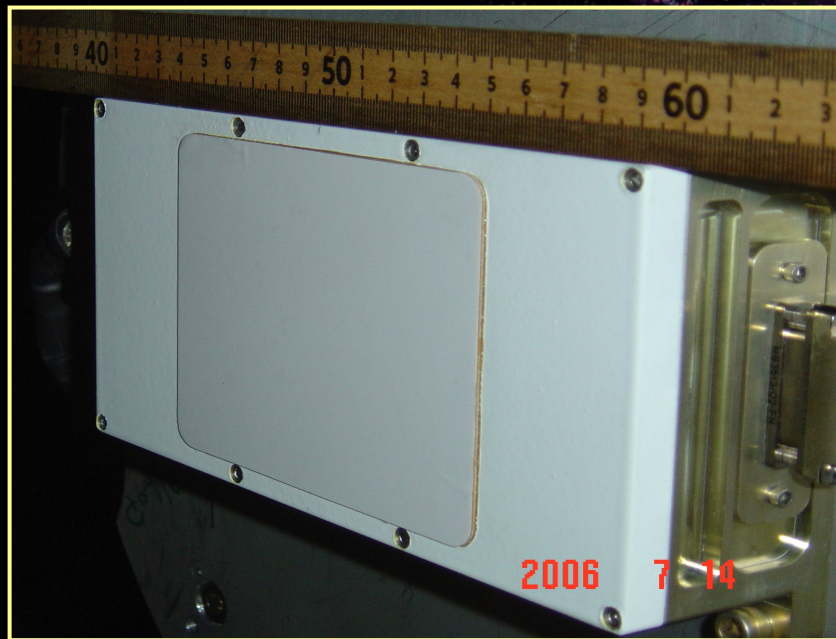

256 Elements Array (Boeing)

Array Number of Elements	256 Elements
Frequencies	25.5-27.5 GHz
Bandwidth	> 1 GHz
Gain (CP)	28 dBi
Antenna EIRP	Peak 36.5 dBW @ 60 Degrees 33 dBW
Antenna 3 dB - Beam width	Nominal 5 Degrees
RF Input Drive Level	130 mW (1 beam)
Array Total DC Power	90 Watts (1 beam)
DC Power Supply	+28 V (± 7V)

Two Principal Planes Cuts Antenna (Beam 1)



LHCP w/RHCP off, $\phi = 0$
(Measured by Boeing)

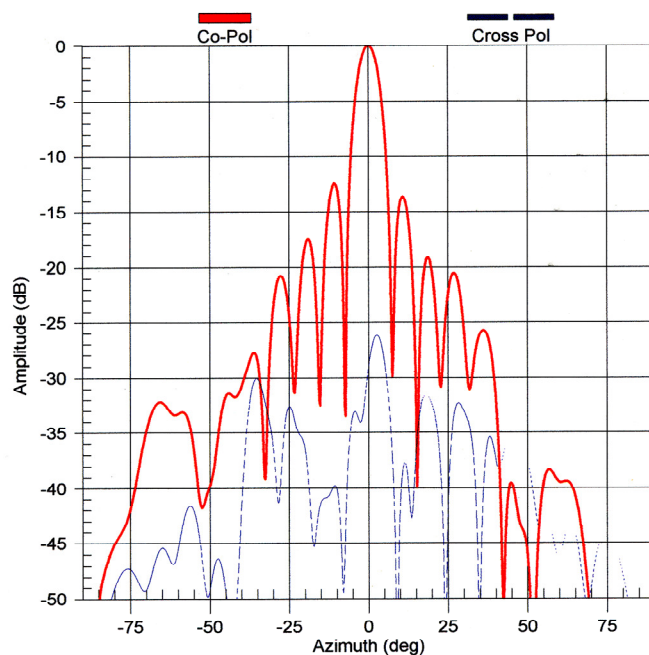

- AR < 1.1
- Directivity (estimated from pattern measurements) : 27.6 dBi
- Directivity (predicted no M-coupling) : 28.2 dBi
- Beamwidth: 6.7 deg

LHCP w/RHCP off, $\phi = 90$
(Measured by Boeing)

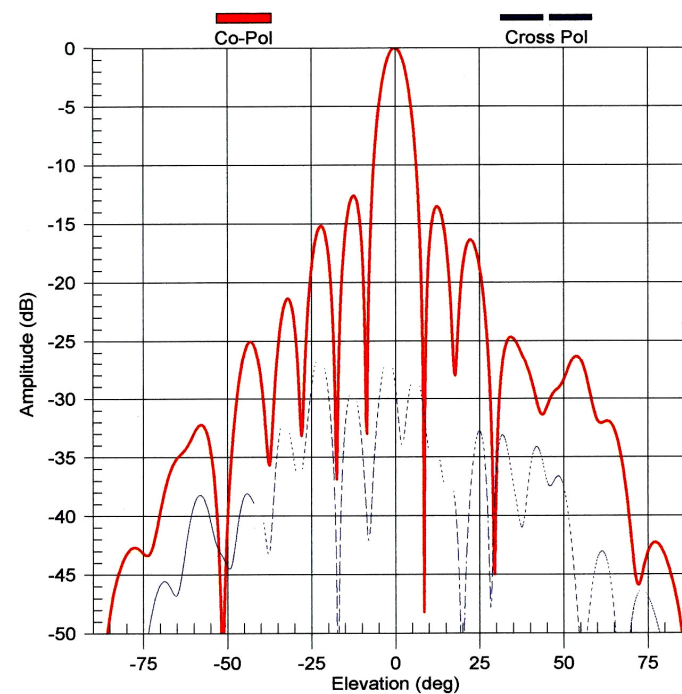

- AR < 1.1
- Directivity (estimated from pattern measurements) : 27.6 dBi
- Directivity (predicted no M-coupling) : 28.2 dBi
- Beamwidth: 7.7 deg

Ferroelectric Reflectarray Development

(K-band: TRL 3)

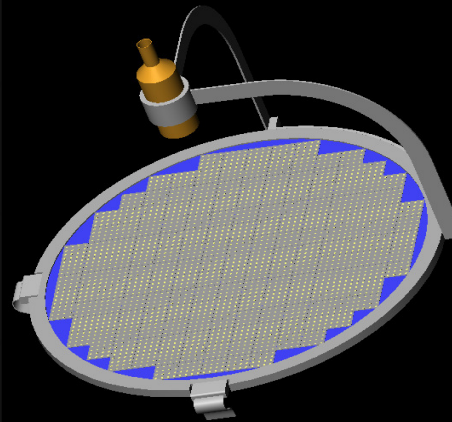
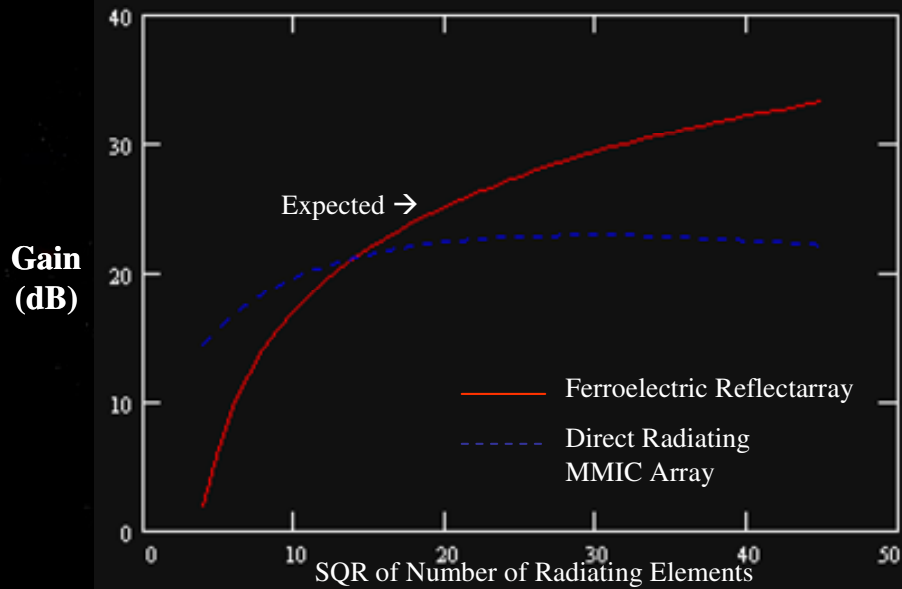

19 GHz 615 Element Prototype

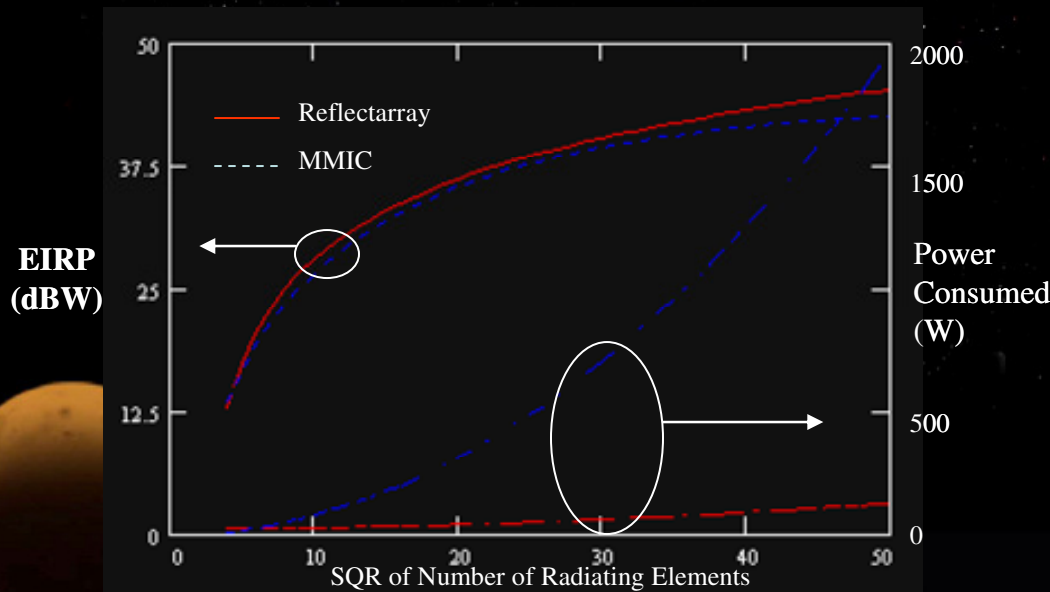

Benefits

- High efficiency
- Zero manifold loss
- Electronically steerable
- Lightweight, planar reflector

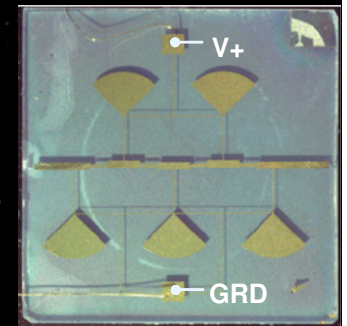

Potential Applications

- Satellite Antenna Systems
- Ground-based Deep Space Network Array



Next Generation Deep Space Network Concept

- Achieving required Ka-band surface tolerance difficult for very large apertures
- Large antenna cost proportional to (diameter)^{>2}
- Advances in Digital Signal Processing make arraying a large number of “small” antennas feasible

GRC Antenna Farm Concept Based on Reflectarray Technology

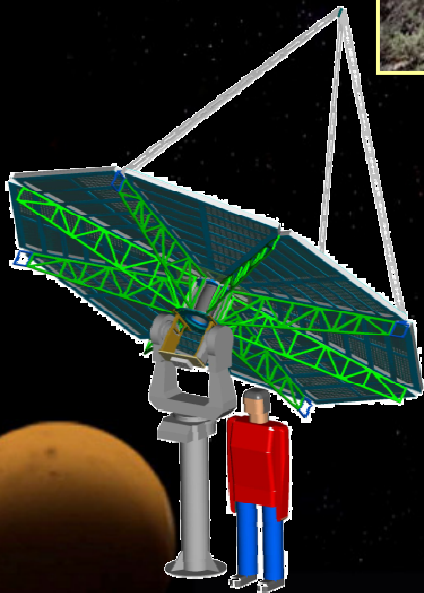
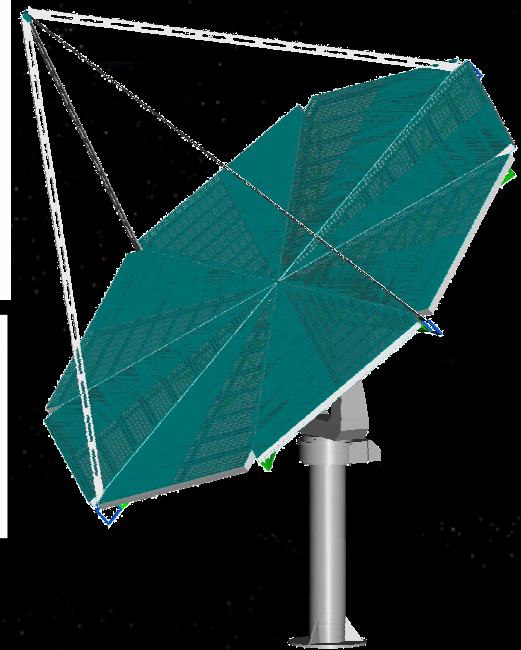
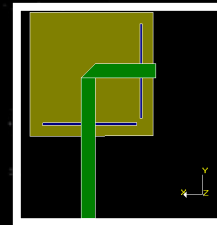
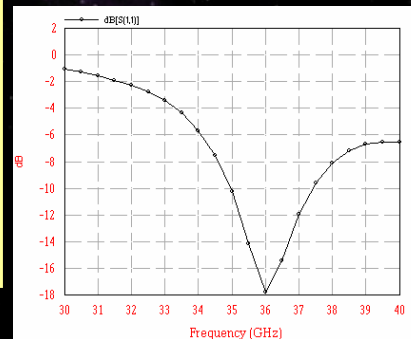

4 m prototype

Flat panels containing printed microstrip patch radiator arrays assembled into circular aperture to save weight and manufacturing cost. Benefits cascade because of simplified gimbal drive systems and reduced maintenance

Multi-Beam Antennas

(S-, Ka-band: TRL 4)

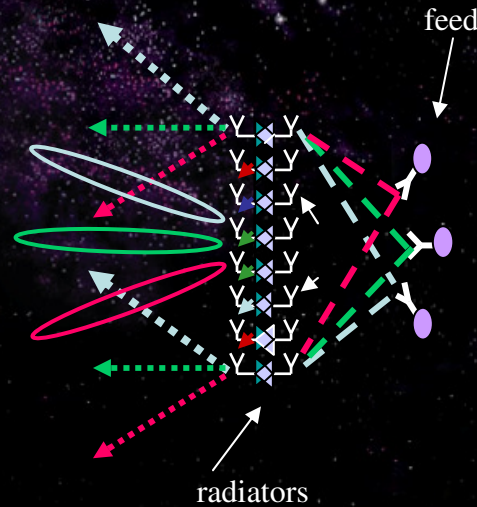
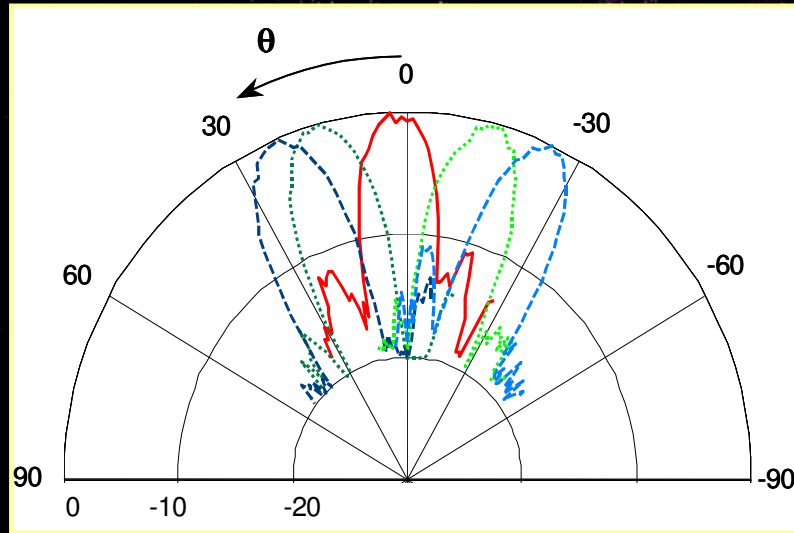

Benefits

- No manifold losses
- Capable of multiple beams
- Pseudo conformal

Potential Applications

- Smart Antenna Systems
- Ground-based Communications (i.e., Habitat, Relays)
- Satellite Constellations

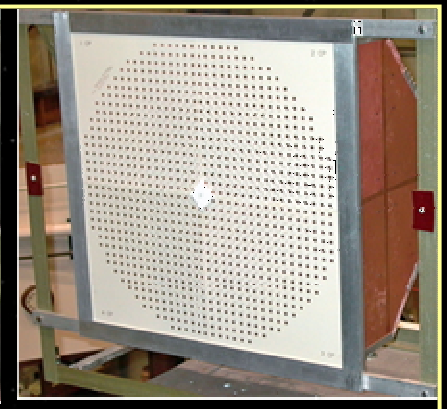
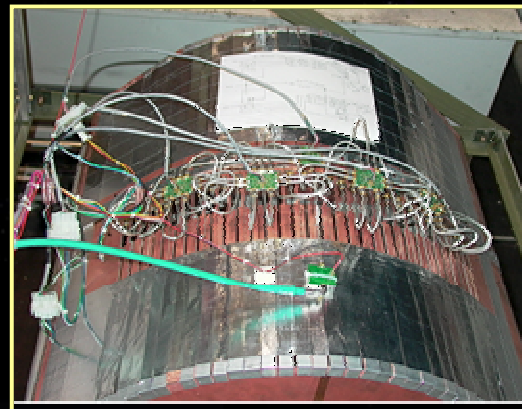

Collaboration with Dr. Z. Popovic University of Colorado, Boulder

TDRSS-C Antenna Development





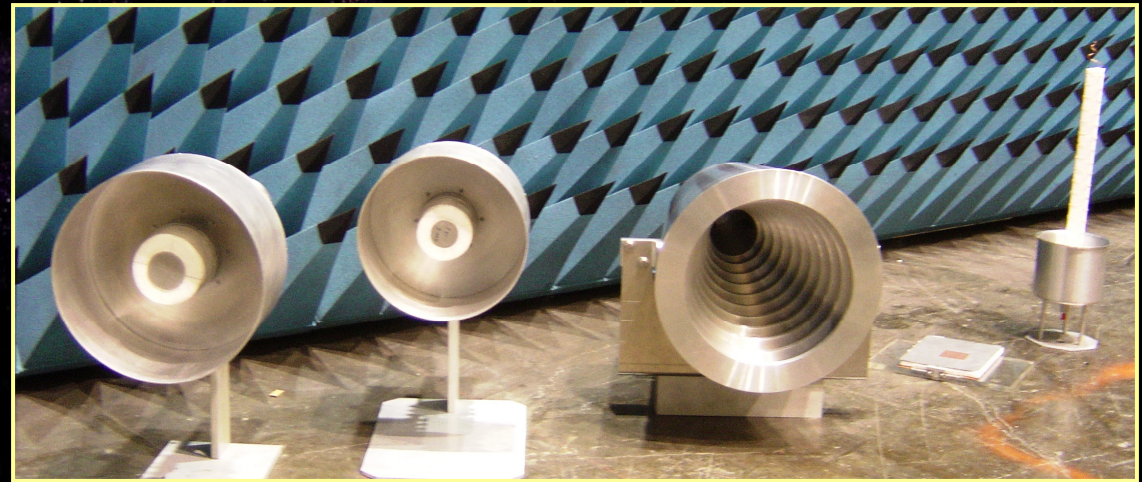

(S-band: TRL 4)

- Next generation TDRSS to implement beam forming between S-band Single Access and Multiple Access antennas
- GRC responsible for antenna element design, construction and characterization of candidate antennas for next generation Multiple Access phased array



Potential Applications

- Satellite Antenna Systems

Specification	Bandwidth 2.0 – 2.3 GHz WB 2.2 – 2.3 GHz NB	Directivity >15 dBi Peak	Directivity at ± 20 deg. > 10 dBi	Axial Ratio < 5 dB ± 20 deg. LHCP, RHCP	Pol. Isolation < -20 dB	Return Loss < -20 dB Port Isolation < -10 dB	Mounting Footprint (Diameter)
Cup-Waveguide (Wideband) 	NB Meets WB MEETS	Meets	Meets	Meets LHCP, RHCP	Meets	Meets	Meets 11.5 in
Cup-Waveguide (Narrowband) 	NB Meets	Meets	Meets	Meets LHCP, RHCP	Meets	Meets	Meets 10.6 in
Horn 	NB Meets	Meets	Meets	Meets LHCP, RHCP	Meets	Meets	DNM* 14.5 in
Helix 	NB Meets	Meets	Meets	Meets LHCP	NA	Meets	Meets 6.0 in
Cup-Patch 	WB Meets	Meets	Meets	Meets LHCP, RHCP	Meets	Meets	Meets 12.5 in



SMALL ANTENNAS (TRL 1-3)

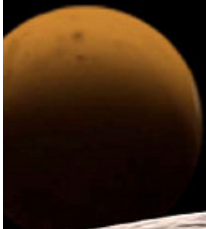

Antenna Technologies for Future NASA Exploration Missions



Description and Objectives:

- Develop new design concepts and candidate miniature antenna structures capable of supporting the communication needs of future Lunar and Martian surface exploration activities.
- Develop compact, self-powering, self-oscillating communications package utilizing miniature antenna development effort.
- Perform trade-off studies among in-house miniature antenna designs and state-of-the-art commercial off-the-shelf (COTS) antennas for Exploration Missions.
- Develop processing algorithm for a randomly distributed network of Lunar surface sensors to enable a surface-to-orbit communication without the need of a Lunar surface base station.

Technology Products:

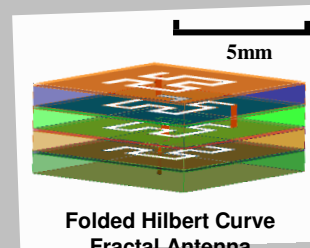

Folded Hilbert Curve Fractal Antenna

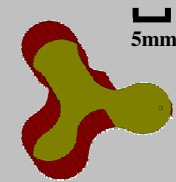

Compact Microstrip Monopole Antenna

TRL_{in} = 2
TRL_{out} = 3

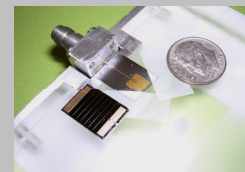

Solar Cell Integrated Antenna

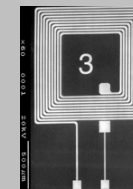

Miniaturized antenna for Bio-MEMS Sensors

TRL_{in} = 2
TRL_{out} = 3

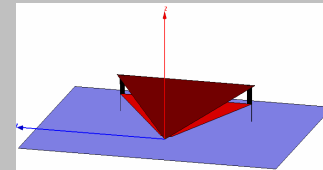

Two-layer Sector Miniature Antenna

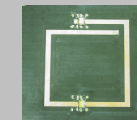

MEMS Integrated Reconfigurable Antenna

TRL_{in} = 2
TRL_{out} = 3

Application: Lunar Surface Exploration Missions

- Robots and Rovers
- Surface Sensors/Probes
- Astronaut EVA
- Nanosatellites

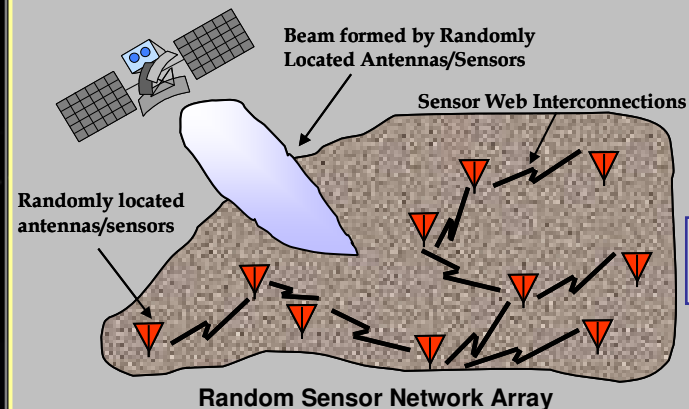
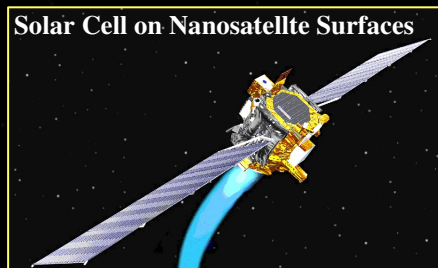

TRL_{in} = 2
TRL_{out} = 3



Miniature Antennas

(S-, Ku-/Ka-band: TRL 3)

S-Band

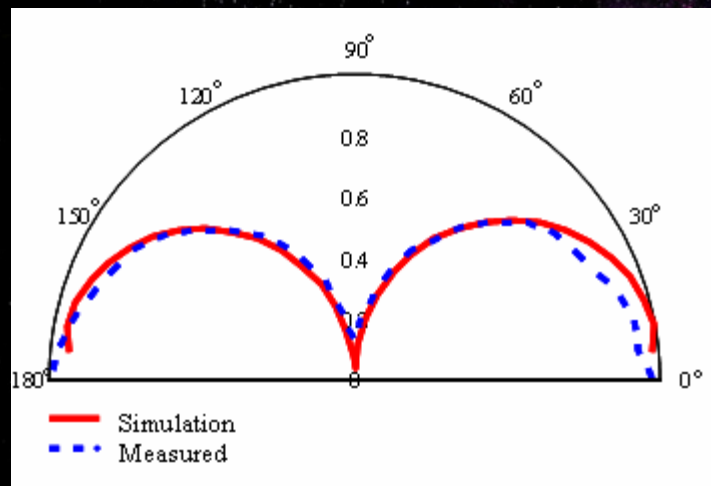

Surface-to-Surface

Ku/Ka-Band

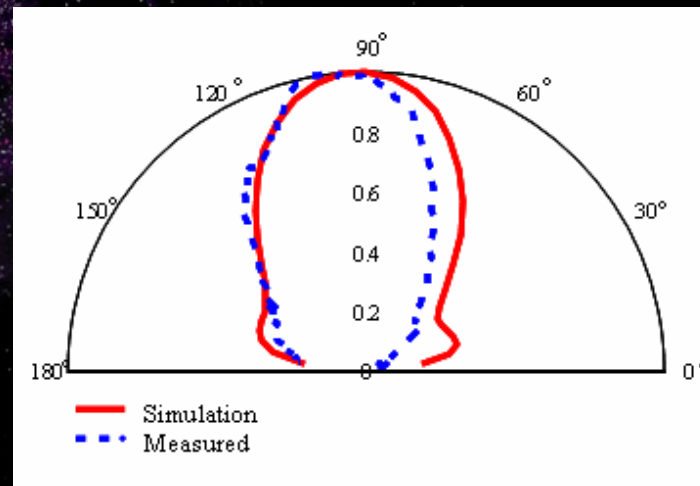

Surface-to-Orbit

Benefits

- Provides optimal radiation patterns for surface-to-surface and surface-to-orbit communications at relevant frequencies without switches

Potential Applications

- Sensors/probes
- Robotic rovers
- Astronaut EVA

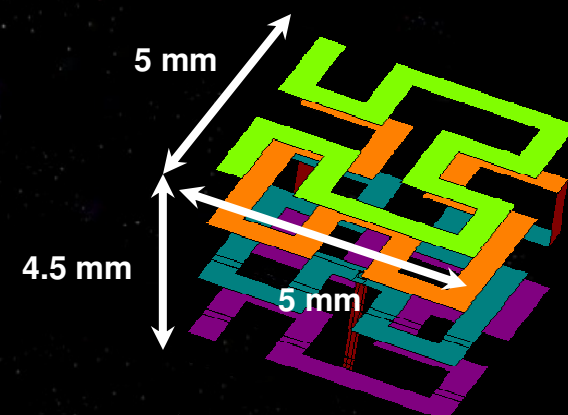

Folded Hilbert Curve Fractal Antenna

folded Hilbert Curve Fractal Antenna (fHCFA)



Design Concept:

- Fractal antenna geometry allows for unique wideband/multi-band operation due to pattern-repetitive nature of fractal shapes. Geometry also allows for antenna miniaturization, similar to meander lines, but with more efficient space utilization.
- Develop an antenna based on a 3rd order Hilbert curve geometry folded upon itself (multilayer) to further decrease antenna footprint.

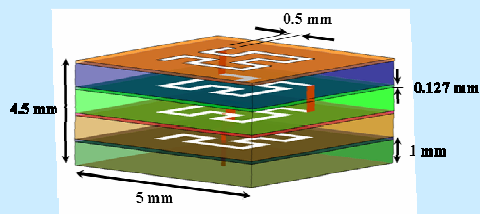

< $\lambda/30$!

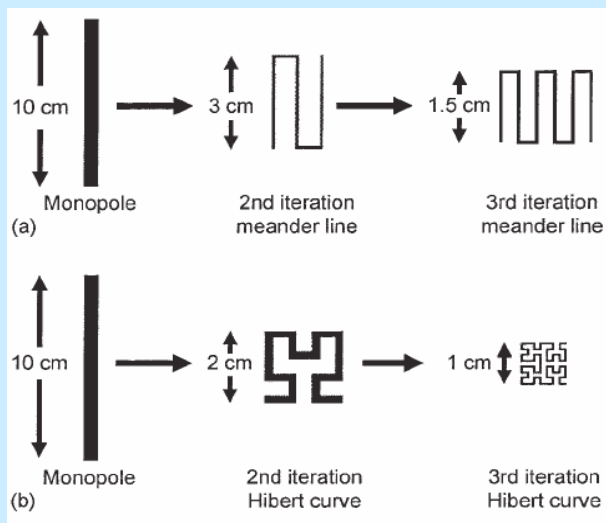

Results:

- fHCFA exhibits multi-resonant behavior.
- Two modes of operation with optimized radiation pattern diversity for surface-to-surface and surface-to-orbit communications at relevant frequencies without switching.

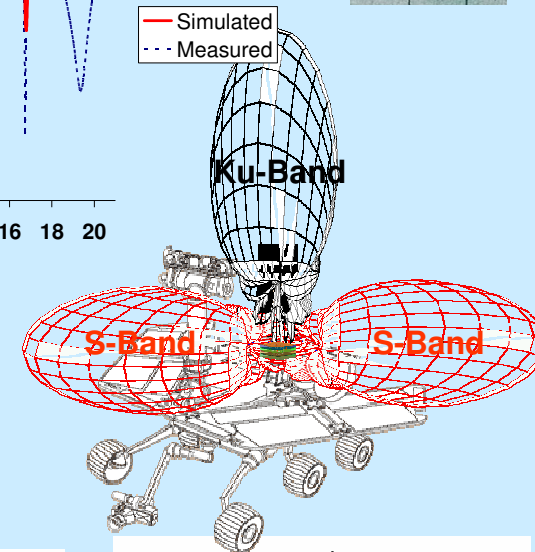
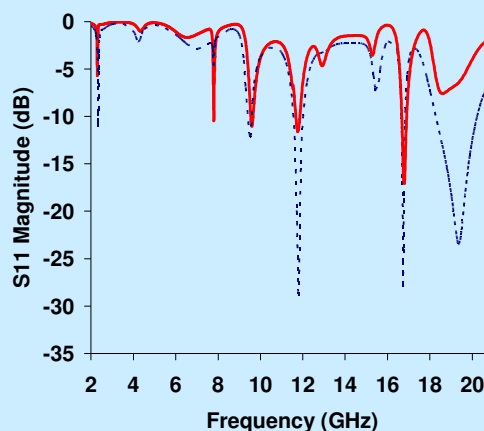

TRL_{in} = 2
TRL_{out} = 3

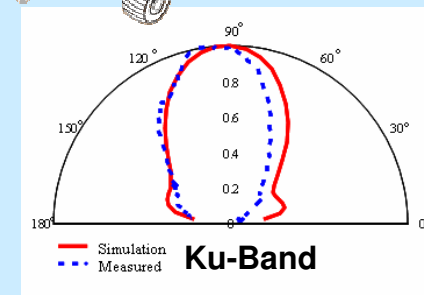
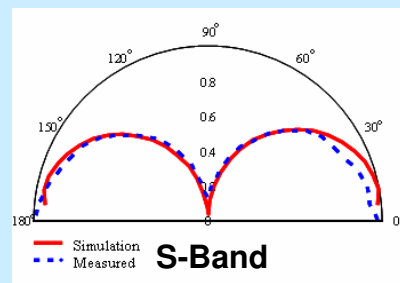

[1] James A. Nessel, Afroz J. Zaman, Félix A. Miranda, "A Miniaturized Antenna for Surface-to-Surface and Surface-to-Orbiter Applications," Microwave and Optical Technology Letters, Vol. 48, No. 5, May 2006, pg. 859-862

Miniature Antennas

(S-band: TRL 3)

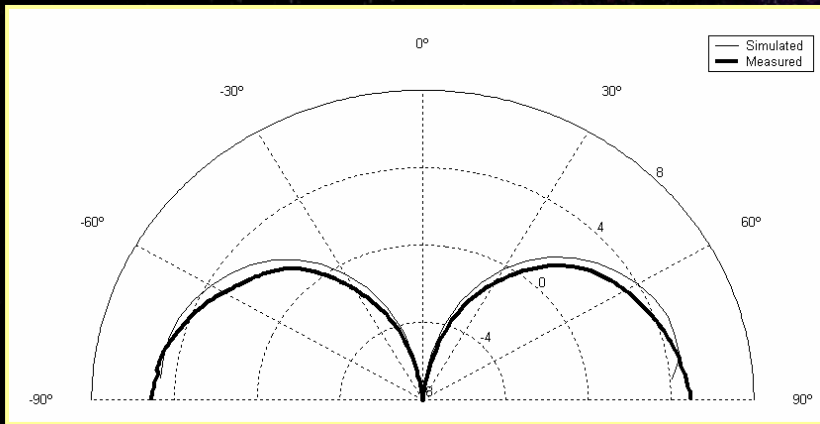

E-plane Pattern

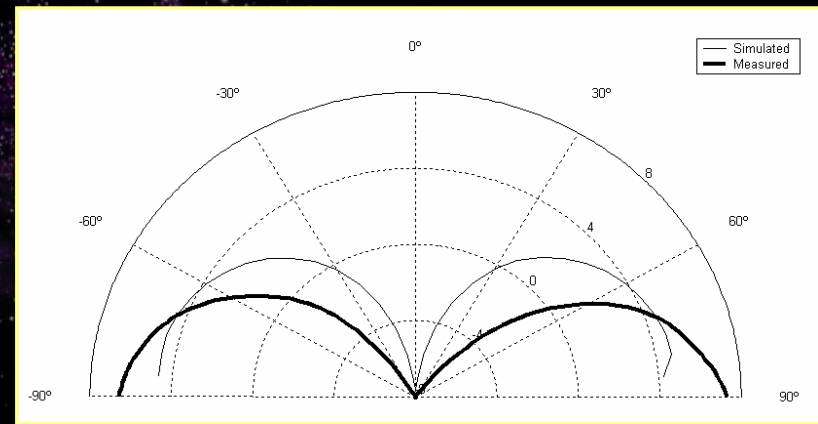

H-plane Pattern

Benefits

- Performance comparable to an S-band dipole, but at less than 1/6 the size

Potential Applications

- Sensors/probes
- Robotic rovers
- Astronaut EVA

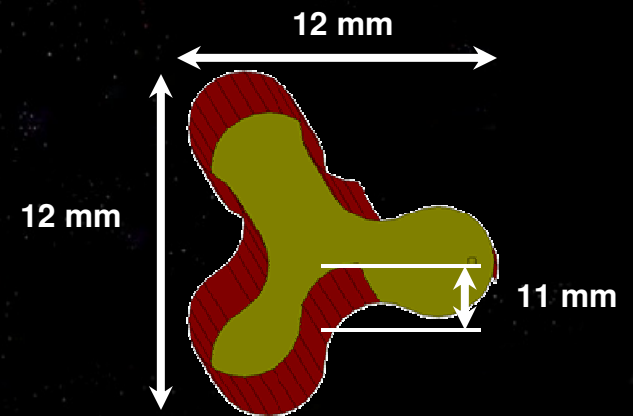

Compact Microstrip Monopole Antenna

Compact Microstrip Monopole Antenna (CMMA)



Design Concept:

- Reduce operating frequency of patch antenna through use of grounding wall and increased perimeter with a compact footprint.
- Adjust for inherent decrease in directivity with vertical wall.
- Combine a microstrip patch with a 3-dimensional structure to attain a highly directive, broadband, compact antenna which radiates like a miniature monopole antenna.

$< \lambda/12 !$

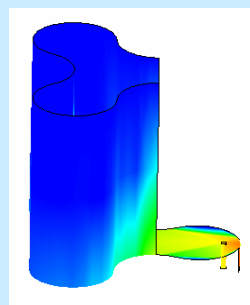
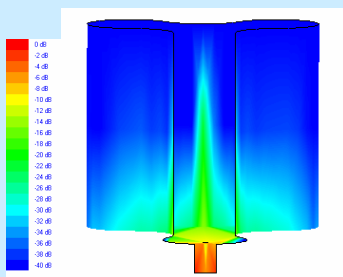
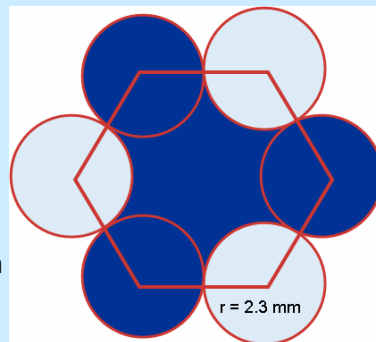
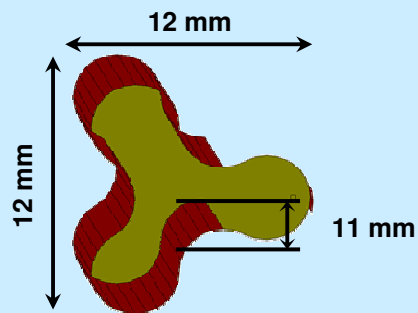

Results:

- End-fire radiation pattern allows for lunar surface-to-surface communications with an antenna structure 1/6th the size of a monopole antenna.

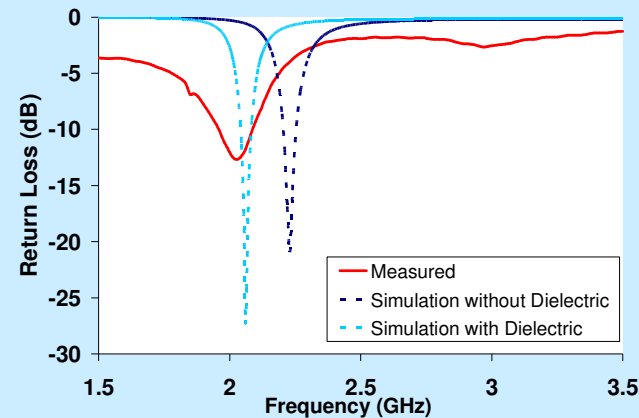

TRL_{in} = 2
TRL_{out} = 3

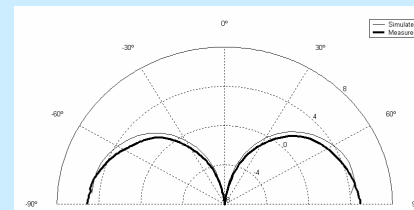
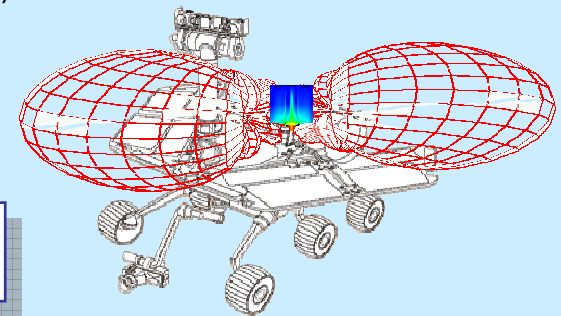

E-Plane

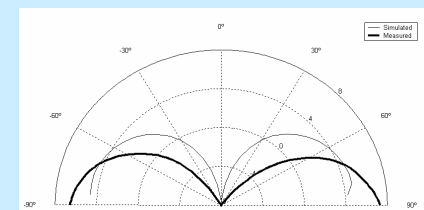

H-Plane

[2] Philip Barr, Afroz Zaman, Félix Miranda, "A Compact, Broadband Antenna for Planetary Surface-to-Surface Wireless Communications," Microwave and Optical Technology Letters, Vol. 48, Iss. 3, March 2006, pg. 521-524

Self-Powered Antennas

(X-band: TRL 3)

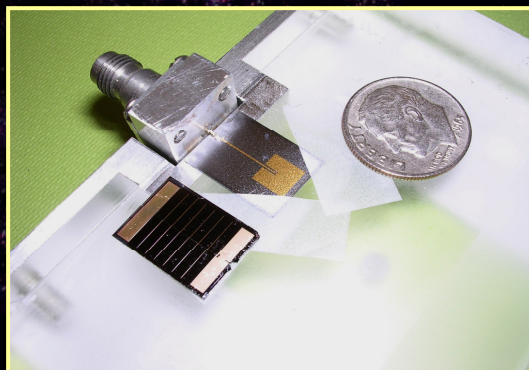
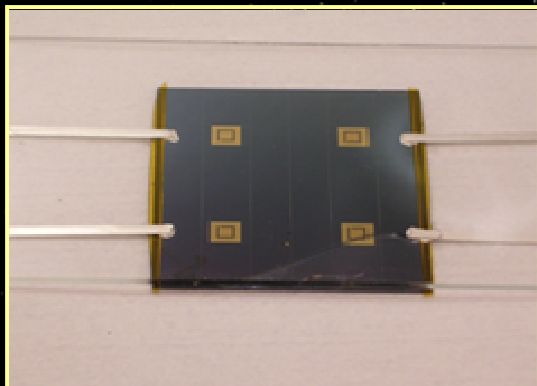

X-band Integrated antenna/solar cell

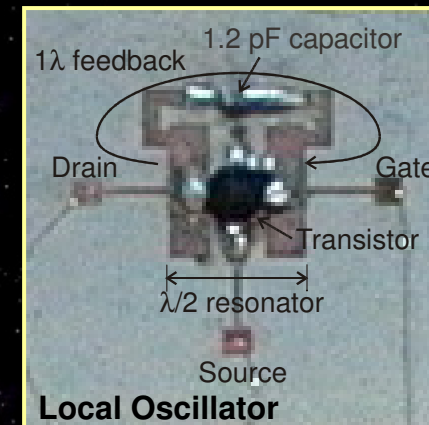

- Integration of solar cell and local oscillator with antenna provides self-powering communications system package

Potential Applications

- Distributed sensors/probes
- Robotic rovers
- Astronaut EVA

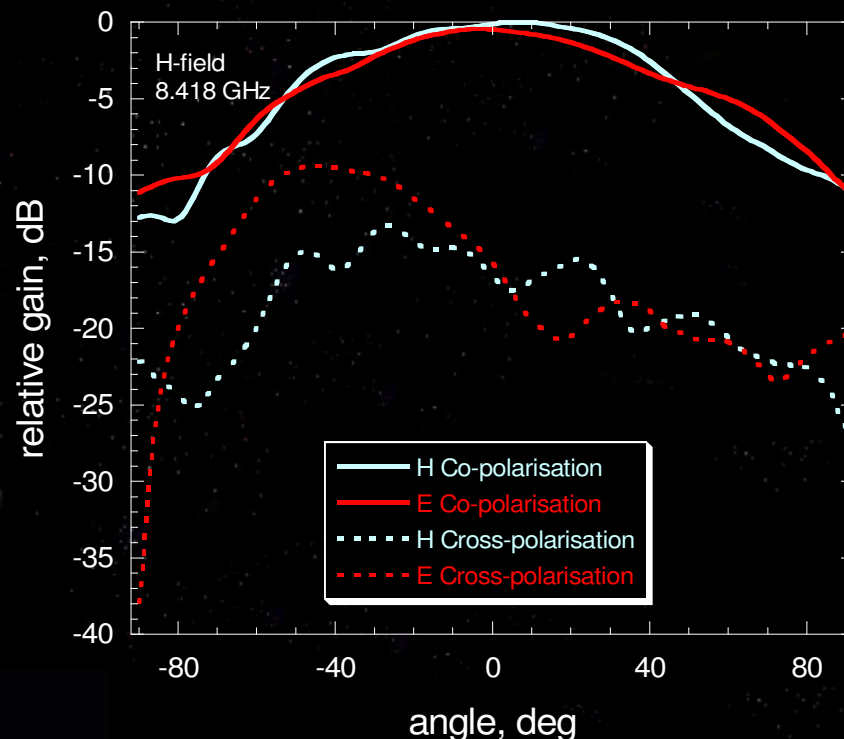

Solar Cell Integrated Antennas



Design Concept:

- Integrate solar cell, local oscillator and miniature antenna for complete, compact, self-powering communications system.
- Integrated antenna radiating element/oscillator generates it's own RF power.
- Demonstrate prototype active oscillator solar cell array antenna modules capable of beam steering based on multi-junction GaAs solar cell and oscillator antenna technologies.
- Foundation for larger aperture, beam-steerable antennas using coupled oscillator approach.
- The proposed system will enable the development of low-cost, lightweight satellites with high directivity communication links for Flexible Access Networks.

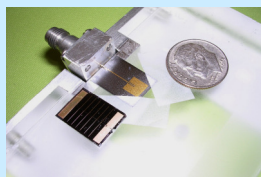

Miniature Antenna

Provides compact structure to transmit RF signal

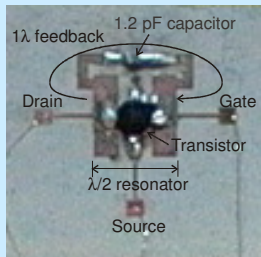

Local Oscillator

Provides modulation of frequency carrier for relevant data transmission

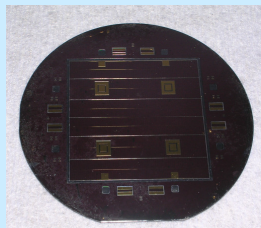

Solar Cell

Provides power for communications system. Can be integrated on antenna layer, or on oscillator layer.

Results:

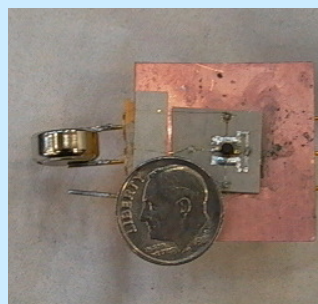

Fabricated integrated antenna/oscillator using Duroid RT 6010 microwave laminate (dielectric constant = 10.2), with pseudomorphic high electron mobility gallium arsenide transistors

TRL_{in} = 2
TRL_{out} = 3

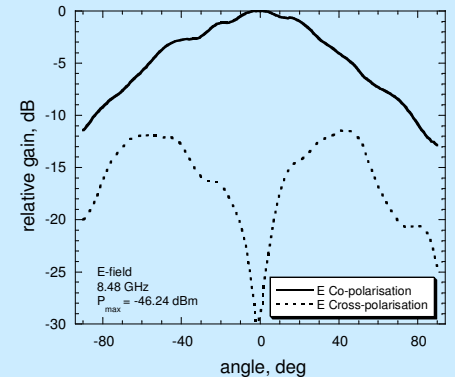
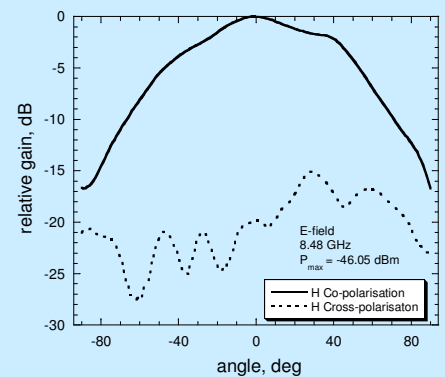
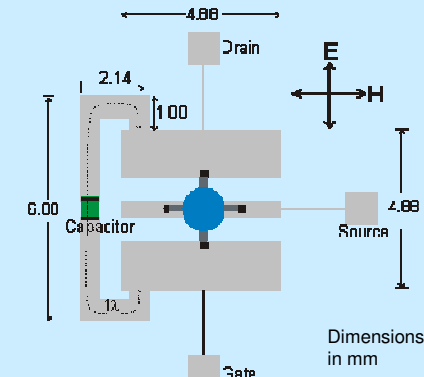
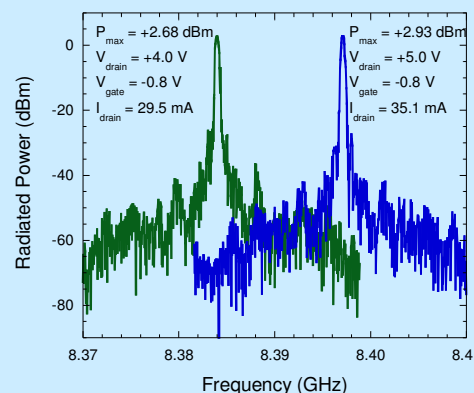



Miniaturized Reconfigurable Antenna for Planetary Surface Communications

Program Goals

- Develop electrically small (i.e., miniaturized) antennas with moderate bandwidths for planetary surface communications between remote sites sensors or orbiters.
- The technology is Intended to enable low-risk sensing and monitoring missions in hostile planetary and/or atmospheric environments.
- These antennas are needed for Planetary and Moon Exploration and Monitoring Missions

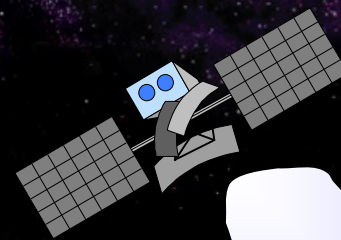

Beam formed by Randomly Located Antennas/Sensors

Sensor Web Interconnections

Randomly located antennas/sensors

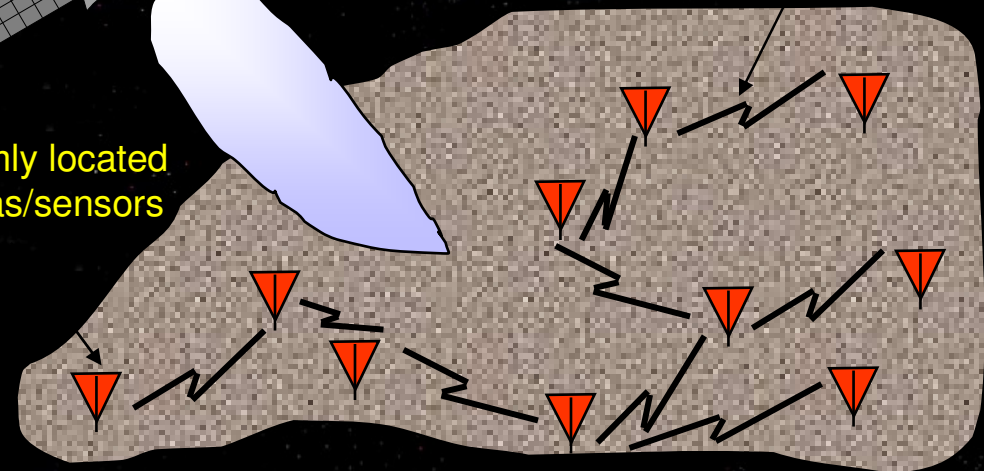

Collaboration with Dr. Jennifer Bernhard (University of Illinois)

Miniaturized Antennas in Random Sensor Arrays for Planetary Surface Exploration



PI : Dr. Jennifer Bernhard/Univ. of Illinois

Concept:

- Develop electrically small antennas and self-healing, adaptive decision algorithms for coherent signal detection and transmission from an array of randomly distributed planetary sensors. The sensor array will configure itself to form a beam in a general direction that can be intercepted by a passing orbiter or directed to a particular satellite or planetary surface-based receiver.
- Develop miniaturized antennas and beam forming algorithm for random sensor arrays that enable the sensor to work together to communicate their data to remote collection sites without the need for a base station
- Develop miniaturized antennas with moderate bandwidths for planetary surface communications between remote sites sensors or orbiters.
- The technology is intended to enable low-risk sensing and monitoring missions in hostile planetary and/or atmospheric environments.
- Development of distributed Bayesian Algorithm based fault tolerant, self organizing random sensor detection

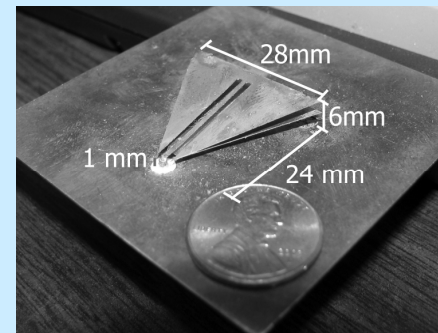

Prototype Miniaturized Antenna

TRL_{in} = 2
TRL_{out} = 3

Approach allows randomly distributed Lunar surface sensors to work together as an array and thus enhances communication capabilities by decreasing the probability of single point communication failure.

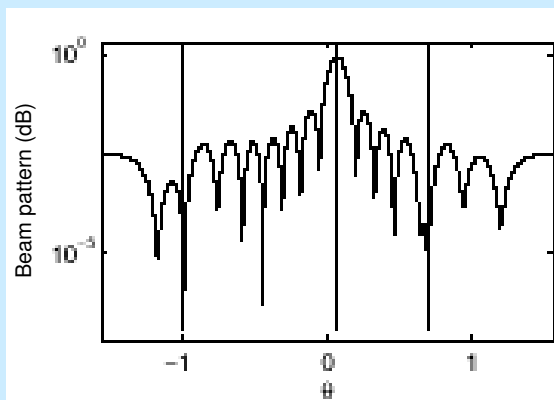

Simulated Beam forming Achieved Using Bayesian Estimation Method For a Random Sensor Array

Projected Network Operation - Flowchart

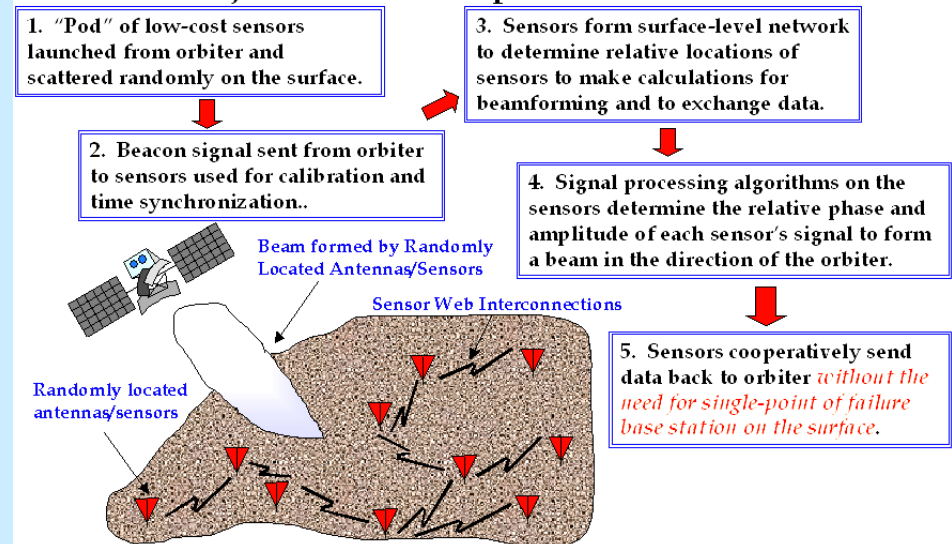

Reconfigurable Antennas for High Data Rate Multi-Beam Communication

PI: Prof. Jennifer Berhard, U. Illinois, Grant # NAG3 2555



Target Technology:

Reconfigurable antenna elements capable of producing multiple beams, multiple frequencies, and array scan angles from broadside to horizon. Intended for inter-satellite, satellite-mobile and satellite-ground communication with a single array.

Antenna Elements:

Spiral microstrip patch antenna with reconfigurable switch elements activated by DC bias. Broadside to end-fire pattern reconfiguration by respective switch activation.

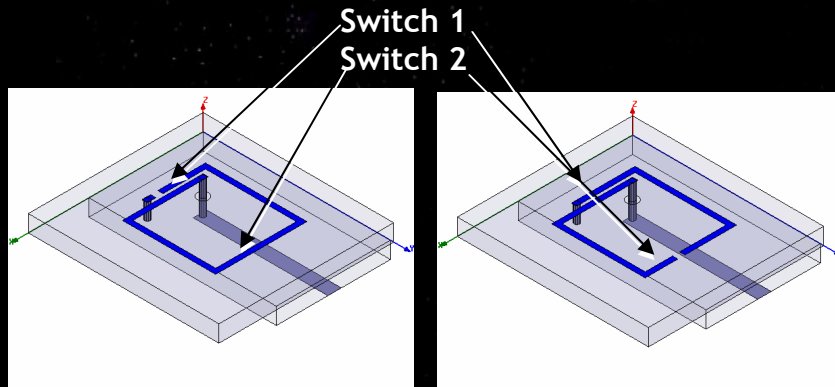

Feed through ground plane opening with via from reverse side 50Ω microstrip line

IC Compatible Prototype Square Element
For monolithic MEMS integrated fabrication

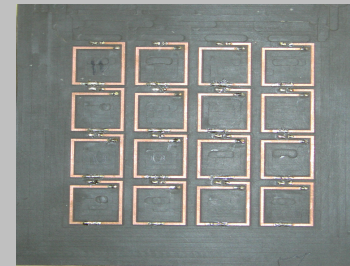

Reconfigurable antenna array (with 16 shorting wire switches)

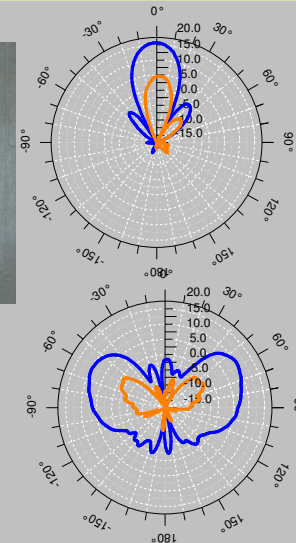

— E_θ
— E_ϕ

Measured patterns ($\phi=0$) from 4x4 array in broadside and end-fire configurations

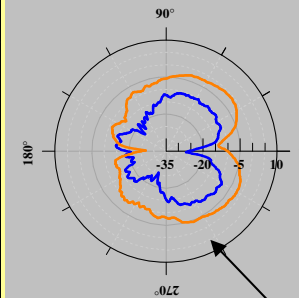

Single element on cube

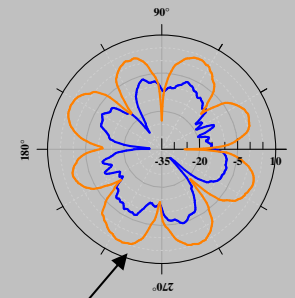

All 4 elements

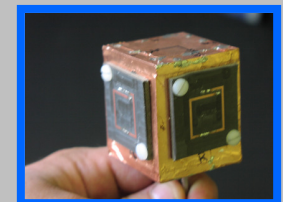
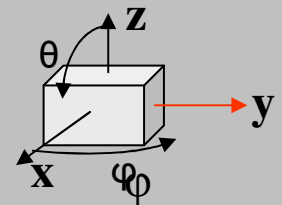
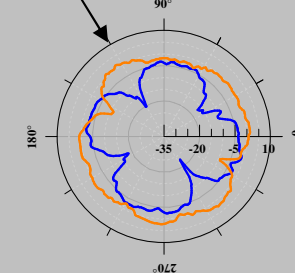
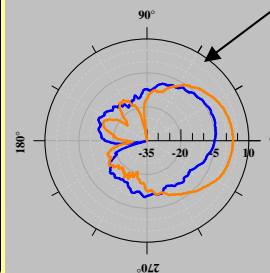

Human/Rover Application

RF Telemetry System for Implantable Bio-MEMS Sensors



(TRL 3-4)

- NASA seeks to develop telemetry based implantable sensing systems to monitor the physiological parameters of humans during space flights
- A novel miniature inductor and pick-up antenna for contact-less powering and RF telemetry from implantable Bio-MEMS sensors has been developed.

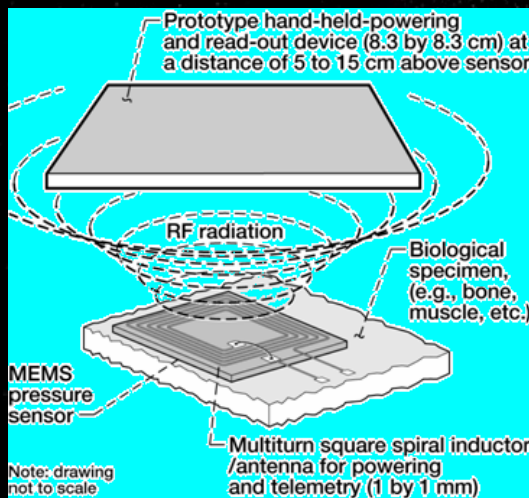

Contact-less powering and telemetry concept

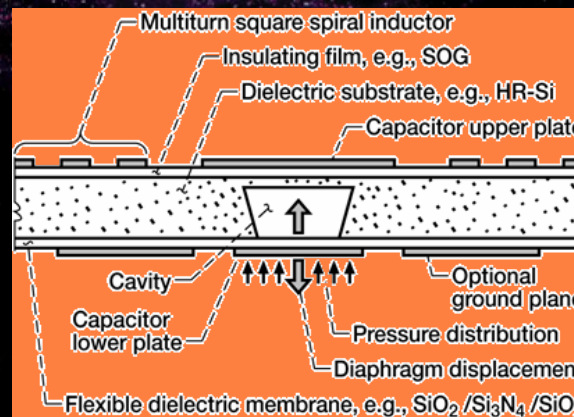

Schematic of a capacitive pressure sensor.

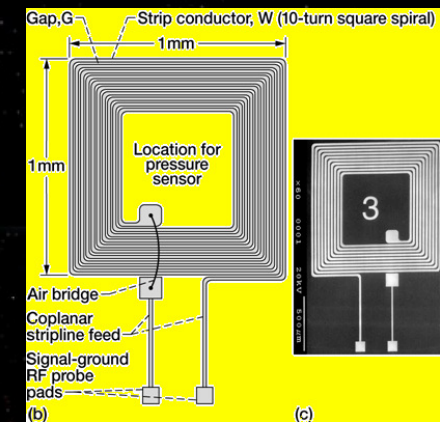

Schematic of miniature spiral inductor on SOG/HR-Si wafer and Photomicrograph of inductor/antenna.

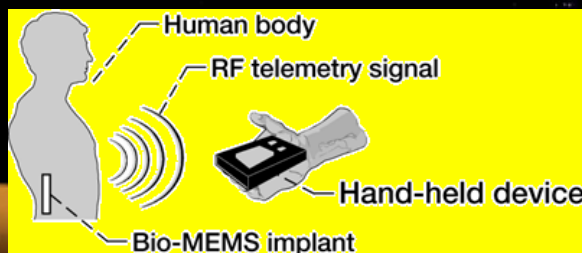

Contact-less powering and telemetry application in biosensors

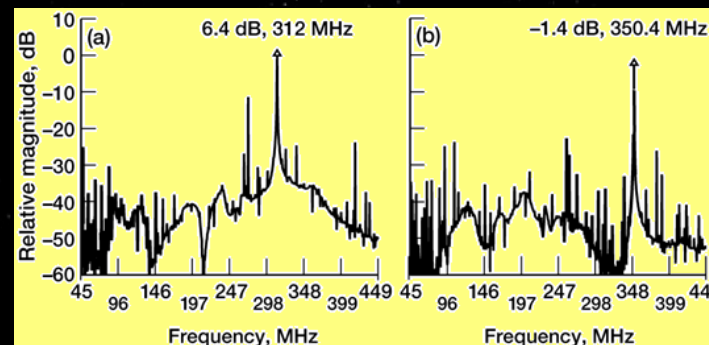

Measured received relative signal strength as a function of frequency.
 (a) Pick-up antenna at a height of 5 cm. (b) Pick-up antenna at a height of 10 cm.



Miniature Antennas

(TRL 2)

- Artificially manufacturable Metamaterials: Magnetic Photonic Crystals (MPC).
- These MPCs exhibit the following properties:
 - (a) considerable slow down of incoming wave, resulting in frozen mode.
 - (b) huge amplitude increase.
 - (c) minimal reflection at the free space interface.
 - (d) large effective dielectric constant, thus enabling miniaturization of the embedded elements

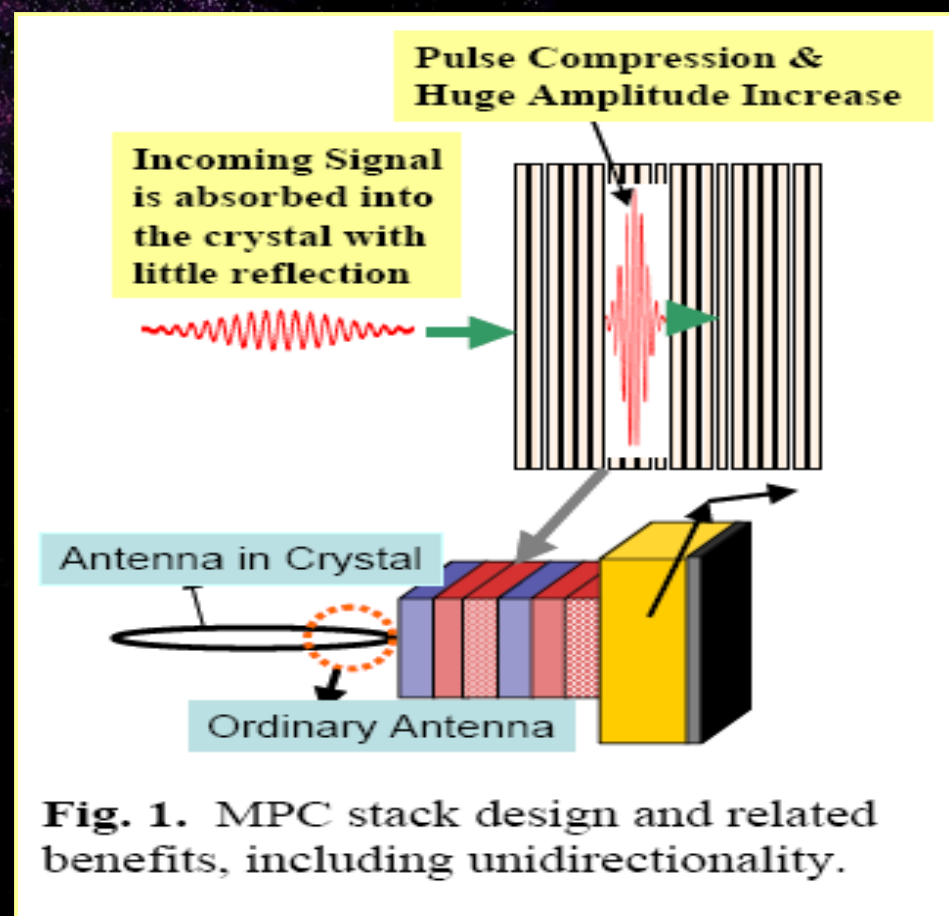

Collaboration with Dr. John Volakis and Mr. Jeff Kula (OSU)



Conclusions

- By 2030, 1 Gbps deep space data rates desired. Choosing the proper antenna technology for future NASA exploration missions will rely on: data rate requirements, available frequencies, available space and power, and desired asset-specific services. Likewise, efficiency, mass, and cost will drive decisions.
- Viable antenna technologies should be scalable and flexible for evolving communications architecture.
- Enabling technologies include: large aperture deployable/inflatable antennas (reduce space/payload mass), multibeam antennas (reduce power consumption), reconfigurable antennas (reduce space), low loss phased arrays (conformal/graceful degradation), and efficient miniature antennas (reduce space/power).
- Efficient miniature antennas will play a **critical** role in future surface communications assets (e.g., SDR radios) where available space and power place stringent requirements on mobile communications systems at the envisioned UHF/VHF/S-band surface comm. frequencies (i.e., astronaut suits, probes, rovers)