



Two-Phase Thermal Switching System for a Small, Extended Duration Lunar Surface Science Platform

23-26 February 2010

D. Bugby (ATK)
J. Farmer (NASA/MSFC)
B. O'Connor (NASA/MSFC)
M. Wirzburger (JHU/APL)
E. Abel (JHU/APL)
C. Stouffer (ATK)

SPESIF 2010



22 CFR 125.4(b)(13) applicable

- **Introduction** *... lunar mission definition*
- **Problem** *... requirements/methodology*
- **Concept** *... thermal switching options*
- **Analysis** *... system evaluation*
- **Plans** *... dual-radiator LHP test bed*
- **Conclusion** *... from this study*

- **Issue:** *extended duration lunar science platforms, using solar/battery or radioisotope power, require thermal switching systems that ...*
 - *Provide efficient cooling during the 15-earth-day 390 K lunar day*
 - *Consume minimal power during the 15-earth-day 100 K lunar night*
- **Objective:** *carry out an analytical study of thermal switching systems that can meet the thermal requirements of ...*
 - *International Lunar Network (ILN) anchor node mission – primary focus*
 - *Other missions such as polar crater landers*
- **ILN Anchor Nodes:** *network of geophysical science platforms to better understand the interior structure/composition of the moon*
 - **Rationale:** *no data since Apollo seismic stations ceased operation in 1977*
 - **Anchor Nodes:** *small, low-power, long-life (6-yr) landers with seismographic and a few other science instruments (see next chart)*
 - **WEB:** *warm electronics box houses ILN anchor node electronics/batteries*
- **Technology Need:** *thermal switching system that will keep the WEB cool during the lunar day and warm during the lunar night*

ILN Anchor Node Spacecraft

(Based on Mid-Summer 2009 Information)

Lander Stowed Configuration

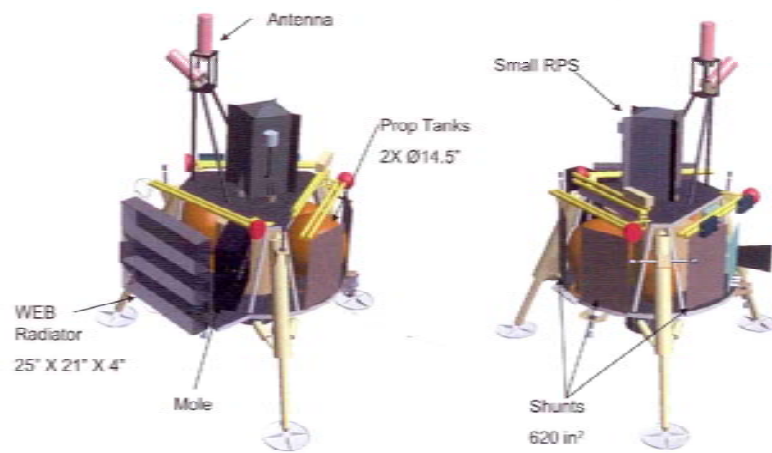

Feb 18, 2009

5

WEB Enclosure

- WEB Dimensions
 - Total Surface Area = 1350 in²
 - Approx. Volume
 - 21.5" X 13" X 15"H
- Bottom Level
 - IEMPDU
 - 9.4" X 11.4" X 7.0"
 - PSE
 - 9.8" X 7.5" X 6.3"
 - RF Components
- Upper Level
 - Secondary Battery
 - 11.8" X 5.9" X 6.7"
 - Seismometer Electronics
 - 6" X 5" X 7"

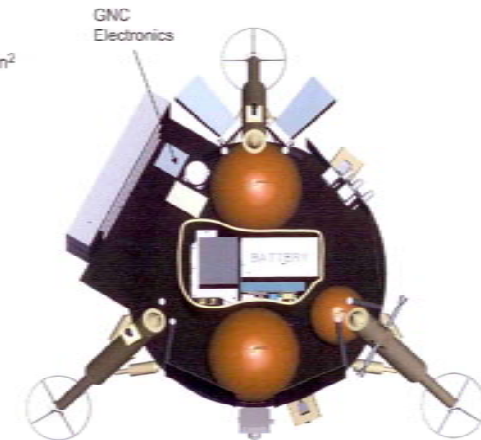

Top Deck Removed

7

Feb 18, 2009

Basic Technology Need: *Variable Conductance Heat Transport System (VCHTS) that thermally couples/decouples the WEB to the radiators*

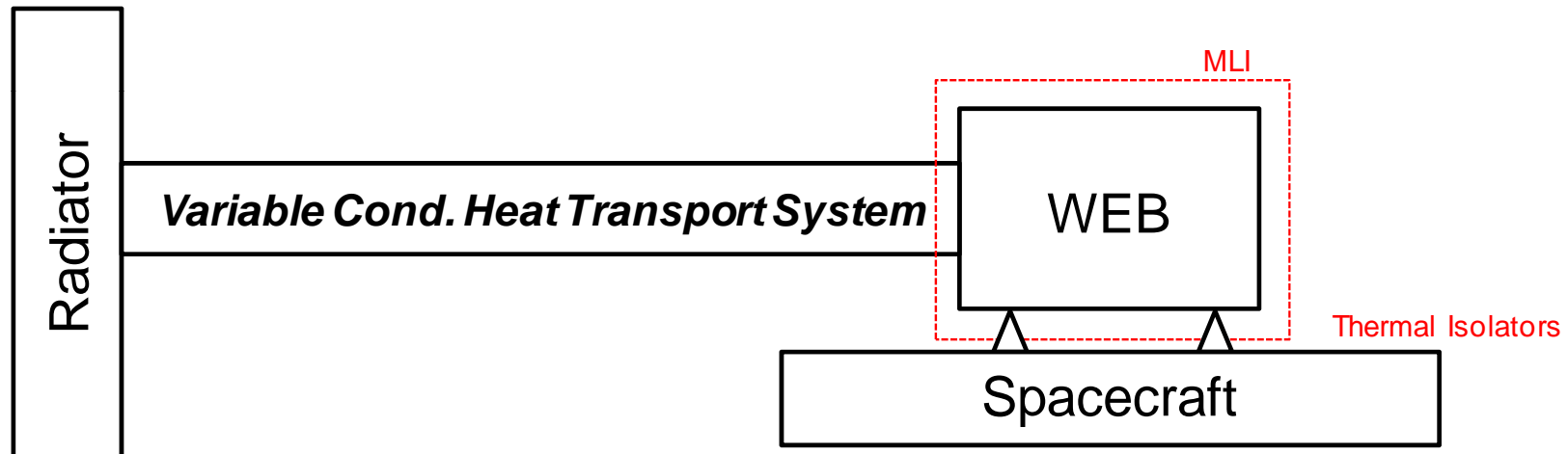

Realistic Technology Need: Involves consideration of multiple subsystems, interfaces (I/F), and system (solution) options

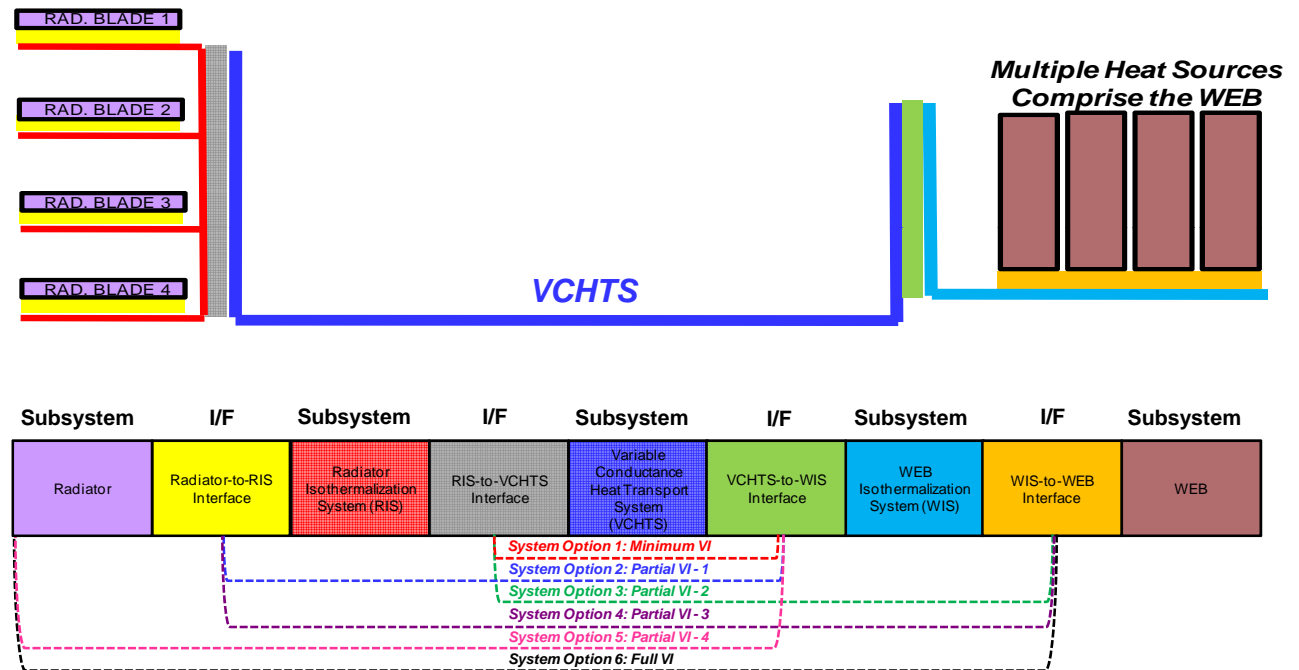
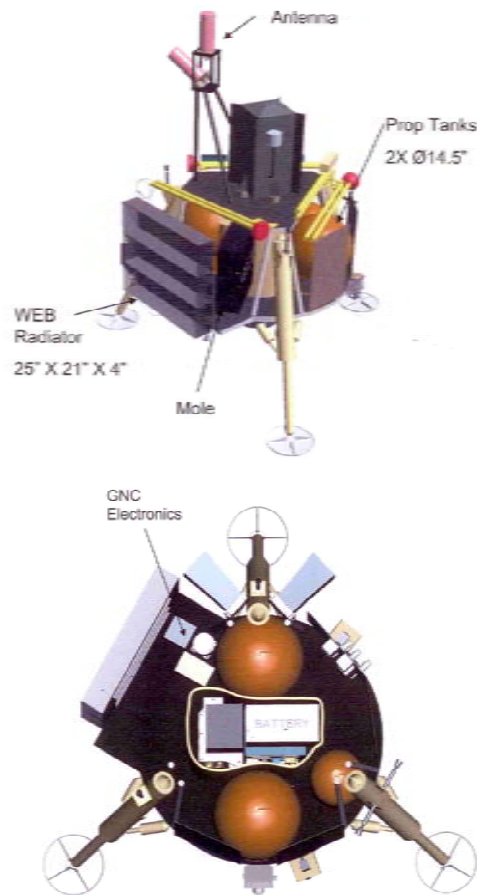

System Options: Definition of VI

The greater the number of interfaces (I/Fs) spanned by the system option, the greater the degree of **Vertical Integration or (VI)**

Requirements: A total of 35 customer-specified or internally-derived requirements

- (1) **WEB operating temperature** (263-323 K, with 263-303 K as a goal)
- (2) **duration of lunar day/night** (about 15 earth-days each)
- (3) **lunar day sink temperature** (260 K with an appropriately oriented radiator that runs much colder than the 390 K lunar day surface temperature)
- (4) **lunar night sink temperature** (60-150 K, depending on the modeling assumptions, which were not fully defined at the time of this study)
- (5) **cruise sink temperature** (168 K, TBD at the time of this study)
- (6) **cruise maximum spin rate** (6 rpm, which produces a small 0.03g acceleration with a 0.75 m moment arm)
- (7) **WEB power during lunar day** (60 W)
- (8) **WEB power during lunar night** (20 W for solar/battery power, 60 W for radioisotope power)
- (9) **transported power during lunar night** (0 W for solar/battery, 40-55 W for radioisotope power)
- (10) **radiator emissivity** (0.93 nominal, 0.70 degraded)
- (11) **radiator area** (0.26-0.34 m²; current designs may have multiple, larger radiators)
- (12) **radiator temperature during lunar day** (298 K with 60 W, 0.93 emissivity, and 0.34 m² radiator area; current radiator designs be larger)
- (13) **minimum ON conductance** (6 W/K; 12 W/K goal)
- (14) **radiator temperature during lunar night** (same as sink temperature, with 0 W/K OFF conductance)
- (15) **OFF conductance** (adjustable down to nearly 0 W/K based on WEB temperature)
- (16) **ON/OFF conductance ratio** (maximize)
- (17) **ON-to-OFF switching time** (minimize)
- (18) **start-up** (minimize need for special procedures; goal is autonomous)
- (19) **control power** (minimize; 5.5 kg mass penalty per 1 W of control power)
- (20) **mass** (minimize)
- (21) **volume** (minimize)
- (22) **cost** (minimize; but need to define the required technology development)
- (23) **lifetime** (6 years minimum)
- (24) **transport length** (0.5-1.75 m; NASA estimate)
- (25) **flight heritage** (desired; not required)
- (26) **vertical integration (VI) capability** (maximize; assume WEB interface cannot be eliminated)
- (27) **complexity** (minimize; use simplest system possible)
- (28) **autonomous operation** (desired; not required)
- (29) **scalability** (maximize; should be able to accommodate increases/decreases in power)
- (30) **testability** (should be testable in 1-g)
- (31) **test orientation** (flight units to be ground-testable in flat orientation)
- (32) **tilt tolerance** (to the potential landed adverse tilt of +/- 20°)
- (33) **ease of integration** (maximize; should be easy to integrate)
- (34) **environment compatibility** (maximize; should be operable in lunar environment)
- (35) **redundancy** (not required)

Study Simplification: *Of the 35 requirements, only 6 were deemed system discriminators (SD)*

- (19) control power** (minimize; 5.5 kg mass penalty per 1 W of control power)
- (23) lifetime** (6 years minimum)
- (26) vertical integration (VI) capability** (maximize; assume WEB interface remains)
- (27) complexity** (minimize; use simplest system possible)
- (28) autonomous operation** (desired; not required)
- (32) tilt tolerance** (to the potential landed adverse tilt of +/- 20°)

Overall Methodology

- 1. Define several potential thermal control system concepts*
- 2. Assign a score to each concept in each of the 6 SD categories*
- 3. Combine the SD scores into a total concept score*
- 4. Rank the concepts based on total score*
- 5. Select the top 2-3 concepts and perform detailed comparison*
- 6. Recommend one concept; any required risk mitigation*

Generic Thermal Switching Options Considered

System	Definition	Thermal Switching Mechanism, Actuator	Heritage
1. VCHP	Variable Conductance Heat Pipe	NCG condenser blockage, reservoir heater	Flight (Extensive)
2. CPL	Capillary Pumped Loop	Liquid condenser blockage, reservoir heater	Flight (Moderate)
3. LHP	Loop Heat Pipe	Liquid condenser blockage, reservoir heater	Flight (Extensive)
4. HLHP	Hybrid Loop Heat Pipe	Liquid condenser blockage, reservoir heater	Ground (Extensive)
5. MPTPL	Mechanically Pumped Two-Phase Loop	Liquid flow rate, pump power (adjusts speed)	Ground (Moderate)

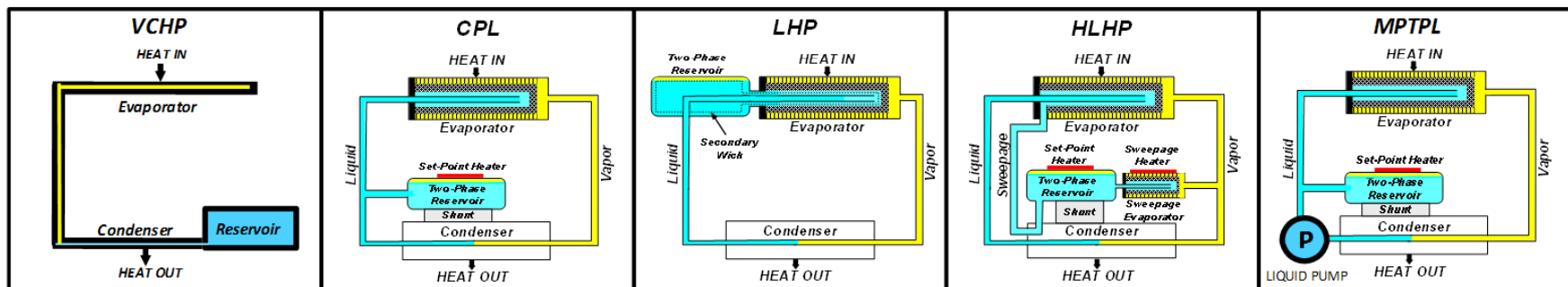

Modifications Considered to Enhance Generic System Performance

System Modification	Performance Enhancement Mechanism	Heritage
A. Thermoelectric Cooler (TEC)	Reservoir cooling for robustness, lower control power	Ground
B. Flow-Obstructing Valve (FV)	Actuating valve to block flow for ON/OFF functionality	Ground
C. Bypass Valve (BV)	Pressure actuated valve for LHP ON/OFF functionality	Ground
D. HX + Subcooler (HX+SC)	Modification to LHP to reduce control power	Ground
E. VCHP	Thermal switching/transport/isothermalization (addition)	Flight
F. Multiple Evaporator/Condenser (MEC)	Multiple evaporator/condenser for higher conductance	Flight
G. Multi-Pass System (MP)	Multi-pass flow routing for higher conductance	Concept

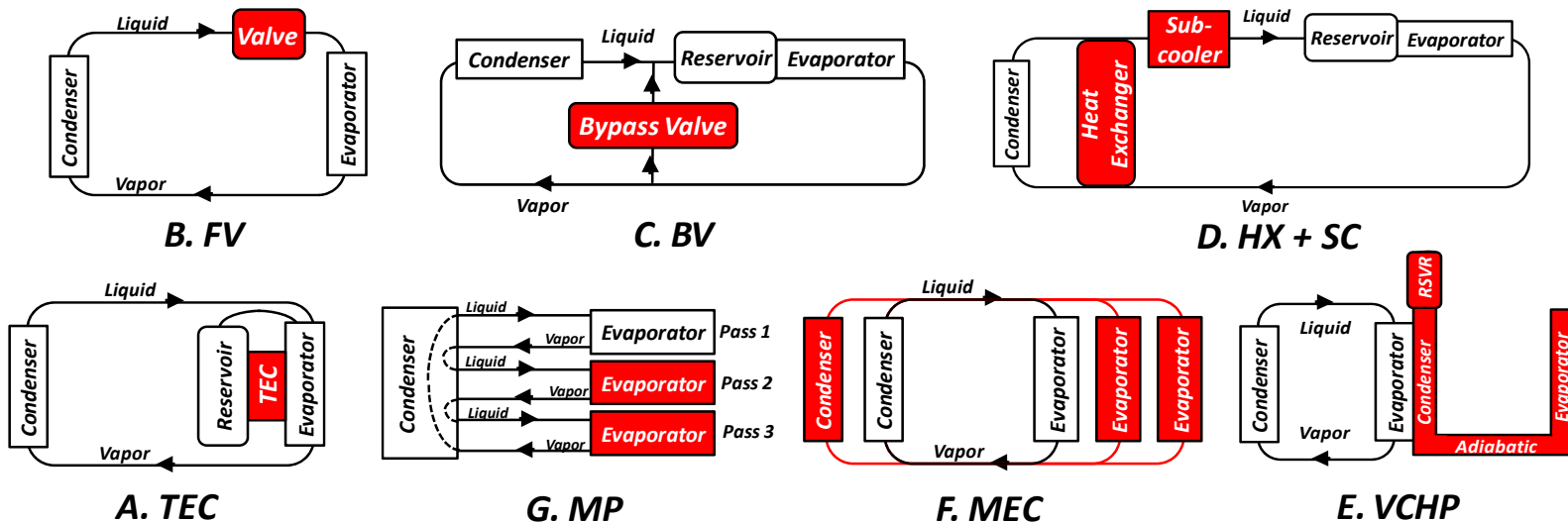

Number of Systems Evaluated ... 26
(Generic Thermal Switch Options plus Enhancements)

1. **VCHP**
2. **CPL**
3. **LHP**
4. **HLHP**
5. **MPTPL**
- 6-8. **CPL, LHP, HLHP with TEC**
- 9-11. **CPL, LHP, HLHP with FV**
12. **LHP with BV**
13. **LHP with HX+SC**
- 14-17. **VCHP, CPL, LHP, HLHP with VCHP**
- 18-20. **CPL, LHP, HLHP with MP**
- 21-23. **CPL, LHP, HLHP with MP and VCHP**
- 24-26. **CPL, LHP, HLHP with MEC**

Scoring Methodology

- **Process:** The analytical process used to rank the systems was to assign each of the 26 systems a score from 0-4 (using increments of 0.5) in each of the six system discriminator categories (i.e., control power, lifetime, capability for VI, complexity, autonomous operation, and tilt tolerance).
- **Template:** Scoring was carried out using the *scoring methodology template* provided below (note: scores [S_{i,j}] were actually generated based on a subjective assessment by the analysis team and the template was actually used to “explain” the scores generated).

Category	Units	Score								
		0.0	0.5	1.0	1.5	2.0	2.5	3.0	3.5	4.0
Control Power	W	5+	4-5	3-4	2-3	1-2	¾ - 1	½ - ¾	< ¼	0
Lifetime	Yrs	0-2	2-3	3-4	4-5	5-6	6-7	7-8	8-10	10+
Capability for VI ¹		np ²	< min VI	min VI	pVI-1	pVI-2	pVI-3	pVI-4	pVI-5	full VI
Complexity		np	high			medium				low
Autonomous Oper. ³		np		smart			dumb			auto
Tilt Tolerance		np	min	1.5X min	2X min	2.5X min	3X min	3.5X min	4X min	5X ⁺ min

¹p VI = partial VI (see Figure 4); ²np = not possible; ³smart = microprocessor, dumb = mechanical thermostat, auto = autonomous

- **Function:** To ensure the selected system would perform well in all six categories, the total score (TS_i) for each system (i) was defined as the *product* of the scores (S_{i,j}) in each discriminator category (j). Equation (1) indicates the total scoring function.

$$TS_i = S_{i,1} * S_{i,2} * S_{i,3} * S_{i,4} * S_{i,5} * S_{i,6}$$

Scoring Results

System	Control Power	Lifetime	VI Ability	Complexity	Autonomy	Tilt Tolerance	Score	Conclusion
1. VCHP	4.0	4.0	2.0	4.0	4.0	1.0	512	4
2. CPL	1.0	4.0	3.0	2.5	1.0	4.0	120	Eliminate
3. LHP	1.0	4.0	3.0	3.0	2.0	4.0	288	Eliminate
4. HLHP	1.0	4.0	3.0	2.0	1.0	4.0	96	Eliminate
5. MPTPL	2.0	1.0	3.0	2.5	3.0	4.0	180	Eliminate
6. CPL/TEC	2.0	2.0	3.0	2.0	1.0	4.0	96	Eliminate
7. LHP/TEC	2.0	2.0	3.0	2.5	1.5	4.0	180	Eliminate
8. HLHP/TEC	2.0	2.0	3.0	1.5	1.0	4.0	72	Eliminate
9. CPL/FV	1.0	1.0	3.0	1.5	1.0	4.0	18	Eliminate
10. LHP/FV	1.0	1.0	3.0	2.0	1.0	4.0	24	Eliminate
11. HLHP/FV	1.0	1.0	3.0	1.0	1.0	4.0	12	Eliminate
12. LHP/BV	4.0	1.0	3.0	2.5	4.0	4.0	480	6
13. LHP/HX+SC	3.5	4.0	3.0	2.0	2.0	4.0	672	3
14. VCHP/VCHP	4.0	4.0	2.5	3.5	4.0	2.0	1120	2
15. CPL/VCHP	1.0	4.0	4.0	2.0	2.0	4.0	256	Eliminate
16. LHP/VCHP	3.5	4.0	4.0	2.5	4.0	4.0	2240	1
17. HLHP/VCHP	1.0	4.0	4.0	1.5	1.0	4.0	96	Eliminate
18. CPL/MP	0.5	4.0	4.0	1.0	1.0	4.0	32	Eliminate
19. LHP/MP	0.5	4.0	4.0	1.0	2.0	4.0	64	Eliminate
20. HLHP/MP	0.5	4.0	4.0	1.0	1.0	4.0	32	Eliminate
21. CPL/VCHP/MP	1.0	4.0	4.0	0.5	1.0	4.0	32	Eliminate
22. LHP/VCHP/MP	3.5	4.0	4.0	0.5	4.0	4.0	448	5
23. HLHP/VCHP/MP	1.0	4.0	4.0	0.5	1.0	4.0	32	Eliminate
24. CPL/MEC	1.0	4.0	4.0	1.0	1.0	4.0	64	Eliminate
25. LHP/MEC	1.0	4.0	4.0	1.0	2.0	4.0	128	Eliminate
26. HLHP/MEC	1.0	4.0	4.0	1.0	1.0	4.0	64	Eliminate

Two Highest Ranked Systems

LHP/VCHP

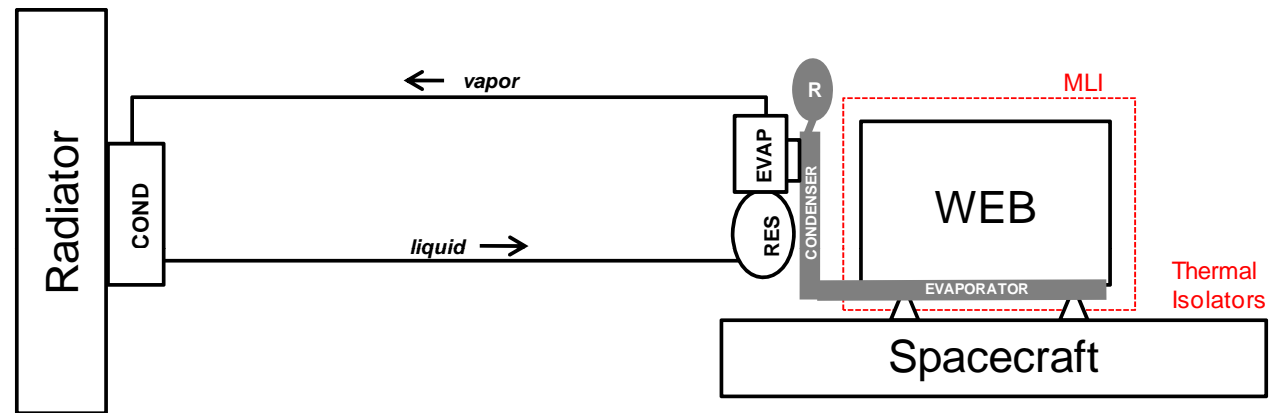

VCHP/VCHP

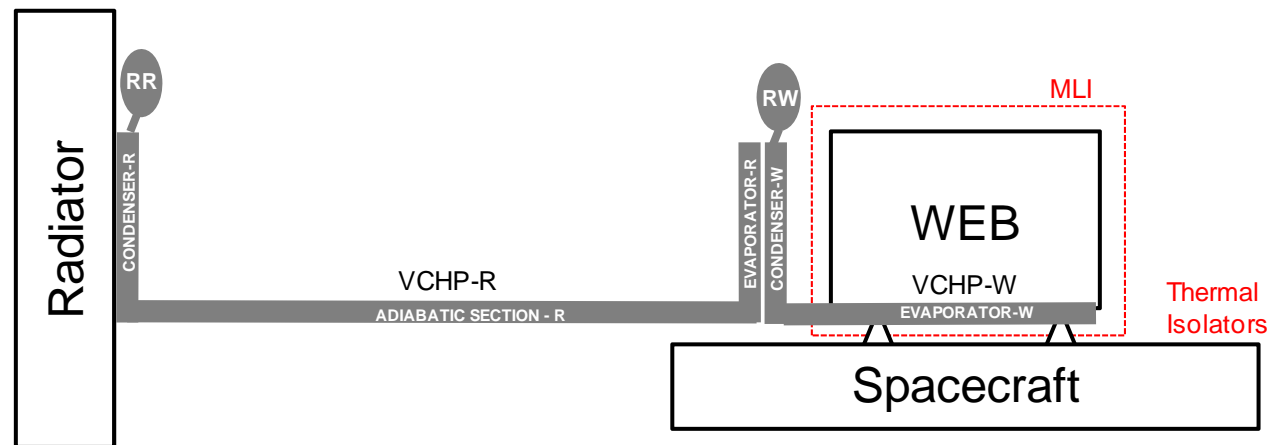

Comparison of Two Highest Ranked Systems

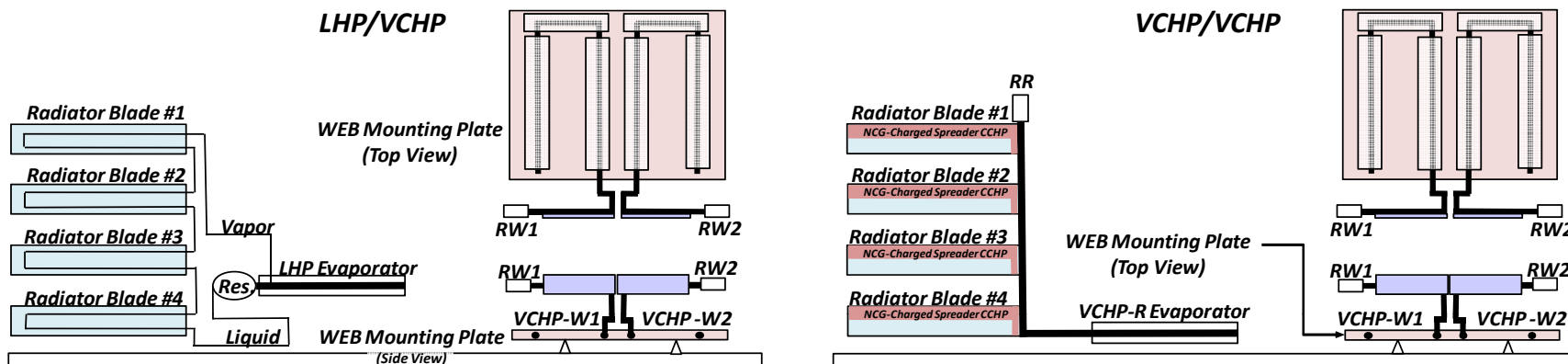

Category	LHP/VCHP	VCHP/VCHP
1. Thermal Switching Concept	VCHP turns ON/OFF autonomously	VCHP-W turns ON/OFF autonomously
2. ON Conductance	12 W/K	7 W/K
3. OFF Conductance	0.007 W/K (VCHP only; lower if LHP included)	0.007 W/K
4. Mass	3.1 kg (not including radiator blades)	4.3 kg (not including radiator blades)
5. Size/Dimensions	0.5 m length LHP evaporator	0.5 m length VCHP-R evaporator
6. Power (Control)	0 W (LHP* autonomously reacts to VCHP)	0 W (VCHP-R** autonomously reacts to VCHP-W)
7. Operational Limits (Tilt)	34° (75% of VCHP static height in 1/6g)	16° (75% of VCHP-R static height in 1/6g)
8. Heritage	30 propylene LHPs in space (or in queue)	>1000 ammonia VCHPs in space
9. Controllability/Autonomy	system operates autonomously	system operates autonomously
10. Reliability/Risk	> 10 yr life/low (breadboard LHP to be tested)	> 10 yr life/low (all SS VCHP design)
11. Ease of Integration	LHP can use coiled (flexible) transport lines	VCHPs can use flexible bellows
12. Modularity	minimal (can enhance but will increase ΔT)	modest (can enhance but will increase ΔT)
13. Testability (Ground Testing)	maximum tilt ~ 6° in any axis	maximum tilt ~ 3° in any axis
14. Scalability	high (due to intrinsic LHP capabilities)	modest (can add additional VCHP-Rs)
15. Thermal Switching Details	$G_{ON} / G_{OFF} = 1700$, rapid thermal switching	$G_{ON} / G_{OFF} = 1100$, rapid thermal switching

* LHP to have polymer wick for low power startup, auto-shutdown; **VCHP-R freeze/thaw tolerant due to noncondensable gas (NCG)

Testing Objectives

1. Verify basic operation of polymer wick LHP in flat configuration
2. Verify low power start-up of polymer wick LHP
3. Verify autonomous shut down of the polymer wick LHP
4. Conduct tests to demonstrate ability of the polymer wick LHP to fulfill mission requirements
5. Measure the ON and OFF conductance of the polymer wick LHP
6. Characterize polymer wick LHP performance with dual radiators

Baseline Orientation

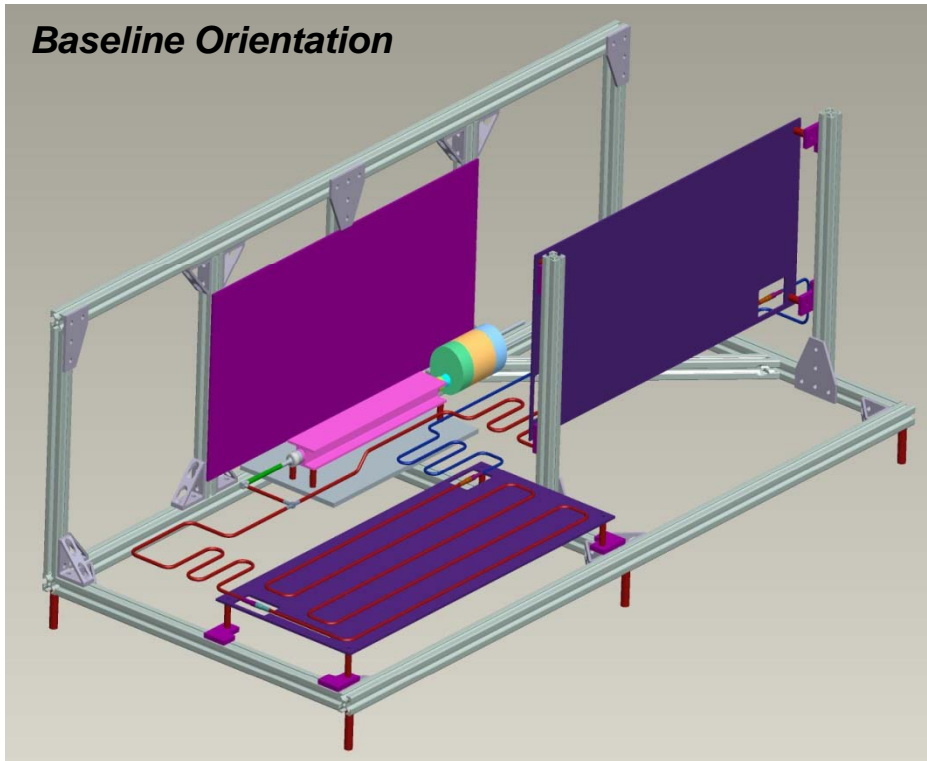

Alternate Orientation

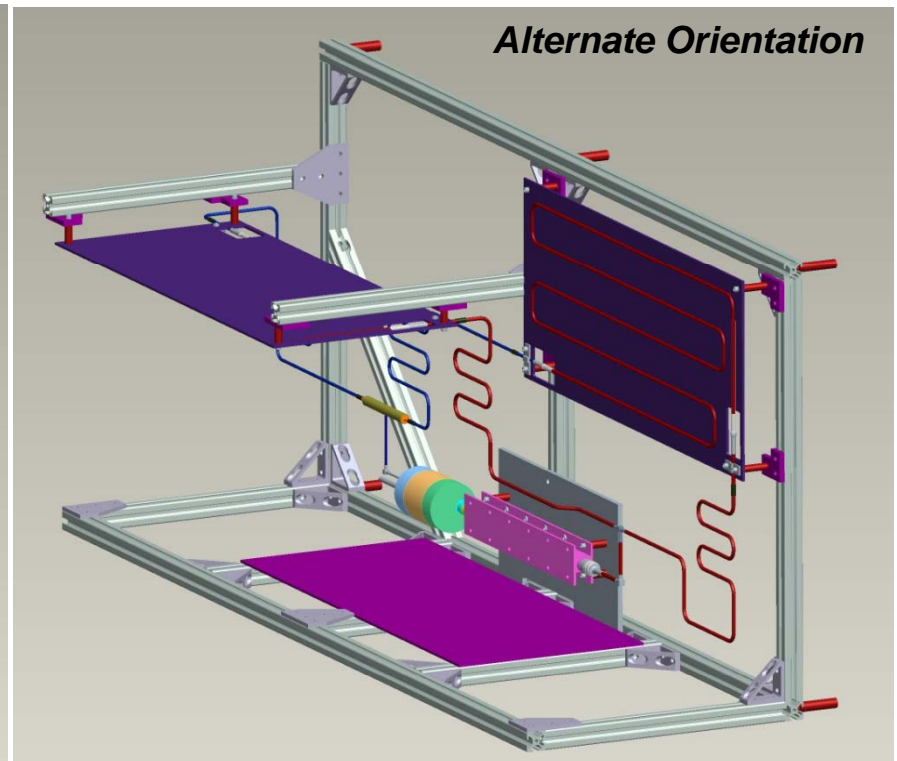

- **LHP/VCHP is the best thermal solution for ILN Anchor Node mission**
 - *Propylene LHP with a long polymer wick evaporator (propylene is for freeze avoidance; length is for high conductance; polymer wick is for low back conduction)*
 - *Dual ammonia VCHPs, the condensers for which interface to the LHP evaporator and the evaporators for which acquire heat from and isothermalize the WEB and its constituent electronics/battery elements.*
- **Thermal switching provided by the VCHPs; reservoir sized to ...**
 - *Passively turn the VCHP OFF as the WEB cools to near its min. operating temp.*
 - *Passively turn the VCHP ON as the WEB warms up from its min. operating temp.*
 - *Ensure the VCHP is fully ON when the WEB is near its peak operating temperature*
- **Of the 26 systems analyzed, LHP/VCHP best met the 6 SD requirements**
 - **Low control power:** none is required
 - **Long lifetime:** 10-year or more lifetime is expected
 - **VI capability:** isothermalizes WEB, functions as VCHTS, isothermalizes radiator
 - **Low complexity:** system based on straightforward, flight-proven technologies
 - **Autonomous operation:** system operates without any power or active intervention
 - **Tolerance to landed tilt:** system able to handle adverse tilts about twice that required
- **LHP Test Bed (Dual-Radiator, Polymer Wick LHP):** under construction; objective is to verify above conclusions; ready for use in a few months