

Space Flight Human System Standards (SFHSS), Volume 2 “Human Factors, Habitability & Environmental Factors” and Human Integration Design Handbook (HIDH)

Jeffrey R. Davis, MD

David Fitts

NASA Space Life Sciences

Space Flight Human System Standards

- Space Flight Human Systems Standards (SFHSS) have been developed and entered into the NASA Engineering Standards Program (NESP) for approval
 - SFHSS is directed at minimizing health and performance risks to flight crew in human space flight programs
 - SFHSS provides Agency-level statements for derivation of program-specific requirements
 - Two volumes:
 - Volume 1: Crew Health
 - Standards for fitness for duty, permissible exposure and outcome limits, levels of medical care, medical diagnosis, intervention, treatment, care, and countermeasures
 - Approved into the NESP
 - Volume 2: Human Factors, Habitability and Environmental Health
 - Standards for space flight hardware based on human capabilities and limitations
 - Submitted to the NESP
 - Designated “NASA-STD-3001”; Supercedes NASA-STD-3000

SFHSS, Vol. 2, Human Factors, Habitability & Environmental Factors

- Environmental, Human Factors, & Habitability
“SHALL” statements previously in NASA-STD-3000
- Accompanied by the Human Integration Design Handbook (HIDH), containing detailed information and background to Volume 2
 - Derived from NASA-STD-3000 but updated
- Developed with multi-Center subject matter expertise: medical, human factors, environments, habitability, and engineering

SFHSS, Volume 2, Contents

Table of Contents:

- Section 1 – Scope
- Section 2 – Applicable Documents
- Section 3 – General
- Section 4 – Human Physical Characteristics & Capabilities
- Section 5 – Human Performance & Cognition
- Section 6 – Natural & Induced Environments
- Section 7 – Habitability Functions
- Section 8 – Architecture
- Section 9 – Hardware & Equipment
- Section 10 – Crew Interfaces
- Section 11 – Spacesuits
- Section 12 – Operations: *Reserved*
- Section 13 – Ground Maintenance & Assembly: *Reserved*
- Appendix A – Reference Documents
- Appendix B – Acronyms
- Appendix C – Definitions

Note: The HIDH Table of Contents is the same for ease of reference

Evolution of NASA-STD-3000

- NASA-STD-3000:
Man-System Integration Standards (MSIS)
 - First baselined Agency-wide in the late 1980's
 - NASA's first space flight human & environmental factors, and habitation standard
 - Applicable to space flight systems with human crews
 - Targeting systems design to support human health and productivity in space flight programs
 - First adopted by the International Space Station Program (ISSP) as SSP 50005, "ISS Flight Crew Integration (FCI) Standards"
 - MSIS was written primarily for Space Station architecture

Evolution of NASA-STD-3000 (cont'd)

- Drivers behind the need to update/replace NASA-STD-3000
 - Too comprehensive
 - Programs want only well-written, verifiable, “bottom line” statements of intent—i.e., standards
 - The MSIS covered too much in a single document:
 - Human/Systems Integration (HSI) Standards
 - Descriptive HSI discipline knowledge in human space flight
 - Lessons learned
 - Examples
 - Other criticisms:
 - Too ISS-centric
 - Delved beyond functional intent and into design solutions
 - Some requirements’ verifiability was questioned
 - Not updated as often as originally planned
 - Not updated with technology changes or lessons learned

From NASA-STD-3000 to Vol. 2 & HIDH

- No essential data in NASA-STD-3000 is being deleted
- MSIS standards (“SHALL”s) are flowing to SFHSS, Volume 2
 - Stand-alone statements reinforced with rationales
 - 177 pages, including appendices (156 without)
- MSIS discipline data and details are flowing to the HIDH
 - New document. Handbook, not a standard. More pages than the MSIS
 - Cross-referenced to SFHSS, Volume 2. Identical Table of Contents
 - Online publication designed for frequent updates

From NASA-STD-3000 to Vol. 2 & HIDH (cont'd)

- Transferring MSIS data to two documents enhances access and usability
 - Vol. 2 Standards are succinct and in a format useful to Programs and Projects
 - HIDH supporting data can be more readily updated when new information becomes available via lessons learned, experience, and research
 - Cost-effective: HIDH data not maintained and reviewed at NESP expense
- Both documents have been pre-coordinated through several multi-Center reviews
- HIDH will enter NASA Scientific & Technical Information (STI) Program publication at the same time Volume 2 enters NESP
 - July, 2009

NASA-STD-3000



Space Flight Human Systems Standard (SFHSS):

- **Vol. 1** Crew Health
- **Vol. 2** Habitability and Environmental Health

Human Integration Design Handbook (HIDH)

NASA Human Integration Design Handbook

Office of the Chief Health and Medical Officer



Basic
TBD
National Aeronautics and Space Administration

- Standards
- Background Data
- Design Guidance
- Reference Data

Human-System Integration Requirements (HSIR)

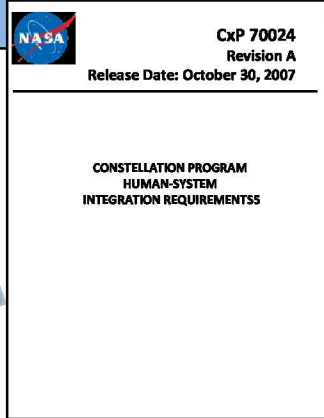

- Updated...
- Background Data
 - Design Guidance
 - Reference Data
 - Lessons Learned
 - Examples

NASA Space Flight Human System Standard

Volume 1
Crew Health
Office of the Chief Health and Medical Officer



Basic
November 2007
National Aeronautics and Space Administration

NASA Space Flight Human System Standard

Volume 2
Habitability and Environmental Health
Office of the Chief Health and Medical Officer



Basic
TBD
National Aeronautics and Space Administration

- Agency-Level Standards

- Program-Specific Requirements

Current Status: NASA-STD-3000

- NASA-STD-3000, MSIS, was last formally updated in 1995
- NASA-STD-3000 remains the current generic--(not the ISSP- or CxP-specific)--NASA human/systems standard until the SFHSS, Volume 2, is baselined in late 2009

Current Status: SFHSS, Volume 2

May 21, 2009, Baseline Draft delivered to NASA HQ Office of the Chief Engineer (OCE) from the OCHMO on June 15th, 2009, for subsequent NASA Engineering Standards Program (NESP) entry

- Release by the NESP initiates Agency-wide dissemination and review

Program-specific HSI Requirements

- Since the creation of NASA-STD-3000, the two major NASA human spaceflight Programs have created and controlled Program-specific HSI requirements based on the -3000 standards
 - Space Station-specific implementation is SSP 50005, ISS Flight Crew Integration (FCI) Standards
 - Baselined in 1994
 - Constellation-specific implementation is CxP 70024, Human Systems Integration Requirements (HSIR)
 - Baselined December 15, 2006; Currently at Revision C1
- SFHSS, Volume 2, acknowledges and supports
 - Requires creation of program-specific requirements

From Standards to Program-Specific Requirements

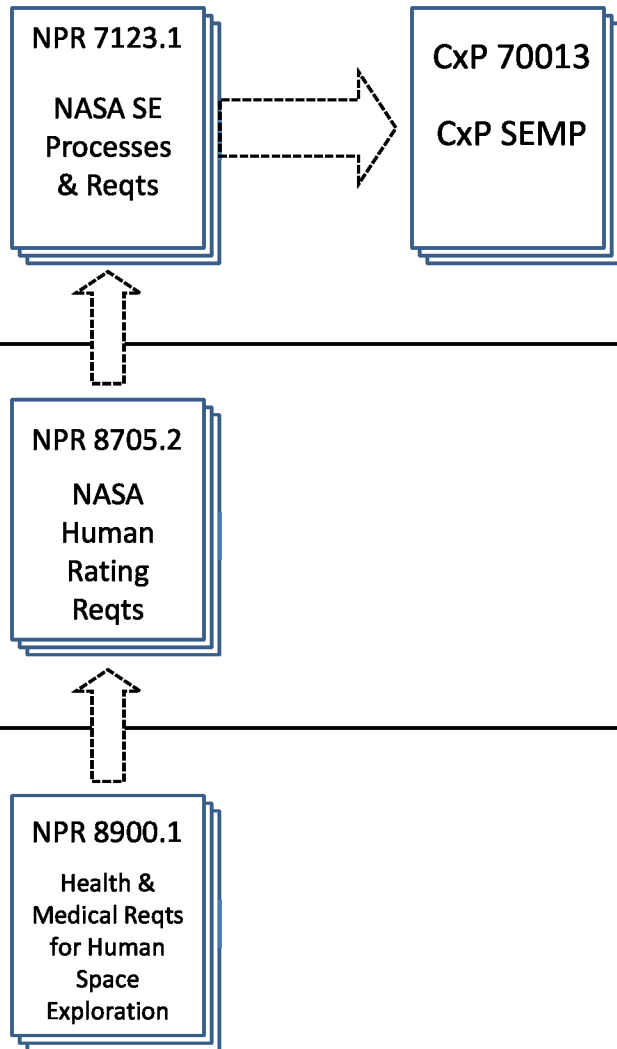

- NASA Systems Engineering Processes & Reqs addresses tailoring for NASA Programs/Projects
 - Appendix F: Tailoring
- The CxP SE Management Plan is the Program-Specific version used for MSIS-to-HSIR
 - Appendix C: Standards & Specs Tailoring
- NASA Human Rating Requirements
 - Currently invokes SFHSS, Vol. 1 and NASA-STD-3000 on human space flight programs
 - Will invoke Vol. 2 when NESP baselined
 - Might invoke both through NPR 8900.1
- NASA Health & Medical Requirements
 - Top level HMTA Procedure
 - Directs establishing Volume 1 and Volume 2 (NASA-STD-3000 until Vol. 2 is baselined)

From Standards to Program-Specific Reqts: Example #1

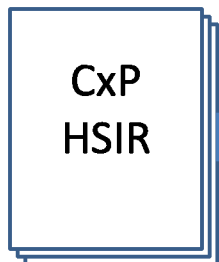

- Water Quantity standard:
 - “The system shall provide sufficient quantities of potable water per crewmember per mission day to support food rehydration in addition to a minimum quantity of 2.0 kg (4.4 lbs) of potable water per crewmember per mission day for drinking.”
- HIDH information:
 - Water quantity needed per person for drinking is well defined
 - Water quantity needed for food hydration is highly dependent on the design of the food system. Current systems (Shuttle, ISS) require approximately 0.5 kg per crewmember per mission day for rehydration of food based on 2007 use ratios of thermostabilized, freeze-dried, and natural-form foods from the ISS menu. ...etc.
- Water Quantity requirement:
 - “The system shall provide a minimum of 2.0 kg (4.4 lb) of potable water per crewmember per mission day for drinking and a minimum of 0.5 kg (1.1 lb) of potable water per crewmember per mission day for food rehydration.”
 - (Orion SRD: Potable Water Tankage: “The Orion shall provide tankage for a minimum of 2.5 kg (5.5 lbs) of potable water per crewmember per mission day for drinking and rehydration of food.”)

From Standards to Program-Specific Reqts: Example #2



- Anthropometry & Biomechanics standard:
 - “Each program shall identify or develop an anthropometry, biomechanics, aerobic capacity, and strength data set for the crewmember population to be accommodated, in support of all requirements in this document.”
 - Also more specific data on the applicability body length, range of motion and reach



- HIDH information:
 - HIDH contains significant information on the derivation of anthropometry and biomechanics data—e.g., populations, critical dimensions—as well as considerable information on how to apply the data during space flight systems design

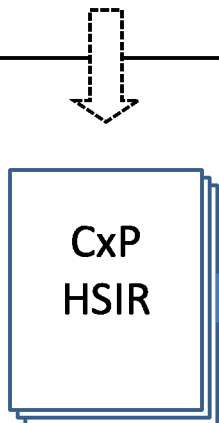

- Anthropometry & Biomechanics requirement:
 - “The system shall provide fit, access, reach, view and operation of human system interfaces in crew functional areas for unsuited crewmembers as defined in Appendix B, Tables B1-1 through B1-8.”

From Standards to Program-Specific Reqts: Example #3

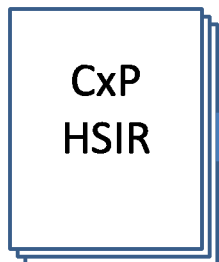
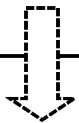
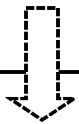

- Air Temperature standard:
 - “The system shall maintain the atmospheric temperature within the range of 18 °C (64.4 °F) to 27 °C (80.6 °F) during all nominal operations, excluding suited operations, ascent, entry, landing, and post-landing.”
-
- HIDH information:
 - “Maintaining proper atmospheric temperature is important for maintaining a safe body core temperature, and is also important for comfort. Humans can survive in a wide range of atmospheric temperatures over various amounts of time, but human comfort without use of thermal protective garments requires a fairly narrow temperature range. The Space Shuttle temperature can be controlled within the range of 18-27 °C (64-81 °F)” ...etc.
- Air Temperature requirement:
 - “The system shall maintain the atmospheric temperature within the range of 18 °C (64.4 °F) to 27 °C (80.6 °F) during all nominal operations, excluding suited operations, ascent, entry, landing, and post-landing.”

Potential CxP Impacts from Vol. 2 Baseline

- Most all Volume 2 standards have CxP 70024, HSIR parallels
 - The CxP HSIR preceded the creation of Volume 2 and served as a source
 - Technically, when baselined, Volume 2 standards will be the “parents” of HSIR “children” requirements
- In two areas, Volume 2 standards will need review by the CxP for inclusion into the HSIR as new requirements
 - Human-Centered Design Process
 - Currently being pursued for Orion despite there being no Volume 2 or HSIR driver
 - SOW and process proposals will be readied for Altair before contract initiated
 - Strategic SLSD plan is to also pursue inclusion in NASA Systems Engineering Handbook and NPR 7120.5, NASA Program Management Plan
 - Two “Reserved” Chapters
 - Ground Maintenance & Assembly – much content already in HSIR
 - Operations – to begin development in FY10

Plan for maintaining SFHSS, Volume 2

- Periodic review with 5-year cycles is “typical” for NASA standards.
 - A process document is in development for the periodic “call” for updated data/information prior to cyclical NESP review
 - Additional processes will be in place for interim revisions between 5-year calls
 - A change in Volume 2 will initiate review of comparable HIDH section (and vice versa)
- Updated information will be vetted through Space Life Sciences and extended SME communities prior to formal Agency-wide NESP review

Summary

- **Space Flight Human Systems Standards (SFHSS) created**
 - Volume 1 = Crew Health
 - Volume 2 = Human Factors, Habitability and Environmental Health
 - supported by the Human Integration Design Handbook (HIDH)
 - Both comprise NASA-STD-3001
 - Both driven by NPR 8900.1, HMTA reqts and invoked by NPR 8705.2, HRR
 - Applicable to all human space flight programs and projects
- **Information in NASA-STD-3000 migrated to the SFHSS**
 - 1) SFHSS, Vol. 2 = Human & Environmental Factors and Habitability Standards
 - 2) HIDH = Additional supporting data
- **Human-centered Program-specific requirements are derived from the SFHSS with supporting help from the HIDH**

