

Source of Acquisition  
CASI Acquired

To: Mr. Chas. J. McCauley  
Asst. Dir. Mgr.  
Vought-Sikorsky Aircraft

VOUGHT-SIKORSKY AIRCRAFT LIBRARY

NATIONAL ADVISORY COMMITTEE FOR AERONAUTICS

SPECIAL REPORT No 142

THIS DOCUMENT AND EACH AND EVERY  
PAGE HEREIN IS HEREBY RECLASSIFIED  
FROM Conf TO Unclass  
AS PER LETTER DATED NACA Release  
notice # 122

MECHANICAL PROPERTIES OF FLUSH-RIVETED JOINTS

By Wm. C. Brueggeman and Frederick C. Roop  
National Bureau of Standards

January 1940

142

SR-142

# MECHANICAL PROPERTIES OF FLUSH-RIVETED JOINTS

By Wm. C. Brueggeman and Frederick C. Roop

## SUMMARY

The strength of representative types of flush-riveted joints has been determined by testing 865 single-shearing, double-shearing, and tensile specimens representing 7 types of rivet and 18 types of joint. The results, presented in graphic form, show the stress at failure, type of failure, and  $d/t$  ratio. In general, "dimpled" joints were appreciably stronger than countersunk or protruding-head joints, but their strength was greatly influenced by constructional details. The optimum  $d/t$  ratios have been determined for the several kinds of joints. Photomicrographs of each type show constructional details and, in several instances, cracks in the sheet.

## I. INTRODUCTION

Aluminum-alloy sheet metal fastened by rivets is widely used as an exterior "skin" or plating on modern aircraft. The performance of aircraft depends to some extent on the smoothness of this skin because protuberances and irregularities cause frictional resistance. Protruding rivet heads are known to be an important source of skin friction both in air (references 1, 2, and 3) and in water (references 4 and 5). This consideration has caused manufacturers to use various "flush" rivets; that is, rivets the manufactured head of which is virtually continuous with the adjacent sheet.

Many highly ingenious designs and techniques for flush riveting have been developed. Generally a recess is formed in the sheet by either "countersinking" or "dimpling" to fit the manufactured head of the rivet. By "countersinking" is meant the removal of metal at one end of the rivet hole to form a circular bevel. "Dimpling" consists of forming an indentation in the sheet by means of suitable dies applied by pressure or impact. Dimpling is used to a greater extent than countersinking in thin sheets, but where sheets

are joined to a relatively thick structural member the sheet is often dimpled and the member countersunk. Details of flush-riveted joints used in German aircraft are given in reference 6. Reference 7 describes an American manufacturer's production methods for flush riveting. Tools for drilling, dimpling, countersinking, and heading in flush riveting are described in reference 8.

The procedure and assumptions used in the design of protruding-head or countersunk-head riveted joints for aircraft are substantially the same as those used for decades in the design of other riveted engineering structures. An adequate concept of the strength of dimpled joints cannot be obtained on this familiar basis, however, because a considerable portion of the load on a dimpled joint may be transmitted through the bearing surfaces of the dimple without acting on the rivet. Dimpled rivets are of major importance in modern flush riveting; a wide variety of constructional details and fabrication techniques are used. Consequently, a large amount of systematic test data would be required to put the design of dimpled joints on a basis as rational as the regular procedure for designing protruding-head and countersunk-head riveted joints. Although most manufacturers have made tests of the type of flush rivet used in their particular aircraft, technical literature contains little information useful in designing flush-riveted joints. It is the object of this investigation to obtain and make available such information. The work was carried out by the National Bureau of Standards at the request of the National Advisory Committee for Aeronautics.

## II. SPECIMENS

### 1. General

Seven airplane manufacturers and the Naval Aircraft Factory cooperated by furnishing specimens representative of commercial production. Each manufacturer fabricated specimens according to his own production methods. In addition, two groups of specimens were fabricated at the National Bureau of Standards, using special-oval-countersunk and brazier-head rivets, respectively. Although these are not strictly flush-riveted joints, they were included because they are alternative types which are sometimes used; the brazier-head specimens also permit a comparison with a conventional protruding-head type.

## 2. Design

A standardized series of single-shearing, double-shearing, and tensile (load parallel to the rivet axis) specimens was used. A schematic load diagram for each kind is given in figure 1; drawings of the specimens are given in figures 2 and 3. The specimens were made as elementary as possible to permit an easy comparison between the different types of rivets.

Tensile specimens were included because it is obvious that some resistance to pulling the rivet heads out of the sheet is required, notwithstanding the assumption by many designers that the strength of a rivet under tensile load is negligible. Probably severe conditions of tensile loading would more often result from accident than from design. Portions of the plating of aircraft have been known to tear off when through accident the interior surface of the plating became exposed to the dynamic pressure of the air; the loading of a single-shearing joint (fig. 1) to failure is generally accompanied by bending of the offset members and resultant tensile loading of the rivet; local buckling of sheet often exerts prying forces on the rivets.

The shearing specimens (fig. 2) consisted of overlapping strips of sheet fastened by single rivets. The expression for the width shown in figure 2 gives a constant ratio of net cross-sectional area of the sheet at the rivet to the area of the rivet. The double-shearing specimen was left optional. The specimens were held in the testing machine by pin connections as shown in figure 4. In the type of single-shearing specimen that was used, the deformation before failure of the sheets is believed to be greater and the conditions of loading more severe than if two or more rivets had been used in tandem or two abutting sheets had been riveted to a third sheet.

The tensile specimen (fig. 3) consisted of two square sheets riveted together at the center. Each sheet was bolted to a flange (fig. 5) which was connected to the testing machine. Specimens having different rivet diameters were geometrically similar in the plane of the sheets; therefore, the results are directly comparable if the  $d/t$  ratio is the same. The results of all tensile tests of riveted joints necessarily depend on the design of the specimen and fixture, therefore the results obtained in this investigation are not directly comparable with re-

sults obtained by other methods.. Tensile tests of protruding-head-riveted joints are reported in reference 9. The specimen was of the same design used in the present investigation.

### 3. Description and Macrostructure

All manufacturers submitted single-shearing and tensile specimens; some submitted double-shearing specimens. Each manufacturer is designated by a symbol A, B, C, D, E, F, or G. The Naval Aircraft Factory is designated by NAF and the National Bureau of Standards by NBS. Cross-sectional drawings of the joints are shown in figure 6. Each type of rivet is shown in the first vertical column. The respective types of joint for which each rivet was used are shown crosswise of the figure. The types of rivet are identified by one-digit numbers. The types of joint are identified by two-digit numbers, of which the first digit identifies the rivet and the last pertains to the type and construction of the joint (single-shearing, double-shearing, dimpled, countersunk, etc.) as given in table I.

TABLE I. Meaning of Second Digit in Joint Numbers

Single shearing	Double shearing	Meaning
1	5	All sheets dimpled.
2	6	Machine countersunk.
3	7	Protruding brazier head.
4	8	One sheet dimpled, one sheet machine countersunk.

The joint numbers, number of specimens, and the materials are given in table II.

TABLE II. Types, Materials, and Number of Specimens

Manu- fac- turer	Joint type	Rivets		Sheet		Notes		Number of specimens			
		Material	Specifi- cation	Material	Specifi- cation	Riv- ets	Sheet	Single shear- ing	Ten- sile	Double shear- ing	Total
A	62,66	A17ST	--	Alclad 24ST	--	{	6	6	6	6	48
	62,66	24ST	57-152-5)		--		1	6	12	12	
B	11	A17ST	AN425AD	24ST	11066	{	3	2	44	23	73
	51	A17ST	AN455AD		11066		3	2	3	3	
C	31,35	A17ST	--	Alclad 24ST	--	{	6	6	18	34	15
D	11	17ST	AN425D	Alclad 24ST	11067	{	3	2	27	18	--
E	21,25	A17ST	--	24ST	--	{	6	7	9	25	6
	22	A17ST		24ST			6	7	6	3	--
	24,28	A17ST		24ST			6	7	--	11	3
F	11	17ST	--	24ST	--	{	6	6	30	24	63
	12	17ST		24ST			6	6	12	12	
G	11	A17ST	25526A	Alclad 24ST	{	11067	2	2	30	30	--
	11	24ST	25526A				11067	2	2	15	15
NAF	41,45	17ST	46A4	24ST	47A10	{	5	4	17	18	6
NBS	53,57	A17ST	43R5INT	24ST 24SRT	47A10INT 47A10INT	{	4	4	60	60	24
	72,76	A17ST	43R5 INT				Alclad-	47A8	4	4	60
	72,76	17ST	43R5INT	24ST			4	4	30	30	12

1. Army specification for rivet wire.

NOTES

Grand total

865

2. Air Corps specification.

3. Air Corps standard (part of Air Corps Specification 25526A).

4. Navy specification. 5. Navy specification for rivet wire.

6. No specification given.

7. Manufacturer E stated that the sheet complied with Air Corps Specification 11067 (Alclad 24ST) but the sheet is obviously not Alclad. Believed to be 24ST.

To determine the constructional details and the occurrence of cracks, specimens were sectioned through the rivet and photomicrographs (figs. 7 to 11 inclusive) were made by the Metallurgical Division. The specimens selected for photomicrographing were one having the greatest and one having the least  $d/t$  ratio for each type. To determine whether the sheet was cracked radially at the rivet hole, two additional specimens of each type of dimpled joint were sectioned at a plane normal to the rivet axis and intersecting the dimpled sheet at the edge of the rivet hole on the convex side. Cracks, shown in figure 10(b), were found in only one specimen, type 21.

The following description of the specimens contains a summary of each manufacturer's statement regarding his specimens followed by other information obtained from an examination of the specimens.

Manufacturer A - rivet 6, joints 62 and 66, figures 6 and 7.- An included angle of  $100^{\circ}$ , a slight crown, and a cylindrical edge were shown in a drawing of type-6 rivets submitted by manufacturer A. He stated that the rivets were driven by hand in machine-countersunk sheets and finished with a rivet peen.

Figure 7 shows a slight crevice between the manufactured head and the sheet. Such a crevice is said to facilitate corrosion by retaining moisture.

Manufacturer B - rivet 1, joint 11; rivet 5, joint 51, figures 6 and 8.- The manufacturer stated that  $78^{\circ}$  countersunk-head rivets conforming to Air Corps Specification 25526-A, Standard Sheet AN425 type AD, were used in the majority of the specimens (joints 11) and a few brazier-head rivets, type AN455AD, were used (joint 51). All sheets were dimpled. Rivets  $3/32$  inch to  $5/32$  inch in diameter were driven by a pneumatic gun; rivets of diameters  $3/16$  inch and  $1/4$  inch were driven by hand.

Figure 8 shows that the dimple of type-11 joints was curved to an unusually large radius, probably to avoid cracks. The gradual curvature at the dimple introduces a crevice between the manufactured head and the sheet, also a certain amount of waviness in the surface of the joint due to the large diameter of the dimple. According to reference 6, tests of airfoils containing a pattern of annular grooves 0.007 inch deep simulating the crevice between the head of a  $3/32$ -inch dimpled rivet and the sur-

rounding sheet show that such grooves increase the drag appreciably, even though no part of the rivet projects above the sheet.

The brazier head of the type-5 rivets is flattened during driving and becomes approximately flush with the sheet as shown in figure 8. Severe shearing deformation of the sheets at the rim of the manufactured head is evident in the type-51 joint. The top sheet has cracked at this location. This deformation probably resulted either from poorly fitting dimpling tools or from excessive pressure.

Manufacturer C - rivet 3, joints 31 and 35, figures 6 and 9. - Manufacturer C stated that his rivets had an included angle of  $100^\circ$  and a cylindrical edge. They were driven by a process termed "punch countersinking" in which the manufactured head forms its own dimple. A special "one-shot" gun was used. This rivet and process were adopted after considerable experimenting. The tools used to drive the rivet were not described, but it is probable that dimpling of the sheets and heading of the rivet were accomplished with the same tools and at the same time. An included angle of  $100^\circ$  was said to be best for self-dimpling heads. Heads having a smaller angle are extruded into the hole to some extent and the remaining material is severely cold-worked to a final shape, which may be too shallow in spite of the greater initial depth. Heads having included angles greater than  $100^\circ$  are initially too shallow to have adequate strength and rigidity. The purpose of the cylindrical edge on the manufactured head is to prevent fatigue failure which had been found to occur in sharp edges and also to prevent damage in handling and shipping. The usual type of pneumatic hammer was found to be inadequate for driving this form of self-dimpling rivet. Several powerful hammer blows were said to give much better results than a large number of light blows which work-harden the rivet unnecessarily and cause radial deformation of the sheets. A "one-shot" hammer powerful enough to drive rivets in two or three blows was developed by manufacturer C. Punch countersinking was said to be most satisfactory for sheet thicknesses between 0.014 inch and 0.064 inch.

Cross sections of joints 31 and 35 are shown in figure 9(a). When driving self-dimpling rivets, if the  $d/t$  ratio is very low the compressive stress in the manufactured head corresponding to the load required to dimple the



sheet becomes so great that a very shallow manufactured head results. (See fig. 9(a).)

The top joint in figure 9(a) apparently has a crack in the rivet shank which is shown enlarged in (b). However, when the shank was again sectioned, as shown in (c), at  $90^\circ$  to the plane exposed in (a) and (b) no crack was visible. The deformed and undeformed grains of this rivet are shown in figure 9(d) and (e), respectively.

Manufacturer D - rivet 1, joint 11, figures 6 and 8.- This manufacturer stated that his  $78^\circ$  countersunk-head type AN425D rivets, were driven by a "one-shot" gun in machine-dimpled sheets.

Figure 8 shows that the radius of the dimple was comparatively short. Practically the full depth of the manufactured head is in contact with the dimple. The rivet holes appear to have been redrilled after dimpling. The driven head in the lower joint is folded around the edge of the lower sheet.

Manufacturer E - rivet 2, joints 21, 22, 24, 25, and 28, figures 6 and 10.- A drawing of type-2 rivets submitted by manufacturer E showed a  $78^\circ$  manufactured head smaller in diameter and depth than type 1. All rivets were  $1/8$  inch in diameter. It was stated that all sheets in the joint were dimpled simultaneously with a special tool in a pneumatic vibrator except in the case of 0.051- and 0.064-inch sheets, which were machine countersunk. Where sheets of these thicknesses were joined to thinner sheets, the latter were dimpled by "vibrating" them into the countersunk recess (types 24 and 28). The sheets in most of the tensile specimens were unequal in thickness. The thinner sheet was adjacent to the manufactured head in every case. The rivets were driven with a squeezer.

Cross sections of four joints submitted by manufacturer E are shown in figure 10(a). No cracks are visible, but when tensile tests were made it became evident that the sheets of some of the joints were cracked at the rim of the dimple. Other specimens, (c) and (e), figure 10, were examined subsequently and circumferential cracks were found. (See also (d) and (f), fig. 10.) The two cracks shown are probably the result of dimpling the sheet around too short a radius in an effort to obtain a smooth flush surface at the rivet head.

Figure 10(b) shows radial cracks found in the 0.040-inch sheet of a type-21 joint when sectioned at a plane normal to the rivet axis and intersecting the dimple on the convex side. The sheet sectioned was adjacent to the driven head.

Manufacturer F - rivet 1, joints 11 and 12, figures 6 and 8.- 78° countersunk rivets (AN425-D, Air Corps Specification 25526-A) were used. Sheets less than 0.102 inch thick were dimpled with punches having a 78° included angle for the sheet adjacent to the manufactured head, and a 90° angle for the other. The 0.102-inch and 0.125-inch sheets were machine countersunk. The rivets were driven by a pneumatic hammer.

Manufacturer G - rivet 1, joint 11, figures 6 and 8.- 78° rivets (AN425AD and AN425DD, Air Corps Specification 25526-A) were used (fig. 8). It was stated that the rivets were driven (not squeezed), presumably by a pneumatic hammer. The dimples shown in figure 8 are formed to a comparatively long radius.

NAF - rivet 4, joints 41 and 45, figures 6 and 8.- The Naval Aircraft Factory furnished a drawing of their self-dimpling rivet. It is similar to the brazier-head, but has a larger fillet between the head and the shank. The rivet hole is drilled with a radius-counterbore drill, which forms the edge of the hole to fit this fillet. A recessed rivet set (fig. 12) is used at the driven head and a flat set at the manufactured head. Under the impacts of a "one-shot" hammer the shank is upset, the convex surface of the head is hammered flush with the sheet, and the sheets are dimpled with the same tools and at the same time. Three blows are required for 1/8-inch rivets and five blows for 5/32-inch rivets.

Objectionable "dishing" of the sheet surrounding the rivet was evident in these joints.

NBS - rivets 5 and 7, joints 53, 57, 72, and 76; figures 6 and 11.- Special-oval-countersunk-head rivets, type 7, and brazier-head rivets, type 5, were used in joints fabricated at the National Bureau of Standards. Specifications for these rivets are included in Navy Department Specification 43R5c (designated types 1 and 2, respectively, in that specification). The crown of the type-7 rivet has a 1/32-inch depth for all sizes and the included angle

of the head is decreased with increasing diameter. The sheet was machine countersunk.

The rivets were sawed to a length equal to the grip plus a head allowance of  $1-1/4$  diameters. Two methods of driving were used, pressing and hammering. The load was applied to the press-driven rivets in a hydraulic testing machine (fig. 13). The diameter of the driven head was made  $1-1/2$  times the shank diameter. The driving stresses used were 150,000 pounds per square inch for Al7ST and 175,000 pounds per square inch for 17ST rivets. The drop hammer (fig. 14) was used for the hammer-driven rivets. Five equal blows were used for each rivet. The height of drop, given in table III, was experimentally determined in advance to produce a diameter of driven head  $1-1/2$  times the shank diameter. This method of hammering was adopted because it gives controllable and reproducible conditions of driving.

TABLE III. Weight and Fall of Drop Hammer

Rivet diameter (in.)	Hammer weight (lb.)	Fall (ft.)
1/8	5	1.0
5/32	5	1.6
3/16	5	3.1
1/4	20	1.1

Special-oval-countersunk-head rivets are also used in dimpled sheets, as specified in Naval Aircraft Factory Process Specification PR-1a for Sunken Rivet Construction in Bottom Plating of Main Floats. In this case the dimple is of such a depth that the top of the manufactured head is flush with the surface of the sheet outside the dimple. Joints of this type were not tested in this investigation. According to tests reported in reference 4, this construction offers no hydrodynamic advantage over a dimpled or countersunk joint in which the crown of the head projects beyond the adjacent sheet.

TABLE IV. Tensile Properties of Aluminum-Alloy Sheet

Manu- fac- turer	Material	Sheet thick- ness (in.)	Yield strength (lb./sq.in.)	Tensile strength (lb./sq.in.)	Elonga- tion in 2 in. (percent)	Notes*
A	Alclad 24ST	0.032	41,300	63,200	18-1/2	Not submitted.
		.040	45,500	65,800	18	
		.051	40,100	63,200	20	
		.064	41,800	64,700	20-1/2	
		.072	43,200	64,600	19	
		.102	42,200	65,000	22-1/2	
		.128				
		.162	42,000	63,600	22	
B	24ST	.020	46,300	68,300	17	
		.025	46,000	68,100	19	
		.032	47,800	70,600	20-1/2	
		.040	45,700	70,600	21	
		.051	46,600	71,200	21	
		.064	45,900	70,000	21-1/2	
		.081	46,100	69,500	20-1/2	
		.102	46,500	69,700	19	
C	Alclad 24ST	.032	43,600	62,800	17	
		.051	41,900	64,000	20	
		.064	41,200	63,500	20	
		.090	42,200	65,000	21	
D	Alclad 24ST	.016	43,400	62,000	15	Submitted with shearing specimens " " tensile " " " shearing " " " " " " " tensile " " " shearing " " " tensile " " " shearing " " " tensile "
			45,300	64,600	16-1/2	
		.025	44,500	63,800	16-1/2	
		.032	44,400	63,700	16-1/2	
			40,700	61,200	18-1/2	
		.050	43,700	64,700	19	
			42,100	63,500	19-1/2	
		.064	41,200	62,600	19	
	41,400	62,700	19-1/2			

\*The length of the specimen was transverse to the direction of rolling (transversal) unless the specimen is denoted "longitudinal." The orientation was determined by inspection.

TABLE IV (Continued)

Manu- fac- turer	Material	Sheet thick- ness (in.)	Yield strength (lb./sq.in.)	Tensile strength (lb./sq.in.)	Elonga- tion in 2 in. (percent)	Notes*
E	24ST	0.020				No specimen available
		.025	45,500	69,200	20-1/2	
		.032	50,600	67,900	17	Subsize - longitudinal
		.040	46,200	68,700	16-1/2	
		.051				No specimen available
		.064	51,800	70,900	21	Subsize - longitudinal
F	24ST	.025	45,400	70,000	20	Subsize
		.032	43,800	67,100	21	"
		.040	45,000	68,300	18	"
		.051	53,100	71,700	18	Subsize - longitudinal
		.064	44,900	67,200	20	Subsize
		.102	46,200	70,000	22	"
		.125	49,100	70,800	19	"
		G	Alclad 24ST	.016	42,900	62,200
	42,400			61,900	17	" " tensile "
.020	42,900			61,600	18-1/2	" " shearing "
	42,100			62,300	17-1/2	" " tensile "
.025	43,700			62,800	17	" " shearing "
	43,200			64,800	18	" " tensile "
.032	44,600			65,600	18	" " shearing "
	41,500			62,500	18	" " tensile "
.040	41,500			62,900	19	" " shearing "
	42,500			63,100	20	" " tensile "

\*The length of the specimen was transverse to the direction of rolling (transversal) unless the specimen is denoted "longitudinal." The orientation was determined by inspection.

TABLE IV (Continued)

Manu- fac- turer	Material	Sheet thick- ness (in.)	Yield strength (lb./sq.in.)	Tensile strength (lb./sq.in.)	Elonga- tion in 2 in. (percent)	Notes*
NAF	24ST	0.032	41,300	65,300	19-1/2	
			41,600	65,600	19-1/2	
		.040	41,300	63,800	18-1/2	
		.051	41,900	65,300	21-1/2	
		.064	40,400	62,800	21-1/2	
NBS	24ST	.032	46,200	69,180	19	
	RT		54,800	72,500	15	
	T alclad		41,600	63,400	18	
	T	.051	46,900	69,400	19-1/2	
	RT		57,500	73,400	15	
	T alclad		43,500	64,400	19	
	T	.081	46,800	69,800	20	
	RT		56,300	71,600	13-1/2	
	T alclad		43,400	65,400	21	
	T	.102	41,600	68,700	22	
	RT		55,700	71,800	14-1/2	
	T alclad		42,100	63,300	20	

\*The length of the specimen was transverse to the direction of rolling (transversal) unless the specimen is denoted "longitudinal." The orientation was determined by inspection.

#### 4. Mechanical Properties of Sheet and Rivet Wire

Samples of the sheet used in the joints were submitted by most of the manufacturers. Tensile specimens conforming to Type 5, Federal Specification QQ-M-151a for Metals - General Specification for the Inspection of - were machined from these samples and tested with the results given in table IV. The yield strength was determined by the offset method from the stress-strain diagram using a 0.2 percent set. The tensile properties of all the sheets for which samples were available complied with the requirements of U.S. Army Specification 57-152-6 Type II and Navy Department Specification 47A10a, Condition T; the tensile properties of the Alclad 24ST sheets complied with the requirements of U.S. Army Air Corps Specification 11067, Type II, and Navy Department Specification 47A8a, Condition T. In several instances where samples were not provided, subsize specimens were tested having a 1-inch gage length and a reduced section 1/4 inch wide. These were machined from shearing specimens of joints which had been tested. These results are also given in table IV.

Bend specimens conforming to Federal Specification QQ-M-151a par. 18b were machined from samples of all the sheet used. The bend properties of all the sheet complied with the requirements of the specifications named above under tensile properties.

TABLE V. Tensile Properties of Wire from Which  
NBS Rivets were Made

Rivet diameter (in.)	Yield strength (lb./sq.in.)		Tensile strength (lb./sq.in.)	Elongation in 4d (percent)
A17ST				
1/8	25,500		46,200	34.8
5/32	23,500		44,200	33.2
3/16	26,400		45,900	32.7
1/4	24,700		46,000	33.8
17ST				
1/8	34,300		58,700	28.9
5/32	33,400		57,500	27.5
3/16	36,700		61,300	29.2
1/4	37,300		62,500	30.3

Tensile and bend specimens of the aluminum-alloy wire from which the types 5 and 7 NBS rivets were made, were tested. The results for the tensile specimens, given in table V, complied with the requirements of Navy Department Specification 43R5c. The bend specimens also complied.

Samples of wire representing the rivets used by the manufacturers were not available.

### 5. Diameter of Driven Heads

The diameter of the driven head was measured on each of the joints submitted by the manufacturers to determine what diameter was considered adequate by manufacturers and to aid in interpreting the results of the tensile test. The minimum, average, and maximum diameter, expressed as a multiple of the nominal shank diameter is given in table VI (p. 16) for each size of rivet used by each manufacturer.

## III. TESTING

The shearing and tensile specimens were loaded to fracture as shown in figures 4 and 5, respectively, and the maximum load was determined. For each combination of sheet thickness and rivet diameter in the joints submitted by the manufacturers, three or four like specimens were tested. For each such combination in NBS joints, 15 specimens were tested, namely, 1 using each of three sheet materials (24ST, 24SRT, Alclad 24ST) in each of the following five groups: 17ST rivets, type 7, press-driven; Al7ST rivets, type 7, press-driven and hammer-driven; Al7ST rivets, type 5, press-driven and hammer-driven.



TABLE VI. Ratio of Driven-Head Diameter to Nominal Shank Diameter

Manu- fac- turer	Shank diameter														
	3/32			1/8			5/32			3/16			1/4		
	Min- imum	Aver- age	Max- imum	Min- imum	Aver- age	Max- imum	Min- imum	Aver- age	Max- imum	Min- imum	Aver- age	Max- imum	Min- imum	Aver- age	Max- imum
A				1.52	1.60	1.73	1.52	1.57	1.67	1.47	1.56	1.68			
B	1.53	1.67	1.86	1.53	1.66	2.03	1.43	1.64	1.79	1.42	1.67	1.92	1.55	1.66	1.89
C	1.61	1.89	2.20	1.57	1.68	1.82	1.62	1.75	1.88	1.72	1.84	2.05			
D	1.62	1.78	1.91	1.46	1.62	1.80	1.49	1.55	1.68						
E				1.58	1.71	1.92									
F				1.62	1.70	1.83	1.56	1.65	1.74	1.50	1.59	1.70	1.54	1.60	1.67
G	1.50	1.64	1.79	1.44	1.59	1.80	1.44	1.58	1.66						
NAF				1.37	1.52	1.66	1.28	1.49	1.62						
NBS*					1.50			1.50			1.50			1.50	

\* NBS rivets were driven under controlled pressure or impacts such that  $\frac{\text{head diameter}}{\text{shank diameter}} = 1.50$ , within  $\pm 5$  percent.

## IV. RESULTS

## 1. General

The strength of the single-shearing, double-shearing, and tensile specimens is plotted (upper series of points) against the  $d/t$  ratio in figures 15 to 38, inclusive.

The shearing stress at failure,  $S_s$ , was computed by dividing the maximum load  $P$  by the nominal cross-sectional area of the rivet for the single-shearing specimens and by twice the nominal area for the double-shearing specimens:

$$\left. \begin{aligned} S_s &= \frac{4P}{\pi d^2} \quad \text{for single-shearing specimens} \\ S_s &= \frac{2P}{\pi d^2} \quad \text{for double-shearing specimens} \end{aligned} \right\} (1)$$

The tensile stress at failure was computed for the tensile specimens by dividing the maximum load by the nominal cross-sectional area of the rivet. In computing the  $d/t$  ratio, the average of the measured thicknesses of both sheets was used for the single-shearing and tensile joints except where the two sheets were not of the same nominal thickness (types 21, 22, and 24). In this case the lesser thickness was used. Either the average thickness of the outer sheets of the double-shearing joints or half the thickness of the inner sheet, whichever was the lesser, ( $t_{\min}$ ), was used.

The bearing stress at failure may be estimated from the curves shown in the plots of shearing strength. These curves are drawn for constant values of bearing stress:

$$\left. \begin{aligned} S_b &= \frac{P}{dt} \quad \text{for single-shearing specimens} \\ S_b &= \frac{P}{2dt_{\min}} \quad \text{for double-shearing specimens} \end{aligned} \right\} (2)$$

They were calculated by eliminating  $P$  from (1) and (2) so that

$$\left. \begin{aligned} S_b &= \frac{\pi}{4} \frac{d}{t} S_s \text{ for single-shearing specimens} \\ S_b &= \frac{\pi}{4} \frac{d}{t_{\min}} S_s \text{ for double-shearing specimens} \end{aligned} \right\} (3)$$

The lower series of points in figures 15 to 38 indicates the rivet diameter (number = diameter in thirty-seconds of an inch) and the type of failure. (For meaning of symbols, see table VII (p. 19). Each point in the lower series corresponds to a point in the upper series plotted directly above it. Corresponding points in the two series can be identified by the similarity of their position with respect to other points. For example, in figure 15 the single-shearing specimen having the greatest strength is one of a group of three whose  $d/t$  ratio (abscissa) is 1.5. The ordinate of this point is  $S_s = 47,500$  pounds per square inch. Interpolation between the curves  $S_b = 40,000$  and  $60,000$  pounds per square inch, shows the bearing stress at failure to be about  $55,000$  pounds per square inch. The highest point in the lower series shows that the rivet diameter for this specimen was  $6/32$  or  $3/16$  inch, and the specimen failed by type  $j$ , which is shearing of the rivet shank (from table VII).

The Vickers number was determined on the manufactured head of some of the rivets used by manufacturer F to determine whether the six rivets in the type-12 joints which had low strengths ( $d/t = 1.5$ , three single-shearing and three tensile, fig. 24) also had low Vickers number. The Vickers number of these six rivets was found to be appreciably lower than the Vickers number of the other rivets used by manufacturer F. This may be indicative of a rivet alloy other than 17ST, or of improper heat treatment of these six rivets.

Typical failures of shearing and tensile joints are shown in figure 39. When comparing the strengths of different types of joints, it should be remembered that

- (a) The same alloys were not used in all joints,
- (b) The range of  $d/t$  is not the same for all groups, although in most cases the ranges overlap each other,
- (c) The plotted results exhibit considerable scatter in some cases, and
- (d) The trend of curves representing the strength of different types of joints may be different.

TABLE VII. Types of Failure

Letter	Meaning
a.	Rivet canted appreciably in direction of loading.
b.	Manufactured head pulled through sheet.
c.	Driven head pulled through sheet.
d.	Sheet tore at manufactured head.
e.	Sheet tore at driven head.
f.	Inner sheet tore (double-shearing joints).
g.	One sheet ruptured at circumference of dimple.
h.	Part or all of manufactured head sheared from shank.
i.	Part or all of driven head sheared from shank.
j.	Rivet shank sheared.
k.	Rivet shank crushed, ultimately failed by shearing.
l.	Rivet hole in an outer sheet elongated, shank canted and failed with jagged tearing fracture under combined shearing, tensile, bending, and bearing stresses.
m.	Rivet shank failed with tensile fracture.

## 2. Single Shearing

Figure 40 is a diagram summarizing the test results for all single-shearing specimens. Average strengths for like specimens were used in plotting this diagram. The lines indicate for a given  $d/t$  ratio, the upper and lower limits of the shearing and bearing stresses at ultimate load for each class of joint. For simplicity, all types of dimpled joints are grouped together in one class.

The lines designated by numbers in figure 40 may be interpreted as follows:

(1) Designates scattered points which appear anomalous for no obvious reason. Generally the range of  $d/t$  was too limited to establish the trend of a line representing these points.

(2) A horizontal line indicates that the shearing stress is critical and shows the range of  $d/t$  for maximum ultimate shearing stress.

(3) A vertical line indicates that the bearing stress is critical and shows the range of  $d/t$  for maximum ultimate bearing stress.

(4) A line showing decreasing ultimate shearing stress with increasing ultimate bearing stress indicates that both shearing and bearing stresses are critical. In this transitional range of  $d/t$  neither the ultimate shearing stress in the rivet nor the ultimate bearing stress in the sheet attains its maximum possible value.

(5) A line showing decreasing ultimate bearing stress with increasing  $d/t$  ratio at the greater values of  $d/t$  probably reflects buckling of the sheet before tearing failure occurs.

(6) A line showing decreasing ultimate bearing stress with decreasing  $d/t$  ratio for dimpled specimens probably reflects the decreasing "keying effect" of the dimple for joints employing self-dimpling rivets (types 31 and 51) as  $d/t$  is decreased below a critical value. The dimple tends to become shallower as  $d/t$  is decreased.

The lines described under (5) and (6) above are rather doubtfully defined by the data, because they stand at the extremes of the available range of  $d/t$  ratios. It is possible that an extension of the range of  $d/t$  ratios investigated would alter the picture in this respect, but such extreme values of  $d/t$  are of little practical importance.

A trend of variation with respect to  $d/t$  is evident in the type of failure as well as the strength of the dimpled joints, as follows:

<u>d/t ratio</u>	<u>Nature of Failures (see table VII)</u>
Less than 2.8	Rivet failure (type j) exclusively.
2.8 - 4.9 (about 60 per- cent of the dimpled joints tested fall in this range)	<p>Transitional between rivet and sheet failure:</p> <p>Type j (with a, d, or e in some cases), particularly in lower part of range.</p> <p>Type h, and a few type i (manufacturer B only) together with a and d, e or g.</p> <p>Type b or c with d, e or both and generally a, particularly in the upper part of the range.</p> <p>A few type g with a and d or e (manufacturer G only).</p>
Greater than 4.9	<p>Sheet failure.</p> <p>Nearly all type b or c, with d, e, or both, and generally a.</p> <p>A few type e and type g with a and d or e (manufacturer G only).</p> <p>One rivet failure, type aeh, <math>\frac{d}{t} = 6.0</math>, manufacturer F.</p>

It is to be noted that the values bounding the above three ranges of d/t ratio correspond closely to the values at which the lines (2), (3), and (4) for dimpled joints join each other in figure 40. By considering together the dependence of strength on d/t ratio, according to figure 40, and of failure type on d/t ratio, according to the preceding tabulation, and regarding this latter quantity as a parameter, the relationship of strength to failure type may easily be seen.

Figure 41 shows, on a diagram similar to figure 40, the detailed comparison among dimpled rivets between the various manufacturing techniques and rivet types. Each line on figure 41 is to be interpreted in similar manner to those on figure 40.

An examination of the results for the single-shearing specimens discloses the following significant points:

The critical shearing stress for protruding-head rivets is the same as for machine-countersunk rivets of the same alloy, but for the former, the critical bearing stress and the  $d/t$  ratio at which bearing stress becomes critical are higher. The scatter of the results on these joints is partly due to differences in sheet material; when shearing stresses are critical, joints in alclad material are slightly stronger than joints in 24ST and 24SRT, and vice versa when bearing stresses are critical. No significant difference can be found in the data between press-driven and hammer-driven rivets.

In some cases dimpled rivets had nearly twice the shearing and bearing strength of brazier and countersunk rivets. Figure 41 shows that in general the joints of manufacturer G (type-11) had the greatest strength, and that the difference between results (for type-11 joints) from different manufacturers is considerable. No conclusive explanation of this difference can be given, but a comparison of the photomicrographs (fig. 8) of the type-11 joints having the greatest strength (D and G) and the others (B and F) shows that in the former the sheets conform more closely to each other and to the rivet, with little or no void between them and a greater portion of the manufactured head in contact with the sheet. The test results for type-11 joints (fig. 25) show no significant difference in the shearing strength of dimpled joints employing Al7ST and 24ST rivets, respectively. These considerations support the conclusion that details of design and technique of fabrication predominate in determining the strength of a dimpled joint.

Over a limited range of  $d/t$  the type-41 joints were approximately equal to the best type-11 joints in strength; the results for the type-41 joints were unusually consistent.

### 3. Tensile

A general classification with respect to principal types of failure, similar to that made for single-shearing joints, may also be made for the tensile joints as follows:

<u>d/t ratio</u>	<u>Nature of Failures (see table VII)</u>
Less than 2.1	Rivet failure exclusively:  A few type m at the least values of d/t ratio (NBS only).  Type h.
2.1 - 4.0	Transitional between rivet and sheet failures:  Type h or dh (one type i, manufacturer B).  Type b, or bd with or without g or h.  Some type c, or ce with or without g or h.  A few type g.
Greater than 4.0	Sheet failure exclusively:  Type bd or ce with or without g.  Type g with or without d or e.

For tensile joints, these three classes do not correspond to any well-marked trends of the plotted data. No quantitative criteria are known, analogous to shearing stress (for rivet failure) and bearing stress (for sheet failure) in the case of shearing joints, to which critical values defining the tensile strength of a joint may be assigned.

The stress which is actually critical for rivet failure (except type m, tensile shank failure) is a combined bending and shearing stress on a cylindrical surface, which is the projection into the head of the lateral surface of the shank.

For sheet failure, the stress which is actually critical is either a hoop stress around the edge of the hole, or, for some dimpled joints, a combined shearing and bending stress at the most sharply curved section of the dimple.

Up to a d/t ratio of about 4, type-41 joints had the



greatest tensile strength; for  $d/t$  ratios above 4, type-31 joints were stronger. Types-21 and 24 joints had the least tensile strength.

The low tensile strength of some of the type-21 and 24 joints was definitely identified with the cracks in the sheet at the rim of the dimple, shown in figure 10(d) and (f). In type g failures the fractures occurred at the location where cracks were found in some of the joints. However, it is improbable that all of the joints failing by type-g had cracks. Type-g failure was not confined to types-21 and 24 joints only.

At the higher values of  $d/t$  many of the joints failed by pulling the driven head through the sheet, but it is not believed that in many cases the tensile strength would be increased appreciably by increasing the driven-head diameter (given in table VI) because tearing of the sheet commenced underneath the head at the edge of the hole.

#### 4. Double Shearing

Fewer types of double-shearing specimens were submitted than were types of single-shearing and tensile specimens, and the range of  $d/t$  covered by each type was generally less. Consequently, a classification of failure types, like those made in sections 2 and 3 above, is more difficult. Rivet failure (type j) exclusively occurred when  $d/t$  was less than 3.6 and transitional failures (types k and l, mingled with type j and with type b) occurred when  $\frac{d}{t} = 3.6 - 6.8$ . No specimens having a  $d/t$  ratio greater than 6.8 were tested.

For machine-countersunk joints (manufacturers A and NBS) the ultimate shearing and bearing stresses had about the same relation to  $d/t$  ratio as for the single shearing joints of these manufacturers. For self-dimpling rivets (manufacturers C and NAF) the ultimate shearing stress was lower than for comparable single-shearing joints. Probably this effect may be ascribed to the longer grip in double-shearing joints as compared to single-shearing joints of the same  $d/t$  ratio, which results in a shallower dimple. No double-shearing joints were submitted which would show whether the great superiority of some dimpled single-shearing joints over machine-countersunk joints could be duplicated for double-shearing joints.

The type-45 joints and the type-66 joints having 24ST rivets had the greatest strength of all double-shearing joints submitted.

## V. CONCLUSION

The mechanical properties of a joint, its surface smoothness, the occurrence of cracks, and the cost of production are all determining factors in selecting a flush-riveted joint. The importance of each of these interrelated factors must be decided by the manufacturer for each particular application. For this reason, it seems impracticable to rate individual types or to make a general statement regarding their merits.

Concerning the strength of flush-riveted joints in aluminum-alloy, the following conclusions may be drawn from data obtained in this investigation:

The optimum value of  $d/t$  ratio was the highest value for which shearing stress alone is critical, unless a high tensile strength is important, in which case a somewhat lower  $d/t$  ratio may be indicated. Approximate average values for the optimum  $d/t$  ratio, neglecting tensile strength, were as follows:

Class of joint	$d/t$
Single-shearing machine countersunk	2.1
Single-shearing dimpled	2.8
Single-shearing protruding (brazier) head	3.7
Double-shearing	3.6

At  $d/t$  ratios below 2.1, machine-countersunk joints had approximately the same shearing strength as brazier-head riveted joints. This strength was slightly higher for joints in alclad sheet than for joints in other sheets of the same alloy. Although dimpled joints of different designs from different manufacturers showed wide variations in strength, almost all dimpled single-shearing joints having a  $d/t$  ratio above 2.1 showed an important advantage in strength over machine-countersunk joints.

This value of  $d/t$  is probably the lower limit at which satisfactory dimpling can be performed.

A detailed comparison of the strength of the various types of single-shearing joints submitted by manufacturers for this investigation is shown in figures 40 and 41.

The number of cracks found in randomly selected dimpled joints emphasizes the need for avoiding severe bends when flanging the sheet to form the dimple. Unfortunately, it does not seem practicable to use a bend of long radius at the dimple without introducing bulging of the sheets and a crevice between the manufactured head and the sheet. The recent trend toward a larger included angle of the manufactured head ( $100^\circ - 120^\circ$ ) seems to offer a partial solution of this difficulty in that the smaller bend angle at the dimple permits a sharper bend without danger of rupture; some reduction in the shearing strength would be expected to accompany this increase in the included angle. The tensile test of joints was found to be effective in detecting circumferential cracks in the sheet at the edge of the dimple.

#### VI. ACKNOWLEDGMENTS

Credit is due the U.S. Army Air Corps for assistance in obtaining test specimens, the Boeing Aircraft Company, the Curtiss-Wright Corporation, the Douglas Aircraft Co., Inc., the Glenn L. Martin Co., the Naval Aircraft Factory, the North American Aviation, Inc., the Seversky Aircraft Corporation, and the Sikorsky Aircraft Division of United Aircraft Corporation for submitting test specimens of flush-riveted joints; to the Aluminum Company of America for donating the sheet and rivets used in the NBS joints, and the Metallurgical Division of the National Bureau of Standards for making photomicrographs of the joints.

National Bureau of Standards,  
Washington, D.C., November 1939.

## REFERENCES

1. Dearborn, Clinton H.: The Effect of Rivet Heads on the Characteristics of a 6 by 36 Foot Clark Y Metal Airfoil. T.N. No. 461, N.A.C.A., 1933.
2. Williams, D. H., and Brown, A. F.: Tests on Rivets and Backward-Lapped Joints, in the Compressed Air Tunnel. R. & M. No. 1789, British A.R.C., 1937.
3. Hood, Manley J.: The Effects of Some Common Surface Irregularities on Wing Drag. T.N. No. 695, N.A.C.A., 1939.
4. Truscott, Starr, and Parkinson, J. B.: The Increase in Frictional Resistance Caused by Various Types of Rivet Heads as Determined by Tests of Planing Surfaces. T.N. No. 648, N.A.C.A., 1938.
5. Parkinson, J. B.: Tank Tests to Show the Effect of Rivet Heads on the Water Performance of a Seaplane Float. T.N. No. 657, N.A.C.A., 1938.
6. Pleines, Wilhelm: Riveting Methods and Rivet Equipments Used in the German Light Metal Aeroplane Construction. Jour. R.A.S., September 1938.
7. Berlin, Don R., and Rossman, Peter F.: Flush Riveting - Considerations for Quantity Production. Jour. S.A.E., August 1939.
8. Holthe, Thorleif: Flush Riveting in Airplane Construction. Machinery, February 1939.
9. Brueggeman, W. C.: Mechanical Properties of Aluminum-Alloy Rivets. T.N. No. 585, N.A.C.A., 1936.

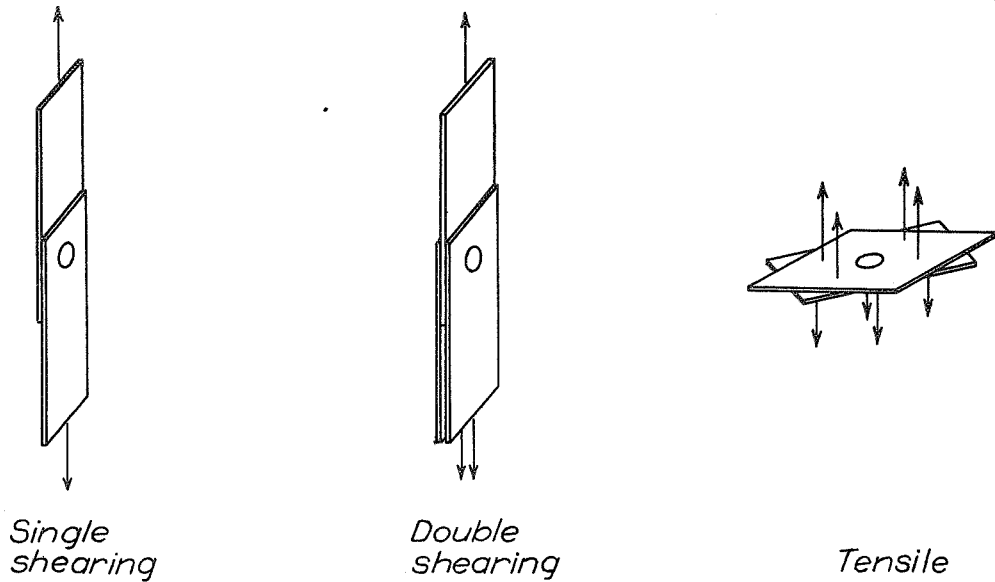

Figure 1.- Schematic diagram of specimens showing loads.

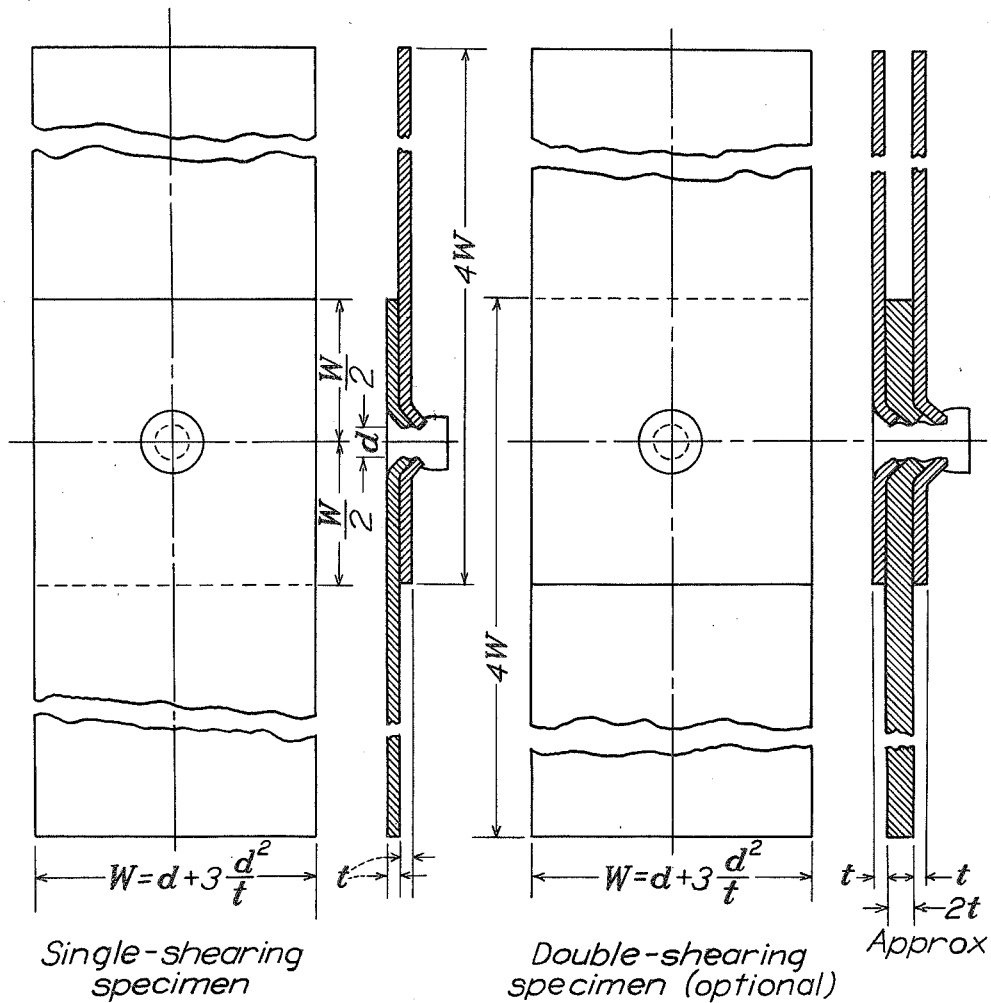

Figure 2.- Shearing specimens.

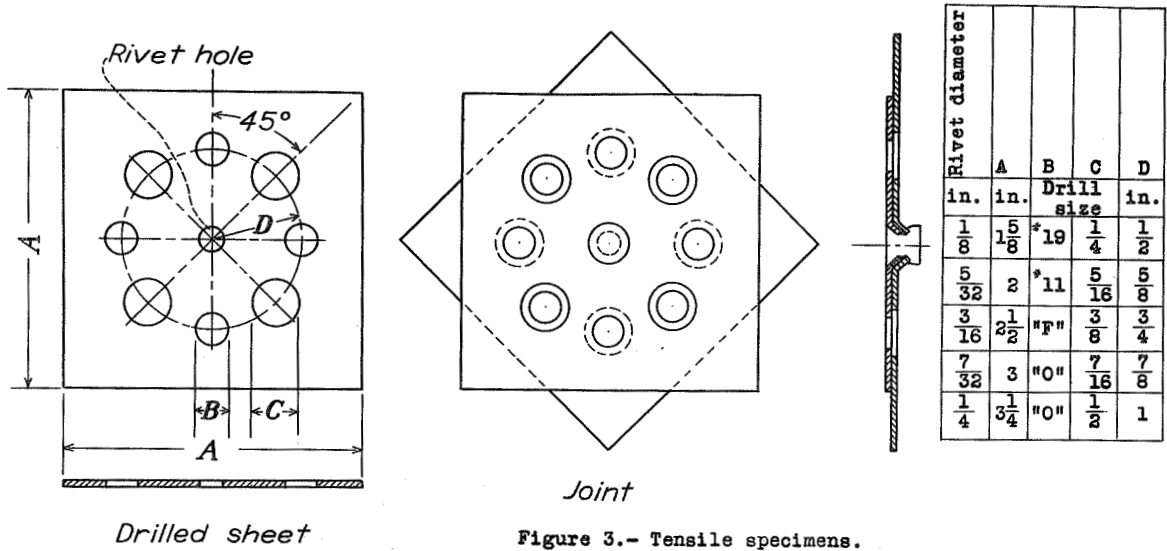

Figure 3.- Tensile specimens.

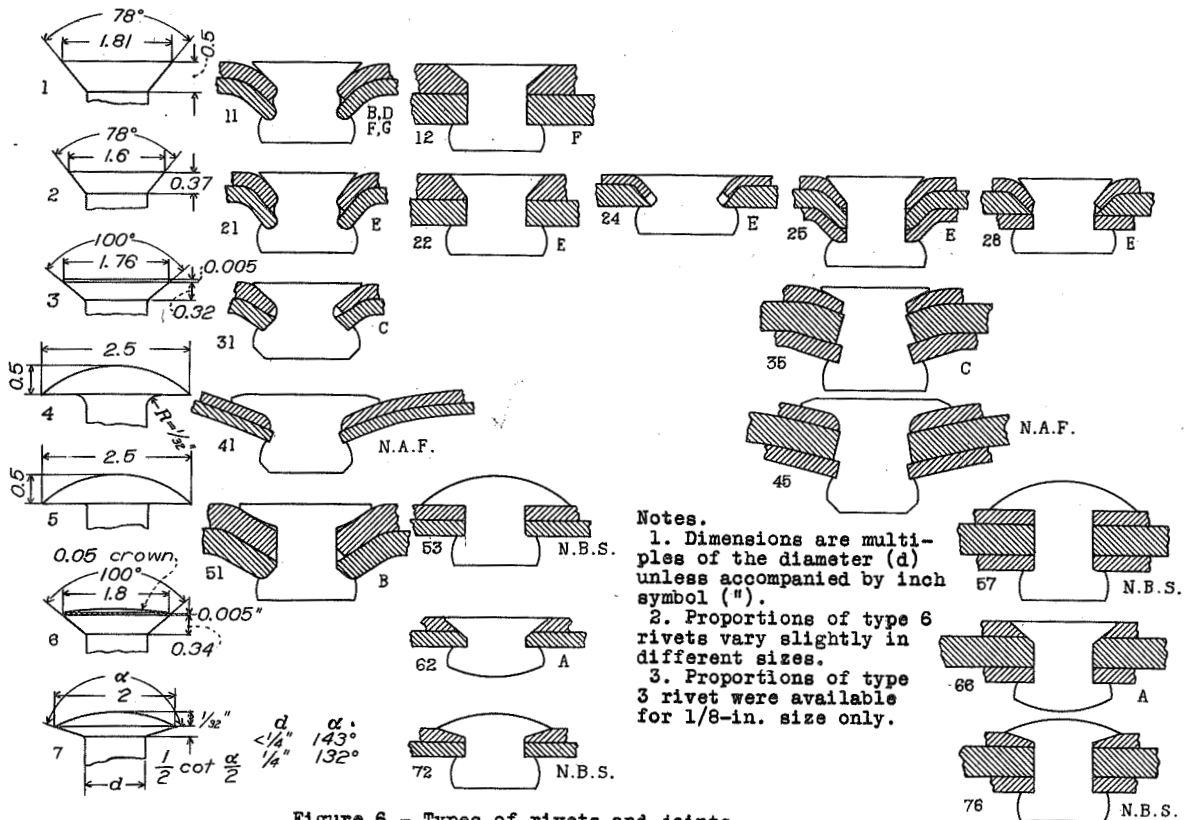

Figure 6.- Types of rivets and joints.

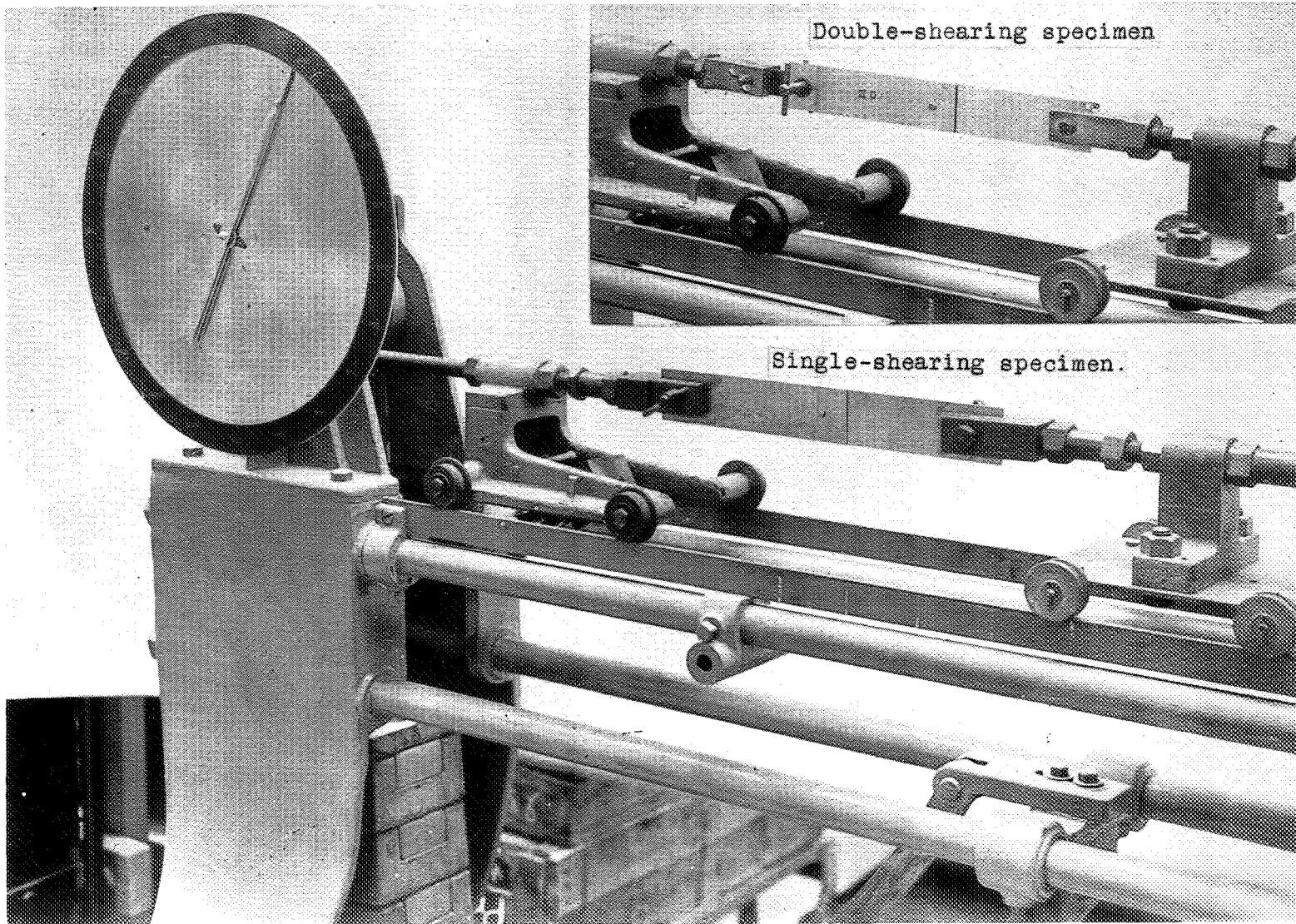

Figure 4.- Machine and fixture for testing shearing specimens.

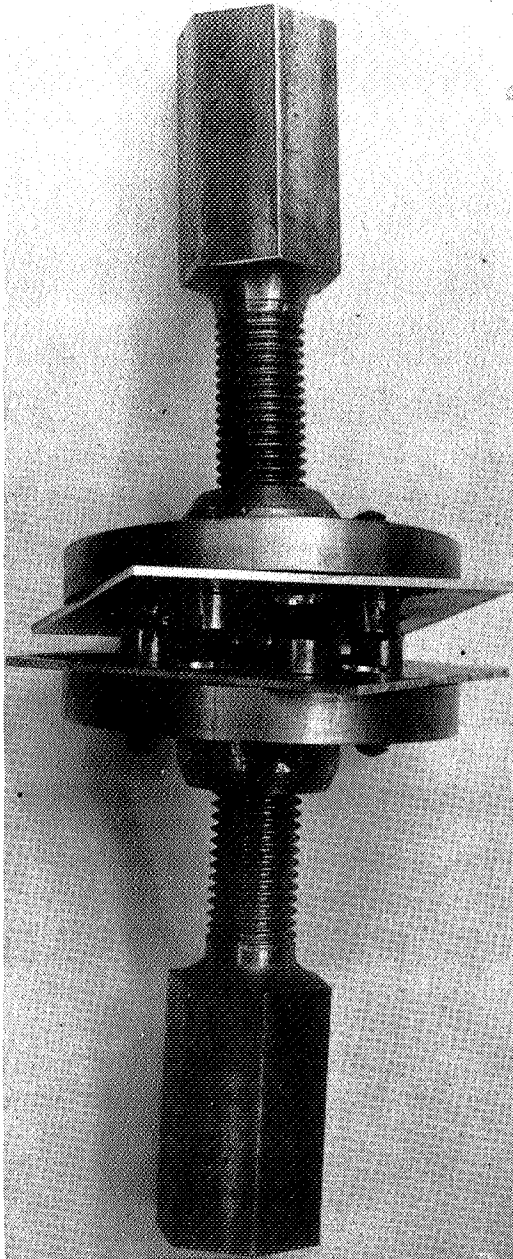

Figure 5.- Tensile specimen after failure showing fixture.

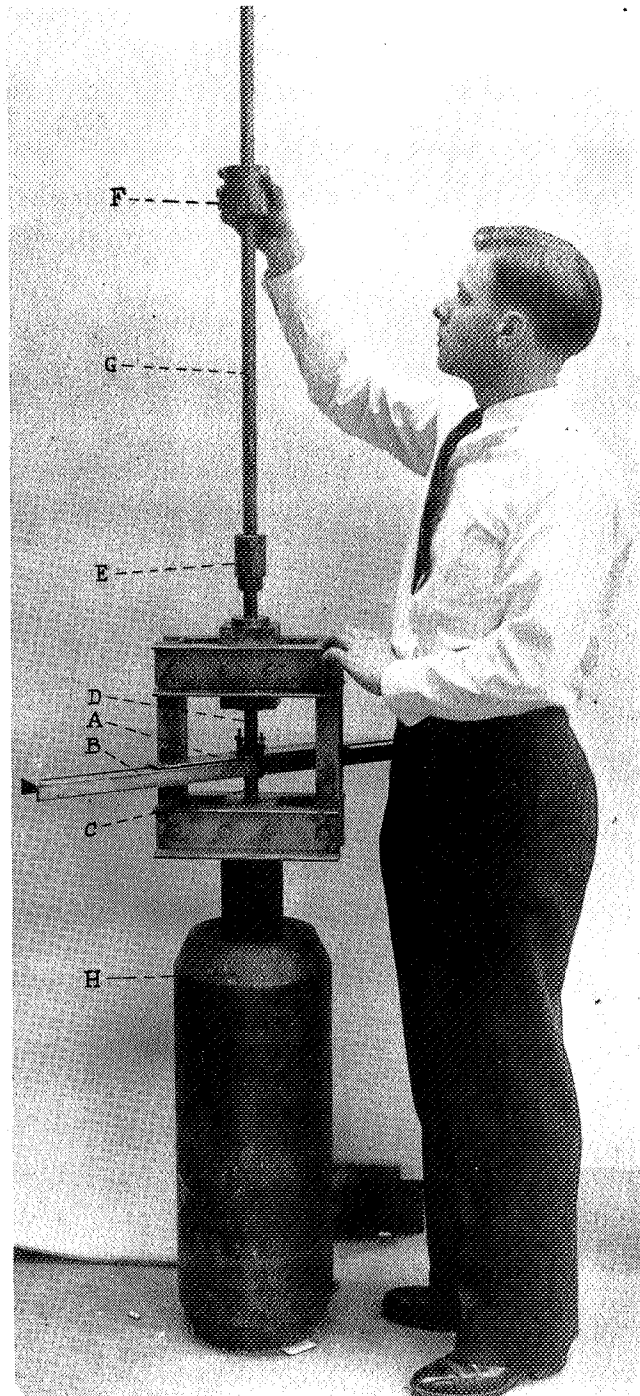

Figure 14.- Drop hammer used to drive NBS rivets. The specimen A is clamped to the aligning frame B which slips over the fixed rivet set C. The movable set D is connected to the anvil E. The hammer F is raised to a predetermined height indicated on the graduated guide tube G and released. The weight of the support H is large compared to the weight of the hammer.



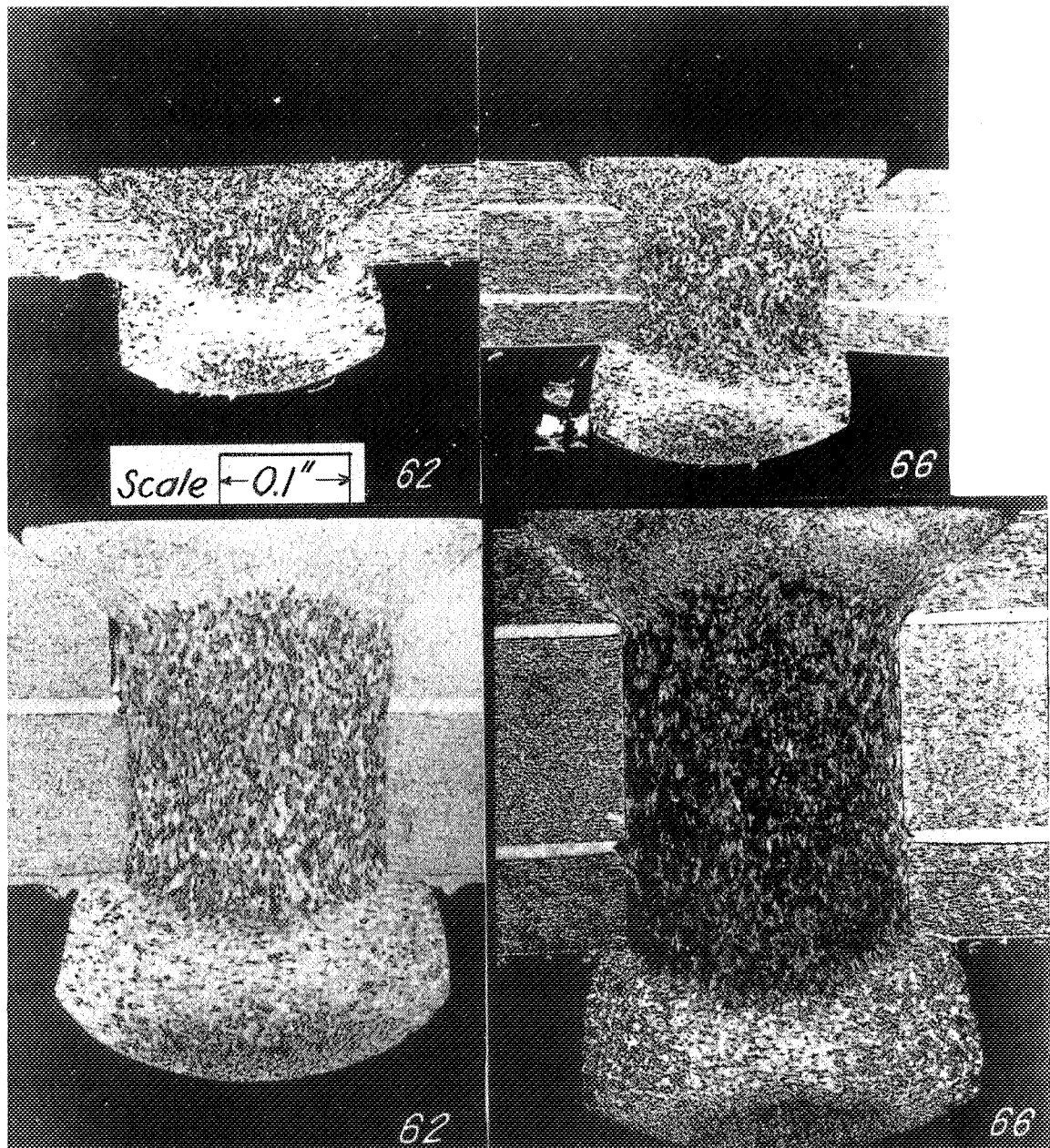

Figure 7.— Cross section of machine-countersunk joints, manufacturer A. The joint numbers (see fig. 6) are shown.

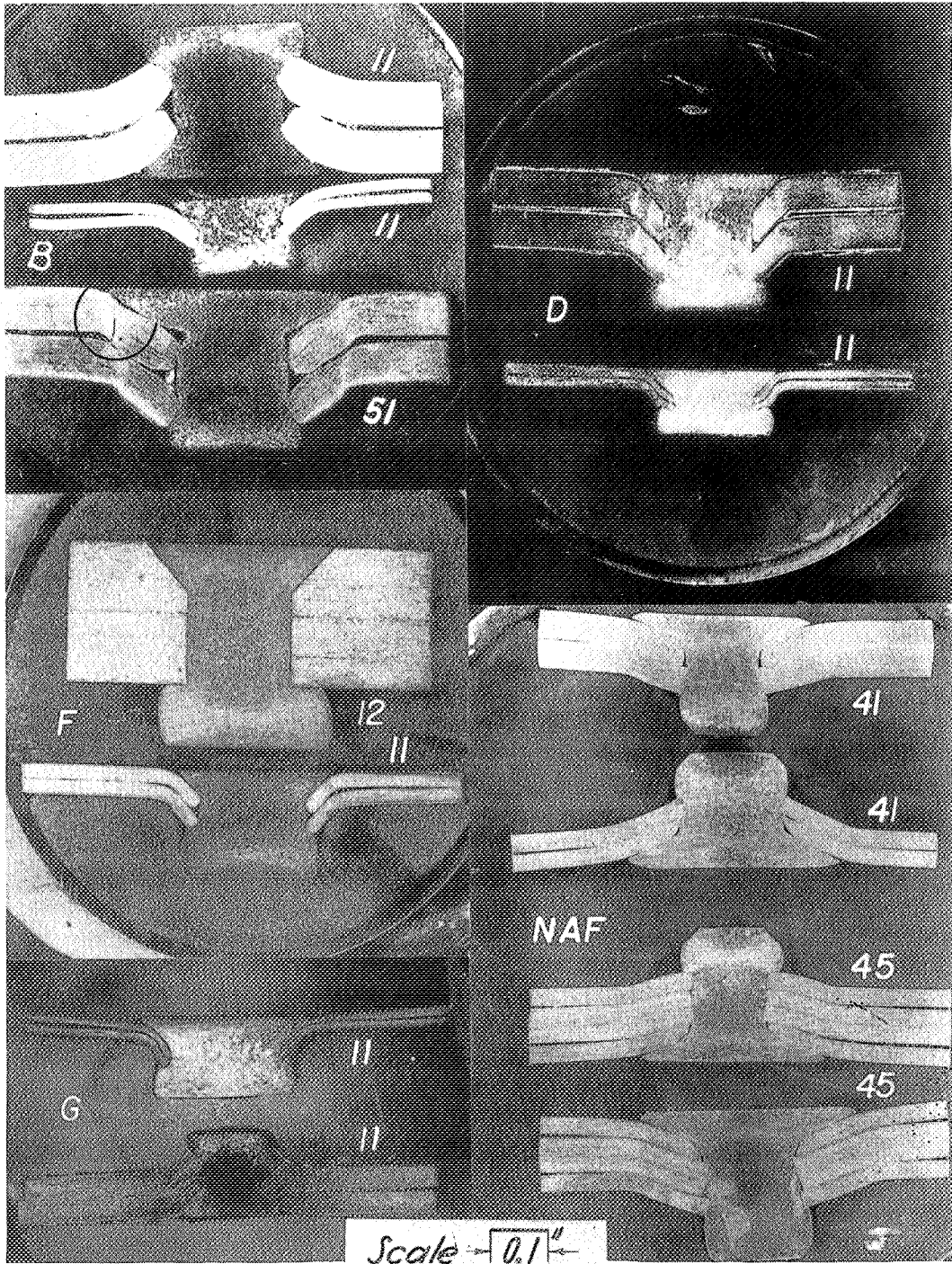

Figure 8.-- Cross section of joints, manufacturers B, D, F, G, and NAF.

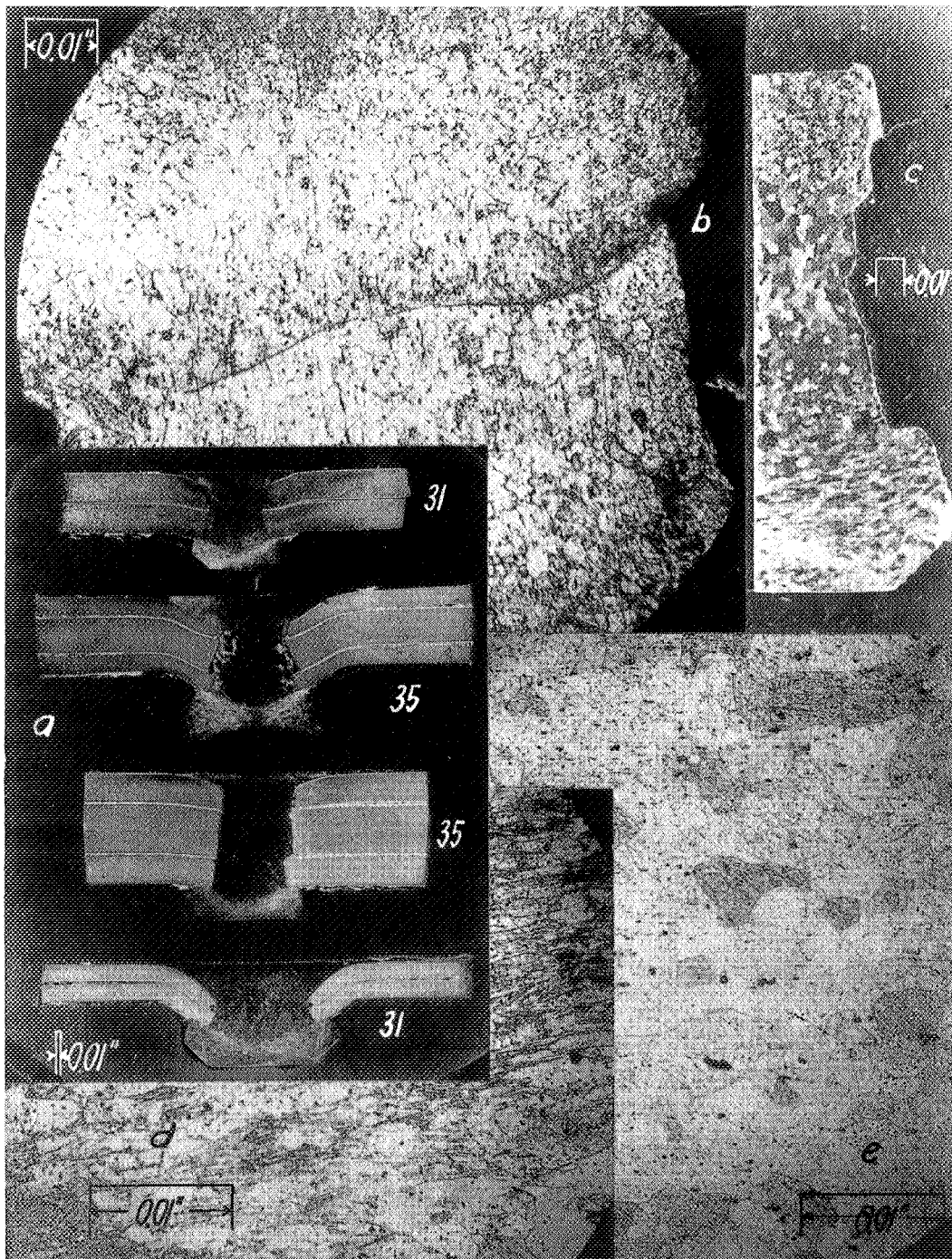

Figure 9.- Joints and rivet, manufacturer C. (a) cross section of joints; (b) photomicrograph of top rivet in (a); (c) photomicrograph of same rivet sectioned at right angles to plane exposed in (a) and (b); (d) microstructure of cold-worked metal in the driven head of the same rivet; (e) microstructure of the same rivet showing undeformed grains.

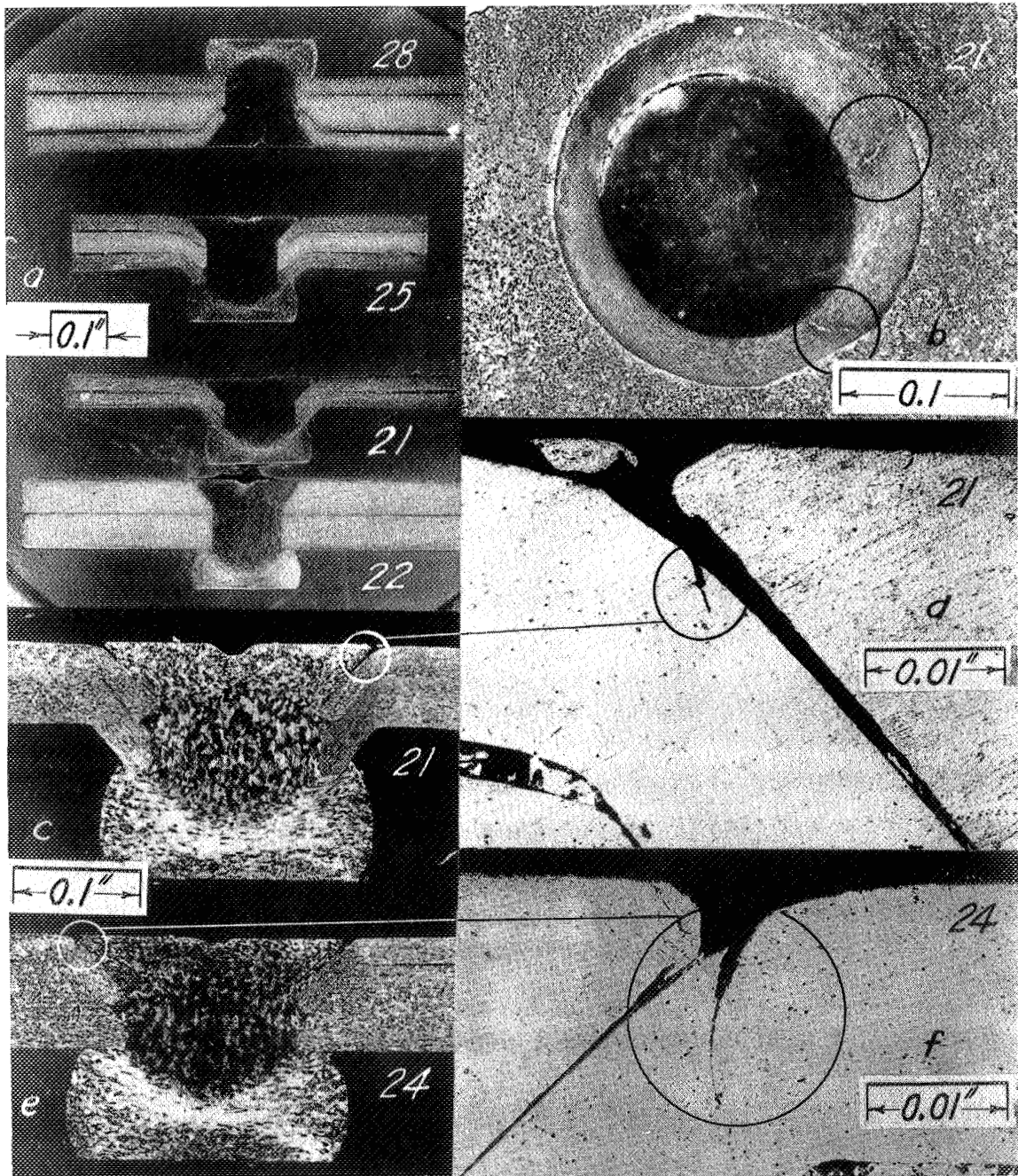
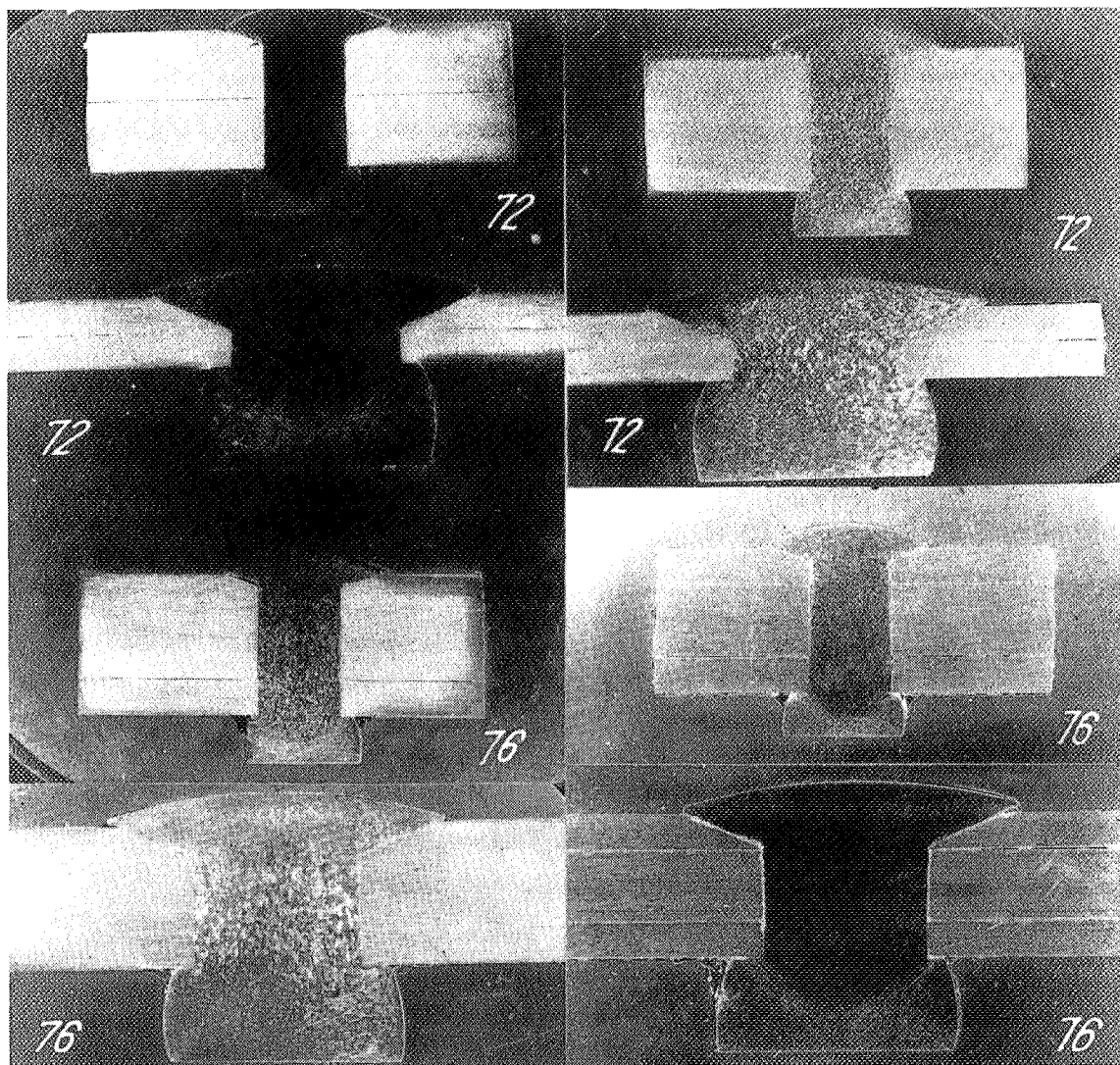

Figure 10.-- (a) Cross section of joints, manufacturer E  
 (b) radial cracks in dimpled sheet at edge  
 of rivet hole; (c) and (e) location of cracks shown enlarged in (d) and (f) respectively.



*Press Driven*

*Hammer Driven*

*Scale* →  $0.1$  <sup>in</sup> ←

Figure 11.- Cross section of NBS special-oval-countersunk-head-riveted joints.

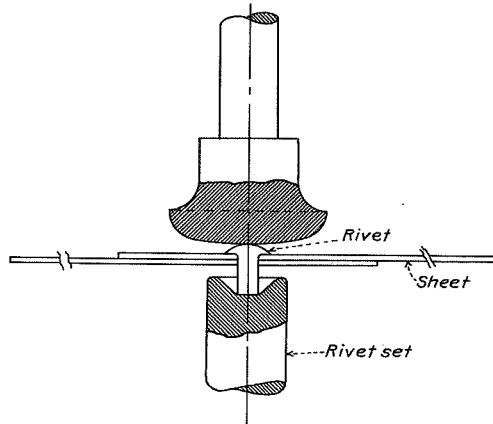

Figure 13.- Tools for driving NAF rivets.

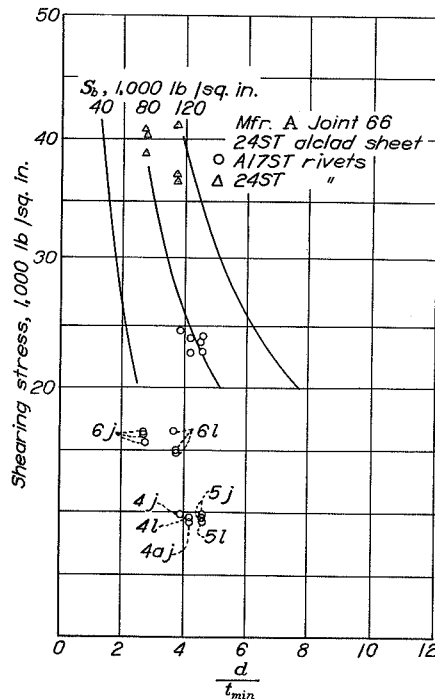

Figure 16.- Test results for double-shearing specimens, manufacturer A. Points in the upper series indicate the stress at failure. Directly below each of these a corresponding point is shown to indicate by number and letter symbols the rivet diameter in units of 1/32 in. and the type of failure (table 7) respectively.

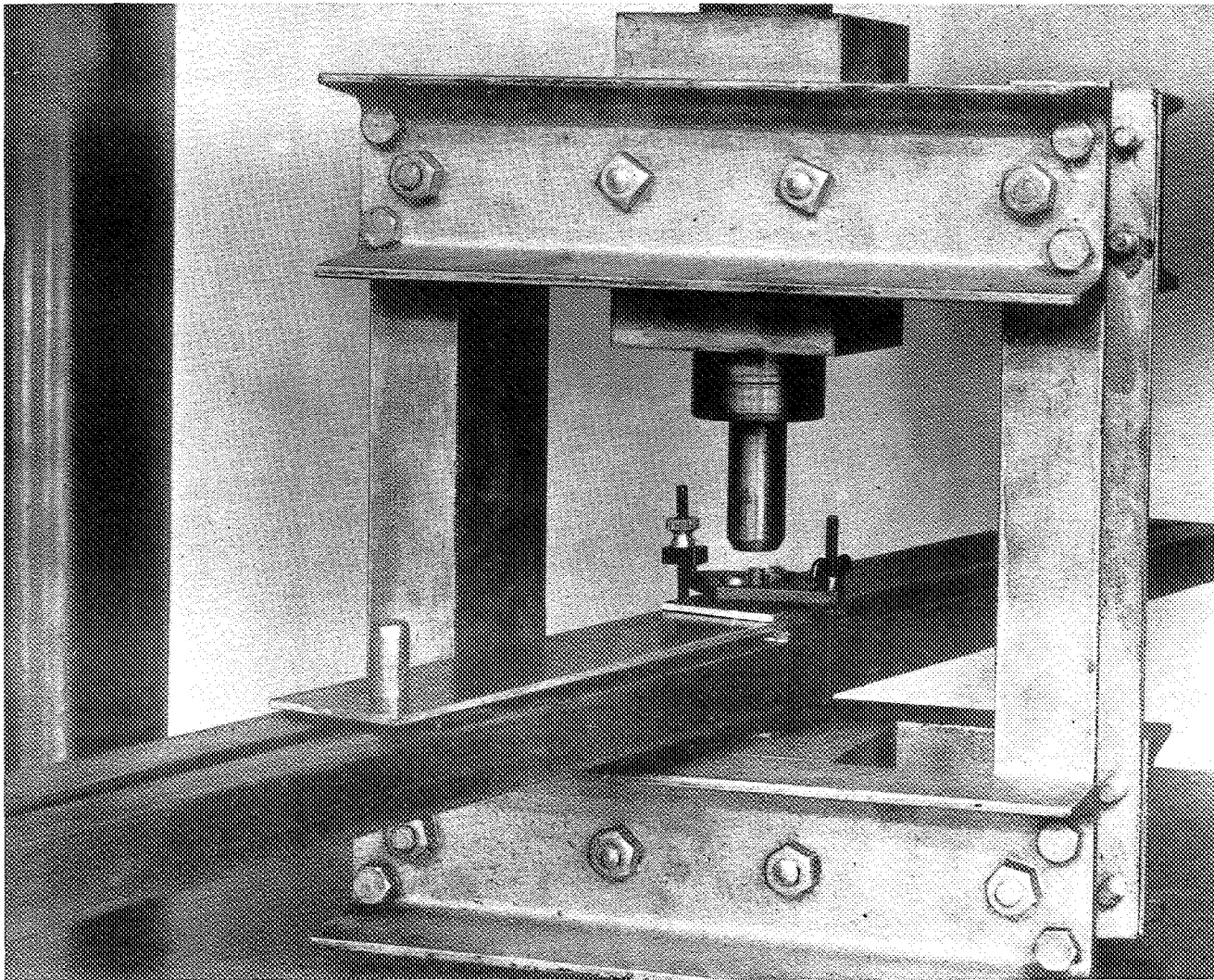

Figure 13.- Fixture used to drive NBS rivets by compressive loading in a testing machine.

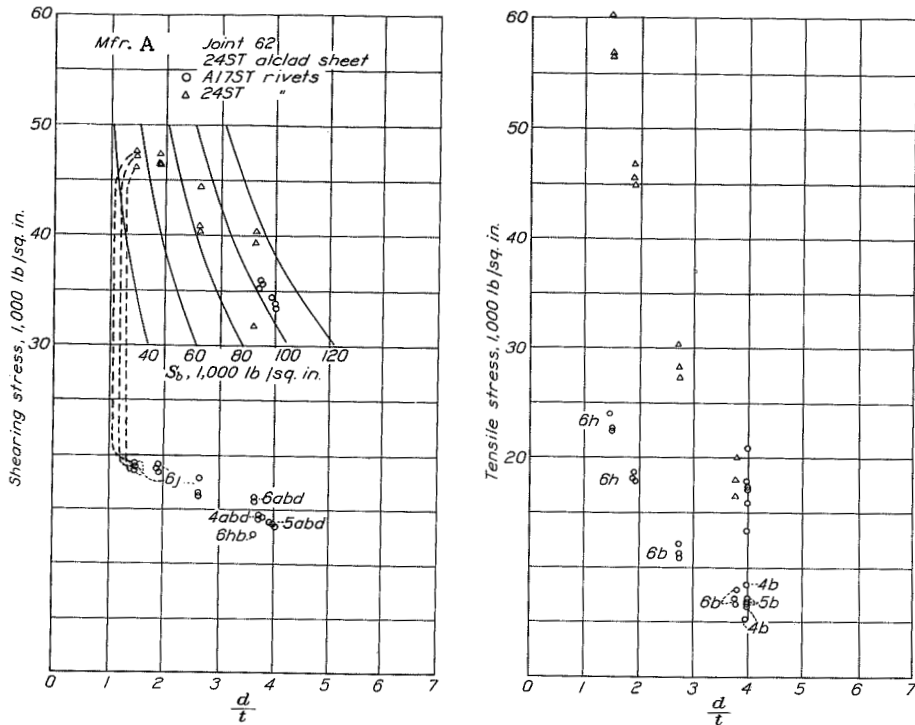

Figure 15.- Test results for single-shearing and tensile specimens, manufacturer A. Points in the upper series indicate the stress at failure. Directly below each of these a corresponding point is shown to indicate by number and letter symbols the rivet diameter in units of 1/32 in. and the type of failure (table 7) respectively.

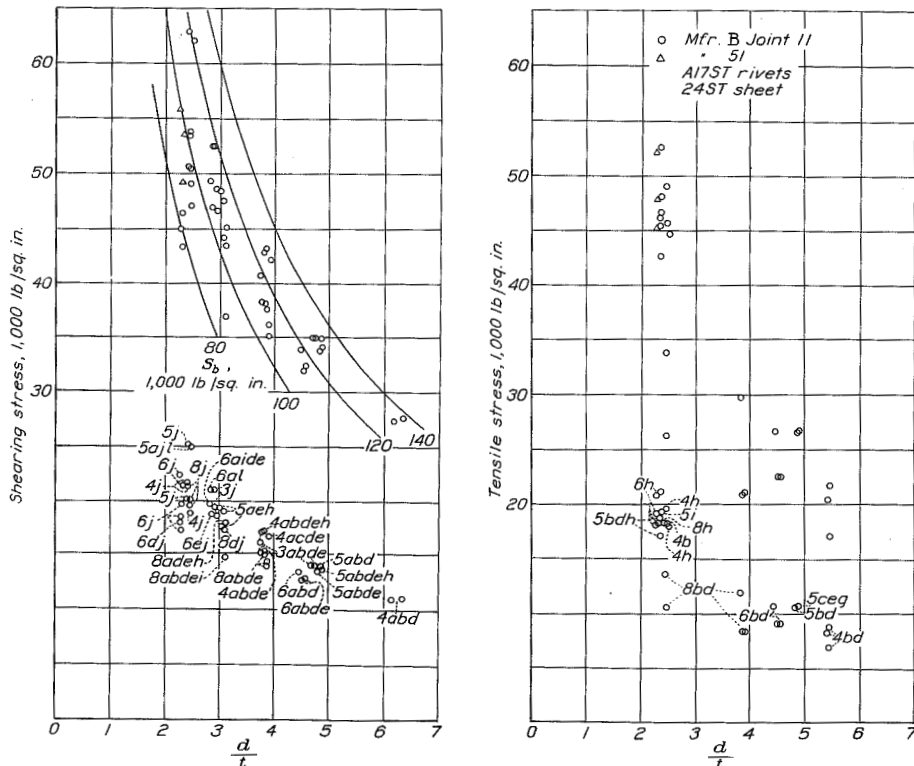

Figure 17.- Test results for single-shearing and tensile specimens, manufacturer B. Points in the upper series indicate the stress at failure. Directly below each of these a corresponding point is shown to indicate by number and letter symbols the rivet diameter in units of 1/32 in. and the type of failure (table 7) respectively.



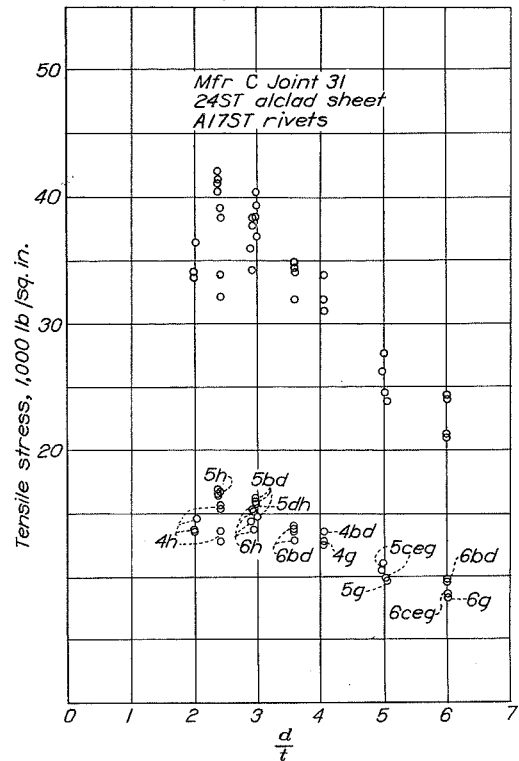
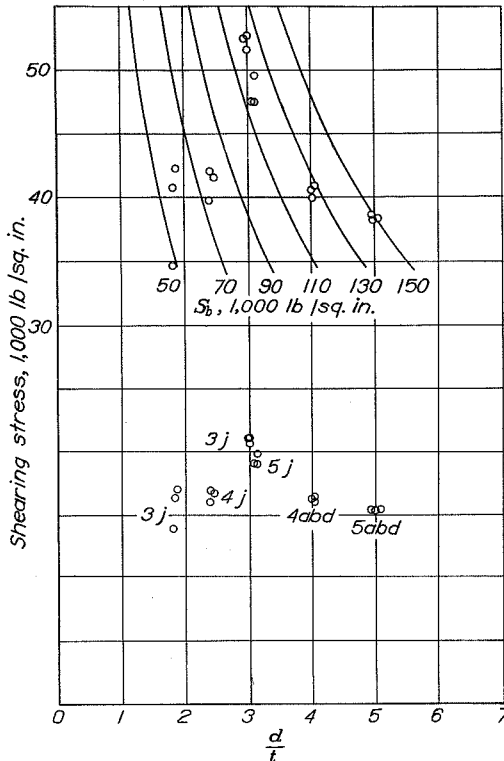

Figure 18.- Test results for single-shearing and tensile specimens, manufacturer C. Points in the upper series indicate the stress at failure. Directly below each of these a corresponding point is shown to indicate by number and letter symbols the rivet diameter in units of 1/32 in. and the type of failure (table 7) respectively.

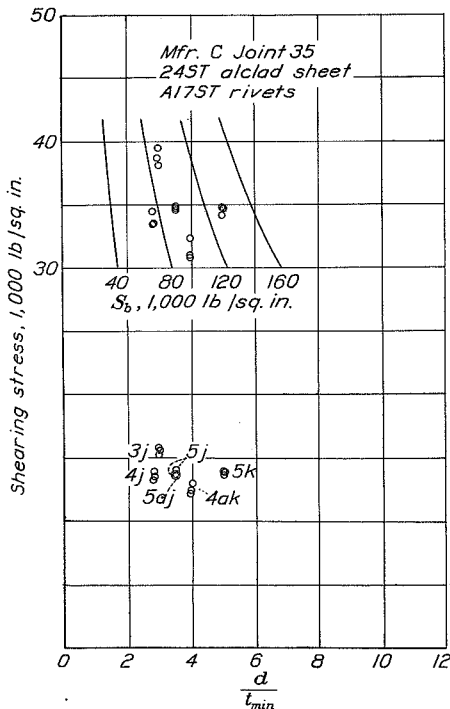

Figure 19.- Test results for double-shearing specimens, manufacturer C. Points in the upper series indicate the stress at failure. Directly below each of these a corresponding point is shown to indicate by number and letter symbols the rivet diameter in units of 1/32 in. and the type of failure (table 7) respectively.

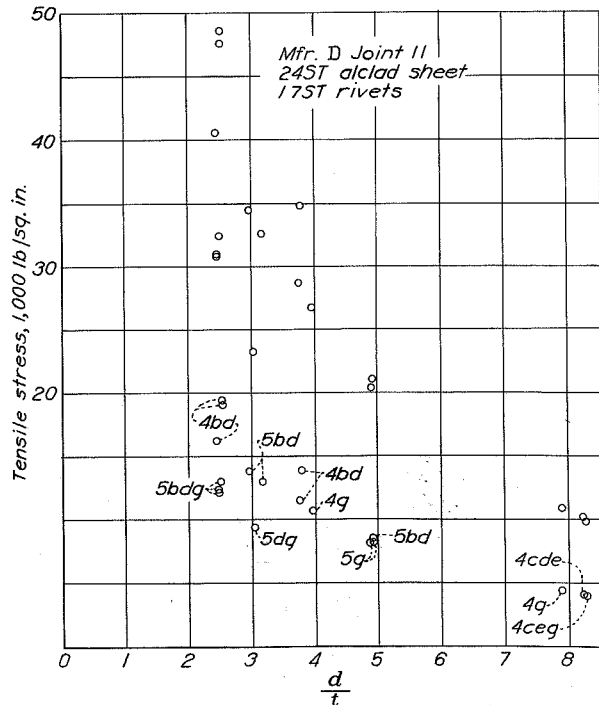

Figure 21.- Test results for tensile specimens, manufacturer D. Points in the upper series indicate the stress at failure. Directly below each of these a corresponding point is shown to indicate by number and letter symbols the rivet diameter in units of 1/32 in. and the type of failure (table 7) respectively.

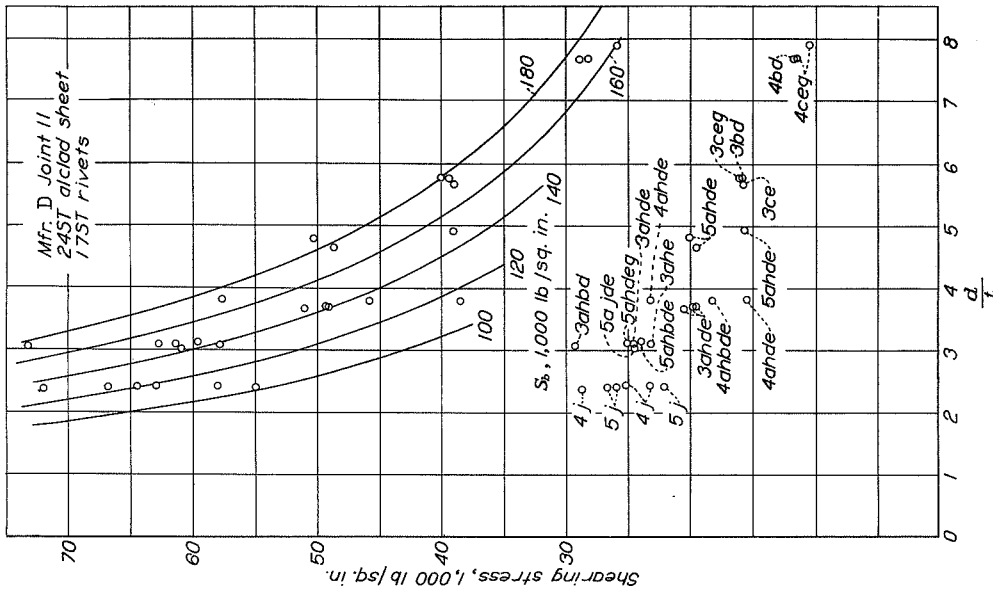

Figure 20.- Test results for single-shearing specimens, manufacturer D. Points in the upper series indicate the stress at failure. Directly below each of these a corresponding point is shown to indicate by number and letter symbols the rivet diameter in units of 1/32 in. and the type of failure (table 7) respectively.

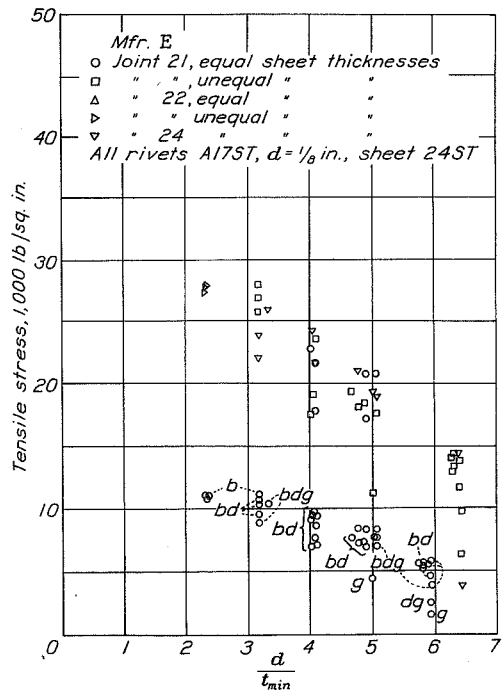
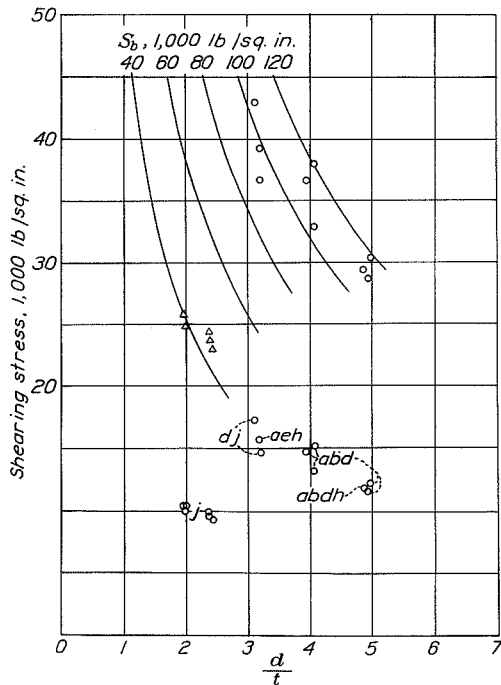

Figure 22.- Test results for single-shearing and tensile specimens, manufacturer E. Points in the upper series indicate the stress at failure. Directly below each of these a corresponding point is shown to indicate by number and letter symbols the rivet diameter in units of 1/32 in. and the type of failure (table 7) respectively.

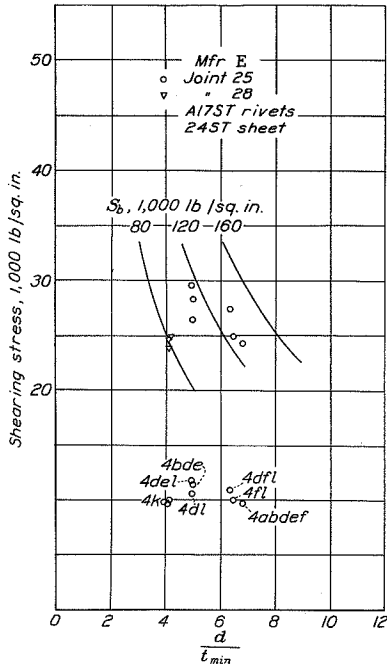

Figure 23.- Test results for double-shearing specimens manufacturer E. Points in the upper series indicate the stress at failure. Directly below each of these a corresponding point is shown to indicate by number and letter symbols the rivet diameter in units of 1/32 in. and the type of failure (table 7) respectively.

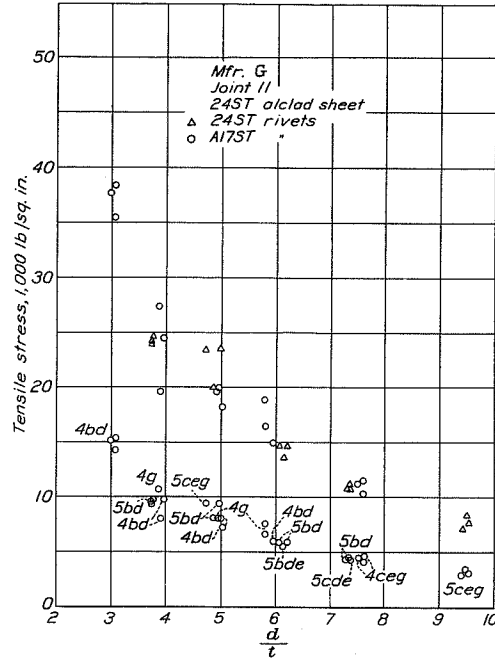

Figure 26.- Test results for tensile specimens, manufacturer G. Points in the upper series indicate the stress at failure. Directly below each of these a corresponding point is shown to indicate by number and letter symbols the rivet diameter in units of 1/32 in. and the type of failure (table 7) respectively.

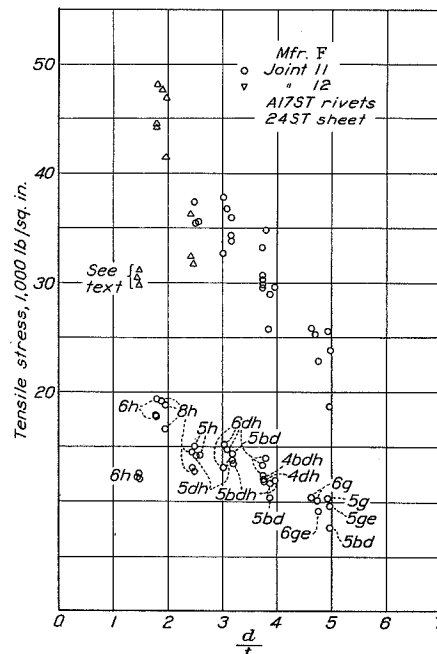
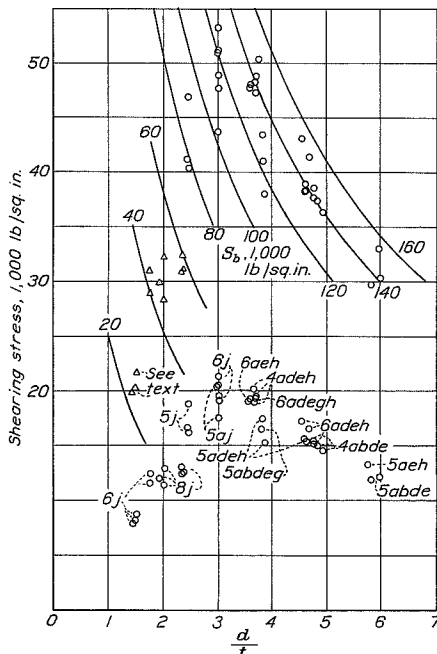

Figure 24.- Test results for single-shearing and tensile specimens, manufacturer F. Points in the upper series indicate the stress at failure. Directly below each of these a corresponding point is shown to indicate by number and letter symbols the rivet diameter in units of 1/32 in. and the type of failure (table 7) respectively.

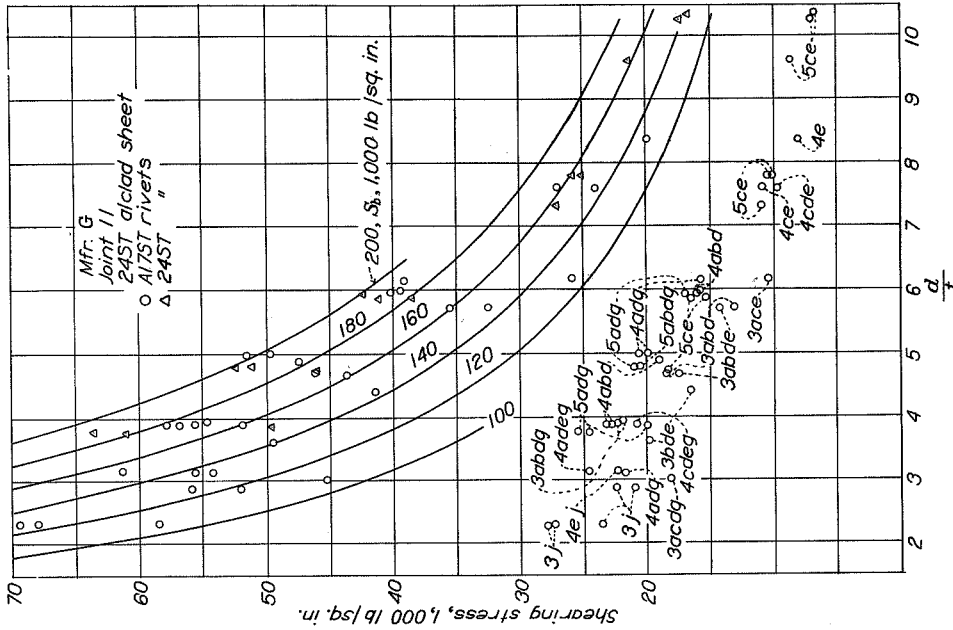

Figure 25.- Test results for single-shearing specimens, manufacturer G. Points in the upper series indicate the stress at failure. Directly below each of these a corresponding point is shown to indicate by number and letter symbols the rivet diameter in units of 1/32 in. and the type of failure (table 7) respectively.

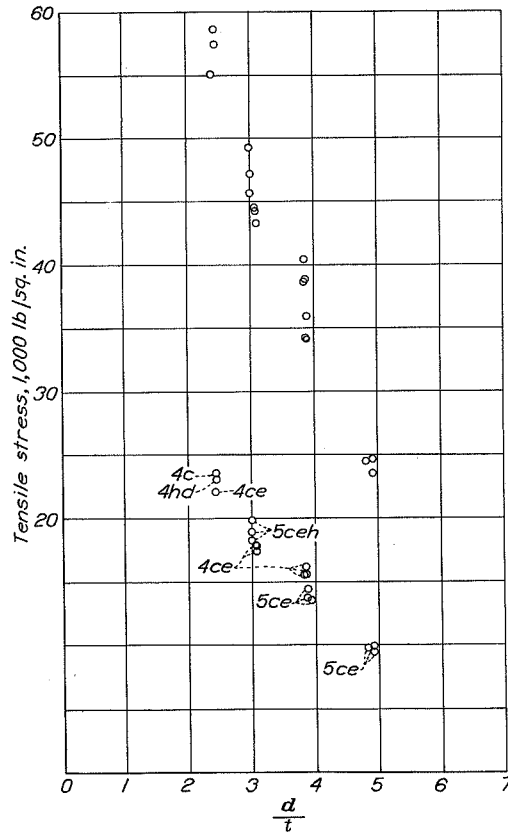
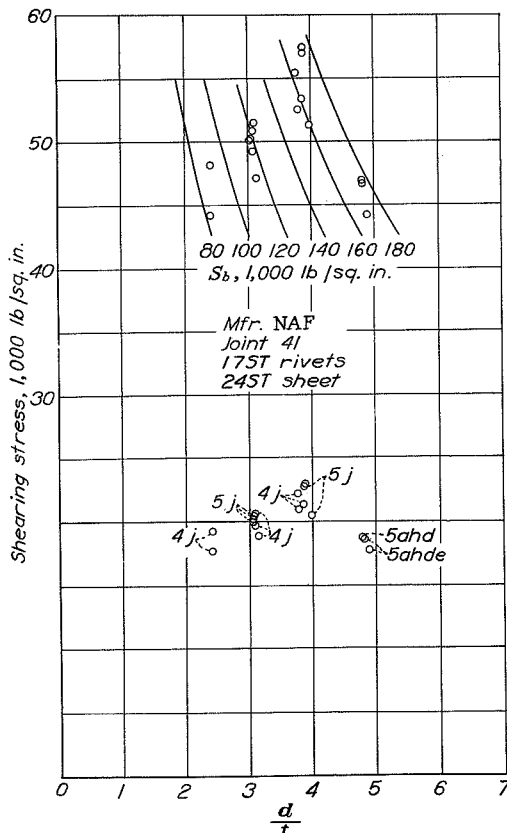

Figure 27.- Test results for single-shearing and tensile specimens, manufacturer NAF. Points in the upper series indicate the stress at failure. Directly below each of these a corresponding point is shown to indicate by number and letter symbols the rivet diameter in units of 1/32 in. and the type of failure (table 7) respectively.

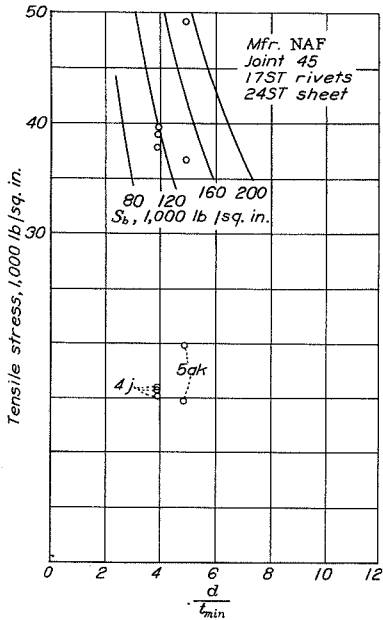

Figure 28.- Test results for double-shearing specimens, manufacturer NAF. Points in the upper series indicate the stress at failure. Directly below each of these a corresponding point is shown to indicate by number and letter symbols the rivet diameter in units of 1/32 in. and the type of failure (table 7) respectively.

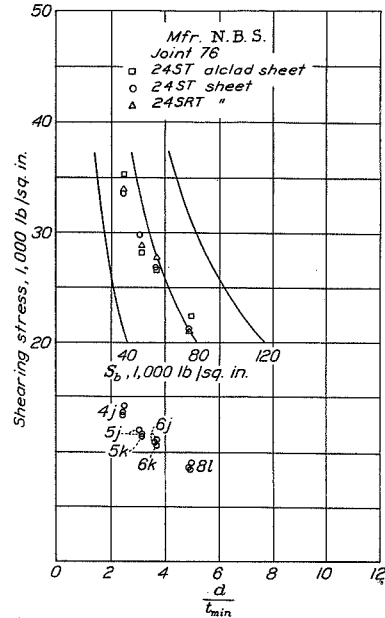

Figure 30.- Test results for NBS 17ST press-driven special-oval-countersunk-head-riveted double-shearing specimens. Points in the upper series indicate the stress at failure. Directly below each of these a corresponding point is shown to indicate by number and letter symbols the rivet diameter in units of 1/32 in. and the type of failure (table 7) respectively.

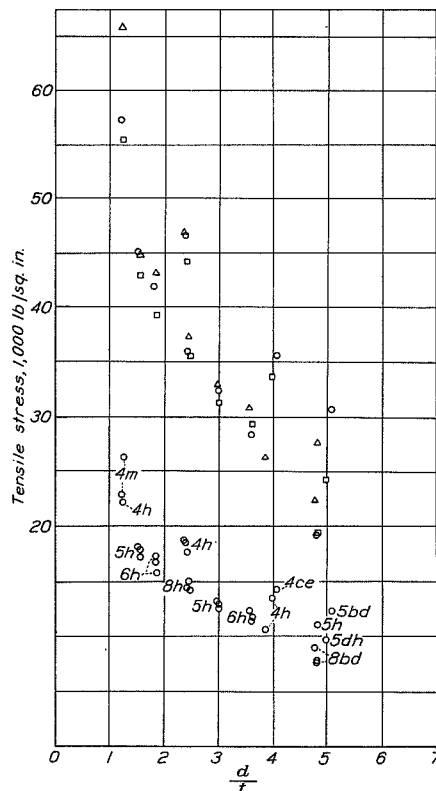
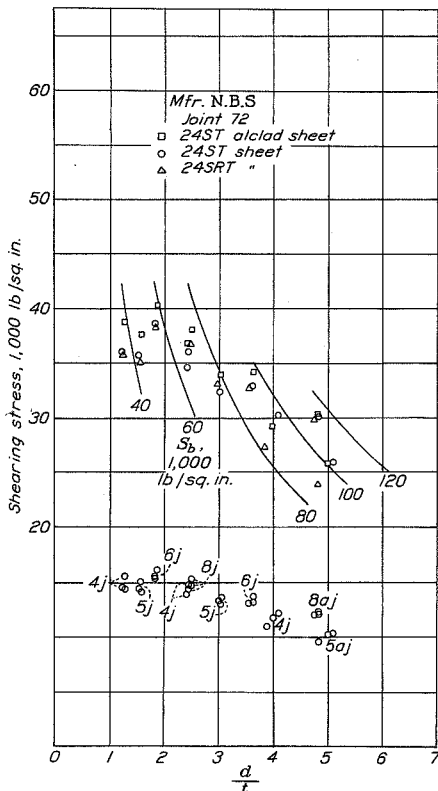

Figure 33.- Test results for NBS 17ST press-driven special-oval-countersunk-head-riveted single-shearing and tensile specimens. Points in the upper series indicate the stress at failure. Directly below each of these a corresponding point is shown to indicate by number and letter symbols the rivet diameter in units of 1/32 in. and the type of failure (table 7) respectively.

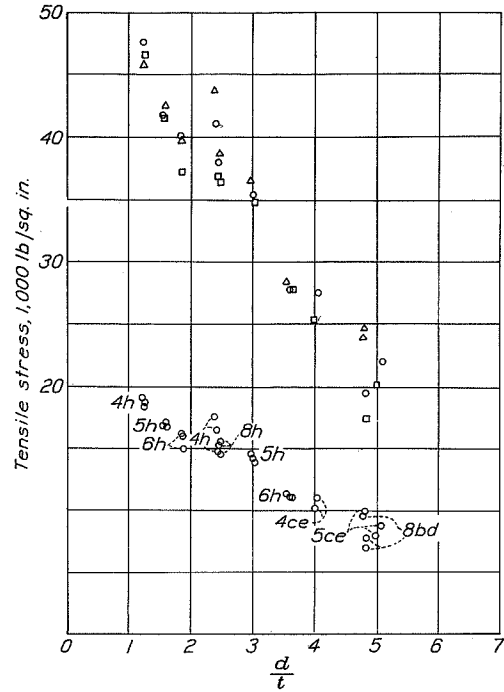
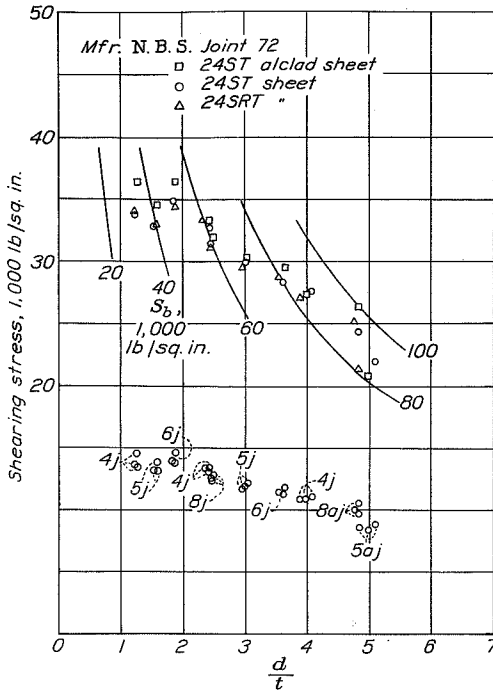

Figure 29.- Test results for NBS Al7ST press-driven special-oval-countersunk-head-riveted single-shearing and tensile specimens. Points in the upper series indicate the stress at failure. Directly below each of these a corresponding point is shown to indicate by number and letter symbols the rivet diameter in units of 1/32 in. and the type of failure (table 7) respectively.

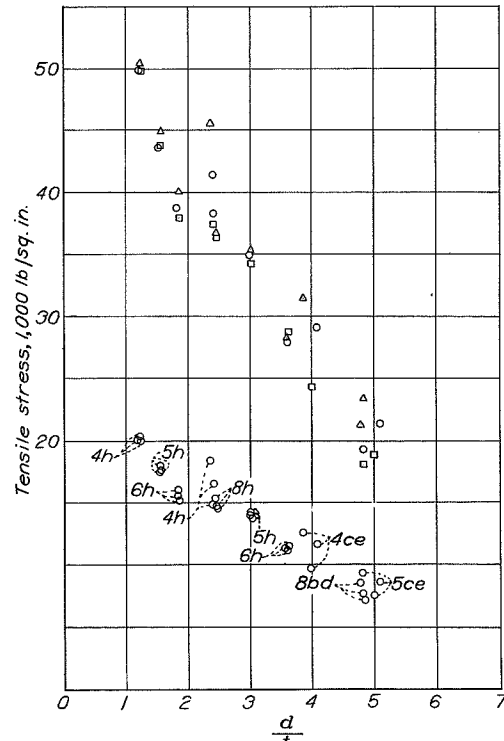
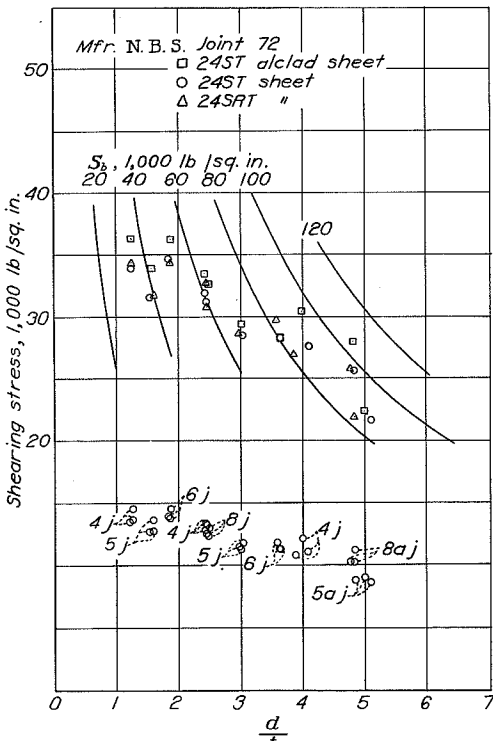

Figure 31.- Test results for NBS Al7ST hammer-driven special-oval-countersunk-head-riveted single-shearing and tensile specimens. Points in the upper series indicate the stress at failure. Directly below each of these a corresponding point is shown to indicate by number and letter symbols the rivet diameter in units of 1/32 in. and the type of failure (table 7) respectively.

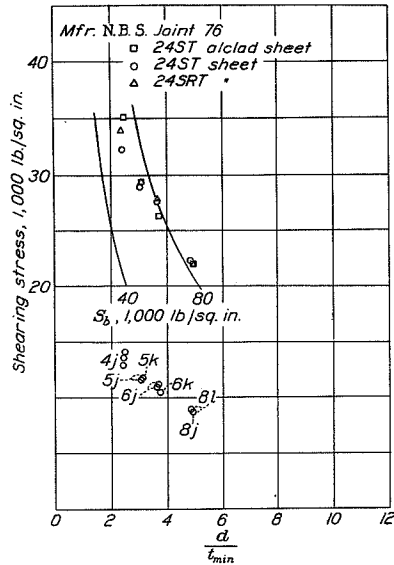

Figure 32.- Test results for NBS Al7ST hammer-driven special-oval-countersunk-head-riveted double-shearing specimens. Points in the upper series indicate the stress at failure. Directly below each of these a corresponding point is shown to indicate by number and letter symbols the rivet diameter in units of 1/32 in. and the type of failure (table 7) respectively.

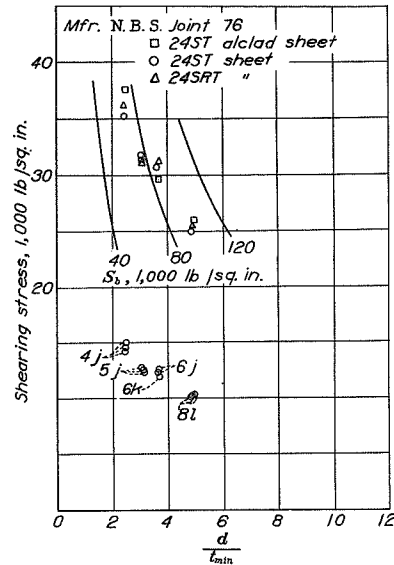

Figure 34.- Test results for NBS 17ST press-driven special-oval-countersunk-head-riveted double-shearing specimens. Points in the upper series indicate the stress at failure. Directly below each of these a corresponding point is shown to indicate by number and letter symbols the rivet diameter in units of 1/32 in. and the type of failure (table 7) respectively.

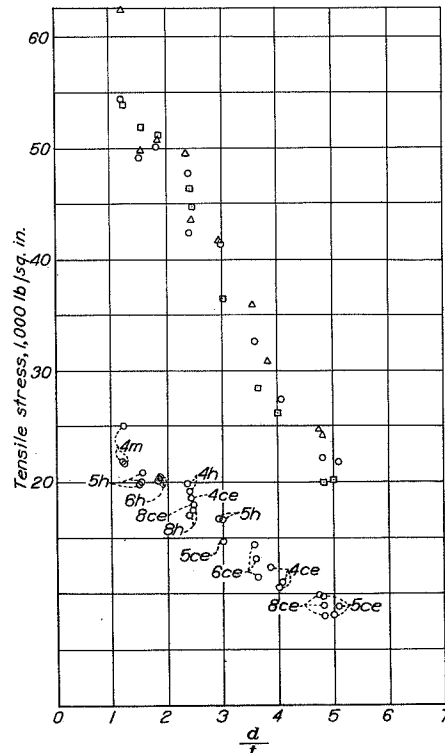
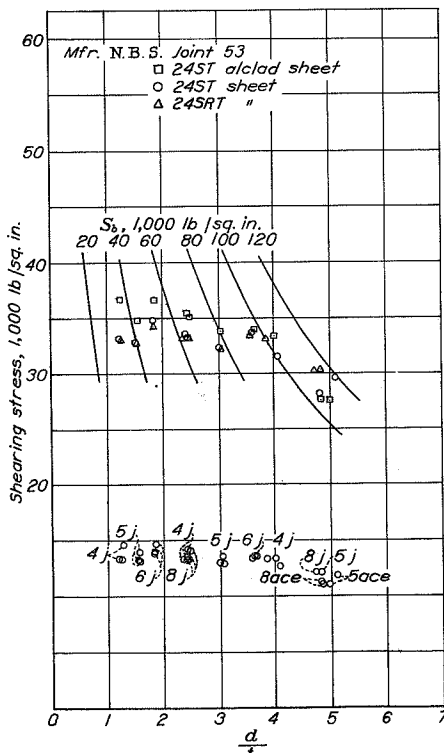

Figure 35.- Test results for NBS Al7ST press-driven brazier-head-riveted single-shearing and tensile specimens. Points in the upper series indicate the stress at failure. Directly below each of these a corresponding point is shown to indicate by number and letter symbols the rivet diameter in units of 1/32 in. and the type of failure (table 7) respectively.

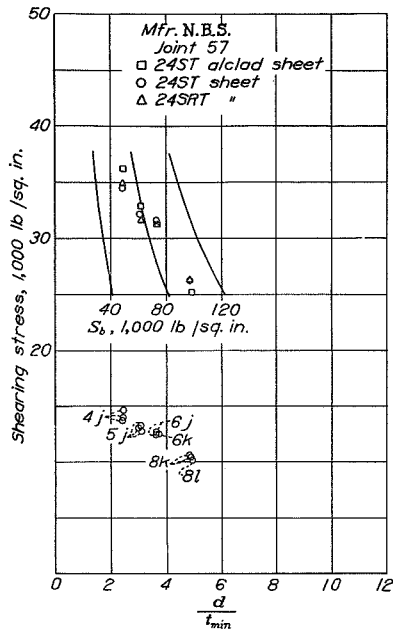

Figure 36.- Test results for NBS A178T press-driven brazier-head-riveted double-shearing specimens. Points in the upper series indicate the stress at failure. Directly below each of these a corresponding point is shown to indicate by number and letter symbols the rivet diameter in units of 1/32 in. and the type of failure (table 7) respectively.

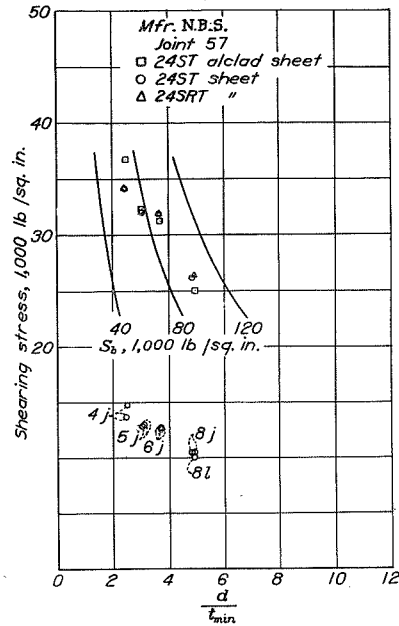

Figure 38.- Test results for NBS A178T hammer-driven brazier-head-riveted double-shearing specimens. Points in the upper series indicate the stress at failure. Directly below each of these a corresponding point is shown to indicate by number and letter symbols the rivet diameter in units of 1/32 in. and the type of failure (table 7) respectively.

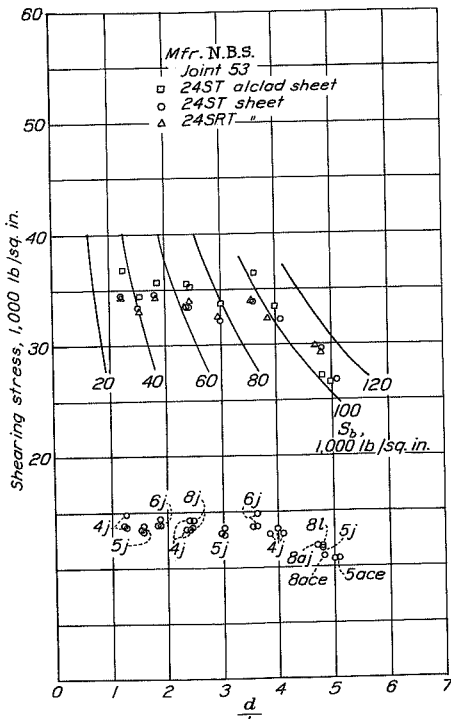
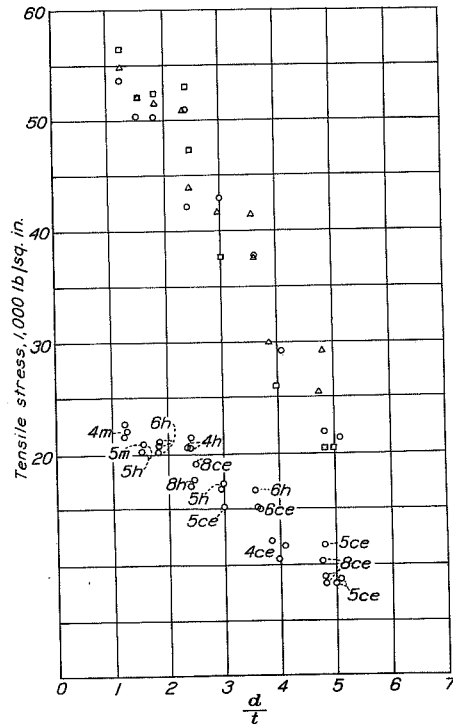
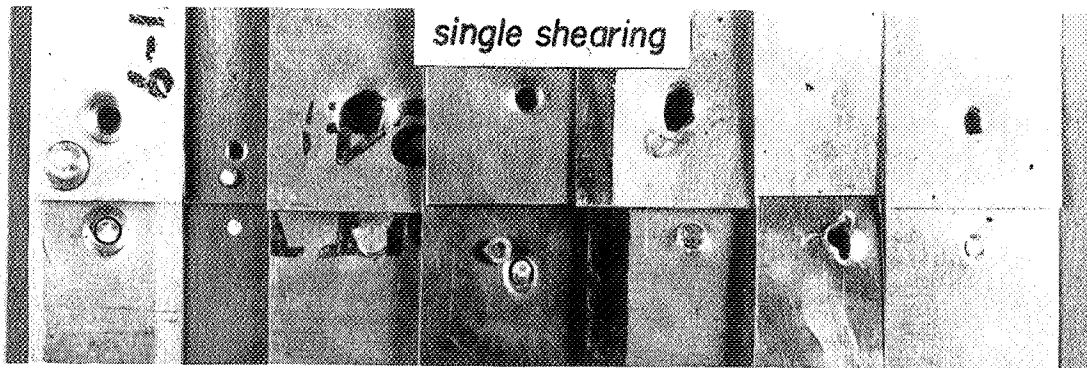

Figure 37.- Test results for NBS A178T hammer-driven brazier-head-riveted single-shearing and tensile specimens. Points in the upper series indicate the stress at failure. Directly below each of these a corresponding point is shown to indicate by number and letter symbols the rivet diameter in units of 1/32 in. and the type of failure (table 7) respectively.







B 51    E 22    G 11    F 11    A 62    D 11    G 11  
 6j      4j      5adg    5adeh    5abd    3ce    3abde

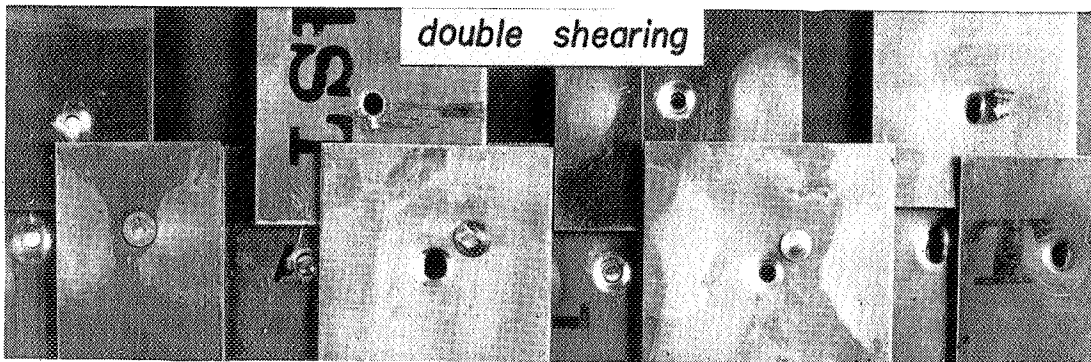

C 35            A 66            C 35            E 25  
 5j              6l              5k              4abdef

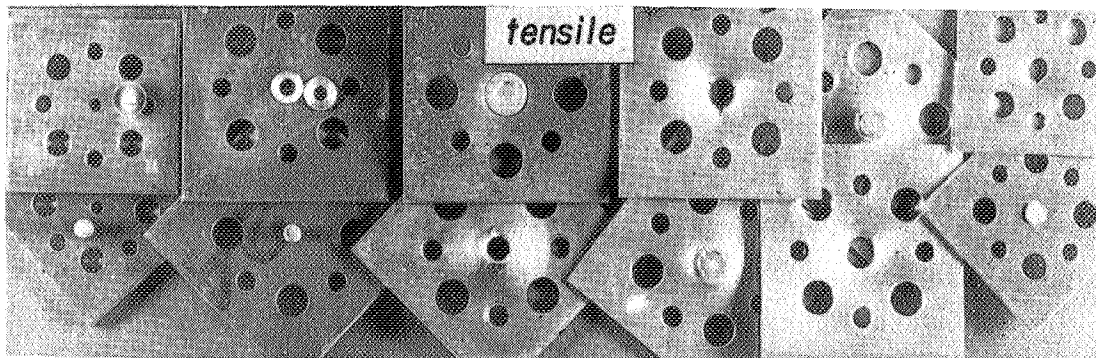

NBS 53    NBS 72    NAF 41    B 11    D 11    E 21  
 4m        5h        5ceh    5bd    5g        4dg

Figure 39.- Typical failures of test specimens. The symbols designate the manufacturer, the joint number (figure 6), the rivet diameter in thirty-seconds of an inch and the type of failure (table 7).

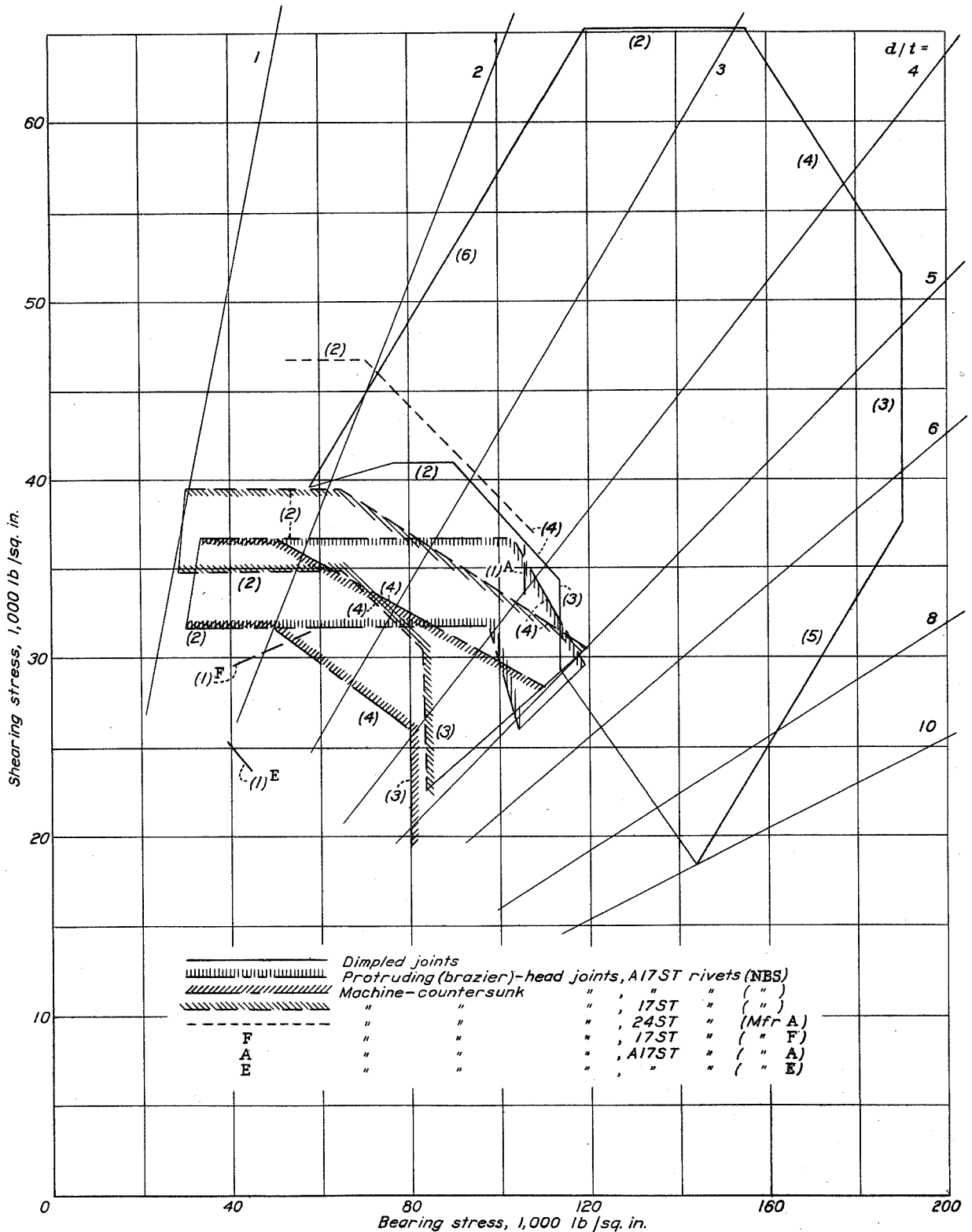

Note: Numbers in parentheses refer to text, Sect. IV, 2

Figure 40.- Summary of test results for all single-shearing specimens.

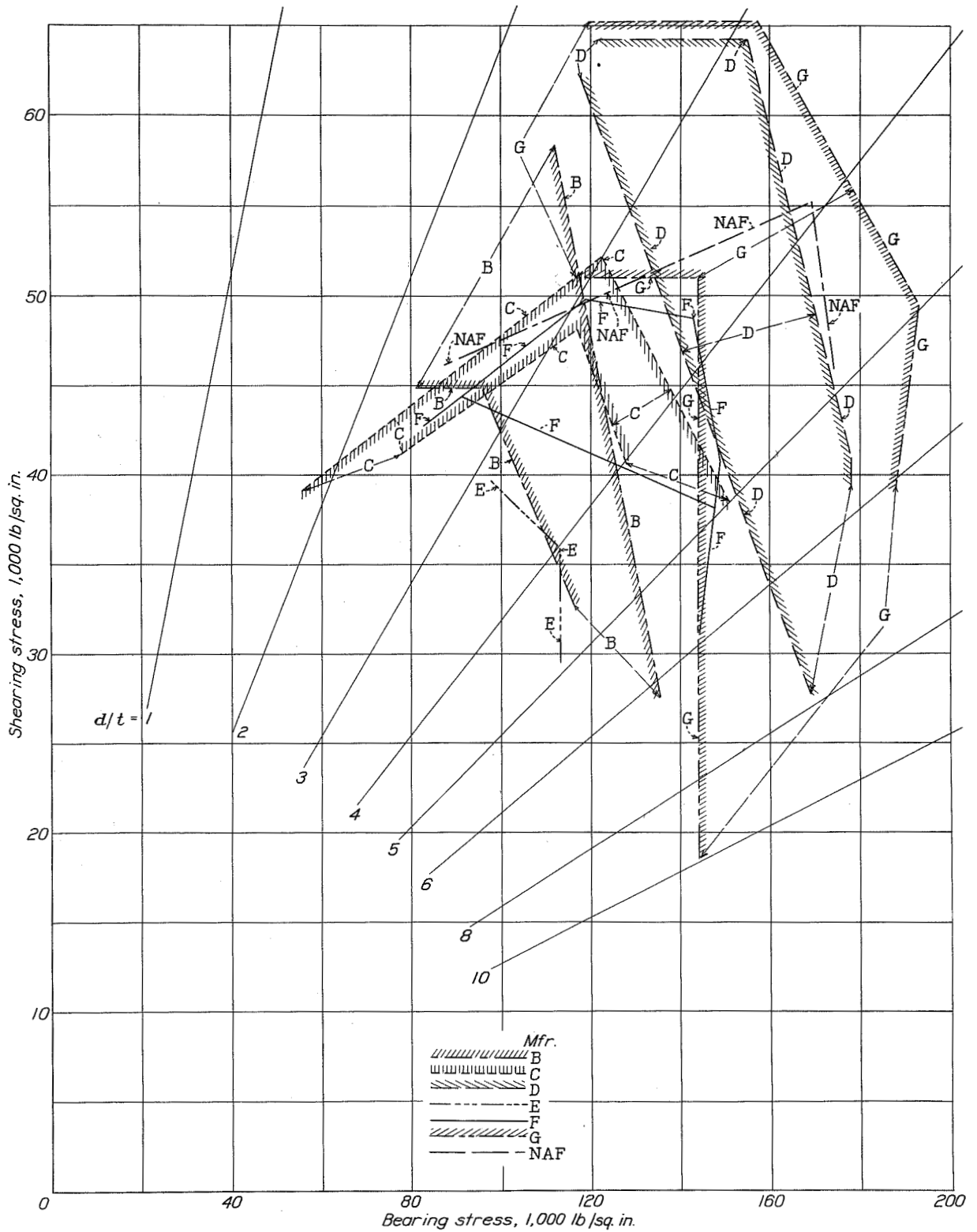

Figure 41.- Summary of test results for all dimpled single-shearing specimens.