

SSC08-X-1

## NanoSail-D: The First Flight Demonstration of Solar Sails for Nanosatellites

Mark Whorton, Andy Heaton, Robin Pinson  
NASA Marshall Space Flight Center  
Marshall Space Flight Center, AL 35812; 256-544-1435  
Mark.S.Whorton@nasa.gov, Andrew.F.Heaton@nasa.gov, Robin.M.Pinson@nasa.gov

Greg Laue  
ManTech SRS Technologies  
500 Discovery Dr, Huntsville, AL 35806; 256-971-7846  
GLaue@stg.srs.com

Charles Adams  
Gray Research, Inc.  
655 Discovery Dr., Suite 300, Huntsville, AL 35806; 256-961-7572  
Charles.L.Adams@nasa.gov

### ABSTRACT

The “NanoSail-D” mission is currently scheduled for launch onboard a Falcon Launch Vehicle in the late June 2008 timeframe. The NanoSail-D, a CubeSat-class satellite, will consist of a sail subsystem stowed in a Cubesat 2U volume integrated with a CubeSat 1U volume bus provided by the NASA Ames Research Center (ARC). Shortly after deployment of the NanoSail-D from a Poly Picosatellite Orbital Deployer (P-POD) ejection system, the solar sail will deploy and mission operations will commence. This demonstration flight has two primary mission objectives: 1) to successfully stow and deploy the sail and 2) to demonstrate de-orbit functionality. Given a near-term opportunity for launch, the project was met with the challenge of delivering the flight hardware in approximately six months, which required a significant constraint on flight system functionality. As a consequence, passive attitude stabilization will be achieved using permanent magnets to de-tumble and orient the body with the magnetic field lines and then rely on atmospheric drag to passively stabilize the sailcraft in an essentially maximum drag attitude. This paper will present an introduction to solar sail propulsion systems, overview the NanoSail-D spacecraft, describe the performance analysis for the passive attitude stabilization, and present a prediction of flight data results from the mission.

### INTRODUCTION

Scientists often devise mission objectives that are difficult to accomplish with current state-of-the-art propulsion technology. Missions such as asteroid surveys, high inclination solar orbits, and comet rendezvous place enormous demands on a typical chemical propulsion system. Other missions demand an entirely new class of non-Keplerian orbits. Exotic missions such as station-keeping at artificial Lagrange points and orbits displaced from the ecliptic require a continual thrusting for long periods interspersed throughout the duration of the mission. These important missions cannot be achieved with conventional expendable propellants.

Moreover, the high cost of large-scale science missions – typically in the range of millions of dollars per kilogram of instrument payload – provides a significant incentive to investigate the potential for small satellite missions. Considerable advances have been made in

structures, avionics, power, and communication systems for smallsats, but to fully achieve the potential cost advantages for smallsats will require fundamental advances in smallsat propulsion systems. Solar sail propulsion systems offer considerable promise for enabling unconventional, non-Keplerian orbits, high delta-V orbits and meeting the demands of smallsat applications

#### *Solar Sail Fundamentals*

Solar sail propulsion utilizes the solar radiation pressure exerted by the momentum transfer of reflected photons<sup>1</sup>. The integrated effect of a large number of photons is required to generate an appreciable momentum transfer which implies a large sail area. And since acceleration is inversely proportional to mass for a given thrust force, the mass of the sailcraft must be kept to a minimum.

Figure 1 illustrates how the solar radiation pressure is utilized for propulsion. Incident rays of sunlight reflect off the solar sail at an angle  $\theta$  with respect to the sail normal direction. Assuming specular reflection from a perfectly flat sail membrane, there will be two components of force. One will be in the direction of the incident sunlight and the second in a direction normal to the incident rays. When the force vectors are summed, the components tangent to the sail surface cancel and the components normal to the surface add to produce the thrust force in the direction normal to the sail surface. For a perfect 40 meter x 40 meter square sail at 1 AU from the sun, the solar radiation thrust force is approximately 0.03 Newtons.

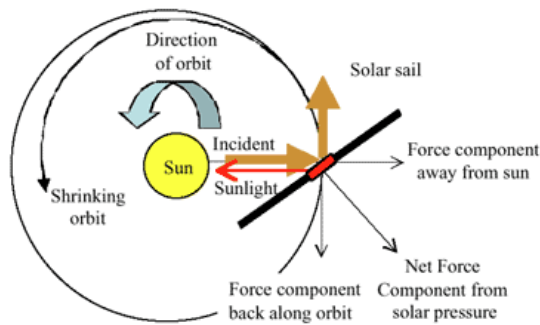

**Figure 1: Solar Radiation Thrust Force (NASA/JPL)**

Solar radiation pressure can be used in different ways to change the orbit elements. If the sail is oriented such that the thrust force is opposite the direction of motion, as in Figure 1 for a heliocentric orbit, the orbit spirals inward. Conversely, if the thrust is in the direction of motion, the sailcraft orbit spirals outward. Orbit inclination changes result when a component of the thrust force is oriented perpendicular to the orbit plane.

Thrust vector pointing is typically accomplished via either three-axis control or spin stabilization. Stringent constraints on mass coupled with the large moments of inertia resulting from the large deployed membranes makes three-axis control difficult, especially in low earth orbit where momentum from gravity gradient and aerodynamic disturbance torques must be mitigated by the attitude control system. Alternatively, conventional spin stabilization is ineffective for circular orbits where the net integrated thrust effects cancel.

### **Solar Sails for Small Satellites**

Solar sail performance is typically specified in terms of characteristic acceleration which is defined as the acceleration from solar radiation pressure at a distance of one astronomical unit from the sun. It is both a function of the reflective efficiency of the sail as well as the total system mass and reflective area. To date, solar

sail propulsion system design concepts have been investigated for large spacecraft in the tens to hundreds of kilograms mass range, consequently requiring sail areas in the thousands of square meters or larger range.<sup>2</sup> Recently however, the NASA Marshall Space Flight Center (MSFC) has been investigating the application of solar sails for small satellite propulsion. If the payload mass can be substantially reduced, then similar characteristic acceleration performance can be achieved with substantially smaller sails, thus reducing the technical risk and cost associated with the sail propulsion system. Moreover, these propulsive solar sails can be doubly utilized to de-orbit a small satellite to meet the end-of-mission disposal requirements without the need of a dedicated chemical propulsion system that would otherwise incur parasitic mass and volume impacts. At the same time, the NASA Ames Research Center (ARC) has been developing small spacecraft missions which could benefit from this mass-efficient propulsion and de-orbit capability. Hence a synergistic collaboration has been established between these two NASA field centers with the objective of conducting a flight demonstration of solar sail technologies for small satellites.

### **NANOSAIL-D SYSTEM OVERVIEW**

The NanoSail-D mission is currently scheduled for launch onboard a Falcon 1 Launch Vehicle in the late June 2008 timeframe. The NanoSail-D spacecraft will consist of a sail subsystem stowed in a 2U volume with a 1U bus provided by NASA ARC.

Given a near-term opportunity for launch, the project was met with the challenge of delivering the flight hardware in approximately six months, which required a significant constraint on flight system functionality. As a consequence, the baseline spacecraft functionality was limited to passive attitude control with no ground command capability and only minimal health and status telemetry sent to the ground. No on-board camera or instrumentation will be utilized to image the deployed sail or measure the attitude dynamics since these functions require considerable software and avionics infrastructure which was beyond the scope of the project budget and schedule.

The stowed configuration of the NanoSail-D spacecraft is illustrated in Figure 2. The spacecraft bus, provided by NASA Ames Research Center, is configured with a flight proven computer, power supply, S-band radio and UHF beacon radio. Passive attitude control is provided by permanent bar magnets that are installed in the bus closeout panels. The spacecraft bus occupies the upper 1/3 volume of the 3U sized "CubeSat" class spacecraft.

The solar sail subsystem occupies the lower 2/3 volume of the spacecraft. Sail closeout panels provide protection for the sail and booms during the launch phase of the mission. These panels have spring loaded hinges that will be released on-orbit, under the command of the spacecraft bus. Figure 3 depicts the NanoSail-D on-orbit after closeout panel release, prior to the sail deployment.

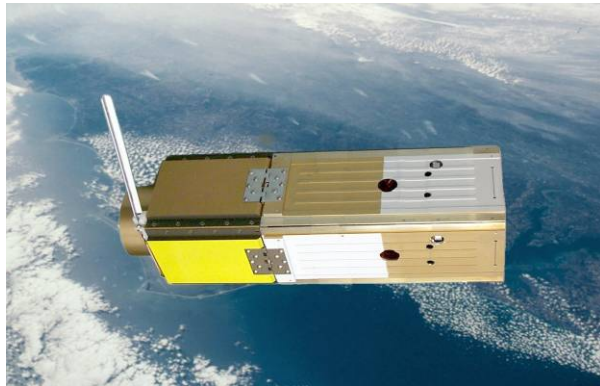

**Figure 2: On-Orbit Stowed Configuration**

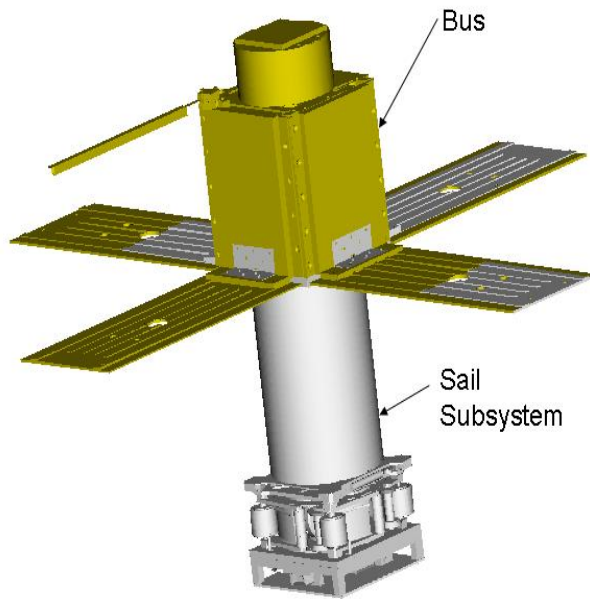
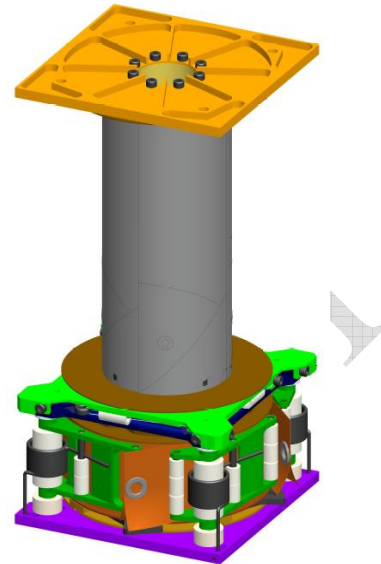

**Figure 3: Panel Deployed Configuration**

***Sail Subsystem Description***

ManTech SRS (MSRS), in Huntsville, Alabama was responsible for design, development and testing of the Sail Subsystem for Nanosail-D. Though the sail-subsystem was utilized as a drag device for the current mission all the essential components of the sail subsystem are scalable to >40m<sup>2</sup> sail missions and were merely truncated due to the aggressive timeline of the

current mission. Details of the sail subsystem are depicted in Figure 4.



**Figure 4: Sail Subsystem**

Due to the aggressive time constraints of the mission (from inception to launch in less than 6 months) the Sail-subsystem was purposely designed to be as modular as possible with the sail subsystem divided into two primary components; the sail assembly and the boom mechanical assembly. Dividing the sub-assembly allowed for; 1) separate relevant functional testing of the sail mechanical assembly and the boom mechanical assembly during the development of the system and 2) complete testing of the entire sail subassembly (deployment functionality) prior to integration with the Nanosail-D bus and release electronics. This basic approach allowed for quick incorporation of lessons learned and design modifications during the development at the sub-system and sub-assembly level without affecting the activities/design of any other components. Once assembled the Sail subassembly consisted of a stand alone unit that bolted to the Bus and connected to the release electronics. Launch operations consists of a simple, timed two actuation system. The initiating event consists of a burn-wire release of the door panels. The door panels protect the sail material and help to constrain it for the launch environment and ascent venting. The sail membranes, fabricated from aluminum coated CP-1 material, are z-folded and rolled onto a sail spool. The Trac booms, developed by AFRL, are also rolled onto a boom spool. The stored strain energy of the rolled booms provides the driving force to simultaneously deploy both the booms and the sail quadrants. The fully deployed on-

orbit configuration of the NanoSail-D spacecraft is illustrated in Figure 5.

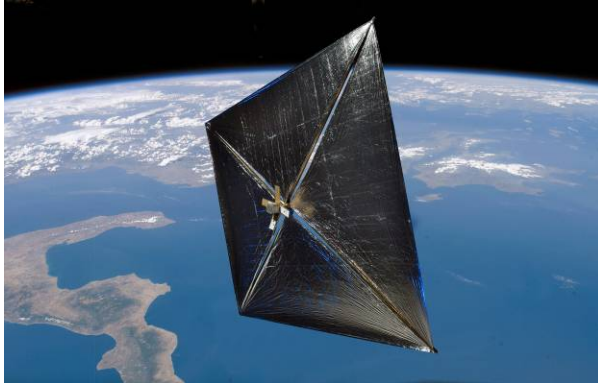

**Figure 5: On-Orbit Deployed Configuration**

### **NANOSAIL-D FLIGHT DEMONSTRATION TEST REQUIREMENTS**

The NanoSail-D Flight Demonstration Mission has four primary mission objectives:

- O1. Establish a synergistic collaboration between MSFC and ARC on small satellite missions.
- O2. Develop, qualify, and deliver an integrated NanoSail-D sail subsystem on schedule for Falcon 1 launch.
- O3. Demonstrate stowage and on-orbit deployment of a solar sail for nanosatellites.
- O4. Demonstrate solar sails as a means of nanosatellite de-orbit requirement compliance.

From these mission objectives the following three mission requirements are derived:

- R1. Deliver NanoSail-D sail subsystem to ARC for integration with the ARC NanoSail-D bus flight hardware
- R2. Upon successful launch and deployment from PPOD canister, deploy sail subsystem to fully operational state
- R3. Demonstrate drag-enhanced orbit re-entry.

Success criteria for mission requirement R1 follows directly from meeting the schedule milestones. Successful accomplishment of mission requirements R2 and R3 will be demonstrated through analysis of data acquired from ground assets. Taking into consideration the limitations imposed by budget constraints and the availability of ground assets, the appropriate success

criteria for deployment of the sail to a fully operational state is that there is

- 1) no visible buckling in any of the four booms and
- 2) none of the three attach points on any of the four triangular quadrants are visibly severed.

Mission data will be potentially comprised by radar cross-sectional area data, optical images, and orbital elements. Radar cross-sectional area data and optical images will be obtained by the U.S. Army's Reagan Test Site. This data will potentially enable estimation of a lower bound on deployed sail area (lower bound only because the sail plane will likely not be normal to the line of sight during data acquisition and hence the projected area normal to the line of sight will be measured). In addition, an estimate of the deployed sail area will be obtained from correlating Keplerian orbital elements (two-line elements, TLE) with orbit propagation models that parameterize the drag coefficient as a function of deployed sail area. Estimation of the deployed area will be difficult during initial phases of the mission when the sail will be "tumbling" about the earth's magnetic field lines during part of the orbit and passively stabilized in the maximum drag orientation near perigee. Hence the estimation of deployed area from orbit data will depend on the latter phases of the mission when the orbit circularizes and the sail passively stabilizes due to aerodynamic torque in a relatively constant local vertical/local horizontal (LVLH) attitude. Thus this latter phase of the mission will provide the opportunity to gather data for demonstration of both R2 and R3. In the event that the sail does not stabilize prior to re-entry, orbital analysis will still allow an estimation of an average ballistic coefficient that can be correlated to an average area. The estimate of average area can be compared to attitude dynamics analysis studies that could suggest a reasonable sailcraft tumbling profile. While the tumbling analysis will probably not be able to derive a tumbling profile with a precise sailcraft attitude as a function of time, it can certainly help refine the estimation of the average ballistic coefficient. Regardless, the orbital analysis will definitely be able to determine sail deployment vs. complete failure of the deployment. In the case of a partial deployment, radar cross-sectional area and imagery will be a higher-fidelity source of data in determining if the sail was fully deployed.



## NANOSAIL-D FLIGHT DEMONSTRATION MISSION OPERATIONS

72 hours after deployment of the NanoSail-D from the P-POD ejection system, the solar sail will deploy and mission operations will commence as described in Table 1.

Event	Event Elapsed Time (E Time +)			Comments
	NSD Eject Time Plus			
	Hrs	Min	Sec	
Falcon-1 Launch	0	-45	0	Launch date/time, Assumed 12 noon on June 20th, 2008 (Kwajalein Local Time)
NanoSail-D Ejection from PPOD, beacon on.	0	0	0	Assume L+45 min
Beacon Operating at 5%	6	0	0	
Beacon Off Period	66	0	0	
Panels Open	72	0	0	
Booms/Sails Deploy	72	0	15	
Optical Confirmation of Deployment	73	44	0	Assumed time (1 orbit after sail deployment, orbit period 1 hr, 34 min)
TLE Confirmation of Deployment	75	14	0	Assumed time (2 orbits after sail deployment)
S-band on, listen at 30 sec on, 30 sec off.	75	0	0	
Deorbit	120	10	0	Assumed 4 days after deployment

**Table 1: Operations Sequence**

Passive attitude stabilization will be achieved using permanent magnets in the sailcraft bus to initially detumble and orient the body with the magnetic field lines. The magnets are located on opposite sides of the bus with the North-South axes of the magnets oriented perpendicular to the long axis of the spacecraft. The body will be free to rotate about the magnetic field lines as the permanent magnets align with the earth's magnetic field as illustrated in Figure 8. Since the orbit plane inclination is less than 10 degrees, the magnetic field lines will be approximately normal to the orbit plane and gravity gradient torques and aerodynamic torques will tend to a passively stabilize the sailcraft in an essentially maximum drag attitude (where the sail plane normal vector is approximately pointed in the velocity vector direction). Since the orbit is elliptical with a 685 km apogee, a 330 km perigee, and 9 degree inclination, the sailcraft will initially tend to rotate about the magnetic field lines in the proximity of apogee while the higher atmospheric drag at the lower altitudes of perigee will tend to constrain the attitude to the maximum drag orientation. Because rotation rates are a function of tip-off rates, it is not possible to precisely predict the transition from the low-drag one-axis "tumble" to drag equilibrium state (and hence only upper and lower bounds on mission duration may be estimated). However, the drag force at perigee will tend to circularize the orbit, lowering the apogee, and hence increasing the amount of time in the maximum drag orientation, and ultimately passively stabilizing the attitude in the maximum drag orientation for the

duration of the orbit as the orbit tends to become more circular. It is through the means of correlating this anticipated orbital motion with orbital simulations that the deployed area of the sail can be estimated and the functionality for de-orbiting can be demonstrated.

Figure 6 illustrates the type of mission analysis that will be used to estimate deployed sail area from the orbit decay. Beginning with the initial state vector for the deployed sail, the orbit decay over 24 hours was determined by propagating the orbit with Satellite Tool Kit from AGI, Inc. The change in semi-major axis is strongly a linear function of the deployed sail area, which suggests that (once the sailcraft achieves passive stability in the maximum drag orientation) the change in orbit energy can be correlated to the deployed sail area and thus can validate the sail deployment mission objective and requirement.

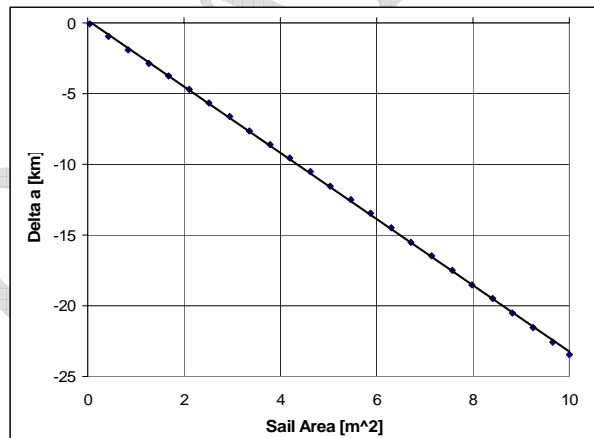

**Figure 6: Orbit Decay as a Function of Sail Area within a 24 hour time frame**

Estimates of the mission elapsed time until the sail re-enters the atmosphere are generated by propagating the orbit using the lifetime tool in STK. Assuming a drag coefficient of 2.0 with a constant projected frontal sail area (assuming passive stabilized equilibrium), the sail area was varied from over 10 m<sup>2</sup> (full deployed sail) to 0.0378 m<sup>2</sup> (no sail deployment) and the lifetime of the sailcraft was calculated. Figure 7 illustrates the mission duration (days until re-entry) as a function of deployed sail area. However, since this analysis assumed a constant sail area and did not take into account the initial slow tumble (with time varying projected frontal area) for an unknown number of orbits, these lifetime estimates serve as a lower bound on the lifetime. Hence for a fully deployed sail with a deployed area of 10 m<sup>2</sup>, this analysis yields a lower bound on the mission duration of 5.1 days. For a 50% deployed sail, the mission is predicted to be greater than 11 days.

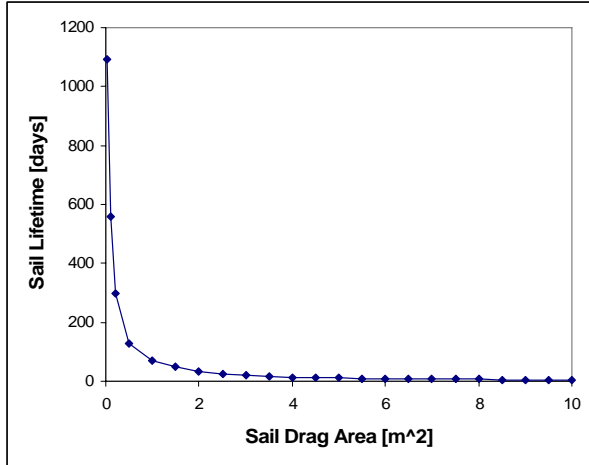
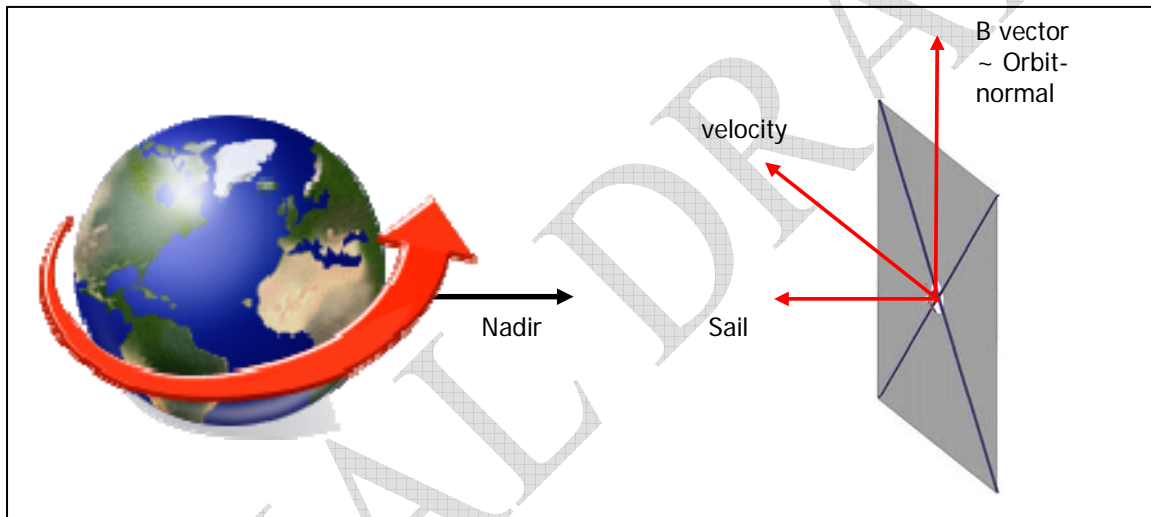

**Figure 7: Mission Duration as a Function of Sail Size**

Kervin, Chief Scientist for the Air Force Maui Optical Station.

**References**

1. McInnes, C.R., Solar Sailing: Technology, Dynamics, and Mission Applications, Praxis Publishing Ltd, Chichester, UK, 1999.
2. Montgomery, E.E. and C.L. Johnson, “The Development of Solar Sail Propulsion for NASA Science Missions” Proceedings of the 45th AIAA/ASME/ASCE/AHS/ASC Structures, Structural Dynamics and Materials Conference; Palm Springs, CA; April 2004.



**Figure 8: Orbit Geometry**

These analyses will be repeated in real time from mission TLE data and after a stabilized attitude is achieved, correlations will yield estimates of deployed area and remaining mission lifetime.

**Acknowledgments**

This work was performed under the sponsorship of Mr. David King, Director of the NASA Marshall Space Flight Center, Dr. S. Pete Worden, Director of the NASA Ames Research Center, and Dr. John Horack, Manager of the Science and Mission Systems Office at the Marshall Space Flight Center. The boom technology used on NanoSail-D was provided by Dr. Jeffery Welsh, Manager of the Spacecraft Components Technology Branch at the Air Force Research Laboratory. On-orbit imaging and tracking of NanoSail-D was provided by MAJ Timothy Bean, Reagan Test Site Space Operations Officer and Dr. Paul

# **NanoSail-D: The First Flight Demonstration of Solar Sails for Nanosatellites**



**22<sup>nd</sup> AIAA/USU Conference on Small Satellites**

*Presented by: Charles Adams, Gray Research, Inc./Jacobs ESTS Group  
Dr. Mark Whorton, Andy Heaton, Robin Pinson: NASA Marshall Space Flight Center  
Greg Laue: ManTech SRS Technologies*

August 13, 2008

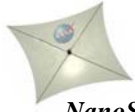

NanoSail-D

# NanoSail-D Mission Configuration

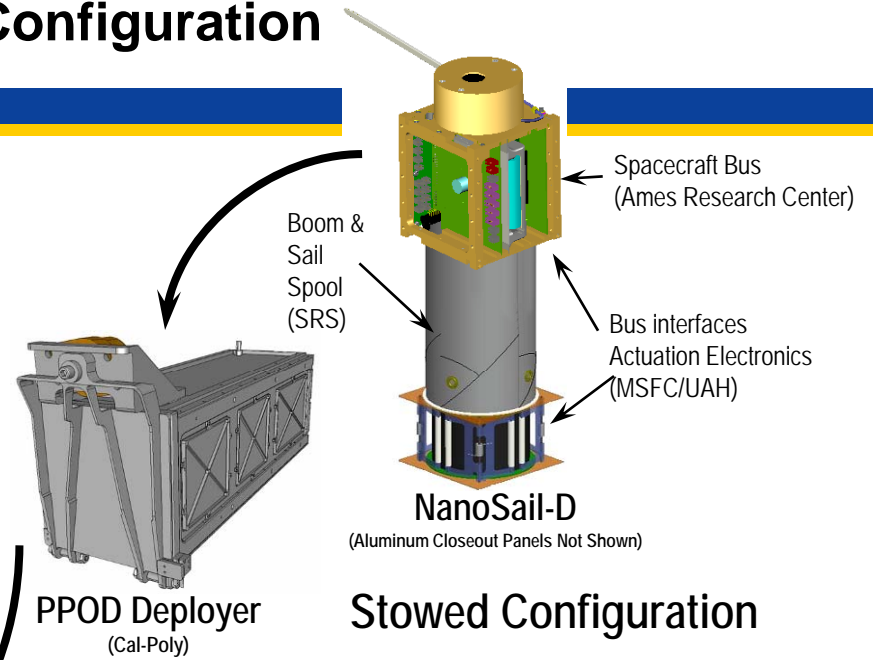
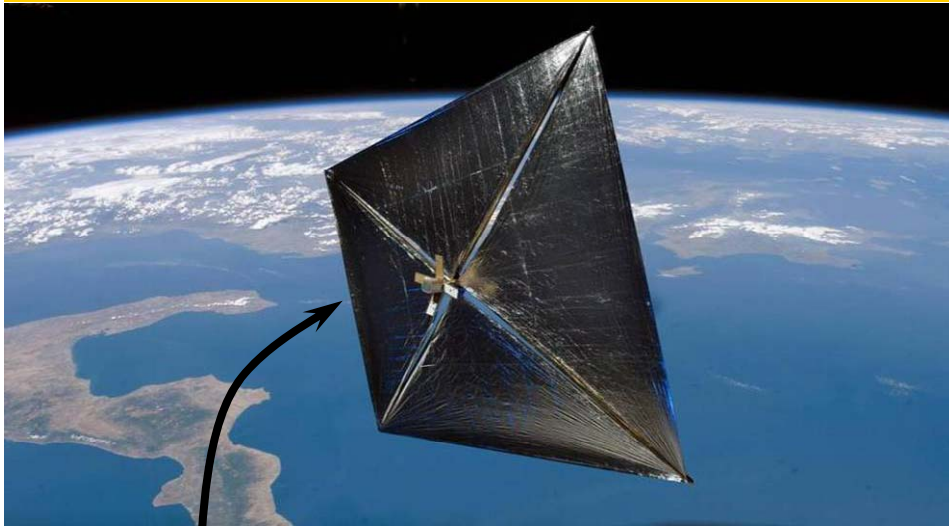

SpaceX Falcon-1

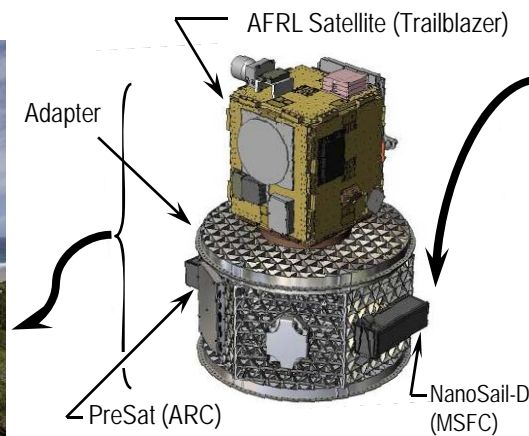

Launch Date: July 29, 2008  
 Launch site: Omelek Island, RTS (Kwaj)  
 Orbit: 685 X 330 km, 9° inclination  
 De-Orbit Period: 5 - 14 days

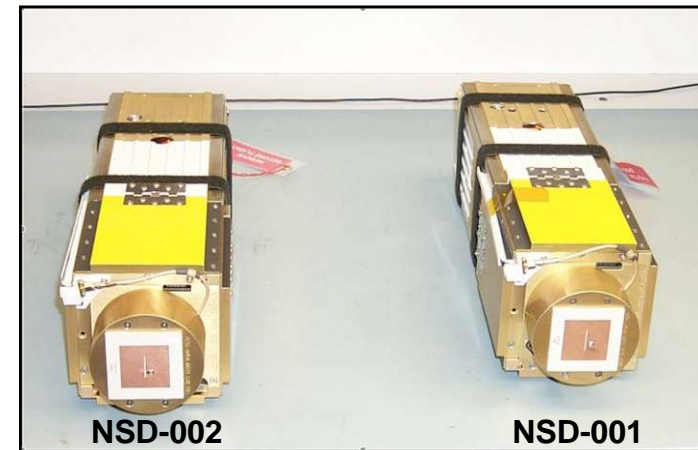

- 3U Cubesat: 10cm X 10cm X 34cm
- Deployed CP-1 sail: 10 m<sup>2</sup> Sail Area (3.16 m side length)
- 2.2 m Elgiloy Trac Booms
- UHF & S-Band communications
- Permanent Magnet Passive Stabilization



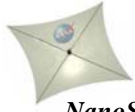

NanoSail-D

# NanoSail-D: A Team Effort



Marshall Space Flight Center

Project Manager, Elwood Agasid/ARC  
 Mission Manager, Bruce Yost/ARC  
 Principal Investigator, Dr. Mark Whorton/EV42  
 Payload Manager, Edw. E. Montgomery/VP52  
 Deputy, Charlie Adams/Gray Research  
 Payload Engineer, Dean Alhorn/ES32



ManTech  
International Corporation.



CAL POLY



L&M  
Electronics





NanoSail-D

# NSD Project Overview

- **Minimum Success Criteria**
  - Successful collaboration with ARC to deliver a payload for launch – [achieved on 4/21/08]
- **Full Success Objectives**
  - Primary: First solar sail deploy in space
  - Secondary
    - *Solar Sail performance assessment*
    - *Drag sail assessment*
    - *Pioneer new project processes*
- **Deliverables**
  - Primary Solar Sail Payload Assembly
  - Spare Solar Sail Payload Assembly
  - Payload Mockup for ARC Bus development
  - Poly PicoSat Orbital Deployer
- **MSFC Management Structure**
  - Project Management: VP
  - Lead Project Engineer: ES32
  - Principal Investigator: EV42
  - S&MA: QD22
  - ITA: EE04
- **Sponsors**
  - MSFC Center Director
  - ARC Center Director



# Major Milestones

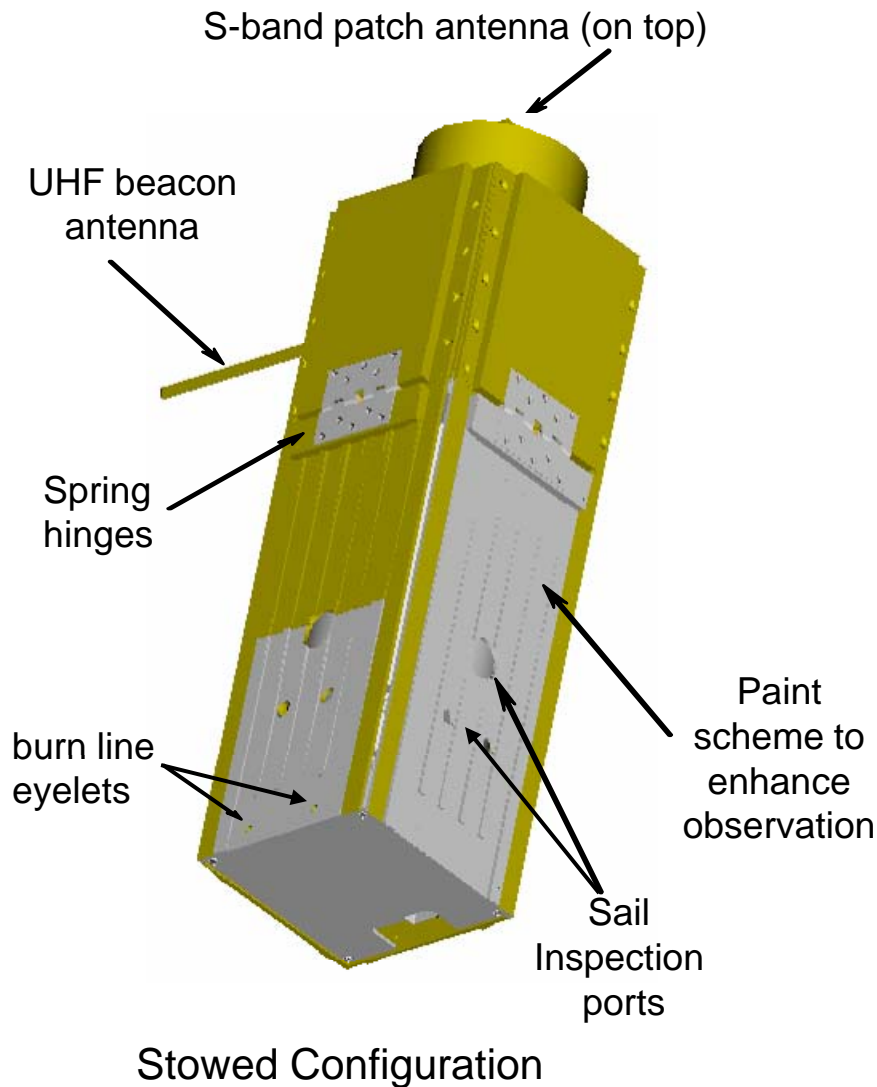

- Past
  - Final Design Audit - 1/17/08
  - MSFC System Acceptance - 4/17/08
  - Sail payload delivery to ARC - 4/21/08
  - Bus-payload integration and flight certification at ARC
    - Integration & checkout – 4/21-24
    - Satellite environmental testing - 4/25 - 5/6
    - Mission simulations completed - 5/10
  - FRR at ARC – 5/13/08
  - ORR at ARC– 6/9/08
- Current:
  - PM&PI travelling to Kwajalein
  - NSSTC/1048 mission center set-up
- Future
  - Launch/Mission Ops 7/18 – 8/10
    - S. Montgomery/VP52 on Kwaj
    - D. Alhorn/ES23 at NSSTC
    - M Whorton/EV42 at Kwaj
    - J. Morcone/MSFC Media Relations
    - Laurie Provin S&MS E/PO
  - Initial Outbrief – 8/16/08
  - Paper at AIAA Conference 8/11/08



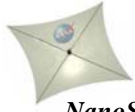

NanoSail-D

# Stowed Configuration

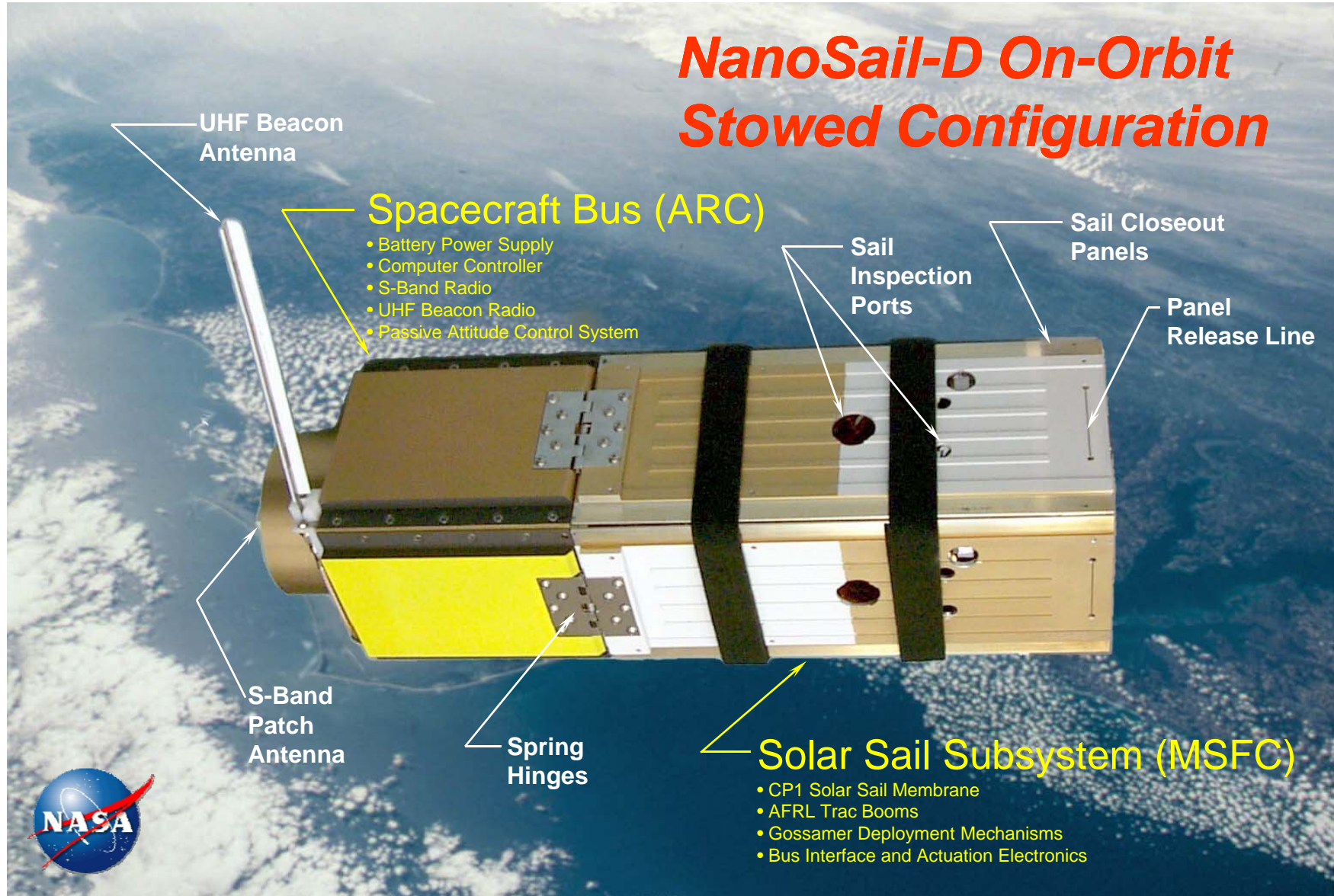



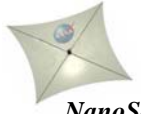

NanoSail-D

# Deployment Video



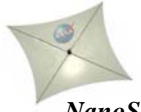

NanoSail-D

# Deployed Configuration

## NanoSail-D On-Orbit Deployed Configuration

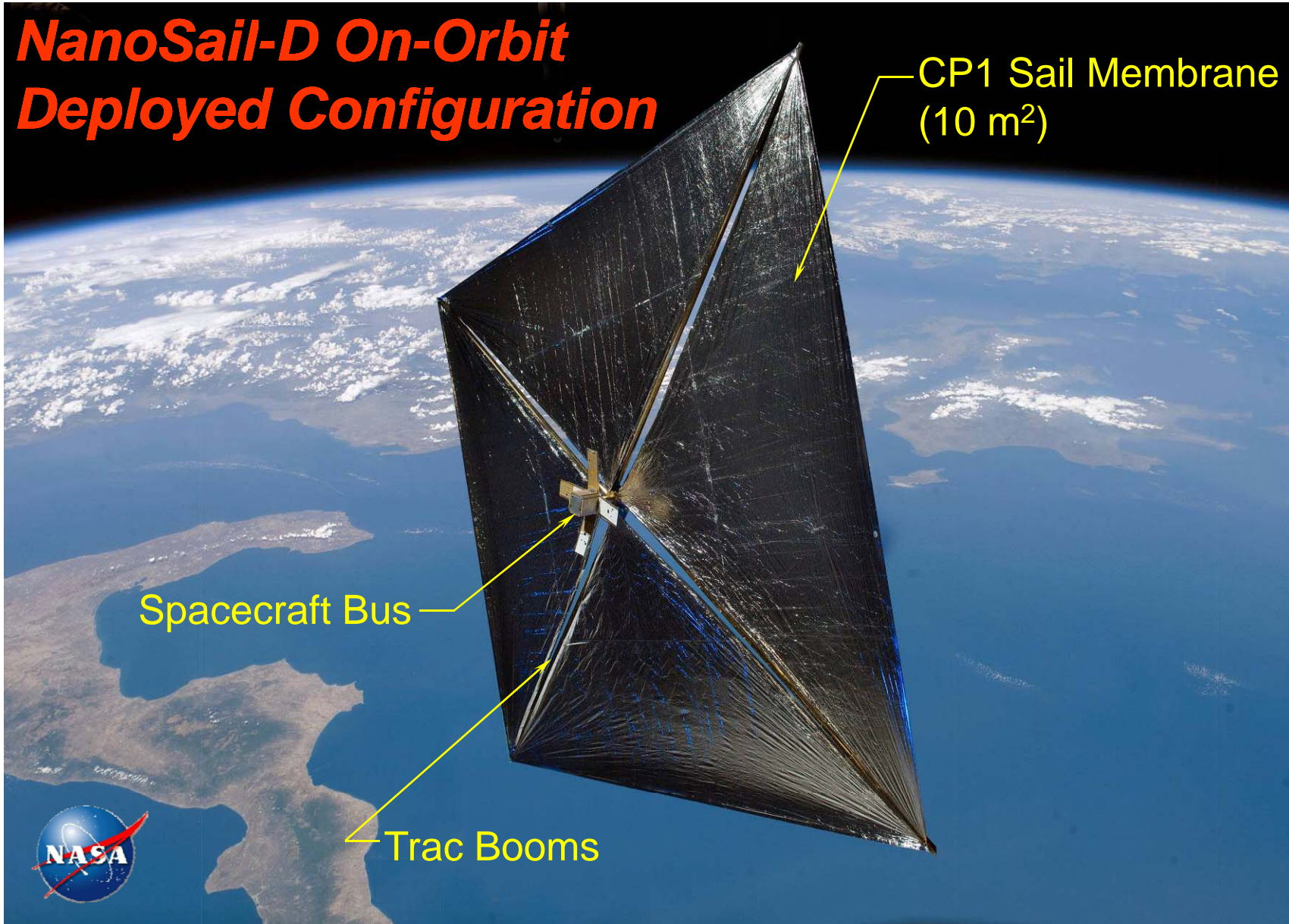

CP1 Sail Membrane  
(10 m<sup>2</sup>)

Spacecraft Bus

Trac Booms

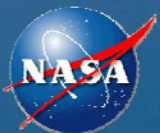



# Mission Milestones

<b>Mission Event</b>	<b><i>Time After Launch, L+ time (hr:min:sec)</i></b>	<b><i>Comments</i></b>
<b>1. Falcon-1 Launch</b>	00:00:00	
<b>2. NanoSail-D Ejection from PPOD, UHF beacon on @ 10%</b>	00:17:47	1067 seconds after launch.
<b>3. Panels Open</b>	72:17:47	72 hrs after ejection from P-POD.
<b>4. Booms/Sails Deploy</b>	72:18:02	15 seconds after panel opening.
<b>5. S-band on, listen at 30 sec on, 30 sec off.</b>	72:22:47	5 minutes after panel opening.
<b>6. Optical Confirmation of Deployment (projected)</b>	73:52:02	1 orbit after sail deployment (orbit period: 1 hr 34 min).
<b>7. TLE Confirmation of Deployment (projected)</b>	75:26:02	2 orbits after sail deployment.
<b>8. Deorbit</b>	168:18:02	Assumed 4 days after sail deployment.



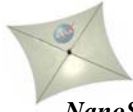

# Mission Dashboard

## NanoSail-D Mission Dashboard

<u>Mission Counter</u>		<u>Satellite Status</u>		<u>Ground Segment Status</u>	
0		<b>Payload Status</b>		<b>Kwajalein comm station</b>	In Transit
<u>Mission Phase</u>		Panel	Stowed	Station shipped 6/4	
Pre-Launch Processing		Sail	Stowed	<b>El Salvador comm station</b>	Nominal
June 24 0900	<b>Launch Operations</b>	<b>Bus Health</b>		Station installed and verified	
	Pre-Sail Flight	Bus Temp	---	<b>CREST ops facility</b>	Nominal
T+72 hours	<b>Sail Deployed Powered</b>	Batt V	---	<b>SCU ops facility</b>	Nominal
~ T+100 hours	<b>Sail Deployed Unpowered</b>	Comm	---	<i>Photo of the Week - <a href="#">UCA antenna</a></i>	
~ T+2 wks	<b>Satellite De-orbited</b>	CPU	---		

**Event Summary (times in PDT)**

- 6/4/08 0900: Satellite leaves Ames

**Operational Notes (times PDT)**

- Launch planned for 6/24 1900 from Reagan Test Site, Kwajalein Atoll

**Drag Estimate from TLEs**

Post-launch, this will be a time history plot of the TLE drag term

**Semi-Major Axis**

Post-launch, this will be a time history plot of the semi-major axis (which will shrink over time)

**Eccentricity**

Post-launch, this will be a time history plot of the eccentricity (which will circularize over time)



Santa Clara University Robotics Systems Laboratory



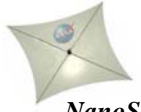

# On-Orbit Performance Predictions

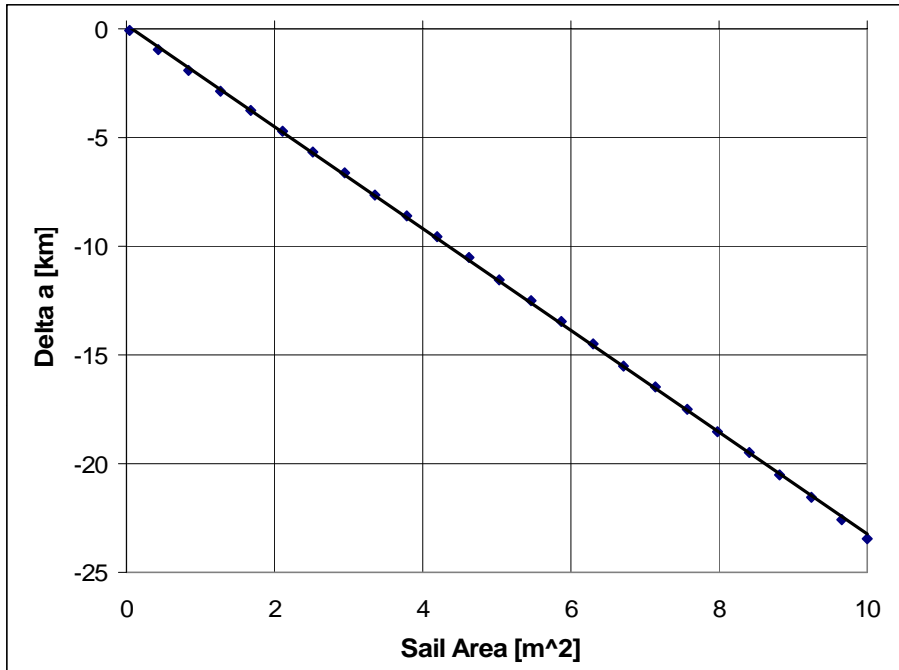

***Orbit Decay as a Function of Sail Area (24 hr Time Period)***

***Mission Duration as a Function of Sail Area***

