

Rolls-Royce Low Noise Highly Variable Cycle Nozzle for Next Generation Supersonic Aircraft

**Dr. Jack S. Sokhey, LibertyWorks®
Matthew Kube-McDowell, Grad. Student, Purdue University**

**Presented at Fundamental Aeronautics 2008 Annual Meeting
Re: NRA NN06ZEA001N, Contract NNL08AA29C, COTR – Brenda Henderson**

Abstract:

An overview of the work performed by Rolls-Royce under contract NNL08AA29C is presented. The work includes computational fluid dynamic (CFD) analysis for, and design of, a highly variable cycle exhaust model for the Supersonic project (NRA NN06ZEA001N). The CFD analysis shows that the latest design improvements to the clam shell doors have increased flow through the ejector over that achieved with previous designs.



Rolls-Royce

Low Noise Highly Variable Cycle Nozzle for Next Generation Supersonic Aircraft

Dr. Jack S. Sokhey, LibertyWorks®
Matthew Kube-McDowell, Grad. Student, Purdue University

Presented at Fundamental Aeronautics 2008 Annual Meeting
Re: NRA NN06ZEA001N, Contract NNL08AA29C, COTR – Brenda Henderson

LibertyWorks®

Supersonics Project – Airport Noise

SUP.07.04 SUP Noise Engineering

- Milestone SUP.07.04.012
 - HVC model system delivered – 4/2009
- Milestone SUP.07.04.013
 - HVC acoustic system performance assessed – 12/2007



Rolls-Royce

Historical Background

- **Propulsion System for Supersonic Aircraft**
 - Medium BPR Turbofan
 - Variable Cycle Optimized for OPR at low speed
 - Jet Noise at Take-off
 - Based on earlier Design for SSBJ (NAS3-03123)
 - RB577-260-LM2 engine-NASA QSV-IIPS Study - Tests conducted in June 2003 at Nozzle Acoustic Test Rig (NATR), GRC.
- **Exhaust Nozzle Development**
 - Based on Concord Nozzle Design
 - Variable Geometry Nozzle
 - Early CFD Flow Simulations

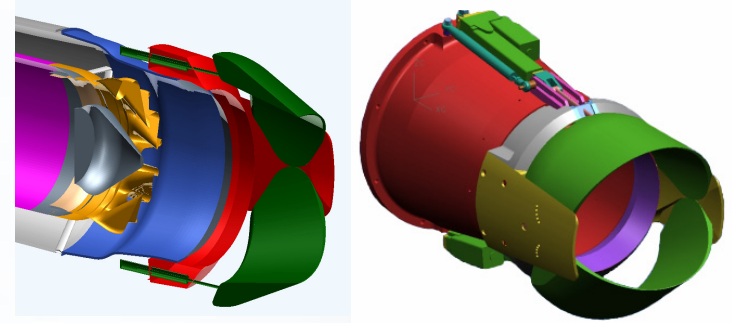
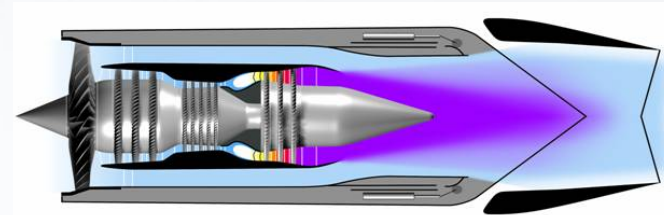

Variable Geometry Exhaust System

- **Baseline Exhaust Nozzle**
 - Mixed Flow Exhaust
 - Variable geometry CD nozzle
 - A8 and A9 (Exit)
 - Actuated Clam Shell Doors or buckets as ejectors
- **Re-design for Low Noise**
 - CFD design Validation
 - Optimum ejector door setting for thrust and jet noise
 - Performance Improvement
 - High Fidelity nozzle model design for acoustic prediction

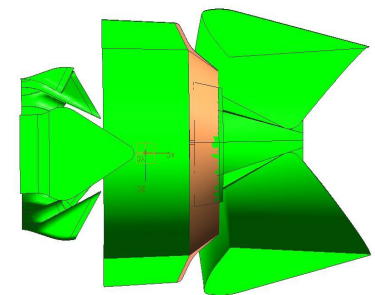
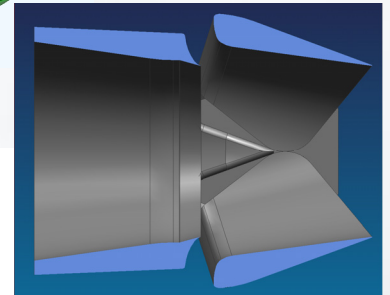
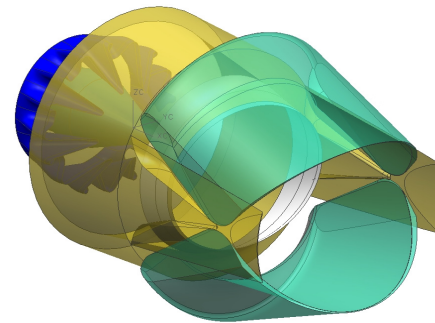
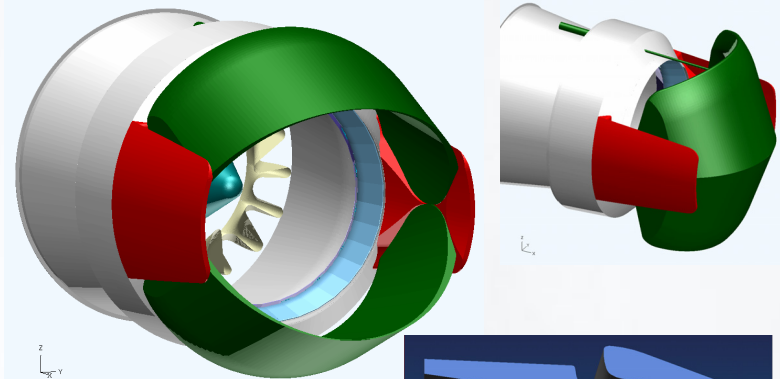

Baseline Analysis-Validation (April 2006)

- **Design and CFD Analysis -Fluent**

- 2003 design tested in 2003 at NASA GRC
- Navier-Stokes Viscous Compressible Solution - Standard ke turbulence model
- Second order explicit / implicit solution

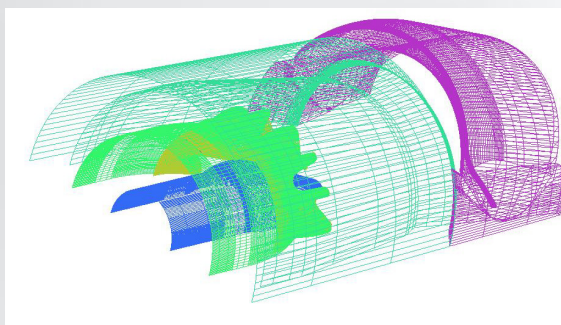
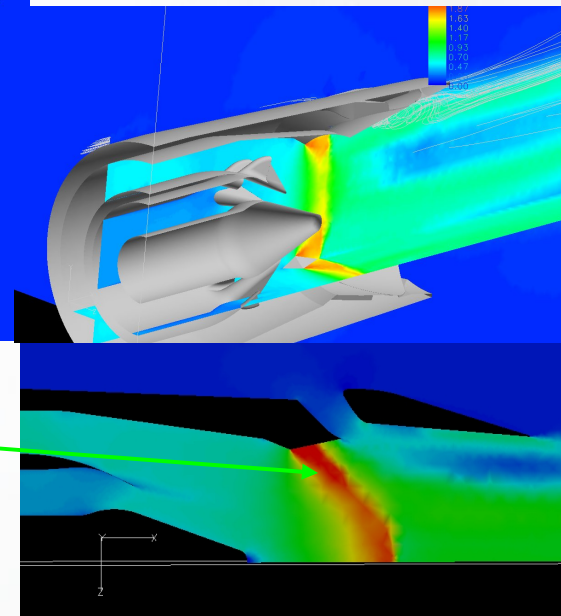
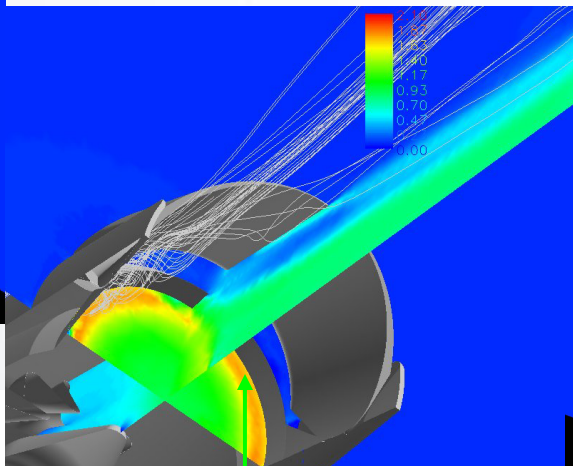
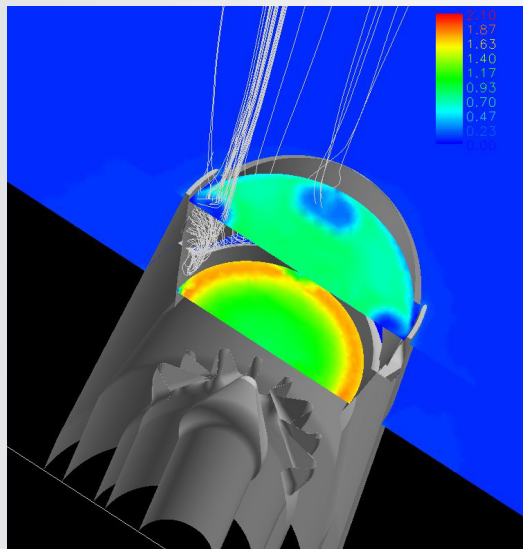

Mpeak ~1.6



Rolls-Royce

CFD Based Design and Analysis

Computational Domain and GRID

- Pointwise Code: Gridgen – Mesh
- Structured grid in far-field plume
- Prisms in boundary layer zone
- Unstructured in complex spaces

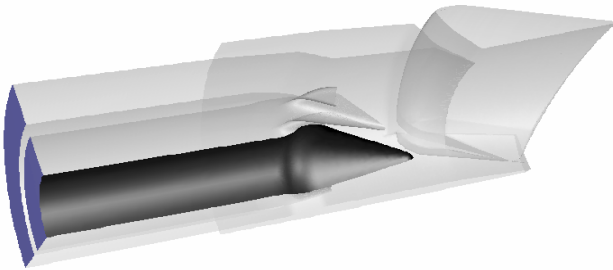
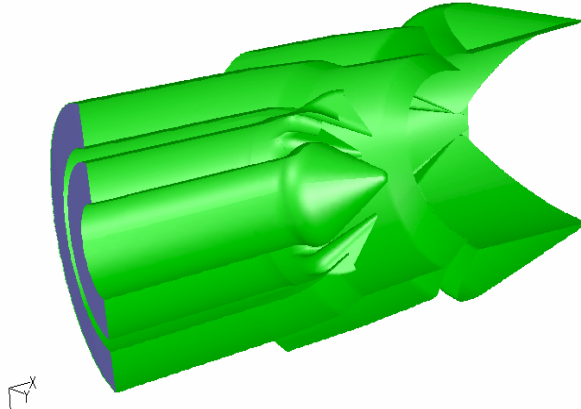
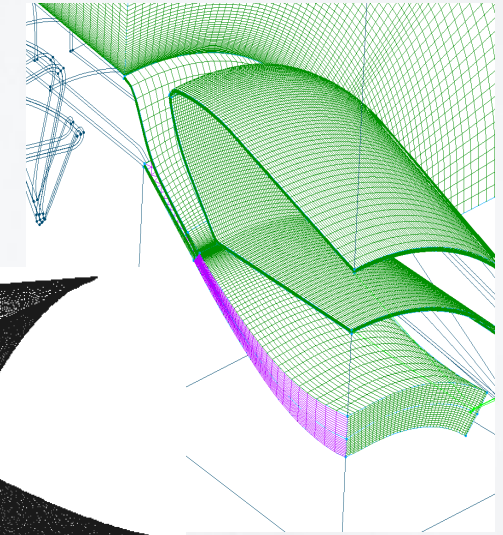

90 Degree Sector Meshed and Modeled

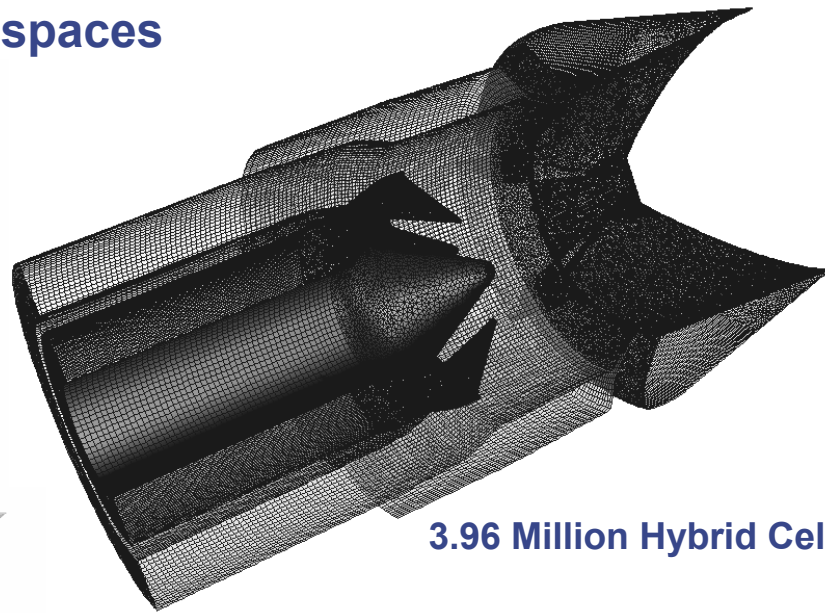

3.96 Million Hybrid Cells

Operating Condition
Mach 0.3 SL Take-off



Rolls-Royce

CFD Computational Problem Set Up & BC's

- Solver used: Fluent 6.2 - Density-based explicit
- Turbulence Model: standard k- ϵ turbulence model with wall functions
- Discretization: first-order upwind w/ under-relaxation, second-order upwind

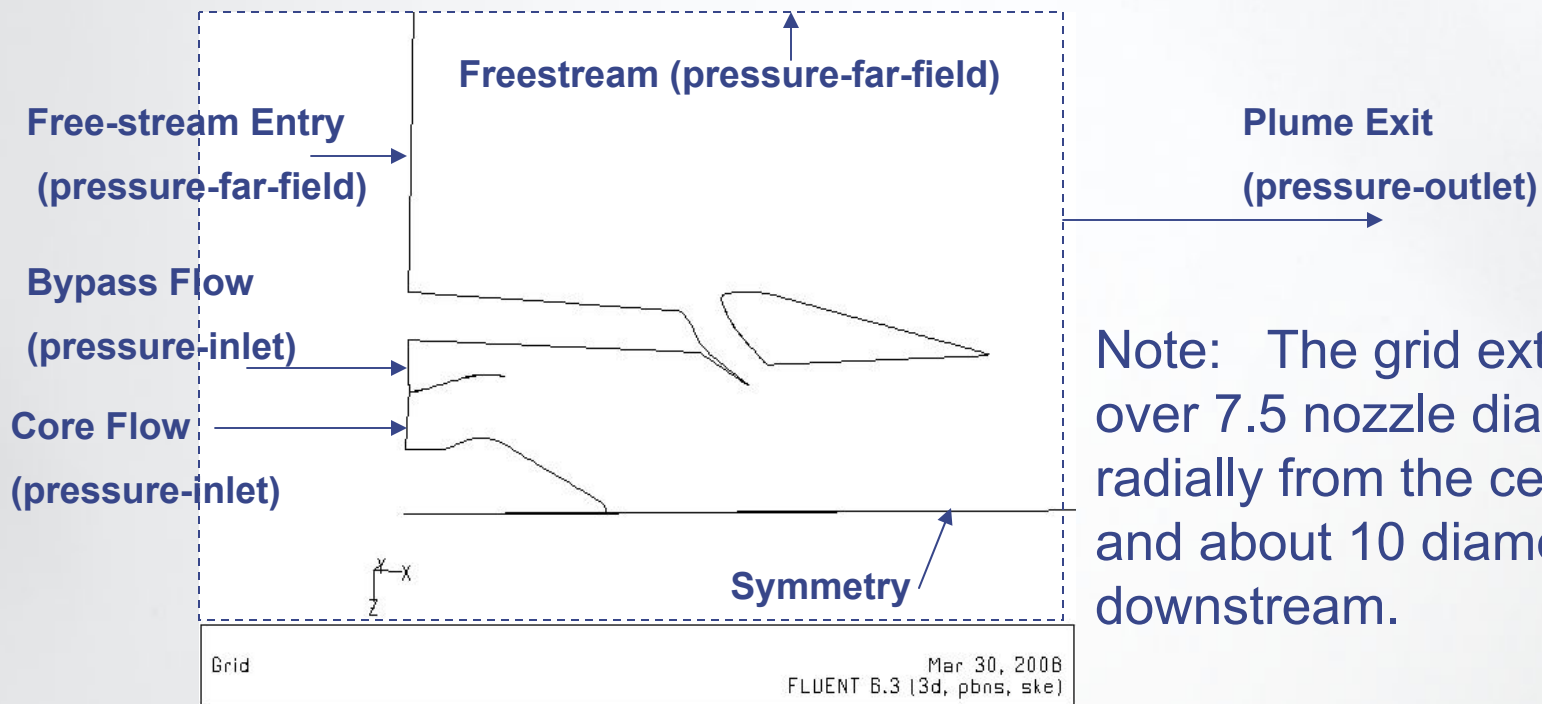

Rolls-Royce

Preliminary Nozzle Design Modifications

- **Objective: Reduce High Mach Numbers**
 - $M_{peak} < 1$ upstream of throat
 - $M_{peak} \sim 1.05$ on the side wall holding the buckets
 - Estimated increase in W_p at 0.3M TO Operation Case over Original Nozzle baseline $\sim 8\%$
 - Clean flow through Ejector Passages

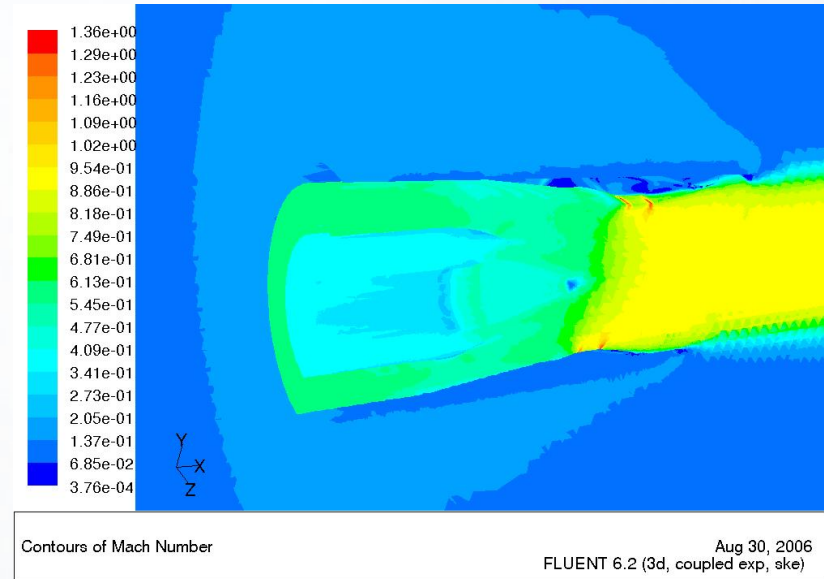
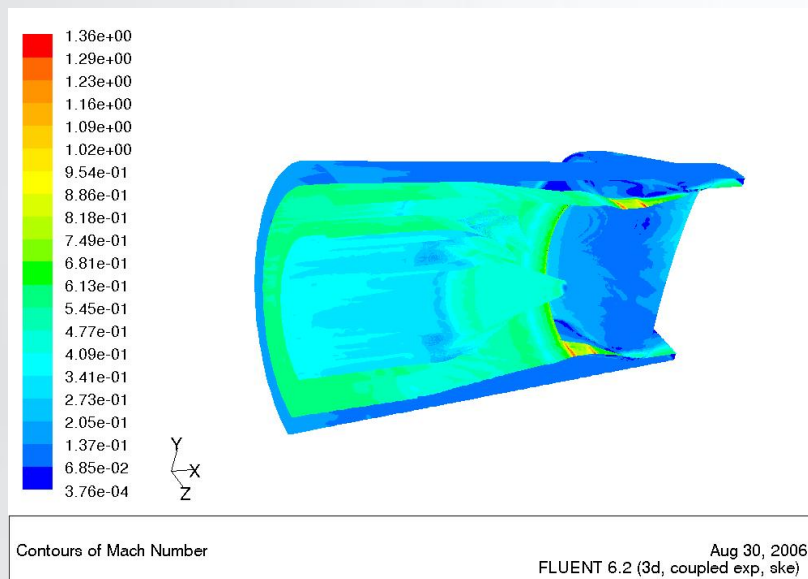

Rolls-Royce

2008 Nozzle Design Configuration

Internal Nozzle Flow-field

Mach Number Development

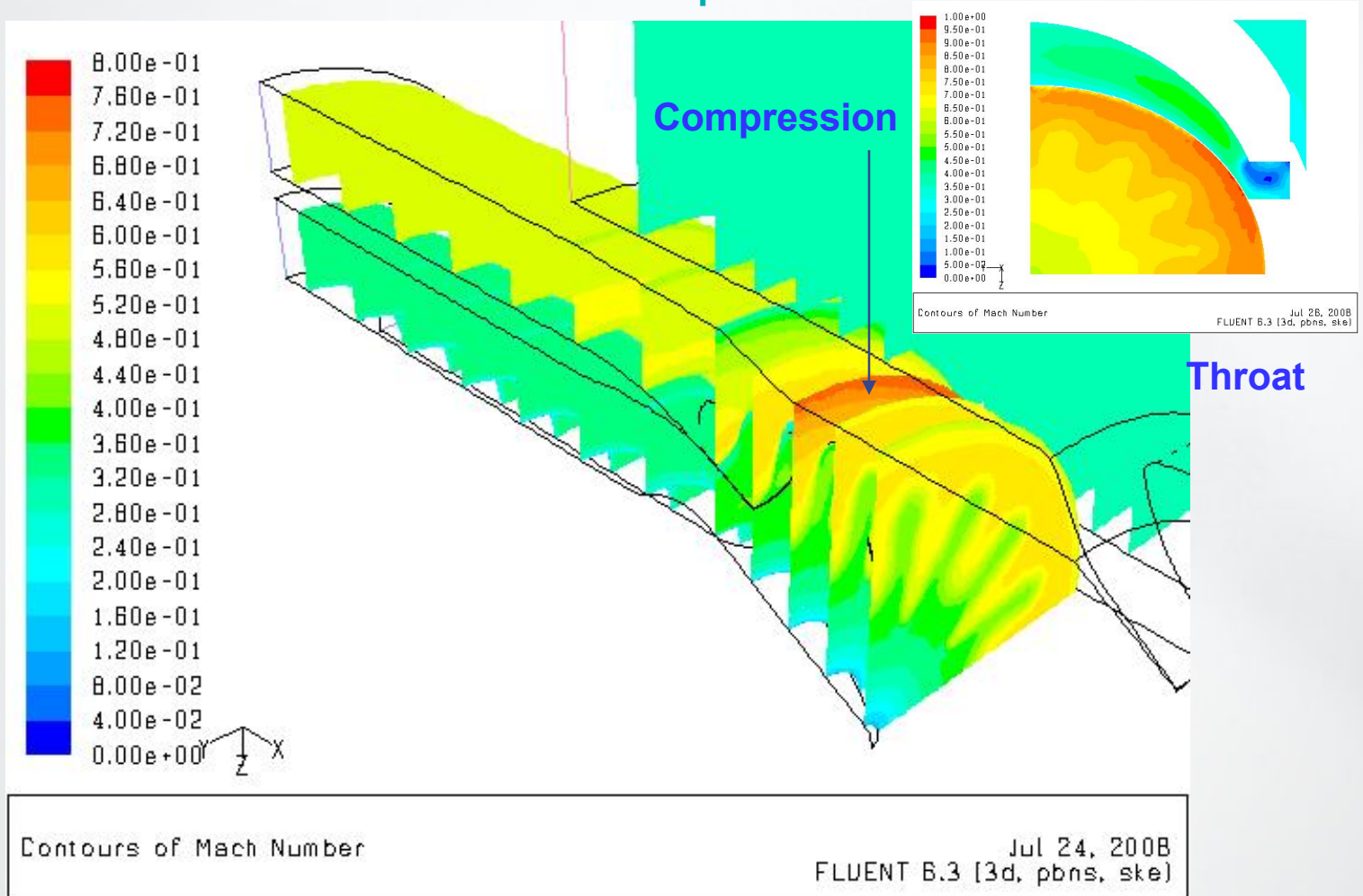

Rolls-Royce

Nozzle Plume Characteristics

Take off Configuration

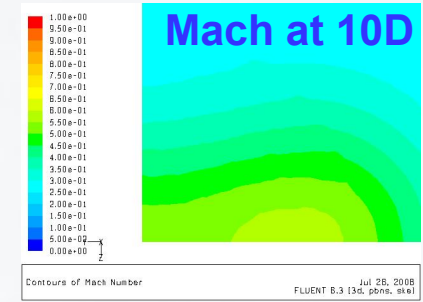
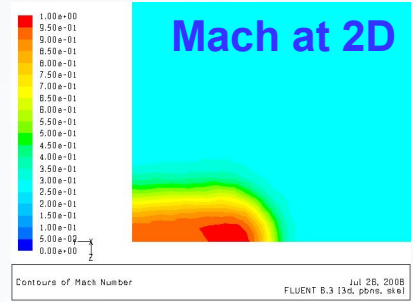
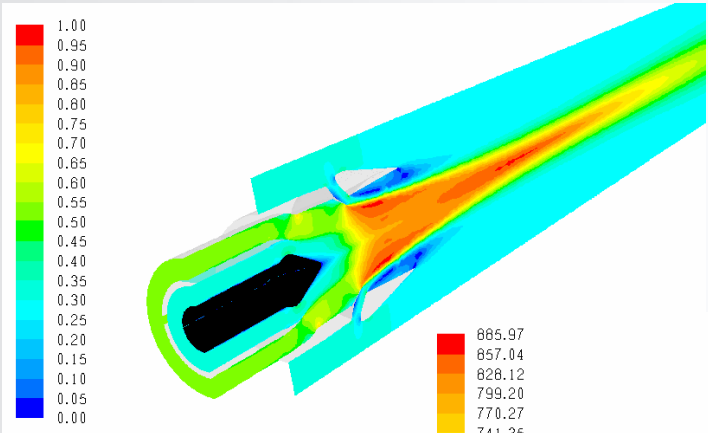

Mach Numbers

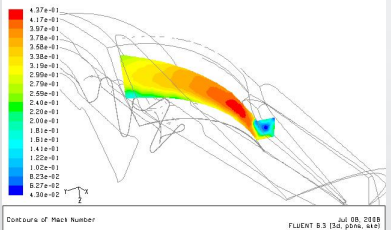

Mach in Ejector Slot region

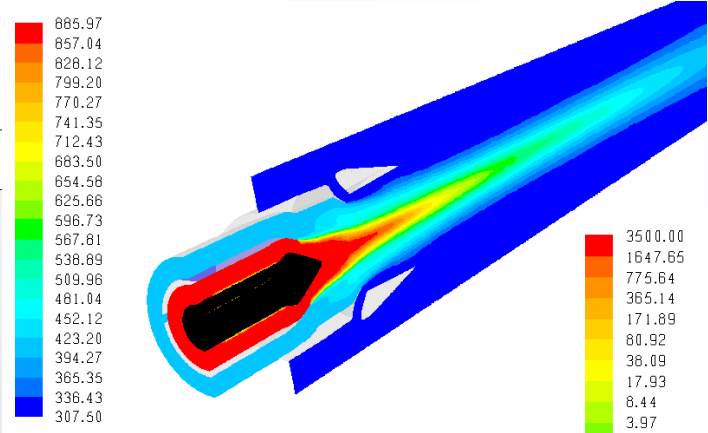

Total Temperatures

Turb. Kinetic Energy

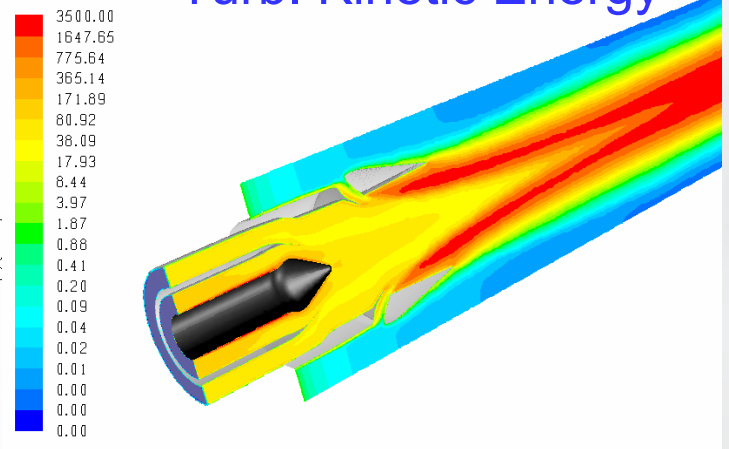

Sep 16, 2008
FLUENT 6.3 (3d, pbns, ske)

Good Plume Mixing at 10 diameters

Nozzle/Ejector Flow-Field Region

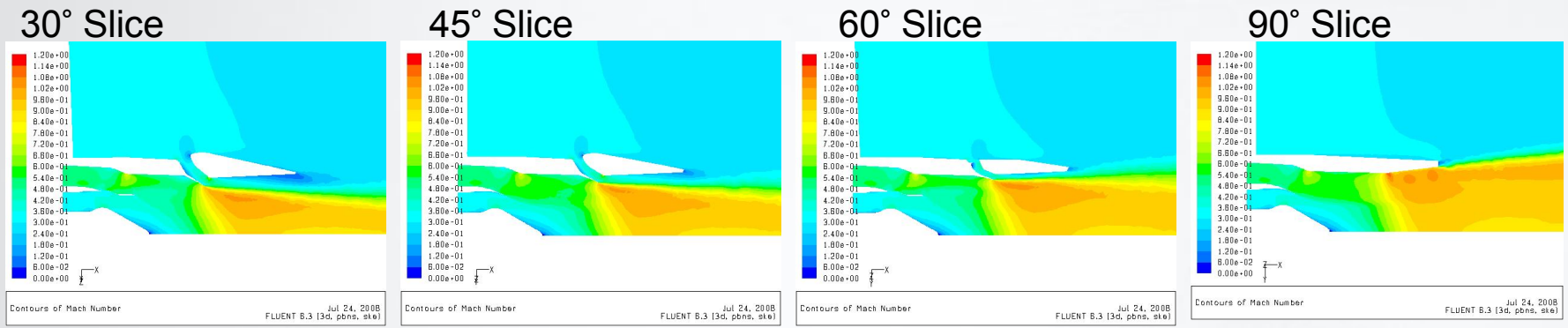

Mach number Distribution

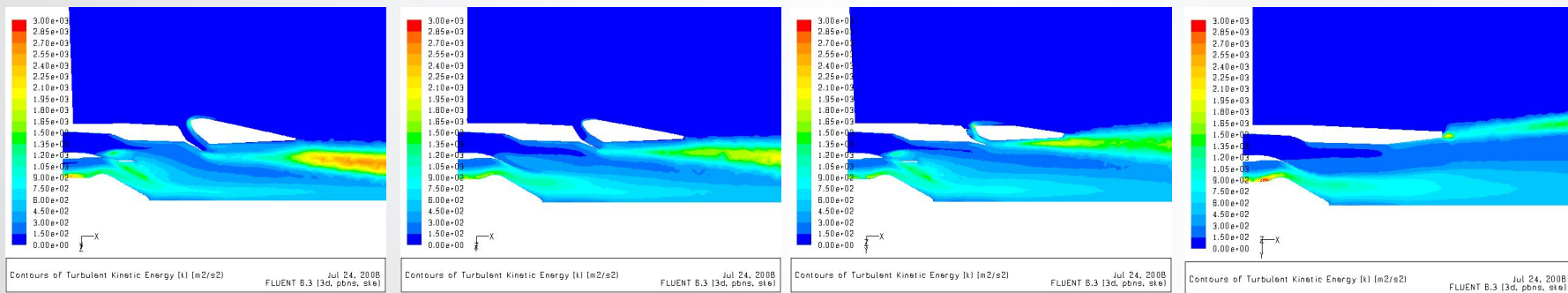

TKE Distribution

- Low Mach numbers – more noise suppression
- No reverse flow through ejector; some recirculation in slot corner
- Vorticity from sidewall and blunt TE increases the turbulent wakes



Rolls-Royce

Downstream Plume Flow-Field

Turbulent Energy Decay

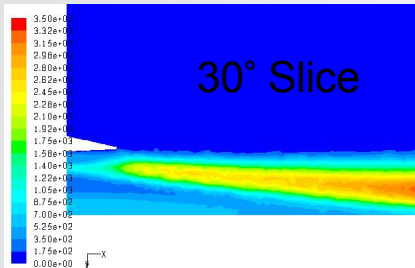

Contours of Turbulent Kinetic Energy (k) [m2/s2] Jul 26, 2008 FLUENT 6.3 [3d, pbns, ste]

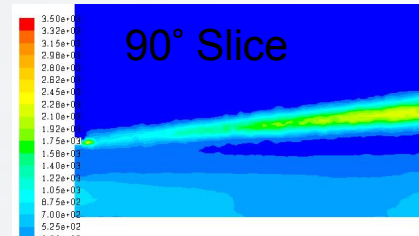

Contours of Turbulent Kinetic Energy (k) [m2/s2] Jul 26, 2008 FLUENT 6.3 [3d, pbns, ste]

at 2D

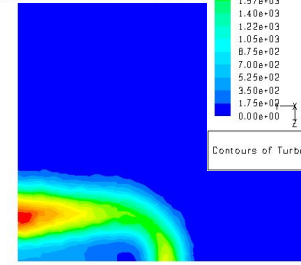

Contours of Turbulent Kinetic Energy (k) [m2/s2] Jul 26, 2008 FLUENT 6.3 [3d, pbns, ste]

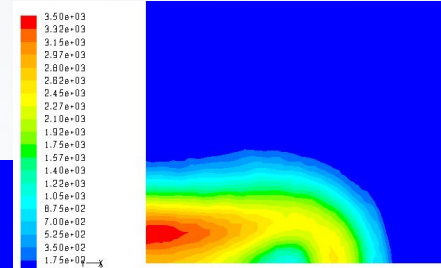

Contours of Turbulent Kinetic Energy (k) [m2/s2] Jul 26, 2008 FLUENT 6.3 [3d, pbns, ste]

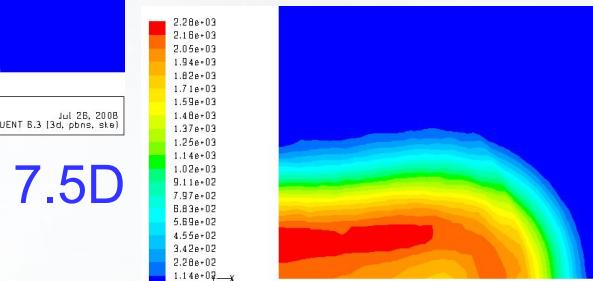

Contours of Turbulent Kinetic Energy (k) [m2/s2] Jul 26, 2008 FLUENT 6.3 [3d, pbns, ste]

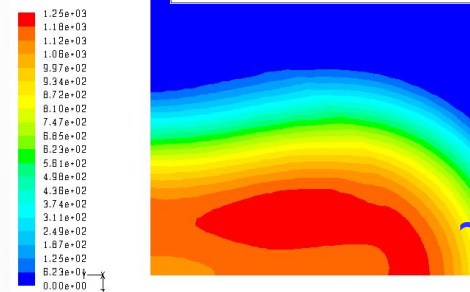

Contours of Turbulent Kinetic Energy (k) [m2/s2] Jul 26, 2008 FLUENT 6.3 [3d, pbns, ste]

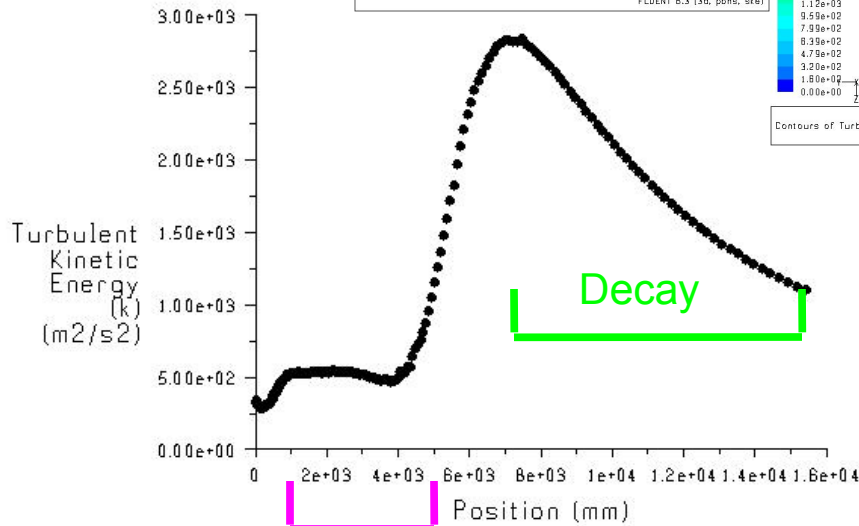

Turbulent kinetic Energy along jet centerline



Rolls-Royce

CFD Analysis at M=1.8 Cruise Case (CR)

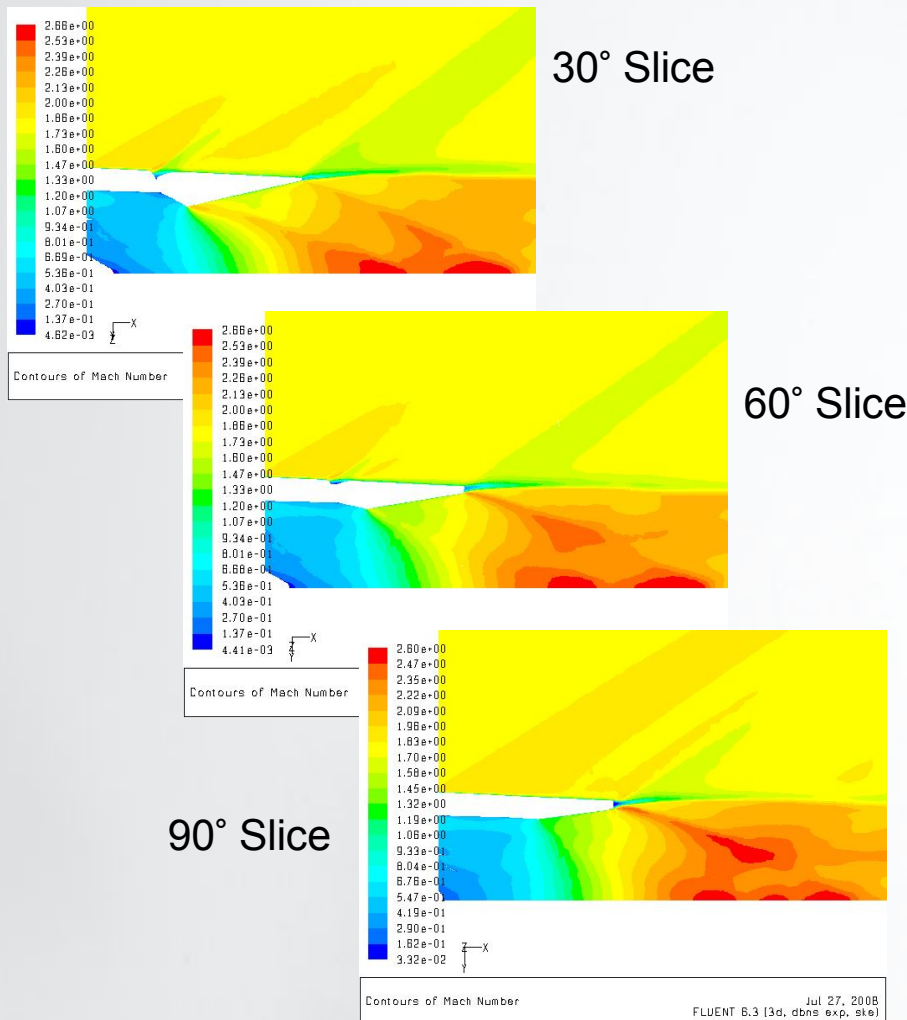

Shock predicted over ejector seam

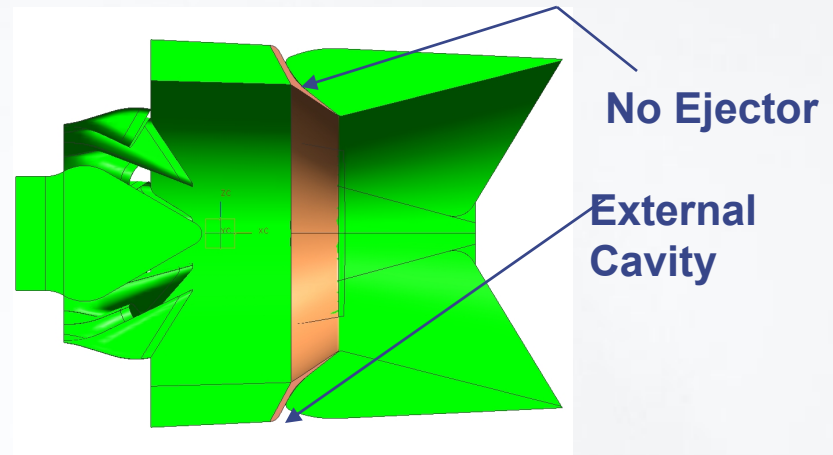

- Grid: ~10.4 million cells
- Grid resolved for boundary layers, mixing layers, and discontinuities over ejector seam
- High-speed flow and shocks slowing convergence – second-order-accurate solution drifting/oscillating, but stable



Rolls-Royce

Modifications to Ejector Doors of the SS Nozzle

- CFD analysis indicated 20% more ejector flow with no separation on the inner surface, lower turbulence and also increased thrust.

90° Plane Slice

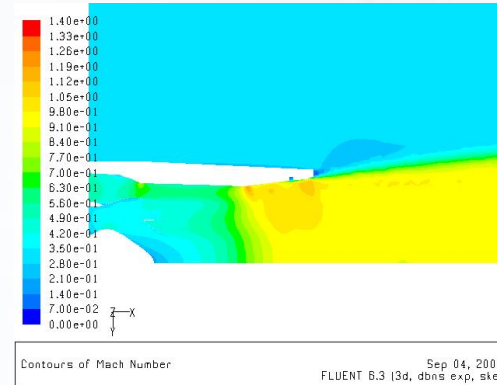
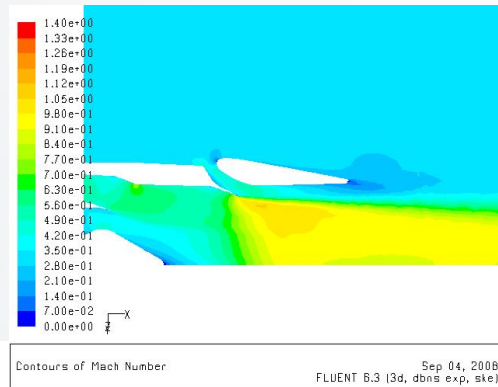
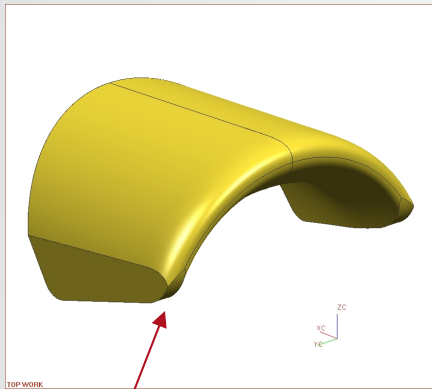

90° Plane Slice

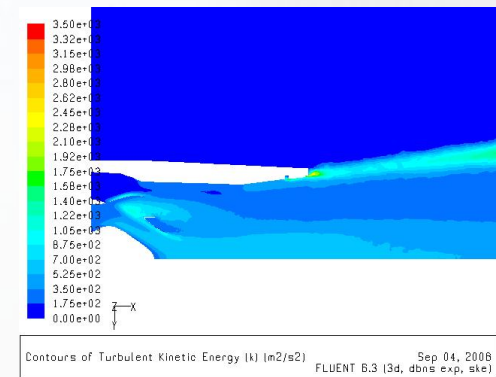
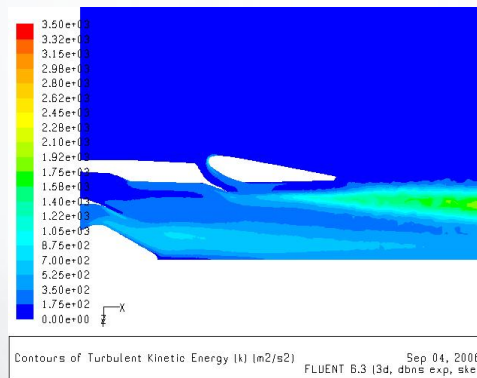
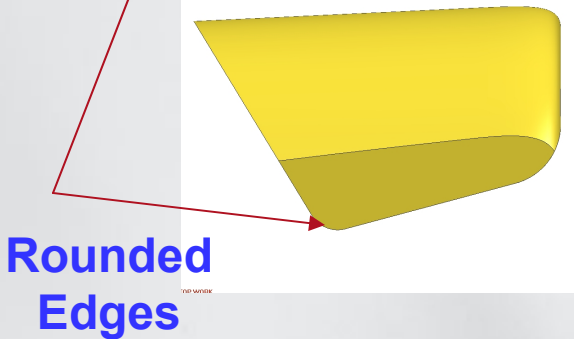

Rolls-Royce

Distribution of Turbulent Kinetic Energy

Mach 0.3, SL Take off Configuration

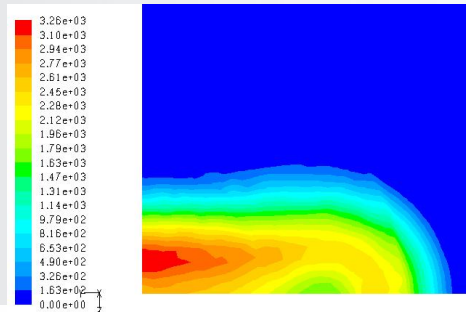

Downstream
(6 diameters)

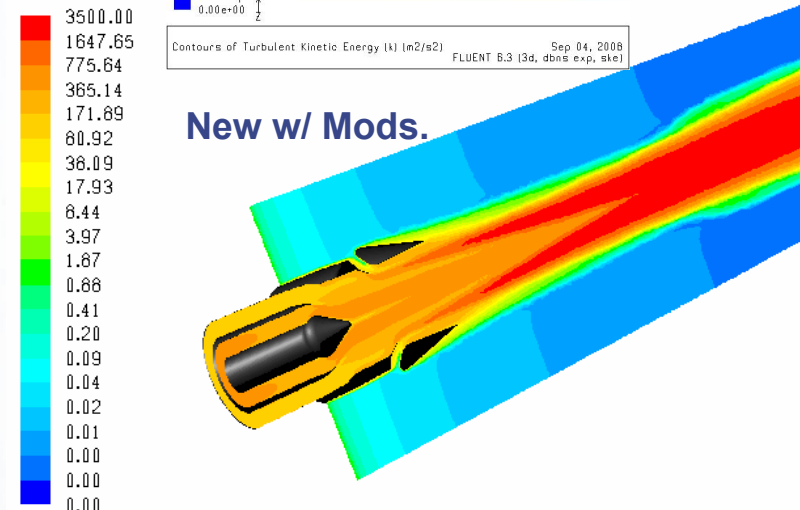
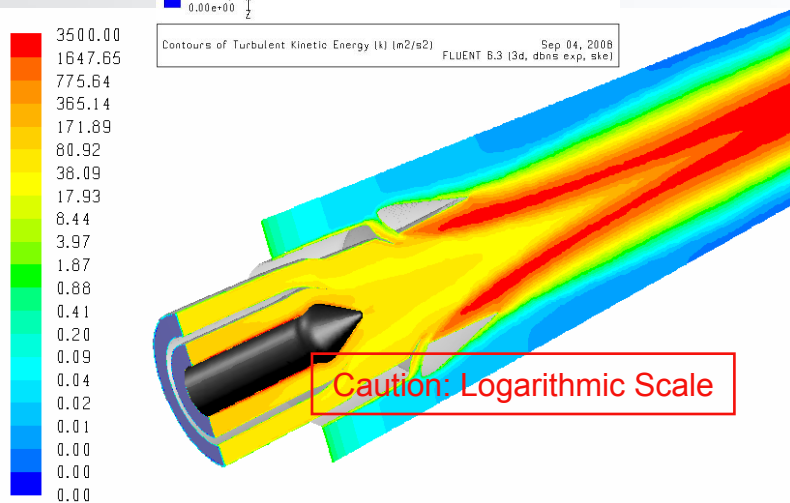
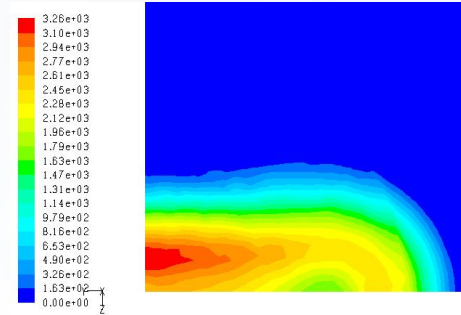

Contours of Turbulent Kinetic Energy (k) (m2/s2) Sep 16, 2008
FLUENT 6.3 (3d, pbns, ske)

Contours of Turbulent Kinetic Energy (k) (m2/s2) Sep 18, 2008
FLUENT 6.3 (3d, dbns exp, ske)



Rolls-Royce

Ejector Flow Path

Current Nozzle Design
w/ Modified ejector Door

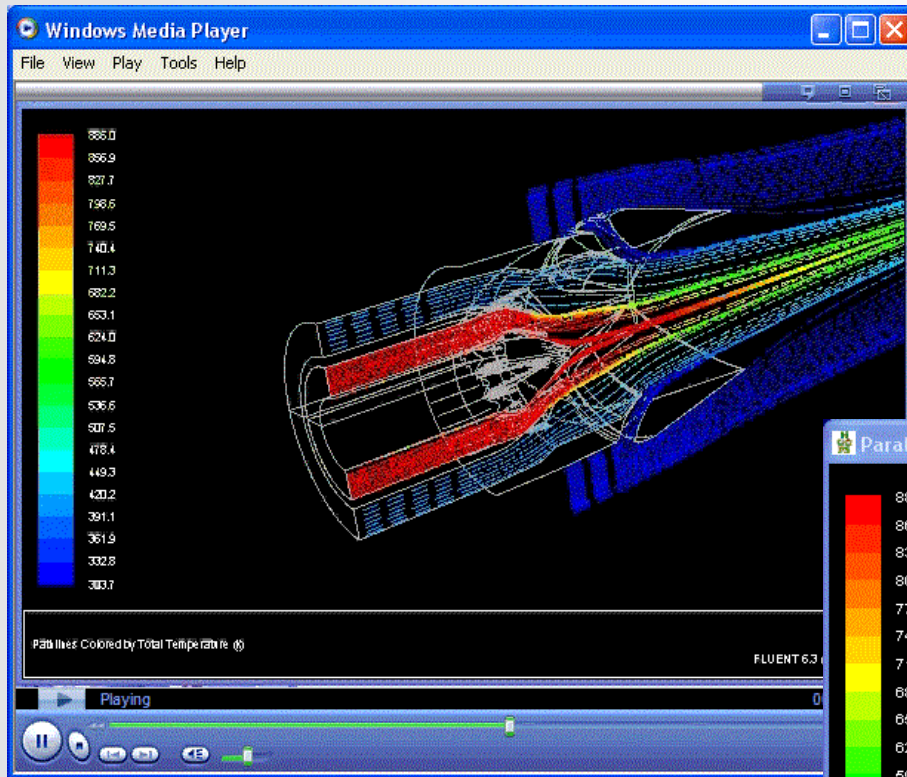

Current Nozzle Design

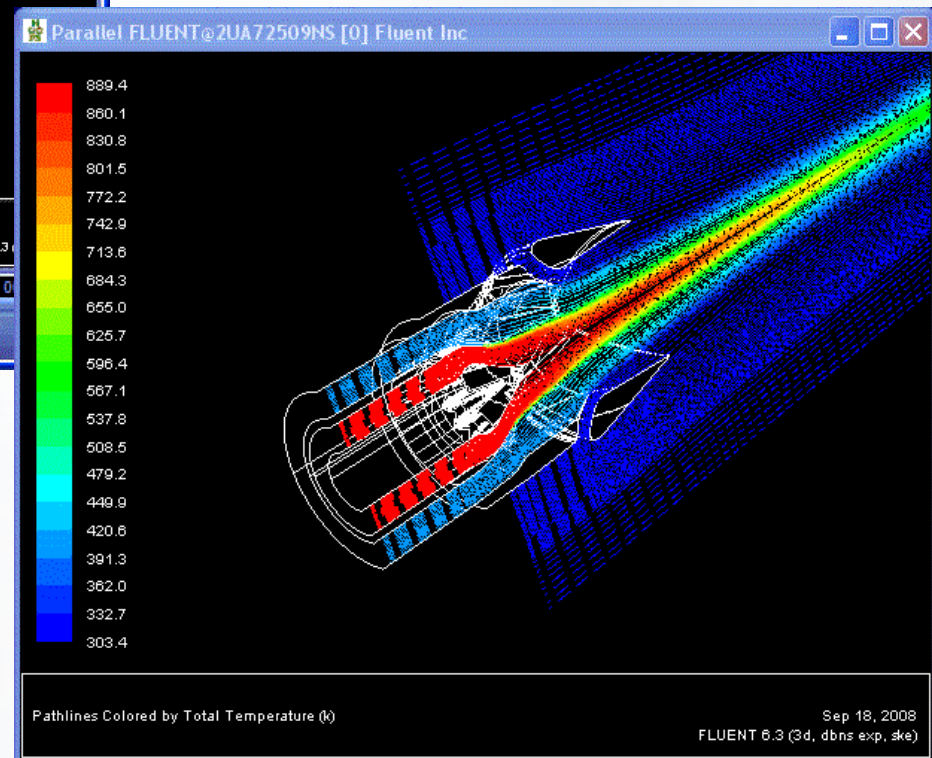

Rolls-Royce

Conclusions

- Analysis of Rolls-Royce Variable Geometry SS Nozzle shows improved noise suppression features during Take-off
 - Low Mach numbers in throat region
 - Adequate ejector flow for plume suppression with minimum flow separation, turbulence decay and efficient mixing
 - Small improvement from ejector flow passage
- The scaled model nozzle design can proceed with the current configuration improvements.



Rolls-Royce