

The Gravity Probe B EXPERIMENT

"Testing Einstein's Universe"



LOCKHEED MARTIN



The Enigma of Gravity

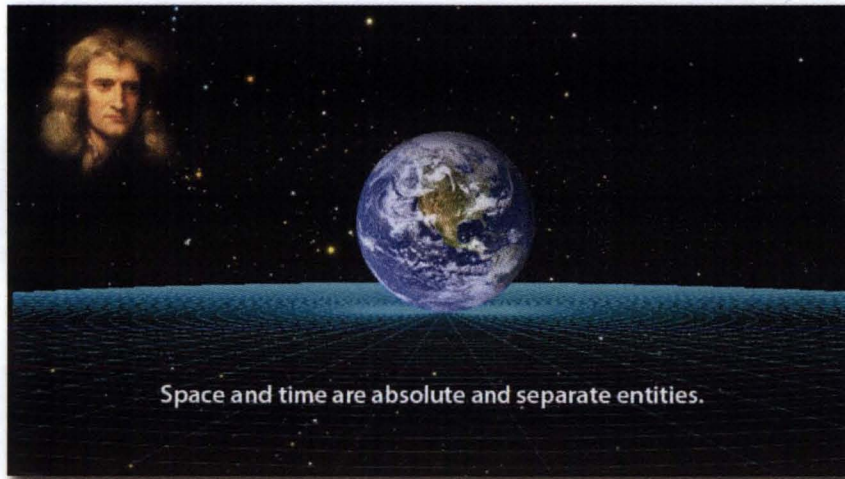

Sir Isaac Newton:

Space and time are absolute or fixed entities. Gravity is a force that acts instantaneously between objects at a distance, causing them to attract one another.

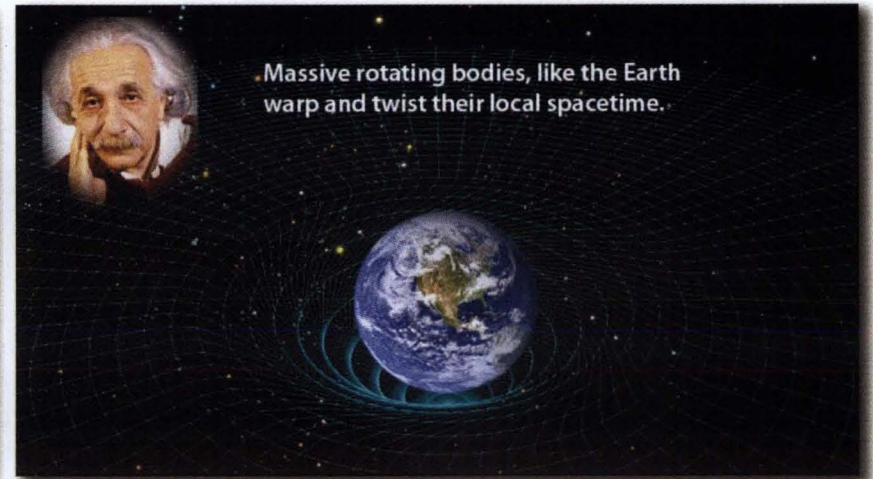

Albert Einstein:

Space and time are relative entities, interwoven into a spacetime fabric whose curvature we call gravity. Spacetime tells matter how to move, and matter tells spacetime how to curve.

A “Simple” Experiment

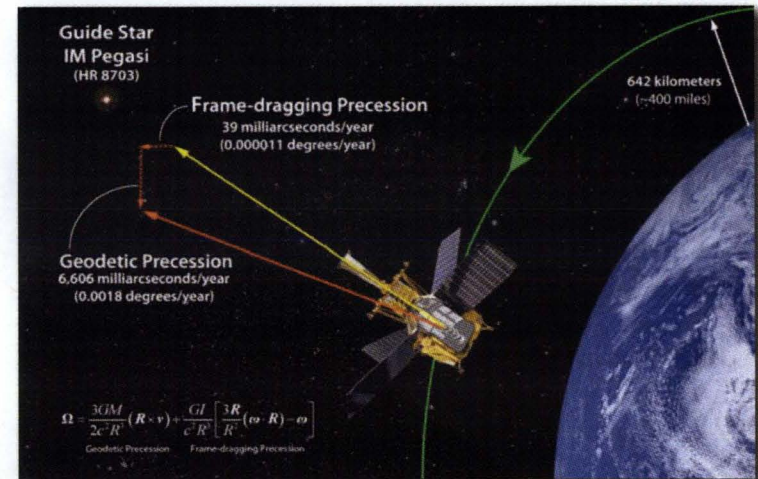
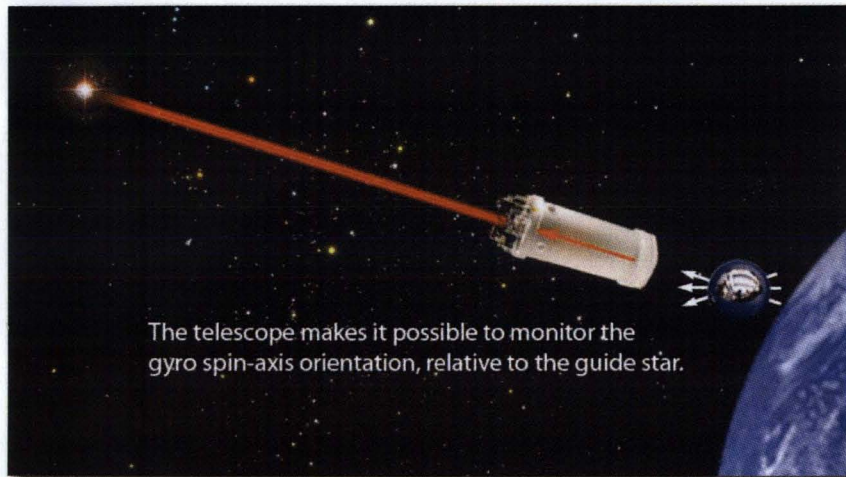

GP-B Co-Founder, Bill Fairbank, once remarked: “No mission could be simpler than GP-B; it’s just a star, a telescope and a spinning sphere.” However, it took over four decades to develop all the cutting-edge technologies necessary to carry out this “simple” experiment.

Ultra-Precise Gyroscopes

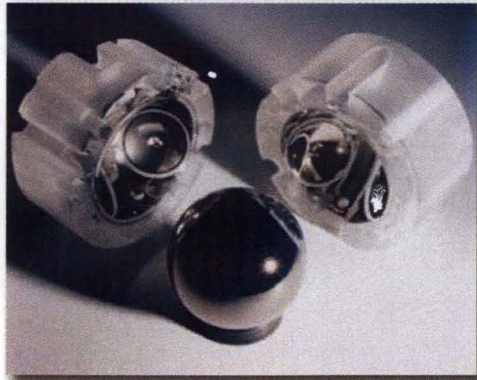
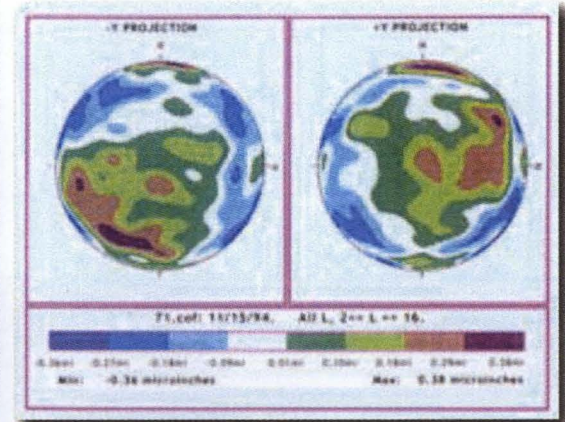
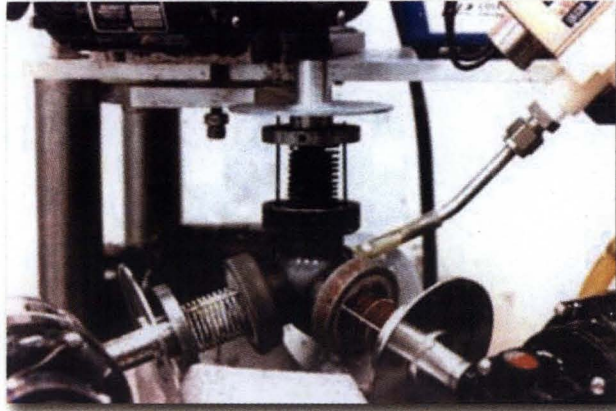

To measure the minuscule angles predicted by Einstein's theory, it was necessary to build near-perfect gyroscopes ~50 million times more precise than the best navigational gyroscopes. The GP-B gyro rotors are listed in the Guinness Database of World Records as the most spherical man-made objects.

SQUID Magnetometers

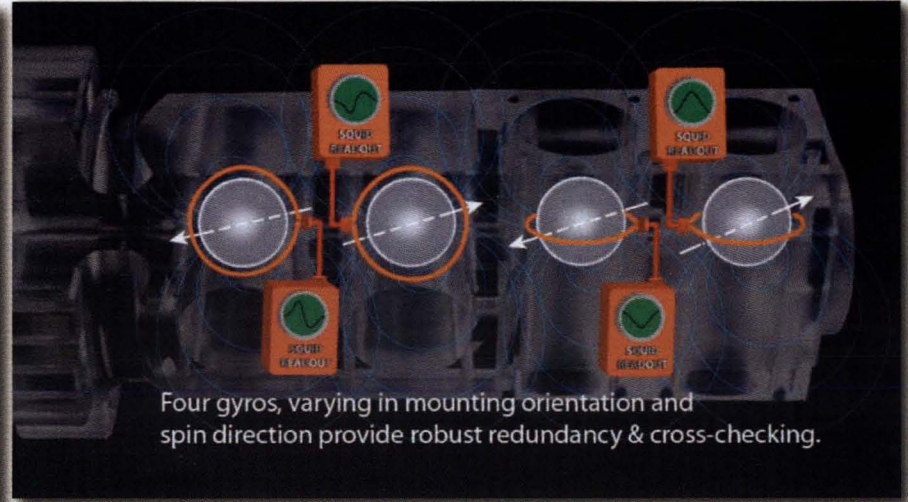
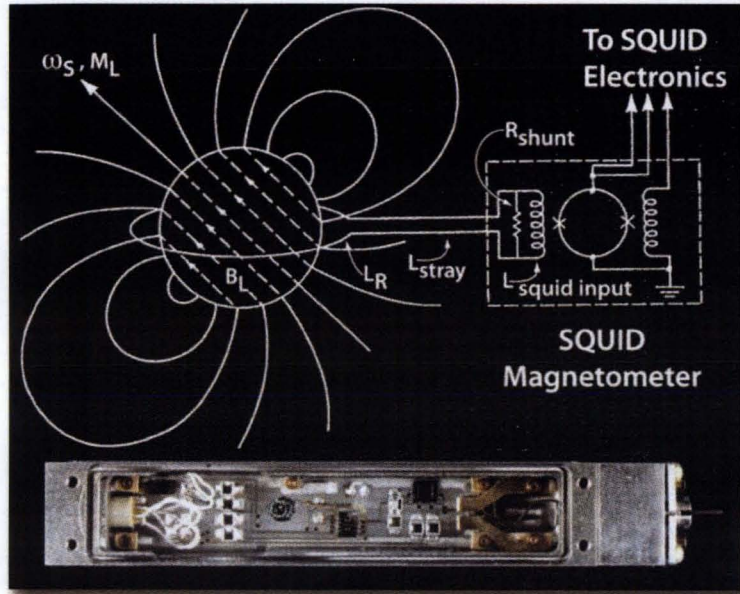

How can one monitor the spin-axis orientation of a near-perfect spherical gyroscope without any physical marker showing the location of the spin axis on the gyro rotor? The answer lies in superconductivity.

Predicted by physicist Fritz London in 1948, and most fortunate for GP-B, a spinning superconductor develops a magnetic moment exactly aligned with its spin axis.

Pointing Telescope

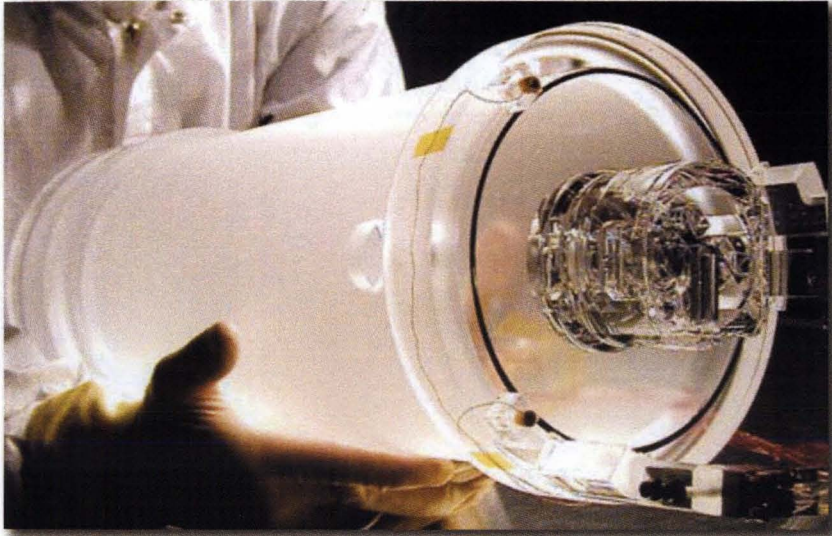

A telescope mounted along the central axis of the dewar and spacecraft provided the experiment's pointing reference to a "guide star." The telescope's image divider precisely split the star's beam into x-axis and y-axis components whose brightness could be compared.

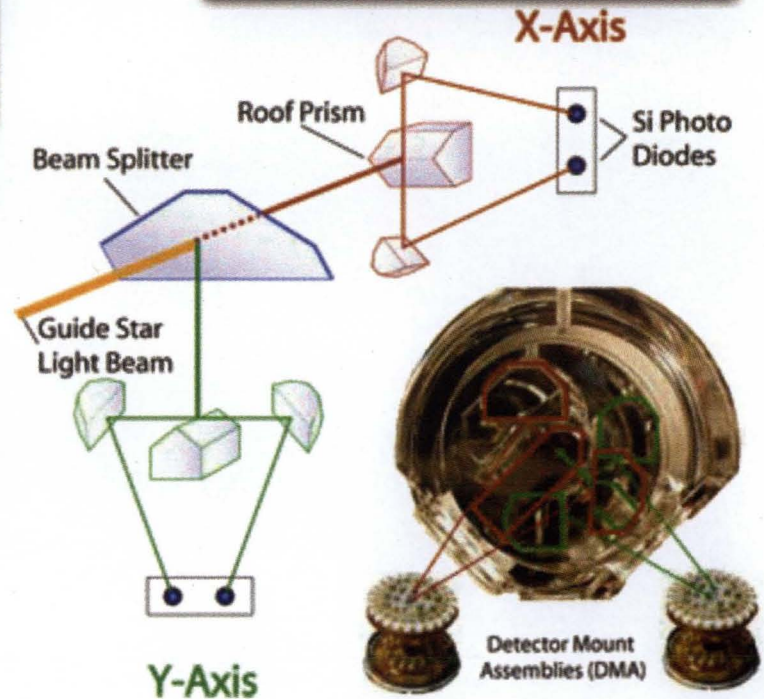
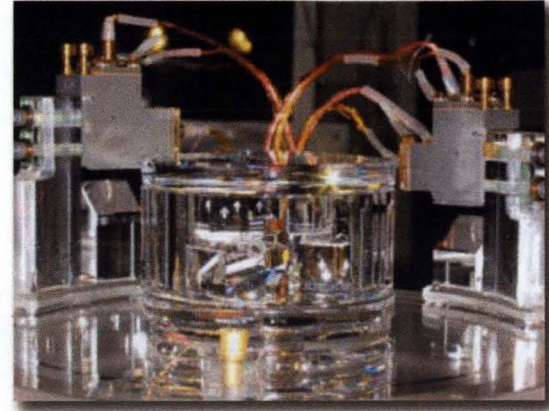

Dewar & Probe

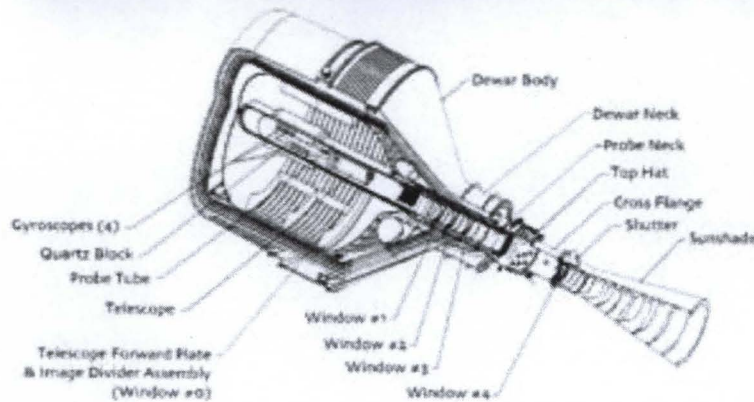
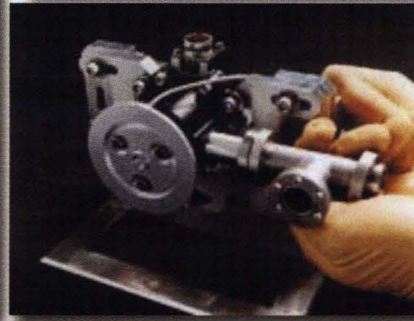
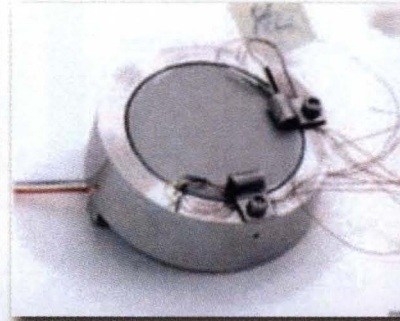

GP-B's 650-gallon dewar, kept the science instrument inside the probe at a cryogenic temperature (2.3K) for 17.3 months and also provided the thruster propellant for precision attitude and translation control.

Integrated Payload & Spacecraft

Built around the dewar, the GP-B spacecraft was a total-integrated system, comprising both the space vehicle and payload, dedicated as a single entity to experimentally testing predictions of Einstein's theory.

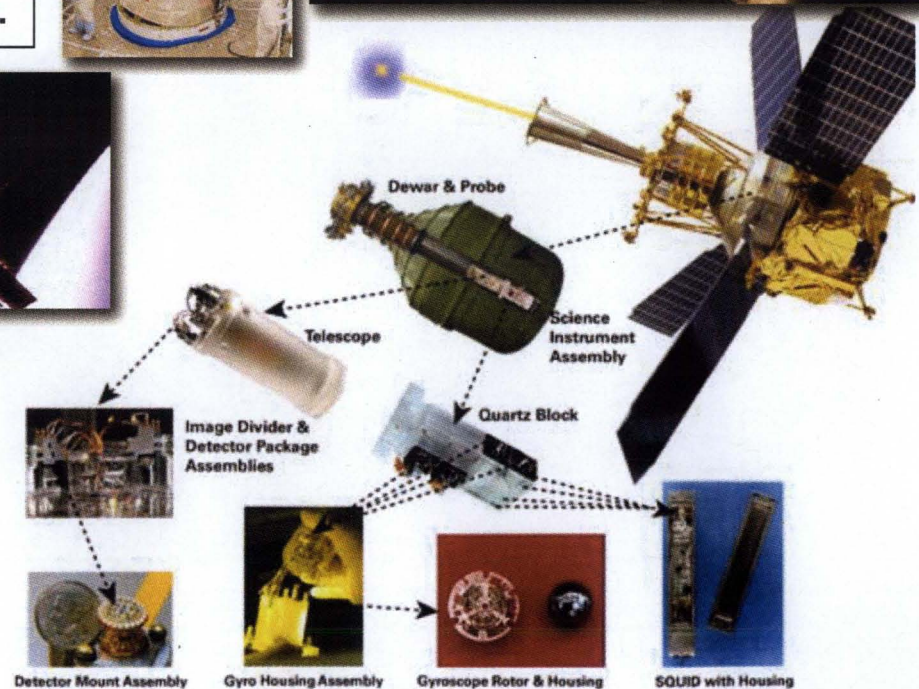
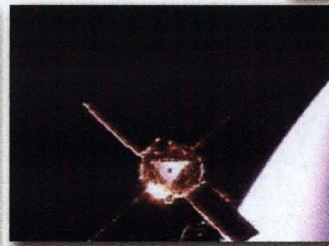
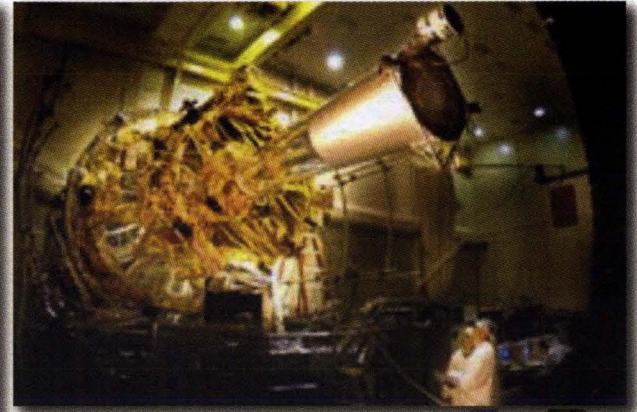

A Collaborative Effort

The success of GP-B required extraordinary collaboration between the Physics and Aero-Astro departments at Stanford and between Stanford, NASA, and Lockheed Martin. In 2005, NASA gave a Group Achievement Award to the entire GP-B team.



Horn, Mary T. (MSFC-NAS802002)[MAINTHIA]

From: Kolodziejczak, Jeffery (MSFC-VP62)
Sent: Tuesday, April 01, 2008 10:48 AM
To: Horn, Mary T. (MSFC-NAS802002)[MAINTHIA]
Subject: Presentation in Birmingham 4/5/08

Attachments: GP-B_nutshell_slideshow.pdf



GP-B_nutshell_slide
show.pdf (8...

Hi Beth,

I'm giving an invited talk at the event given below.
It's a nontechnical public talk on GPB and General Relativity.

The presentation material has been downloaded from public websites.
The slides are attached.

I'll also be showing animation clips from:
<http://einstein.stanford.edu/Media/>
(first 8 clips listed on this site.)

Jeff K.

> Richard Phelps
> Program Coordinator
> Central Alabama Mensa
> Regional Gathering Committee

>
> Jeff Kolodziejczak

>
> Dear Jeff

>
> Thank you for agreeing to speak at the upcoming "Owlabama Blast," the annual Regional Gathering of Central Alabama Mensa. Here are some details.

>
> Each Speaker will receive a day pass to all activities including meals and 24-hour Hospitality suites. We want you to feel welcome to stay all day and participate in as much as compels your interest.

>
> I am in the process of arranging the schedule now. There are ten to fourteen time slots for speakers--two each Friday night and Sunday morning, and the remainder during the day Saturday. I am scheduling you for 11:00 am Saturday, April 5, 2008. As I said, I plan to arrange a projector for Power Point.

>
> Here is a description of the Regional Gathering, or RG, as we call it, reprinted from the Central Alabama Mensa website (<http://centralalmensa.org/index.html>):

> The Owlabama Blast

> "The Best of Region 5 (and Destin)"

> April 4 - 6, 2008

> Alta Vista Hotel and Conference Center Birmingham, Alabama Join us for

> the 21st annual Owlabama Blast - A relaxing good time is our goal. We are changing things up this year. We are retaining the great karaoke and dance activities that you would expect from Birmingham. From Destin there will be a chocolate orgy. From Atlanta is the movie room. Huntsville supplied the idea for sex trivia. The gift exchange is from South Carolina. In addition to the best of each gathering, there will be a vendor and events room. The vendors are self-explanatory. The events will keep everyone supplied with activities the entire weekend. For participating there will be tickets given for raffles. You have never seen a regional gathering quite like this one will be.

>
> This is reprinted from the American Mensa website (<http://www.us.mensa.org/>):

>
> "American Mensa
> "The organization for smart people like you
>
> "With more than 50,000 members, American Mensa is the largest national Mensa operating under the auspices of Mensa International, Ltd. There are currently more than 100,000 members worldwide, and an estimated six million Americans are eligible for Mensa membership.
>
> "Members of American Mensa range in age from 4 to 100. They include engineers, homemakers, teachers, actors, athletes, students and CEOs, and they share one trait — high intelligence. To qualify for Mensa, they scored in the top 2 percent of the general population on an accepted standardized intelligence test.
>
> "As a member, you have an opportunity to meet other smart people at local, regional and national levels. You can attend entertaining events and exchange your ideas with others through a variety of publications. You can also work to help others in your community by volunteering for community-oriented activities and working with the Mensa Education and Research Foundation's scholarship program."
>
> Thanks again. I am looking forward to hearing you. The fastest way to contact me is by cell phone: 256-310-4022.
>
> Sincerely,
>
> Richard Phelps
> 256-310-4022
> redbassguitar@yahoo.com
> 142 Echo Hill Trail
> Jacksonville, Alabama 36265
>