

1110FC-000

# Automated Eddy Current Inspection on Space Shuttle Hardware

John Hartman and Jeremy Felker

ATK Launch Systems Group

P.O. Box 160362, M/S 640, Clearfield, UT 84016-0362

(435) 863-4516; fax (435) 863-4599; email [john.hartman@atk.com](mailto:john.hartman@atk.com)

(435) 863-4555; fax (435) 863-4599; email [jeremy.felker@atk.com](mailto:jeremy.felker@atk.com)

## INTRODUCTION

Over the life time of the Space Shuttle program, metal parts used for the Reusable Solid Rocket Motors (RSRMs) have been nondestructively inspected for cracks and surface breaking discontinuities using magnetic particle (steel) and penetrant methods. Although these inspections adequately screened for critical sized cracks in most regions of the hardware, it became apparent after detection of several sub-critical flaws that the processes were very dependent on operator attentiveness and training. Throughout the 1990's, eddy current inspections were added to areas that had either limited visual access or were more fracture critical. In the late 1990's, a project was initiated to upgrade NDE inspections with the overall objective of improving inspection reliability and control. An automated eddy current inspection system was installed in 2001. Figure 1 shows one of the inspection bays with the robotic axis of the system highlighted. The system was programmed to inspect the various case, nozzle, and igniter metal components that make up an RSRM, both steel and aluminum. For the past few years, the automated inspection system has been a part of the baseline inspection process for steel components. Although the majority of the RSRM metal part inventory is free of detectable surface flaws, a few small, sub-critical manufacturing defects have been detected with the automated system. This paper will summarize the benefits that have been realized with the current automated eddy current system, as well as the flaws that have been detected.

## BENEFITS OF THE AUTOMATED EDDY CURRENT SYSTEM

### Reliability

The primary reason for implementing the automated system (named AIIS for Automated Inductive Inspection System) was to increase the overall reliability of the inspection process. Simply put, reliability can be defined as the assurance that critical sized flaws will be detected. There are several factors that contribute to (and some synonymous with) inspection reliability.

### Control & Repeatability

The AIIS is a sensor-based, robotic system and therefore has a great deal of control and repeatability, which is highly valued when working in the space program. All components and probes, some of which are shown in figure 2, are documented and controlled on tooling drawings. All RSRM parts are initially programmed and inspection coverage of required surfaces is verified. These programs and all associated software are controlled through a software configuration control procedure, assuring that all required surfaces are inspected the same way each time. The sensors are calibrated, assuring a measurable and consistent level of sensitivity and response. All calibration and detection "thresholds" are traced back to extensive Probability of Detection (POD) testing performed on actual cracks. This helps ensure that the required flaw sizes will be detected with a high level of statistical probability and confidence.

Although inspector variability is never fully eliminated, it is greatly reduced with the AIIS. The inspectors primary responsibility is to insure that "good" data is collected (no unexpected lift-off, digital acquisition problems, etc), reviewed for cracks, and archived. Review of data for cracks is both by visual review of C-scans, with color coding corresponding to decision thresholds, and by review of results from computer algorithms that scan the data for crack-like signals. All of these factors help insure that multiple scans of a given part will produce repeatable data, with very high confidence that the flaw as large as or larger than the requirement will be found.

### Sensitivity

In a statistical sense, the sensitivity of an inspection could be defined as its Minimum Detectable Flaw Size (MDFS), or the flaw size that is detected with a 90% probability (and 95% confidence level). The smaller the MDFS, the

more reliable the system becomes at screening critical sized flaws. The POD for the eddy current system produces a smaller MDFS than the POD of the magnetic particle inspection process<sup>(1,2)</sup> and is therefore more statistically reliable at detecting the required flaws. As will be seen, flaws that have been detected on flight hardware have been significantly smaller than the MDFS for a given area, which illustrates the conservatism built into the calibration process.

### Data Archiving

The AIIS allows for the storage and archiving of all inspection data. Because the metal hardware is reusable, this can allow for trending of unusual material conditions. Also, if cracks are detected, historical data can help determine the nature of the flaw (manufacturing flaw vs. service induced). Data is stored on an intranet server and can be easily accessed.

### Reduction of Solvent Wastes

With the historical magnetic particle and penetrant processes, the inspection of large scale components produced lots of chemical & solvent waste. This includes an acid etch bath that has to be maintained for inspection of aluminum nozzle components. Disposal and maintenance of these materials requires extensive attention to insure compliance with safety procedures and environmental codes.

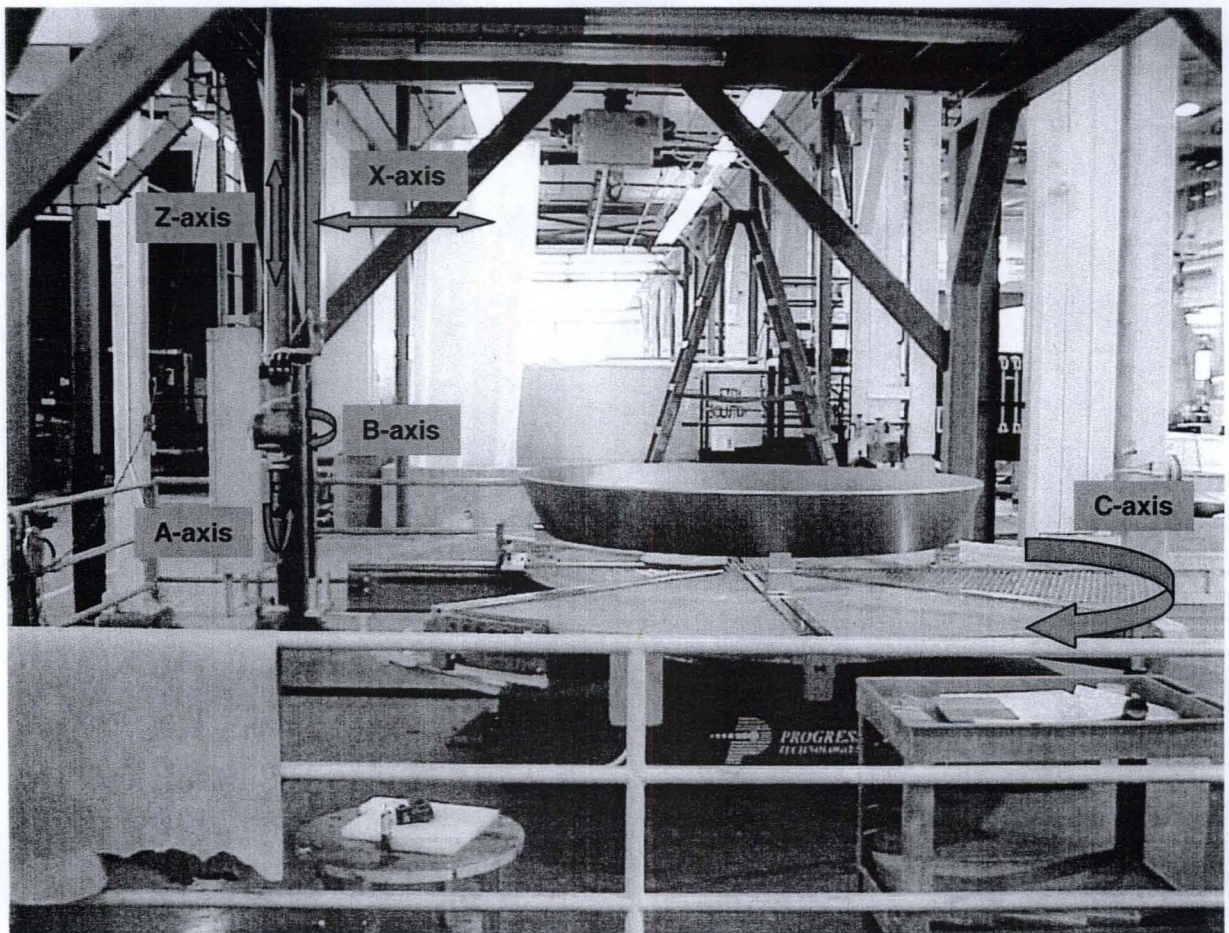

Figure 1: AIIS Bay for Nozzle, Igniter & Dome Hardware

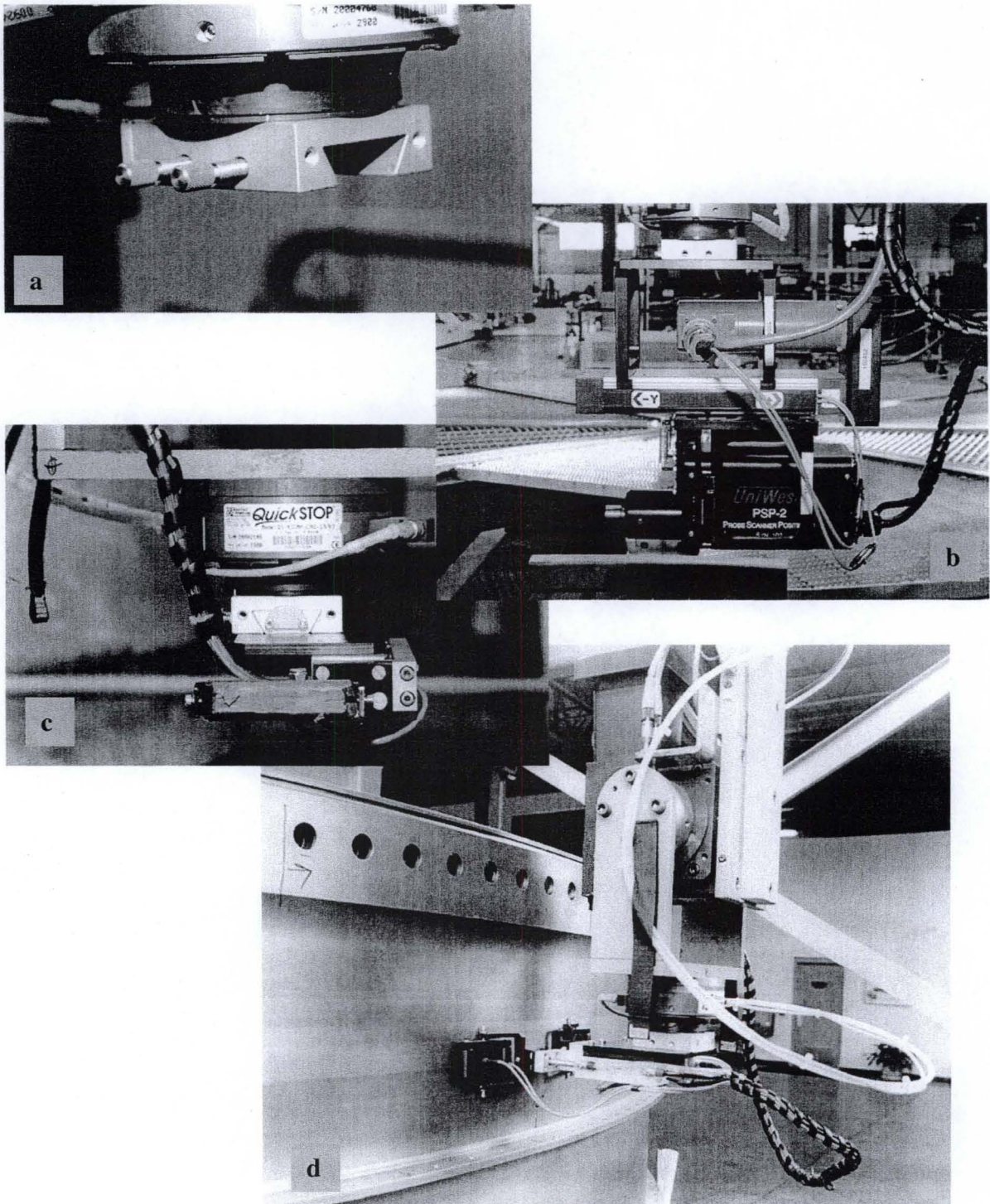

Figure 2: Various elements associated with AIIS: a) Dovetail joint to mount inspection sleds, b) mounted hole scanner, c) sled for "skiing" over holes, and d) sled for large acreages.

## FLAWS DETECTED ON RSRM METAL HARDWARE

AIIS has been inspecting hardware now for several years, along side the baseline magnetic particle and penetrant processes. Currently, approximately 40% of the RSRM steel hardware inventory has been inspected with AIIS. During initial implementation, it was expected that the metal hardware as a whole was quite healthy. The reason is that all metal components are refurbished after each Space Shuttle flight. Refurbishment primarily consists of inspecting the hardware to insure it complies with engineering requirements. This includes a complete Nondestructive Evaluation (NDE) inspection to screen the hardware for surface discontinuities. The vast majority of components have gone through several refurbishment inspections. Therefore, if any manufacturing flaws existed in a component after its fabrication, they would most likely have been detected previously with magnetic particle or penetrant (or with localized eddy current that is performed on select hardware features). Service-induced stress corrosion cracks primarily occur on select features of the booster aft segment and are due to splashdown loads.

The expectation, then, was that if flaws were to be found, they would be smaller than the reliably detectable flaw size for the magnetic particle or penetrant inspections. This has turned out to be the case. At this point in time, seven of the components out of over 320 inspected were found to have small surface or near-surface discontinuities (cracks or very thin inclusions near or at the surface). Three were aluminum (same component type), and four were steel (three component types). Table 1 summarizes the findings. Of the seven components, 2 were new parts (first time inspection), while the rest were on multiple refurbishments (i.e., had been inspected before, sometimes up to as many as 6 or 7 times). All detected flaws were manufacturing defects. Interestingly, the very first part inspected (a brand new aluminum Nose Inlet Housing, which is part of the nozzle assembly) was found to have several surface discontinuities (long shallow cracks that looked to have some foreign material or impurity associated with them). Until recently, none of the case hardware components (part of the primary pressure vessel) were found to have flaws. Earlier this year, however, a cylinder was inspected and found to have 12 small cracks in the ID membrane/acreage regions. These flaws are summarized in Figure 3. Figures 4 through 6 show representative eddy current C-scan images of cracks found in various parts. The C-scan images incorporate a gray scale color palette with color coded "decision thresholds" correlating to acceptance criteria. A blue indication corresponds to a circumferentially oriented flaw, while a magenta indication corresponds to a longitudinally oriented flaw.

**Table 1: Summary of cracks detected on RSRM metal hardware.**

Component	Cracks detected	Approx. sizes	Unique features	Action taken
Nozzle/Nose Inlet Housing (3 parts)	Multiple – over 20 among all 3 parts. All cracks were on the OD membrane surface, running circumferentially	Typically long and shallow Depth: shallow, less than 0.030" many around 0.010"-0.020" Length: between 0.10" to ~0.75"	Most all of the flaws were in conjunction with pitting (even one part that was brand new). Discontinuities continued down below the pitting	Flaws blended out
Nozzle/Forward Exit Cone	Two on a flange surface. New part, first time inspected	Very small, <0.10" long and <0.005" deep.	Machined smooth surface, found in region calibrated for higher sensitivity	Flaws blended out.
Igniter chamber (2 parts)	Multiple – on same surface of each part; mostly circumferential	Largest approximately 0.150" long by 0.050" deep	All flaws found on a smooth machined surface. Unable to visually detect.	Largest was blended out on one component (component was scrapped. Other component is used as test article)
Cylinder	12 – ID membrane; circumferential & longitudinal orientations.	All very small (well below detection requirement for that area - see table 2).	All manufacturing flaws. Part was on 6 <sup>th</sup> refurbishment. Unable to visually detect.	All cracks were verified with local MT and blended out.

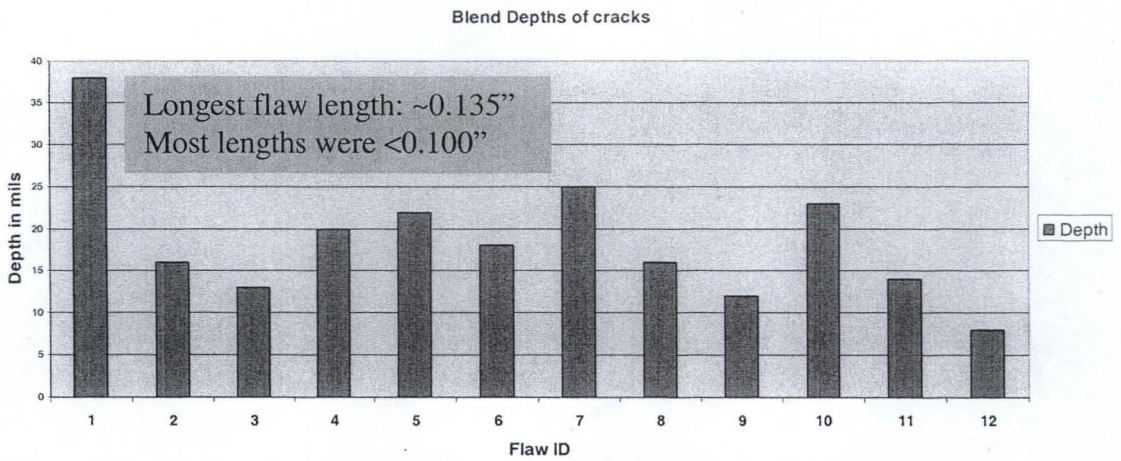

Figure 3: Summary of crack dimensions found on cylinder.

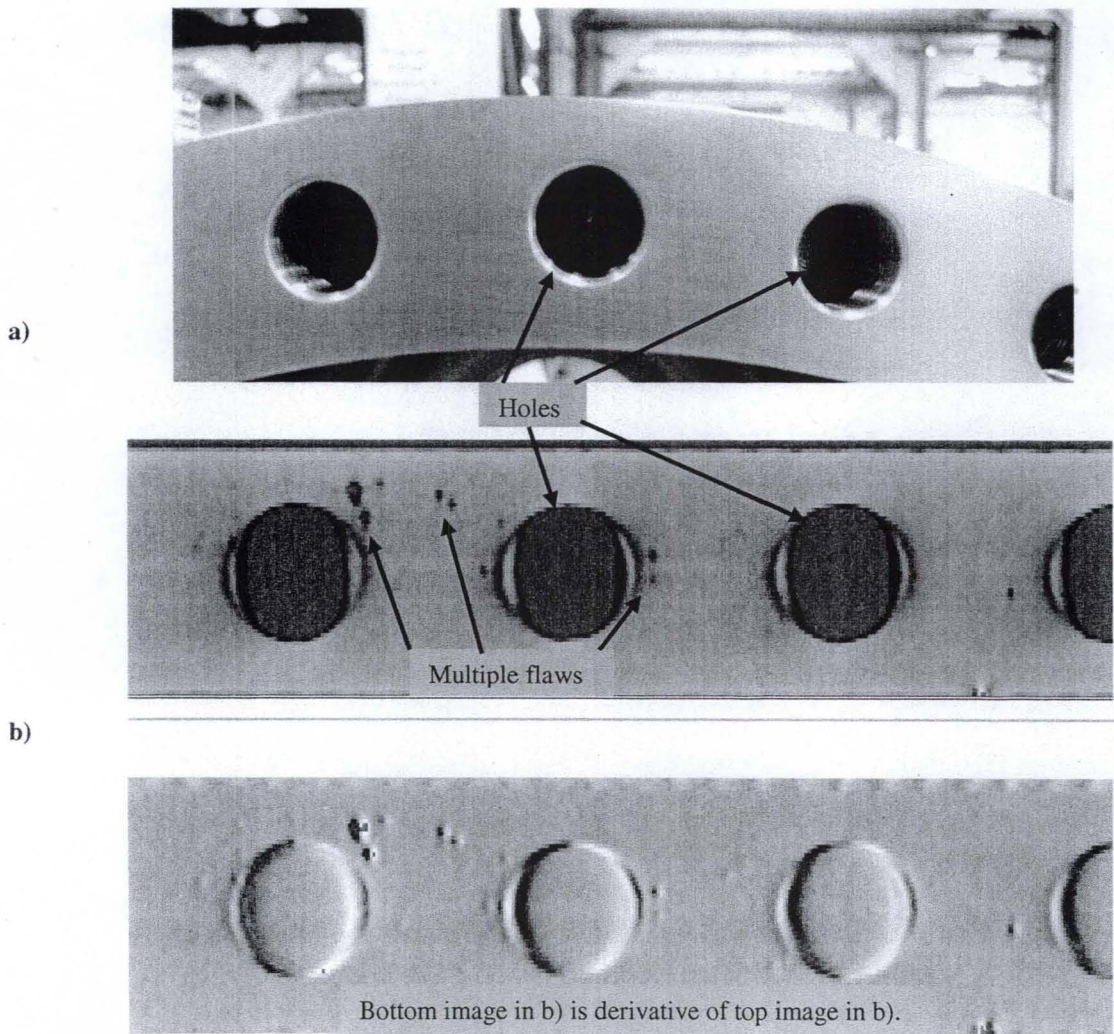

Figure 4: a) Igniter chamber boss with 3/4" threaded holes, b) C-scan images of eddy current data from the same surface on a different chamber.

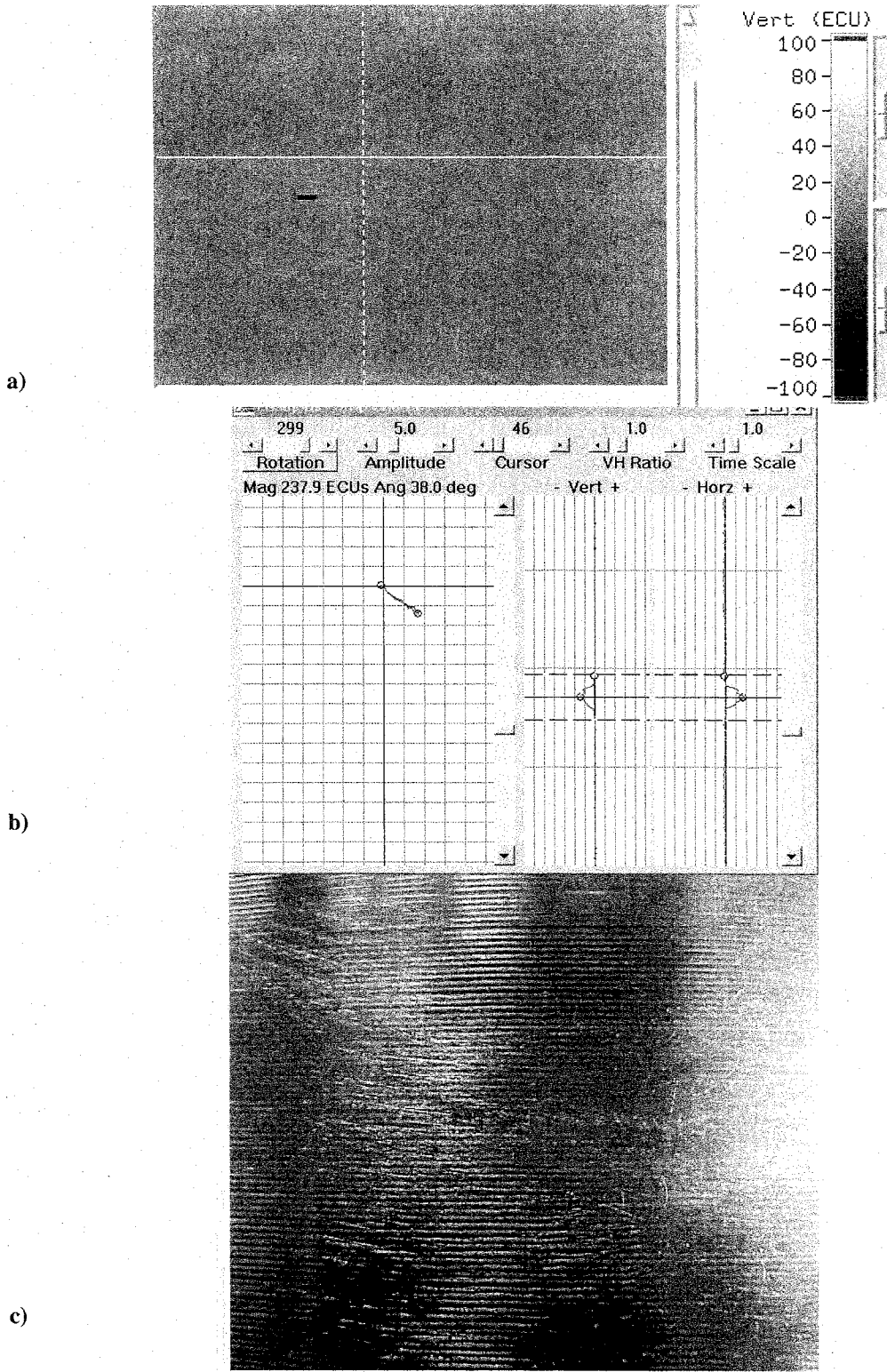

Figure 5: Inspection of an Aluminum Nose Inlet Housing - a) C-scan of circumferential flow, b) corresponding impedance plane & strip chart data, c) photo of the flawed area (defect extended ~ 15 mils below the surface pitting).

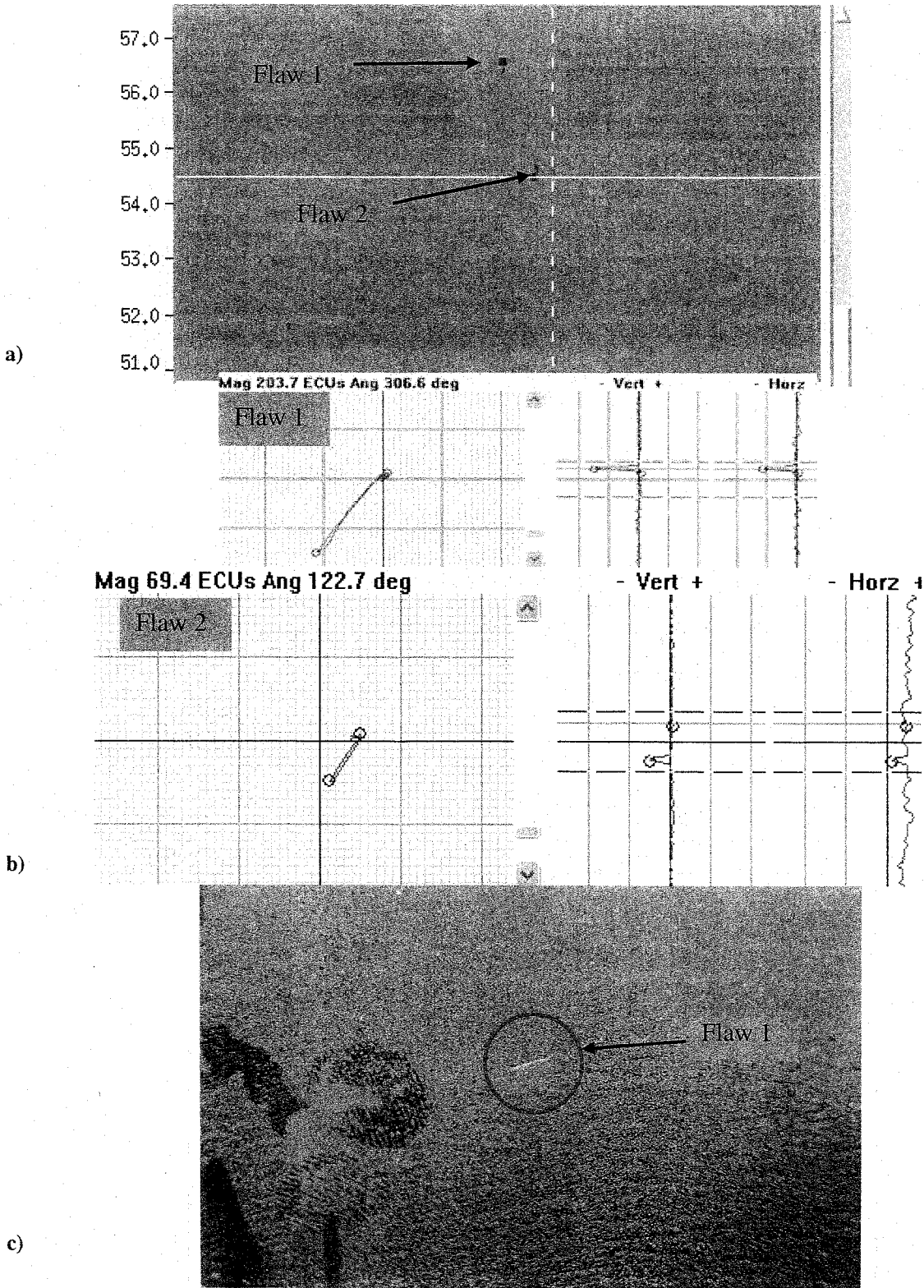

Figure 6: Cracks on cylinder ID: a) eddy current C-scan, b) impedance plane data of cracks, c) mag particle image of largest crack.

## **SUMMARY**

An automated eddy current inspection system has been implemented for inspection of Space Shuttle RSRM metal hardware. The NDE aspects of the system were thoroughly characterized through POD testing prior to and after installation. Current findings on RSRM hardware are consistent with expectations, and provide evidence that the system is very reliable and capable of detecting the required flaw sizes.

## **REFERENCES**

1. Hartman and Hibbert, "Probability of Detection Results of Eddy Current Inspection for Ferromagnetic Space Shuttle Solid Rocket Boosters", *Paper Summaries of the 1995 ASNT Spring Conference and Fourth Annual Research Symposium*, Las Vegas, NV, 1995.
2. Hartman and Kirby, "Automation of NDE on Space Shuttle Solid Rocket Motor Metal Components", *Abstracts of the ASNT Spring Conference and 11<sup>th</sup> Annual Research Symposium*, Portland, OR, 2002.



# Automated Eddy Current Inspection on Space Shuttle Hardware

John Hartman  
Principal NDT Engineer  
(435) 863-4516  
john.hartman@atk.com  
Nov. 16, 2007



## Outline

### Outline

- Historical inspections on RSRM metal hardware
- Reasons for changing to an **Automated Inductive Inspection (eddy current) System (AIIS)**
- Brief overview of the system
- Inspection results on hardware since implementation

## Past NDE on Reusable Solid Rocket Motor (RSRM) Metal Hardware



RSRM Booster



3

## Historically, most NDE was visual based

- Magnetic Particle on steel parts

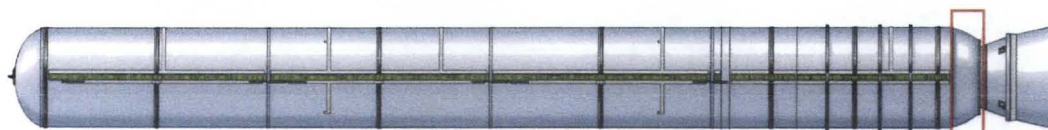

Case Components (Aft Dome)

4

Historically, most NDE was visual based

- Magnetic Particle on steel parts

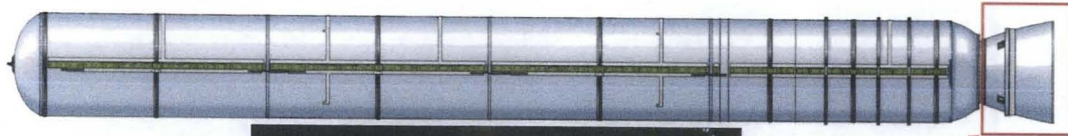

Nozzle Components – Throat Housing

Historically, most NDE was visual based

- Magnetic Particle on steel parts

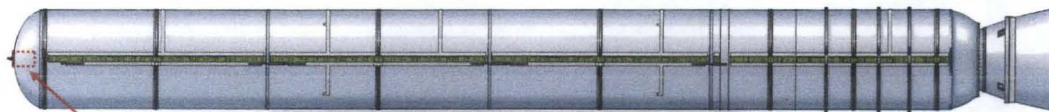

Igniter Components

Historically, most NDE was visual based

- Penetrant on aluminum nozzle parts



Nose Inlet Housing

Semi-automated and manual eddy current on critical or limited access areas

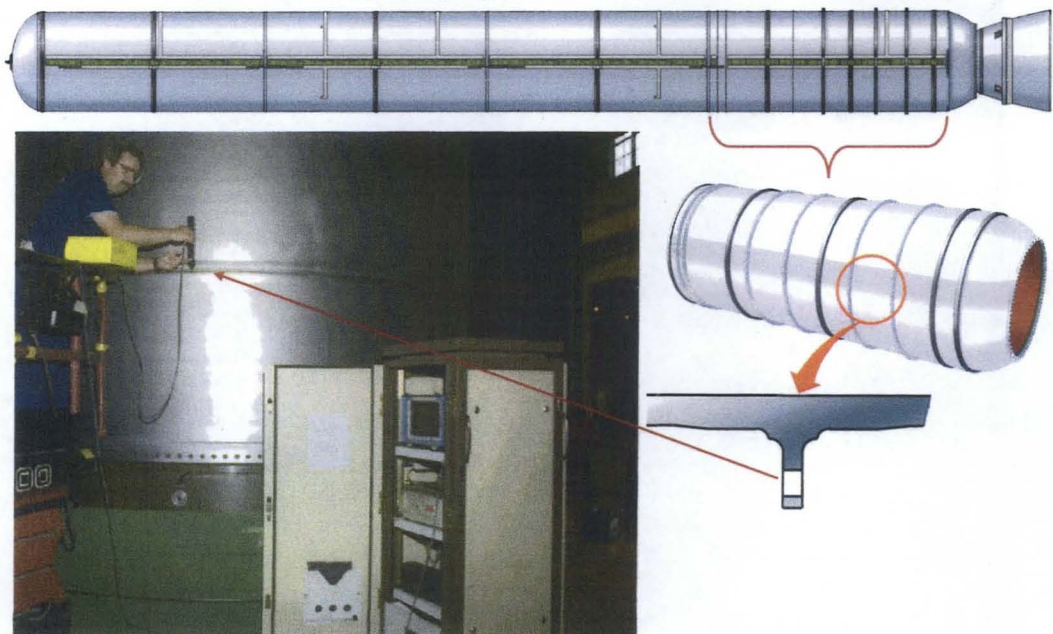

## Reasons for changing to AIIS

- Foremost is increased reliability, which could be defined as the assurance that critical sized flaws will be detected
  - Automation means that large metal parts are scanned the same way each time
  - Less dependency on inspector attentiveness
  - More **control**
- Overall sensitivity is increased (more sub-critical smaller flaws will be found)
- Archiving of data
  - “Proof” of Inspection – auditable
  - Possible trending ... helps to confirm the origin of a crack (manufacturing vs. service induced)
- Elimination or reduction of solvent wastes ... less environmental & safety concerns
  - Acid etch
- In 2000, funding was appropriated to build and install an AIIS

9

## Overview of AIIS

### Overview of the system

- Two inspection bays

H-7 bay for large case cylindrical parts

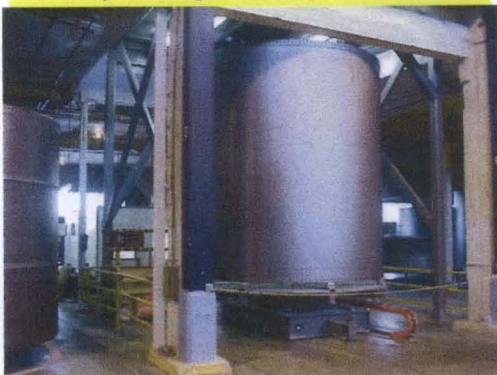

H-6 bay for smaller nozzle & igniter parts



10

## Overview of the system

- AIIIS integrates a 5 axis robotic system with an eddy current data acquisition system



11

## Overview of the system

- Close up of inspection wrist

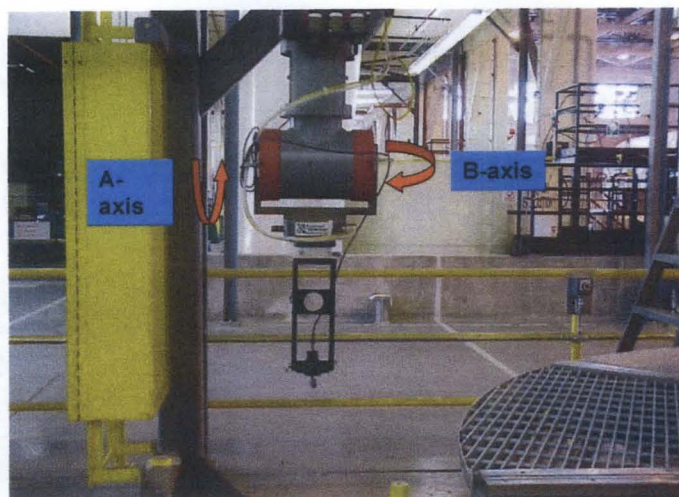

12

## Overview of the system

- For inspection of holes, a rotary scanner with linear drive is attached to the wrist (two additional axes of motion)

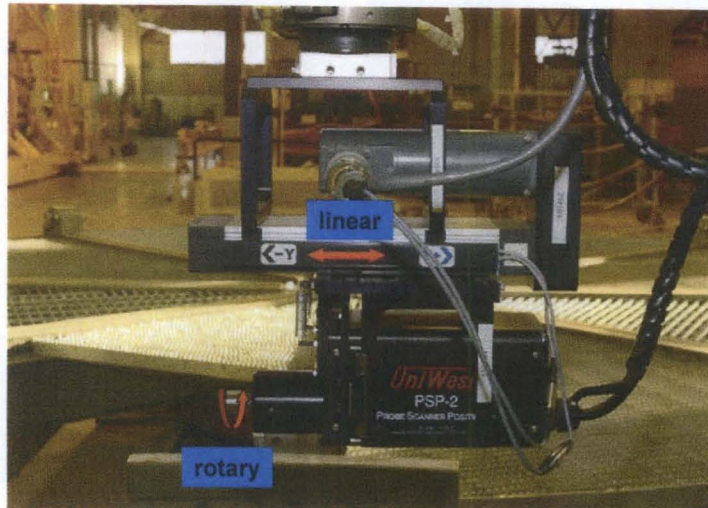

13

## Overview of the system

- The inspection turntable is on rails, and extends into the high bay for loading and offloading of components
- Components are mounted on adjustable chocks

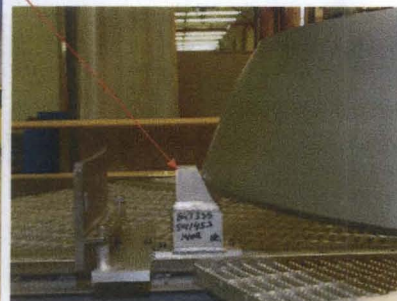

14

## Overview of the system

- Probes or inspection "sleds" used for different surfaces and geometries are mounted to the inspection "wrist" via a dovetail joint

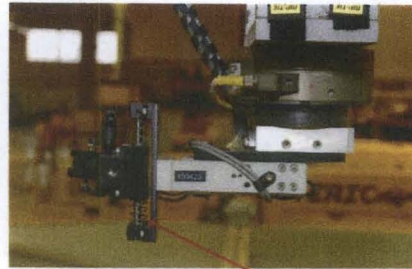

Pneumatic pressure and spring tension help insure compliance to part

## Overview of the system

- The primary inspector interface is a check-list based program
- Data is gathered on the part with each inspection sled, including calibration scans
- Data is reviewed by operator for cracks
  - Software tools help to flag crack-like responses
- After review, data is archived on an intranet storage system

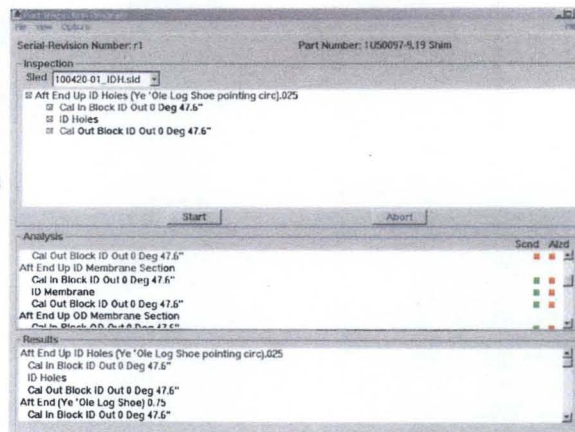



## Inspection Results on hardware

- AIIS has been inspecting metal hardware (mostly steel) for several years
- Inspections have been concurrent with historic mag particle & penetrant inspections
- Nearly 400 components have been inspected
- Most components inspected were refurbished, meaning they had been used and inspected more than once already

### **Expectation?**

- Overall, the majority of the hardware should be fairly healthy, having received multiple inspections over its lifetime
- If surface cracks were to be found, they would likely be smaller or shallower than the reliably detectable crack sizes for mag particle and penetrant determined from POD testing

17

## Inspection Results on hardware

- This turned out to be the case
- Most hardware was healthy
- Up to this point, only 8 components have been found with cracks or discontinuities
  - Four aluminum nozzle components
  - Four steel components
- All flaws detected, except for one aluminum component, were very small, sub-critical manufacturing flaws

18

## Inspection Results on hardware

### Aluminum Nose Inlet Housing (Nozzle Component)

- Three separate parts were found with shallow crack-like inclusions
- The very first part (a new part) inspected with the system was found to have several cracks
  - The part surface was machined and very smooth, but all the cracks were in conjunction with pitting (~0.005" deep)
  - Flaws were blended out – deepest was around 0.020"
- Two other refurbished Nose Inlet Housings have also been found with similar defects in the same region of the part,
  - The flaws were typically "long" (still less than 1") and shallow (deepest around 0.030")
  - They correlate with pitting
  - Some of the flaws were visually verified during removal (blending)
- All flaws were manufacturing flaws

19

## Inspection Results on hardware

### Aluminum Components - Nose Inlet Housing

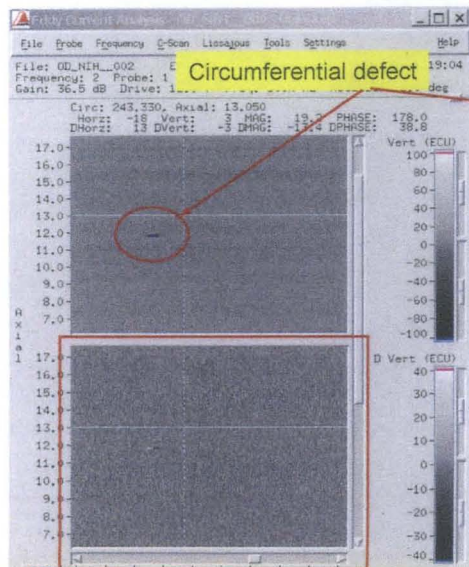

Bottom C-scan is filtered image of top C-scan

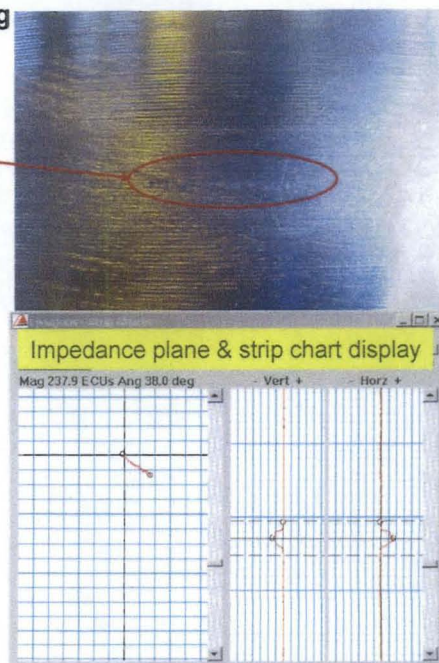

20

## Inspection Results on hardware

**Aluminum Components - Two other Nose Inlet Housings had similar circumferential defects in the same region (OD membrane). Also, an Aft Exit Cone was verified to have a corner crack (part was initially inspected with penetrant)**

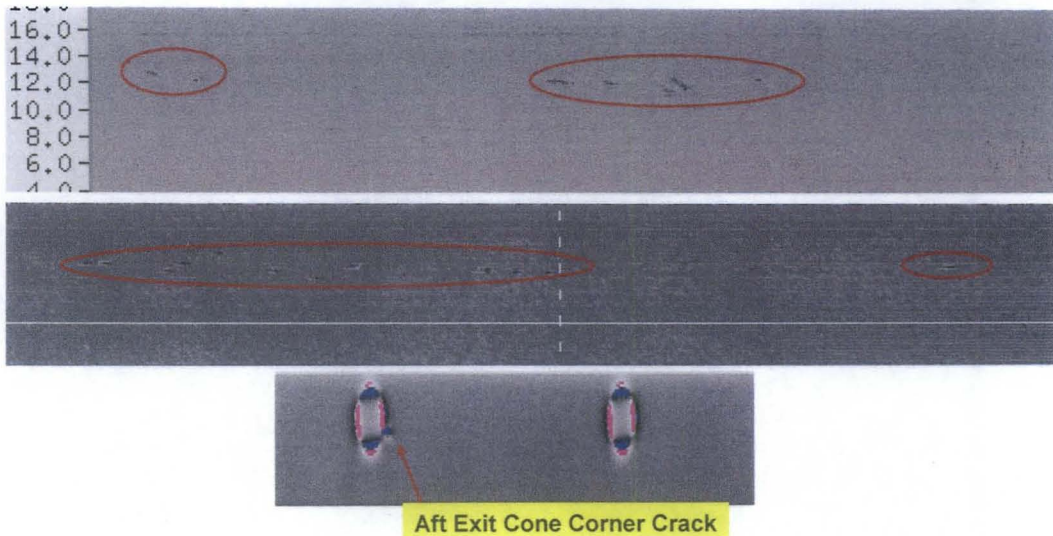

21

## Inspection Results on hardware

### **D6AC Steel Igniter Chamber**

- Two separate parts found with flaws in the same region
  - One chamber dedicated for flight, the other for testing

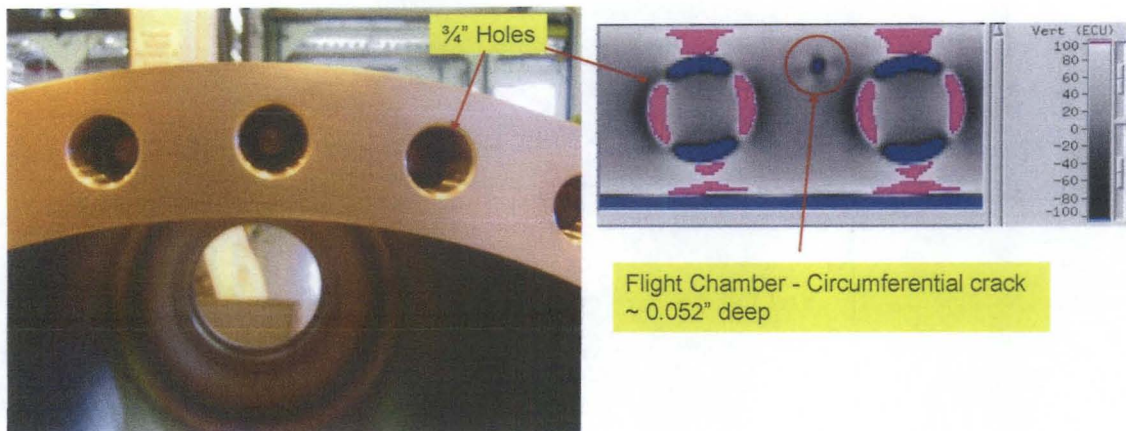

22

## Inspection Results on hardware

### D6AC Steel Igniter Chamber

- Test article

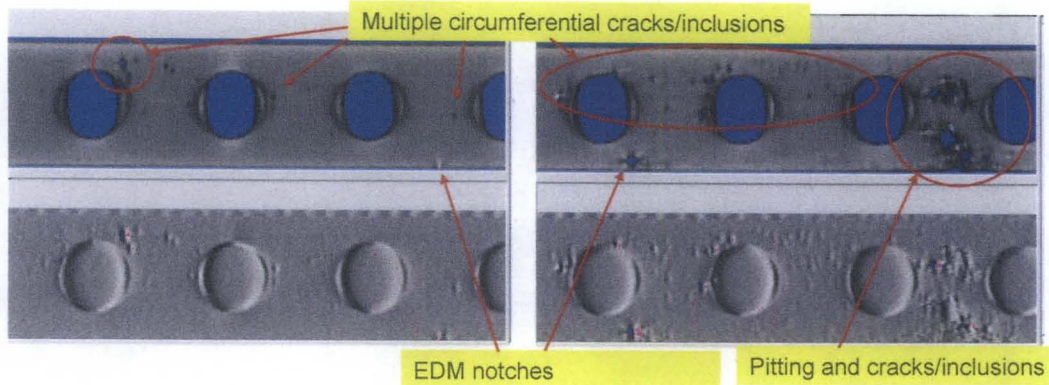

- Bottom images are the same as the top but they are filtered (differentially)

23

## Inspection Results on hardware

### D6AC Steel Forward Exit Cone (Nozzle Component)

- New component
- Detected several very shallow defects on a machined flange surface using a higher resolution probe
  - Confirmed visually & with mag particle
  - Blended out flaws – deepest was only 0.005"

24

## Inspection Results on hardware

### D6AC Steel Cylinder (Case Component)

- On it's 6<sup>th</sup> refurbishment (i.e., had been inspected multiple times over the years)
- Detected 12 small cracks on the ID membrane of the cylinder
- All cracks were manufacturing flaws with different orientations
- Lengths were on average around 0.100" or smaller (required detection level was 0.250" by 0.125" deep). Depths are summarized below

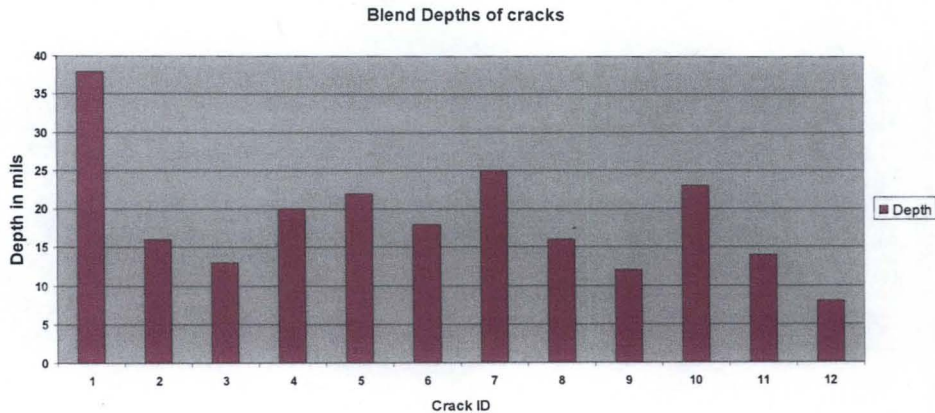

25

## Inspection Results on hardware

### D6AC Steel Cylinder (Case Component)

- All cracks were eventually confirmed with local mag particle and pencil probe eddy current inspections
- Examples of C-scan images from AIIIS and wet fluorescent mag images are shown on the following charts

26

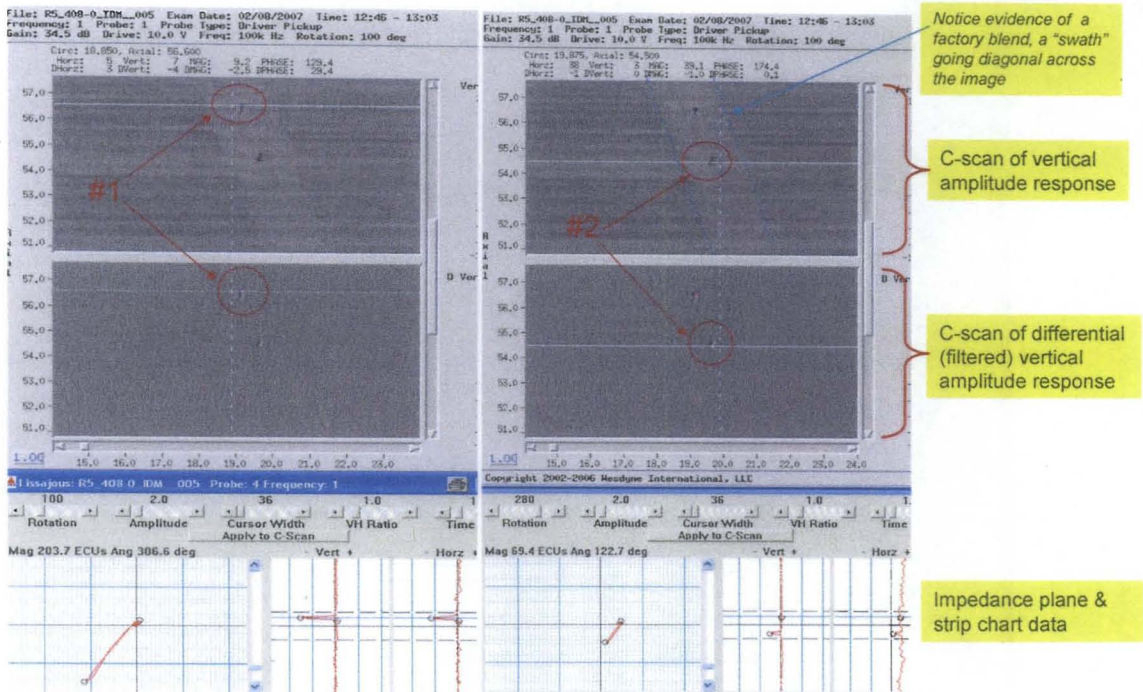

27

**Crack #1: Mag image of crack using portable yoke with wet fluorescent spray**



28

## Crack #2: Mag image of crack using portable yoke with wet fluorescent spray

Note: Edge of blend "swath"  
Roll band lines are ~0.040" apart

Roll Bands  
~0.040" apart

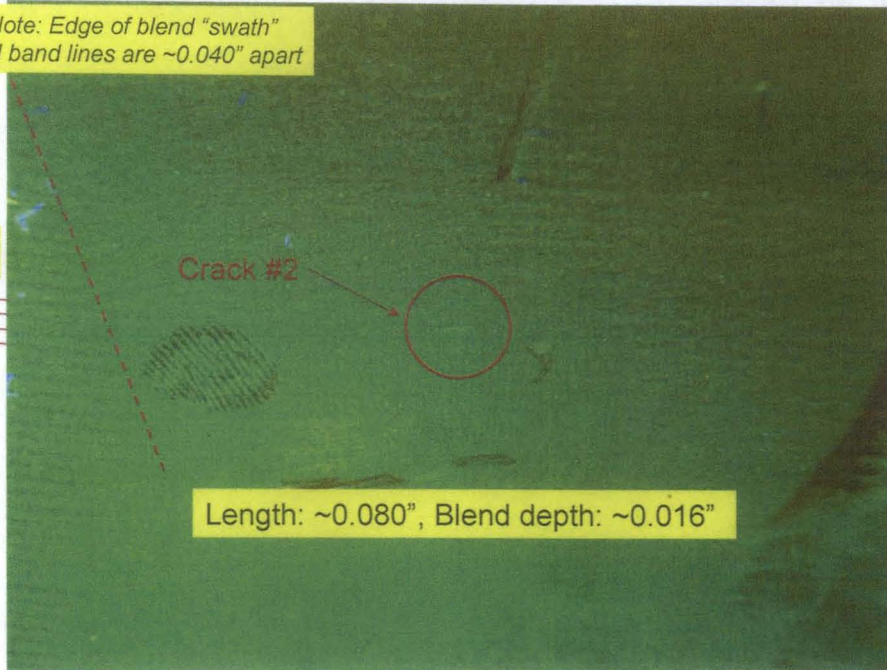

## Crack #3: AIIIS eddy current data

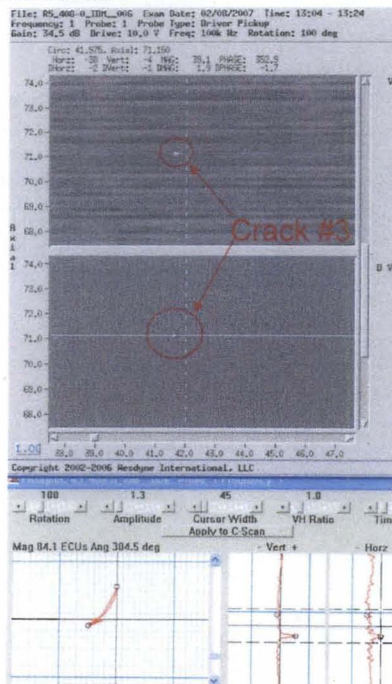

## Crack #3: Wet fluorescent mag image

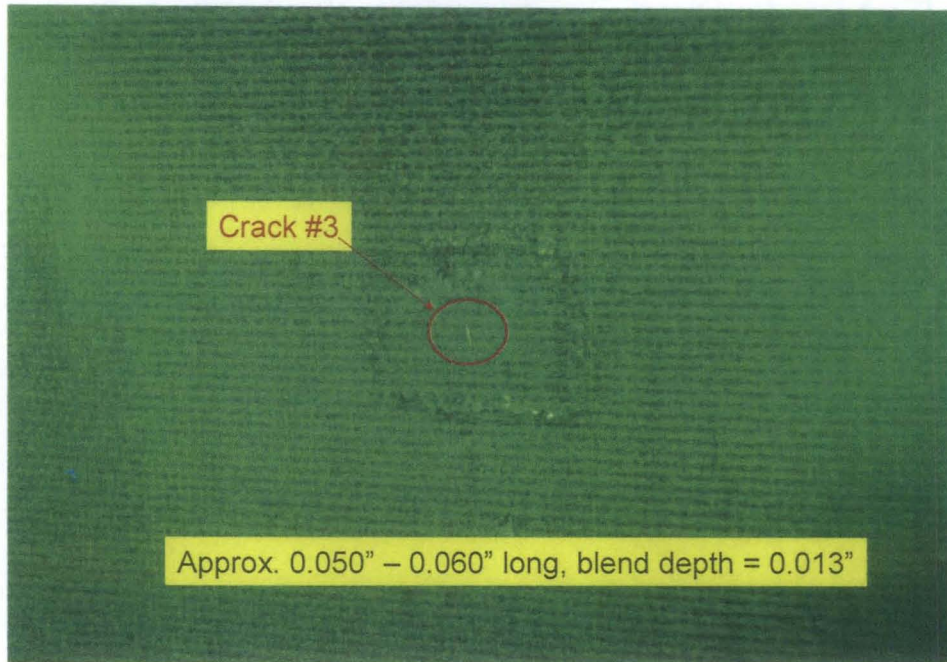

31

## Crack #s 4-7: AIIIS eddy current data & mag image

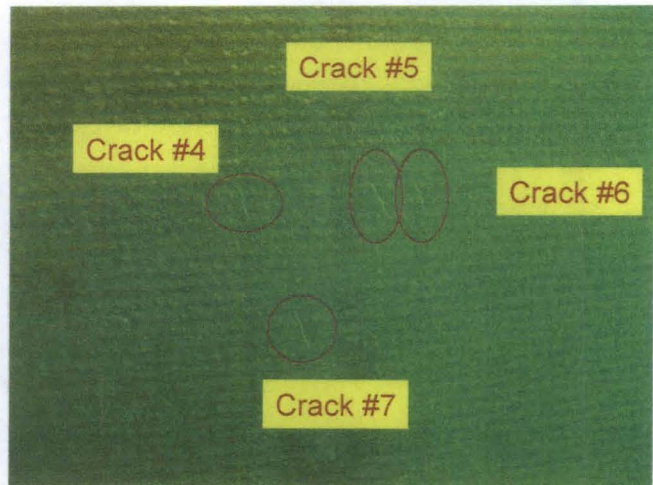
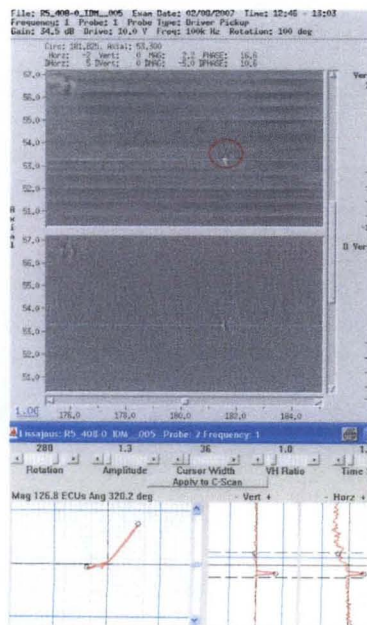

**Blend Depths for cracks**  
 #4: 0.020"      #5: 0.022"      #6: 0.018"  
 #7: 0.025"

32



## Crack #12: AIIIS eddy current data and mag image

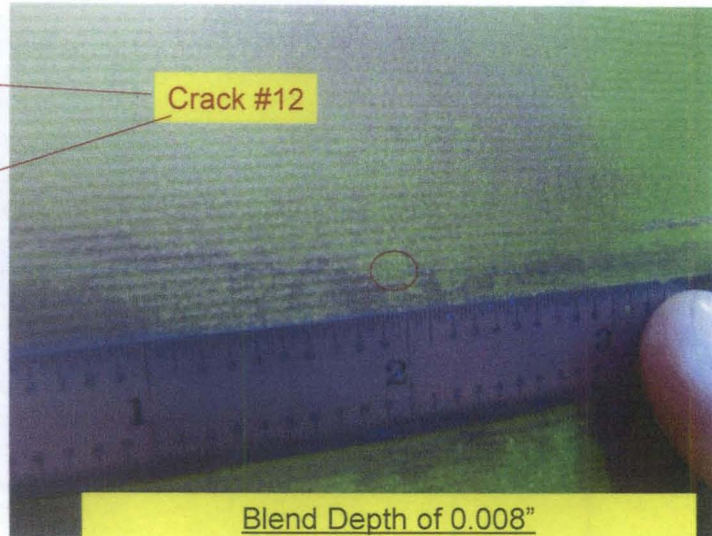
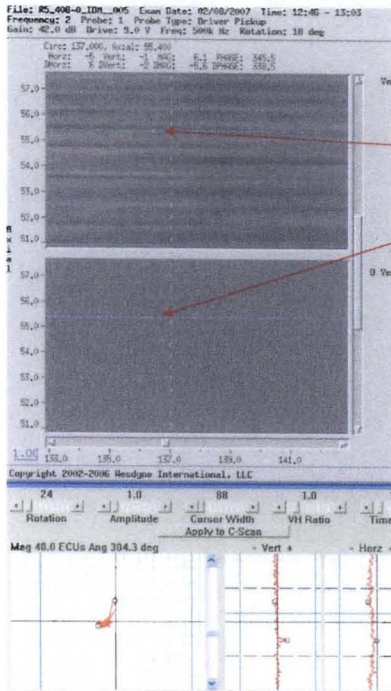

33

## Summary

### Summary

- An automated eddy current system has been implemented to inspect RSRM metal components
- The system was thoroughly characterized through POD testing both before and after installation
- The system has demonstrated improved reliability at detecting cracks compared to the historical visual based inspections.