

NASA Bluetooth Wireless Communications

Robert Miller

Avionics Division, NASA JSC, robert.d.miller@nasa.gov

NASA has been interested in wireless communications for many years, especially when the crew size of the International Space Station (ISS) was reduced to two members. NASA began a study to find ways to improve crew efficiency to make sure the ISS could be maintained with limited crew capacity and still be a valuable research testbed in Low-Earth Orbit (LEO).

Currently the ISS audio system requires astronauts to be tethered to the audio system, specifically a device called the Audio Terminal Unit (ATU). Wireless communications would remove the tether and allow astronauts to freely float from experiment to experiment without having to worry about moving and reconnecting the associated cabling or finding the space equivalent of an extension cord.

A wireless communication system would also improve safety and reduce system susceptibility to Electromagnetic Interference (EMI). Safety would be improved because a crewmember could quickly escape a fire while maintaining communications with the ground and other crewmembers at any location. In addition, it would allow the crew to overcome the volume limitations of the ISS ATU. This is especially important to the Portable Breathing Apparatus (PBA).

The next generation of space vehicles and habitats also demand wireless attention. Orion will carry up to six crewmembers in a relatively small cabin. Yet, wireless could become a driving factor to reduce launch weight and increase habitable volume. Six crewmembers, each tethered to a panel, could result in a wiring mess even in nominal operations. In addition to Orion, research is being conducted to determine if Bluetooth is appropriate for Lunar Habitat applications.

NASA's Avionic Systems division has built and tested wireless communications systems geared around Bluetooth to save power and minimize interference with Wireless Local Area Networks (WLANs). Bluetooth's frequency hopping scheme was built to minimize interference in the 2.4GHz band. NASA has also studied and quantified how much of a factor that interference will play and is looking into authorizing the frequency for use on board. In addition, NASA has been heavily researching Voice over IP (VoIP) because IP traffic between systems is a requirement in the Constellation Program (CxP).

Two options to continue NASA's current work are by (1) pursuing a Detailed Test Objective (DTO) for a wireless system onboard the ISS or (2) building a wireless handset to reduce the Space Shuttle's susceptibility to EMI while providing a low-cost integration path to the ISS.

NASA Bluetooth Wireless Communications

**IEEE Galveston Bay Section
Symposium for Space Applications of Wireless & RFID 2007**

Robert Miller

robert.d.miller@nasa.gov

5/8/2007 -5/9/2007

Avionics Systems Division
Electronics Design Branch



NASA
Johnson Space Center
*EV2: Electronic
Design Branch*

Subject:

Agenda

Name: Robert Miller
Date: 5/11/2007
Page: 2

Wireless Crew Communications (WCC)

- History and Rationale
- Commercial Partnerships
- ISS Test System Block Diagram
- Hardware Developed
- Next Steps
- CEV System Overview





NASA
Johnson Space Center
EV2: *Electronic*
Design Branch

Subject:

WCC History / Rationale

Name: Robert Miller

Date: 5/11/2007

Page: 3

Joint proposal with human factors when ISS crew size was reduced

- Improved Efficiency
 - 3 hours / week current spent translating for communication
 - Crew can be farther from crewmate or audio unit without shouting or repeating
- Operational Volume
 - Workspace not limited to range of audio cable
- Safety
 - Continuous communication during an emergency egress from a module
- Public Affairs
 - No cables dangling in front of crewmember during audio/video downlinks
- Long term cost savings
 - COTS interface to audio system
 - Reduced volume / mass from interface cables



On Mic: Expedition 8 Flight Engineer Alexander Kaleri



NASA
Johnson Space Center
EV2: *Electronic*
Design Branch

Subject:

Commercial Partnerships

Name: Robert Miller

Date: 5/11/2007

Page: 4

- Space Alliance Technology Outreach Program (SATOP)

- Private company requests NASA technical insight
- CAVCOM wanted to make their headset wireless
- NASA wants to use CAVCOM for hearing protection

- Using Wireless with CAVCOM could improve:

- Portable Breathing Apparatus (PBA) earpiece volume
- PBA tethered to Audio Terminal Unit (ATU)
- Loss of communication efficiency between astronauts due to increased noise in an emergency
- Crew Hearing Loss



- Development with Cambridge Silicon Radio's (CSR's) Bluecore-2 processor

- Initial prototype work with Stonestreet One.



NASA
Johnson Space Center
EV2: *Electronic Design Branch*

Subject:

ISS System Block

Name: Robert Miller
Date: 5/11/2007
Page: 5

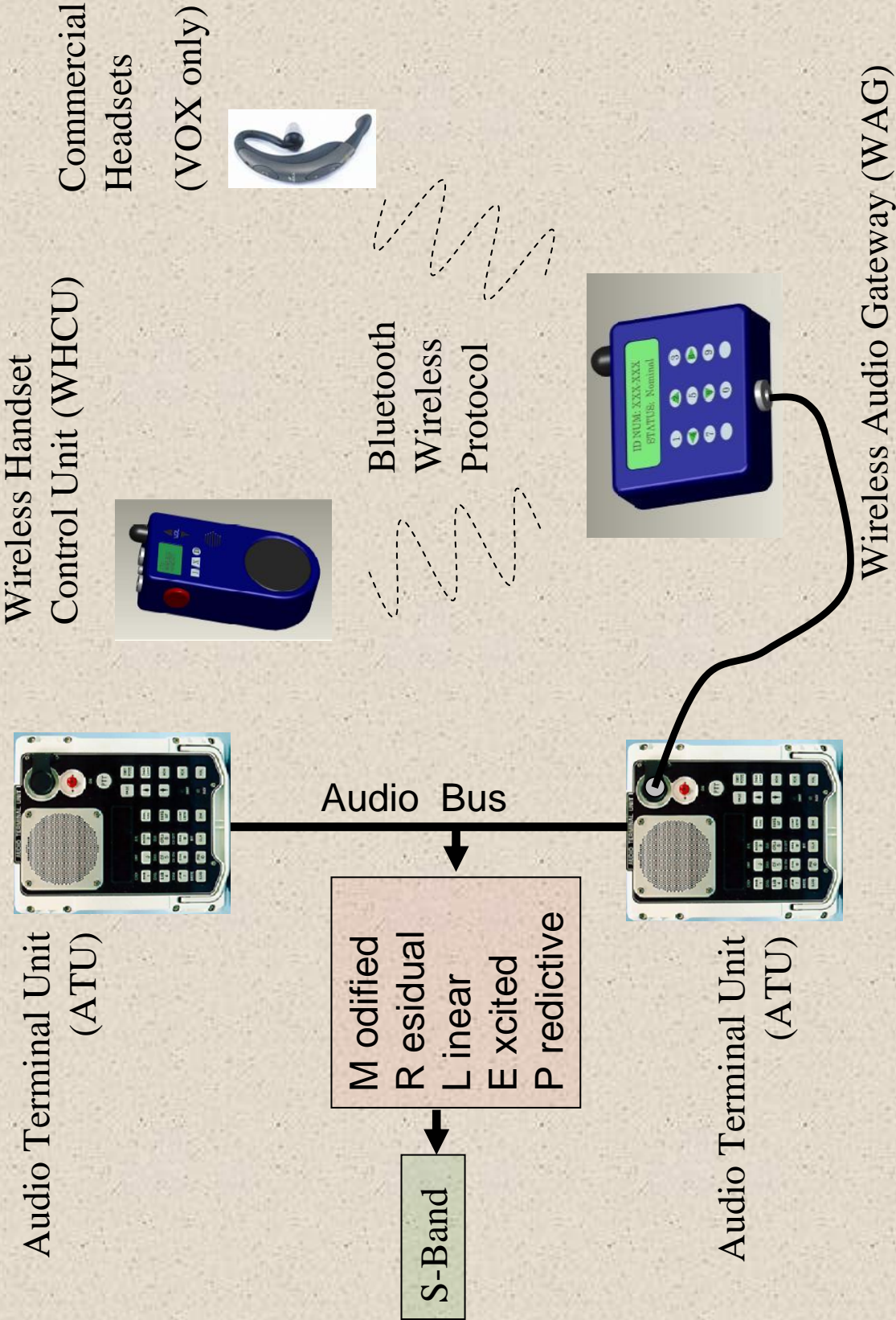



NASA
Johnson Space Center
EV2: Electronic
Design Branch

Subject:

Hardware

Name: Robert Miller
Date: 5/11/2007
Page: 6



Old design

Wireless Handset Control Unit (WHCU)

Wireless Audio Gateway (WAG)



New design





NASA
Johnson Space Center
*EV2: Electronic
Design Branch*

Subject:

Next Steps

Name: Robert Miller
Date: 5/11/2007
Page: 7

1. Test CavCom with the MRELP compression algorithm in both wired and wireless configurations at ESTL
 - Heavily distorts voice
2. Investigate WAG modifications to allow multiple crew to ATU (shown on next slide)
3. Investigate or develop roaming software
 - Test / Debug new WHCU
4. Investigate dual-microphones
5. Test feedback control circuitry
6. Test new headset detection circuit
7. Incorporate new Bluetooth microcontroller with integrated DSP into future revision



NASA
Johnson Space Center
EV2: Electronic
Design Branch

Subject:

Next Steps (Block)

Name: Robert Miller

Date: 5/11/2007

Page: 8

Node 1

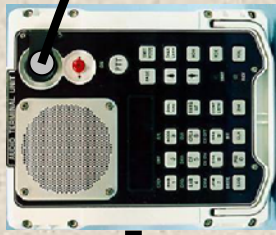

ATU



WAG

Roaming

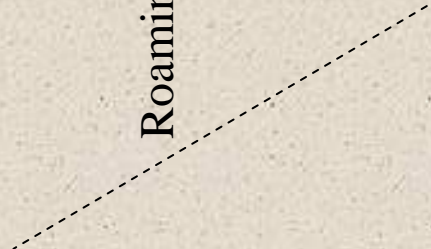

WAG

Lab

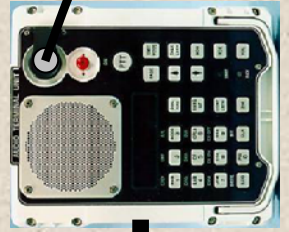

ATU



NASA
Johnson Space Center
EV2: Electronic
Design Branch

Subject:

Orion Audio Architecture

Name: Robert Miller

Date: 5/11/2007

Page: 9

Orion Audio Architecture

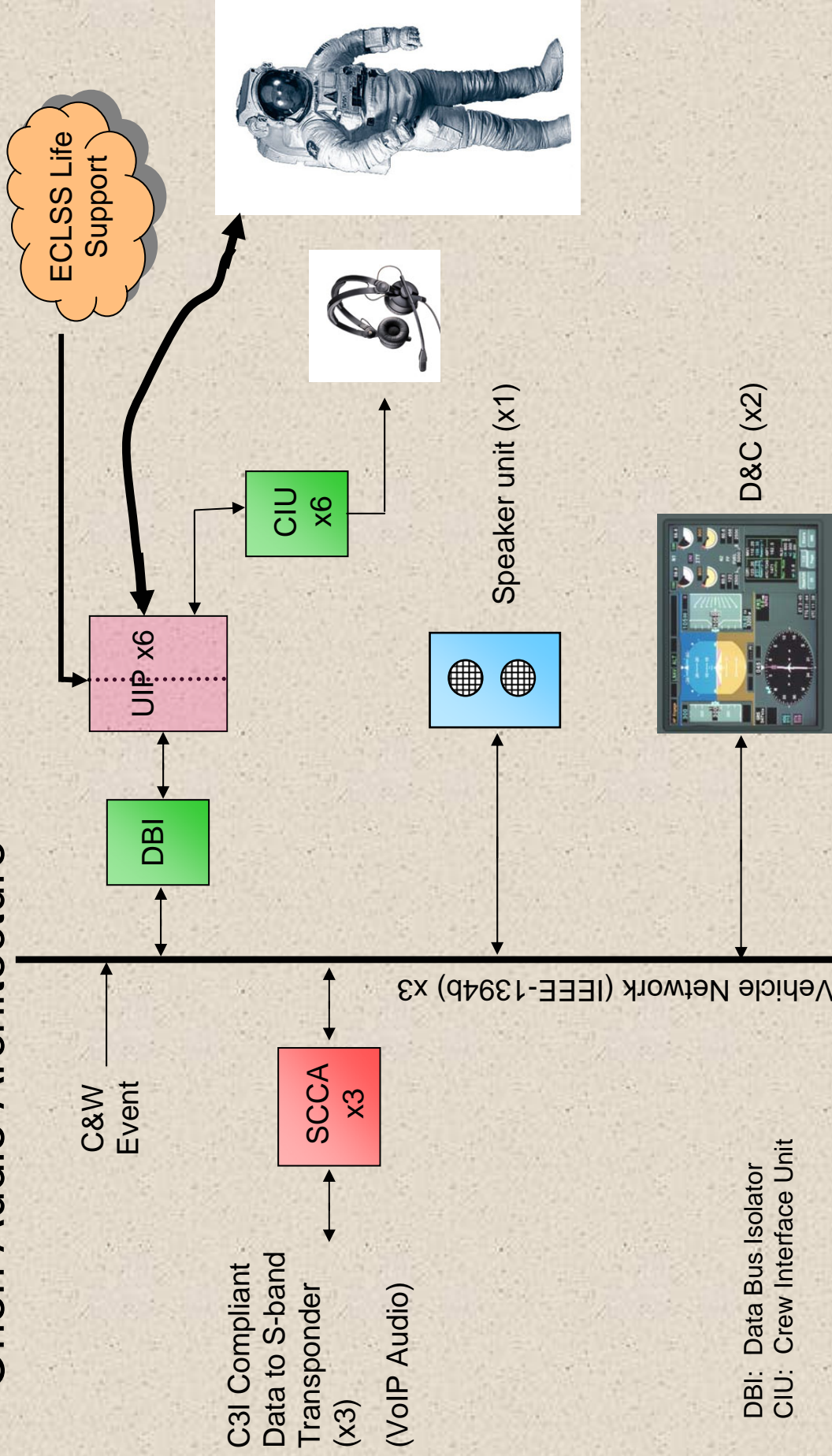

DBI: Data Bus Isolator
CIU: Crew Interface Unit



NASA
Johnson Space Center
EV2: Electronic
Design Branch

Subject:

Name: Robert Miller
Date: 5/11/2007
Page: 10

Backup Slides



NASA
Johnson Space Center
*EV2: Electronic
Design Branch*

Subject:

Protocol Choice

Name: Robert Miller

Date: 5/11/2007

Page: 11

Bluetooth Chosen as Optimal Standard

- Designed for cable replacement and full-duplex audio
- Low Power
 - lightweight, portable battery
- Industry Standard
 - Lasting power
 - Upgradeability
 - Availability of commercial products
- Coexistence of Voice / Data
 - Data needed for mode selection, PTT
 - Data allows potential future upgrades like VoIP interface to LAN





NASA
Johnson Space Center
EV2: Electronic
Design Branch

Subject:

ISS Ambient Noise

Name: Robert Miller
Date: 5/11/2007
Page: 12

Sound Pressure Levels in the Service Module (SM)

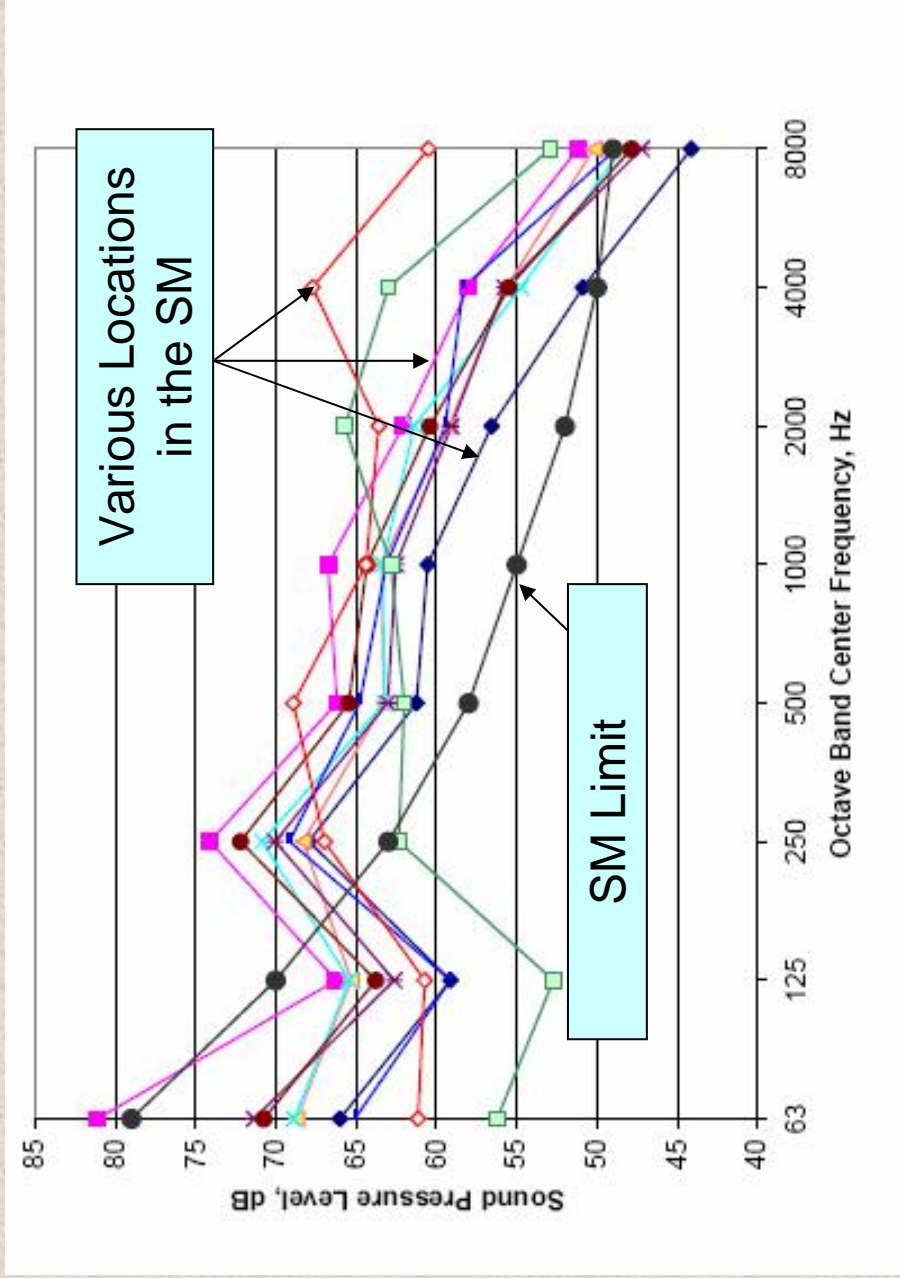

OSHA Maximum for
8-hour day: **90 dB**



NASA
Johnson Space Center
EV2: Electronic Design Branch

Subject:

WAG / HCU Block

Name: Robert Miller
Date: 5/11/2007
Page: 13

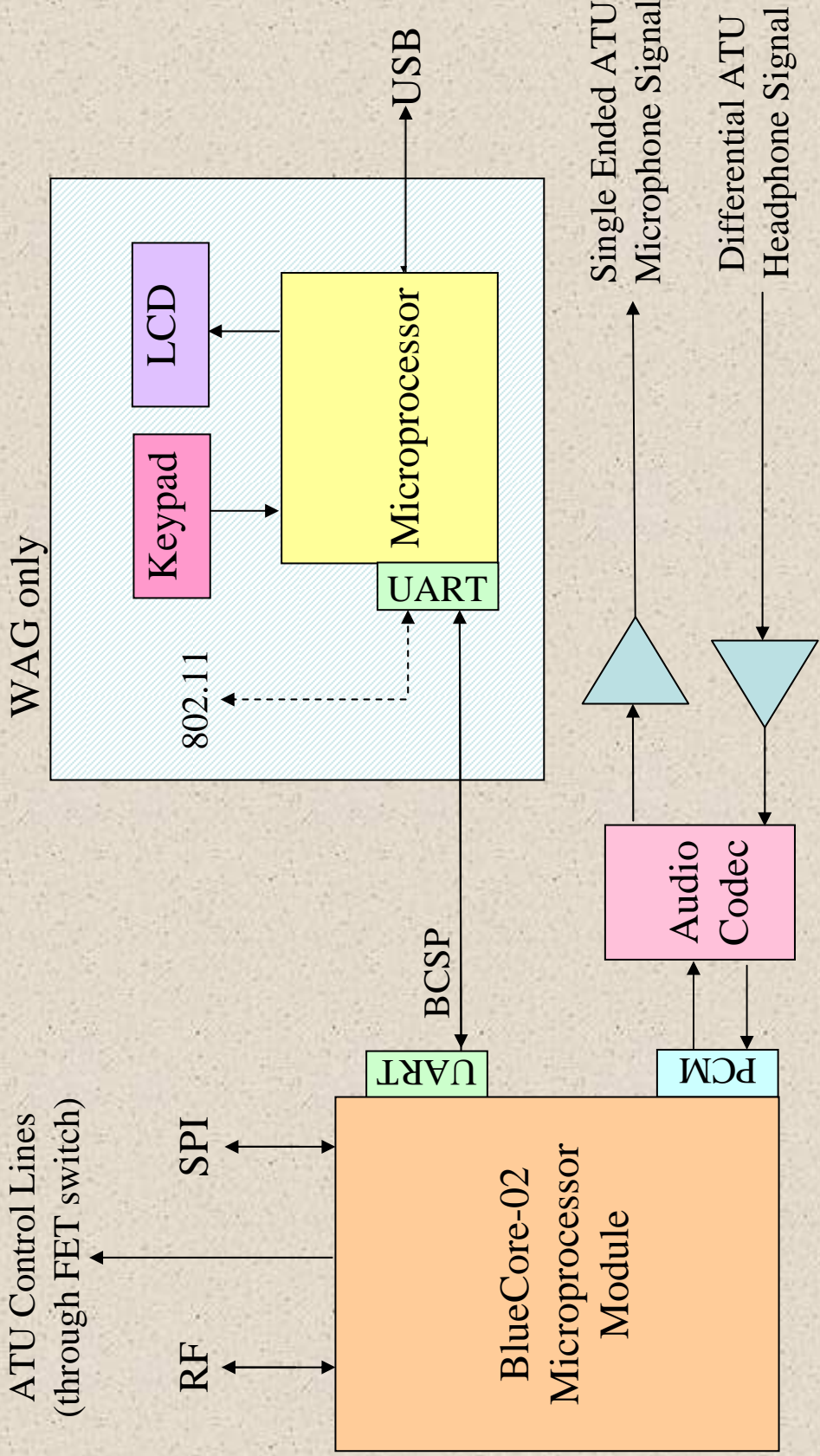



NASA
Johnson Space Center
EV2: Electronic
Design Branch

Subject:

Test Box Block

Name: Robert Miller

Date: 5/11/2007

Page: 14

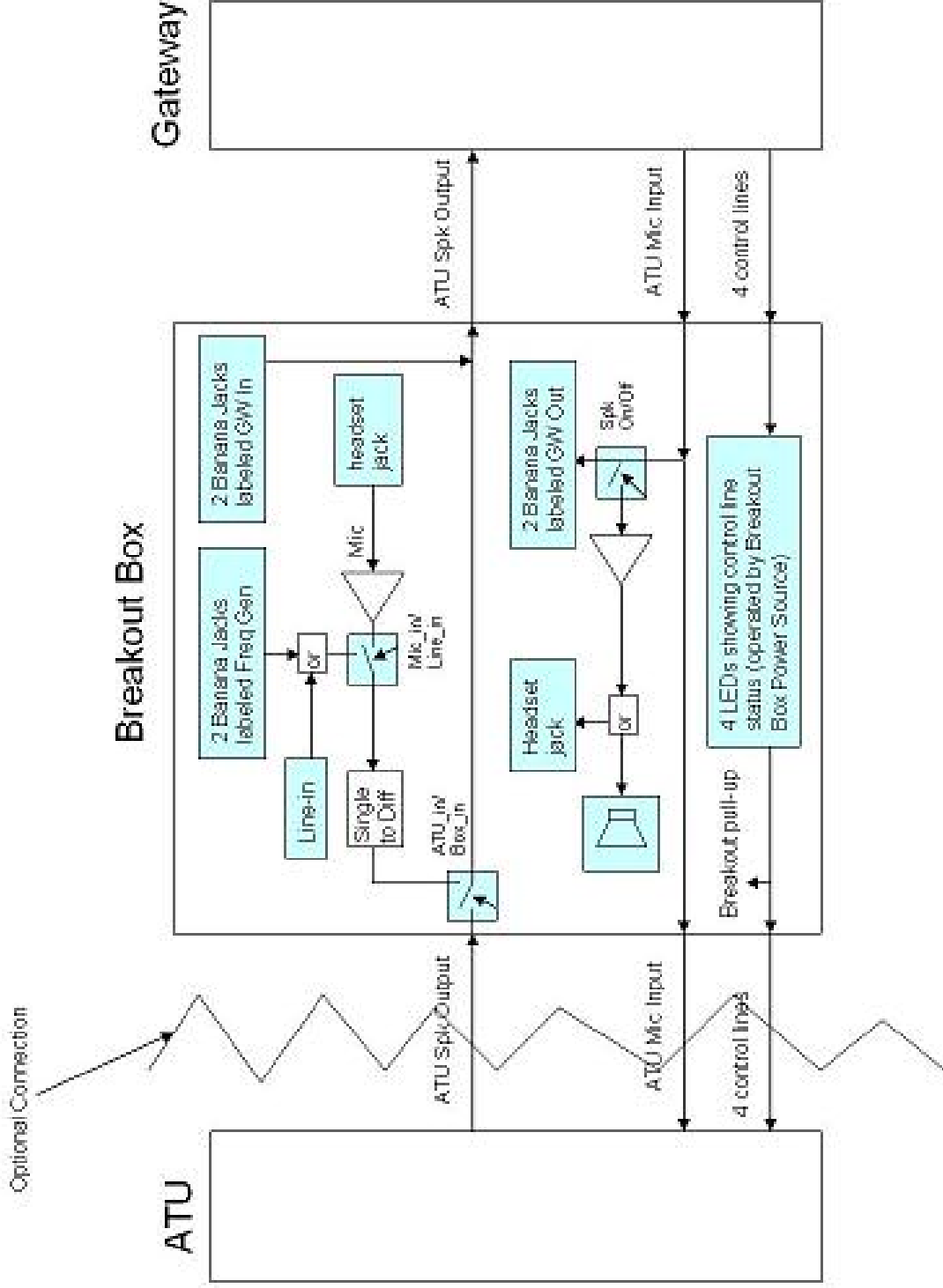



NASA
Johnson Space Center
EV2: Electronic
Design Branch

Subject:
**ISS Systems Integration Lab
(ISIL) Test**

Name: Robert Miller
Date: 5/11/2007
Page: 15

Remote ATU

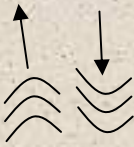
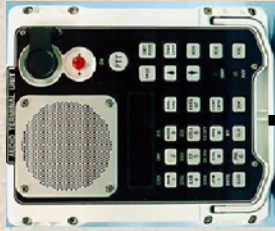

Duplexed Audio

ELI



Jabra250



Standard
Headset



CavCom



WHCU



WAG

ATU

Bluetooth
Wireless
Protocol

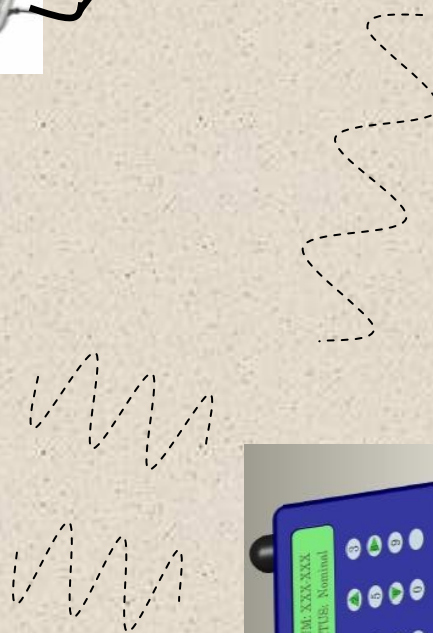



NASA
Johnson Space Center
EV2: Electronic
Design Branch

Subject:

ISS Systems Integration Lab (ISIL) Test

Name: Robert Miller

Date: 5/11/2007

Page: 16

ATU

P-Mic

Breakout Boxes

CavCom

WAG

Casira Development Kit

WHCU

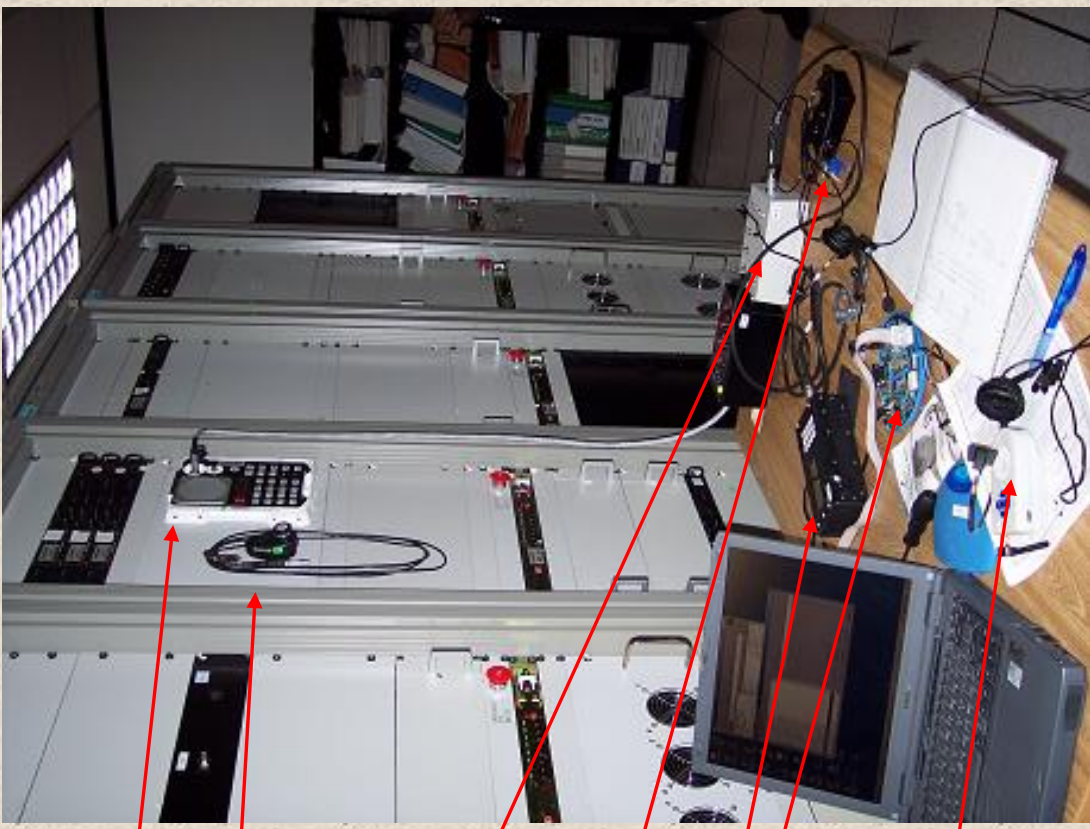

	<p>NASA Johnson Space Center EV2: <i>Electronic Design Branch</i></p>	<p>Subject: ISS Systems Integration Lab (ISIL) Test Results</p>	<p>Name: Robert Miller Date: 5/11/2007 Page: 17</p>
--	--	--	---

ISIL Results (after 2 tests and demo) (hardcopy of report available)



WAG: Successfully forced ATU mode into VOX for commercial headsets and allowed WHCU to change modes



WHCU: Successfully changed the ATU mode wirelessly over Bluetooth

- Feedback present when ATU generates side tone



CavCom: Successfully transmitted and received audio through the WHCU and Casira BT development kit.

- Audio quality needs to be improved.



Eli: Worked great both transmitting and receiving. Some feedback noticed near remote ATU due to very sensitive microphone.



Jabra250: Best audio quality, standard commercial headset