

ON-BOARD OPTICAL SPECTROMETRY FOR DETECTION OF MIXTURE RATIO AND ERODED MATERIALS IN ROCKET ENGINE EXHAUST PLUME

Sarkis Barkhoudarian, Scott Kittinger

Pratt and Whitney Rocketdyne, Canoga Park, California 91309

ABSTRACT

Optical spectrometry can provide means to characterize rocket engine exhaust plume impurities due to eroded materials, as well as combustion mixture ratio without any interference with plume. Fiberoptic probes and cables were designed, fabricated and installed on Space Shuttle Main Engines (SSME), allowing monitoring of the plume spectra in real time with a Commercial of the Shelf (COTS) fiberoptic spectrometer, located in a test-stand control room. The probes and the cables survived the harsh engine environments for numerous hot-fire tests. When the plume was seeded with a nickel alloy powder, the spectrometer was able to successfully detect all the metallic and OH radical spectra from 300 to 800 nanometers.

INTRODUCTION

Optical on-board plume spectrometry can, in real time, perform inspection and health management for erosion/wear of rocket engine internal components, as well as monitor the actual combustion mixture ratio in the plume. This is achieved by monitoring the spontaneous optical emission from all the metallic elements and OH radical in the plume. In most rocket engines, all the internal eroded materials combust in the exhaust plume. The spectral wavelengths are an indication of the combusting element types and their intensities are a measure of the amount of each element in the plume.

This technology has the potential to reduce/replace conventional intrusive manual inspection of rocket-engine internal surfaces looking for material erosion. It is more valuable for deep-space rocket-engine applications where in space inspection is not practical. Through the use of this technology, the erosion, wear and burning of all internal components can be measured in real time without any interference with the plume. This will result in improved safety and mission success, while providing condition-based maintenance and reducing the need of in-space

inspection. In addition, optical spectrometry can provide information about the actual *combustion* mixture ratio, rather than the *propellant* mixture ratio, eliminating possible errors due flowmeters or leakage.

COMMERCIAL SPECTROMETER DESCRIPTION

COTS fiberoptic spectrometers contain a diffraction grating element and 2048-diode linear-array photodetector. The grating element diffracts the light transmitted by fiberoptic cable to different colors which are located at different angles. The photodetector array, placed in front of the diffracted light, measures the amplitude of each color simultaneously. An electronic multiplexer provides consecutive electrical spectra in only five milliseconds, covering 300 to 800 nanometer optical wavelength range, with 1-nm resolution. These spectrometers are lightweight and very small. They weigh only 0.42 lb and have only 3.5x2.5x1.4 inch dimension. See Figure 1.

SSME SPECTROMETRIC SYSTEM DESCRIPTION

A special spectrometric system was developed for monitoring SSME plume, as shown in Figure 2. It consisted of passive and robust fiberoptic probes, fabricated from the nozzle manifold material, as shown in Figure 3, ruggedized COTS fiberoptic spectrometers, and custom-made UV-transmitting 100-ft long fiberoptic cables. See Figure 4. The probes are installed on the SSME nozzle aft manifold as shown in Figure 5. The probe center lines are aimed above the shock diamond to eliminate the need of tracking the shock diamond as the rocket engine ascends and the shock diamond expands and departs from the nozzle, (see Figure 6.). This eliminated the need of mechanical tracking devices that did not survive the nozzle violent environment (83 g rms random vibration and up to 6,000 F total temperature) during previous attempts. The spectrometer was installed in a test-stand hard-core room and attached to the probe approximately 100 feet away from the SSME nozzle lip, as shown in Figure 7.

SSME SPECTROMETRIC TEST RESULTS

Optical spectra from 18 SSME hot-fire tests were obtained. These spectra were averaged over $\frac{1}{2}$ of a second to obtain improved signal-to-noise ratio. A typical SSME spectrum is shown in Figure 8 where x-axis is the wavelength in nanometer, y-axis is the time profile and z-axis is the relative value of the intensity of the optical emission. The 318-nanometer line shows the presence of OH radical which is related to the plume mixture ratio; 589 nm is the sodium line and 766 nm is the potassium line. These lines are always present due to the fact that the combustion is not stoichiometric but it is hydrogen rich (~6:1 oxygen to hydrogen) and that the propellants have trace amounts (parts per billion) of sodium and potassium impurities.

During a SSME hotfire test, 50 grams of Inconel-718 powder was mixed into uralite paste and was applied to a 0.5x2-ft area of the inner wall of the SSME nozzle to seed the plume with impurities. The spectrometric system simultaneously detected the alloy Ni, Cr, and Fe elements, indicating almost complete combustion of the Inconel-718 powder in the first few seconds when the engine reaches to its 100% load, as shown in Figure 9. Subsequent hotfire tests showed presence of similar Inconel spectra during power-level changes. It was hypothesized that this emission originated from minute unburned Inconel-718 powder, left in nozzle liquid-hydrogen cooled (-430°F) inter-tube crevices and dislodged during nozzle distortion. This indicates the feasibility of detecting much smaller amounts of eroded material in real time.

CONCLUSION

Real-time optical spectrometry is demonstrated to be feasible in a harsh rocket engine environment, providing measurements of internal component erosion and remaining life. This capability could eliminate the need for intrusive inspection. It also identifies the eroding component from the ratio of various elements, corresponding to each alloy, providing fault isolation. Optical spectrometry can also be used for direct monitoring of the plume mixture ratio through measurement of the intensity of the OH radical wavelength, providing instantaneous combustion information.

ACKNOWLEDGMENTS

The authors would like to thank Lorin Blewett, Ferdinand Jones, Douglas Bradley, Ken Kan, Ed Hansen and Robert Blomquist for supporting the development of this technology and Kelly Stallmo for her assistance in preparing this paper.

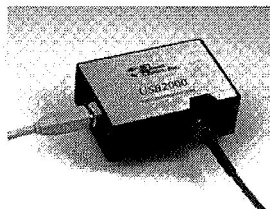

Figure 1. COTS Fiberoptic spectrometer

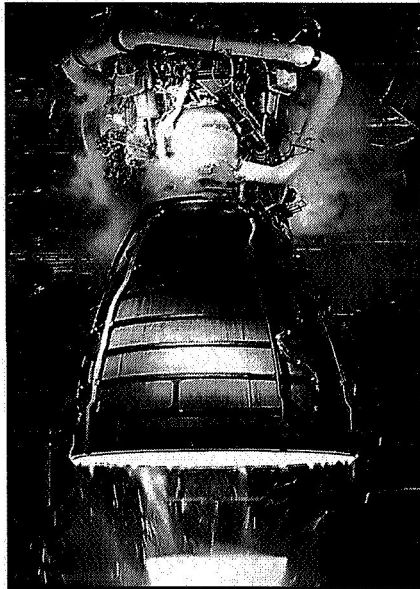

Figure 2. SSME Plume

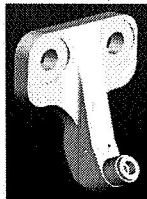

Figure 3. Robust Fiberoptic Probe

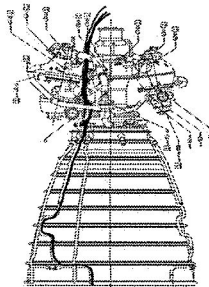

Figure 4. Space Shuttle Main Engine Fiberoptic Cable

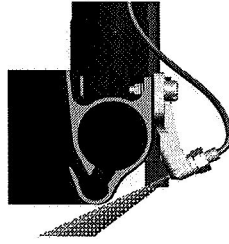

Figure 5. Cutaway View of Fiber optic Probe Installation on SSME Nozzle

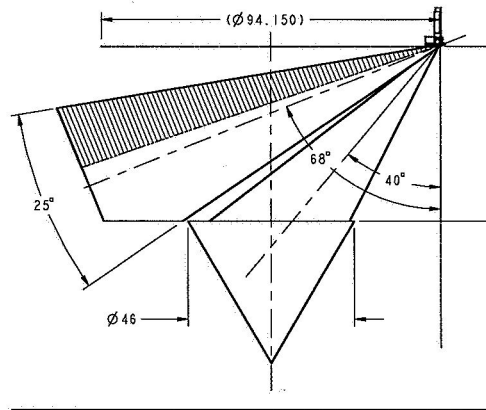

Figure 6. Fiber optic Probe Field of View Underneath the Nozzle Aft Manifold

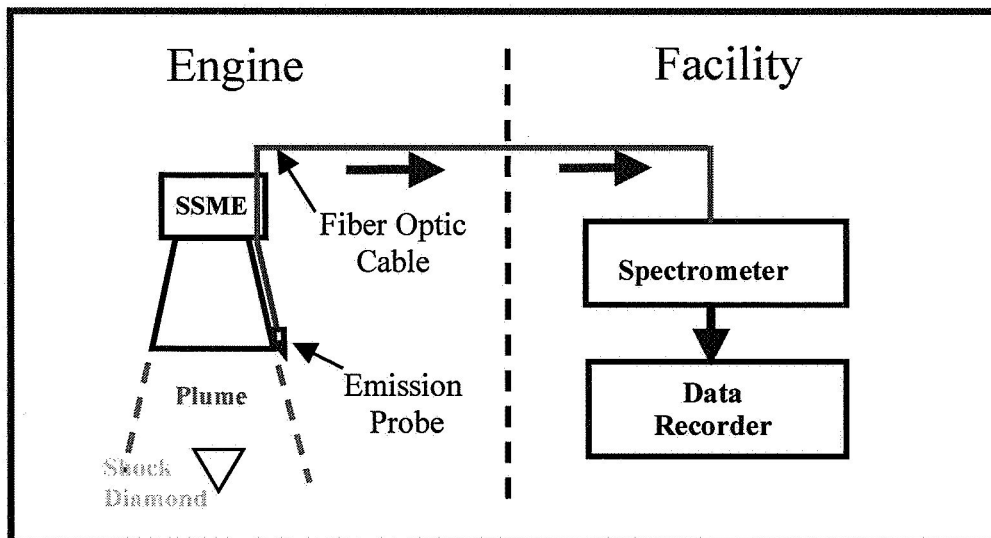

Figure 7. SSME Spectrometric System Setup

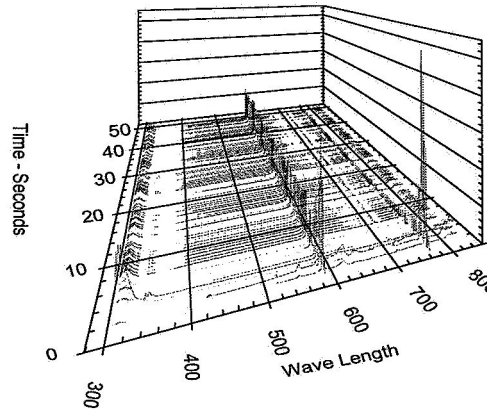

Figure 8. Typical SSME Plume Optical Spectra

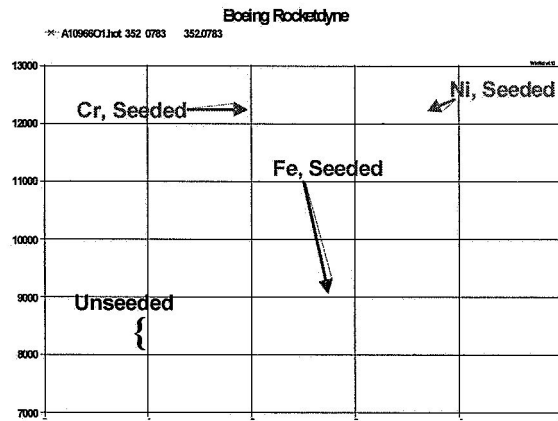

Figure 9. Time Profiles of Seeded and Unseeded SSME Plume from Two Hot Fire Tests

BIBLIOGRAPHY

Barkhoudarian, S., "Real-Time On-Board HMS/Inspection Capability for Propulsion and Power Systems"

AIAA/ASME/SAE/ASEE Joint Propulsion Conference, Tucson, Arizona, 2005.

Tejwani, Gopal D., Felix E. Bircher, and David Van Dyke, "SSME Health Monitoring at SSC with Exhaust Plume

Emission Spectrometry" AIAA/ASME/SAE/ASEE Joint Propulsion Conference, Seattle, Washington, 1997.

Bickford, R., Madzsar, G. "Fabry-Perot Interferometer Development for Rocket Engine Plume Spectrometry",
AIAA/ASME/SAE/ASEE Joint Propulsion Conference, Orlando, Florida, 1990.