

“Survey of Dust Issues for Lunar Seals and the RESOLVE Project”

By Margaret P. Proctor and Paula Dempsey

Abstract

Lunar dust poses a technical challenge for sealing applications on the moon. A survey of seals used in Apollo lunar missions is presented as well as lunar soil characteristics and a description of the lunar environment. Seal requirements and technical challenges for the volatiles characterization oven and hydrogen reduction reaction chamber of the RESOLVE project are discussed. The purpose of the RESOLVE project is to find water or ice in lunar soil and demonstrate the ability to produce water, and hence oxygen and hydrogen, from lunar regolith for life support and propellants.

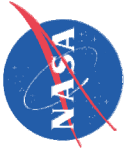

Survey of Dust Issues for Lunar Seals and the RESOLVE Project

By

Margaret P. Proctor and Paula Dempsey

**Seals Team of the Mechanical Components Branch
Materials and Structures Division
NASA Glenn Research Center**

**Presented at the
2006 NASA Seal/Secondary Air System Workshop
November 14-15, 2006
Cleveland, OH**

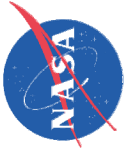

Challenges of Future Lunar Exploration

“Dust represents the single largest technical challenge to prolonged human presence on the Moon.”

Harrison Schmidt, Apollo 17 Astronaut March 2005

- The extent and duration of planned lunar surface activities is much higher than prior Apollo experiences.
- Systems and components will be exposed to environmental factors for periods of time orders of magnitude longer than those previously addressed.

Dust mitigation strategies:

1. Design systems tolerant of dust properties
2. Develop techniques to clean or remove dust from surfaces
3. Active abatement methods to minimize or eliminate deposition and/or adhesion of dust

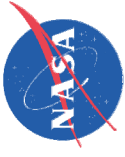

Apollo Lunar Sample Return Containers a.k.a. “Rock Boxes”

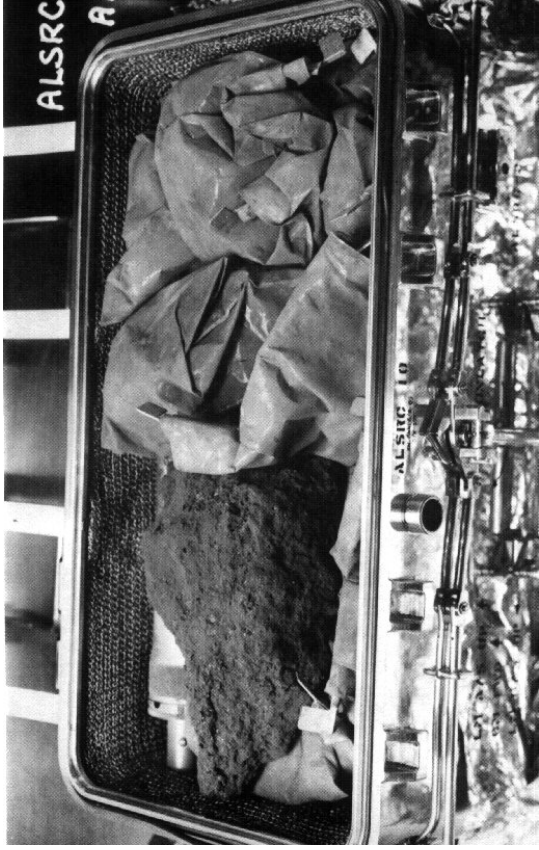

- Used to return lunar regolith samples to earth
- Triple seals designed to provide a vacuum seal of 10^{-6} torr
- Aluminum box (7075 AA) with Knife edge seal in soft indium alloy (90% indium, 10% silver), 150 cm long
- Teflon spacer prevents contact prior to use.
- Single use and pressure required to maintain sealing.
- Double O-rings (L608-6 fluorosilicone) for add'l sealing.

Of the 12 Rock Boxes, 4 had substantial leaks due to bag material or dust on sealing surface¹

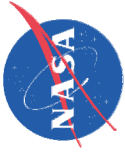

Apollo Special Environmental Sample Containers

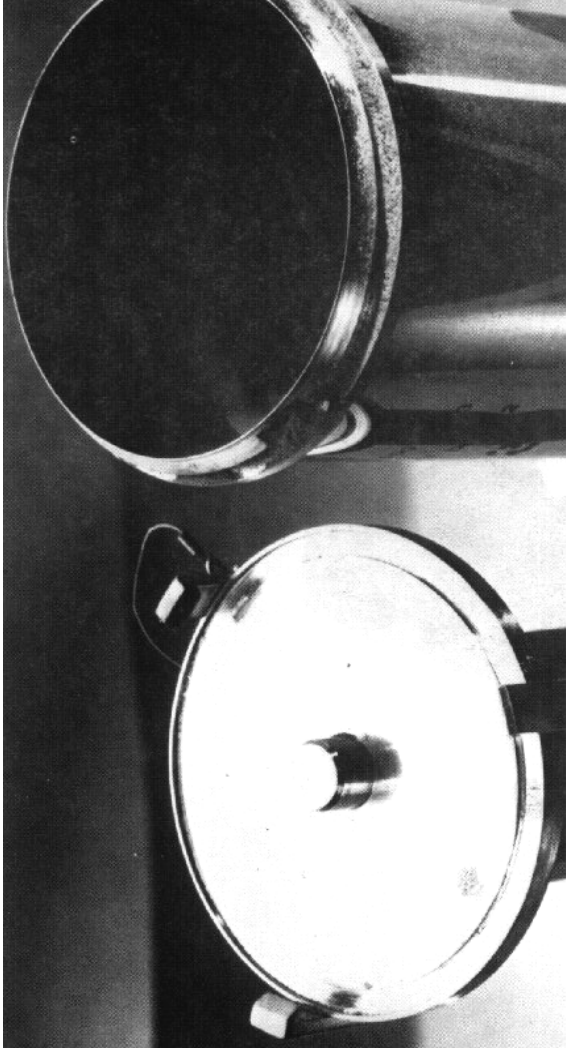

- 340L S.S. with knife edge seal into indium alloy
- 18 cm long
- At end of Apollo missions, no reports of leakage

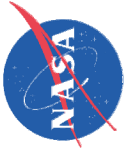

Apollo Space Suits

- **Space Suits**
 - Designed to operating pressure: 3.75psig (25.8 KPa),
temperature: + 250 °F (+ 394 °K),
maximum leak rate: 0.0315 lb/hr (180 scc/min)
 - Leakage increased with use.

Apollo Helmet Attaching Neck Ring

- Manufactured by Air-lock Inc.
- Aluminum alloy 7070-T6 treated with an anodized coating.
- Helmet disconnects have interior stainless steel bearings
- Seals in the Extravehicular Mobility Suits (EMS) were used to attach the space helmets to the spacesuit by a pressure-sealing neck ring.
- Between Extra-Vehicular Activities (EVAs) the helmet disconnect seals were cleaned and re-lubricated with Krytox oil and grease to reduce leakage.

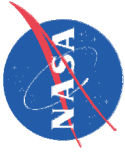

Apollo Helmet Attaching Neck Ring

- Attached to suit by a self-latching self-sealing quick disconnect coupling

It has....

- Neck ring housing
- 8 latch assemblies
- A rotating lock ring
- Push button lock assembly on the locking ring.

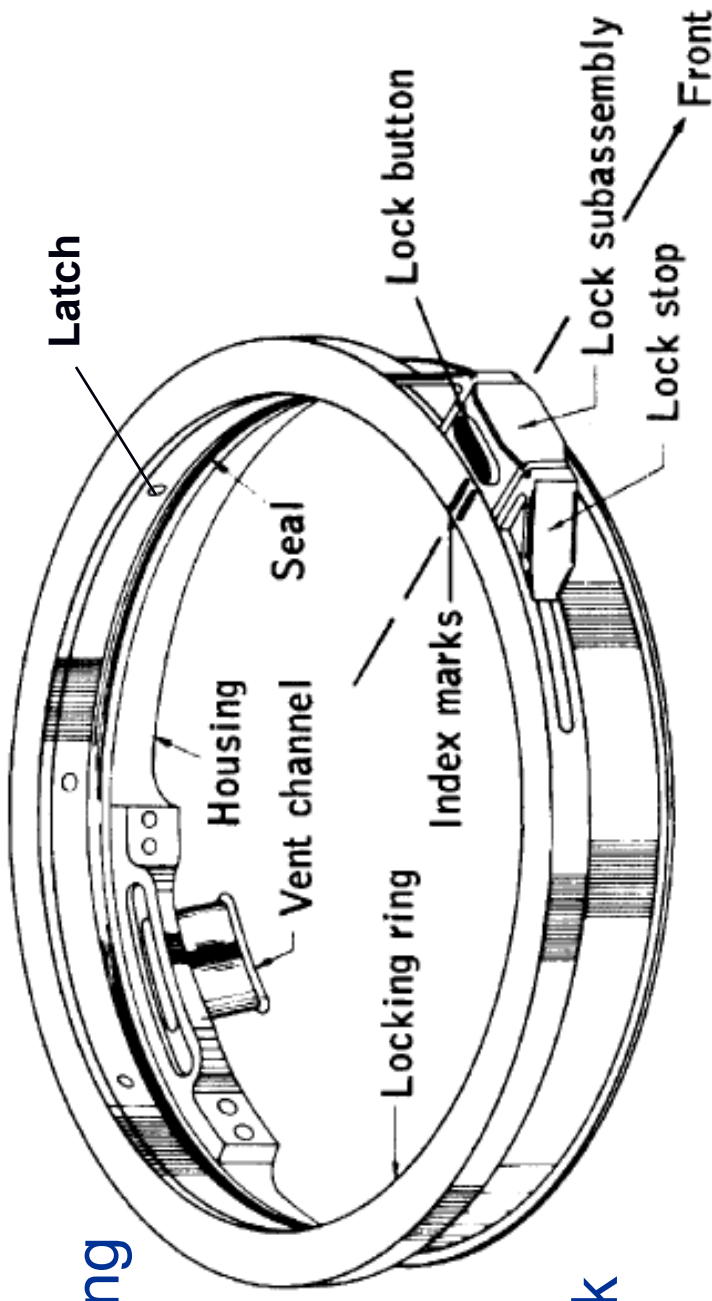

CMP A7LB

Command Module Pilot (CMP) Helmet

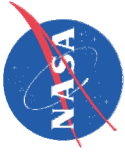

Apollo Space Suits

Glove Disconnect Assembly

- Manufactured by Air-lock Inc.
- Aluminum alloy 2024-T4.
- Have interior stainless steel bearings.
- Pressure-sealing disconnects attached gloves to spacesuit arms
- Wrist bearings and rotational hardware connectors had fabric coverings to keep out the dust.
- Between EVAs glove disconnect seals were cleaned and re-lubricated with Krytox oil and grease to reduce leakage.
- Air-lock has a patent (4596054) on the synthetic resin lip seal used in the bearing assembly of the space suit at the rotary motion locations, such as at the glove connection.
- The suit side has a manually actuated lock/unlock mechanism.
- The glove has a sealed bearing that permits 360° glove rotation.

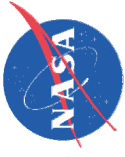

Apollo Space Suits-Glove Disconnect Assembly

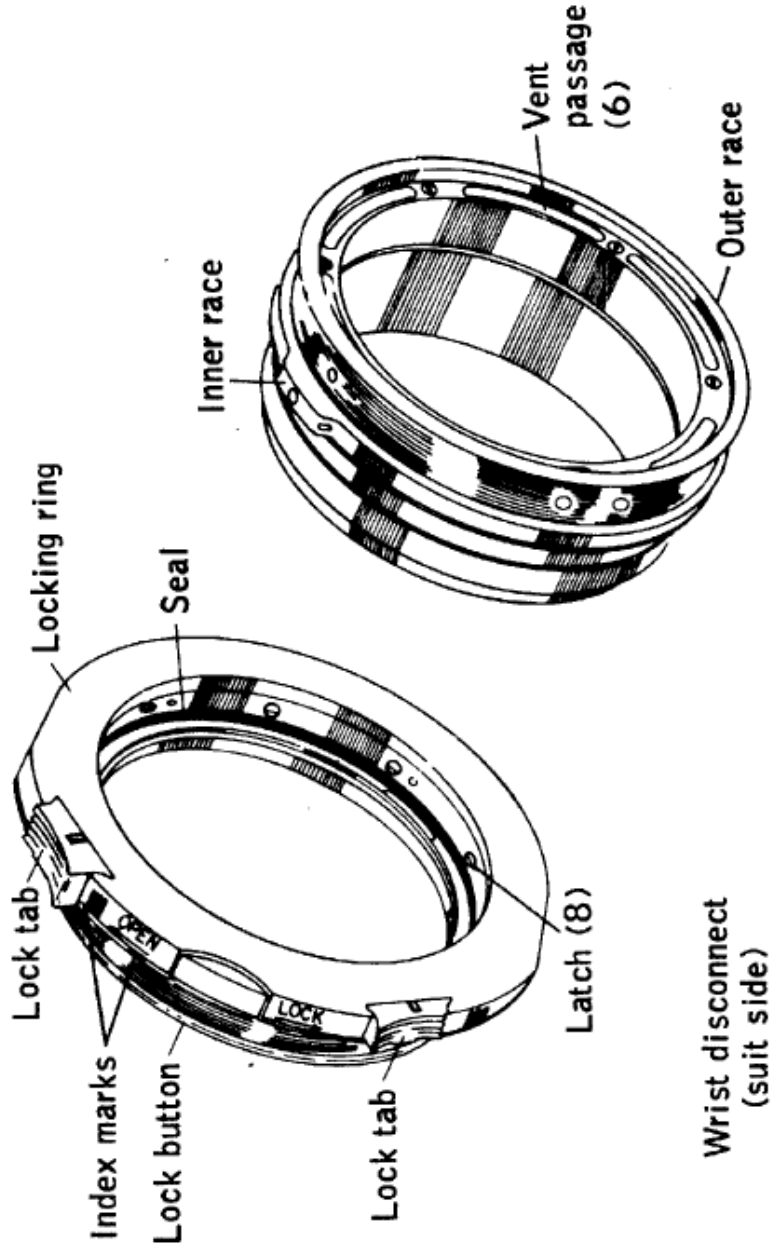

Wrist disconnect
(glove side)

Reference: Apollo Operations Handbook (1971) Extravehicular Mobility Unit. Volume I. CSD-A-789-(1)

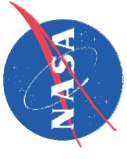

Lunar Soil Characteristics

Characteristic	Description
Size	90% < 1000 μm , 70% < 100 μm
Shape	Angular/subangular sharp
Bulk Density (0-30 cm)	1.58 \pm g/cm ³
Hardness	5-7 (Mohs scale)
Porosity (0-15 cm)	52% \pm 2%
Cohesion (0-15 cm)	0.52 KPa (.0053 kg/cm ² ; .0754 psi)
Toxicity	Primarily non-toxic
Corrosiveness	Not active in vacuum
Electrostatic	Highly charged
Magnetic	<20 μm high ferromagnetic susceptibility
Thermal Conductivity	1.72-2.95 x 10 ⁻⁴ W/cm °K (Apollo 17)
Compressibility (loose)	0.3 (compression index)

Reference: Fuhs, S., Harris, J.(1992) Dust Protection for Environmental Control and Life Support Systems in the Lunar Environment. Proceedings of the Lunar Materials Technology Symposium.

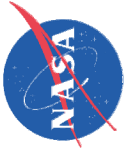

Lunar Soil Composition

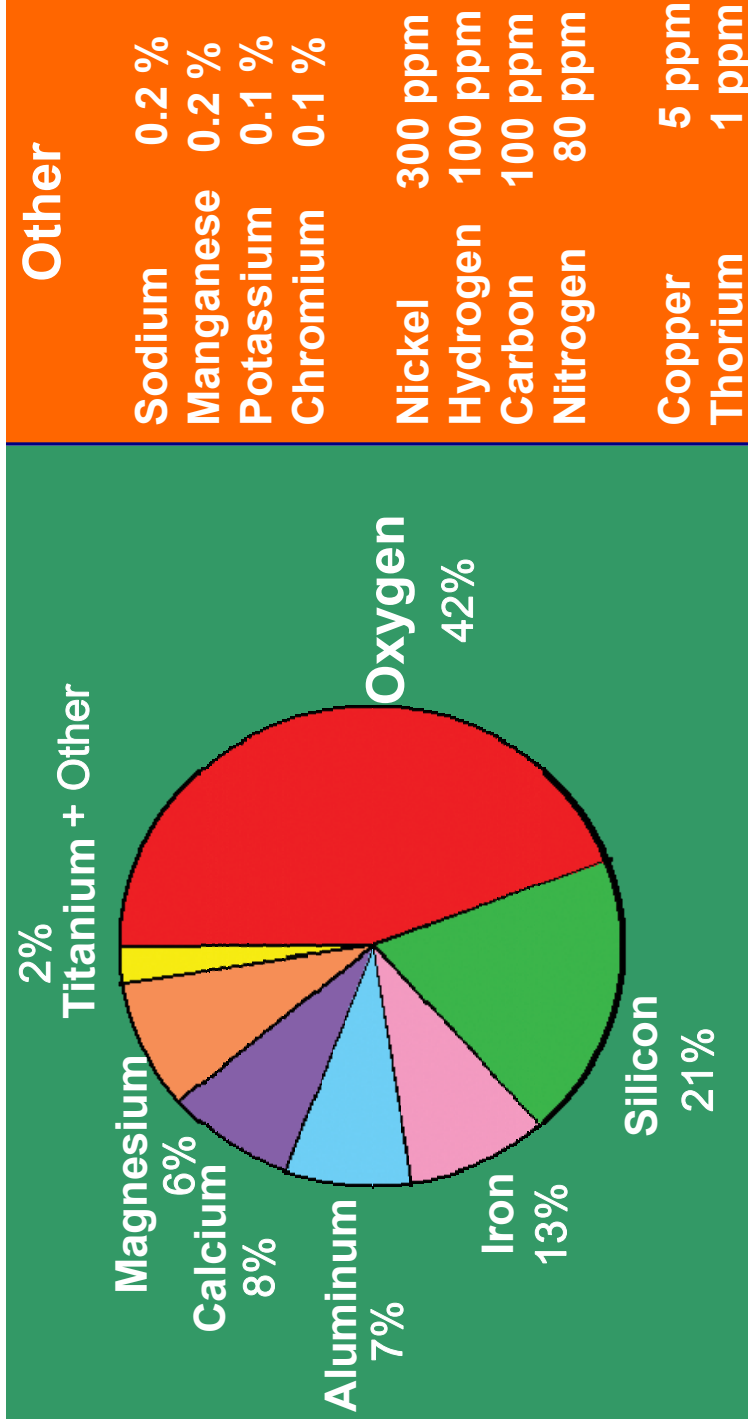

Reference: McKay, D.S. and Taylor, L. (2005) Nature and Evolution Of Lunar Soil.

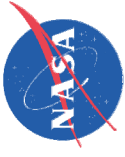

Lunar Environment

Equatorial radius	1738.1 km
Surface area	$37.8 \times 10^6 \text{ km}^2$
Mass	$7.35 \times 10E^{22} \text{ kg}$
Density	3.34 g/cm ³
Surface gravity	1.63 m/sec ²
Orbital Period around earth	27.32 Earth days
Atmospheric Pressure	$3 \times 10^{-13} \text{ KPa}$ ($2 \times 10^{-12} \text{ torr}$)
Measured Surface Temps. (Apollo)	Min -181 C (92 K) Max 111 C (384 K)
Atmosphere (%)	Helium (25); Neon (25); Hydrogen(23); Argon(20); Trace: Methane; Ammonia; Carbon Dioxide
Lunar Radiation Sources	Galactic cosmic rays (GCR) Solar particle events (SPE) wind, cosmic rays

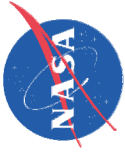

The RESOLVE project

- **Purpose:**
 - find water or ice in lunar soil
 - demonstrate the ability to produce water and hence oxygen and hydrogen for life support and propellants from lunar regolith.
- **How will this be done?**
 - Core samples of lunar regolith heated in a Volatiles Characterization Oven to 150 °C to look for water vapor or other volatiles.
 - Hydrogen reduction process reacts hydrogen to the oxides in the lunar regolith to form water, which can then be split into H₂ & O₂ using electrolysis. Process requires heating to ~900 °C.

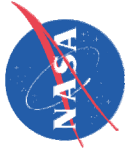

Conceptual Integrated RESOLVE Unit¹

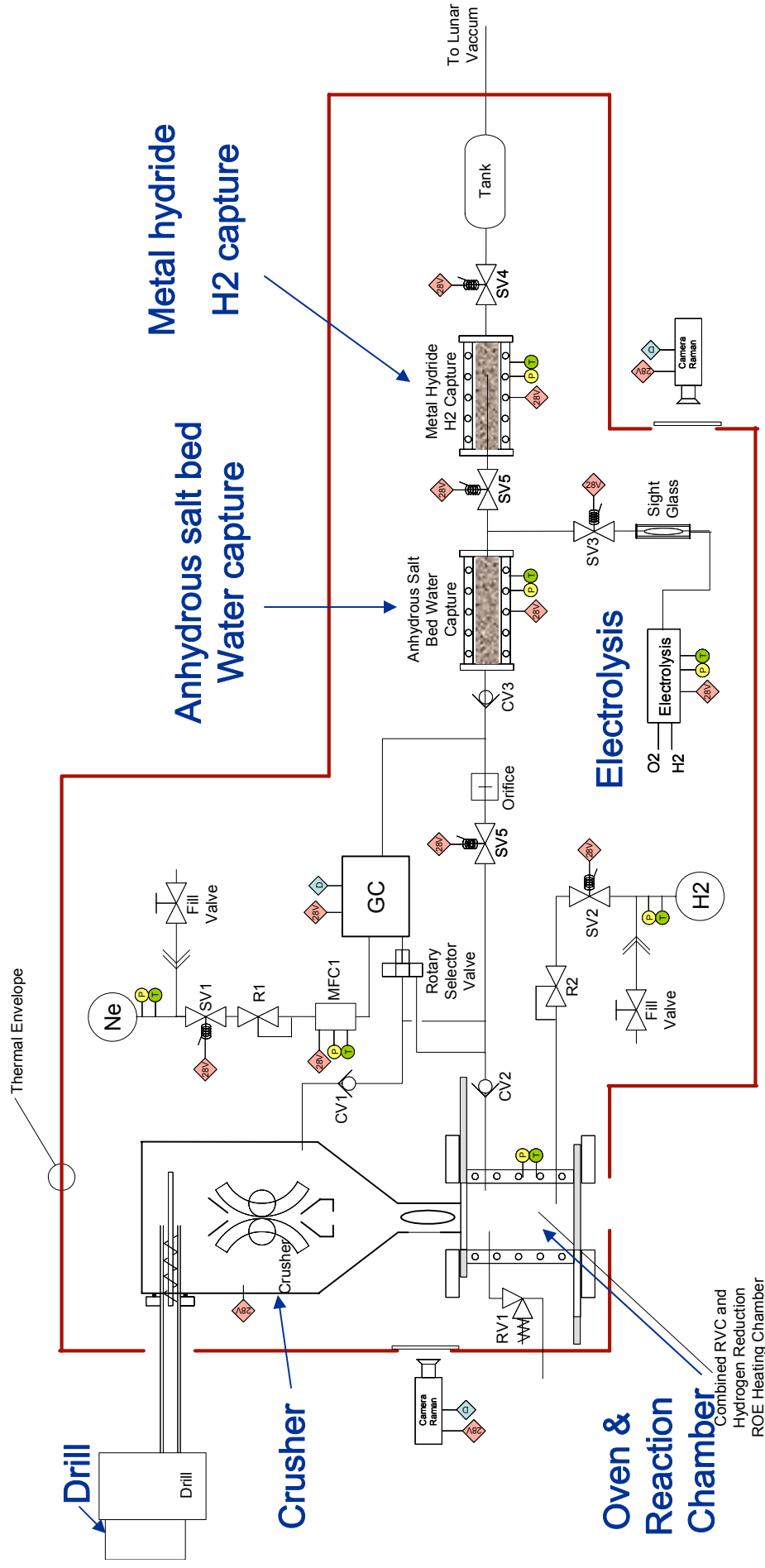

¹ Sanders, Gerald B., et. al., "Regolith & Environment Science, and Oxygen & Lunar Volatile Extraction (RESOLVE) for Robotic Lunar Polar Lander Mission," Lunar International Conference 2005.

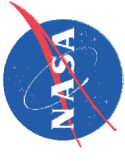

Seal Requirements for Volatiles Characterization Oven (VCO)

- Capable of -233 to 150 °C
- Effective for 0-75 psi differentials (may be revised to 150 psid)
- Low or no out-gassing in a vacuum (lunar 10^{-14} atm or 7.6×10^{-12} torr)
- Leakage rate less than $0.5 \text{ cm}^3/\text{min}$ during 20 minutes processing time at 5 atm differential assuming H_2
- Compatible with hydrogen, oxygen, water, water vapor, other volatiles
- Tolerant of vibrations up to 10g at 80-100 Hz
- Reusable up to 40 open/close cycles
 - Resistant to lunar radiation environment
 - Resistant to damage from lunar dust
 - Material repels lunar dust or has means to remove dust from seal*
 - Material flows around lunar dust trapped at seal interface*
- Light weight → Small load to achieve a seal
- Inexpensive
- High reliability → Low number of components
- Geometrically compatible with interface requirements

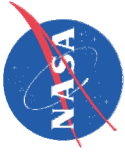

Challenges of Sealing Hydrogen Reduction Reaction Chamber

- Same requirements as the volatiles characterization oven except:
 - 900 °C
 - 3 batches processed at 900 °C
- Initial bench testing allows the volatiles characterization oven to be separate from the hydrogen reduction chamber.
- Want the same chamber for both processes to reduce weight .

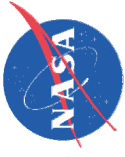

Some Options for Sealing VCO

- O-Rings
 - Metal
 - Viton A -
 - Teflon – cold flows around single layer of dust particle
- Tungsten Carbide Knife edge on Tungsten Carbide
 - Knife is very hard and very sharp for cutting any particles between it and the hard flat sealing surface
- Knife edge into Indium or other soft metal that could be re-melted after each use to restore the “gasket” material.

Key: Protect sealing surface from dust !

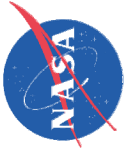

A Volatiles Characterization Oven Concept

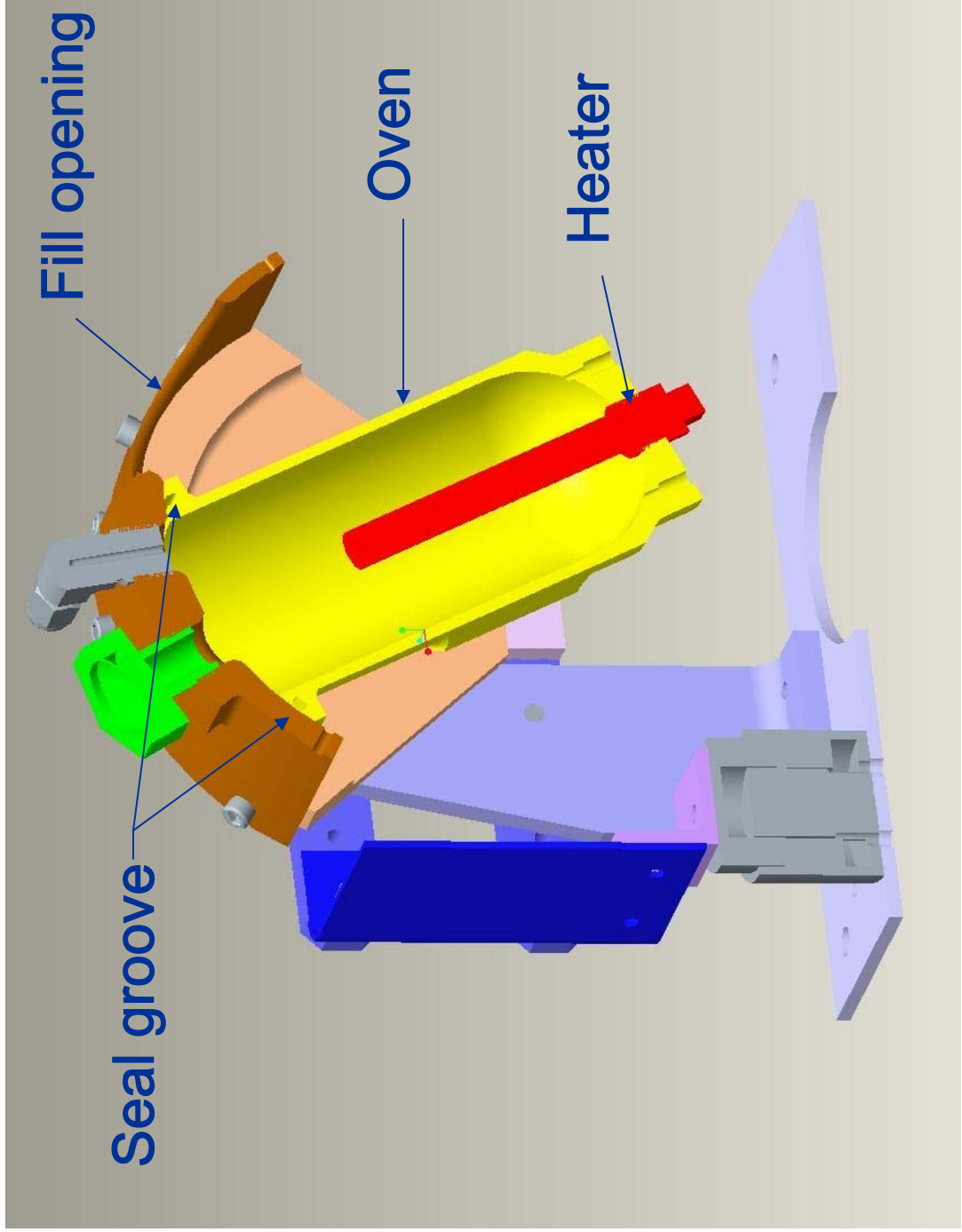

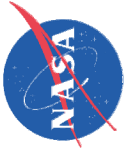

Summary

- Lunar dust poses a challenge to long term missions on the moon.
- Assessment of material capabilities in the lunar environment is needed.
- Protecting and/or cleaning sealing surfaces of lunar dust must be addressed for re-usable seals.
- The RESOLVE project poses a challenging seal problem.