



# **SHARPI/PICTURE sounding rocket telescope**

**D. Content, S. Antonille, T. Wallace, D.  
Rabin, S. Wake**

**NASA GSFC**



# Overview of talk

- Intro – lightweight precision mirror development
- Two sounding rocket concepts sharing a telescope
- OTA overview
- PM development program
- PM figure testing
- Mirror coatings
- PM mount & verification
- SM
- OTA

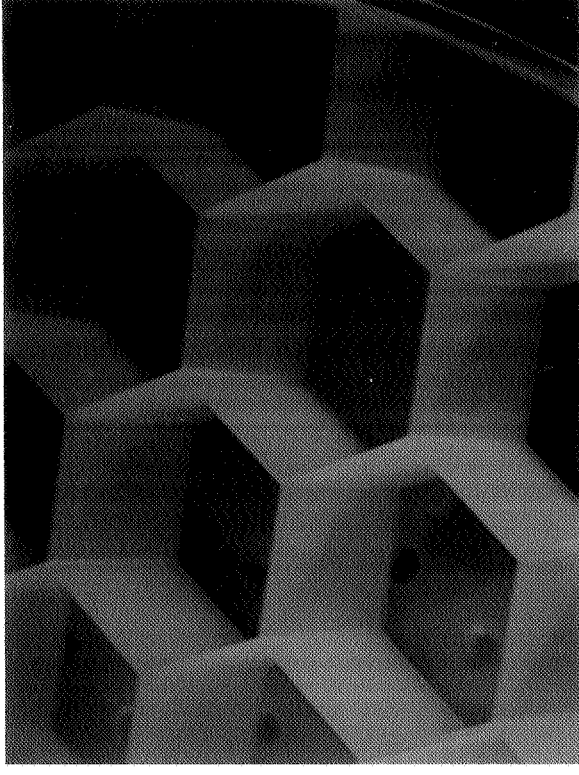

Detail of SHARPI PM over mounting pad



## Technology area – lightweight precision optics

- Combination of high precision and light weight allows new missions
  - Small missions with better system performance
  - Larger apertures at high performance with launchable weight
- Working definition – high precision is at least visible diffraction limited; lightweight should be ~JWST mirror weight ( $\sim 25 \text{ kg/m}^2$ ), but be careful
  - Areal density is (at least) linear with diameter for fixed stiffness
  - Comparisons among many mirrors can be difficult
- We (or SHARPI PM vendor ITT{Kodak}) have reported on development of the SHARPI PM at previous Tech Days
- Collaboration with PICTURE team is a fairly recent development
  - Only by combining resources can this level of technology be implemented on sounding rocket budgets, but this raises flight maturity more rapidly than any alternative – risky but win:win
- Hoping to fly this telescope in CY2007!



## PICTURE AO Coronagraph on a Sounding Rocket

- B.U. (S. Chakrabari), J.P.L., MIT(Lane), GSFC (Rabin), NGST and LMCO
- A mini-version of the TPF-C proposed concept.
  - 1 potential target, Jovian planet around E Eri. (3e-8 contrast)
  - Selected jan 2005, 2 flights jan-feb 2007 and july-aug 2007.
  - CDR july 2005
  - Nuller, with calibration system (no fiber bundle)
    - Working at 1  $\mu$ M
  - 1000 element DM in 1 arm of nuller

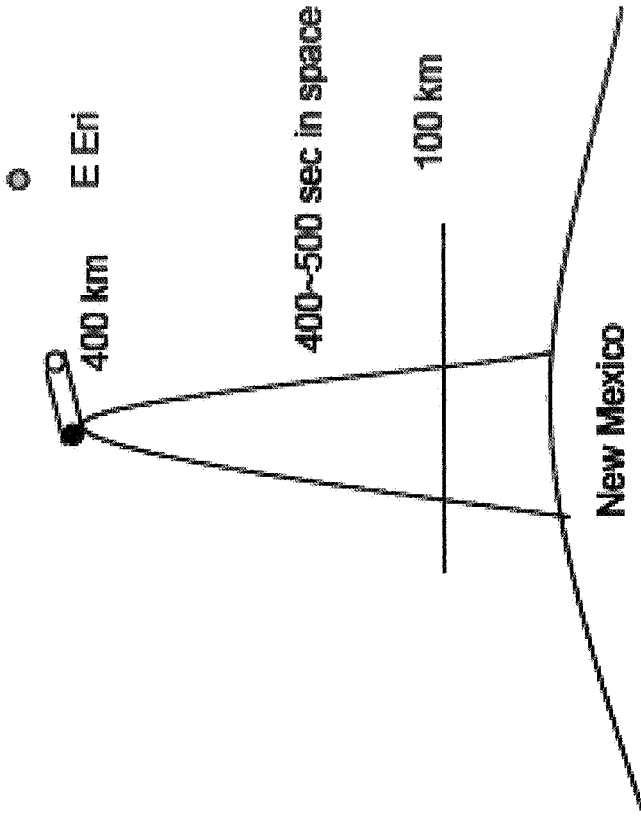

This is a low cost, high payoff, quick turnaround attempt at direct Imaging of an extrasolar planet; it's the ONLY funded exoplanet imaging experiment funded in the aftermath of TPF “deferral”



# Solar High Angular Resolution Photometric Imager (SHARPI)

- Sounding rocket telescope for 0.2" solar imaging over 70" in the far ultraviolet (160nm)
- Primary Surface figure error budget allocation ~7 nm RMS  
70"

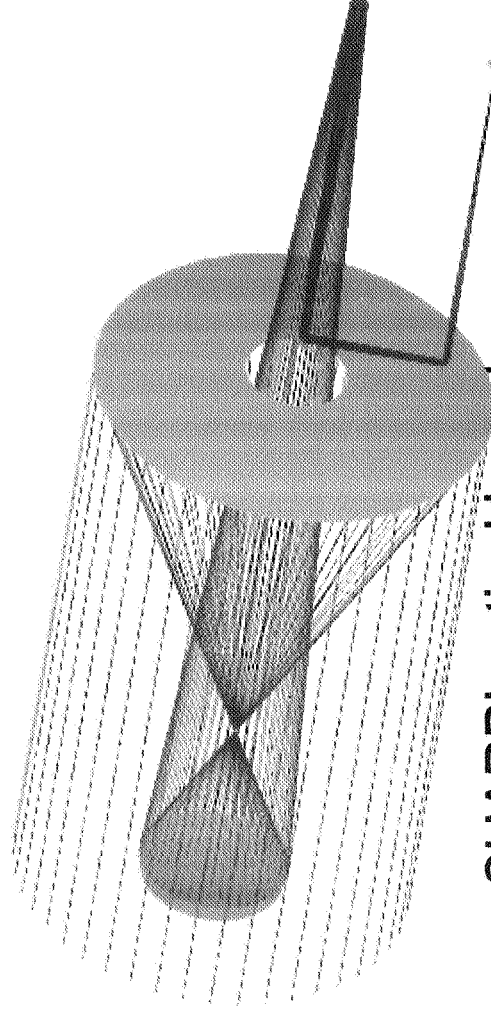

SHARPI optical layout

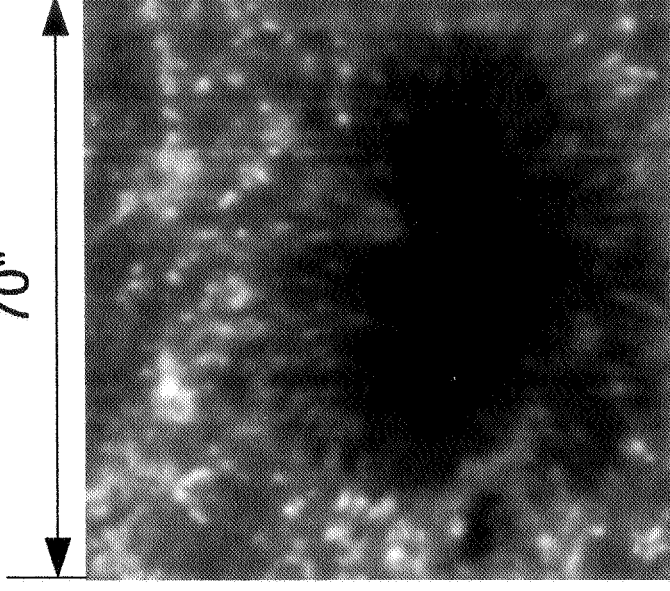

SHARPI science not yet funded,  
will be proposed in 2008

TRACE image of sunspot  
160nm, 1" resolution



# PICTURE hardware overview & roles

- BU: Supriya Chakrabarti PI; management, rocket, operations, machining
- JPL: M. Shao, M. Levine; visible nuller, instrument
- MIT: B. Lane – science cameras
- GSFC: D. Rabin, D. Content; telescope

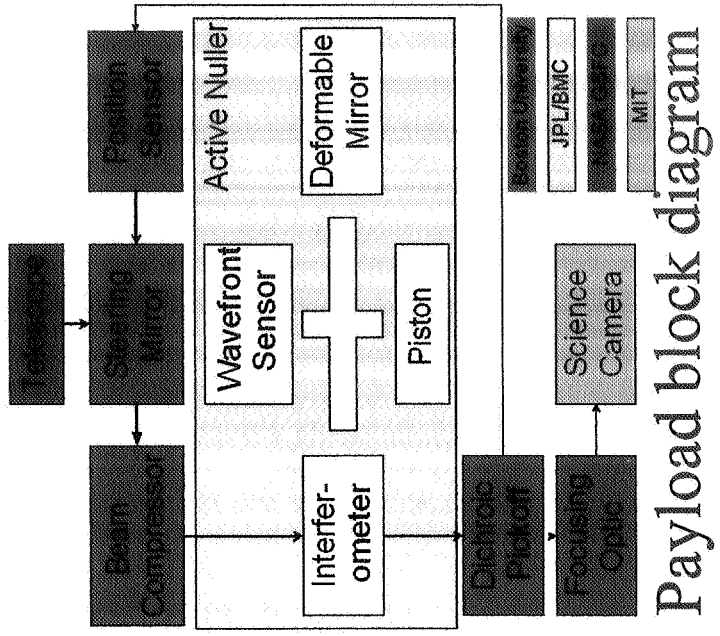

Payload block diagram

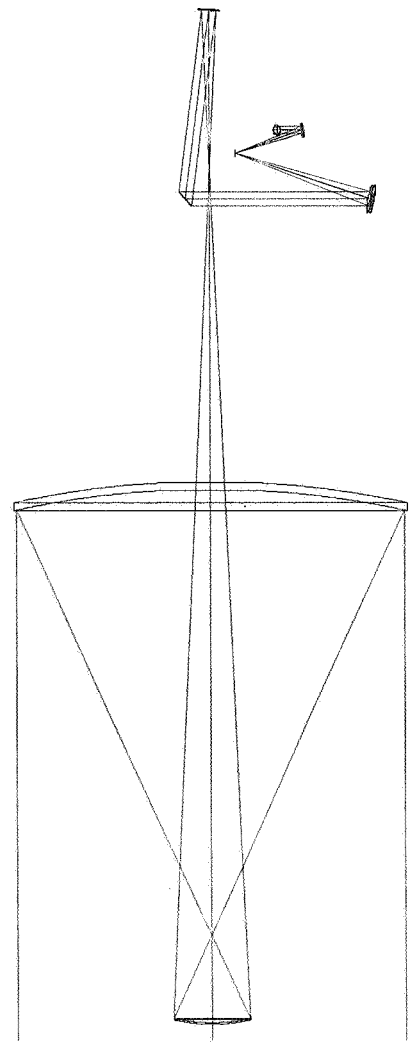

Optical layout

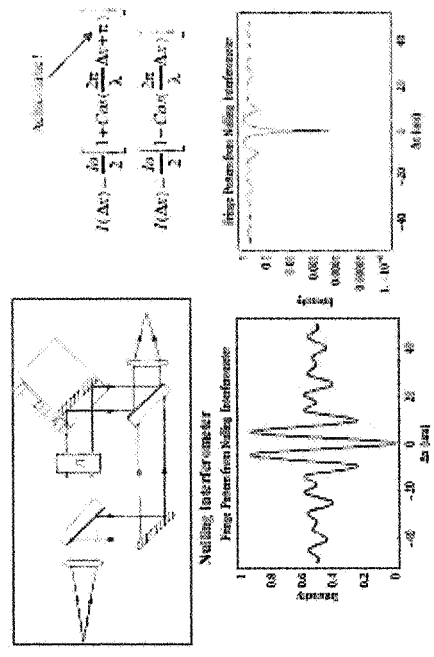

Visible nuller concept



## Overview of OTA hardware

- SM from SSG/Tinsley SBIR-02-II
  - SiC w/ Si cladding, also 20kg/m<sup>2</sup>, 11cm clear aperture, 3 nm rms figure
  - Ti, Al pieces for SM mount in fabrication (BU design)
  - Tolerances for SM come from JMEX phase A studies in 2001/2004
- Structure is Ti and composite metering structure w/ rocket skin outside
  - Star tracker is mounted in front of secondary
  - SM on 4-vane spider
  - Adjustments for ground alignment only
- 0.5m PM is largest to go on a sounding rocket

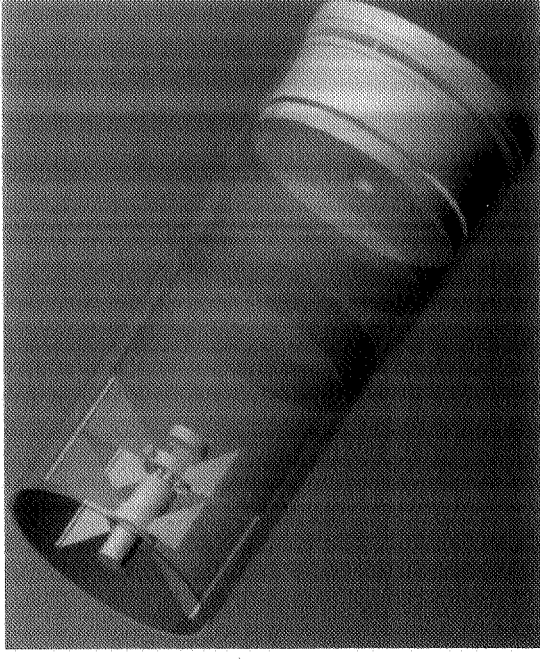

Telescope assembly

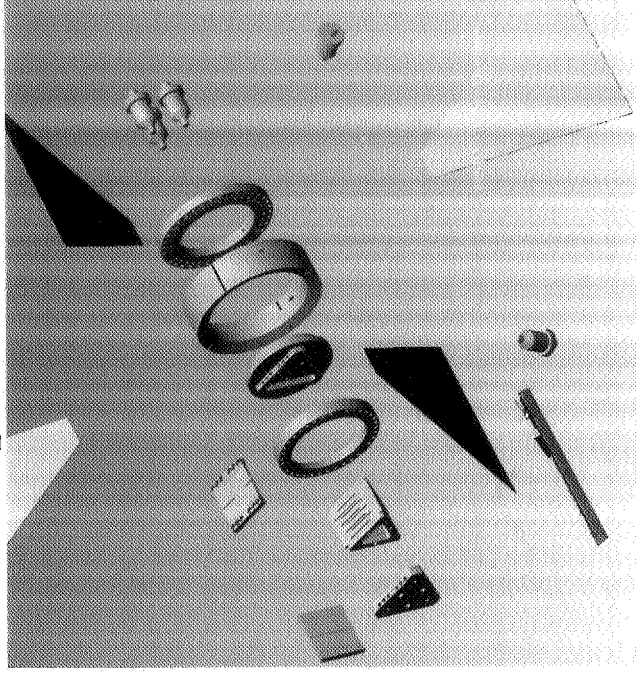

SM & spider assembly



## PM development overview

- PM completed with help of Kodak IR&D; their measurement of figure quality over 0.508m CA was 7 nm rms with 1g vertical effects backed out
- We have tested the mirror horizontally but with some captured strain from GSE mount; when this is backed out we see good agreement
- Currently analyzing data from vertical CGH test of PM
- Will use Parks method of separating test error from mirror error
  - Data taken at 12 rotated positions of PM relative to test beam
- Subsequent steps and rough schedule, details below

- Coating [September]

- Mounting [October]

- Vibration [November]

- OTA assembly & Alignment

[December]

TechDays 06Sep20 Content et al.

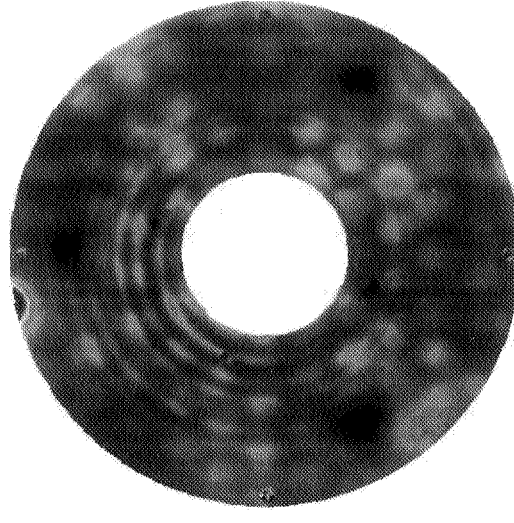

Left –GSFC horizontal data; Right – ITT data





## PM Vertical CGH figure test – fall '06

- 2-sphere test extended to aspheres
  - Evans & Kestner, Appl. Opt. 35 1015 (1996).
  - By rotating to  $n$  positions, asymmetric errors up to  $n$ -theta order can be measured
- Zygo GPI folded via MUX cube, PSI down from MUX
- Removable kinematic mount for CGH
- PI Hexapod on rotation bearing with 12 detent positions ( $30^\circ$ )
- Previous work did a partial calibration of CGH with good success {ref Antonille}

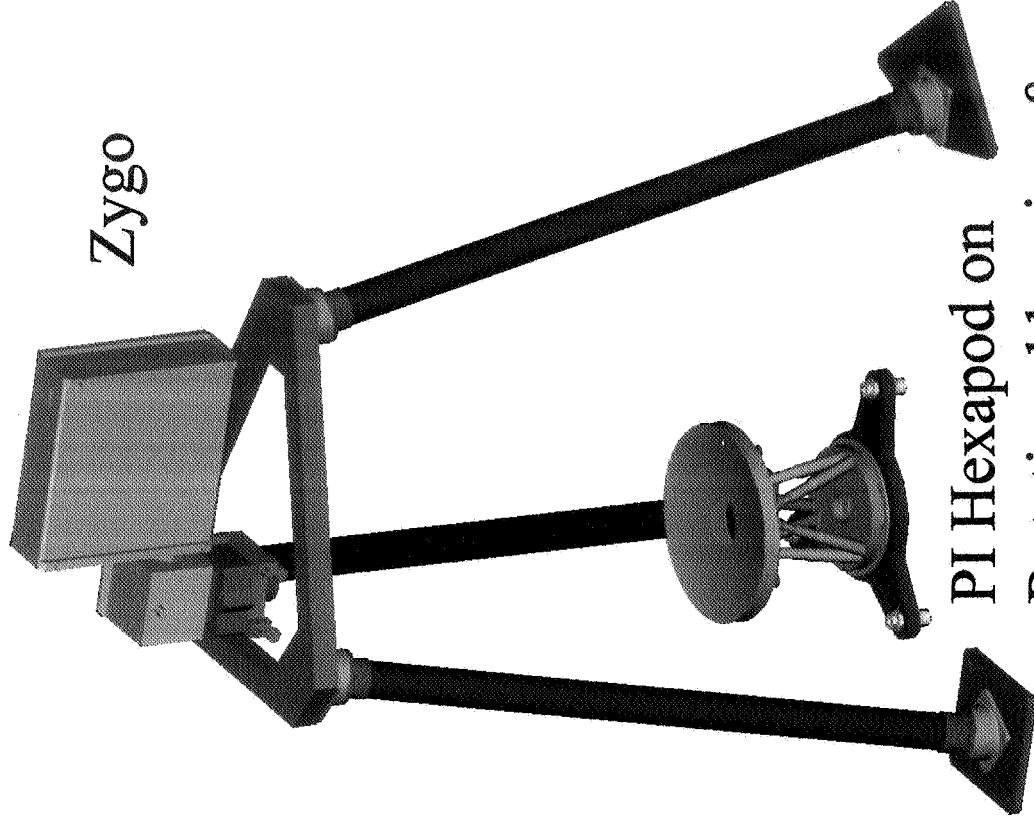

PI Hexapod on  
Rotational bearing &  
3pt tip/tilt adjuster



## PM figure test, continued

- Tower made from low-CTE carbon fiber tubes; tent gives good thermal isolation
- To date, we are sure the PM meets PICTURE req'ts & that we can remeasure after coating, during mounting, & after vibration
- Complications include CGH distortion, 1g residual is much larger than figure error

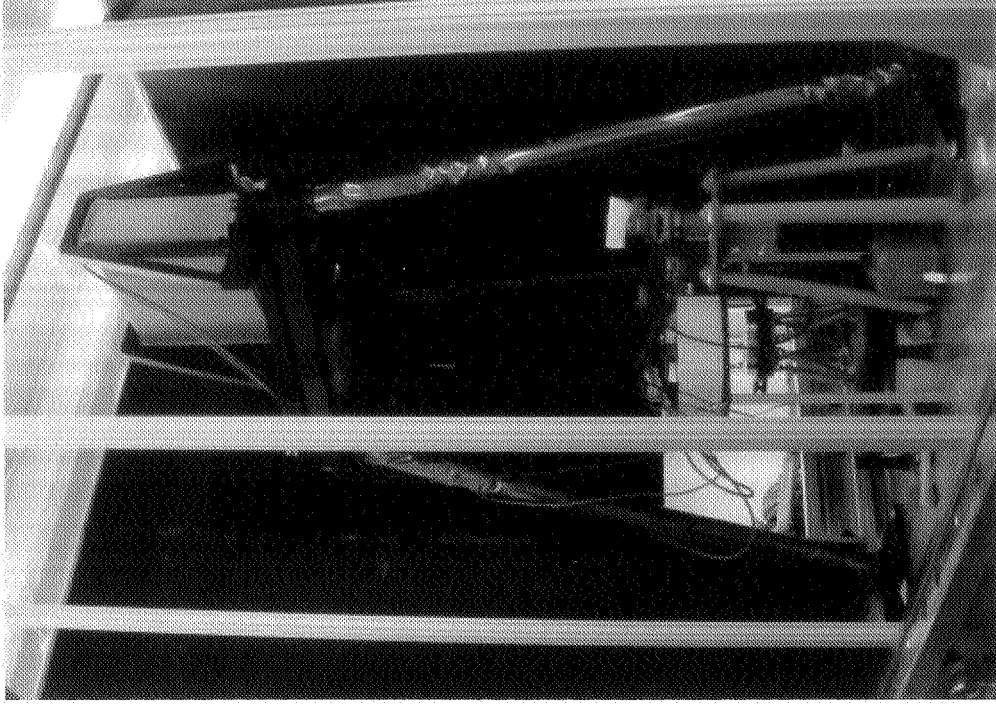
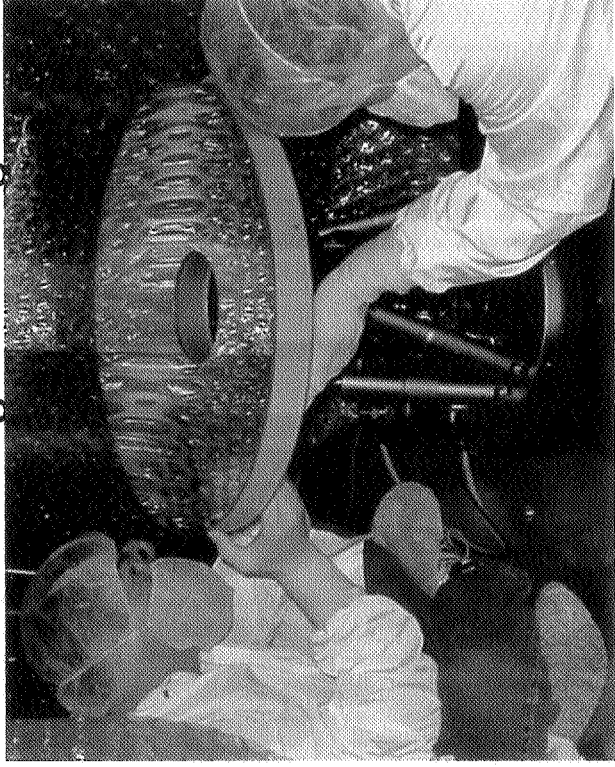

Picture of tower w/ tent under construction



## Mirror coatings for exoplanet coronagraph

- Work on TPF-C showed that performance can be very sensitive to mirror polarization depending on spectral bandwidth and speed of optics
  - for TPF-C the choice was custom protected Ag coatings on all fast optics
- Team worked to determine 'easy' coatings that could be done cheaply {in-house} and quickly
  - PM: Al SiO<sub>x</sub> {1 ≤ x ≤ 2} over ULE fused silica
  - SM: {Cr} Ag Al<sub>2</sub>O<sub>3</sub> SiO<sub>x</sub> over Si {SSG mirror is Si-clad rbSiC, see their talk}
- Design uses 0.5λ dielectric thickness on SM and 0.25λ on PM
- A few% uniformity is required



## PM mount

- Concept is telescoping, liquid pinned bipod mounts
- To be assembled 'around and under' PM in figure test tower
  - Allows watching figure as the mounting progresses
  - Design analyzed & optimized via finite element modeling & iteration
  - Hexapod allows controlled lower of PM onto flight mount while measuring figure
- Mechanical hardware requires tight tolerances
- All PM assembly parts are in hand, lapping and preassembly underway

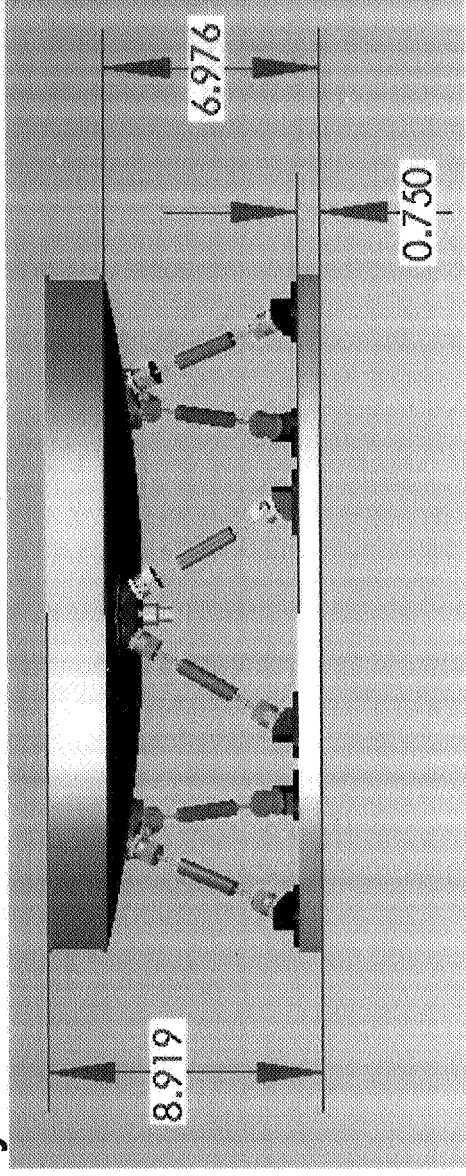



## Secondary mirror -- SM

- Fabrication described by SSG; SSG SBIR-2002-II, J. Schwartz
- 122mm aperture concave elliptical asphere,  $R=226.29$ ,  $k=-0.6633$ 
  - Mild asphere,  $\sim 10\lambda$  departure from best fit sphere
- Requirement for surface quality – let us only worry about the PM!
  - 3.0nm rms figure, 1.7nm rms midfrequency {1-10mm band}
  - MET by SSG/Tinsley on Si-clad rbSiC with Invar mount
- Ready to coat, will verify no major figure change after coating

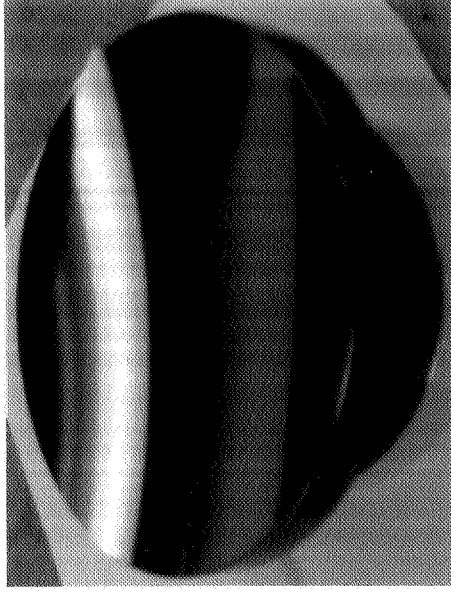

Y+, looking at optical surface

Y+ looking at back of mirror

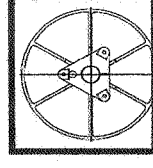

13.8



-11.85



# Optical telescope assembly

- Horizontal alignment in cleanroom
- We have borrowed & calibrated a 0.5m flat from JPL
- We have calibrated the f/11 transmission sphere
- Alignment expected to be straightforward except for
  - PM gravity sag (previously measured)
  - Telescope tube sag (modeling underway)



# Summary

- Flight build underway;
  - All PM parts in house by mid-September
  - All telescope parts in house expected by Oct1
  - PM figure testing complete
  - PM coating expected late September; SM coating to follow
  - Hope to deliver completed telescope for CY07 1<sup>st</sup> launch
- Acknowledgements:
  - This has been a long term collaboration with ITT Space Systems, we thank them for their hard work (& IR&D contribution)
  - Many people at GSFC contributed to this effort over the year, we want to mention particularly
    - J. Davila, J. Gum, S. Irish, R. Keski-Kuha, L. Kolos, M. Quijada, S. Owens, C. Strojny, T. Saha, C. Stevens, F. Threat, S. Wake
  - We thank SSGPO & SSG/Tinsley for their efforts on the SM and QED for the confirming figure measurements
  - Thanks also to Schafer for the silicon foam new technology SHARPI mirror (see their talk)