

NORTHROP GRUMMAN

DEFINING THE FUTURE

Space Robotics: AWIMR an Overview

FROM UNDERSEA TO OUTER SPACE TO CYBERSPACE

File Updated August 31, 2006

Rick Wagner
Northrop Grumman Corporation

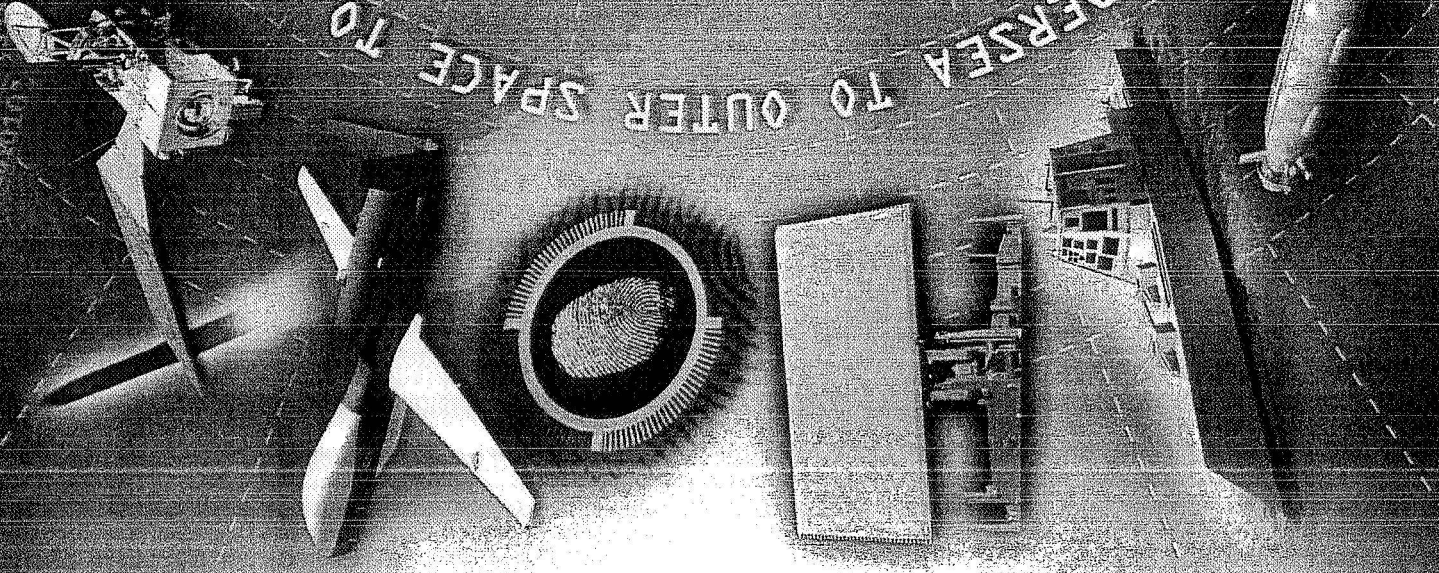
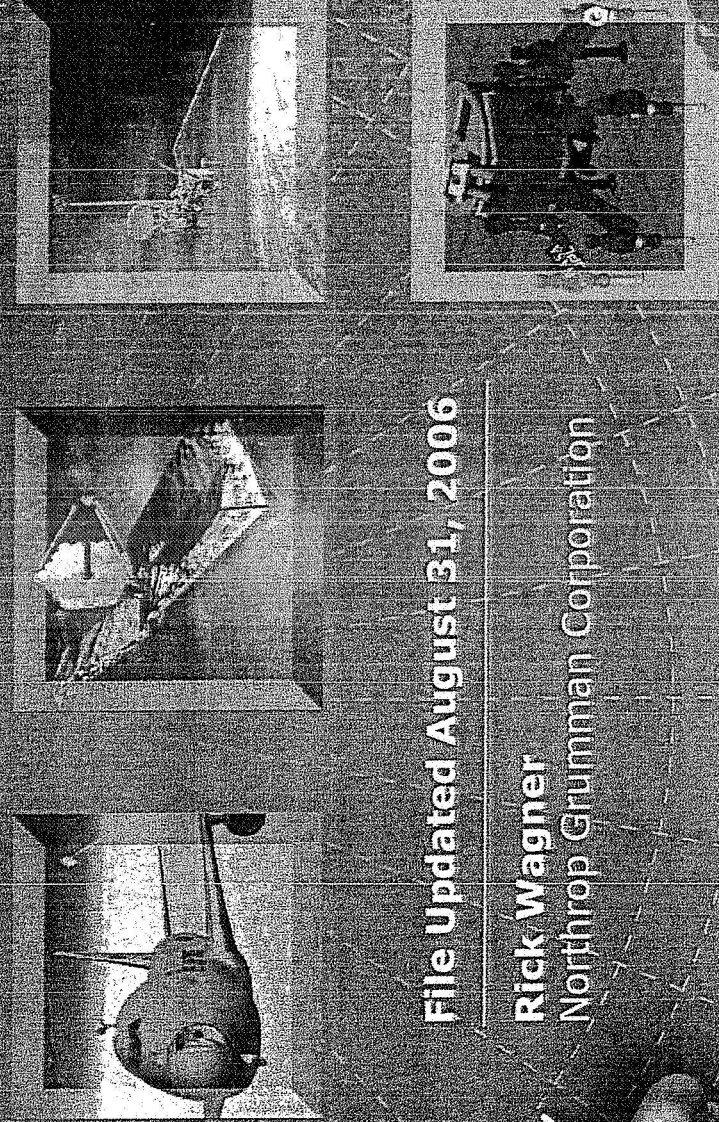

Agenda

- Meeting mission goals
 - Space robotics requirements
 - Space robotics mission design
- Space robotics applications
 - ISS European arm, Robonaut, AERcam, Skyworker
 - AWIMR
 - Architecture
 - Zero-g locomotion
- Looking ahead
 - IEEE Robotics and Automation Society: Technical Committee
 - ICRA 2007 Workshop on Space Robotics

Applications: European Robot Arm for the ISS

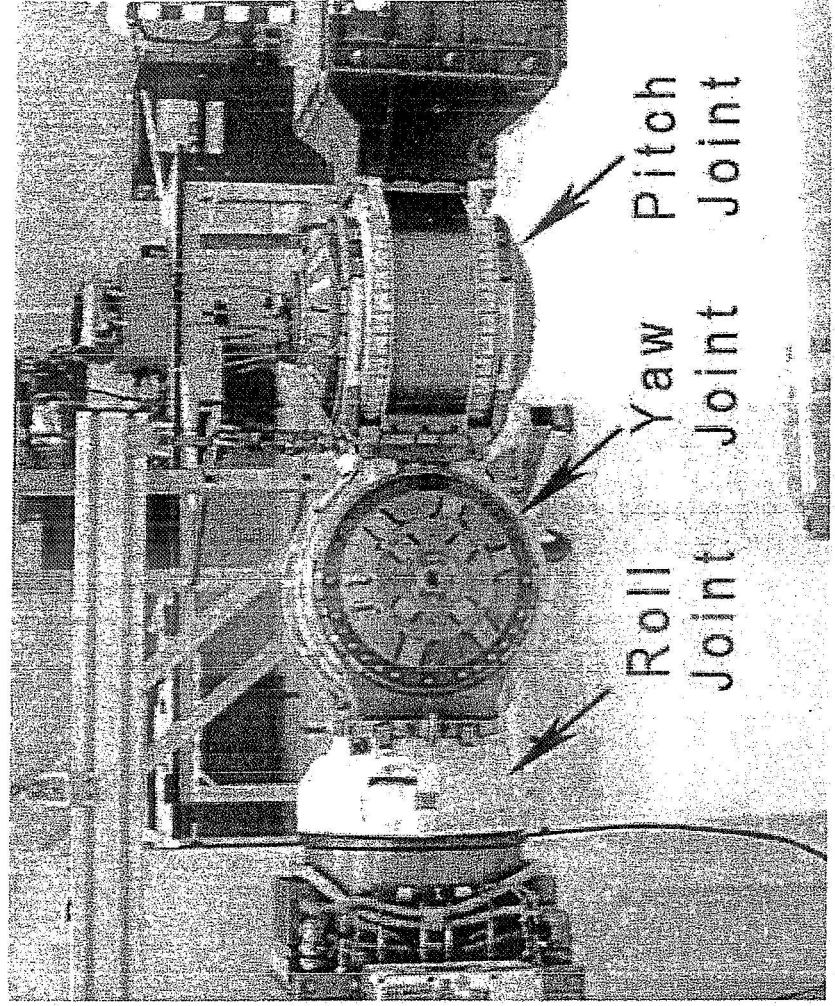
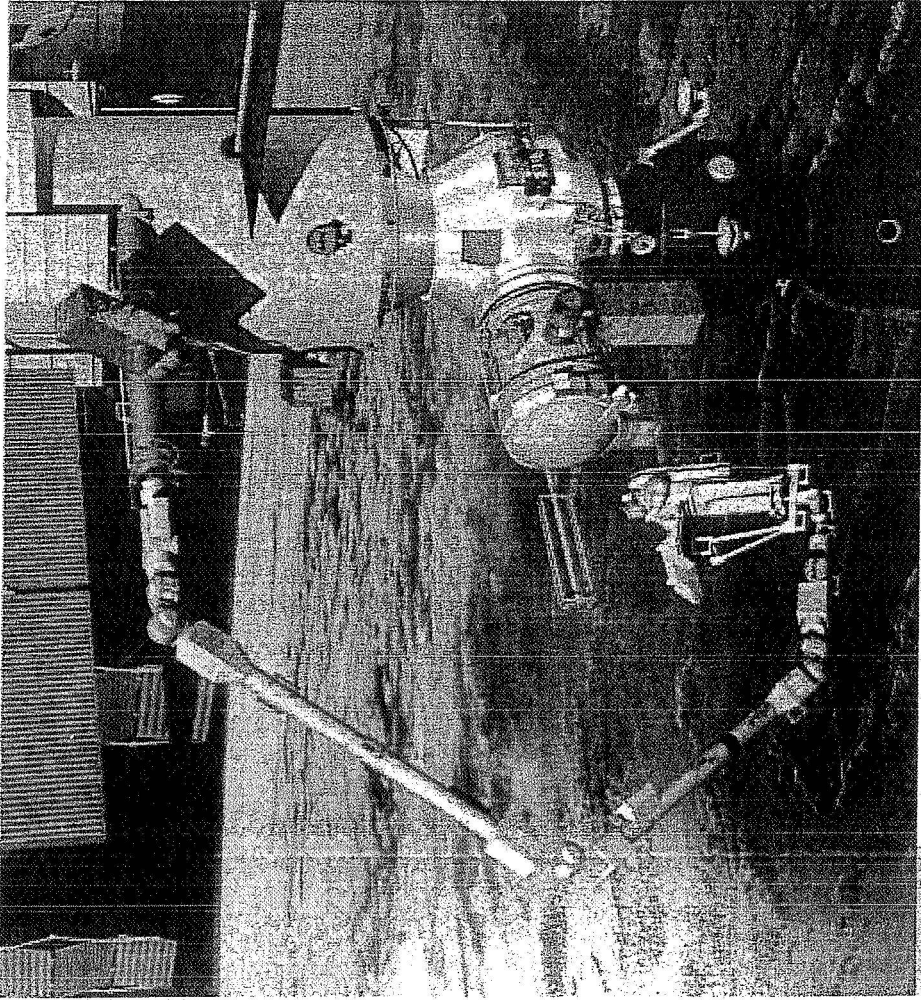

A wide range of space tasks (requirements) lend themselves to robotics

- **Inspection**
 - Micrometeoroid damage, structural fatigue, anomalous conditions
 - Structure, insulation, plumbing, wiring, fasteners
- **Cleaning**
 - Optics, coatings, thermal surfaces, windows
- **Astronaut Assistance**
 - Illumination of work area, transportation of parts and tools
- **Assembly**
 - Transportation and mating of structural elements
- **Repair**
 - Component replacement or reconfiguration
- **Replenishment**

Applications

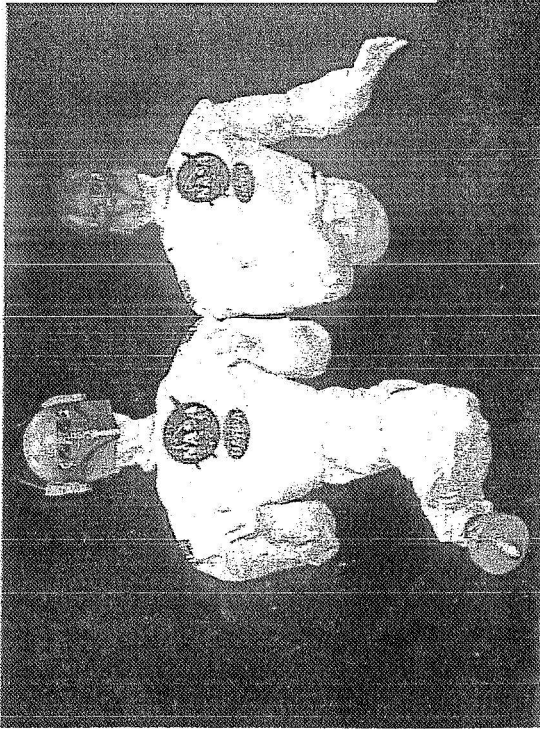

JSC's Robonaut

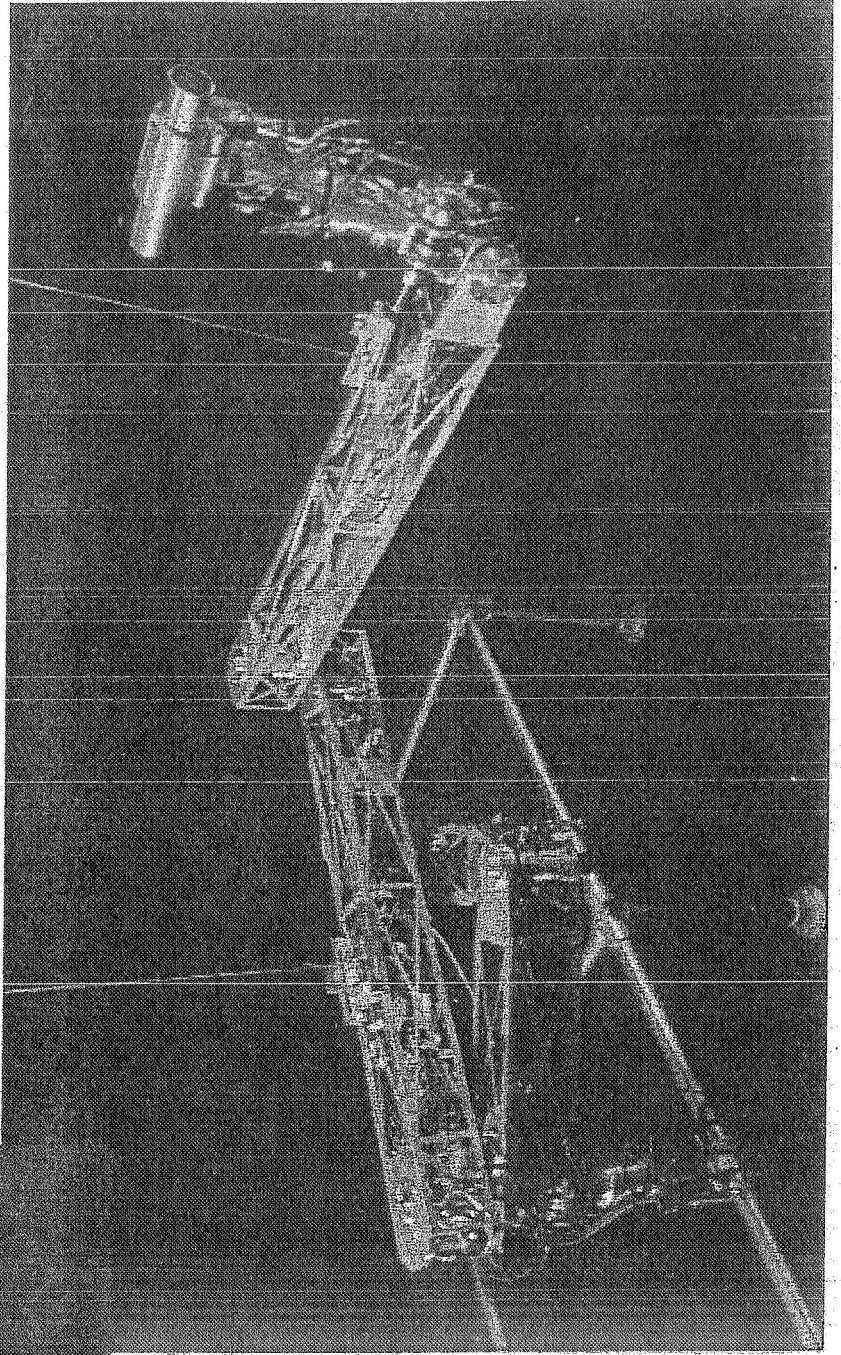

CMU's Skyworker

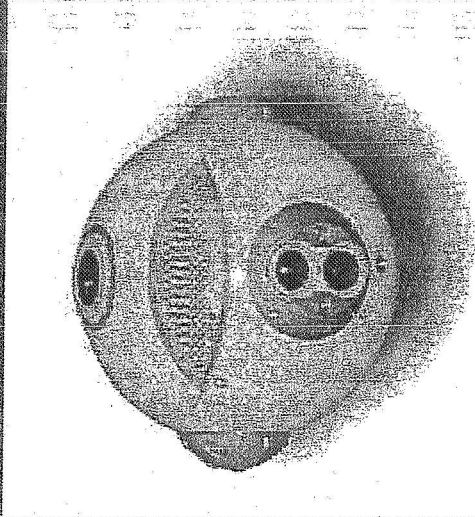

**JSC's mini AERCAM,
5 inches diameter**

System mission design considerations for space robots

NORTHROP GRUMMAN

- Trade study to determine a space robot task set
 - Candidate task set
 - System context for task definition
 - Benefit assessment
 - Tasks drive algorithm conceptual design
 - Algorithms drive hardware conceptual design
 - Determine costs (mass, power, complexity, reliability)
 - Iterate to develop an optimal task set
- Optimal task set drives algorithm development
 - Balance of teleoperation versus autonomy
 - Metric: percent autonomous operation (more autonomy reduces crew load)
 - Metric: efficiency (speed of autonomous operations versus speed of teleoperation)
 - Optimal sensing and control
 - Machine vision allows more flexible autonomy but increases computational complexity
 - Dynamic gates allows greater movement efficiency but increase mechanical complexity
 - General versus special purpose design
 - Special purpose design may be mass- and power-efficient for a smaller set of tasks
 - General purpose design may be more efficient for a larger set of tasks

Applications: astronaut assistance

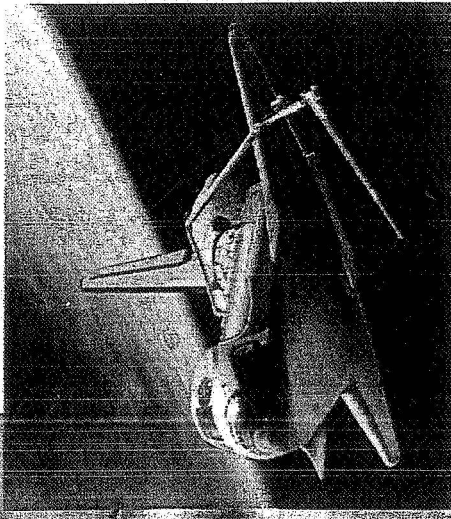

(a) RMS and OBSS Inspection

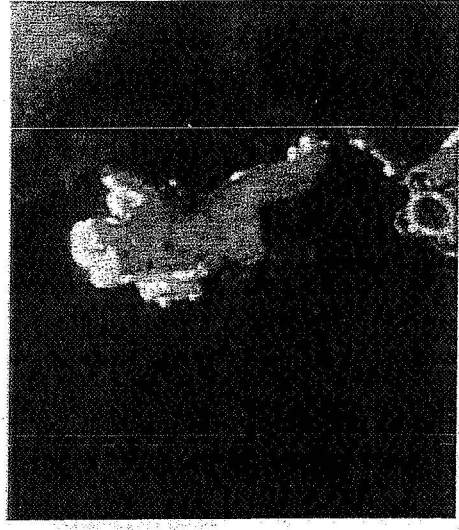

(b) Robotic/Human EVA Repair

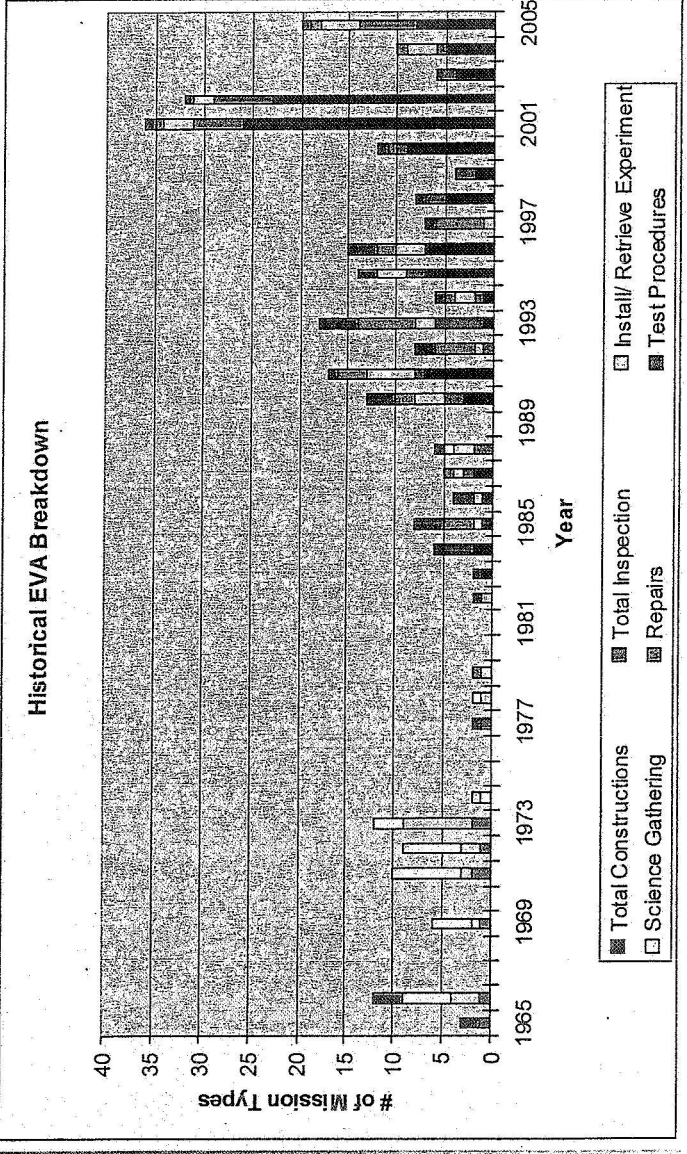
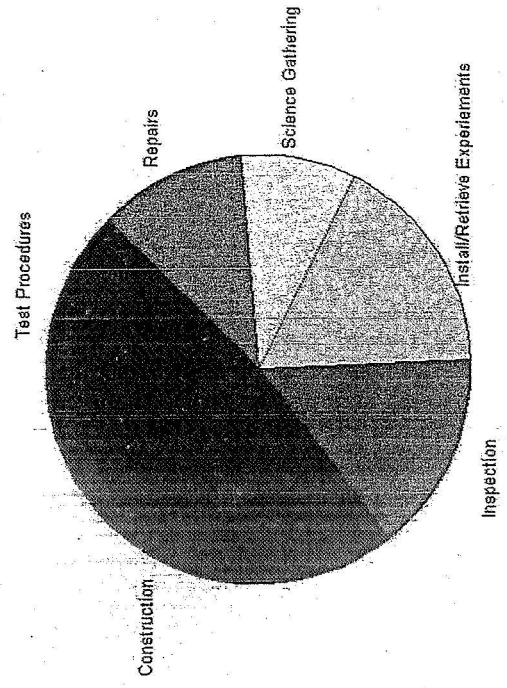

Proportion of EVA mission types

Frequency of EVA mission types

LEMUR I

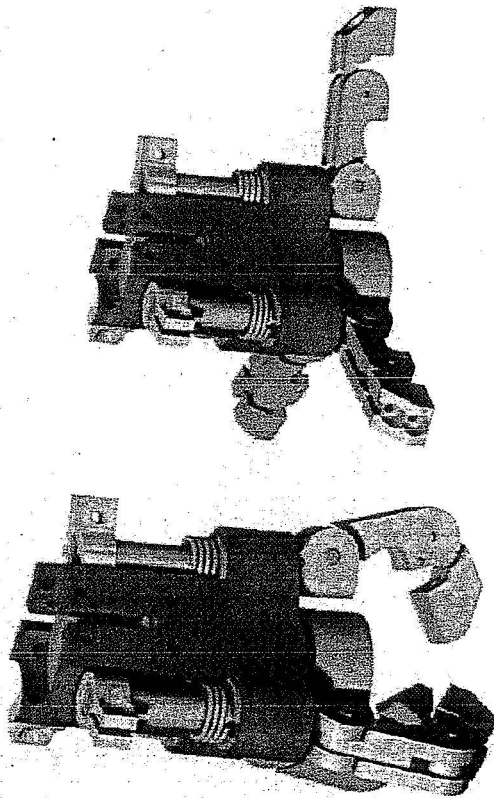
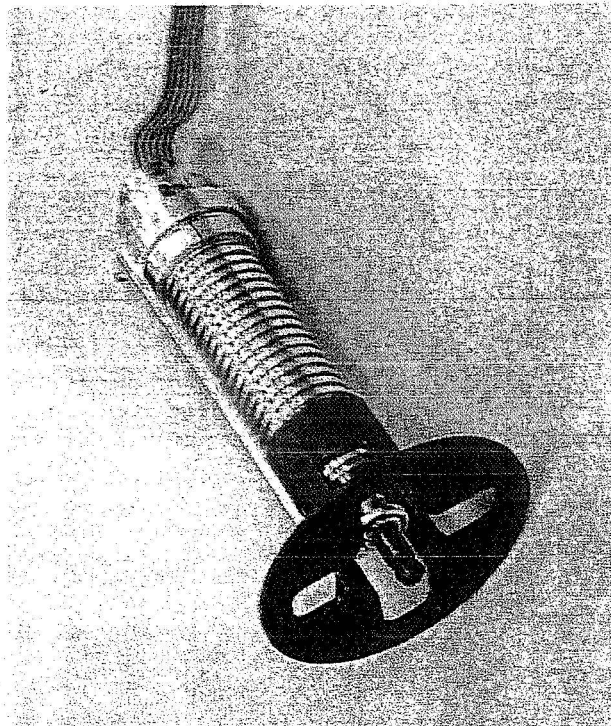
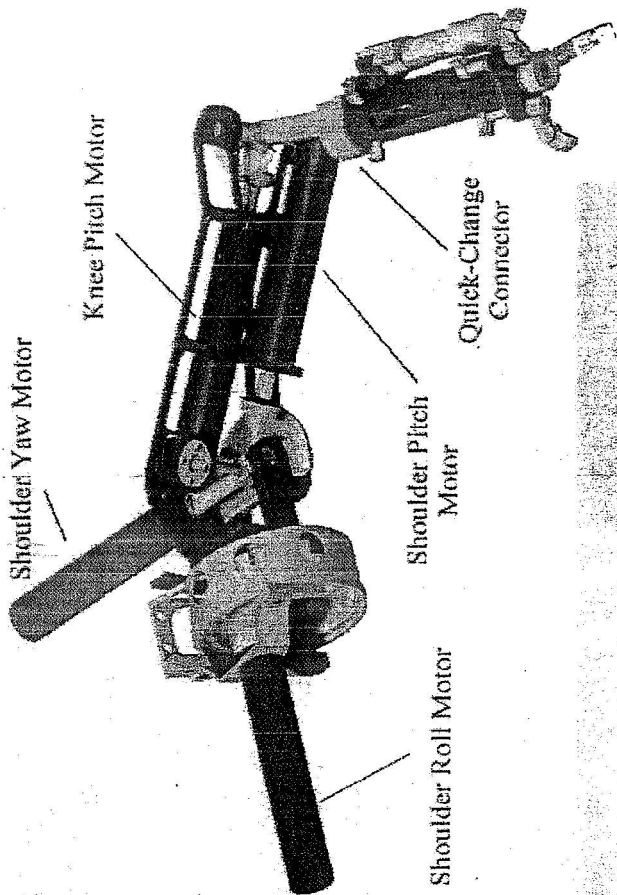
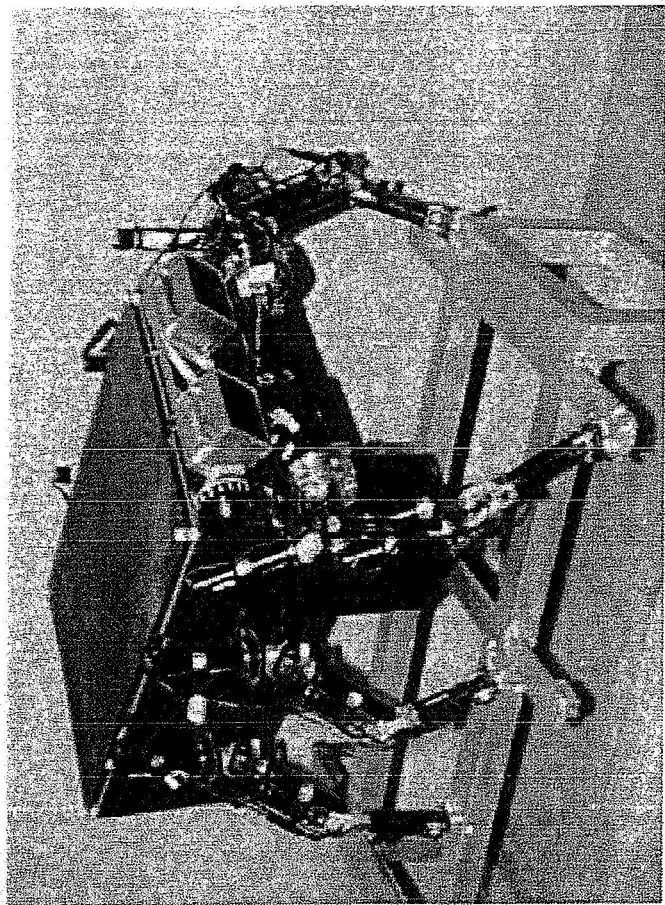

Mission design: AWIMR

- **Goals (subgoals of “reduce human EVA”)**
 - **Primary tasks**
 - **Autonomously patrol exterior of a space vehicle and look for damage**
 - Derived requirement: know when to recharge batteries and how to do it
 - Derived requirement: know where to walk and what to image
 - Derived requirement: know when to halt and call for human help
 - **Travel to a location when commanded and image specified areas**
 - Derived requirement: minimize human work (be as helpful as possible)
 - Derived requirement: be fast enough in tasks to be useful
 - **Secondary tasks**
 - **Repairs for a subset of damage types**
 - **Teleoperated mode for all capabilities (walking, imaging, repair)**
- **Constraints**
 - **Survive all space environments**
 - **Do not damage the space vehicle**
 - **Minimize mass, power consumption, maximize durability**

EVA cost and AWIMR applicability

Overhead Element	Time (minutes)
Suit checkout	162
REBA powered hardware checkout	25
SAFER checkout	30
Airlock config	92
Consumables prep	100
EVA prep - pre-breathe related	47
EVA prep - EMU related	30
Suit donning & leak check	60
SAFER donning	Done during pre-breathe
Purge	11
Pre-breathe	125
Airlock depress	28
Airlock egress	15
Airlock ingress	15
Airlock repress	15
Suit doffing	25
SAFER doffing and stow	10
Post EVA processing	95

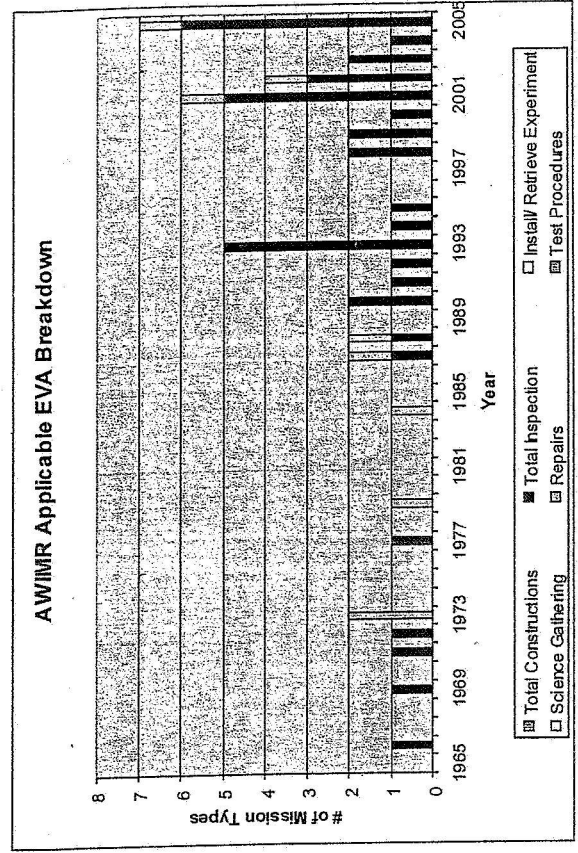
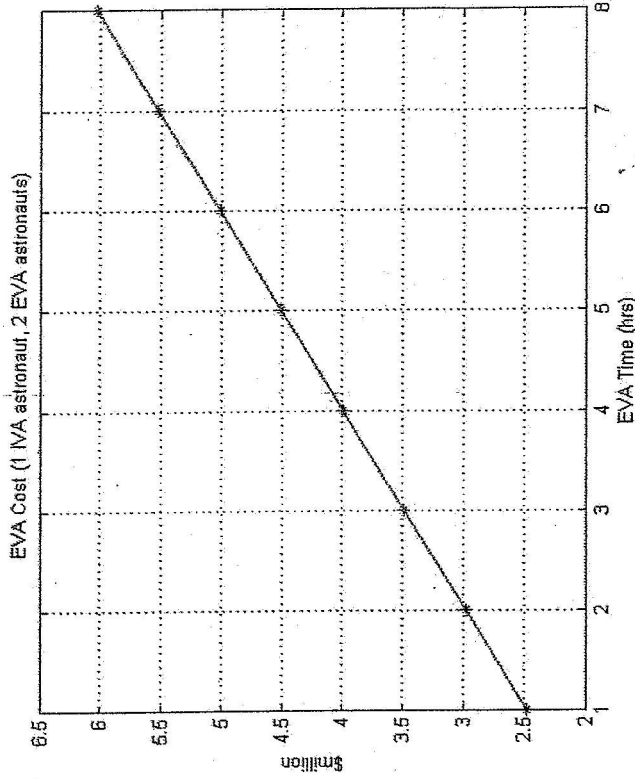

EVA cost historical data: costs in astronaut time (above left), costs in millions of dollars per EVA hour (upper right), and EVA missions that could have been avoided by AWIMR (lower right). EVA cost source: NASA JSC

AWIMR (phase 1 prototype hardware)

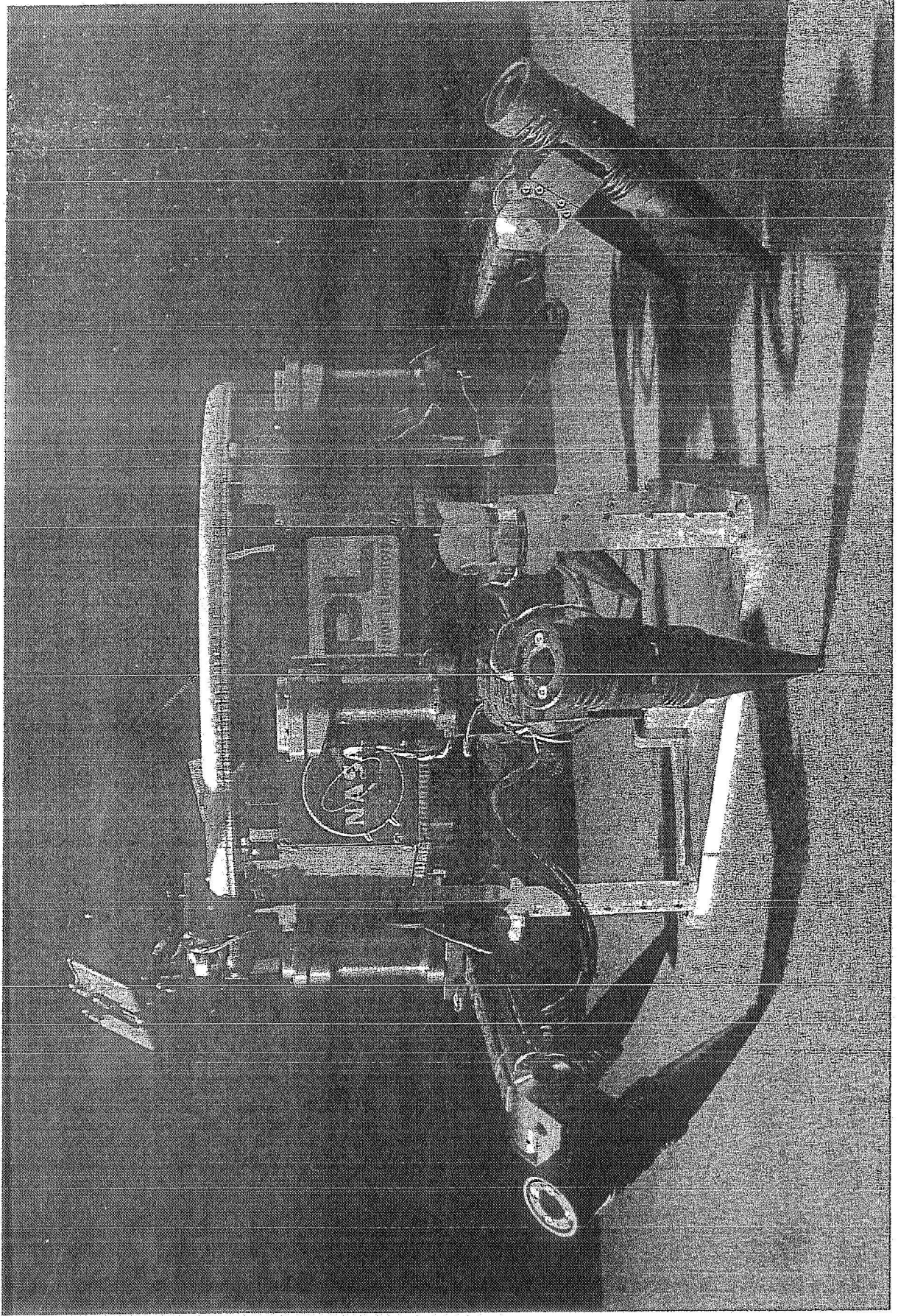

AWIMR prototype video

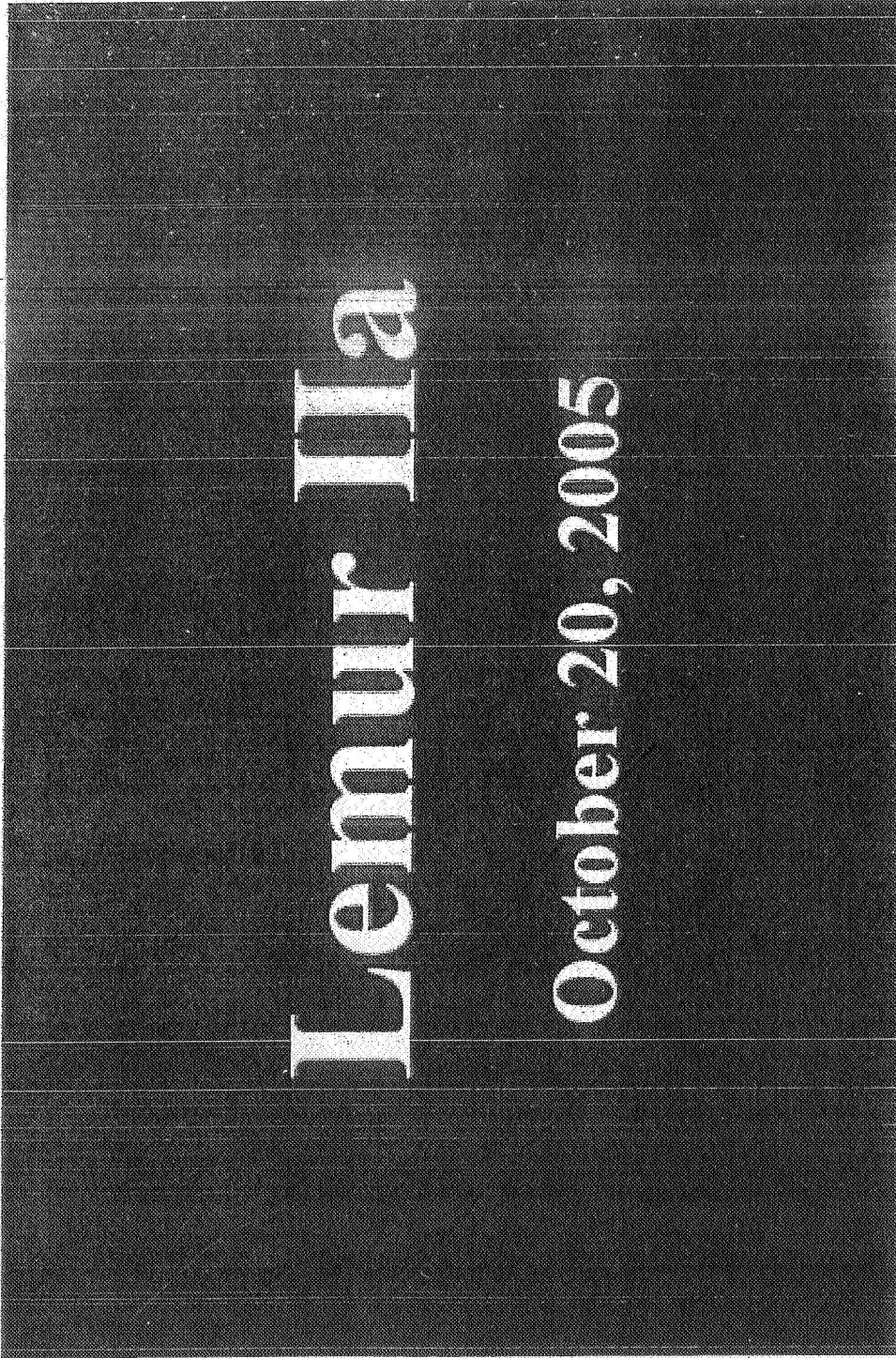

- The AWIMR phase 1 prototype is the Lemur IIa from the Jet Propulsion Laboratory (JPL), in Pasadena, California (the California Institute of Technology (Cal Tech) and the National Aeronautics and Space Administration (NASA)). The AWIMR program is managed by Ames Research Center (Sunnyvale, California) its prime contractor is Northrop Grumman Space Technology (at Redondo Beach, California)

AWIMR (phase 2 conceptual model)

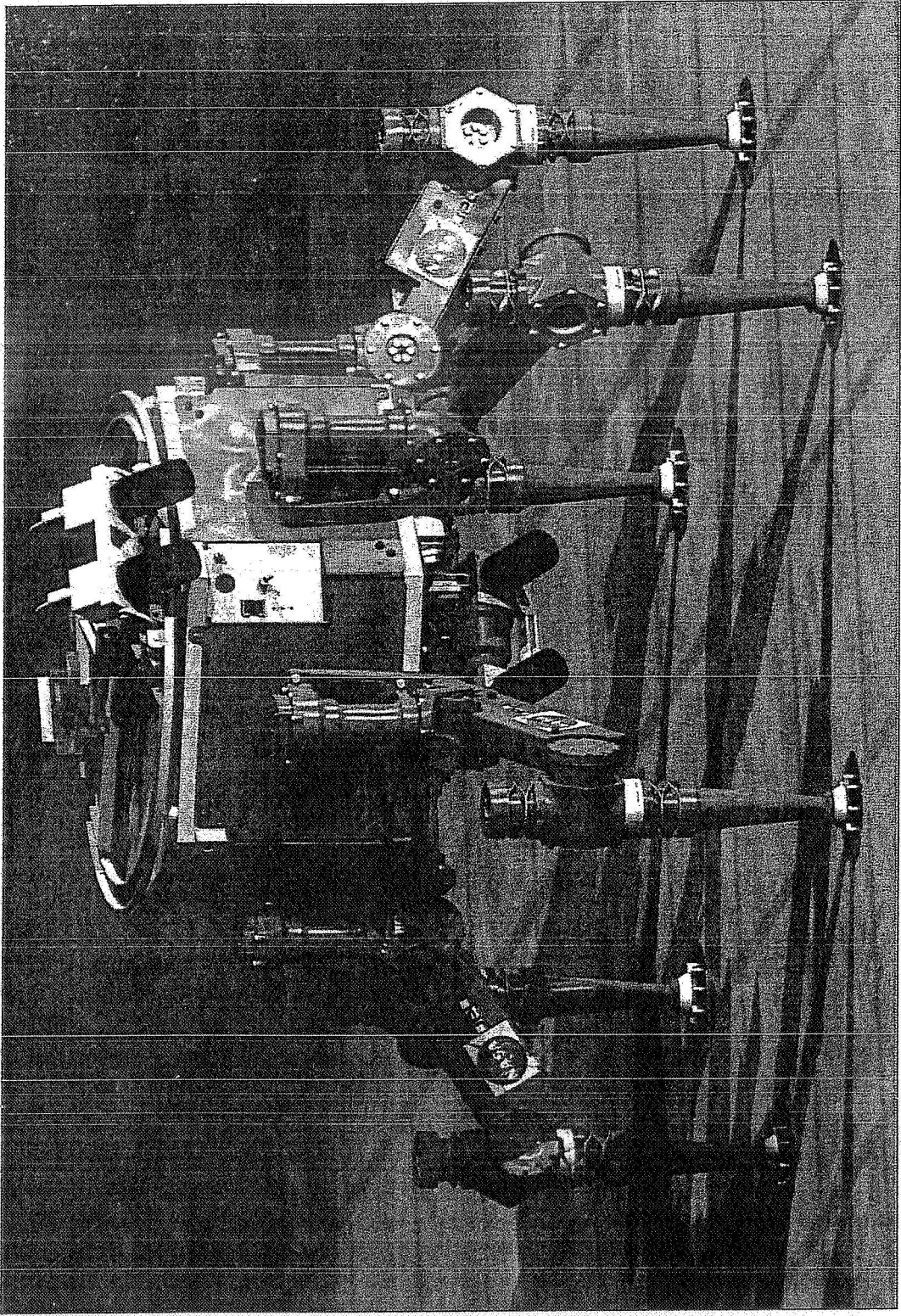

AWIMR on space shuttle video

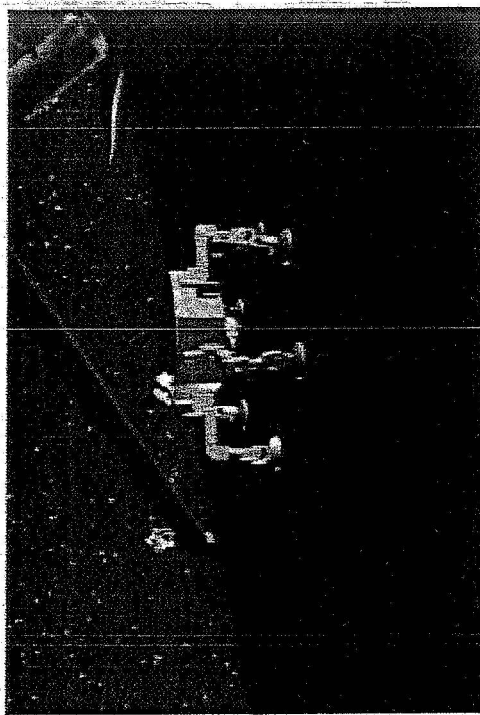

AWIMR phase 2 was to demonstrate zero-g walking with "sticky feet." AWIMR in this video is using the "pairwise opposed" gait developed for sticky foot locomotion in zero-g.

Hexapod sticky foot robot gaits

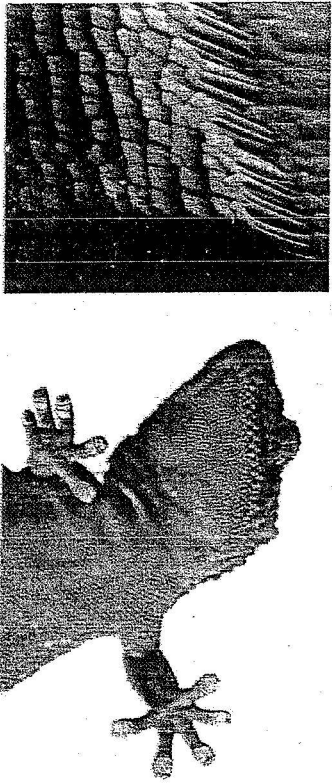

- **Ripple gait**
 - A single foot is moved at a time
- **Tripod gait**
- **Pairwise opposed gait**

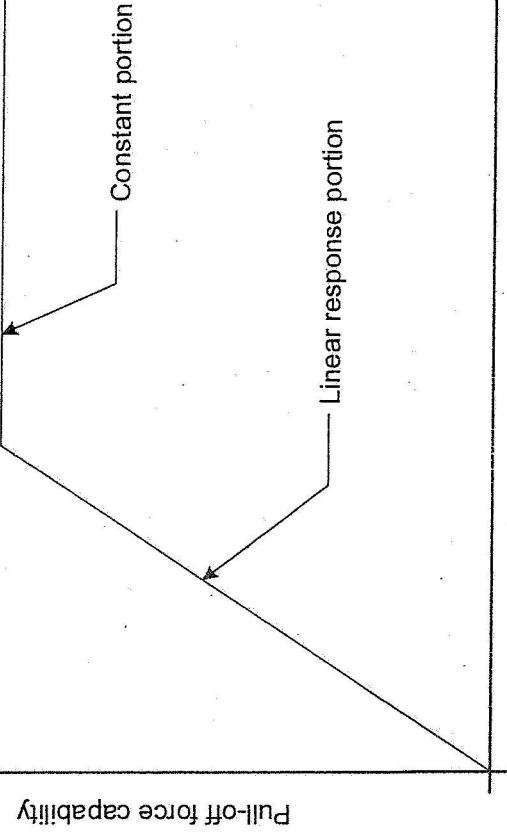
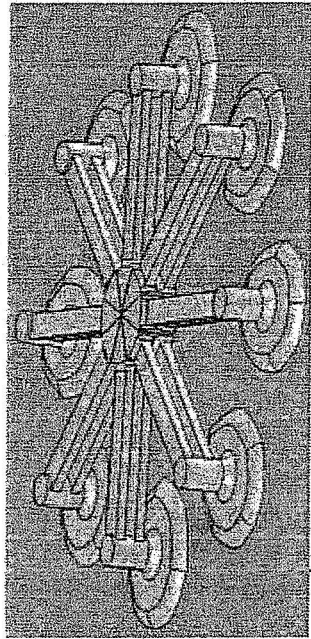
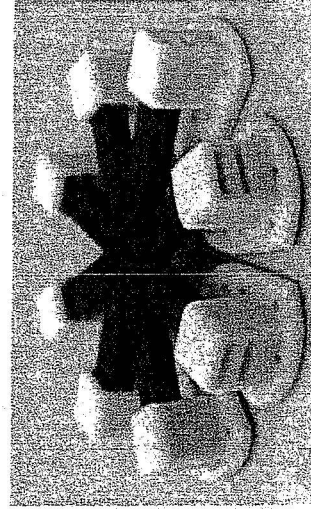
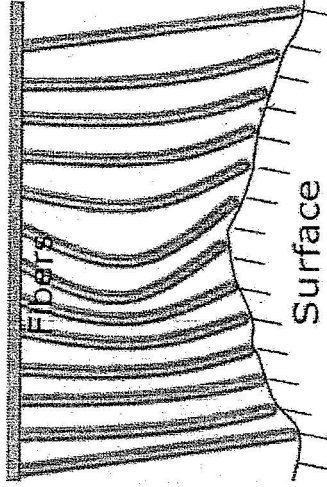

Inspired by the gecko's micro-fiber sticky foot, polymers such as polydimethylsiloxane provide repeatable sticky force greater than preloading force. We found that sticky feet require attention to the zero-g gait.

Sticky foot design

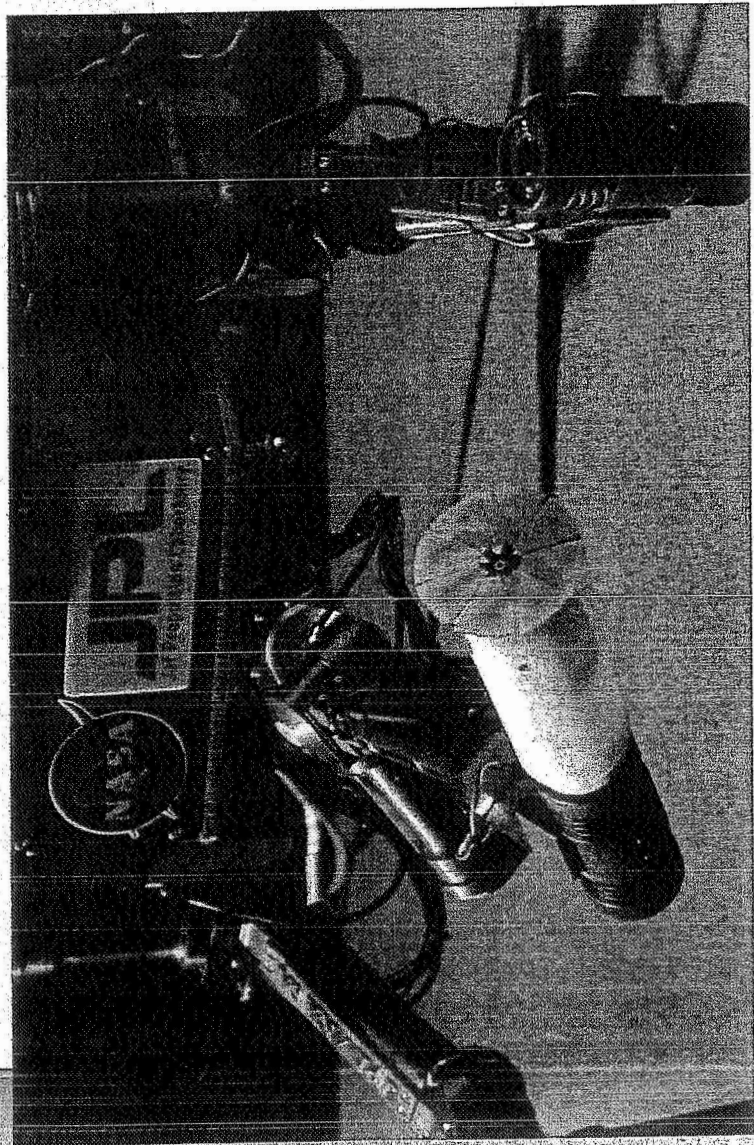
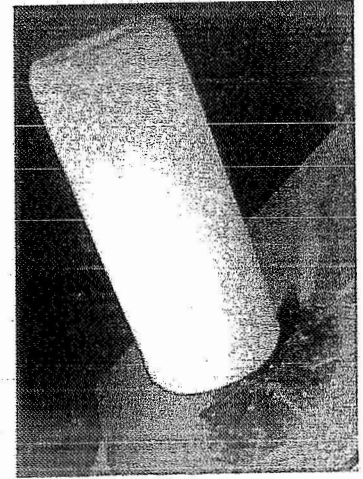
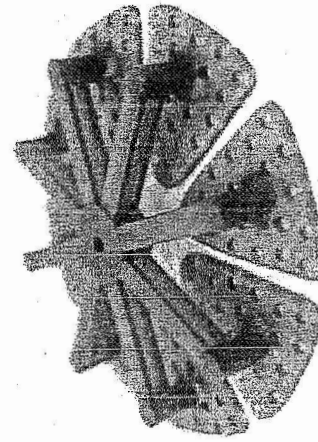
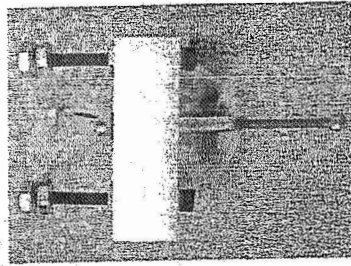
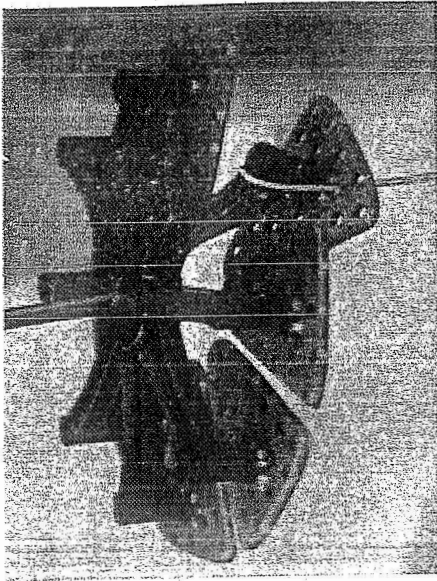
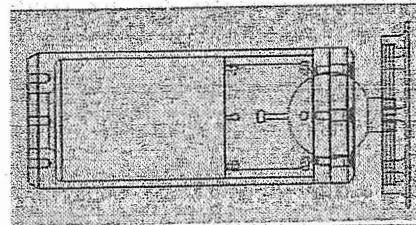
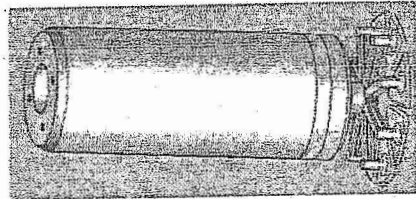
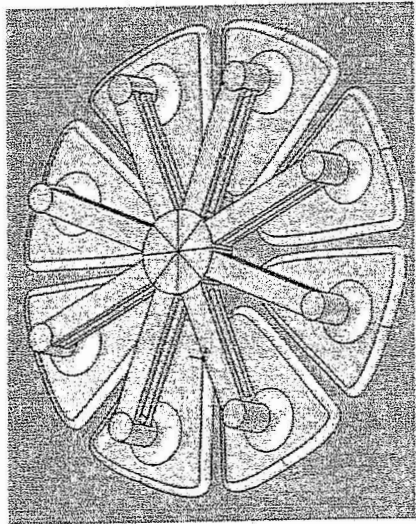

Ripple and pairwise gait preload force analysis

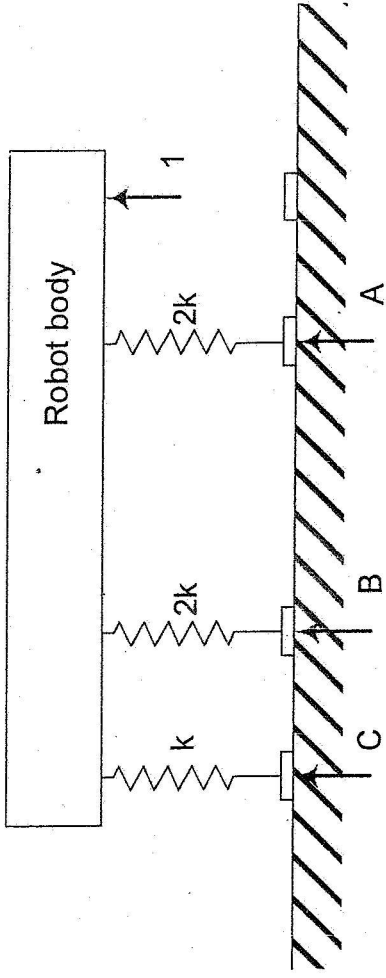
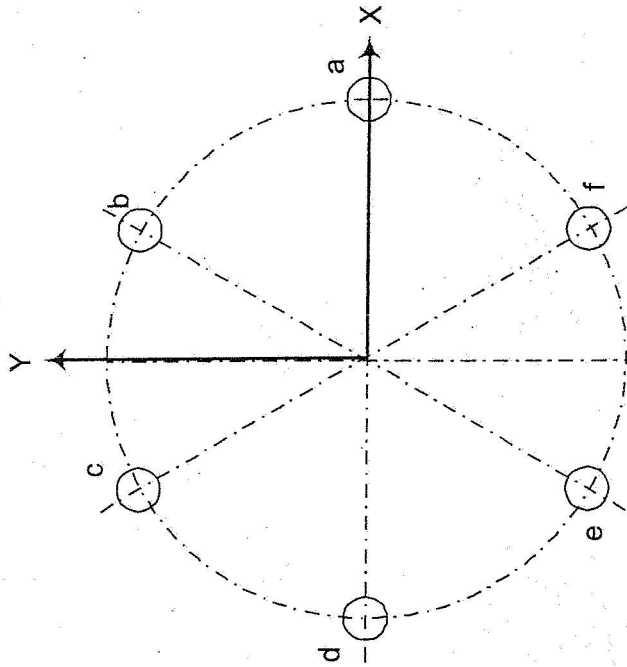

Simplified free body diagram

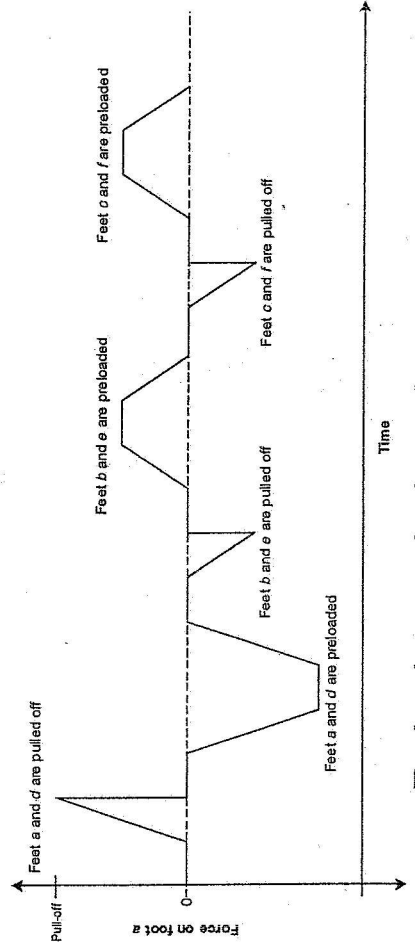
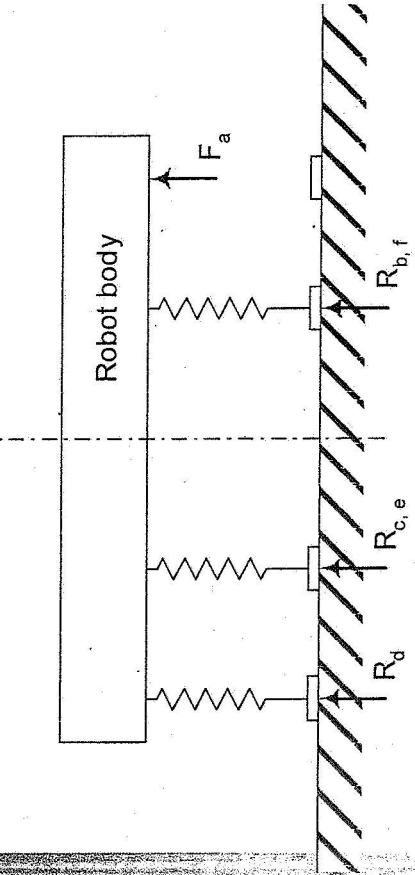

Pairwise gait time force profile

AWIMR mechanical configuration

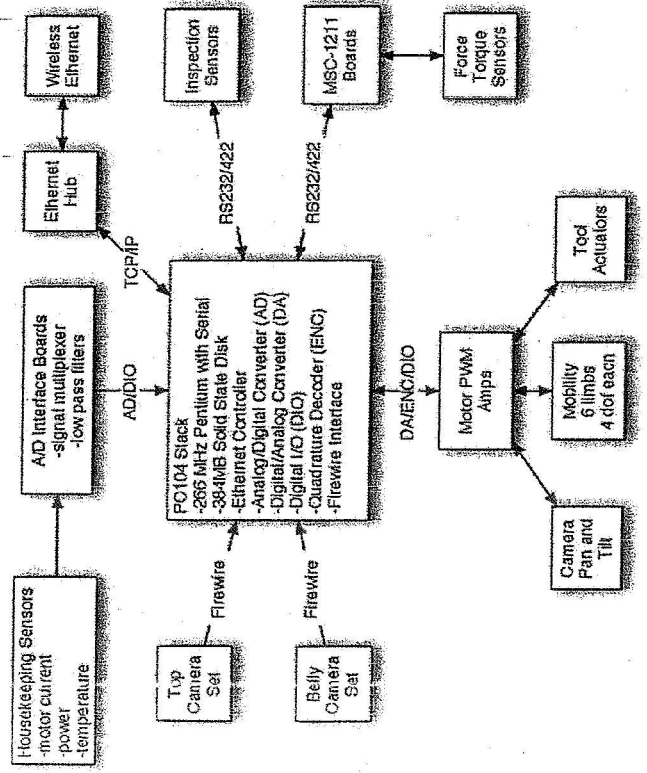
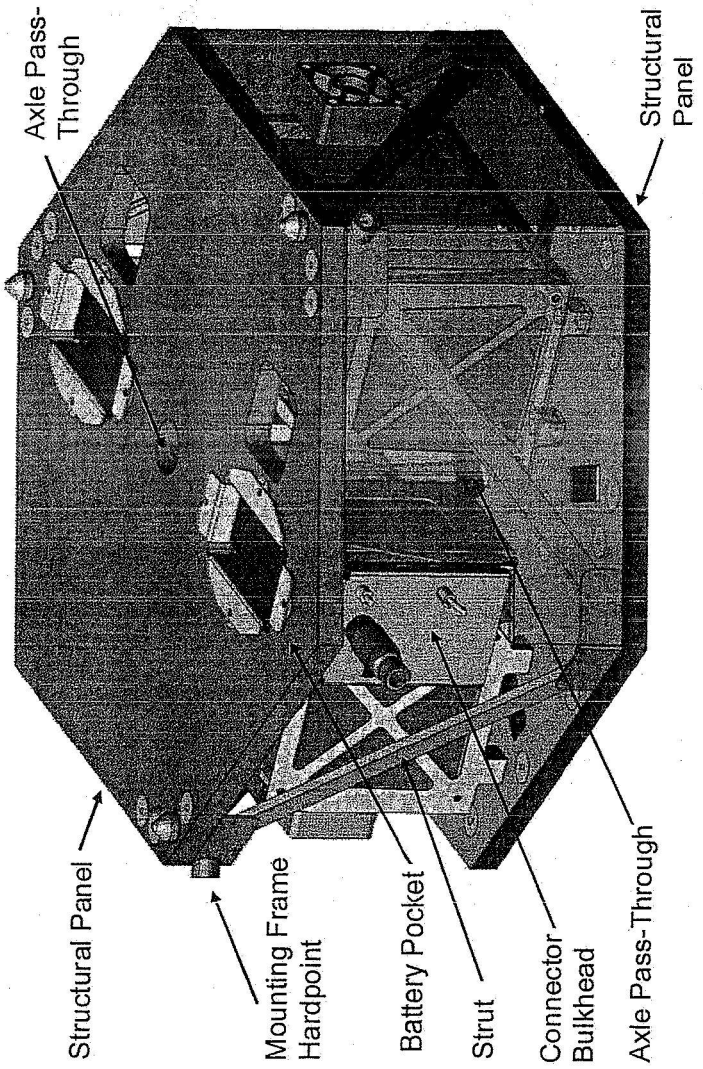
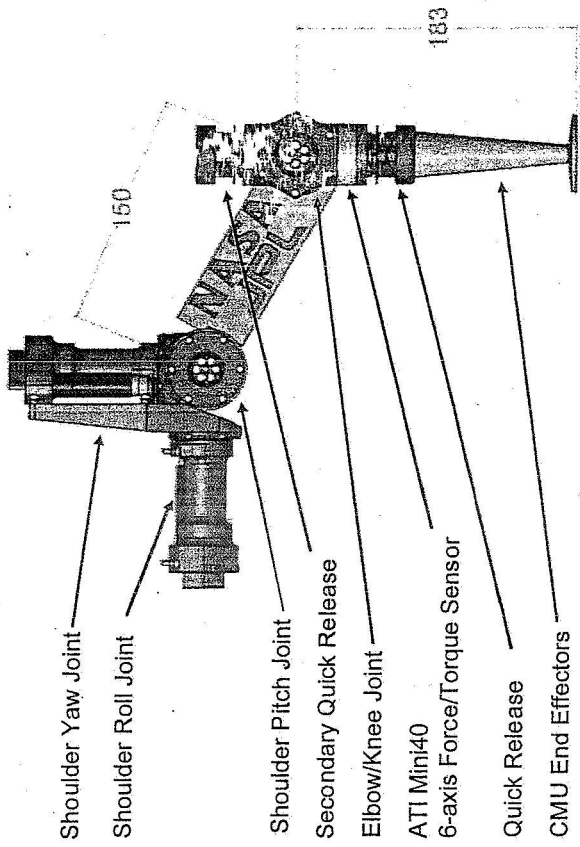
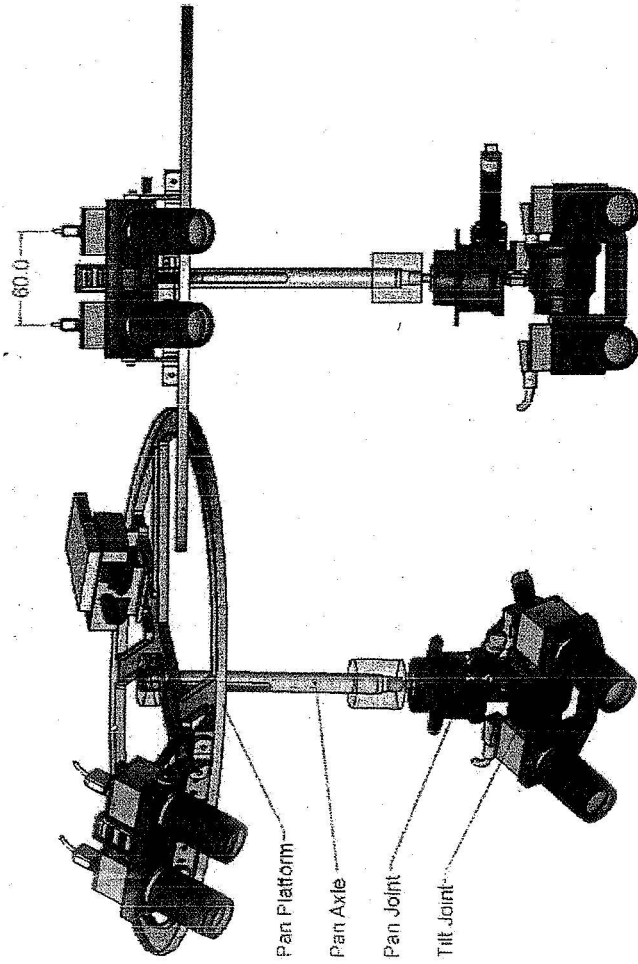

Software architecture

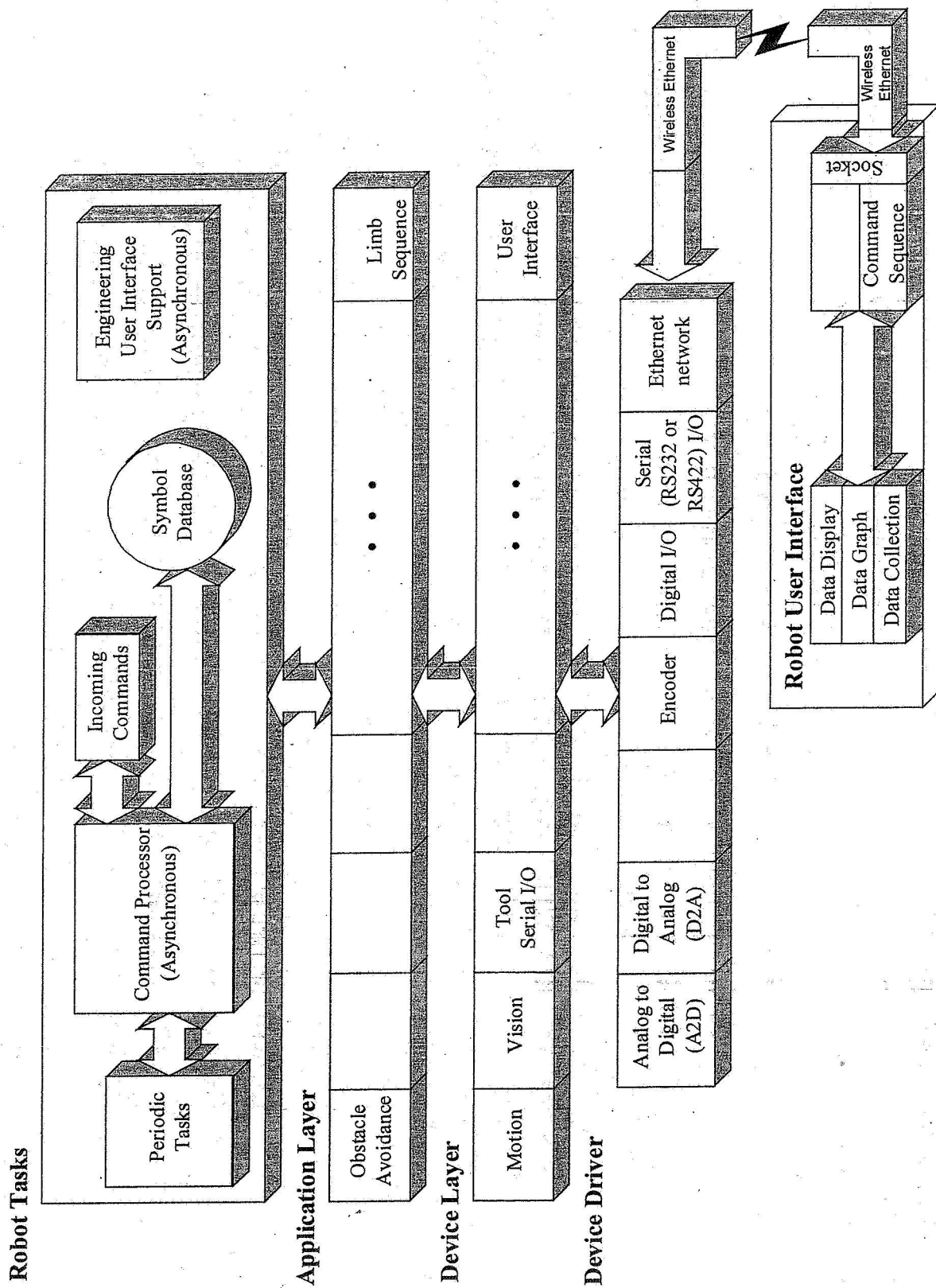

Looking ahead

- IEEE Robotics and Automation Society
 - New Technical Committee: Space Robotics
 - Focus on in-space robotics (not planetary)
 - The space environment (micro-gravity, radiation, contamination sensitivity, thermal extremes, etc.) poses unique challenges to robotics and robot algorithms. The space (non-planetary) robotics discipline will find increasing importance in coming years, particularly as the opportunities for human-robot and robot-robot cooperation arise in space exploration. Priority areas for this technical committee include:
 - Microgravity locomotion, including vehicle gripping techniques in microgravity. Space adapted grippers include sticky polymeric and electrostatic, as well as more conventional mechanical devices. Locomotion strategies also include leaping and free flying.
 - Command and control interfaces, including teleoperated modes.
 - Power sources and consumable recharging techniques.
 - Radiation hardening and effects on processing throughput.
 - Glare and glint effects on machine vision.
 - Thermal considerations in space robot design.

ICRA 2007

- **International Conference on Robotics and Automation (IEEE RAS)**
- **Roma, Italy, April 10-14, 2007**
- **Space Robotics Workshop (proposed) hosted by the IEEE RAS Space Robotics TC**
 - **A half-day workshop on in-space robotics**
 - **Complements a possible half day workshop on planetary robotics**
 - **Workshop call to be announced shortly**
 - **Draft workshop call at**
 - **<http://teamster.usc.edu/~fixture/Robotics/SpaceRoboticsTC/Workshop.html>**