

# **Development and Flight Testing of a Neural Network Based Flight Control System on the NF-15B Aircraft**

Craig R. Bomben, NASA Dryden FRC, Project Pilot (member)  
James W. Smolka, NASA Dryden FRC, Project Pilot (member)  
John T. Bosworth, NASA Dryden FRC, Project Chief Engineer  
Peggy S. Williams-Hayes, NASA Dryden FRC, Handling Qualities Engineer  
John J. Burken, NASA Dryden FRC, Flight Controls Engineer  
Richard R. Larson, NASA Dryden FRC, Systems Engineer  
Mark J. Buschbacher, NASA Dryden FRC, Flight Controls Engineer  
Heather A. Maliska, NASA Dryden FRC, Structural Loads Engineer

## **Introduction**

The Intelligent Flight Control System (IFCS) project at the NASA Dryden Flight Research Center, Edwards AFB, CA, has been investigating the use of neural network based adaptive control on a unique NF-15B test aircraft. The IFCS neural network is a software processor that stores measured aircraft response information to dynamically alter flight control gains. In 2006, the neural network was engaged and allowed to learn in real time to dynamically alter the aircraft handling qualities characteristics in the presence of actual aerodynamic failure conditions injected into the aircraft through the flight control system. The use of neural network and similar adaptive technologies in the design of highly fault and damage tolerant flight control systems shows promise in making future aircraft far more survivable than current technology allows. This paper will present the results of the IFCS flight test program conducted at the NASA Dryden Flight Research Center in 2006, with emphasis on challenges encountered and lessons learned.

## **Project Background**

NASA's IFCS program was conceived to develop and flight test control schemes that enhance control during a primary control surface failure. The Second Generation (Gen-2) IFCS flight test project goal is to demonstrate a neural flight control system that can provide adaptive control without the requirement for extensive gain scheduling or explicit aircraft parameter identification. The Gen-2 approach does not require

information on the nature or the extent of the failure or knowledge of the control surface positions in either nominal or off-nominal conditions.

### **Participating Organizations**

The participating organizations for the IFCS project are:

1. NASA Dryden Flight Research Center, Edwards AFB, CA, which was the responsible test organization.
2. NASA Ames Research Center, Mountain View, CA, which was the organization responsible for the neural network design methodology.
3. Institute for Scientific Research (ISR), Fairmont, WV, which was the organization responsible for the neural network implementation within the aircraft control laws.
4. Boeing Aerospace Company, St. Louis, MO, which was responsible for programming the aircraft flight control computers and conducting Hardware-in-the-Loop Simulation (HILS) ground testing.

### **Project Goals and Objectives**

The F-15 IFCS project goals were:

1. Demonstrate revolutionary control that efficiently optimizes aircraft performance in normal and failure conditions.
2. Advance neural network based flight control technology for new aerospace system designs.

The project was tasked with applying advanced adaptive control techniques to significantly improve the robustness of the system. In particular, the goal was to use neural network based adaptive systems. The demonstrated system needed to be able to adjust to unexpected vehicle dynamic characteristics during normal conditions and also adjust for vehicle failures.

There are some very striking examples of severely damaged vehicles that were safely landed. These cases have usually been the result of very skilled and very lucky pilots. Adaptive flight controls system technology has the potential to reduce the amount of skill and luck required and allow for safe recovery of a wider class of damaged vehicles.

The general project goals were broken down into the following three specific objectives for the adaptive system:

1. Reduce the initial transients due to the failure.
2. Reestablish controlled flight (model following performance).
3. Reduce cross-coupling effects.

The extent to which these specific objectives can be achieved depends on the severity of the failure and the existence of reserve control power. The project demonstration did not attempt to show the limits achievable by the F-15 IFCS vehicle. Instead the demonstration shows the ability of an adaptive system to adjust with no advanced knowledge of the failure to achieve the above stated three objectives.

### **Flight Test Approach**

The robustness capability of the neural adaptive flight control system was demonstrated in flight. Two types of failures were simulated:

1. A simulated change in aircraft stability was achieved by changing the gain on the angle of attack feedback to the symmetric canard. With fixed canards, the aircraft is both statically and dynamically unstable. Angle-of-attack feedback to the canards is required for longitudinal stability.
2. A change in control effectiveness was simulated by biasing and freezing one of the stabilator control surfaces.

The failed system was evaluated both with and without neural network adaptation. The evaluation was carried out using 1g formation flight and 3g air to air tracking tasks using standard Cooper-Harper rating techniques. A Congressional Milestone was created to “track completion of the flight demonstration of the second generation damage adaptive flight control system.” The project team was challenged to demonstrate that the adaptive system provides an improvement of one flying qualities level with a simulated failure.

### **Test Aircraft Description**

The aircraft used for this research project is a highly modified pre-production NF-15B airplane (USAF SN 71-0290), as depicted in Figure 1. The aircraft is configured with standard F-15 ailerons, stabilators, and rudders, but also has symmetrically and asymmetrically movable canards (F-18 horizontal tail surfaces) mounted on the engine inlets. The propulsion system consists of two Pratt & Whitney F100-PW-229 engines, each equipped with an axi-symmetric thrust vectoring pitch/yaw balance beam nozzle (not utilized for this test project) and electronic

throttles with no mechanical linkages to the engines. A unique asymmetric thrust departure prevention system was designed for this aircraft which functions similar to F-15E aircraft, but reverts the normally operating engine to non-afterburner PRI (primary) mode above 1.1 Mach. Additionally, the aircraft has a unique quad hydraulic system configuration, quad redundant digital flight control system (FCS) with no mechanical backup to the flight control surfaces. Each FCS channel has three processors, two for non-research specific functions, including the baseline flight control laws and redundancy management, and one dedicated for the research flight control laws. An Airborne Research Test System (ARTS-II) computer provided a single string path for the neural network computations to interface with the research flight control laws. The aircraft has an F-15E cockpit with pre-production F-15E display software and several unique displays. The aircraft is equipped with a metal radome with a test instrumentation pitot-static system and angle-of-attack and sideslip angle vanes, and is extensively instrumented for propulsion, flight control, handling qualities, and limited structural testing.

Pitch control is provided by symmetric movement of the stabilators. Symmetric canard motion is programmed as a function of angle-of-attack and does not provide any pitch control augmentation. During roll maneuvers, asymmetric stabilators and ailerons provide roll control with symmetric rudders and asymmetric canards providing roll coordination. During yaw maneuvers, symmetric rudders and asymmetric canards provide control, with the canards providing significantly enhanced directional stability vice production aircraft. During power approach, the ailerons droop similar to an F-18 for enhance slow speed operations. The aircraft is also equipped with conventional flaps and a preproduction speedbrake.

### **Pilot-Vehicle Interface Logic**

The pilot uses the existing Multi Purpose Display (MPD) panel to control research functions. The pilot-vehicle interface logic was developed jointly by a project pilot and a systems engineer. The interface logic possibilities were constrained by requirements to use existing avionics software interfaces to the non-research flight control computers and the availability of quad-redundant cockpit switches. There are three types of functions available, each having a baseline configuration when no option is selected (default) and 15 enumerated configuration options.

With this much flexibility, the number of test configurations is quite large (approximately 450 for this project), potentially requiring a large matrix of ground tests to confirm the operation of each specific set of selections.

For this test program, the tests were limited to a small subset of the possibilities, shown in the table below.

PAL	DAG	Flying Qualities	Failure	Excitation	Qbar Limit
1 or 8	20	Baseline	None	None	733 psf
	21	Baseline	4 deg Left Stabilator Lock	None	550 psf
	22	Baseline	2 deg Left Stabilator Lock	None	733 psf
	23	Baseline	0 deg Left Stabilator Lock	None	733 psf
	24	Baseline	-2 deg Left Stabilator Lock	None	733 psf
	25	Baseline	-4 deg Left Stabilator Lock	None	550 psf
	26	Baseline	-0.5 Canard Failure Multiplier	None	550 psf
	27	Baseline	-0.2 Canard Failure Multiplier	None	733 psf
	28	Baseline	0 Canard Failure Multiplier	None	733 psf
	29	Baseline	0.1 Canard Failure Multiplier	None	733 psf
	30	Baseline	0.2 Canard Failure Multiplier	None	733 psf
	31	Baseline	0.4 Canard Failure Multiplier	None	733 psf
	32	Baseline	0.6 Canard Failure Multiplier	None	733 psf
	33	Baseline	0.8 Canard Failure Multiplier	None	733 psf
	34	Baseline	None	None	733 psf
35	Baseline	None	None	733 psf	

Table 1. Failure Conditions Tested during IFCS

Only two neural network options were tested, one which allowed real-time gain adjustment by the neural networks (variable gain system), and one which disabled the real-time gain adjustments (fixed gain system).

The typical engagement switch sequence required as many as 14 switch and button actuations to fully engage the system with the neural network active and a failure condition selected. While this sequence of switch and button manipulations appears complex, sufficient simulation and training made it seem intuitive to the pilots. Additionally, a challenge and response procedure was utilized. Prior to any switch selection, the control room cleared the pilot or flight test engineer (FTE) to make the selection. The pilot or FTE would then verbally confirm the selection, and the control room verified the correct selection based on instrumentation. This challenge and response added the required level of safety to prevent inadvertent selection of the wrong IFCS options or modes. Three possible pilot disengagement methods were available.

# Research System Design

## Description of the Gen-2 Controller

The Gen-2 approach is based on the augmented model inversion architecture developed by Calise<sup>1</sup>, et al, and Rysdyk<sup>2</sup>, et al. The general control scheme consists of a dynamic inversion controller with explicit model following. An adaptive component is added to accommodate large errors that are outside the normal robustness range of the dynamic inversion controller. The main components of the Gen-2 controller are illustrated in Figure 2.

### Dynamic Inversion

The dynamic inversion portion of the flight control system provides a consistent controlled response for angular acceleration commands to the vehicle. A simplified aerodynamic model is incorporated into the control algorithm. For a given commanded acceleration, simplified equations of motion are used to calculate the required control surface commands. A proportional, integral, and derivative feedback compensator is wrapped around the dynamic inversion controller to make up for the simplifications used in the dynamic model and to reject disturbances.

### Explicit Model Following

An explicit model following scheme is used to achieve desired handling qualities. Reference models are defined with desired frequency and damping characteristics. The control system forces the response of the vehicle to match the reference model. The pitch axis desired reference model is a second order system:

$$\frac{q_{ref}}{\delta_{stk_{lon}}} = \frac{K_{lon}\omega_{sp}^2(s + L_{\alpha})}{s^2 + 2\zeta_{sp}\omega_{sp}s + \omega_{sp}^2}$$

The short period natural frequency ( $\omega_{sp}$ ), damping ( $\zeta_{sp}$ ), and apparent lift curve slope ( $L_{\alpha}$ ) are selected to achieve Level 1 flying qualities. The command gain ( $K_{lon}$ ) is chosen to provide an appropriate stick force per unit normal load factor (g).

The roll axis reference model is first order:

$$\frac{p_{ref}}{\delta_{stk_{lat}}} = \frac{K_{lat}}{\tau_r s + 1}$$

The command gain ( $K_{lat}$ ) is chosen to provide the appropriate amount of roll rate for the given flight conditions, and the roll mode time constant ( $\tau_r$ ) is selected to adjust how fast the roll rate is achieved. Values for these quantities were selected to achieve Level 1 flying qualities.

### **Simplified Directional Axis**

The initial research controller used dynamic inversion in all three control axes: roll, pitch and yaw. While testing the original dynamic inverse controller with an asymmetric failure, significant cross-axis coupling was noted. Even with the adaptive system engaged the coupling was not reduced. To achieve a pure roll response, a dynamic inversion controller anticipates how much to mix yaw with roll control. This feed-forward command mixing was contributing significantly to the undesirable coupling. Eventually a classical  $\beta$ -dot yaw axis control path was implemented. With the resulting hybrid system the adaptation was able to better control the asymmetric coupling. This modification was necessary to obtain Acceptable flying qualities in the presence of a simulated failure with the Gen-2 system. A future system that incorporates adaptation in the forward path mixer might not require modifying the full three axis dynamic inversion system.

### **Adaptive Neural Network**

The goal of the neural network system is to accommodate large errors that are not anticipated in the nominal control law design. A well designed flight control system is robust to a fairly large range of uncertainty or changes in vehicle behavior. As the changes become more extreme the performance degrades. An adaptive system has the ability to readjust the controller to re-achieve desired performance or regain robustness about the new point. In a failed flight condition (degraded aircraft dynamics) or configuration (reduced control surface effectiveness), larger than expected errors will develop. The adaptive neural networks operate in conjunction with the measured response error of the control system. Weights (gains) on the neural network parameters are dynamically adjusted until the error is reduced. The weights act as adjustments to the proportional, integral, and derivative feedback gains. Weights can also provide a control bias, a new feedback to the system,

or new cross-feed paths between the control axes. When optimal weights are achieved the feedback error is minimized and the system achieves better reference model following and presumably better handling qualities.

The F-15 IFCS implementation incorporated three neural networks that provided adjustment to the roll, pitch, and yaw forward path commands ( $U_{ad}$  in figure 2). Dead-zones were applied for the inputs to the neural network. These dead zones were used to keep the neural networks from constantly adapting to small errors. The sizes of the dead zones were determined by using the 6-degree-of-freedom software simulation. Limits were also placed on the weight magnitudes. These weight limits helped provide a limited authority system for initial test purposes.

### **Safety Monitors**

Limits on the neural network commands were required since the neural networks were implemented in the single-string ARTS-II computer and were considered experimental software. The limiters were required to allow relatively large commands for adaptation in the presence of large failures, but also were needed to provide protection from a high rate hard-over failure of the adaptation software or hardware. A special safety monitor called a floating limiter was designed for the IFCS program. The features of the floating limiter are shown in figure 3.

Figure 3 shows a maximum upper and lower boundary in red. When these boundaries are violated an immediate disengagement is initiated. Within the red boundaries is a green floating range. When the neural network commands are within the green window, full dynamic rate is allowed. The green window is allowed to float to center itself about the input signal. This aspect allows for a large slow bias change associated with re-trimming an asymmetric vehicle.

When the neural network command moves rapidly in one direction the signal will adjust to the moving window boundary. At that point the signal is rate limited and, if it persists on the boundary, will eventually cause a research system disengagement.

This relatively complicated nonlinear limiter was effective in providing unlimited small dynamic motion and large re-trimming authority while still protecting from unsafe neural network commands.



## **Software Simulation**

The software simulation was developed at the Integration and Test Facility (ITF) located at the NASA Dryden Flight Research Center. The IFCS F-15 simulation is a six-degree-of-freedom high-fidelity fixed-base simulation that has many components. The core components include the aerodynamics, mass properties, equations of motion, structural loads models, and a representative crew station. The simulation is used for software integration, hardware-in-the-loop integration, and flight test support. It is also used in analysis for hazard and risk reduction.

## **Hardware-in-the-Loop Simulation**

Hardware-in-the-loop simulation was conducted at Boeing in St. Louis, MO, for software qualification purposes. The hardware-in-the-loop simulation integrated a software aerodynamic model of the aircraft with actual flight control computers, engine IDEEC controllers, and aircraft avionics components and displays. An F-15E cockpit with a computer generated visual scene was used for piloted evaluations. A capability to inject flight control failure conditions into the flight control computers was used to test the functionality of the failure detection algorithms and to provide pilot training and familiarization with degraded aircraft handling qualities. Additionally, the pilot-vehicle interface (PVI) and engagement and disengagement transients were tested.

During the hardware-in-the-loop simulation, pilots noted several PVI discrepancies from the design specification. It was determined that the project could tolerate these discrepancies without expending limited resources to correct the software errors.

## **Structural Loads**

The flight envelope and maneuvering requirements for the IFCS program were well within the capabilities of the NF-15B vehicle. However, the simulated failures and recovery from them generated unconventional control surface combinations. These unconventional control surface combinations could result in high local structural loads. Some method was required to ensure that the vehicle structural loads were maintained within limits.

As shown in table 2, the aircraft with no stabilator failure has conventional control surface positions, with only minor differences between left and right surfaces due to normal trim requirements. With the -4 degree stabilator failure inserted on the left stabilator (shown by

the position change from +3.3 degrees to -0.7 degrees), however, the right stabilator carries the entire pitch trim requirement by deflecting an additional +3 degrees, and the roll trim requirement is picked up by the ailerons, as evidenced by a change of position of over 5.5 degrees by each aileron surface to counteract the roll produced by the asymmetric stabilator deflection. Notice that the canard and rudder surface positions are hardly affected.

<b>Surface position</b>	<b>No failure (deg)</b>	<b>-4 deg left stab failure (deg)</b>
Left Stabilator	3.3	-0.7 (failed)
Right Stabilator	3.4	6.4
Left Canard	-3.8	-3.9
Right Canard	-3.6	-3.8
Left Aileron	0.1	5.9
Right Aileron	0.5	-5.2
Left Rudder	0.6	0.4
Right Rudder	-1.0	-1.2

Table 2. Affect of -4 Degree from Trim Stabilator Failure on Aircraft Surface Positions

The NF-15B vehicle was instrumented for loads and a full loads calibration was performed in the Flight Loads Lab (FLL) at NASA Dryden Flight Research Center. Additionally, the program had an existing loads model that was developed by McDonnell Douglas for predicting aircraft structural loads based on measured loads from a previous NF-15B program. The loads model uses aircraft state and control input parameters along with the aircraft aerodynamics to predict a total of 45 aircraft component loads at 20 load stations. A set of flights were performed to check out the new loads instrumentation and to validate the loads model.

Initially an attempt was made to implement the loads model onboard the vehicle in the primary flight control processor as a safety monitor. It was found that the memory requirements for that loads model were beyond the capabilities of the flight control processor. Instead the flight test was limited to maneuvers and flight conditions where the worst case load was predicted to be within 70% of the design limit load. The loads model was used as a loads preflight prediction tool and a real time control room monitor for the IFCS Gen-2 flights. A build up flight test approach was used to verify the predicted loads and maneuvering dynamics.

In retrospect, the fidelity of the loads model and the inputs to that model would have precluded use as an onboard safety monitor. During

envelope clearance the model limits were adjusted based on post-flight data processing and comparison with the loads instrumentation. If the model were incorporated onboard these adjustments would have required flight control software changes along with all of the associated retesting.

## **Flight Testing**

### **Test Plan Overview**

The Gen-2 system was designed over a limited subsonic region. Originally, the design envelope included a supersonic regime, but design difficulties and limited resources caused the project to abandon the supersonic arena. The final flight envelope was 15,000 to 35,000 feet altitude and 275 KCAS (knots calibrated airspeed) to 0.95 Mach. The research controller was engaged and tested throughout this subsonic region. The clearance was achieved by maneuver build up using control raps to test for aero-servo-elastic stability, control doublets for basic rigid body controllability, control frequency sweeps to obtain closed-loop control system response characteristics, and wind-up-turns and loaded rolls to determine structural loads.

Two test points were chosen to demonstrate the ability to adapt to vehicle failures: flight condition 1 at 20,000 ft and Mach number of 0.75 (350 KCAS) and flight condition 2 at 25,000 ft and Mach number of 0.90 (385 KCAS). Neural network adaptation was not performed at flight condition 2 during this set of flight tests, but is planned for future testing. The maneuver build up was repeated with the simulated failures engaged.

Once the maneuvering flight envelope was cleared, the handling qualities of the vehicle were evaluated with no failure, with a simulated failure, and with a failure and adaptation. A 1g wings level formation flight task and a 3g air-to-air tracking task were performed for each simulated failure.

### **Flight Test Maneuvers**

Test points were cleared in a build-up fashion, so that the simulated aircraft failures began at the most benign failure magnitudes and increased in severity. For the initial flight tests, the research controller was cleared by flying around the envelope and performing pitch, roll, and yaw raps and doublets. After the controller was cleared, the neural networks were activated – first with no simulated aircraft failures, then

with the symmetric type of simulation failure (gain change on canard schedule), followed by the asymmetric simulated failure (a locked stabilator).

Flying qualities were evaluated by two pilots at the 20,000 feet, Mach 0.75 test point using the Cooper-Harper Rating (CHR) scale and a Pilot Induced Oscillation (PIO) rating scale (Fig. 4) during various simulated aircraft failures. The evaluations were conducted using the following sequence.

1. Baseline aircraft evaluation
2. Failure alone (no adaptation) on the research controller
3. Failure with NN adaptation on the research controller
4. Failure with NN adaptation on the research controller and NN training maneuvers

By flying the above sequence the pilots were able to define flying quality degradations caused by the inserted failures and subsequent changes caused by the neural network gain adjustments. Because the neural network required a finite amount of time to completely compute gain adjustments and because their level of output was dependent upon the aggressiveness of maneuvering, a training maneuver was added in an attempt to quickly optimize the neural network contributions. This training maneuver consisted of longitudinal doublets aimed to maximize the neural network output prior to conducting the evaluations.

During the evaluation two separate tasks were utilized while evaluating the flying qualities. Deviations were made from the desired positions and corrections were made back to the desired position using increasing aggressiveness. Using predetermined desired and adequate errors, handling qualities rating (HQR) scores were assessed for both gross acquisition and fine tracking tasks. Additionally, the pilot answered a series of questions designed to help engineers determine the exact cause of any deficiencies noted.

The first task was to fly a parade formation (two ship widths) position during straight and level flight. This wider-than-normal position was required to accommodate potential transients in the event of unexpected system disengagements. Deviations, both high and low, were made from the desired location and attempts to quickly reposition the aircraft were executed. The desired tracking criteria was defined as a ring that spanned from the forward F-18 canopy rail to the ejection seat head box and adequate criteria was defined as a ring that spans entire F-18 canopy and windshield. Desired performance was obtained if the pilot

could keep the wingtip missile launcher within the desired target for 75% of the time and adequate was defined as the ability to keep it within the adequate target 100% of the time. Refer to figure 5 for desired and adequate target definitions.

The second task was fixed gun sight tracking of a 3g F-18 target aircraft. The test aircraft was positioned 1,000-1,500 feet in trail while the test aircraft conducted a constant 3g level turn. The pilot attempted to position the gun sight piper on the target aircraft and hold it as close to the target as possible. Deviations aft, left, right and forward of the target where initiated and repositions where conducted with increasing aggressiveness. Desired and adequate performance was defined for both gross acquisition and fine tracking. For gross acquisition, piper errors of  $\pm 25$  mils with a maximum of 1 overshoot were required to meet desired criteria and  $\pm 50$  mils with a maximum of 2 overshoots for adequate criteria. For fine tracking, piper errors of  $\pm 5$  mils for 75% of the time were required to meet desired criteria and  $\pm 10$  mils for 100% of the time for adequate criteria. Refer to Figure 6 for a picture of the gun sight.

Two simulated failure types were utilized to degrade the flying qualities for the evaluations. The first type involved canard feedback errors that affected the basic aircraft dynamics by reducing aircraft longitudinal stability. The second type involved stabilator failures to alter aerodynamic control effectiveness, resulting in degraded pitch performance and creating cross coupling errors.

Canard multiplier failures of 0.8, 0.6, 0.4, 0.2, 0.1, 0, -0.2 and -0.5 canard were flown. The 1.0 canard multiplier was the baseline value and decreasing values resulted in decreased longitudinal stability.

Although the flight control system provided the flexibility to fail either stabilator in any position, only the left stabilator was failed at 3 predefined positions. The left stabilator was failed (frozen) at the trim position,  $-2^\circ$  from trim, and  $-4^\circ$  from the trim position. The trim position failure was predicted to be the most benign failure with increasing failure severity to the worst case failure of  $-4^\circ$  from trim. Larger failures were precluded due to excessive transients in the event of a transition to the baseline aircraft due to a detected fault, wake turbulence encounter, or for some other unanticipated reason.

Prior to conducting the flying qualities evaluations each test point was cleared by evaluating the transients associated with failure engagements (conducted at 1g) and disengagements (at 1g and during dynamic

maneuvers). Additionally aircraft loads were monitored to ensure the non-standard control surface deflections and neural network outputs did not result in any unanticipated aircraft loads. The following clearance flight maneuvers were used:

1. Three axis raps and doublets
2. Three axis frequency sweeps
3. 3g and 4g wind-up turns (WUT)
4. Half stick rolls in both directions
5. 3g rolling reversals
6. Pilot initiated disengagements during 3g WUTs, half stick rolls, and 3g rolling reversals (to evaluate disengagement transients)

All engagement and disengagement transients were benign and aircraft loads were predominately below the 70% aircraft design load limit (DLL) with a few excursions up to 84% on the ailerons.

## Flight Test Results

### Formation Flight with Canard Multiplier Failure

All of the handling qualities data was collected at 20,000 feet and Mach 0.75. Handling qualities tasks (including formation flight and 3g tracking) were flown for the canard multipliers of 0.2 and -0.5. The pilot ratings for the largest canard multiplier (-0.5) are presented in the tables 3 and 4.

Canard Multiplier	Gross Acq	Fine Tracking	PIO scale rating
Baseline; formation flight	2	2	1
-0.5 CM; NN off; formation flight	2.5	3	4
-0.5 CM; NN on; formation flight	2	2	1
Baseline; 3g tracking	2	2	1
-0.5 CM; NN off; 3g tracking	4	3	2
-0.5 CM; NN on; 3g tracking	3	2	1

Table 3. Pilot A HQRs, Formation Flight & 3g Tracking Tasks, Flight 187

Canard Multiplier	Gross Acq (GA)*	Fine Tracking (FT)*	PIO scale rating*
Baseline, formation flight	2.5	1.5	1
-0.5 CM NN off, formation flight	3	4	3
-0.5 CM NN on, formation flight	4	2	GA 3
			FT 1
Baseline, 3g tracking	2/4.5	1/3	1/2
-0.5 CM, NN off, 3g tracking	3/5	2/3	2/3
			GA 1
			FT 2
-0.5 CM, NN on, 3g tracking	2.5/6	1.5/4	1/3
			GA 1
			FT 3

\*The first rating is longitudinal, the second rating is lateral

Table 4. Pilot B HQRs, Formation Flight & 3g Tracking Tasks, Flight 186

### Pilot A

The canard multiplier (CM) failure resulted in a very slight degradation in both gross acquisition and fine tracking flying qualities and a significant degradation in PIO from the baseline control laws with the neural network adaptation off.

The NN resulted in a slight improvement for both the flying qualities and PIO while the flying qualities and PIO ratings returned to the same ratings as the baseline aircraft. Pilot A commented during the evaluation of the canard multiplier with neural network adaptation that the "...initial response was very predictable. [It was] much like the baseline [airplane] without the failure. [There were] no real undesirable motions, [and it was] very predictable. [As far as] aggressiveness affects – [more aggressive] had little effect. [As far as] compensation – normal compensation techniques where we're having to stop the motion prior to being in position. No coupling of axes and reasonable sensitivity, all the feel systems were good."

### Pilot B

The CM failure resulted in a very slight degradation in gross acquisition and a significant degradation in fine tracking and PIO. Pilot B

commented that although he was still getting the desired performance out of the aircraft, it was still possible to excite a mild PIO. He remarked that he felt as though the entire airplane was rotating about the pilot and that he could see the canards moving in his peripheral vision. Because of these two factors, his ratings were slightly degraded from the baseline aircraft for gross acquisition (CHR 2.5 to CHR 3) and more noticeably degraded in fine tracking (CHR 1.5 to CHR 4).

The NN resulted in a slight degradation in gross acquisition, an improvement in fine tracking and no change in the PIO rating.

### **3g Tracking Task with Canard Multiplier Failure**

#### **Pilot A**

The CM failure resulted in degradation to Level 2 flying qualities for gross acquisition, a slight degradation in fine tracking and a slight increase in the PIO tendency from the baseline control laws with the NN off. The aircraft had a tendency to “dig in” during pitch maneuvers with the failure. Additionally there was some undesired motion and left and right yaw associated with large longitudinal inputs. This resulted in later pipper placement errors while conducting gross acquisition tasks.

The NN resulted in a slight improvement in all tasks with the fine tracking and PIO rating returning to that of the baseline aircraft. Pipper placement improved slightly with the NN but gross acquisition tasks still resulted in some lateral errors. Even though the error magnitudes were reduced the pilot still had trouble predicting the lateral motion while conducting longitudinal inputs.

#### **Pilot B**

For the baseline configuration (no failure, no adaptation) for 3g tracking, pilot B noticed a slight degradation in the lateral axis while flying the task. Because of this, he separated his ratings into two separate ratings, separately rating the longitudinal and lateral axes. Pilot B gave a CHR 2 for gross acquisition, CHR 2 for fine tracking, and a PIO rating of 1 for the pitch axis; while giving a CHR 4.5 for gross acquisition, a CHR of 3 for fine tracking, and a PIO rating of 2 for the lateral axis.

For the -0.5 canard multiplier, pilot B noticed a slight degradation in both axes when the failure was introduced without the neural network adaptation.



For the -0.5 canard multiplier with neural network adaptation, pilot B's ratings indicated that he felt that the adaptation created a slight improvement in the longitudinal axis, but that there was a further degradation in the lateral axis. He also noted that there was no PIO tendency in the pitch axis (PIO 1), but that there was some PIO tendency present for the lateral axis (PIO 3).

### **Summary of Canard Multiplier Failure Tests**

Pilot B felt that during the formation flight task, the neural network adaptation improved the handling qualities in the fine tracking task, but slightly degraded the handling qualities in the gross acquisition task. Pilot B commented that during the failure with adaptation present, the airplane did not behave as precisely as it did in the baseline configuration (no failure, no adaptation). For the 3g tracking task, while the neural network adaptation did not improve the aircraft behavior in the lateral axis, pilot B noted that there was a slight improvement in the longitudinal axis with adaptation, and that there were no PIO tendencies in the longitudinal axis.

Comparing the ratings given by both pilots, Pilot A felt as though the neural network adaptation improved the handling qualities of the aircraft in both formation flight & 3g tracking. Pilot B's ratings indicate that he also saw an improvement in the longitudinal axis during 3g tracking with adaptation present. Pilot B felt that the adaptation degraded the lateral axis, and also indicated that there were some undesirable motions present in the lateral axis while evaluating the PIO tendencies, while Pilot A stated that he felt that the neural network adaptation corrected the PIO tendencies present in the failure case with no adaptation.

### **Formation Flight with Stabilator Failures**

Tables 5 and 6 are compilations of the pilot assessment of the stabilator failures during the formation flight task.

#### **Pilot A**

Pilot A rated the baseline handling qualities task for formation flight at CHR 2 for both gross acquisition and fine tracking, and a PIO rating of 1. His comments from flight 188 were that the "...initial response was good, it was predictable, no undesirable motions. More aggressiveness didn't cause any degradation in flying qualities. Good performance. No coupling of axes, good sensitivity, good feel system."

Stabilator Failure Magnitude	Gross Acquisition CHR	Fine Tracking CHR	PIO rating
Baseline (flight 188)	2	2	1
Trim; NN off	6	5	4
Baseline (flight 189)	2	2	1
Trim; NN off	3	3	3
Trim; NN on	3	3	4 to 3
-2 deg from trim; NN off	2	3	2
-2 deg from trim; NN on	2	2	1
-4 deg from trim; NN off	3	3	2
-4 deg from trim; NN on	3	3	2

Table 5. Pilot A HQRs, Stabilator Failure in 1g Formation Flight

Stabilator Failure Magnitude	Gross Acquisition CHR	Fine Tracking CHR*	PIO rating*
Baseline (flight 190)	3	2	2
Trim; NN off	4	4	4
Trim; NN on	4	4/7	2/4
-2 deg from trim; NN off	4	3	2
-2 deg from trim; NN on	3	4/7	2/5
-4 deg from trim; NN off	4	3	2
-4 deg from trim; NN on	4	4/4	2/2

\*The first rating is longitudinal, the second rating is lateral

Table 6. Pilot B HQRs, Stabilator Failures in 1g Formation Flight

During one of the two trim failure test points, Pilot A assessed the failure to have the worst flying qualities with a degradation to Level 2. Because of an in-flight control channel failure, the mission was terminated early and the failure was not evaluated with the neural network on.

The second time the trim failure test condition was flown, the pilot assessed the flying qualities as Level 1, but there was still an increase in PIO tendencies. The NN showed a marked improvement on the first test point, from Level 2 to Level 1 flying qualities, and no change from the second one. The NN did not improve the PIO tendencies during the trim failure. The trim failure with NN on resulted in a slight degradation from

the baseline aircraft and showed a slight overall increase in PIO tendencies.

For the trim stabilator failure, initially the PIO rating was worse with adaptation on, but then improved. Pilot A did notice some change in PIO tendencies during formation flight. He observed that the flying qualities improved significantly after the first 30 seconds of formation flight as a result of neural network adaptation. The pilot's observations in flight are confirmed by looking at the values of the neural network weights as a function of time (fig.7). The weights significantly changed after 30 seconds of maneuvering. The NN weight change was able to bring the PIO rating back to the same rating obtained with no neural network present. For the -4 stabilator failure, Pilot A noticed no difference in PIO tendencies with or without the NN adaptation. For the -2 deg from trim stabilator failure, the PIO rating from Pilot A went from a 2 to 1 (improving slightly).

### **Pilot B**

Pilot B experienced degraded handling qualities in the lateral axis while evaluating the primarily pitch axis dominated wing formation task. Because of this, the above table includes CHRs for both the longitudinal and lateral axis.

Pilot B rated the baseline handling qualities card for formation flight as a CHR 3 for gross acquisition, CHR 2 for fine tracking, with a PIO rating of 2. Pilot B commented during flight that the "...initial response was good and abrupt. We did get one or two overshoots on the first one, [which is] a little bit of a predictability issue. As I did the maneuver a couple of times, [it] got more predictable, so I probably got used to the response. The airplane has got good handling qualities despite fairly aggressive flying. We got desired performance the entire time, no coupling of axes, no feel system issues."

For the trim stabilator failure with no neural network adaptation, Pilot B's gross acquisition and fine tracking task CHR degraded slightly to a 4 and the PIO rating was increased to 4. The pilot stated that there was an underlying heaving motion associated with the failure. Figure 8 illustrates the pilot stick motions as a result of the cross coupling to achieve very precise pitch tracking without any apparent lateral motion during the formation task.

Pilot B indicated that for the trim stabilator failure, the pitch PIO tendency improved with the NN adaptation on and that the longitudinal task

remained the same for both gross acquisition and fine tracking however the lateral task degraded to Level 3 flying qualities for fine tracking with the neural network on due to a cross coupling effect that resulted in a lateral PIO with very aggressive longitudinal tracking.

### 3g Tracking with Stabilator Failures

Tables 7 and 8 show the pilot ratings for the 3g air-to-air tracking task for the trim stabilator failure.

Stabilator Failure Magnitude	Gross Acquisition CHR	Fine Tracking CHR	PIO rating
Baseline (flight 191)	2	2	1
Trim; NN off	5	4	2
Trim; NN on	3	4	3
Baseline (flight 193)	2	2	1
-4 deg from trim; NN off	5	4	4
-4 deg from trim; NN on	4	5	4
-4 deg from trim; NN on with training	3	3	4

Table 7. Pilot A HQRs, Stabilator Failures in 3g Tracking Task

Stabilator Failure Magnitude	Gross Acquisition CHR*	Fine Tracking CHR*	PIO rating*
Baseline (flight 192)	1/2	1/1	1
Trim; NN off	4/6	4/5	2/2
Trim; NN on	3/6	4-3-5/4.5	5/1
-2 deg from trim; NN off	2/5	2.5/3	2/2
-2 deg from trim; NN on	5/6	6/6	4/2

\*The first rating is longitudinal, the second rating is lateral

Table 8. Pilot B HQRs, Stabilator Failures in 3g Tracking Task

#### Pilot A

For the 3g tracking task, pilot A's ratings indicate that the neural network improved the gross acquisition for all of the stabilator failures. Each rating improved by one or more CHR points – CHR 5 to CHR 3 for the trim stabilator failure, CHR 4 to CHR 3 for the -2 deg from trim stabilator failure, and CHR 5 to CHR 4 for the -4 deg from trim stabilator failure. Training the neural network prior to flying the tracking task did not help in

the gross acquisition for the -2 deg from trim stabilator failure (CHR 3 to CHR 5), but did help for the -4 deg from trim stabilator failure (CHR 4 to CHR 3).

After flying the trim stabilator failure with the neural network adaptation on, pilot A commented that he felt as though cross-coupling was reduced, but that he was seeing PIO tendencies that he had not seen with the neural network adaptation off.

### **Pilot B**

Pilot B rated the baseline handling qualities card for 3g tracking as a CHR 1 for gross acquisition and fine tracking in the pitch axis, a CHR 2 for gross acquisition in the lateral axis, and as a CHR 1 for fine tracking in the lateral axis. Pilot B indicated that there was no PIO tendency, and gave it a PIO rating of 1.

Pilot B only rated the trim and -2 deg from trim stabilator failures for the 3g tracking task. For the trim stabilator failure, pilot B noted a slight improvement in the pitch axis (CHR 4 to CHR 3) for gross acquisition, but no change in the lateral axis with the neural networks on. For fine tracking, the task with neural networks on seemed to be essentially the same as the trim stabilator failure with no adaptation present. The pilot commented in flight that this was hard to evaluate, and indicated that his rating was changing throughout the task. This impression may have been the result of neural network learning during the task. The pitch PIO tendency increased with the neural network on (PIO 2 to PIO 5), but the lateral PIO tendency decreased slightly with the neural network on (PIO 2 to PIO 1). For the -2 deg from trim stabilator failure, pilot B's rating with the neural networks on were degraded for both the gross acquisition and fine tracking tasks in both the pitch and lateral axis. PIO tendencies in the pitch axis increased with the neural network on, while lateral PIO tendencies remained the same with adaptation.

When pilot B flew the trim stabilator failure with no neural network adaptation, he noted the cross axis coupling present (especially in the lateral axis), but did not note any significant PIO tendency. During the 3g tracking task for the trim stabilator failure with no neural network adaptation pilot B commented that "...when I put the initial piper on the target without doing any acquisition tasks, we were just kind of wandering around, it was pretty hard to keep on target, [it tended to] wander off to either side and in pitch fore and aft. So the error was much larger and I would say it was marginal in pitch in terms of meeting desired criteria."

“Predictability was poor in terms of being able to keep it precisely on a point where you wanted it to. Aggressive affects? – I think the more aggressive I got, the worse the errors got, so it requires you to back off of your gain. Adequacy of performance was just barely – I'd say it was marginal between desired and adequate. During the lateral axis, [I] definitely [got] a lot of coupling and pitch going on...during the lateral gross acquisition task. In the pitch gross acquisition task, I tried to put a pure input in and I ended up off on his right wing tip. So there's definitely coupling, it's more bothersome in the lateral directional axis than it is in the pitch axis.”

When the neural network adaptation was present for the trim stabilator failure, pilot B compared the 3g tracking task to the trim stabilator failure without adaptation commenting that the “...initial response on this – the airplane was quite bobbly in pitch and laterally when I first started tracking. That seemed to settle down a little bit with some time. However, when I got into the gross acquisition task, the pitch axis seemed to be a little bit better than the previous one, until I started doing the lateral acquisition tasks. And one thing under lateral acquisition, every time I moved the stick – the piper would move up to the upper part of the 3-9 line and then as I got closer to [the] target, it would move below the 3-9 line. It was almost like a half figure-eight trying to get it back on the target. And the first time I did that [there] was a large overshoot, [but when I] started to compensate for it, the overshoot seemed to go down a little bit. But I did get into a PIO on that last one after the gross acquisition. So there is definitely a coupling of axis that's going on and it's most notable when you do the lateral task. A little bit in the pitch task, [it] does have a tendency to pull the piper off to the right side of the target.”

Pilot B also commented during his ratings that with lower (pilot) gains, he did not feel that the PIO tendency was present.

### **Summary of Stabilator Failure Tests**

For formation flight, pilot A observed that the PIO tendency was worse for the trim stabilator failure with neural network adaptation on (compared to the -2 deg from trim stabilator failure). Pilot B's opinion was the opposite, observing that the PIO tendency was worse with the neural network adaptation on for the -2 degree from trim case, but improved for the trim stabilator failure case. Pilot A's comments indicated that he felt that the neural network adaptation was able to diminish the cross-coupling for the stabilator failures, while pilot B indicated that the cross coupling “was worse and far more noticeable

than it was without the neural nets” for the trim stabilator failure. Both pilots agreed that for the -4 degree from trim stabilator failure that there was no difference in PIO tendency with or without neural network adaptation.

For the 3g tracking task, pilot A noted an improvement for the gross acquisition task when neural network adaptation was present for all of the stab failures flown. For the trim stab failure, pilot B also felt that gross acquisition task was slightly better in the pitch axis with neural network adaptation, but noted some degradation in the pitch axis for the gross acquisition task for the -2 stab failure with adaptation present. Pilot A indicated that the neural network adaptation was able to diminish the cross axis coupling present during the task, but felt that the PIO tendency was increased with adaptation. Pilot B ratings also indicate that the PIO tendency in the pitch axis was increased for both failures he evaluated in flight where neural network adaptation was present.

## **Frequency Response Analysis of Canard Multiplier Effect**

To achieve a change in vehicle dynamic characteristics, a change in the angle of attack feedback to the canard was made. This change in feedback gain acts to destabilize the vehicle. Figure 9 shows the closed loop frequency response of pitch rate due to longitudinal stick. The model following control laws attempt to match the frequency response depicted by the black dashed line. The grey shaded region surrounding the black dashed line represents the region of maximum unnoticeable added dynamics. When the frequency response lies within the grey shaded region, the response of the vehicle is indistinguishable from the response of the model to be followed (the black dashed line).

With a canard multiplier of -0.5 and no neural networks the frequency response of the vehicle falls outside the grey shaded region. The blue line shows the predicted effect of the -0.5 canard multiplier. The green line shows the flight measured response with no neural networks. Comparing the green and blue lines shows that the effect of the canard multiplier was less severe than predicted by the simulation.

The red line shows that with the neural networks on, the system was better able to achieve the model following goal. However, because the effect of the failure was less than predicted the benefits of the neural network were not as pronounced as desired. A future software load will provide the ability to put in larger canard multipliers.

## Handling Qualities Predictions Compared To Flight Data

Both pilots performed pitch and roll frequency sweeps in the piloted simulation. Pilot A performed pitch and roll frequency sweeps in flight for all three stabilator failures with no adaptation. Automated frequency sweeps were also run in the batch simulation for comparison purposes to flight data. All sweeps were analyzed using the lower-order equivalent systems (LOES) method. For the pitch axis, a second order transfer function was used to determine short period frequency and damping. For the roll axis, a first order transfer function was used to determine the roll mode time constant. The research controller was designed to meet Level 1 handling qualities for the no failure case.

Several handling quality metrics - control anticipation parameter (CAP), Smith-Geddes, average Cooper-Harper (ACH) rating, and the Neal-Smith method were used to predict the type of handling qualities that would be experienced with a simulated surface failure. Table 9 shows the LOES analysis of the frequency data from flight and from the non-linear simulation, along with these various handling qualities prediction methods for comparison purposes for the trim stabilator failure.

<b>Stabilator Failure</b>	<b>Flight 194</b>	<b>Pilot A</b>	<b>Pilot B</b>	<b>Automated</b>
<b>HQ metrics</b>		<b>sim</b>	<b>sim</b>	<b>sim</b>
$\omega_{sp}$	2.11	1.96	2.12	1.96
$\zeta_{sp}$	0.43	0.50	0.52	0.72
$\tau_r$	0.26	0.25	0.24	0.27
<b>CAP Level</b>	2	3	2/3	3/2
<b>Neal-Smith Level</b>	-	3	2	-
<b>Smith-Geddes Level,</b>	3	3	2/3	3
<b>PIO predicted?</b>	yes	yes	yes	yes
<b>ACH</b>	8.4	7.7	6.5	7.4
<b>Coherence (&gt;)</b>	0.60	0.85	0.94	0.98

Table 9. Frequency Sweep Analysis Parameters with Predicted Handling Qualities for Trim Stabilator Failure



## **Simulation to Flight Data Comparison of HQ Parameters**

For the trim stabilator failure, short period frequency values obtained from flight and simulation data (using LOES) compared well. The short period mode appears to be less damped in flight compared to the simulation data obtained from both pilots. Roll mode time constant values are consistent between flight and simulation data.

The CAP level predicted from the frequency sweep obtained in flight was Level 2. This is reflected in Pilot A's ratings during the 3g tracking task, as well as in Pilot B's ratings for both the formation flight and 3g tracking tasks for the trim stabilator failure. Pilot A initially gave Level 2 ratings for the trim stabilator failure during formation flight, but when he rated the same failure again in a later flight, his ratings were all Level 1. The CAP value from pilot B's frequency sweep in simulation was on the Level 2 and Level 3 border. Pilot B did have a fine tracking CHR that was Level 3 for the lateral axis (CHR 7). All of the CHRs from pilot B were Level 2, which correspond to the prediction given by the CAP.

The Neal-Smith plot generated from data obtained from Pilot A in the piloted simulation is in an area of the graph that indicates, "sluggish response; strong PIO tendencies, have to overdrive it". Pilot A's comments in flight 191 directly correspond to this. In the 3g tracking task for the trim stabilator failure with no neural network adaptation, Pilot A commented, "very sluggish response out of the airplane, big overshoot there, probably above 50 mils". Pilot A gave PIO rating of 3 in formation flight, and a PIO rating of 2 in the 3g tracking task, indicating that he did not see a strong PIO tendency for the trim stabilator failure in flight 189. The PIO 4 rating given by Pilot A in flight 188 indicates there was a PIO tendency present, but that it was not divergent.

The Smith-Geddes criteria predicts that a PIO tendency is present for the trim stabilator failure with no neural network adaptation. The comments and PIO ratings from both pilots confirm this. A plot of pitch stick input and pitch attitude for Pilot A during flight 188 shows the classic behavior of a PIO – pilot input is directly out of phase with the aircraft response (figure 10).

## **Conclusions**

A very valuable set of data was collected for a direct adaptive neural network based flight control system. This data will be invaluable in learning how these kinds of systems behave in a real-world environment

and allow further refinement of design tools and methodologies for future systems.

The research flight control system provided good flying qualities as a baseline system. The integrators in all three axes provided reasonably good robustness to the aircraft in the presence of simulated failures. Because of this, the full contributions of the neural network compensation were difficult to determine.

When the adaptive system was not required (no simulated failures present), the handling qualities of the vehicle were not adversely affected.

The migration of the neural network gain weighting was generally as predicted. Real-world sensor noise and disturbances did not adversely affect the learning behavior of the neural network adaptive system.

The complex floating limiter safety monitor worked well and did not cause nuisance trips with normal piloting technique. With aggressive flying, there were a few instances where the floating limiter disengaged the system.

The canard multiplier failures were less severe than predicted by the non-linear simulation. The adaptive system seemed to provide improvement with these failures however the change was less dramatic than was predicted.

The stabilator failures provided a good example of an asymmetric vehicle. The neural networks provided some relief from the coupled behavior. However, with the neural networks engaged, the system tended to be much more PIO prone in the pitch axis. Pilot control stick motions revealed that pilot compensation was adequate to deal with most of the cross coupling when accomplishing a pitch task. However, for task accomplishment requiring motions in the lateral axis, pilot compensation was less successful.

## **Lessons Learned**

Current aerospace standards for developing aircraft analytical and simulation models do not address cross coupling control surface effects between the longitudinal and the lateral-directional axes. For robust damage tolerant systems that use unconventional control surface

deflection combinations for control, this cross coupling modeling is required in order to properly allocate all available control power.

The ability of the pilot to adapt to the coupled behavior of a simulated stabilator failure was greater than expected. This might mean that eliminating cross coupling is less important than eliminating the PIO tendency for safe recovery of the aircraft. However, cross coupling is difficult for pilot compensation if the aircraft is in a phase of flight where the mission can not be terminated gracefully, such as if the aircraft suffers damage in the middle of an air-to-air combat situation. Mission continuation may be required for survival.

The ability of the pilot to adapt to the simulated failures became a significant player in the handling qualities evaluations. As the pilot flew the various sizes of failures to buildup to the larger simulated failures, it was possible for him to become accustomed to the effects induced by the simulated failures. The use of guest pilots could solve this problem, where the guest pilot only evaluates the larger simulated failures without first becoming accustomed to the smaller failures. This would enable the pilot to give a true first impression of the system.

Initial simulation models had a very high-gain, high-bandwidth flight control system. This system was very robust to simulated failures. However the dynamic inversion controller provided most of the compensation with the neural network playing a minor role. This initial controller did not have adequate structural mode attenuation to avoid adverse aeroservoelastic (ASE) interactions. When the controller gain was reduced to achieve ASE margins it was much harder to achieve robustness to failures. Also the neural network contribution required was significantly increased.

Initially the performance objectives emphasized transient reduction and achieving model following after the failure. Piloted simulation results showed that reducing cross coupling was a more important objective.

Explicit cross axis feed-forward and feedback paths (for example, pitch to roll and vice versa) were required in the neural network to reduce the coupling. Relying on feedback disturbance rejection alone was not sufficient.

It was found that the baseline dynamic inversion controller contributed significantly to the undesired cross coupled response in the presence of a surface failure. This was due to the feed-forward paths and assumptions made in the onboard aerodynamic model. A simpler

conventional controller would not have these added forward path contributions for an aircraft with an asymmetric failure.

Selecting the inputs to the neural networks is very important to the system design. Transient errors that are normal for abrupt command inputs (i.e. during a full stick roll) tend to drive the neural network weights to a high-gain system. The high gain system can result in limit cycle oscillations.

A significant amount of design tuning was required to achieve robust full envelope performance for the F-15 system. This contradicts the promise of robustness for the unforeseen failure. In many cases the design had to be fine-tuned in the piloted simulation as opposed to using more conventional linear models.

For a truly robust adaptive system, an onboard loads model to provide structural load limit information would be ideal. However the currently available models are too complex and not reliable enough for an onboard redundant system.

Some flight loads are self limiting. It was found that the aileron structure was stronger than the hinge moment capability of the actuator. When this actuator is pushed to the limit the result is that the control surface deflection is reduced and no structural damage occurs. Conversely, when the stabilators are pushed to their limit structural damage can potentially occur.

## **References**

1. Calise, A.J., S. Lee, and M. Sharma, "Direct Adaptive Reconfigurable Control of a Tailless Fighter Aircraft," AIAA-98-4108, Aug. 1988.
2. Rysdyk, Rolf T. and Anthony J. Calise, "Fault Tolerant Flight Control Via Adaptive Neural Network Augmentation," AIAA-98-4483, Aug. 1988.

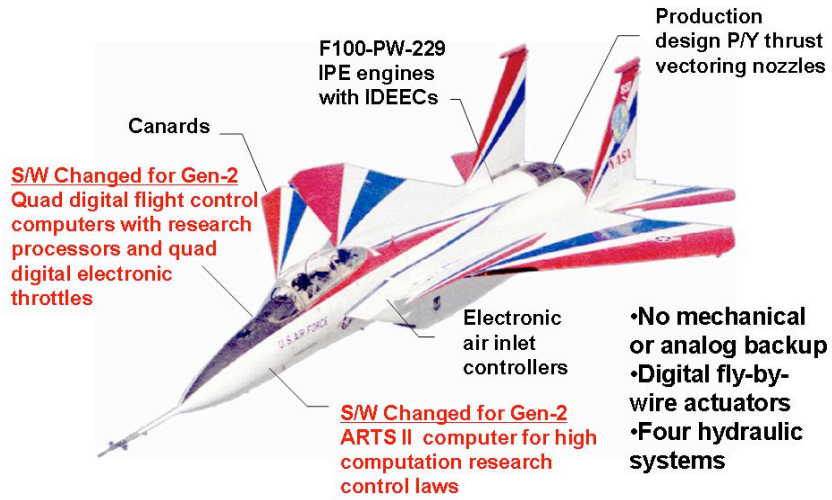

Figure 1. NASA IFCS NF-15B, NASA 837

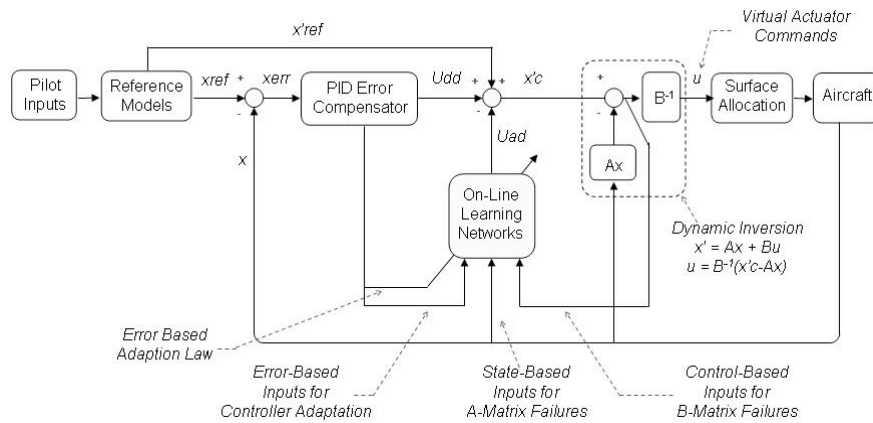

Figure 2. IFCS Gen-2 Control Architecture

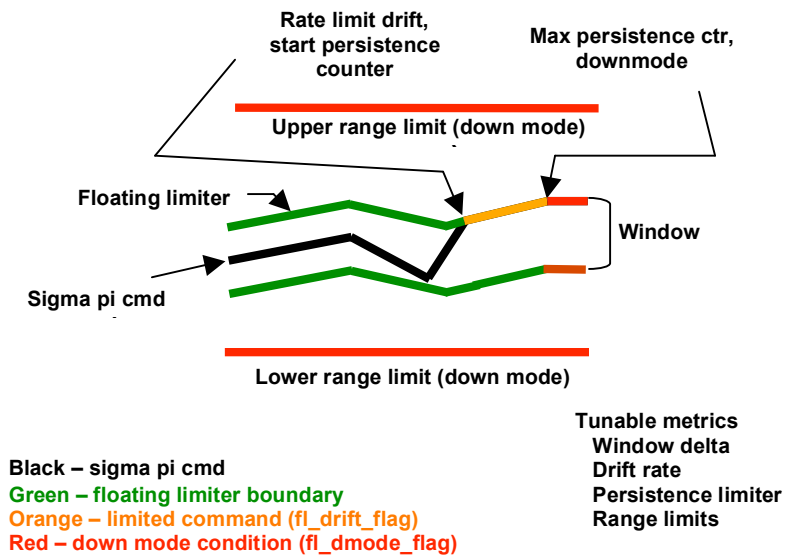

Figure 3. Floating Limiter Design

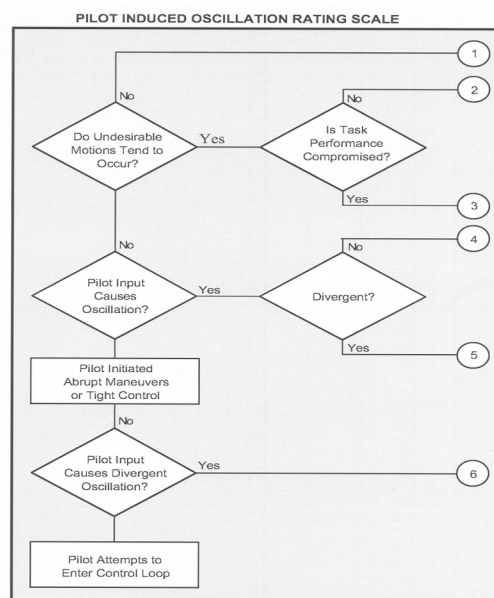

Figure 4. PIO Rating Scale

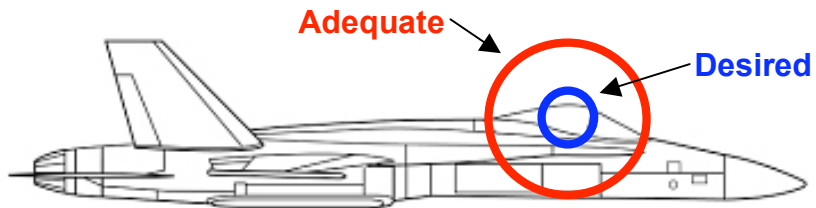

Figure 5. Desired and Adequate Criteria for HQ Evaluations

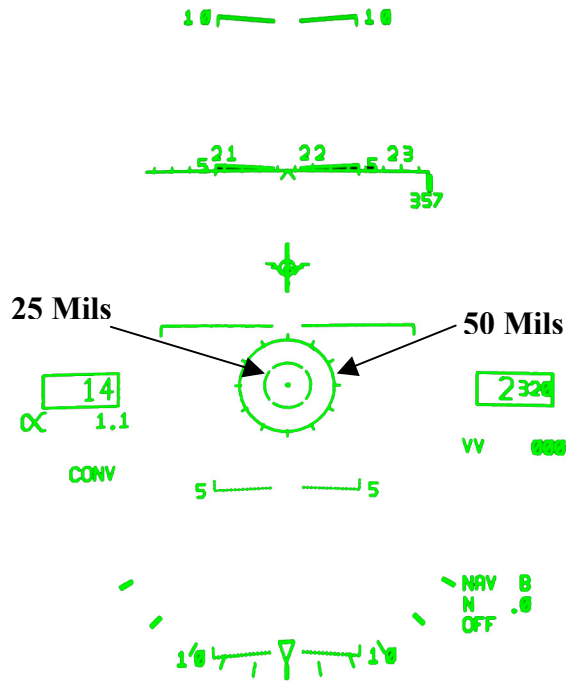
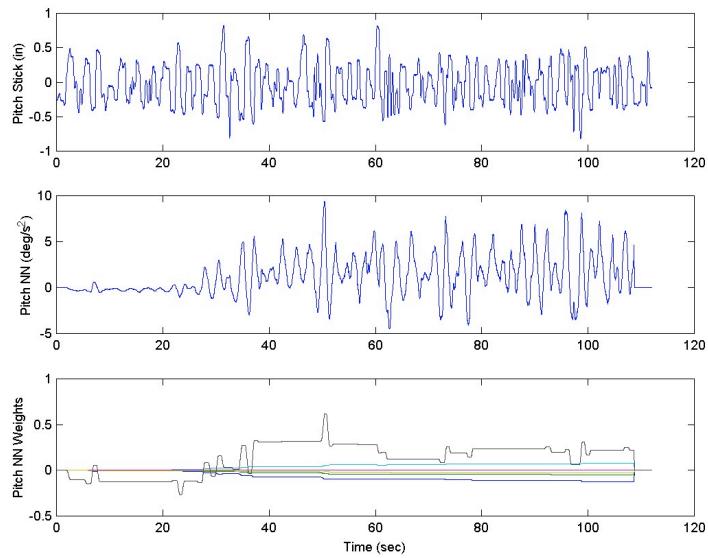
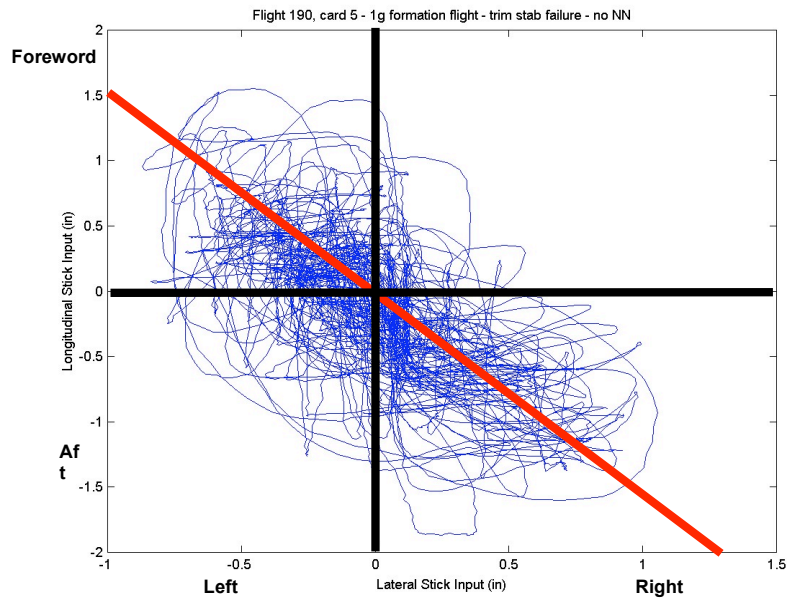

Figure 6. Gun Sight Used in HQ Evaluations



**Figure 7. NN Weights Time History for Flight 189, Trim Stabilator Failure HQ Evaluation in Formation Flight**



**Figure 8. Pilot Stick Motions During 1g Formation with Left Stabilator Failed to the Trim Position**



Closed Loop Pitch Axis Technical Performance Metric M=0.75 H=20K CM=-0.5

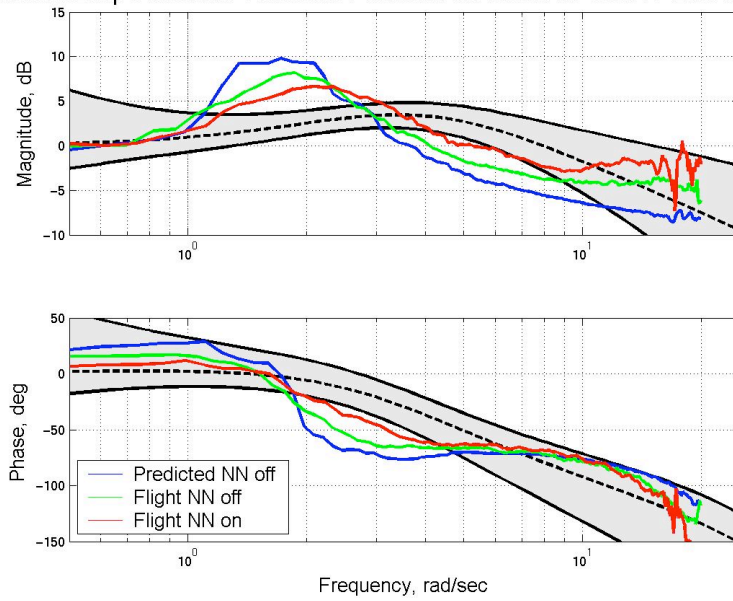

**Figure 9. Closed Loop Pitch Axis Technical Performance Metric Mach 0.75, 20K Feet, Canard Multiplier of -0.5**

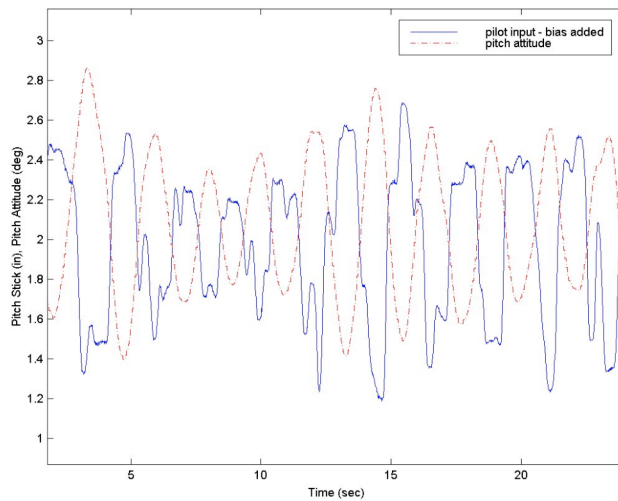

**Figure 10. Pilot Input vs. Pitch Attitude of Aircraft for Trim Stabilator Failure HQ Evaluation in Formation Flight – Pilot A**