

NASA/TP-2005-213937  
ARL-TR-3675



# Loads and Performance Data from a Wind-Tunnel Test of Generic Model Helicopter Rotor Blades

*William T. Yeager, Jr., and Matthew L. Wilbur  
U.S. Army Research Laboratory  
Vehicle Technology Directorate  
Langley Research Center, Hampton, Virginia*

---

November 2005

## The NASA STI Program Office . . . in Profile

Since its founding, NASA has been dedicated to the advancement of aeronautics and space science. The NASA Scientific and Technical Information (STI) Program Office plays a key part in helping NASA maintain this important role.

The NASA STI Program Office is operated by Langley Research Center, the lead center for NASA's scientific and technical information. The NASA STI Program Office provides access to the NASA STI Database, the largest collection of aeronautical and space science STI in the world. The Program Office is also NASA's institutional mechanism for disseminating the results of its research and development activities. These results are published by NASA in the NASA STI Report Series, which includes the following report types:

- **TECHNICAL PUBLICATION.** Reports of completed research or a major significant phase of research that present the results of NASA programs and include extensive data or theoretical analysis. Includes compilations of significant scientific and technical data and information deemed to be of continuing reference value. NASA counterpart of peer-reviewed formal professional papers, but having less stringent limitations on manuscript length and extent of graphic presentations.
- **TECHNICAL MEMORANDUM.** Scientific and technical findings that are preliminary or of specialized interest, e.g., quick release reports, working papers, and bibliographies that contain minimal annotation. Does not contain extensive analysis.
- **CONTRACTOR REPORT.** Scientific and technical findings by NASA-sponsored contractors and grantees.

- **CONFERENCE PUBLICATION.** Collected papers from scientific and technical conferences, symposia, seminars, or other meetings sponsored or co-sponsored by NASA.
- **SPECIAL PUBLICATION.** Scientific, technical, or historical information from NASA programs, projects, and missions, often concerned with subjects having substantial public interest.
- **TECHNICAL TRANSLATION.** English-language translations of foreign scientific and technical material pertinent to NASA's mission.

Specialized services that complement the STI Program Office's diverse offerings include creating custom thesauri, building customized databases, organizing and publishing research results ... even providing videos.

For more information about the NASA STI Program Office, see the following:

- Access the NASA STI Program Home Page at <http://www.sti.nasa.gov>
- E-mail your question via the Internet to [help@sti.nasa.gov](mailto:help@sti.nasa.gov)
- Fax your question to the NASA STI Help Desk at (301) 621-0134
- Phone the NASA STI Help Desk at (301) 621-0390
- Write to:  
NASA STI Help Desk  
NASA Center for AeroSpace Information  
7121 Standard Drive  
Hanover, MD 21076-1320

NASA/TP-2005-213937  
ARL-TR-3675



# Loads and Performance Data from a Wind-Tunnel Test of Generic Model Helicopter Rotor Blades

*William T. Yeager, Jr., and Matthew L. Wilbur  
U.S. Army Research Laboratory  
Vehicle Technology Directorate  
Langley Research Center, Hampton, Virginia*

National Aeronautics and  
Space Administration

Langley Research Center  
Hampton, Virginia 23681-2199

November 2005

Available from:

NASA Center for AeroSpace Information (CASI)  
7121 Standard Drive  
Hanover, MD 21076-1320  
(301) 621-0390

National Technical Information Service (NTIS)  
5285 Port Royal Road  
Springfield, VA 22161-2171  
(703) 605-6000

## Abstract

*An investigation was conducted in the NASA Langley Transonic Dynamics Tunnel to acquire data for use in assessing the ability of current and future comprehensive analyses to predict helicopter rotating-system and fixed-system vibratory loads. The investigation was conducted with a generic model helicopter rotor system using blades with rectangular planform, no built-in twist, uniform radial distribution of mass and stiffnesses, and a NACA 0012 airfoil section. Rotor performance data, as well as mean and vibratory components of blade bending and torsion moments, fixed-system forces and moments, and pitch link loads were obtained at advance ratios up to 0.35 for various combinations of rotor shaft angle-of-attack and collective pitch. The data are presented without analysis.*

## Introduction

Vibratory loads, and the resulting vibrations, have always been a problem for helicopters. Excessive vibration levels have adverse effects on crewmembers, passengers, and aircraft components. As mission requirements force helicopters to fly faster, the vibration problem becomes more pronounced because of the increased vibratory loads caused by the higher speeds. Decreased vibration levels result in enhanced productivity and effectiveness of helicopters through reduced crew and passenger fatigue and discomfort, increased aircraft component reliability, and reduced aircraft maintenance costs.

The primary contributor to helicopter vibration is the main rotor. Vibratory loads caused by harmonic variations in main-rotor blade airloads are transmitted through the rotor shaft and into the fuselage. Accurate prediction of these vibratory loads is an important first step in reducing vibrations because it permits attacking the problem at the source and enables researchers to develop an understanding of the roles played by various design parameters with regard to helicopter vibration (refs. 1 & 2). References 3-5 indicate that the state-of-the-art of rotor loads analyses has made the successful prediction of rotor loads difficult, particularly for the higher frequency loads that are of primary interest when addressing helicopter vibrations. Furthermore, reference 6 indicates that the prediction capability

of current analyses has not improved greatly over the years. However, some success has been reported in references 7-9 where optimization methods are used in conjunction with comprehensive analyses to predict vibratory loads and design low-vibration main-rotor blades.

The next step in rotorcraft vibratory loads prediction will involve the coupling of computational fluid dynamics (CFD) methodologies with comprehensive analyses. The expected benefits of incorporating CFD in vibratory loads predictions include improved calculations of induced velocity fields and wake characteristics. Two examples of the use of CFD in rotorcraft calculations are presented in references 10 and 11 and indicate mixed results with regard to the successful use of CFD methodologies.

The search for analyses that can accurately predict rotor vibratory loads will continue until an analysis is identified that can provide a designer confidence that the goal of lower vibration can be met before committing to a costly fabrication process. To aid in the identification of such an analysis, an investigation was undertaken in the NASA Langley Transonic Dynamics Tunnel (TDT) using a generic model rotor system to acquire fixed- and rotating-system vibratory loads data. The model rotor blades used to obtain these data are elementary in both design and construction, utilizing a rectangular planform, no built-in twist, constant structural properties along

the blade, and a symmetrical airfoil section. Additionally, the blade spar is metallic and rectangular in cross-section to provide stable, flat surfaces for mounting the strain-gage bridges that measure blade bending and torsion loads. The blade characteristics should be easy to incorporate in analytical models, making the data obtained during this investigation useful as a benchmark in identifying the mechanisms that produce rotorcraft vibratory loads as well as determining the ability of current and future analyses to predict these loads.

## Symbols

The positive directions of fixed-system forces, moments, angles, and velocities and blade bending and torsion moments are shown in figure 1. The symbols in parentheses are used in the data tables.

A	fixed-system strain-gage balance axial force, lb
$A_n$ (Mag)	magnitude of $n^{\text{th}}$ harmonic of blade, strain-gage balance, or pitch link load, in-lbs or lbs
$A_0$ (MEAN)	mean value of Fourier analysis of blade, strain-gage balance, or pitch link load, in-lbs or lbs
$A_1$	rotor first-harmonic lateral cyclic pitch angle, deg
a	speed of sound, ft/sec
$a_{1s}$	rotor first-harmonic longitudinal flapping angle with respect to the rotor shaft, deg
$B_1$	rotor first-harmonic longitudinal cyclic pitch angle, deg
b	number of blades
$b_{1s}$	rotor first-harmonic lateral flapping angle with respect to the rotor shaft, deg

$C_D$	rotor drag coefficient, $D / \rho\pi R^2(\Omega R)^2$
$C_L$	rotor lift coefficient, $L / \rho\pi R^2(\Omega R)^2$
$C_Q$	rotor torque coefficient, $Q / \rho\pi R^3(\Omega R)^2$
c	nominal blade chord, 3.625 in
D	rotor drag, lb, $N \sin \alpha_S + A \cos \alpha_S$
d	rotor diameter, 9.370 ft
g	gravitational constant, 32.2 ft / sec <sup>2</sup>
$I_0$	blade section torsional mass moment of inertia, slug-ft <sup>2</sup> / ft
L	rotor lift, lb, $N \cos \alpha_S - A \sin \alpha_S$
$L_{\text{Nom}}$	nominal rotor lift, lb
$M_T$	rotor tip Mach number, $\Omega R / a$
N	fixed-system strain-gage balance normal force, lb
n	harmonic index
$nP$	$n^{\text{th}}$ harmonic of rotor rotational frequency
PM	fixed-system strain-gage balance pitching moment, in-lb
RM	fixed-system strain-gage balance rolling moment, in-lb
Q	rotor shaft torque measured by fixed-system strain-gage balance, in-lb
R	rotor radius, 4.685 ft
r	spanwise distance along blade radius measured from center of rotation, in

S	fixed-system strain-gage balance side force, lb
V	free-stream velocity, ft / sec
YM	fixed-system strain-gage balance yawing moment, in-lb
z	distance from wind-tunnel floor to rotor hub, ft
$\alpha_s$	rotor shaft angle of attack, deg
$\theta$	rotor blade collective pitch angle at 0.75R, deg
$\mu$	rotor advance ratio, $V / \Omega R$
$\rho$	test-medium mass density, slugs / ft <sup>3</sup>
$\varphi_n$ (Phase)	phase angle of n <sup>th</sup> harmonic of blade, strain-gage balance, or pitch link load, deg
$\psi$	rotor blade azimuth angle, deg
$\Omega$	rotor rotational velocity, rad / sec
$\omega$	natural frequency of rotating blade mode, rad / sec
Subscripts:	
Nom	nominal

## Apparatus and Procedures

### Wind Tunnel

The testing was conducted in the Langley Transonic Dynamics Tunnel (TDT), schematics of which are shown in figure 2. The TDT is a continuous-flow tunnel with a slotted test section and is capable of operation up to Mach 1.2 at stagnation pressures up to one atmosphere. The tunnel test section is 16 feet square with cropped corners and has a cross-sectional area of 248 ft<sup>2</sup>. The tunnel uses either air or a heavy gas as its test

medium. The tunnel was originally constructed to use R-12 as the test medium (ref. 12). Environmental concerns raised in the late-1980s regarding the continued use of R-12 led to a NASA decision to replace R-12 with the essentially equivalent refrigerant R-134a. Conversion of the TDT heavy gas test medium to R-134a was completed in 1997 and is described in references 13 and 14. The investigation documented in this report was conducted before the conversion to R-134a and so R-12 at a nominal density of 0.006 slugs/ft<sup>3</sup> was used as the test medium. The use of a heavy gas test medium with a high density and low speed of sound, such as either R-12 or R-134a, aids the matching of model-rotor-scale Reynolds number and Mach number to full-scale values. Furthermore, some restrictions on model structural design are eased, and dynamic similarity is still maintained. The heavier test medium permits a simplified structural design to obtain the required stiffness characteristics, and thus eases design and fabrication requirements of the model (ref. 15).

### Model Description

The rotor model used in this investigation was a four-bladed, articulated rotor with coincident lead-lag and flapping hinges operating with a pitch-flap coupling ratio of 0.5 deg/deg (flap up, pitch down). The attachment point of the blade pitch link was 1.4 inches aft of the blade pitch axis and 0.7 inches inboard of the blade flapping hinge. The rotor blades were rectangular in planform and used a rectangular aluminum spar as the primary load-carrying member. Calculated model blade structural properties and rotating natural frequencies are presented in Table I. The calculated blade rotating frequencies were determined by using the second-generation version of the Comprehensive Analytical Model of Rotorcraft Aerodynamics and Dynamics (CAMRAD-II) (ref. 16) code. Measured rotating frequencies were determined during the course of the test by a rotating shake test.

The airfoil used over the entire blade length was a NACA 0012 with the airfoil contour provided by a Rohacell WF-51 foam core bonded

to the aluminum spar with the spar centered at the blade quarter chord. The foam core was wrapped with a fiberglass skin consisting of two layers of 0.004 inch thick E-glass oriented at +/- 20 degrees. Brass weights were used at the blade leading edge and 3 inches aft of the leading edge to place the blade center of gravity at the blade quarter chord and to provide the desired blade torsional inertia. The blades had no built-in twist. Blade cross-sectional details, planform geometry and construction details are shown in figure 3. One blade was instrumented with resistance-wire strain-gage bridges bonded to the blade spar at the blade quarter chord and calibrated to measure blade structural moments about three axes at several blade radial stations. Flapwise (out-of-plane) strain-gage bridges were installed at 23, 37, 51, 63, 74, and 82 percent radius. Chordwise (in-plane) strain-gage bridges were installed at 30, 45, and 77.23 percent radius, and torsional strain-gage bridges were installed at 35, 60, and 85 percent radius. The blade design parameters were chosen in order to provide a simple structure that could be easily modeled analytically, could be built for a minimal cost, and would provide a consistent data set for correlation with analysis.

The blades were tested using the Aeroelastic Rotor Experimental System (ARES) testbed shown in figures 4 and 5. The ARES has a streamlined helicopter fuselage shape enclosing the rotor controls and drive system, and is powered by a variable frequency synchronous motor rated at 47-hp output at 12,000 rpm. The motor is connected to the rotor shaft through a belt-driven two-stage speed reduction system. The ARES rotor control system and rotor shaft angle of attack are remotely controlled from the wind-tunnel control room. The rotor shaft angle of attack is varied by an electrically controlled hydraulic actuator. Blade collective pitch and lateral and longitudinal cyclic pitch are input to the rotor through the swashplate, which is positioned by three hydraulic actuators.

Instrumentation on the ARES testbed allows continuous displays of model control settings, rotor forces and moments, blade loads, and pitch link loads. For this test all four pitch links were

instrumented to provide tension and compression loads. The ARES rotor shaft pitch attitude is measured by an accelerometer, and rotor control positions are measured by linear potentiometers connected to the swashplate. Rotor blade flap and lag angles are measured by rotary potentiometers mounted on the rotor hub and geared to the blade cuff. Rotor shaft speed is determined by a magnetic sensor. The rotating blade data are transferred to the fixed system through a 30-channel slip-ring assembly. A six-component strain-gage balance mounted below the pylon and drive system measures rotor forces and moments. The balance is fixed with respect to the rotor shaft and pitches with the fuselage. The balance does not sense fuselage forces and moments.

## Test Procedure

During this test, data were acquired in both hover ( $\mu = 0.0$ ) and in forward flight ( $\mu = 0.06 - 0.35$ ). In hover, data were obtained at  $z/d = 0.85$ ,  $M_T = 0.65$  and zero degrees shaft angle of attack over a range of blade collective pitch values. At each test point in forward flight the rotor rotational speed and tunnel conditions were adjusted to give the desired values of tip Mach number and advance ratio. The testbed was then pitched to the desired shaft angle of attack. Blade collective pitch was changed to obtain variations in rotor lift. At each collective pitch setting, cyclic pitch was used to remove rotor first-harmonic flapping with respect to the shaft or to set a desired value of first-harmonic flapping with respect to the shaft depending on the desired test condition. Data were then recorded at each value of collective pitch. The maximum value of collective pitch attained at each shaft angle of attack was determined in most cases by blade load limits. Rotor aerodynamic performance and blade loads were measured at nominal advance ratios of 0.06, 0.07, 0.08, 0.09, 0.13, 0.16, 0.20, 0.25, 0.30, and 0.35 for shaft angles of attack from 0 degrees to -6 degrees. Performance and loads data were also obtained at nominal advance ratios of 0.08, 0.11, 0.13, 0.16, 0.20, 0.225, 0.25, 0.275, 0.30, and 0.325 at constant nominal rotor lift values of 160 lbs ( $C_L = 0.00366$ ), 180 lbs ( $C_L = 0.00412$ ), and 200 lbs ( $C_L = 0.00458$ ) for shaft angles of



attack representative of 1g flight at each advance ratio. At the nominal advance ratios of 0.16, 0.20, 0.225, 0.25, 0.275, 0.30, 0.325 data were also obtained at  $\pm 1$  degree of rotor first harmonic longitudinal and lateral flapping with respect to the shaft at a nominal rotor lift value of 180 lbs.

Model deadweight tares were determined throughout the range of shaft angles of attack with the blades on and with them removed. Aerodynamic rotor hub tares were determined with the blades removed throughout the ranges of shaft angles of attack and advance ratios investigated. Both deadweight and aerodynamic hub tares have been removed from the data presented. No corrections for tunnel wall effects were applied to the data.

### Measurement Quality

The quality of the performance data obtained during this investigation was addressed. During the test, 234 data points were obtained. Out of this data set, 51 points were repeated. The repeated points were obtained entirely within a particular test run. A test run is defined as data points obtained by increasing then decreasing  $\theta$  for a series of constant values of  $\alpha_s$  and  $\mu$ . Time constraints precluded obtaining any run-to-run repeat points. The average deviation in  $C_L$ ,  $C_D$ , and  $C_Q$  ( $\Delta C_L$ ,  $\Delta C_D$ ,  $\Delta C_Q$ ) was determined between the originally obtained data points and the repeat data points. The average deviations for constant values of  $M_T$ ,  $\mu$ ,  $\alpha_s$ ,  $\theta$ , and zero rotor first-harmonic flapping with respect to the shaft were determined to be as follows:

$$\Delta C_L \dots\dots\dots +0.00002 \text{ to } -0.00002$$

$$\Delta C_D \dots\dots\dots +0.00001 \text{ to } -0.00000$$

$$\Delta C_Q \dots\dots\dots +0.00000 \text{ to } -0.00000$$

The values of  $\Delta C_L$ ,  $\Delta C_D$ , and  $\Delta C_Q$  are presented to the same level of accuracy, i.e., number of decimal places, as the performance data presented in this report.

## Presentation of Results

The rotor performance and loads data obtained during this investigation are presented in both figures and tables. Rotor performance is presented as plots of  $C_L$  versus  $C_Q$  for hover, and in forward flight as plots of  $C_L$  versus  $C_D$  and  $C_L$  versus  $C_Q$  for advance ratios from 0.09 to 0.35. At advance ratios of 0.06, 0.07, and 0.08, insufficient data were obtained for meaningful plots to be created, so results at these advance ratios are only presented in tabular form. The rotor performance data obtained at constant nominal values of rotor lift and with variations from trim in rotor first-harmonic flapping angles with respect to the shaft are also only presented in tabular format. The rotor performance parameters  $C_L$ ,  $C_D$ , and  $C_Q$  are tabulated along with the corresponding rotor control angles  $A_1$ ,  $B_1$ , and  $\theta$  for all forward flight data points. In hover, no values of  $A_1$  and  $B_1$  are presented. For the conditions of constant nominal rotor lift and non-trim rotor first-harmonic flapping with respect to the shaft, the corresponding nominal rotor lift and flapping values are also tabulated. Each plotted and tabulated data point is identified by a specific test run number and point number. For example, point 150 within run 7 is indicated as 7.150 in the plots. The rotor loads data are presented in tabular form and consist of the mean (MEAN), oscillatory (1/2 peak to peak (1/2 P-P)), and first ten harmonics (1P to 10P) of a Fourier analysis of the instrumented blade strain-gage signals, fixed-system strain-gage balance signals and pitch link strain-gage signals. Pitch link loads are presented in the tables for blades 1 through 4 with blade 1 defined as the reference blade and blades 2 – 4 numbered clockwise, when viewed from above, from blade 1. The loads data, like the performance data, are identified by a specific test run number and point number, thus allowing cross-referencing of loads and performance data. No information is presented for the flapwise strain-gage bridge installed at 82 percent radius because of a failure in the bridge. Also, no results are presented in Table V (Run 9) for the torsional strain-gage bridge installed at 85 percent radius because of instrumentation problems during the run. The magnitudes (Mag) of the blade flapwise,

chordwise and torsion loads are presented in inch-pounds, the magnitude of the fixed-system strain-gage balance loads are presented in pounds and inch-pounds, and the magnitude of the pitch link loads is presented in pounds. The magnitude of all phase angles (Phase) is presented in degrees referenced in the direction of rotor rotation from zero degrees over the tail of the ARES testbed. The sign conventions for the blade loads data are as follows: flapwise up, positive; chordwise aft, positive; torsion blade nose-up, positive; and pitch link load for a tension load, positive. The sign conventions for the fixed-system strain-gage balance forces and moments and blade bending and torsion moments are presented in figure 1. The total blade load, pitch link load or strain-gage balance load at any azimuth location may be reconstructed from the tabulated harmonics by using the following equation:

$$Load = A_0 + \sum_{n=1}^{10} A_n \sin(n\psi + \phi_n)$$

The data are presented in the following order:

	Table Number	Figure Number (Performance Data Only)
Hover Performance	II	6
Performance and loads, $\mu = 0.06-0.08$	III	---
Performance and loads, $\mu = 0.09 - 0.20$	III	7 -10
Performance and loads, $\mu = 0.25$	IV	11
Performance and loads, $\mu = 0.30$ and $0.35$	V	12-13
Performance and loads at constant rotor lift and non-trim flapping, $\mu = 0.08 - 0.325$	VI	---

## Concluding Remarks

Rotor performance data, as well as mean and vibratory components of blade bending and torsion moments, fixed-system forces and moments, and pitch link loads data have been obtained with a model articulated helicopter rotor using generic rotor blades. The data were obtained at advance ratios up to 0.35 for various combinations of rotor shaft angle-of-attack and blade collective pitch. These data will be useful as a benchmark for assessing the ability of current and future comprehensive analyses to predict helicopter rotating-system and fixed-system vibratory loads.

## References

1. Taylor, Robert B.: *Helicopter Blade Design for Minimum Vibration*, NASA CR -3825, Oct. 1984.
2. He, C: *A Parametric Study of Harmonic Rotor Hub Loads*. NASA CR - 4558, Nov. 1993.
3. Bousman, William G.; Mantay, Wayne R.: A Review of Research in Rotor Loads. Presented at *NASA / Army Rotorcraft Technology Conference*, Mar. 14-16, 1987, NASA-Ames Research Center.
4. Ormiston, Robert A.: Comparison of Several Methods for Predicting Loads on Hypothetical Helicopter Rotor. *Journal of the American Helicopter Society*, Vol. 19, No. 4, Oct. 1974, pp. 2 - 13.
5. Blackwell, R.H., Jr.: Blade Design for Reduced Helicopter Vibration. *Journal of the American Helicopter Society*, vol. 28, No.3, July 1983, pp. 33 - 41.
6. Hansford, R.E.; Vorwald, J.: Dynamics Workshop on Rotor Vibratory Loads Prediction. *Journal of the American Helicopter Society*, Vol. 43, No.1, Jan. 1998, pp. 76 - 86.
7. Weller, W.H.; Davis, M.W.: Wind-Tunnel Tests of Helicopter Blade Designs Optimized for Minimum Vibration. *Journal of the*

- American Helicopter Society*, vol. 34, no. 3, July 1989, pp. 40 - 50.
8. Young, D.K.; and Tarzanin, F.J.: Structural Optimization and Mach Scale Test Validation of a Low Vibration Rotor. *Journal of the American Helicopter Society*, vol. 38, no.3, July 1993, pp. 83 - 92.
  9. Callahan, C.B.; Straub, F.K.: Design Optimization of Rotor Blades for Improved Performance and Vibration. *Journal of the American Helicopter Society*, vol. 38, no. 4, Oct. 1993, pp. 62-70.
  10. Bousman, William G.; et. al.: *A Comparison of Lifting-Line and CFD Methods With Flight Test Data from a Research Puma Helicopter*. NASA TM-110421 (USAATCOM – TR-96-A-008), Oct. 1996.
  11. Bridges, Derek: *Introduction to Computational Fluid Dynamics With Rotorcraft Applications*. AERSP 504, Final Report, Dec. 2000.
  12. Moxey, R.L.: Transonic Dynamics Wind Tunnel. *Compressed Air Magazine*, Vol. 68, Number 10, October 1963, pp. 8-13.
  13. Corliss, James M.; Cole Stanley R.: Heavy Gas Conversion of the NASA Langley Transonic Dynamics Tunnel. AIAA 98-2710, Presented at the 20<sup>th</sup> AIAA Advanced Measurement and Ground Testing Technology Conference, Albuquerque, NM, June 15-18, 1998.
  14. Cole, S.R.; and Garcia, J.L.: Past, Present and Future Capabilities of the Transonic Dynamics Tunnel From an Aeroelasticity Perspective. Presented at the *AIAA Dynamics Specialists Conference*, Atlanta, GA, April 5-6, 2000 (AIAA Paper 2000-1767).
  15. Lee, Charles: Weight Considerations in Dynamically Similar Model Rotor Design. SAWE Paper No. 659, May 1968.
  16. Johnson, Wayne: *CAMRAD-II, Comprehensive Analytical Model of Rotorcraft Aerodynamics and Dynamics*, Johnson Aeronautics, Palo Alto, Calif., 1994.

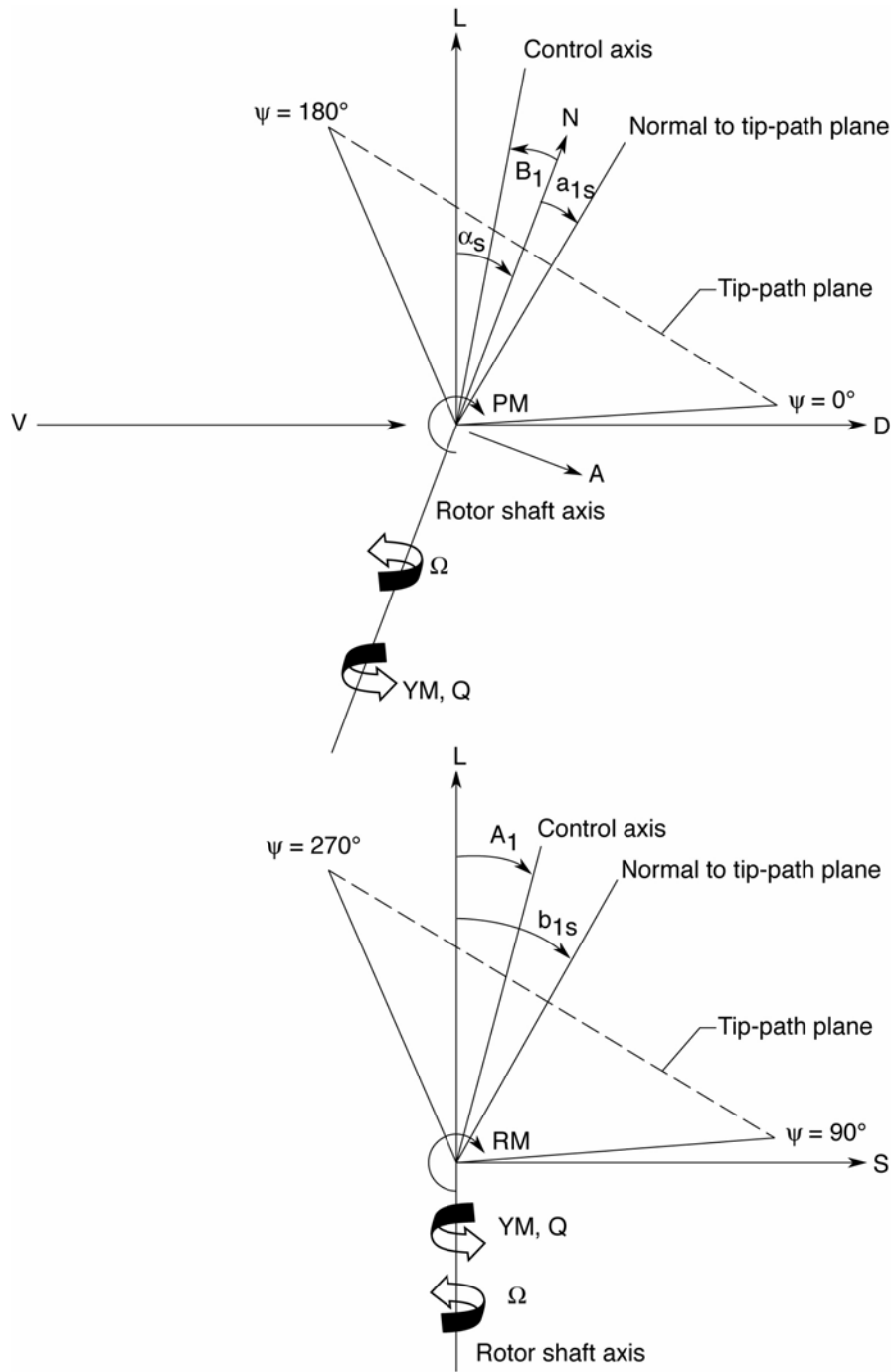

(a) Forces, moments, and velocities

Figure 1. Positive directions of forces, moments, angles and velocities and blade bending and torsion moments.

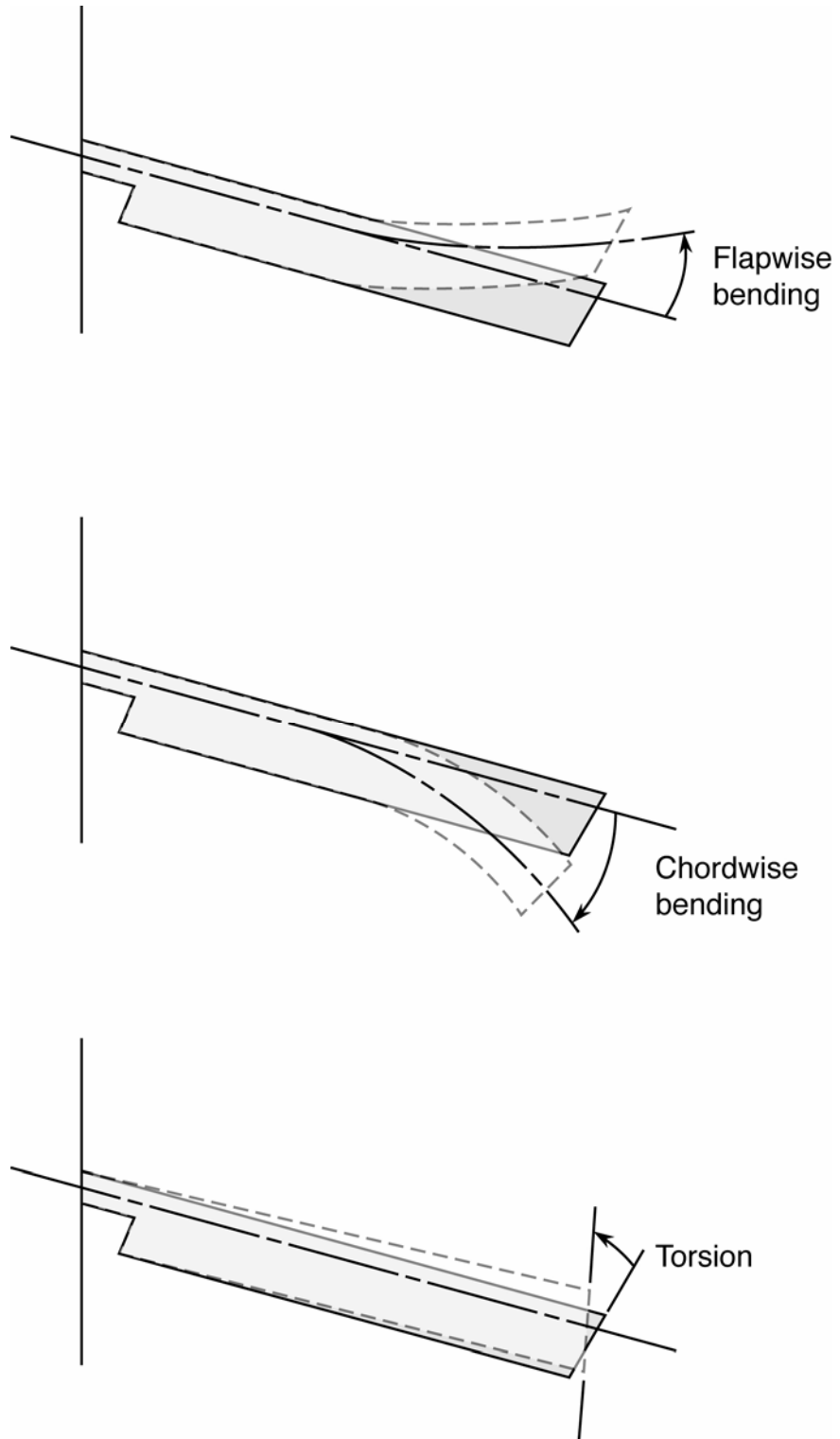

(b) Blade bending and torsion moments

Figure 1. Concluded.

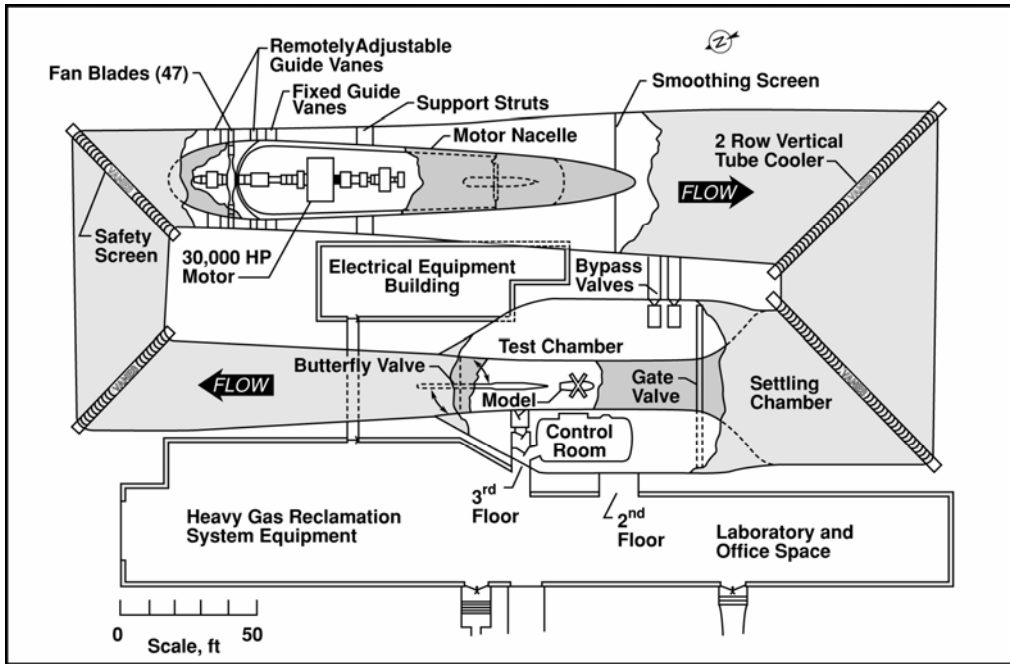

(a) Tunnel planform

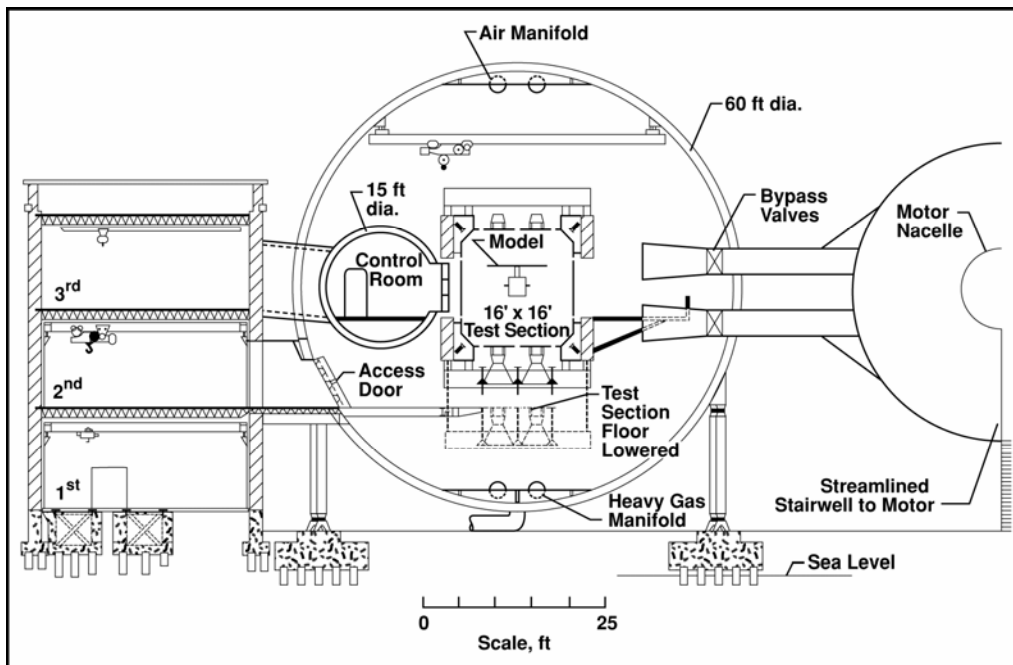

(b) Tunnel cross-section

Figure 2. Langley Transonic Dynamics Tunnel.

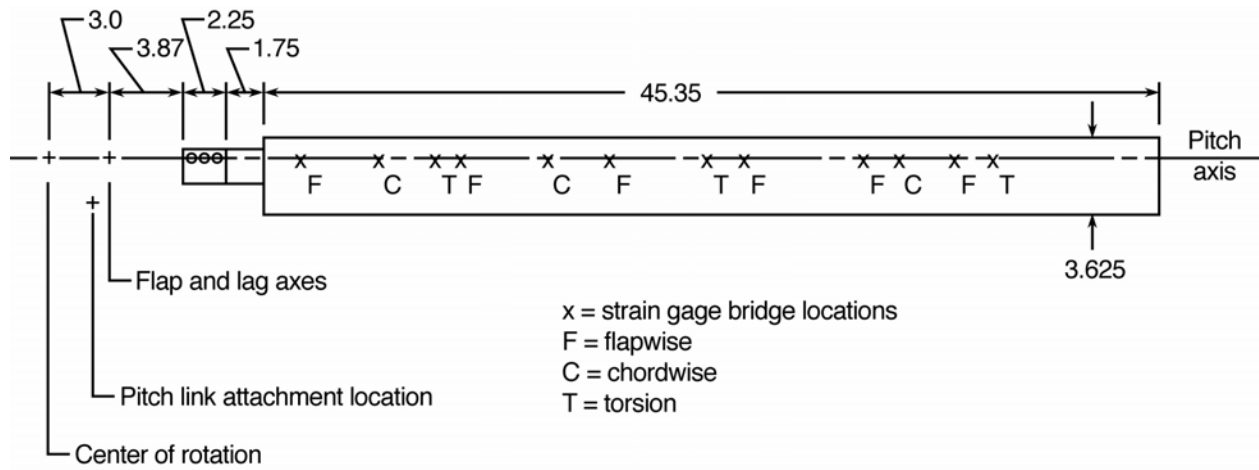

(a) Blade planform

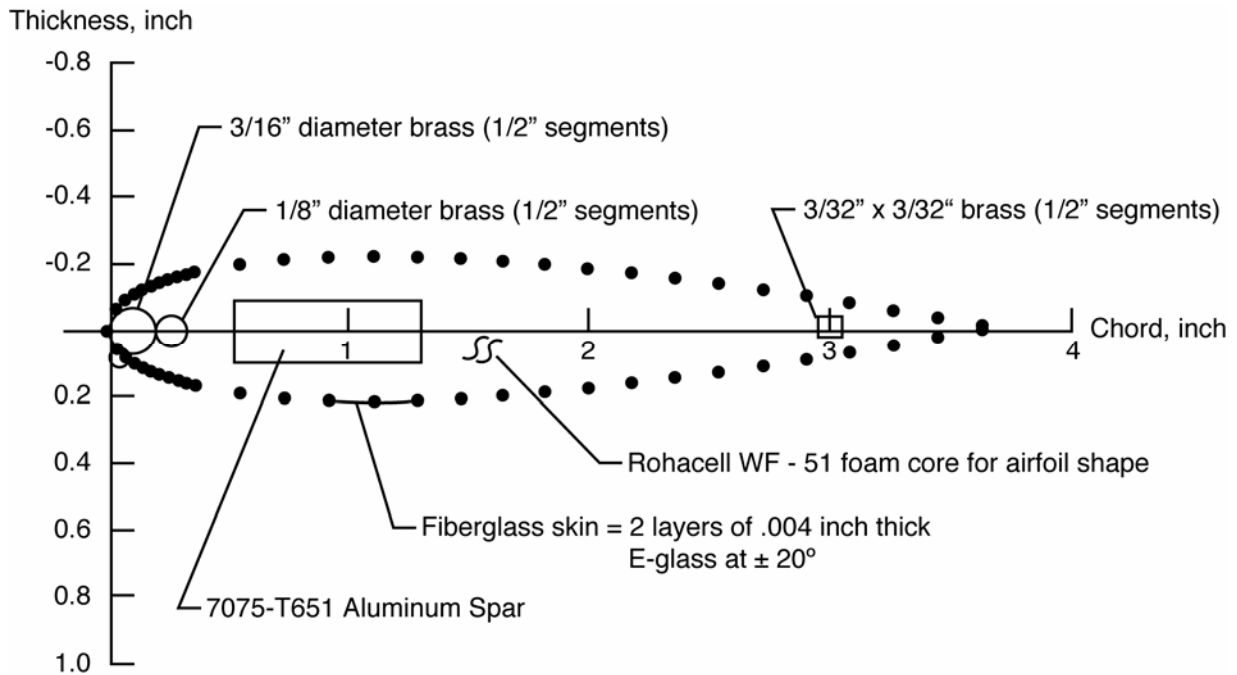

(b) Blade cross-section

Figure 3. Rotor blade geometry. Dimensions in inches.

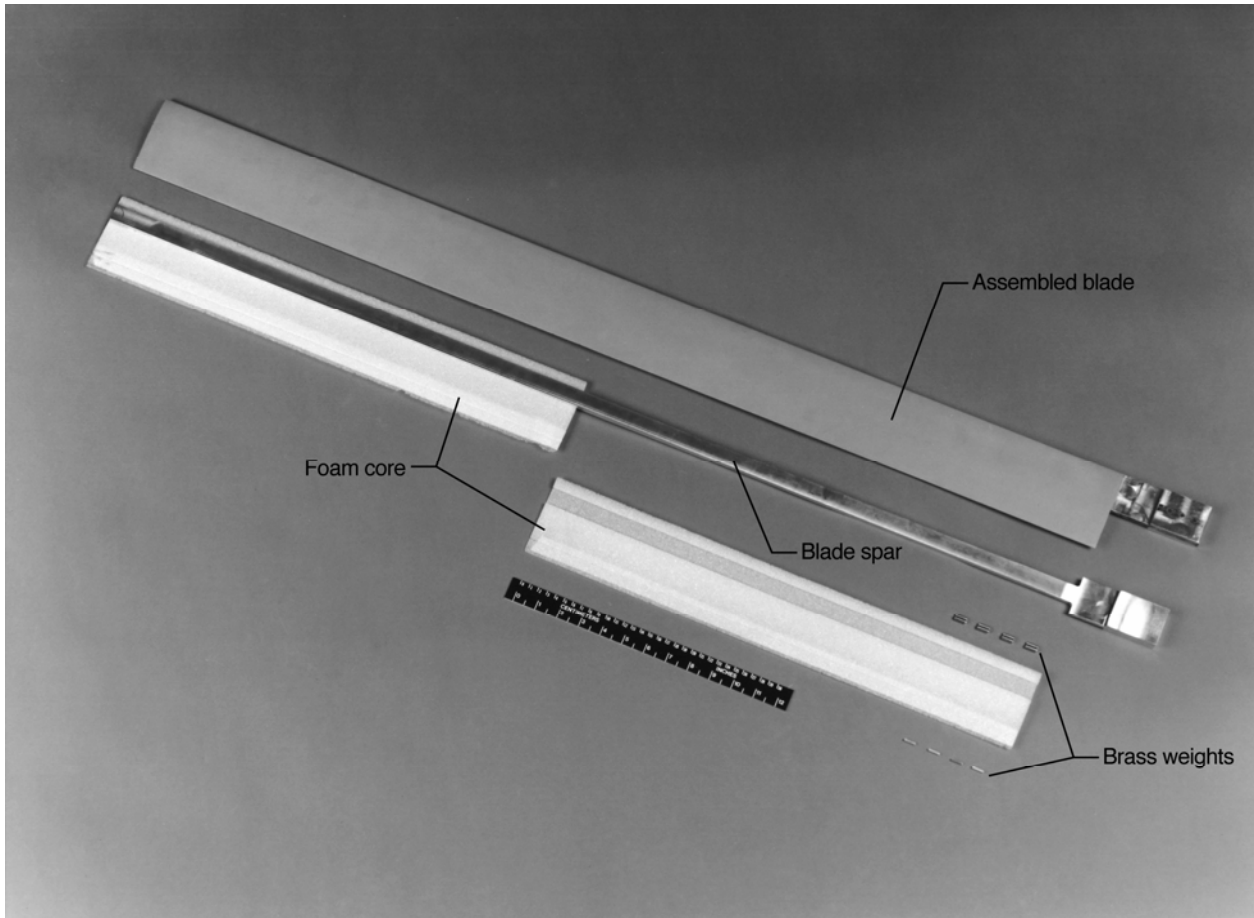

(c) Blade construction details

Figure 3. Concluded.



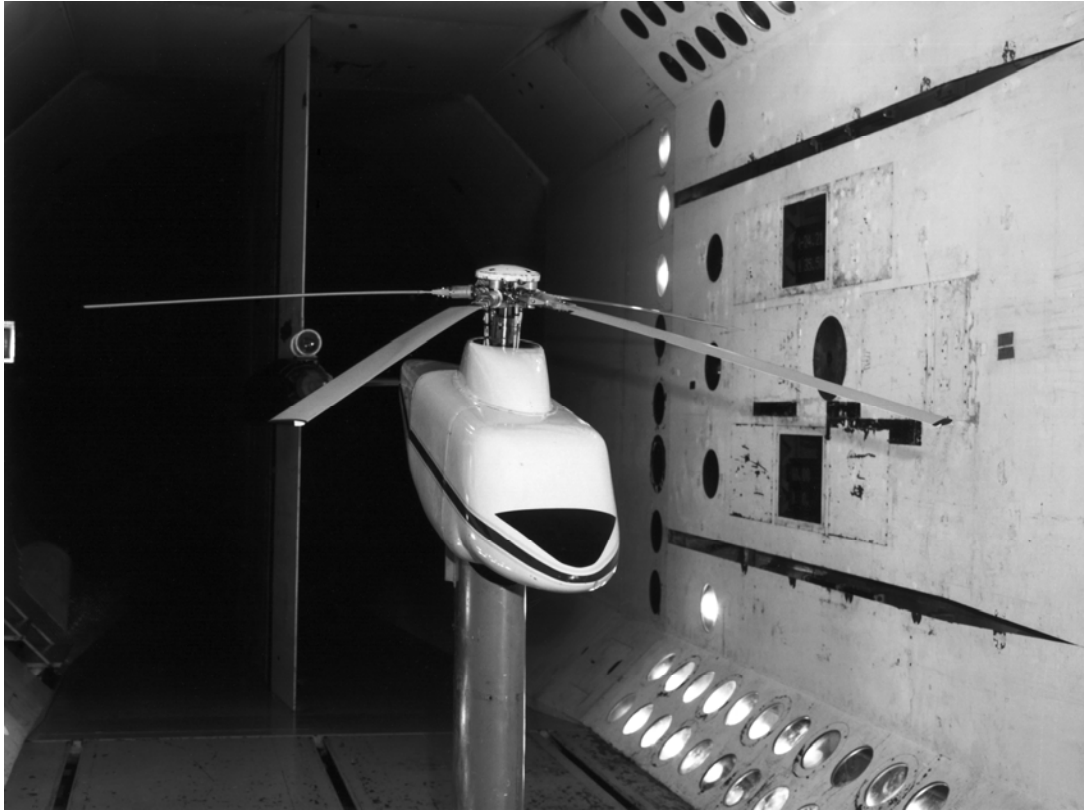

Figure 4. Aeroelastic Rotor Experimental System tested in Langley Transonic Dynamics Tunnel.

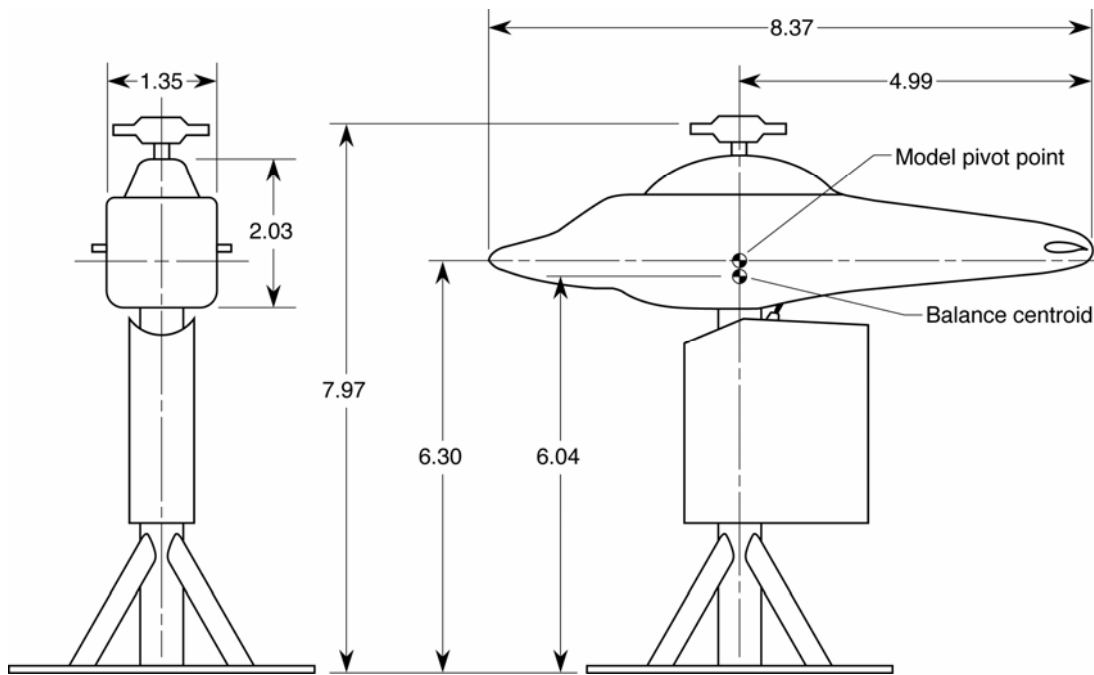

Figure 5. Schematic of Aeroelastic Rotor Experimental System testbed. All dimensions are in feet.

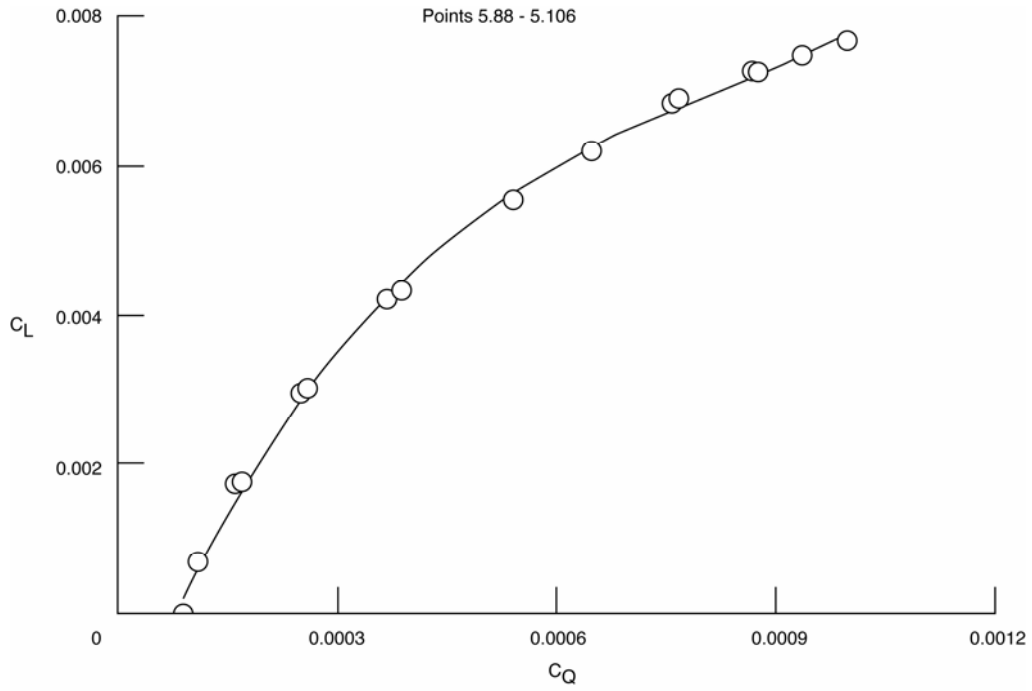

Figure 6. Rotor hover performance.

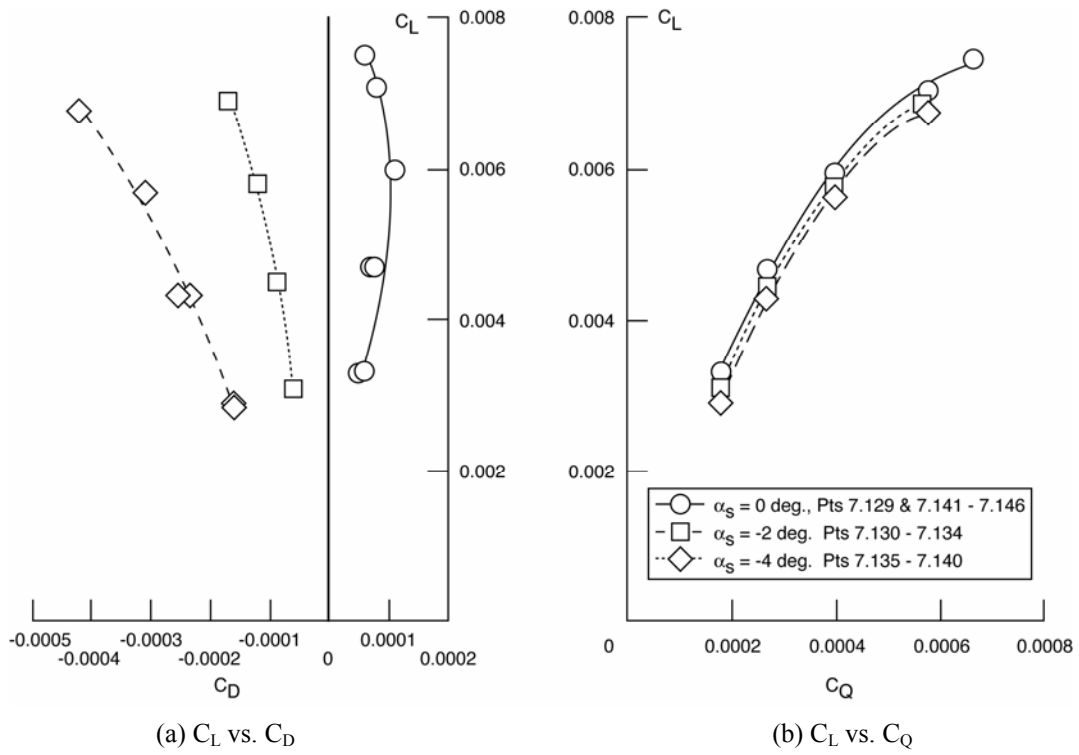

Figure 7. Rotor performance at  $\mu = 0.09$ .

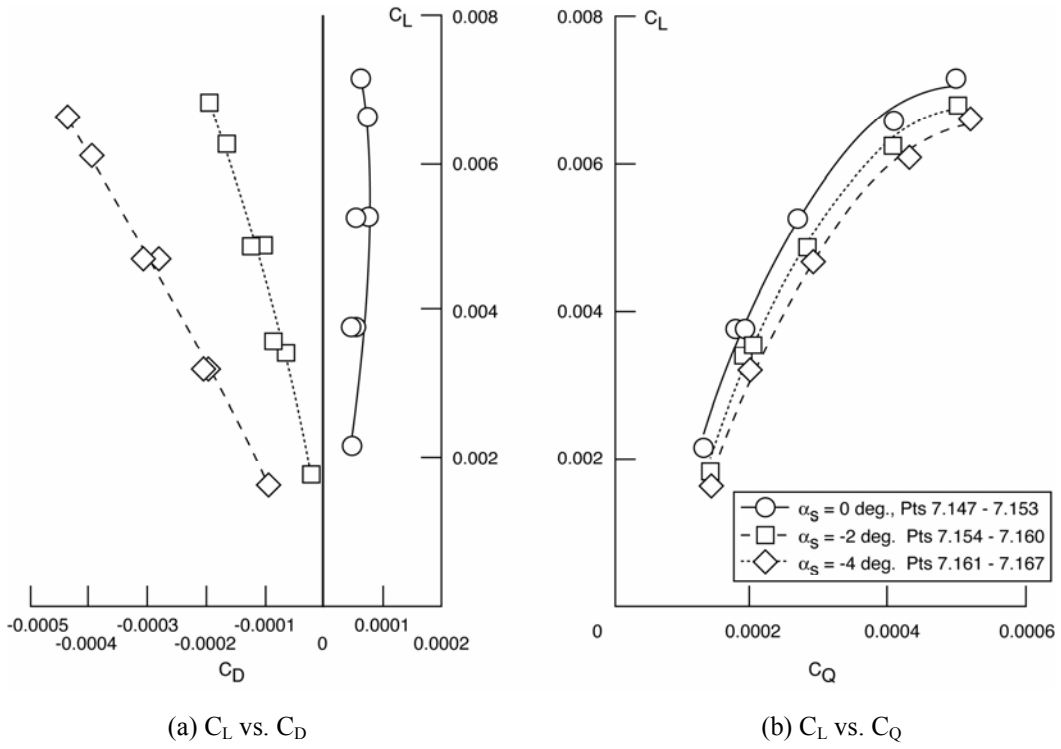

Figure 8. Rotor performance at  $\mu = 0.13$ .

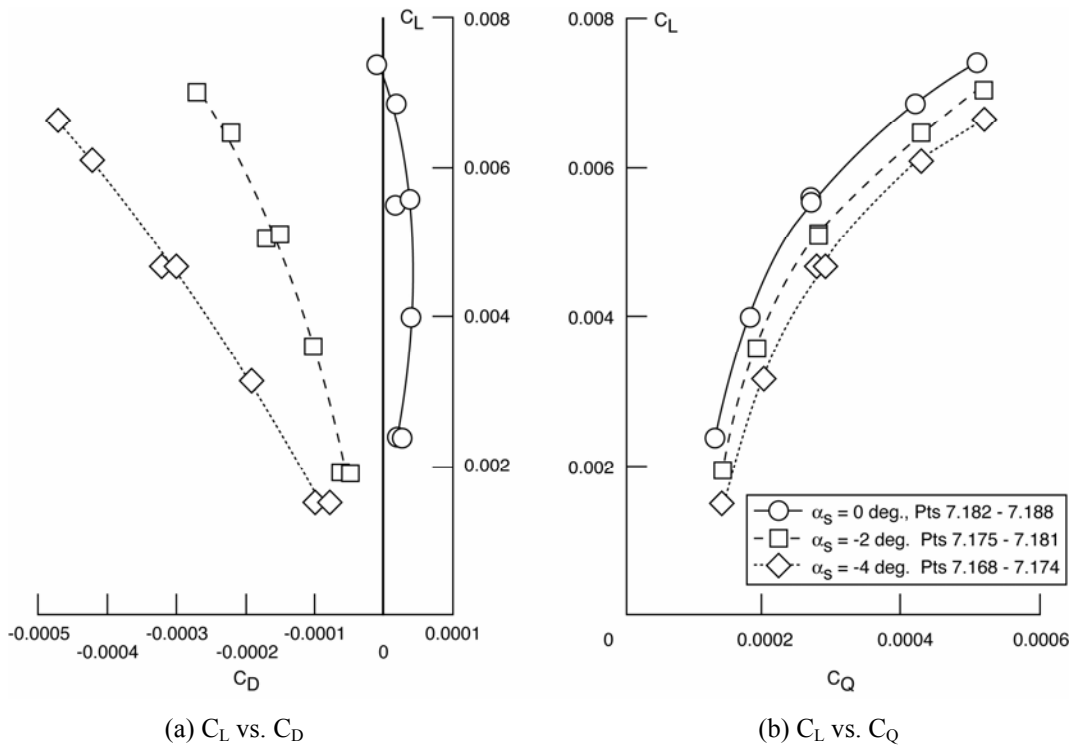

Figure 9. Rotor performance at  $\mu = 0.16$ .

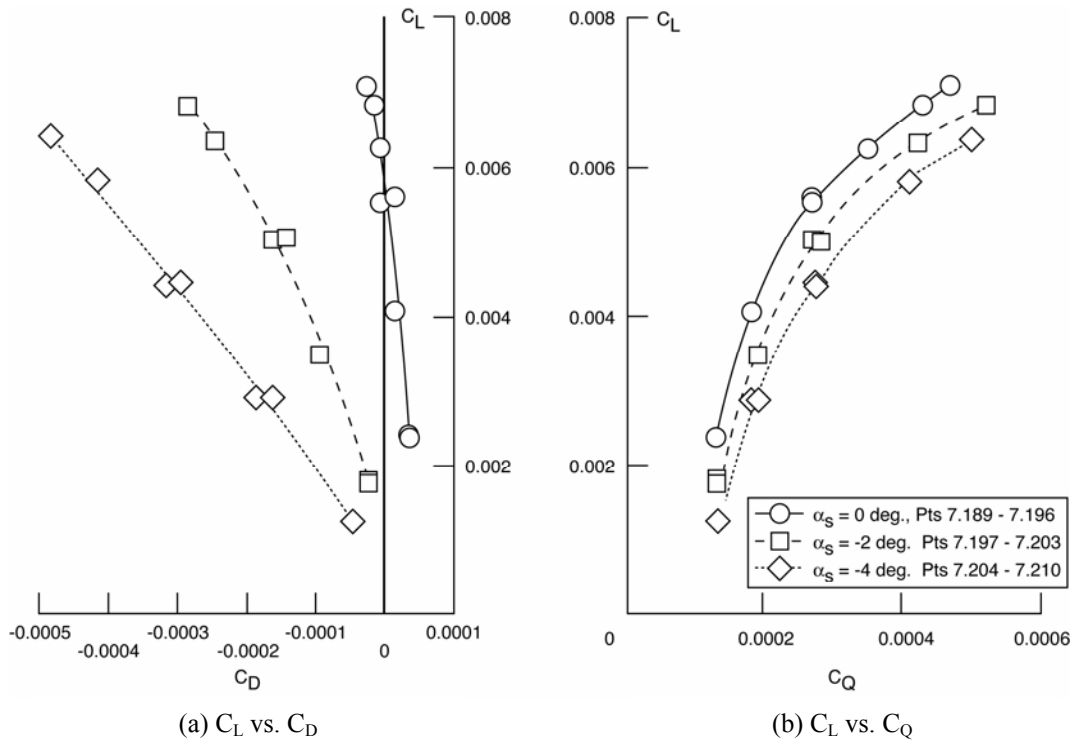

Figure 10. Rotor performance at  $\mu = 0.20$ .

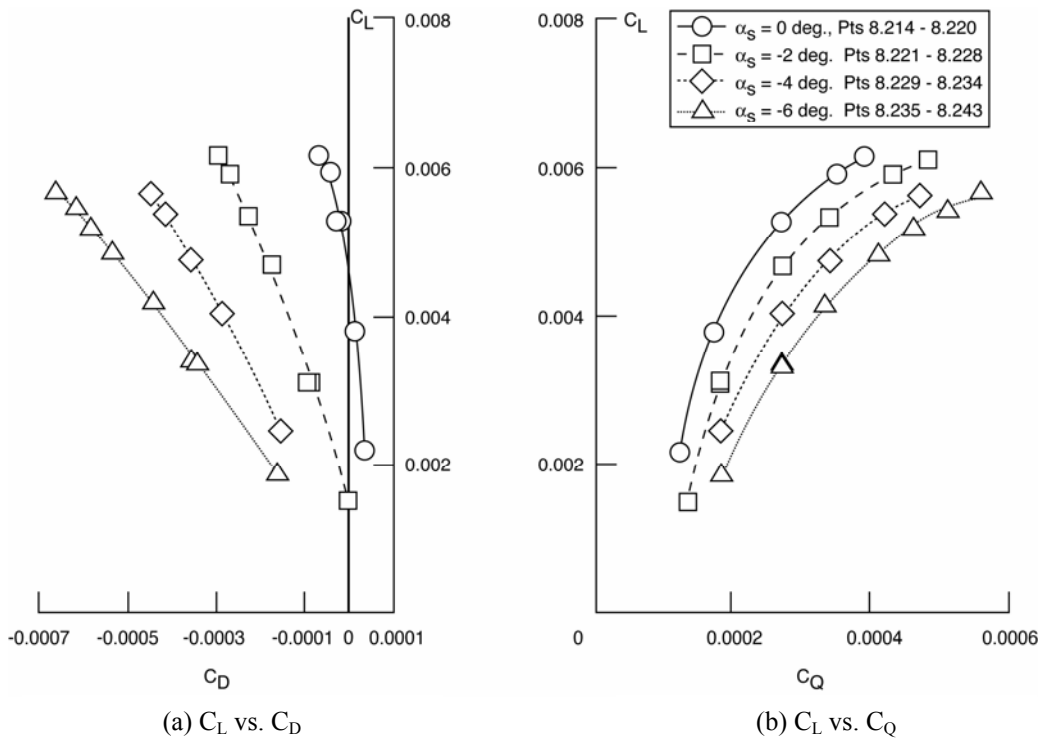

Figure 11. Rotor performance at  $\mu = 0.25$ .

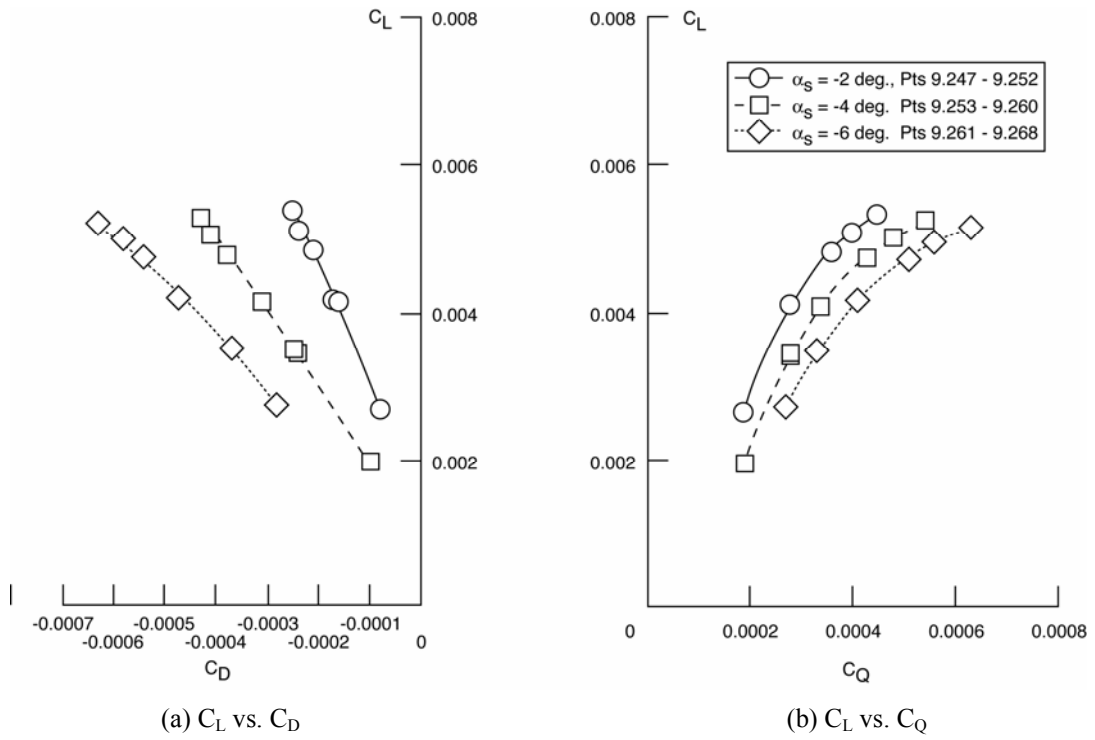

Figure 12. Rotor performance at  $\mu = 0.30$ .

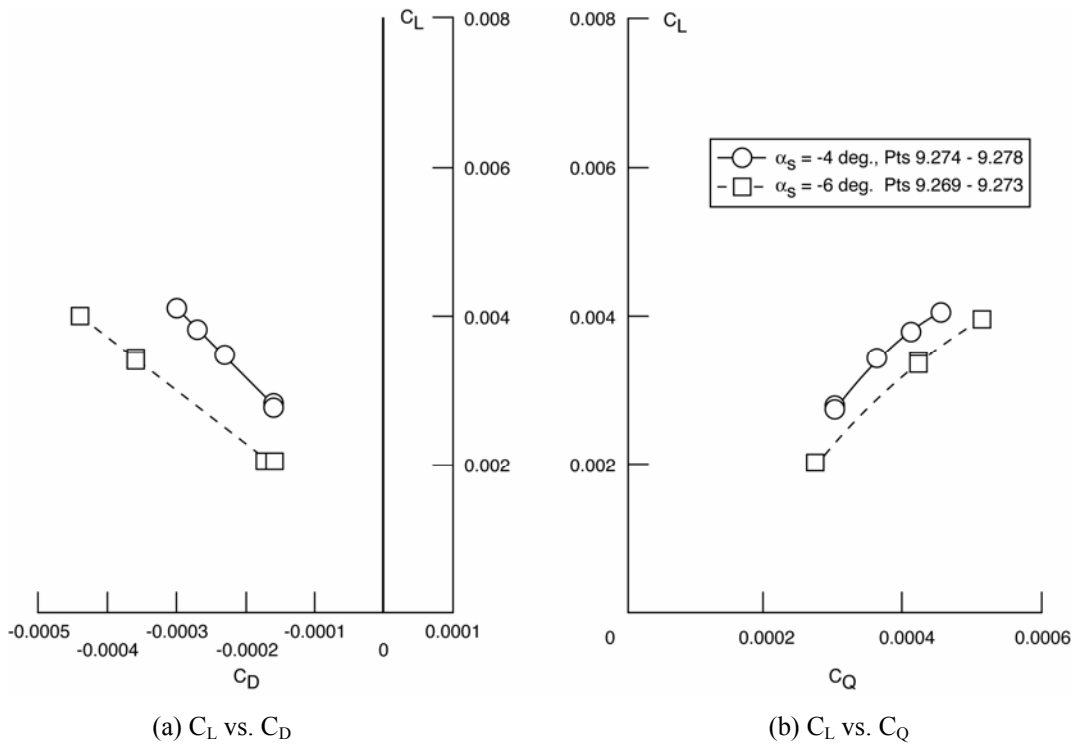

Figure 13. Rotor performance at  $\mu = 0.35$ .

Table I. Rotor Blade Properties

(a) Calculated structural properties

Inboard section, r/R	Section length, ft	Section mass, slugs / ft	Stiffness, lb-ft <sup>2</sup>			I <sub>0</sub> , Slug-ft <sup>2</sup> / ft
			Flapwise	Chordwise	Torsion	
0.1222	0.1875	0.037	1831.9	17889.4	7467.3	0.000072
0.1622	0.1458	0.016	163.0	7986.3	3085.7	0.000029
0.1933	3.7792	0.015	106.0	2850.0	123.0	0.000076

(b) Model rotor-blade rotating elastic natural frequencies

Modal Identity	$\omega / \Omega^1$	
	Calculated	Measured
1 <sup>st</sup> Flapwise	2.71	2.70
2 <sup>nd</sup> Flapwise	5.06	4.78
1 <sup>st</sup> Chordwise	5.39	5.30
1 <sup>st</sup> Torsion	6.25	6.25

<sup>1</sup> $\Omega = 69.12 \text{ rad / sec}$

Table II. – Rotor hover Performance

POINT	Run 5		
	$\theta$	$C_L$	$C_Q$
88	0.0	0.00001	0.00009
89	2.0	0.00067	0.00011
90	4.0	0.00174	0.00016
90A	6.0	0.00300	0.00026
91	6.0	0.00293	0.00025
92	8.0	0.00420	0.00037
93	10.0	0.00557	0.00054
94	11.0	0.00622	0.00065
95	12.0	0.00686	0.00076
96	13.0	0.00730	0.00087
97	13.5	0.00750	0.00094
98	14.0	0.00771	0.00100
99	13.0	0.00728	0.00088
100	12.0	0.00692	0.00077
101	10.0	0.00556	0.00054
102	8.0	0.00434	0.00039
103	6.0	0.00301	0.00026
104	4.0	0.00176	0.00017
105	2.0	0.00069	0.00011
106	0.0	0.00001	0.00009

Table III. - Rotor Performance, Control Positions, Blade Loads, Fixed System Loads, and Pitch Link Loads for  $\mu_{Nom.} = 0.06, 0.07, 0.08, 0.09, 0.13, 0.16$  and  $0.20$

(a) Rotor performance and control positions

Run 7								
$\mu_{Nom} = 0.06$								
POINT	$\alpha_s$	$B_1$	$A_1$	$\theta$	$\mu$	$C_L$	$C_D$	$C_Q$
126	0.0	1.6	-0.4	4.1	0.058	0.00282	0.00005	0.00017
$\mu_{Nom} = 0.07$								
POINT	$\alpha_s$	$B_1$	$A_1$	$\theta$	$\mu$	$C_L$	$C_D$	$C_Q$
127	0.1	2.2	-0.5	6.0	0.073	0.00433	0.00008	0.00026
$\mu_{Nom} = 0.08$								
POINT	$\alpha_s$	$B_1$	$A_1$	$\theta$	$\mu$	$C_L$	$C_D$	$C_Q$
128	0.1	3.0	-0.4	8.0	0.077	0.00572	0.00009	0.00038
128A	0.1	3.7	-0.1	10.0	0.083	0.00697	0.00009	0.00056
$\mu_{Nom} = 0.09$								
POINT	$\alpha_s$	$B_1$	$A_1$	$\theta$	$\mu$	$C_L$	$C_D$	$C_Q$
129	0.1	4.2	0.2	11.0	0.085	0.00751	0.00006	0.00067
130	-2.0	1.8	-0.3	4.0	0.086	0.00306	-0.00006	0.00018
131	-2.0	2.4	-0.3	6.0	0.087	0.00450	-0.00009	0.00027
132	-2.0	3.0	-0.2	8.0	0.086	0.00581	-0.00012	0.00040
133	-2.0	3.6	0.2	10.0	0.088	0.00691	-0.00017	0.00057
134	-2.0	1.8	-0.3	4.0	0.086	0.00308	-0.00006	0.00018
135	-4.0	1.8	-0.1	4.0	0.086	0.00288	-0.00016	0.00018
136	-4.0	2.3	-0.1	6.0	0.087	0.00432	-0.00024	0.00027
137	-4.0	2.7	0.0	8.0	0.090	0.00570	-0.00031	0.00040
138	-4.0	3.5	0.5	10.0	0.090	0.00678	-0.00042	0.00058
139	-4.0	2.4	-0.1	6.0	0.090	0.00431	-0.00025	0.00027
140	-4.0	1.8	-0.1	4.0	0.086	0.00286	-0.00016	0.00018
141	0.0	1.9	-0.3	4.0	0.086	0.00329	0.00006	0.00018
142	0.0	2.5	-0.4	6.0	0.088	0.00469	0.00008	0.00027
143	0.0	3.1	-0.3	8.0	0.088	0.00599	0.00011	0.00040
144	0.0	3.8	0.1	10.0	0.088	0.00707	0.00008	0.00058
145	0.0	2.7	-0.4	6.0	0.088	0.00468	0.00007	0.00027
146	0.0	1.9	-0.3	4.0	0.086	0.00328	0.00005	0.00018
$\mu_{Nom} = 0.13$								
POINT	$\alpha_s$	$B_1$	$A_1$	$\theta$	$\mu$	$C_L$	$C_D$	$C_Q$
147	0.0	1.6	0.2	2.0	0.136	0.00215	0.00005	0.00013
148	0.0	2.2	0.4	4.0	0.135	0.00375	0.00006	0.00018
149	0.0	2.9	0.3	6.0	0.135	0.00527	0.00008	0.00027
150	0.0	3.7	0.4	8.0	0.133	0.00662	0.00008	0.00041



Table III. – continued.

(a) continued.

 $\mu_{\text{Nom}} = 0.13$ 

POINT	$\alpha_s$	$B_1$	$A_1$	$\theta$	$\mu$	$C_L$	$C_D$	$C_Q$
151	0.0	4.1	0.6	9.0	0.132	0.00717	0.00007	0.00050
152	0.0	3.1	0.3	6.0	0.134	0.00527	0.00006	0.00027
153	0.0	2.3	0.3	4.0	0.135	0.00376	0.00005	0.00019
154	-2.0	1.5	0.3	2.0	0.137	0.00180	-0.00002	0.00014
155	-2.0	2.0	0.4	4.0	0.137	0.00340	-0.00006	0.00019
156	-2.0	2.8	0.4	6.0	0.133	0.00490	-0.00010	0.00028
157	-2.0	3.7	0.5	8.0	0.133	0.00627	-0.00016	0.00041
158	-2.0	4.2	0.7	9.0	0.133	0.00684	-0.00019	0.00050
159	-2.0	3.0	0.3	6.0	0.134	0.00488	-0.00012	0.00028
160	-2.0	2.3	0.2	4.0	0.136	0.00356	-0.00008	0.00020
161	-4.0	1.5	0.2	2.0	0.137	0.00163	-0.00009	0.00014
162	-4.0	1.9	0.3	4.0	0.137	0.00321	-0.00019	0.00020
163	-4.0	2.7	0.3	6.0	0.134	0.00471	-0.00028	0.00029
164	-4.0	3.6	0.5	8.0	0.133	0.00610	-0.00039	0.00043
165	-4.0	4.0	0.7	9.0	0.134	0.00663	-0.00043	0.00052
166	-4.0	3.0	0.3	6.0	0.134	0.00470	-0.00030	0.00029
167	-4.0	2.3	0.3	4.0	0.136	0.00318	-0.00020	0.00020

 $\mu_{\text{Nom}} = 0.16$ 

POINT	$\alpha_s$	$B_1$	$A_1$	$\theta$	$\mu$	$C_L$	$C_D$	$C_Q$
168	-4.0	1.6	0.4	2.0	0.162	0.00151	-0.00008	0.00014
169	-4.0	2.1	0.7	4.0	0.163	0.00315	-0.00019	0.00020
170	-4.0	3.0	0.8	6.0	0.161	0.00470	-0.00030	0.00028
171	-4.0	4.0	1.0	8.0	0.162	0.00611	-0.00042	0.00043
172	-4.0	4.5	1.1	9.0	0.161	0.00664	-0.00047	0.00052
173	-4.0	3.4	0.7	6.0	0.161	0.00470	-0.00032	0.00029
174	-4.0	1.6	0.5	2.0	0.162	0.00151	-0.00010	0.00014
175	-2.0	1.6	0.5	2.0	0.163	0.00194	-0.00006	0.00014
176	-2.0	2.3	0.6	4.0	0.163	0.00359	-0.00010	0.00019
177	-2.0	3.2	0.7	6.0	0.162	0.00514	-0.00015	0.00028
178	-2.0	4.2	0.9	8.0	0.161	0.00647	-0.00022	0.00043
179	-2.0	4.8	1.1	9.0	0.161	0.00703	-0.00027	0.00052
180	-2.0	3.5	0.6	6.0	0.161	0.00510	-0.00017	0.00028
181	-2.0	1.6	0.4	2.0	0.163	0.00193	-0.00005	0.00014
182	0.0	1.6	0.5	2.0	0.163	0.00236	0.00003	0.00013
183	0.0	2.5	0.6	4.0	0.162	0.00398	0.00004	0.00018
184	0.0	3.3	0.7	6.0	0.160	0.00559	0.00004	0.00027
185	0.0	4.3	0.9	8.0	0.161	0.00686	0.00002	0.00042
186	0.1	4.8	1.2	9.0	0.161	0.00739	-0.00001	0.00051
187	0.0	3.6	0.6	6.0	0.160	0.00552	0.00002	0.00027
188	0.0	1.9	0.4	2.1	0.164	0.00237	0.00002	0.00013

Table III. - Continued

(a) Concluded

Run 7

 $\mu_{\text{Nom}} = 0.20$ 

POINT	$\alpha_s$	$B_1$	$A_1$	$\theta$	$\mu$	$C_L$	$C_D$	$C_Q$
189	0.0	2.0	0.6	2.0	0.201	0.00236	0.00004	0.00013
190	0.0	2.9	1.1	4.0	0.201	0.00403	0.00002	0.00018
191	0.0	3.9	1.3	6.0	0.200	0.00558	0.00002	0.00027
192	0.1	4.5	1.5	7.0	0.201	0.00624	0.00000	0.00035
193	0.1	5.0	1.6	8.0	0.200	0.00683	-0.00001	0.00043
194	0.1	5.3	1.8	8.5	0.200	0.00708	-0.00002	0.00047
195	0.0	4.2	1.2	6.0	0.200	0.00552	0.00000	0.00027
196	0.0	2.2	0.7	2.0	0.200	0.00233	0.00004	0.00013
197	-2.0	1.9	0.7	2.0	0.200	0.00179	-0.00002	0.00013
198	-2.0	2.6	1.1	4.0	0.202	0.00345	-0.00009	0.00019
199	-2.0	3.7	1.3	6.0	0.201	0.00503	-0.00014	0.00027
200	-2.0	4.8	1.7	8.0	0.201	0.00632	-0.00024	0.00042
201	-2.0	5.4	1.9	9.0	0.200	0.00683	-0.00028	0.00052
202	-2.0	3.9	1.2	6.0	0.201	0.00501	-0.00016	0.00028
203	-2.0	2.0	0.8	2.0	0.200	0.00173	-0.00002	0.00013
204	-4.0	1.7	0.8	2.1	0.200	0.00123	-0.00004	0.00013
205	-4.0	2.5	1.1	4.0	0.200	0.00285	-0.00016	0.00018
206	-4.0	3.5	1.4	6.0	0.201	0.00442	-0.00029	0.00027
207	-4.0	4.6	1.7	8.0	0.201	0.00580	-0.00041	0.00041
208	-4.0	5.2	1.9	9.0	0.199	0.00636	-0.00048	0.00050
209	-4.0	3.8	1.3	6.0	0.200	0.00439	-0.00031	0.00027
210	-4.0	2.7	1.1	4.0	0.201	0.00285	-0.00018	0.00019

Table III. - Continued

(b) Blade flapwise bending moment (in-lbs), 23.00 percent radius

Run 7

$\mu_{Nom} = 0.06$

POINT	MEAN	1/2 P-P	1P	2P	3P	4P	5P	6P	7P	8P	9P	10P	
126	49.00	11.80	1.97 275.84	1.67 114.91	4.91 282.13	1.45 236.68	3.79 354.73	1.57 265.45	0.33 271.38	2.14 336.77	0.43 291.22	0.11 113.94	Mag Phase

$\mu_{Nom} = 0.07$

POINT	MEAN	1/2 P-P	1P	2P	3P	4P	5P	6P	7P	8P	9P	10P	
127	52.22	18.40	2.49 277.99	2.81 119.15	7.13 290.50	2.91 233.12	5.91 353.96	2.53 270.01	0.37 240.81	3.03 325.70	0.48 281.08	0.13 136.00	Mag Phase

$\mu_{Nom} = 0.08$

POINT	MEAN	1/2 P-P	1P	2P	3P	4P	5P	6P	7P	8P	9P	10P	
128	55.50	21.27	2.85 283.28	2.94 104.10	8.71 286.57	4.25 224.96	6.51 340.79	2.84 258.07	0.36 182.46	2.63 303.21	0.43 267.56	0.06 129.45	Mag Phase
128A	58.17	21.48	3.27 303.41	3.23 97.64	10.49 276.96	5.35 214.93	3.19 347.56	2.80 244.53	1.14 175.68	4.22 308.66	0.59 246.15	0.14 120.91	Mag Phase

$\mu_{Nom} = 0.09$

POINT	MEAN	1/2 P-P	1P	2P	3P	4P	5P	6P	7P	8P	9P	10P	
129	59.27	22.52	3.56 313.25	2.60 93.84	11.07 273.32	5.78 215.02	1.38 6.03	2.62 240.31	1.28 154.07	5.99 303.33	0.71 248.44	0.14 113.78	Mag Phase
130	49.70	12.19	1.51 291.74	2.17 130.85	4.85 282.83	1.66 210.06	4.19 341.37	1.26 270.83	0.31 96.11	2.60 325.01	0.20 266.22	0.19 103.79	Mag Phase

Table III. - Continued

(b) Continued

Run 7

 $\mu_{\text{Nom}} = 0.09$ 

POINT	MEAN	1/2 P-P	1P	2P	3P	4P	5P	6P	7P	8P	9P	10P	
131	52.70	16.08	2.23 283.72	2.86 124.70	6.80 285.39	2.42 214.81	4.99 340.08	1.79 271.44	0.28 166.28	2.89 322.08	0.31 237.27	0.19 90.05	Mag Phase
132	55.86	18.80	2.53 288.32	3.49 110.87	8.39 279.13	3.01 210.21	5.79 332.68	1.99 257.25	0.50 125.73	2.70 291.48	0.21 197.35	0.16 25.67	Mag Phase
133	58.28	18.48	2.83 309.98	3.15 111.28	9.78 274.18	3.94 208.42	2.40 333.96	2.12 250.28	0.68 145.52	4.05 306.83	0.29 237.43	0.15 84.2	Mag Phase
134	49.75	12.31	1.55 291.14	2.11 131.88	4.86 284.21	1.72 211.16	4.20 343.80	1.28 272.35	0.29 104.67	2.62 328.11	0.20 266.11	0.19 107.29	Mag Phase
135	49.64	9.84	1.32 294.08	2.11 132.79	4.21 291.90	1.20 215.08	3.26 0.68	0.95 285.52	0.23 151.78	1.79 342.64	0.19 272.15	0.09 140.62	Mag Phase
136	52.75	12.40	1.83 281.62	2.85 124.19	5.83 286.03	1.79 210.48	3.65 346.68	1.20 263.50	0.39 214.49	1.57 309.05	0.33 254.15	0.01 271.72	Mag Phase
137	55.93	13.77	2.37 285.15	3.32 117.20	7.13 280.57	2.29 201.15	3.39 340.66	1.16 258.39	0.51 211.14	1.16 294.11	0.32 249.99	0.13 277.45	Mag Phase
138	58.19	13.20	2.32 313.25	2.99 122.39	8.08 275.80	2.92 196.12	1.99 288.05	1.01 255.14	0.51 234.16	1.25 315.88	0.31 265.95	0.14 283.25	Mag Phase
139	52.80	11.98	1.69 286.51	2.80 125.60	5.76 288.19	1.84 209.55	3.54 353.55	1.18 265.94	0.38 215.70	1.39 316.95	0.30 265.46	0.03 283.65	Mag Phase
140	49.67	9.87	1.23 296.55	2.13 133.62	4.24 292.08	1.22 215.88	3.25 1.45	0.94 284.61	0.29 153.24	1.79 345.55	0.18 280.01	0.08 145.75	Mag Phase

Table III. - Continued

(b) Continued

Run 7

$\mu_{Nom} = 0.09$

POINT	MEAN	1/2 P-P	1P	2P	3P	4P	5P	6P	7P	8P	9P	10P	
141	50.04	14.81	1.73 285.63	2.10 138.38	5.23 285.15	1.93 213.97	4.85 355.04	1.75 274.62	0.39 106.38	3.60 324.71	0.20 301.78	0.28 84.54	Mag Phase
142	53.03	20.34	2.36 236.86	3.04 126.13	7.90 285.79	3.14 221.83	6.63 347.05	2.53 267.22	0.28 151.51	4.10 321.72	0.21 267.55	0.36 101.13	Mag Phase
143	56.08	23.92	2.98 289.78	3.41 110.61	10.01 283.48	4.34 221.99	7.18 338.54	2.86 256.61	0.43 119.43	3.58 298.77	0.12 3.96	0.24 56.91	Mag Phase
144	58.53	22.99	3.23 307.63	2.90 101.79	11.13 275.98	5.36 214.93	2.92 343.89	2.75 248.56	0.96 163.76	5.56 306.63	0.68 253.40	0.22 80.63	Mag Phase
145	52.92	20.26	2.25 288.10	2.96 124.14	7.73 281.75	3.29 214.00	6.50 338.15	2.51 258.87	0.23 147.66	4.24 307.98	0.24 259.84	0.35 83.90	Mag Phase
146	50.00	14.76	1.64 289.13	2.19 139.96	5.26 286.19	1.98 215.29	4.79 355.59	1.68 278.01	0.40 105.31	3.64 325.52	0.21 295.14	0.30 91.1	Mag Phase

$\mu_{Nom.} = 0.13$

POINT	MEAN	1/2 P-P	1P	2P	3P	4P	5P	6P	7P	8P	9P	10P	
147	48.14	6.00	0.20 19.83	1.62 164.29	2.43 304.28	1.04 195.23	1.73 23.45	0.58 290.41	0.21 193.00	1.11 4.67	0.10 311.49	0.07 88.80	Mag Phase
148	51.36	12.28	0.63 283.90	2.77 160.64	4.29 296.54	2.24 200.44	3.89 9.92	1.44 267.97	0.74 194.81	2.14 338.13	0.30 258.45	0.24 111.47	Mag Phase

Table III. - Continued

Run 7													
(b) Continued													
$\mu_{\text{Nom.}} = 0.13$													
POINT	MEAN	1/2 P-P	1P	2P	3P	4P	5P	6P	7P	8P	9P	10P	
149	54.55	19.50	1.40 286.54	3.79 151.76	6.48 293.75	4.08 204.03	6.28 9.90	2.42 263.68	1.22 199.02	2.90 322.55	0.47 233.16	0.50 91.87	Mag Phase
150	57.51	24.41	2.11 297.60	3.73 130.74	8.70 282.11	6.34 200.67	6.61 358.19	2.42 252.15	0.92 179.06	4.63 312.83	0.62 234.35	0.63 86.73	Mag Phase
151	58.65	24.57	2.42 311.00	3.47 119.44	9.52 278.10	6.93 203.89	6.17 348.62	2.28 250.50	0.81 161.98	5.10 304.68	0.91 230.55	0.47 80.69	Mag Phase
152	54.62	19.80	1.30 295.59	3.73 152.39	6.58 295.81	4.28 206.63	6.36 11.84	2.40 267.91	1.11 198.74	3.07 324.49	0.42 236.81	0.55 95.64	Mag Phase
153	51.39	12.52	0.64 302.01	2.86 159.56	4.37 296.44	2.25 200.51	3.89 12.97	1.44 271.76	0.73 195.85	2.26 337.31	0.35 261.53	0.25 106.79	Mag Phase
154	47.94	5.46	0.35 30.93	1.73 157.02	2.31 297.97	0.89 194.59	1.43 27.96	0.52 297.26	0.11 148.10	1.15 339.10	0.07 39.93	0.18 58.23	Mag Phase
155	51.10	12.73	0.71 285.23	2.86 153.38	4.31 294.39	2.30 200.76	3.69 15.60	1.21 277.63	0.56 157.86	2.70 334.45	0.09 287.58	0.32 75.46	Mag Phase
156	54.31	18.49	1.28 287.90	3.73 142.00	6.45 288.42	3.93 197.11	5.54 354.65	1.81 257.94	0.64 125.79	3.37 307.84	0.02 239.92	0.45 56.01	Mag Phase
157	57.38	20.67	1.93 306.38	3.98 129.65	8.67 283.38	5.46 204.62	5.23 345.14	1.72 250.03	0.83 108.05	3.65 316.47	0.21 355.38	0.56 46.52	Mag Phase
158	58.56	19.52	2.35 317.73	3.52 118.69	9.55 275.53	6.21 205.36	4.60 322.09	1.64 239.48	1.00 99.09	3.30 318.47	0.35 330.88	0.62 19.95	Mag Phase
159	54.28	18.25	1.17 298.28	3.68 145.48	6.47 291.83	3.77 201.91	5.56 359.94	1.78 264.17	0.62 124.19	3.36 317.27	0.01 177.10	0.43 65.81	Mag Phase

Table III. - Continued

(b) Continued.

Run 7

$\mu_{\text{Nom}} = 0.13$

POINT	MEAN	1/2 P-P	1P	2P	3P	4P	5P	6P	7P	8P	9P	10P	
160	51.44	13.47	0.67 299.59	3.03 150.28	4.58 290.92	2.44 197.10	3.97 8.32	1.32 269.40	0.51 146.35	2.82 319.99	0.11 225.87	0.34 67.45	Mag Phase
161	47.94	5.59	0.58 29.22	1.78 149.18	2.30 300.90	0.83 190.89	1.41 6.70	0.35 288.89	0.26 91.25	1.08 334.98	0.07 106.13	0.10 61.70	Mag Phase
162	51.15	11.84	0.71 289.11	2.94 144.40	4.37 293.99	1.83 192.02	3.65 357.13	0.92 267.94	0.60 99.06	2.19 320.52	0.12 110.78	0.20 78.48	Mag Phase
163	54.38	16.33	1.26 290.15	3.82 135.31	6.41 286.00	3.02 188.36	5.10 339.65	1.34 248.50	0.68 71.77	2.52 287.69	0.19 52.37	0.23 38.48	Mag Phase
164	57.47	18.13	1.82 307.26	4.14 120.42	8.29 276.99	4.22 191.94	5.05 323.63	1.46 224.94	0.89 60.23	2.03 278.96	0.32 9.99	0.25 8.42	Mag Phase
165	58.57	17.76	2.16 322.20	3.70 115.86	9.09 276.07	4.63 201.32	4.35 309.85	1.62 219.28	1.10 58.70	1.96 294.19	0.31 329.56	0.26 350.13	Mag Phase
166	54.45	15.76	1.08 303.70	3.80 141.06	6.40 294.41	2.92 200.45	4.96 354.40	1.27 266.18	0.72 87.47	2.20 309.13	0.18 71.27	0.19 63.17	Mag Phase
167	51.11	11.28	0.50 324.66	2.97 145.80	4.42 295.19	1.72 190.46	3.46 356.23	0.80 269.29	0.62 97.78	2.04 322.49	0.12 104.49	0.17 73.46	Mag Phase

Table III. - Continued

(b) Continued.

Run 7

 $\mu_{\text{Nom}} = 0.16$ 

POINT	MEAN	1/2 P-P	1P	2P	3P	4P	5P	6P	7P	8P	9P	10P	
168	48.06	5.06	0.85 38.45	1.72 154.43	2.14 309.93	0.66 188.35	0.96 34.30	0.38 306.93	0.00 298.05	0.92 344.05	0.08 201.45	0.09 116.66	Mag Phase
169	51.36	10.67	0.43 338.02	3.07 150.26	4.12 301.96	1.80 197.03	3.06 1.29	0.93 274.33	0.31 98.41	2.27 312.25	0.18 182.04	0.22 93.97	Mag Phase
170	54.68	16.74	0.83 322.44	4.42 142.88	6.23 294.60	3.22 191.85	4.67 347.81	1.37 259.46	0.84 77.49	3.43 295.02	0.12 128.56	0.38 53.61	Mag Phase
171	57.82	20.74	1.45 333.77	4.45 125.42	7.85 284.46	4.63 197.48	5.41 335.25	1.45 245.12	1.45 61.43	4.66 292.24	0.11 42.80	0.44 35.90	Mag Phase
172	59.01	21.06	1.95 339.05	4.17 114.20	8.57 278.76	4.87 201.97	5.61 314.10	1.59 227.52	2.02 67.81	4.91 298.23	0.24 317.90	0.55 17.66	Mag Phase
173	54.73	15.93	0.88 348.54	4.41 143.87	6.19 295.85	3.07 194.34	4.45 349.18	1.27 257.91	0.86 77.71	3.03 295.19	0.27 132.07	0.38 62.79	Mag Phase
174	48.17	4.99	0.86 48.58	1.71 156.07	2.09 312.44	0.69 194.46	1.06 31.03	0.39 310.46	0.04 222.13	0.84 349.23	0.07 192.90	0.08 107.81	Mag Phase
175	48.65	5.16	0.55 56.04	1.73 163.03	2.44 310.08	0.76 189.77	1.08 25.54	0.49 306.64	0.18 307.52	0.86 335.26	0.11 250.44	0.04 68.46	Mag Phase
176	51.92	11.23	0.35 322.65	3.16 157.63	4.39 303.84	2.05 199.06	3.18 18.08	1.02 289.32	0.09 349.18	2.65 313.71	0.38 251.78	0.21 105.56	Mag Phase
177	55.19	18.12	0.92 312.01	4.37 148.45	6.49 300.18	3.73 204.69	5.28 7.27	1.40 277.25	0.59 62.97	4.09 319.21	0.34 285.53	0.43 75.62	Mag Phase



Table III. - Continued

(b) Continued.

$\mu_{\text{Nom}} = 0.16$

Run 7	POINT	MEAN	1/2 P-P	1P	2P	3P	4P	5P	6P	7P	8P	9P	10P	
	178	58.16	22.15	1.64 325.25	4.27 122.79	8.19 284.81	5.48 205.49	5.28 352.36	1.21 268.66	1.55 45.05	6.03 310.36	0.54 291.84	0.62 52.54	Mag Phase
	179	59.20	21.47	2.07 334.95	4.00 110.53	8.44 271.15	5.58 194.82	4.99 316.74	1.25 235.09	1.61 34.68	6.24 288.64	0.58 268.37	0.71 18.40	Mag Phase
	180	55.29	18.20	0.77 327.91	4.28 144.83	6.46 294.31	3.66 194.31	5.49 357.17	1.40 268.44	0.74 46.97	4.04 298.32	0.26 244.25	0.49 53.82	Mag Phase
	181	48.65	5.19	0.57 48.27	1.79 159.02	2.38 306.88	0.77 185.87	1.12 21.59	0.49 294.11	0.19 288.51	0.87 326.14	0.14 242.53	0.02 95.91	Mag Phase
	182	49.05	5.78	0.21 89.31	1.69 163.06	2.71 310.99	0.87 188.51	1.81 21.40	0.67 305.01	0.30 260.60	0.80 343.28	0.17 257.32	0.03 210.20	Mag Phase
	183	52.36	11.15	0.19 327.7	2.86 165.58	4.44 308.69	1.91 199.27	3.67 21.76	1.19 291.18	0.40 232.27	1.96 324.51	0.44 272.71	0.07 17.7	Mag Phase
	184	55.79	17.87	0.76 306.79	3.78 151.39	6.39 297.43	3.70 197.75	6.25 10.55	1.62 270.67	0.20 174.48	2.75 301.85	0.42 283.81	0.49 32.42	Mag Phase
	185	58.65	22.60	1.57 325.73	3.79 121.48	8.22 285.46	5.99 207.45	6.15 12.07	1.18 272.21	0.59 74.22	4.92 328.4	0.76 305.24	0.67 49.84	Mag Phase
	186	59.51	21.86	2.00 331.31	3.80 110.98	8.34 273.81	5.91 195.05	5.67 343.89	1.22 245.83	0.61 61.14	5.13 310.07	0.71 290.74	0.82 29.38	Mag Phase
	187	55.81	17.79	0.79 334.87	3.86 152.05	6.52 299.82	3.75 200.43	6.14 12.72	1.58 271.93	0.28 153.5	2.61 306.98	0.35 292.14	0.49 46.73	Mag Phase
	188	49.09	6.09	0.50 65.82	1.78 166.30	2.73 317.14	0.97 202.66	1.99 31.83	0.71 318.84	0.34 272.82	0.95 4.82	0.18 286.73	0.01 298.00	Mag Phase

Table III. - Continued

(b) Continued.

Run 7

$\mu_{Nom} = 0.20$

POINT	MEAN	1/2 P-P	1P	2P	3P	4P	5P	6P	7P	8P	9P	10P	
189	49.34	5.35	0.86 61.90	1.52 173.91	2.96 320.37	0.74 209.99	1.44 28.04	0.59 326.59	0.21 331.21	0.93 33.53	0.30 350.18	0.12 320.12	Mag Phase
190	52.74	8.96	0.72 74.73	2.68 170.87	4.75 317.74	1.65 201.29	2.58 5.66	0.76 326.98	0.46 358.37	0.96 30.57	0.35 356.79	0.12 246.67	Mag Phase
191	56.31	13.80	0.83 20.17	3.59 153.40	6.49 306.40	2.99 203.80	4.00 12.74	0.84 326.06	0.99 34.76	2.71 351.89	0.53 332.85	0.20 176.52	Mag Phase
192	58.00	16.61	1.40 15.84	3.56 129.35	7.09 295.16	4.00 205.84	4.80 13.94	1.01 342.32	1.40 26.00	4.02 339.60	0.71 324.31	0.24 151.67	Mag Phase
193	59.24	18.71	1.86 4.57	3.97 108.57	7.65 284.56	4.53 207.97	5.09 356.41	0.85 332.20	1.80 31.50	5.51 335.38	0.73 324.16	0.40 103.89	Mag Phase
194	59.66	17.74	2.06 1.94	3.91 101.91	7.66 278.88	4.42 200.21	5.41 330.99	0.76 321.25	1.92 35.49	4.90 339.06	0.57 355.50	0.58 96.80	Mag Phase
195	56.31	15.06	1.14 34.30	3.61 153.95	6.39 309.07	3.09 204.10	4.36 20.49	0.87 328.18	0.81 60.02	3.46 3.81	0.49 327.80	0.32 160.54	Mag Phase
196	49.34	5.15	1.10 69.28	1.50 172.61	2.88 323.35	0.64 204.87	1.26 26.22	0.57 329.17	0.25 318.76	1.09 57.39	0.30 8.80	0.12 331.05	Mag Phase
197	48.82	4.84	1.14 52.07	1.35 170.36	2.33 318.35	0.60 177.30	0.71 46.97	0.42 346.73	0.21 258.72	1.49 61.76	0.21 15.51	0.05 195.50	Mag Phase
198	52.12	9.56	0.81 42.09	2.67 162.22	4.27 310.85	1.55 189.64	2.49 8.10	0.82 305.09	0.06 197.67	2.27 11.97	0.20 330.61	0.20 138.53	Mag Phase

Table III. - Continued

(b) Continued.

$\mu_{\text{Nom}} = 0.20$

Run 7	POINT	MEAN	1/2 P-P	1P	2P	3P	4P	5P	6P	7P	8P	9P	10P	
	199	55.60	15.86	0.92 10.53	3.96 155.45	6.31 310.63	2.93 204.99	4.41 13.91	1.14 302.96	0.63 90.80	3.98 8.88	0.47 338.66	0.36 134.61	Mag Phase
	200	58.79	19.64	1.72 1.95	4.23 116.86	7.33 286.61	4.63 200.10	5.35 338.56	0.95 285.07	1.50 53.81	6.04 340.24	0.75 331.89	0.41 94.48	Mag Phase
	201	59.70	18.84	2.28 0.08	4.00 104.61	7.31 275.35	4.51 188.71	6.73 307.34	1.08 263.05	1.69 46.02	6.20 332.16	0.70 343.85	0.53 91.40	Mag Phase
	202	55.60	15.77	1.21 19.82	3.94 150.37	6.29 307.29	3.01 199.17	4.61 5.97	1.16 295.20	0.53 81.44	3.68 0.00	0.41 326.44	0.34 128.04	Mag Phase
	203	48.61	4.77	1.23 51.99	1.29 171.08	3.24 320.41	0.50 180.40	0.75 49.17	0.41 351.45	0.21 270.05	1.46 62.38	0.16 12.04	0.06 213.44	Mag Phase
	204	48.07	4.17	1.24 38.59	1.27 160.64	1.89 315.96	0.40 145.36	0.43 86.85	0.33 359.35	0.23 257.94	1.14 47.54	0.13 354.53	0.02 45.08	Mag Phase
	205	51.46	8.56	1.02 28.88	2.58 156.98	3.69 311.96	1.12 184.71	1.47 11.86	0.55 302.07	0.25 169.98	1.77 355.07	0.12 271.44	0.16 118.92	Mag Phase
	206	54.92	12.94	0.95 11.49	3.66 152.39	5.51 308.35	2.46 201.71	3.11 10.29	0.83 292.79	0.50 105.26	2.73 345.87	0.06 320.83	0.28 103.82	Mag Phase
	207	58.34	17.55	1.68 0.36	3.88 122.32	6.64 286.01	4.26 194.75	4.60 350.19	0.82 273.10	0.69 69.53	4.14 326.91	0.14 313.42	0.37 69.32	Mag Phase
	208	59.50	16.76	2.26 0.54	3.87 108.16	7.14 279.50	3.98 197.03	4.65 310.38	0.95 230.73	1.24 87.62	4.87 328.43	0.27 331.08	0.36 55.60	Mag Phase
	209	54.87	12.77	1.26 23.42	3.72 147.80	5.41 306.12	2.42 197.08	3.00 1.27	0.83 293.65	0.36 93.53	2.36 332.20	0.03 31.03	0.22 82.32	Mag Phase

Table III. - Continued

(b) Concluded.

$$\mu_{\text{Nom}} = 0.20$$

Run 7

POINT	MEAN	1/2 P-P	1P	2P	3P	4P	5P	6P	7P	8P	9P	10P	
210	51.42	8.33	1.19 40.12	2.65 157.65	3.74 316.22	1.04 192.63	1.27 16.94	0.54 308.88	0.14 169.47	1.62 5.69	0.10 323.17	0.12 114.56	Mag Phase

Table III. - Continued

(c) Blade chordwise bending moment, in-lbs., 30.00 percent radius

Run 7

$\mu_{Nom} = 0.06$

POINT	MEAN	1/2P-P	1P	2P	3P	4P	5P	6P	7P	8P	9P	10P	
126	-24.43	9.57	0.97 298.91	0.80 60.23	2.52 146.54	1.53 288.05	4.51 298.31	2.70 327.46	0.24 166.90	0.19 196.29	0.22 127.87	0.04 225.79	Mag Phase

$\mu_{Nom} = 0.07$

POINT	MEAN	1/2P-P	1P	2P	3P	4P	5P	6P	7P	8P	9P	10P	
127	-22.39	13.37	5.10 326.86	2.98 47.41	4.88 148.16	0.95 300.17	1.63 27.07	4.50 24.68	0.11 170.18	0.60 196.55	0.21 130.27	0.11 133.32	Mag Phase

$\mu_{Nom} = 0.08$

POINT	MEAN	1/2P-P	1P	2P	3P	4P	5P	6P	7P	8P	9P	10P	
128	-18.25	28.19	14.65 342.30	4.64 31.98	9.58 151.77	2.58 233.06	0.71 333.24	3.94 346.29	0.07 202.15	0.91 204.14	0.20 97.74	0.06 146.11	Mag Phase
128A	-10.99	51.33	30.00 358.04	9.91 19.87	16.30 160.37	1.40 176.97	2.43 274.26	3.86 344.60	2.39 242.34	0.56 253.17	0.63 358.61	0.38 57.95	Mag Phase

$\mu_{Nom} = 0.09$

POINT	MEAN	1/2P-P	1P	2P	3P	4P	5P	6P	7P	8P	9P	10P	
129	-6.56	66.07	36.75 4.46	10.77 23.24	17.43 154.93	2.69 156.88	7.27 294.73	7.76 323.66	1.54 202.73	0.47 305.3	0.47 350.57	0.34 335.68	Mag Phase
130	-25.19	7.78	1.83 311.22	1.82 80.99	2.75 165.28	1.66 294.27	1.58 339.51	2.31 356.99	0.20 34.10	0.33 176.03	0.11 115.59	0.00 8.85	Mag Phase

Table III. - Continued

(c) Continued.

Run 7

 $\mu_{\text{Nom}} = 0.09$ 

POINT	MEAN	1/2P-P	1P	2P	3P	4P	5P	6P	7P	8P	9P	10P	
131	-22.53	12.84	5.61 326.59	3.29 59.82	5.01 149.57	1.56 290.52	1.47 70.29	3.32 36.83	0.26 157.08	0.07 45.11	0.08 103.1	0.14 154.94	Mag Phase
132	-18.19	30.24	15.43 343.22	4.36 18.88	11.48 149.48	2.31 249.66	2.69 250.33	4.42 342.58	0.28 299.39	0.68 143.23	0.05 173.87	0.09 149.65	Mag Phase
133	-11.00	47.49	27.27 359.68	9.80 23.63	14.79 159.80	0.28 173.81	3.89 291.96	3.33 22.76	1.34 186.13	0.35 237.04	0.41 259.66	0.34 24.53	Mag Phase
134	-25.62	7.53	1.65 305.94	1.90 80.53	2.75 166.94	1.61 300.32	2.03 339.07	1.91 356.10	0.06 102.28	0.40 184.52	0.13 136.53	0.05 156.21	Mag Phase
135	-25.81	6.03	1.75 320.57	1.49 74.45	2.15 172.15	1.47 315.71	2.31 357.47	1.08 10.90	0.10 50.79	0.28 116.11	0.09 137.08	0.07 196.41	Mag Phase
136	-22.93	11.10	5.04 325.40	2.73 61.17	3.92 149.61	1.37 287.68	0.70 33.39	2.43 85.78	0.14 13.22	0.55 153.06	0.21 90.72	0.10 138.24	Mag Phase
137	-18.60	29.44	14.93 344.84	3.85 21.17	10.45 151.98	1.98 254.38	3.95 282.60	3.46 345.40	0.49 287.10	0.46 88.62	0.05 6.43	0.05 170.01	Mag Phase
138	-11.43	43.27	24.28 358.95	8.60 25.99	12.97 163.89	0.53 36.57	4.97 331.15	3.66 106.31	1.72 217.16	0.41 98.69	0.82 267.00	0.45 26.13	Mag Phase
139	-23.05	11.43	5.51 328.23	3.05 56.57	4.28 152.55	1.17 277.31	0.74 29.00	2.63 86.82	0.03 32.86	0.23 105.34	0.18 94.11	0.10 165.45	Mag Phase
140	-25.66	6.58	1.74 317.53	1.76 79.17	2.34 173.65	1.39 318.33	2.15 358.21	0.87 2.81	0.08 69.95	0.40 191.55	0.09 144.90	0.04 178.80	Mag Phase

Table III. - Continued

(c) Continued.

Run 7

 $\mu_{\text{Nom}} = 0.09$ 

POINT	MEAN	1/2P-P	1P	2P	3P	4P	5P	6P	7P	8P	9P	10P	
141	-25.99	9.43	1.58 304.85	2.04 88.39	2.88 170.29	2.37 297.72	2.96 336.12	1.99 352.68	0.11 77.01	0.59 135.17	0.20 139.00	0.11 192.12	Mag Phase
142	-23.14	16.81	6.26 324.72	3.99 68.02	6.12 147.05	2.40 286.58	0.86 216.37	4.26 30.14	0.18 125.92	0.44 138.74	0.25 120.43	0.19 140.45	Mag Phase
143	-18.61	36.60	17.81 347.38	5.30 27.76	13.71 155.73	3.50 254.50	2.22 261.64	6.23 345.47	0.58 251.70	0.67 172.36	0.06 140.67	0.04 67.78	Mag Phase
144	-11.24	55.88	30.50 0.28	10.71 25.16	17.17 159.05	0.56 155.45	4.90 300.39	6.22 353.20	2.28 228.24	0.32 348.10	0.34 359.84	0.29 33.62	Mag Phase
145	-23.19	16.73	6.17 322.14	4.23 61.18	5.90 141.70	2.02 273.31	1.23 123.53	4.90 22.50	0.15 144.19	0.67 145.41	0.28 99.39	0.19 113.95	Mag Phase
146	-26.20	8.40	1.62 305.24	2.21 90.17	2.85 168.53	2.21 302.38	2.14 1.60	2.43 358.43	0.12 58.33	0.45 168.93	0.19 140.74	0.06 174.26	Mag Phase

 $\mu_{\text{Nom}} = 0.13$ 

POINT	MEAN	1/2P-P	1P	2P	3P	4P	5P	6P	7P	8P	9P	10P	
147	-28.01	4.28	2.10 279.43	1.31 116.15	1.34 175.48	1.26 347.47	1.79 339.09	0.61 23.62	0.20 13.32	0.17 96.19	0.07 155.24	0.01 268.67	Mag Phase
148	-26.45	10.07	2.95 303.61	2.98 86.40	2.79 184.14	2.46 321.72	4.12 351.89	1.33 67.58	0.72 61.32	0.56 143.23	0.19 116.86	0.02 158.11	Mag Phase
149	-23.37	20.84	11.29 328.17	5.74 72.69	6.24 145.28	2.57 291.72	2.59 315.95	2.18 132.40	0.69 102.83	0.48 96.16	0.27 109.32	0.19 217.03	Mag Phase

Table III. - Continued

(c) Continued.

Run 7

 $\mu_{\text{Nom}} = 0.13$ 

POINT	MEAN	1/2P-P	1P	2P	3P	4P	5P	6P	7P	8P	9P	10P	
150	-18.05	40.77	25.27 349.55	9.40 36.77	11.70 157.48	2.12 264.29	4.05 357.22	5.21 86.45	0.56 305.76	0.67 184.56	0.36 65.68	0.20 208.26	Mag Phase
151	-14.11	48.28	32.25 358.06	12.45 36.38	12.59 162.18	0.60 70.67	2.71 336.41	0.88 3.17	1.59 298.08	1.41 104.83	0.51 91.83	0.46 181.61	Mag Phase
152	-23.28	20.16	11.06 328.44	5.90 72.43	6.38 151.23	2.12 278.65	1.71 303.88	2.69 130.48	0.44 93.70	0.83 144.17	0.31 123.61	0.22 216.12	Mag Phase
153	-26.66	10.27	3.14 305.59	3.17 81.76	2.89 177.41	2.17 324.85	3.86 359.25	2.00 67.18	0.57 97.06	0.12 70.65	0.13 132.93	0.07 185.36	Mag Phase
154	-28.25	5.16	1.96 289.98	1.08 83.31	1.13 174.19	0.48 358.42	2.15 321.65	0.57 105.19	0.22 3.83	0.22 172.79	0.05 162.57	0.03 262.78	Mag Phase
155	-26.51	9.97	2.92 307.78	3.01 82.25	2.71 184.83	2.41 325.26	4.06 353.31	1.40 76.11	0.45 65.55	0.56 144.06	0.11 145.78	0.07 210.51	Mag Phase
156	-23.68	21.49	10.97 329.74	4.66 66.15	6.50 146.64	2.15 274.20	2.35 301.50	3.58 122.91	0.89 50.35	0.42 104.32	0.22 99.78	0.11 190.59	Mag Phase
157	-18.65	40.59	23.79 349.39	8.60 35.32	11.70 160.49	1.75 268.22	6.12 2.71	5.23 91.16	0.73 18.91	0.82 198.62	0.29 76.04	0.22 220.53	Mag Phase
158	-14.76	47.84	30.70 357.12	11.23 34.52	12.62 160.92	1.17 67.20	5.45 357.47	1.21 102.81	1.32 10.63	1.07 131.32	0.44 93.47	0.36 193.51	Mag Phase
159	-23.73	18.48	9.80 327.62	4.96 70.76	5.88 150.63	1.59 281.45	1.52 312.17	2.06 103.50	0.81 62.03	0.24 200.43	0.20 121.83	0.13 215.80	Mag Phase



Table III. - Continued

(c) Continued.

Run 7

 $\mu_{\text{Nom}} = 0.13$ 

POINT	MEAN	1/2P-P	1P	2P	3P	4P	5P	6P	7P	8P	9P	10P	
160	-26.68	10.27	3.31 306.69	3.25 77.47	2.93 175.24	2.16 319.84	3.46 349.19	1.92 54.37	0.48 59.11	0.30 173.16	0.07 102.66	0.02 99.54	Mag Phase
161	-28.36	4.46	1.97 297.82	1.25 63.05	0.99 172.66	0.21 71.09	1.85 351.18	0.66 201.30	0.13 27.56	0.42 141.96	0.05 157.06	0.04 195.18	Mag Phase
162	-26.59	8.95	3.15 312.32	2.48 75.35	2.62 180.13	2.05 323.06	3.57 348.22	0.85 70.31	0.29 59.64	0.13 30.22	0.05 137.55	0.04 172.57	Mag Phase
163	-23.93	21.50	10.53 331.22	4.26 58.16	6.61 148.12	2.00 268.09	3.30 290.21	2.38 113.58	0.92 50.96	0.19 55.38	0.17 88.70	0.07 132.02	Mag Phase
164	-18.67	40.15	22.91 347.50	8.44 24.55	11.79 157.82	1.90 262.37	5.84 325.03	4.50 66.99	0.80 14.05	0.28 216.86	0.32 27.62	0.08 156.16	Mag Phase
165	-14.60	47.81	29.65 357.96	11.10 28.69	12.84 163.28	0.84 22.21	6.13 334.17	0.40 41.06	1.25 10.23	0.25 313.70	0.62 56.55	0.35 165.44	Mag Phase
166	-23.72	20.02	10.20 330.83	4.44 63.18	6.32 156.84	1.63 277.07	2.42 311.72	2.88 107.15	0.70 69.90	0.36 121.89	0.15 116.45	0.07 155.31	Mag Phase
167	-26.92	9.12	3.13 311.63	2.48 72.63	2.75 179.34	1.86 324.36	3.34 349.38	1.24 64.63	0.40 84.03	0.55 164.33	0.09 164.82	0.05 136.51	Mag Phase

Table III. - Continued

(c) Continued

Run 7

 $\mu_{\text{Nom}} = 0.16$ 

POINT	MEAN	1/2P-P	1P	2P	3P	4P	5P	6P	7P	8P	9P	10P	
168	-28.65	4.94	1.91 289.54	1.23 59.39	0.92 181.56	0.51 93.18	2.44 348.12	0.79 177.45	0.18 16.47	0.10 46.82	0.03 137.22	0.02 262.61	Mag Phase
169	-27.11	9.81	3.47 310.91	2.54 70.40	2.38 185.40	1.83 329.69	3.91 0.41	1.25 118.11	0.32 61.62	0.26 218.46	0.03 159.74	0.04 172.32	Mag Phase
170	-24.44	25.39	13.03 332.37	4.10 60.91	7.51 149.89	2.14 270.34	3.62 300.21	3.64 133.93	0.58 75.66	0.34 25.94	0.11 118.17	0.05 209.00	Mag Phase
171	-19.12	40.22	26.37 349.16	10.61 26.45	10.96 162.97	2.34 234.60	4.11 2.27	5.37 116.53	1.10 7.22	0.30 33.66	0.26 64.08	0.11 152.41	Mag Phase
172	-15.15	49.71	33.50 358.89	12.97 28.19	11.65 165.02	0.66 142.34	3.82 345.48	1.05 205.87	0.86 62.99	0.45 110.53	0.39 93.73	0.29 199.36	Mag Phase
173	-24.40	22.41	11.86 331.95	4.22 59.07	7.05 151.98	1.53 266.42	2.68 325.40	3.42 122.26	0.55 95.48	0.53 60.07	0.07 116.07	0.03 318.90	Mag Phase
174	-28.90	4.62	1.92 288.18	1.45 56.05	0.91 176.32	0.59 138.10	2.10 355.85	0.61 201.88	0.20 19.14	0.16 103.76	0.06 112.67	0.01 55.89	Mag Phase
175	-28.95	6.12	2.15 288.12	1.43 70.93	1.28 188.84	0.39 31.00	3.18 355.38	0.59 166.73	0.12 8.59	0.02 161.21	0.07 170.79	0.03 186.35	Mag Phase
176	-27.41	12.54	4.47 312.51	3.48 74.10	2.59 182.53	2.21 333.54	4.06 20.08	2.46 130.01	0.43 82.07	0.53 143.48	0.10 141.70	0.06 198.01	Mag Phase
177	-24.37	27.79	14.22 336.70	4.85 68.52	8.33 155.77	3.10 275.82	3.45 318.52	4.28 155.21	0.71 94.77	0.20 136.61	0.19 115.83	0.10 235.26	Mag Phase

Table III. - Continued

Run 7													
(c) Continued													
$\mu_{\text{Nom}} = 0.16$													
POINT	MEAN	1/2P-P	1P	2P	3P	4P	5P	6P	7P	8P	9P	10P	
178	-18.10	42.88	29.35 354.09	11.86 33.22	10.97 166.36	1.24 238.51	3.06 14.34	6.39 144.77	0.83 347.08	0.22 81.64	0.39 92.16	0.33 186.40	Mag Phase
179	-13.88	52.44	36.10 359.56	13.46 28.12	10.66 157.29	1.43 100.46	4.22 330.13	0.63 225.78	0.74 0.59	1.42 92.65	0.44 65.49	0.55 194.22	Mag Phase
180	-24.11	23.38	13.34 330.20	5.63 56.24	6.69 152.45	2.26 255.76	3.32 332.86	2.65 132.13	0.65 87.78	0.23 157.80	0.15 109.32	0.13 231.16	Mag Phase
181	-29.12	5.86	2.16 285.73	1.44 75.31	1.21 187.62	0.60 27.73	2.76 354.61	0.81 165.33	0.16 337.48	0.08 311.25	0.05 171.41	0.04 191.45	Mag Phase
182	-29.24	6.03	2.36 280.58	1.33 84.53	1.68 181.87	1.09 347.10	2.74 341.70	0.77 104.46	0.15 4.67	0.18 38.12	0.10 113.04	0.05 82.25	Mag Phase
183	-27.54	12.91	5.22 309.80	3.68 81.92	2.75 183.02	2.24 324.67	3.40 30.95	2.97 119.25	0.57 90.06	0.42 77.07	0.24 106.23	0.10 134.45	Mag Phase
184	-24.19	27.27	15.68 335.70	6.21 60.44	7.46 154.31	3.15 257.96	4.07 333.37	3.02 126.31	0.54 85.84	0.55 90.76	0.28 94.44	0.13 230.28	Mag Phase
185	-17.54	43.46	30.81 355.90	12.03 38.12	10.85 167.47	1.22 201.66	1.92 352.51	6.49 153.62	0.58 332.62	0.53 89.26	0.61 116.60	0.38 203.58	Mag Phase
186	-13.64	53.23	37.09 1.85	13.66 32.67	10.54 160.93	2.00 105.24	4.32 311.68	0.29 273.85	0.86 329.20	1.17 107.66	0.52 92.30	0.61 217.54	Mag Phase
187	-23.92	24.21	14.27 332.77	6.45 65.17	7.03 156.18	2.64 253.12	3.02 343.52	2.67 125.97	0.69 93.73	0.51 125.12	0.23 109.29	0.13 233.40	Mag Phase
188	-29.23	5.79	2.30 281.19	1.35 78.46	1.46 193.77	0.82 358.46	2.71 351.20	0.84 153.17	0.25 57.01	0.40 118.29	0.16 149.24	0.05 143.19	Mag Phase

Table III. - Continued

(c) Continued

Run 7

 $\mu_{\text{Nom}} = 0.20$ 

POINT	MEAN	1/2P-P	1P	2P	3P	4P	5P	6P	7P	8P	9P	10P	
189	-29.75	6.41	2.97 273.30	1.15 94.74	1.79 195.55	1.24 0.28	2.97 343.79	0.62 124.63	0.34 350.16	0.38 214.33	0.15 162.13	0.07 132.44	Mag Phase
190	-28.11	15.19	7.03 308.17	4.10 78.34	2.64 191.40	2.18 338.51	4.58 63.59	2.19 157.55	0.45 93.06	0.21 33.17	0.19 116.77	0.11 147.75	Mag Phase
191	-24.62	33.52	19.60 339.44	6.22 64.85	9.77 164.40	4.36 265.53	5.16 13.92	4.59 152.89	0.95 329.19	0.40 161.81	0.22 103.29	0.10 121.63	Mag Phase
192	-21.30	43.15	26.70 346.96	10.71 39.90	10.05 165.88	4.82 239.59	5.40 58.50	7.81 136.71	0.97 337.34	0.58 221.26	0.17 111.38	0.25 170.54	Mag Phase
193	-17.15	45.92	35.07 355.11	14.16 33.32	10.40 165.61	3.52 206.18	1.64 112.42	5.41 169.74	1.21 277.90	0.71 142.92	0.34 108.86	0.37 156.70	Mag Phase
194	-14.98	50.68	38.55 359.22	14.61 31.80	9.98 167.25	2.79 180.93	1.75 17.26	4.68 165.01	0.80 264.78	0.50 203.36	0.22 70.83	0.25 242.76	Mag Phase
195	-24.39	28.93	18.40 337.51	7.75 60.27	7.65 165.92	4.28 256.01	5.35 20.52	2.92 133.93	0.51 333.20	0.41 145.30	0.18 116.63	0.07 136.79	Mag Phase
196	-29.66	5.99	2.99 277.21	1.38 85.73	1.64 201.06	0.91 21.93	2.87 16.83	0.33 79.05	0.43 356.92	0.29 242.84	0.10 183.84	0.09 134.60	Mag Phase
197	-29.57	5.54	2.34 280.66	0.92 68.73	1.21 194.66	0.90 65.16	2.91 6.59	0.49 139.22	0.43 342.74	0.13 189.56	0.09 166.16	0.05 133.37	Mag Phase
198	-28.10	12.33	5.38 308.63	3.23 65.92	2.34 180.09	1.83 339.49	3.73 28.86	2.60 130.59	0.20 71.74	0.35 152.60	0.16 129.12	0.07 142.87	Mag Phase

Table III. - Continued

Run 7													
(c) Continued													
$\mu_{\text{Nom}} = 0.20$													
POINT	MEAN	1/2P-P	1P	2P	3P	4P	5P	6P	7P	8P	9P	10P	
199	-25.35	30.45	17.14 340.33	5.00 66.68	8.40 163.23	3.63 263.87	3.88 339.15	3.80 144.68	0.21 276.94	0.40 231.42	0.23 113.26	0.04 27.93	Mag Phase
200	-18.43	44.49	31.97 353.15	13.60 30.94	10.23 165.29	3.16 214.22	1.33 28.33	6.47 150.07	0.53 297.70	0.41 129.55	0.27 92.18	0.15 134.74	Mag Phase
201	-14.30	55.69	38.59 2.08	14.33 26.82	9.57 163.70	1.66 166.98	5.20 336.91	2.05 108.54	1.42 227.47	1.09 170.48	0.47 54.17	0.33 236.16	Mag Phase
202	-25.05	27.58	15.92 336.06	4.72 58.89	7.73 159.46	2.99 248.78	3.86 331.40	3.11 116.41	0.16 160.48	0.29 135.70	0.24 106.84	0.09 38.86	Mag Phase
203	-29.69	5.57	2.49 283.68	1.12 64.00	1.22 192.63	0.89 72.30	2.47 8.53	0.88 128.58	0.37 4.24	0.35 273.81	0.10 193.85	0.07 130.20	Mag Phase
204	-29.83	5.31	1.99 282.37	1.09 56.55	0.94 178.69	1.06 95.33	2.82 352.39	0.69 164.16	0.22 337.86	0.18 219.14	0.11 165.62	0.04 189.60	Mag Phase
205	-28.20	10.98	3.81 312.85	2.62 55.46	2.03 175.58	1.14 354.87	4.86 356.88	2.13 115.61	0.15 37.43	0.23 115.22	0.11 113.11	0.06 142.51	Mag Phase
206	-25.54	24.03	13.47 333.73	4.05 59.55	6.11 152.59	1.98 266.80	3.92 334.34	2.75 143.02	0.50 108.90	0.21 294.10	0.13 110.21	0.03 311.60	Mag Phase
207	-20.04	44.31	28.08 349.48	11.47 27.52	9.53 161.16	3.98 208.52	3.44 336.27	8.76 116.15	0.62 350.74	0.29 331.68	0.26 95.65	0.11 124.57	Mag Phase
208	-15.72	54.10	36.59 0.32	13.88 26.92	10.00 165.59	2.04 191.83	7.26 321.95	4.02 148.24	1.16 218.23	0.56 181.14	0.33 37.21	0.26 233.41	Mag Phase
209	-25.44	20.91	12.67 328.32	4.63 60.34	5.12 147.02	1.54 276.18	3.88 355.03	2.30 103.11	0.55 102.09	0.10 359.39	0.03 124.03	0.07 302.13	Mag Phase

Table III. - Continued

(c) Concluded

Run 7

$\mu_{\text{Nom}} = 0.20$

POINT	MEAN	1/2P-P	1P	2P	3P	4P	5P	6P	7P	8P	9P	10P	Mag Phase
210	-28.56	10.15	4.23 309.36	1.80 58.98	2.31 184.49	1.65 345.54	4.83 8.28	2.23 71.30	0.27 50.60	0.19 323.08	0.06 160.65	0.05 128.18	

Table III. - Continued

(d) Blade torsional moment, in-lbs., 35.00 percent radius

Run 7

$\mu_{Nom} = 0.06$

POINT	MEAN	1/2P-P	1P	2P	3P	4P	5P	6P	7P	8P	9P	10P	
126	2.21	3.63	1.18 18.44	1.52 99.48	0.84 147.18	0.34 182.43	1.17 239.47	0.85 141.73	0.23 301.90	0.12 243.11	0.10 274.32	0.03 70.73	Mag Phase

$\mu_{Nom} = 0.07$

POINT	MEAN	1/2P-P	1P	2P	3P	4P	5P	6P	7P	8P	9P	10P	
127	4.35	5.58	1.62 27.08	2.81 100.02	0.66 142.79	0.97 185.44	1.73 219.97	0.83 157.28	0.31 345.06	0.07 297.43	0.09 3.69	0.05 131.91	Mag Phase

$\mu_{Nom} = 0.08$

POINT	MEAN	1/2P-P	1P	2P	3P	4P	5P	6P	7P	8P	9P	10P	
128	6.57	7.66	2.32 29.81	3.74 81.04	0.45 138.36	1.61 184.84	2.20 211.07	0.80 166.82	0.51 311.48	0.11 295.32	0.11 342.65	0.04 68.11	Mag Phase
128A	7.88	11.72	4.08 28.42	4.30 67.65	1.41 313.12	2.51 214.61	3.27 246.17	1.67 285.66	0.82 330.64	0.55 217.84	0.37 265.33	0.22 276.12	Mag Phase

$\mu_{Nom} = 0.09$

POINT	MEAN	1/2P-P	1P	2P	3P	4P	5P	6P	7P	8P	9P	10P	
129	7.92	14.19	5.26 24.08	3.62 53.85	2.61 306.66	3.19 246.55	3.95 276.37	2.50 276.68	2.05 294.91	0.90 241.52	0.62 272.87	0.39 285.53	Mag Phase
130	3.07	3.65	1.29 17.71	1.80 110.87	0.42 145.07	0.58 187.11	1.33 231.81	0.52 142.24	0.23 337.60	0.09 230.96	0.04 266.89	0.09 101.85	Mag Phase

Table III. - Continued

(d) Continued

Run 7

 $\mu_{\text{Nom}} = 0.09$ 

POINT	MEAN	1/2P-P	1P	2P	3P	4P	5P	6P	7P	8P	9P	10P	
131	5.07	5.35	1.69 22.58	2.94 101.74	0.37 152.19	0.97 189.40	1.58 221.03	0.41 158.62	0.33 356.47	0.10 202.82	0.03 347.00	0.06 99.89	Mag Phase
132	7.16	6.90	2.31 25.98	4.02 82.29	0.18 185.46	1.25 189.38	1.82 204.36	0.47 198.16	0.45 315.32	0.13 238.32	0.12 349.70	0.06 84.97	Mag Phase
133	7.61	9.71	4.65 35.06	3.39 81.54	1.62 317.53	2.06 203.51	2.50 236.14	1.73 255.61	1.23 314.11	0.30 215.22	0.10 319.64	0.23 254.20	Mag Phase
134	3.25	3.71	1.32 17.68	1.82 111.57	0.38 149.84	0.61 191.41	1.37 234.03	0.51 145.00	0.25 345.83	0.08 228.55	0.04 259.27	0.08 107.08	Mag Phase
135	3.02	3.23	1.28 19.60	1.79 114.91	0.24 153.73	0.51 205.05	0.95 249.80	0.21 150.05	0.13 14.88	0.06 190.85	0.03 311.58	0.05 129.04	Mag Phase
136	4.95	4.66	1.65 23.63	2.90 102.10	0.16 158.44	0.94 188.93	0.97 224.93	0.08 121.95	0.11 41.87	0.05 59.35	0.06 317.39	0.04 104.92	Mag Phase
137	7.09	5.93	2.19 26.66	3.85 86.41	0.16 231.39	1.20 186.27	1.03 208.94	0.54 250.04	0.20 5.39	0.17 278.22	0.12 357.65	0.08 79.82	Mag Phase
138	7.33	8.56	4.70 40.18	3.17 92.85	0.96 319.57	1.50 199.70	1.45 192.58	2.33 265.98	1.15 346.01	0.18 280.60	0.25 50.43	0.09 218.52	Mag Phase
139	5.14	4.71	1.70 23.74	2.93 103.71	0.15 156.80	0.97 190.89	0.94 229.31	0.07 136.54	0.17 38.23	0.03 79.34	0.04 300.95	0.05 127.16	Mag Phase
140	3.13	3.20	1.30 19.91	1.78 114.93	0.22 157.66	0.54 204.33	0.93 249.83	0.26 157.51	0.12 355.60	0.06 175.50	0.03 336.15	0.05 114.44	Mag Phase



Table III. - Continued

(d) Continued

Run 7

 $\mu_{\text{Nom}} = 0.09$ 

POINT	MEAN	1/2P-P	1P	2P	3P	4P	5P	6P	7P	8P	9P	10P	
141	3.52	3.79	1.35 20.78	1.92 112.00	0.44 132.23	0.58 180.48	1.44 237.36	0.75 140.39	0.26 335.63	0.13 221.57	0.02 241.95	0.10 92.88	Mag Phase
142	5.53	6.23	1.76 24.54	3.25 100.13	0.41 136.49	1.06 187.58	2.27 216.47	0.77 148.69	0.36 348.05	0.17 245.82	0.07 295.27	0.10 99.43	Mag Phase
143	7.53	8.06	2.58 29.41	4.40 80.64	0.17 202.65	1.60 193.95	2.29 213.00	0.64 195.24	0.61 331.08	0.18 276.17	0.14 327.47	0.06 85.51	Mag Phase
144	8.17	12.26	4.55 29.10	3.70 64.55	1.99 316.66	2.87 218.15	3.60 254.56	1.78 263.70	1.27 312.46	0.63 219.37	0.38 266.45	0.29 272.71	Mag Phase
145	5.57	6.28	1.80 23.03	3.18 97.84	0.45 130.96	1.18 183.07	2.17 208.56	0.79 143.91	0.37 341.26	0.10 229.73	0.06 276.80	0.10 92.86	Mag Phase
146	3.62	3.76	1.37 20.57	1.89 113.81	0.44 131.78	0.62 185.33	1.39 235.41	0.77 146.21	0.26 335.04	0.12 216.51	0.01 223.99	0.10 94.97	Mag Phase

 $\mu_{\text{Nom}} = 0.13$ 

POINT	MEAN	1/2P-P	1P	2P	3P	4P	5P	6P	7P	8P	9P	10P	
147	2.35	2.09	1.13 19.03	0.91 140.44	0.26 125.97	0.54 137.31	0.35 214.62	0.36 147.58	0.04 61.04	0.04 232.24	0.06 48.88	0.05 106.44	Mag Phase
148	4.37	3.63	1.62 22.83	2.11 132.36	0.69 82.76	0.89 162.09	0.76 211.62	0.48 125.23	0.19 332.31	0.03 83.29	0.11 44.89	0.12 106.75	Mag Phase
149	6.61	5.87	2.08 24.49	3.52 117.83	1.17 61.53	1.45 169.83	1.52 213.73	0.56 112.63	0.39 332.73	0.12 329.76	0.13 20.45	0.13 104.14	Mag Phase

Table III. - Continued

(d) Continued

Run 7

 $\mu_{\text{Nom}} = 0.13$ 

POINT	MEAN	1/2P-P	1P	2P	3P	4P	5P	6P	7P	8P	9P	10P	
150	8.93	7.70	3.03 22.20	4.57 86.06	1.75 339.52	2.13 205.50	1.59 234.79	0.61 283.44	0.60 315.91	0.18 265.61	0.11 274.57	0.01 221.32	Mag Phase
151	9.30	11.32	4.13 21.27	4.70 72.26	3.08 327.29	2.86 247.84	2.09 283.16	1.08 303.43	0.77 316.34	0.57 262.37	0.46 290.70	0.31 338.76	Mag Phase
152	6.79	5.99	2.15 25.07	3.56 118.50	1.16 56.63	1.63 178.90	1.52 216.54	0.49 110.69	0.34 332.05	0.12 349.72	0.11 18.60	0.11 114.44	Mag Phase
153	4.51	3.67	1.69 21.67	2.12 133.63	0.69 87.05	0.88 161.55	0.79 213.29	0.52 129.32	0.23 339.98	0.01 92.15	0.11 56.33	0.12 113.54	Mag Phase
154	2.09	1.92	1.32 18.31	0.82 136.82	0.16 192.29	0.47 151.93	0.36 234.38	0.24 162.75	0.04 284.46	0.07 174.08	0.03 100.49	0.04 130.08	Mag Phase
155	4.13	3.46	1.63 20.46	2.06 128.92	0.41 82.88	0.80 177.69	0.94 236.05	0.30 130.87	0.29 327.90	0.08 144.00	0.07 83.30	0.09 116.13	Mag Phase
156	6.30	5.75	2.05 21.04	3.42 110.85	0.69 48.65	1.37 174.59	1.62 219.08	0.34 64.01	0.48 307.83	0.04 99.85	0.09 352.49	0.09 100.34	Mag Phase
157	8.63	7.31	2.99 23.35	4.66 88.58	1.37 329.80	1.98 207.05	1.47 240.30	0.70 325.74	0.66 315.70	0.10 334.52	0.12 296.98	0.03 334.29	Mag Phase
158	8.94	10.73	4.03 20.55	4.54 71.85	2.73 313.77	2.92 245.84	2.10 269.79	1.17 292.88	1.12 285.35	0.56 277.05	0.41 278.70	0.24 305.16	Mag Phase
159	6.37	5.67	2.10 21.68	3.38 114.13	0.72 48.15	1.39 182.42	1.56 224.90	0.29 94.85	0.46 317.20	0.03 119.04	0.09 4.06	0.10 114.78	Mag Phase

Table III. - Continued

(d) Continued

Run 7

 $\mu_{\text{Nom}} = 0.13$ 

POINT	MEAN	1/2P-P	1P	2P	3P	4P	5P	6P	7P	8P	9P	10P	
160	4.41	3.74	1.71 18.65	2.21 126.23	0.45 80.49	0.87 173.01	1.02 229.76	0.33 126.42	0.33 315.90	0.07 125.54	0.09 61.29	0.09 102.86	Mag Phase
161	1.94	1.88	1.33 17.77	0.84 128.18	0.20 258.32	0.43 158.50	0.46 237.63	0.08 119.97	0.05 328.29	0.08 167.49	0.03 105.83	0.02 138.71	Mag Phase
162	4.00	3.47	1.60 19.25	2.14 122.25	0.15 61.34	0.69 172.70	1.08 237.01	0.22 82.47	0.27 331.49	0.16 140.03	0.06 72.34	0.05 113.43	Mag Phase
163	6.18	5.42	2.08 17.84	3.47 107.80	0.44 18.45	0.98 181.08	1.71 223.05	0.39 19.41	0.40 304.47	0.13 97.66	0.05 356.49	0.07 94.34	Mag Phase
164	8.46	7.52	3.03 20.69	4.72 84.83	1.16 311.24	1.61 207.09	1.47 232.80	1.01 334.42	0.48 307.91	0.10 34.33	0.04 228.36	0.05 248.03	Mag Phase
165	8.53	11.19	4.31 23.70	4.45 77.51	2.25 311.04	2.44 248.12	2.41 278.47	1.72 344.26	0.69 295.23	0.24 311.96	0.26 270.85	0.23 301.86	Mag Phase
166	6.33	5.39	2.14 20.44	3.42 113.52	0.45 19.65	1.05 197.30	1.65 237.17	0.36 31.97	0.36 323.33	0.10 99.97	0.05 39.26	0.06 130.36	Mag Phase
167	4.03	3.49	1.67 19.85	2.14 125.04	0.13 76.76	0.71 179.04	1.06 238.51	0.20 92.88	0.23 315.05	0.13 131.34	0.06 58.96	0.06 114.92	Mag Phase

Table III. - Continued

(d) Continued

Run 7

 $\mu_{\text{Nom}} = 0.16$ 

POINT	MEAN	1/2P-P	1P	2P	3P	4P	5P	6P	7P	8P	9P	10P	
168	1.89	1.91	1.45 15.64	0.62 127.40	0.35 272.09	0.47 144.51	0.18 239.05	0.18 151.67	0.04 90.74	0.11 171.06	0.03 103.01	0.03 103.68	Mag Phase
169	4.01	3.28	1.83 21.07	2.00 126.65	0.37 13.29	0.64 162.18	0.73 232.93	0.30 88.89	0.17 333.76	0.21 133.08	0.09 77.76	0.05 99.80	Mag Phase
170	6.36	5.05	2.35 18.55	3.59 112.19	1.10 4.22	0.92 185.11	1.36 228.94	0.36 28.97	0.46 307.99	0.22 123.56	0.08 58.00	0.06 91.06	Mag Phase
171	8.63	8.91	3.39 17.49	4.72 85.40	2.78 326.96	2.11 235.05	1.70 247.58	0.85 327.68	0.61 291.45	0.22 167.25	0.19 260.23	0.14 284.15	Mag Phase
172	8.82	12.29	4.43 16.11	4.90 69.56	3.94 322.32	2.93 267.16	2.38 298.86	1.97 339.32	1.44 318.01	0.32 327.76	0.45 311.28	0.33 328.74	Mag Phase
173	6.44	4.93	2.43 19.69	3.60 113.31	1.16 5.25	0.90 191.27	1.33 230.22	0.42 10.27	0.41 315.88	0.18 123.65	0.07 38.69	0.06 99.70	Mag Phase
174	1.99	1.96	1.50 16.72	0.59 124.93	0.39 274.90	0.57 153.19	0.16 244.55	0.19 146.89	0.07 105.90	0.09 179.52	0.02 127.75	0.03 113.40	Mag Phase
175	2.55	2.27	1.48 18.58	0.73 136.98	0.17 252.16	0.71 144.82	0.30 188.17	0.31 143.94	0.08 91.20	0.11 163.08	0.06 64.72	0.07 101.00	Mag Phase
176	4.73	3.83	1.89 20.44	2.22 132.22	0.56 43.93	0.89 166.56	0.66 205.36	0.42 121.42	0.12 321.32	0.21 135.31	0.13 88.77	0.11 101.76	Mag Phase
177	7.05	5.19	2.48 21.30	3.80 115.36	1.35 25.68	1.23 187.91	1.27 223.97	0.28 48.32	0.38 317.32	0.16 123.25	0.11 55.06	0.12 106.39	Mag Phase

Table III. - Continued

Run 7													
(d) Continued													
$\mu_{\text{Nom}} = 0.16$													
POINT	MEAN	1/2P-P	1P	2P	3P	4P	5P	6P	7P	8P	9P	10P	
178	9.11	11.20	3.82 16.78	5.15 78.70	3.51 330.05	2.77 250.43	2.06 276.03	1.29 318.36	0.89 301.51	0.25 244.43	0.34 288.48	0.22 312.46	Mag Phase
179	8.91	14.47	5.13 10.93	5.07 61.96	4.65 315.89	3.42 270.14	3.10 309.74	2.24 326.32	1.48 302.95	0.64 289.04	0.58 297.54	0.28 326.49	Mag Phase
180	7.19	5.24	2.55 19.02	3.79 112.83	1.48 17.38	1.35 185.48	1.30 216.66	0.21 52.35	0.40 302.87	0.14 103.71	0.09 24.70	0.10 96.34	Mag Phase
181	2.58	2.30	1.48 16.25	0.76 134.73	0.19 263.99	0.71 141.74	0.30 180.11	0.34 136.46	0.09 102.17	0.12 145.76	0.07 63.84	0.07 89.37	Mag Phase
182	3.04	2.49	1.33 14.17	1.02 137.90	0.17 94.53	0.55 127.12	0.35 170.56	0.36 127.54	0.13 106.70	0.13 155.36	0.06 54.10	0.08 55.68	Mag Phase
183	5.19	4.13	1.87 20.63	2.28 136.95	0.88 58.98	0.83 157.36	0.65 172.56	0.47 112.58	0.06 15.07	0.19 151.00	0.11 70.17	0.10 81.35	Mag Phase
184	7.64	5.50	2.49 22.21	3.83 115.44	1.78 31.95	1.33 173.04	0.98 200.90	0.39 76.06	0.26 303.05	0.01 12.25	0.13 31.36	0.09 54.45	Mag Phase
185	9.65	10.95	3.85 18.80	5.28 77.90	3.79 333.41	2.79 246.33	1.56 285.21	1.05 313.77	0.69 297.14	0.44 244.81	0.34 312.90	0.29 340.66	Mag Phase
186	9.41	14.37	5.09 13.97	5.40 65.03	4.70 320.30	3.11 272.03	2.87 333.92	1.83 337.02	1.16 309.37	0.72 285.92	0.62 324.87	0.37 332.16	Mag Phase
187	7.77	5.45	2.56 22.94	3.86 116.12	1.78 28.91	1.47 181.76	1.05 201.03	0.34 85.76	0.28 310.23	0.06 358.94	0.13 30.00	0.07 69.29	Mag Phase
188	3.06	2.48	1.40 17.83	0.96 142.45	0.12 81.82	0.60 141.54	0.36 183.18	0.36 142.08	0.12 123.91	0.12 182.27	0.07 86.26	0.06 86.84	Mag Phase

Table III. - Continued

(d) Continued

$\mu_{\text{Nom}} = 0.20$

Run 7	POINT	MEAN	1/2P-P	1P	2P	3P	4P	5P	6P	7P	8P	9P	10P	
	189	3.13	2.47	1.56 13.58	0.78 143.16	0.24 324.18	0.47 129.33	0.48 200.04	0.54 141.26	0.22 129.77	0.06 176.31	0.05 101.40	0.08 129.00	Mag Phase
	190	5.50	4.64	2.12 21.34	2.13 139.90	0.88 28.50	0.85 152.09	0.92 170.33	0.73 122.81	0.13 62.13	0.13 207.74	0.15 122.16	0.14 106.36	Mag Phase
	191	7.99	5.88	2.85 20.67	3.96 112.69	2.26 5.57	1.33 211.92	1.15 205.14	0.19 54.96	0.32 295.23	0.27 225.13	0.03 112.98	0.09 61.74	Mag Phase
	192	9.04	10.80	3.55 16.66	4.88 87.03	4.29 336.45	3.17 244.19	1.55 252.09	0.86 297.76	0.79 288.04	0.45 226.91	0.19 248.87	0.21 310.73	Mag Phase
	193	9.55	14.99	4.71 9.87	6.24 67.78	6.01 329.13	4.49 260.23	2.15 303.28	2.04 330.20	1.21 318.74	0.57 241.90	0.41 306.90	0.41 337.69	Mag Phase
	194	9.33	15.87	5.55 8.04	6.51 60.51	6.30 323.12	4.23 265.33	2.84 336.51	2.72 345.76	1.83 336.04	0.32 318.51	0.41 352.55	0.31 355.07	Mag Phase
	195	8.08	5.84	2.97 22.18	3.89 115.25	2.33 11.46	1.40 219.48	1.15 216.62	0.05 83.90	0.37 308.69	0.35 238.33	0.06 27.54	0.09 44.23	Mag Phase
	196	3.12	2.54	1.59 16.66	0.72 142.29	0.33 311.44	0.58 144.75	0.45 191.79	0.54 151.57	0.24 127.97	0.09 194.21	0.08 115.56	0.09 125.79	Mag Phase
	197	2.59	2.47	1.74 16.16	0.34 118.22	0.63 282.32	0.78 140.95	0.08 208.98	0.46 166.74	0.19 135.27	0.11 212.36	0.04 76.81	0.05 102.85	Mag Phase
	198	4.85	3.73	2.24 20.58	1.72 126.42	0.58 345.81	0.93 149.30	0.49 206.78	0.50 127.70	0.08 335.68	0.18 199.76	0.12 66.11	0.10 77.10	Mag Phase

Table III. - Continued

(d) Continued

$\mu_{Nom} = 0.20$

Run 7	POINT	MEAN	1/2P-P	1P	2P	3P	4P	5P	6P	7P	8P	9P	10P	
	199	7.17	5.77	2.92 20.06	3.65 114.11	1.86 3.81	1.26 201.03	1.04 243.13	0.17 52.01	0.38 329.11	0.24 210.75	0.11 70.19	0.06 56.17	Mag Phase
	200	9.21	12.70	4.33 14.56	5.85 70.55	5.26 328.28	3.21 250.58	2.06 294.15	1.73 325.81	1.18 327.68	0.19 254.52	0.32 322.85	0.38 322.42	Mag Phase
	201	8.82	14.95	5.77 10.86	5.89 55.99	5.85 315.68	3.13 257.68	3.59 344.90	2.85 4.49	1.73 350.36	0.43 24.28	0.44 13.62	0.11 1.10	Mag Phase
	202	7.25	6.00	3.00 18.56	3.62 110.55	1.92 355.27	1.41 194.80	1.13 232.99	0.09 51.28	0.35 323.04	0.21 217.97	0.11 42.54	0.05 58.52	Mag Phase
	203	2.57	2.54	1.78 16.18	0.28 112.69	0.67 283.51	0.80 144.35	0.08 204.03	0.42 168.17	0.16 139.09	0.11 206.97	0.04 87.72	0.05 115.31	Mag Phase
	204	1.92	2.52	1.78 11.63	0.21 69.39	0.84 272.08	0.71 132.74	0.10 327.49	0.31 164.41	0.17 134.34	0.08 196.39	0.03 95.53	0.03 113.56	Mag Phase
	205	4.12	3.45	2.26 19.15	1.44 122.02	0.53 325.76	0.73 137.57	0.35 262.93	0.35 115.98	0.07 25.03	0.13 169.33	0.07 65.04	0.05 81.14	Mag Phase
	206	6.32	5.17	2.85 18.21	3.11 112.96	1.61 1.59	0.64 180.97	0.82 256.37	0.23 78.29	0.36 332.55	0.15 173.76	0.10 49.74	0.03 69.67	Mag Phase
	207	8.74	10.17	3.88 15.36	4.81 75.49	4.32 325.17	2.44 234.75	1.66 268.27	0.74 307.81	0.53 303.93	0.35 205.83	0.20 275.66	0.20 291.26	Mag Phase
	208	8.87	14.69	4.91 11.41	5.41 58.12	5.49 323.12	2.62 270.44	3.48 328.05	2.53 357.74	1.75 351.76	0.28 16.99	0.40 328.51	0.25 337.24	Mag Phase
	209	6.43	5.17	2.91 17.38	3.13 112.06	1.69 0.10	0.61 179.24	0.79 249.08	0.11 72.76	0.38 328.56	0.11 159.00	0.06 34.39	0.04 107.22	Mag Phase

Table III. - Continued

(d) Concluded

$\mu_{Nom} = 0.20$

Run 7

POINT	MEAN	1/2P-P	1P	2P	3P	4P	5P	6P	7P	8P	9P	10P	
210	4.12	3.45	2.29 20.99	1.53 127.78	0.43 336.58	0.71 137.30	0.32 277.28	0.39 134.01	0.10 26.87	0.11 178.94	0.07 69.53	0.04 120.10	Mag Phase



Table III. - Continued

(e) Blade flapwise bending moment, in-lbs., 37.00 percent radius

Run 7

$\mu_{Nom} = 0.06$

POINT	MEAN	1/2P-P	1P	2P	3P	4P	5P	6P	7P	8P	9P	10P	
126	-0.24	0.21	0.05 347.14	0.06 112.89	0.05 359.70	0.04 156.55	0.07 59.00	0.06 18.97	0.05 25.68	0.05 183.07	0.02 179.06	0.03 227.82	Mag Phase

$\mu_{Nom} = 0.07$

POINT	MEAN	1/2P-P	1P	2P	3P	4P	5P	6P	7P	8P	9P	10P	
127	-0.29	0.47	0.07 183.68	0.12 60.03	0.13 315.32	0.12 171.91	0.07 55.47	0.05 10.91	0.10 327.69	0.09 213.76	0.07 204.98	0.04 193.96	Mag Phase

$\mu_{Nom} = 0.08$

POINT	MEAN	1/2P-P	1P	2P	3P	4P	5P	6P	7P	8P	9P	10P	
128	-0.44	0.36	0.13 260.26	0.02 172.89	0.04 352.18	0.11 195.62	0.02 297.41	0.05 127.49	0.03 142.49	0.04 45.55	0.06 98.28	0.07 145.48	Mag Phase
128A	-0.17	0.43	0.25 259.26	0.12 76.53	0.05 72.49	0.08 201.94	0.07 315.01	0.02 344.34	0.05 299.50	0.11 270.91	0.05 154.21	0.02 169.06	Mag Phase

$\mu_{Nom} = 0.09$

POINT	MEAN	1/2P-P	1P	2P	3P	4P	5P	6P	7P	8P	9P	10P	
129	-0.29	0.45	0.27 262.38	0.10 102.34	0.04 4.04	0.01 236.02	0.09 248.91	0.04 339.93	0.06 3.37	0.03 143.26	0.07 326.52	0.05 57.03	Mag Phase
130	-0.34	0.61	0.36 259.89	0.16 55.04	0.04 84.03	0.03 262.05	0.09 3.09	0.07 282.06	0.03 222.87	0.09 224.96	0.03 155.15	0.12 48.36	Mag Phase

Table III. - Continued

(e) Continued

Run 7

 $\mu_{\text{Nom}} = 0.09$ 

POINT	MEAN	1/2P-P	1P	2P	3P	4P	5P	6P	7P	8P	9P	10P	
131	-0.27	0.54	0.37 256.11	0.12 66.44	0.07 162.75	0.08 128.51	0.02 355.42	0.03 356.54	0.05 200.12	0.04 182.52	0.07 32.58	0.08 96.61	Mag Phase
132	-0.24	0.58	0.31 263.18	0.16 64.13	0.04 304.40	0.07 113.98	0.03 265.63	0.06 210.11	0.06 171.75	0.06 143.88	0.03 66.66	0.15 202.49	Mag Phase
133	-0.21	0.47	0.34 254.28	0.07 62.60	0.03 154.64	0.09 278.32	0.06 286.82	0.02 106.63	0.03 159.77	0.09 306.26	0.02 20.32	0.08 50.56	Mag Phase
134	-0.20	0.76	0.42 247.84	0.11 28.09	0.11 147.98	0.03 20.35	0.13 59.99	0.03 301.29	0.04 15.88	0.06 152.12	0.05 150.11	0.10 31.76	Mag Phase
135	-0.19	0.71	0.48 251.01	0.14 16.82	0.13 162.56	0.01 152.43	0.09 326.61	0.04 256.52	0.06 146.87	0.05 92.83	0.13 141.82	0.06 320.21	Mag Phase
136	-0.32	0.75	0.55 243.30	0.07 347.16	0.09 149.21	0.08 317.11	0.04 359.93	0.05 47.89	0.08 222.52	0.01 113.67	0.05 200.19	0.06 40.62	Mag Phase
137	-0.32	0.60	0.49 239.55	0.07 25.42	0.07 346.71	0.10 307.53	0.05 15.70	0.02 157.42	0.07 162.58	0.03 49.82	0.05 238.81	0.07 69.04	Mag Phase
138	-0.46	0.71	0.52 229.66	0.05 336.23	0.04 168.71	0.09 214.19	0.01 243.57	0.06 39.53	0.08 55.80	0.03 97.82	0.06 184.50	0.13 104.90	Mag Phase
139	-0.30	0.74	0.52 229.49	0.05 287.26	0.09 135.36	0.04 142.34	0.05 43.81	0.05 344.20	0.05 127.85	0.05 51.09	0.03 292.07	0.09 237.36	Mag Phase
140	-0.31	0.68	0.47 222.31	0.04 64.88	0.09 130.54	0.06 50.58	0.05 80.70	0.05 214.28	0.07 59.70	0.03 204.45	0.07 203.23	0.02 39.12	Mag Phase

Table III. - Continued

(e) Continued

Run 7

 $\mu_{\text{Nom}} = 0.09$ 

POINT	MEAN	1/2P-P	1P	2P	3P	4P	5P	6P	7P	8P	9P	10P	
141	-0.19	0.66	0.53 217.38	0.06 236.57	0.06 314.31	0.05 289.94	0.02 88.94	0.06 176.37	0.04 118.48	0.07 116.44	0.08 201.83	0.08 214.18	Mag Phase
142	-0.21	0.60	0.41 205.50	0.08 302.34	0.07 340.58	0.05 273.72	0.08 309.40	0.05 201.75	0.06 205.13	0.05 64.83	0.06 244.17	0.08 189.26	Mag Phase
143	-0.26	0.51	0.30 200.23	0.05 11.39	0.08 312.00	0.02 276.89	0.07 344.08	0.01 155.65	0.04 158.25	0.03 359.49	0.06 14.94	0.10 239.91	Mag Phase
144	-0.19	0.53	0.25 189.66	0.14 345.92	0.08 357.53	0.10 252.24	0.05 188.79	0.05 339.58	0.04 343.08	0.06 147.16	0.08 58.95	0.01 353.25	Mag Phase
145	-0.21	0.55	0.27 192.78	0.10 349.04	0.03 297.65	0.03 125.99	0.04 20.44	0.04 49.37	0.04 164.21	0.05 359.59	0.06 104.95	0.13 231.72	Mag Phase
146	-0.18	0.49	0.26 189.87	0.08 353.11	0.08 71.12	0.02 290.82	0.05 318.66	0.03 102.66	0.01 173.87	0.05 231.73	0.08 55.02	0.07 104.78	Mag Phase

 $\mu_{\text{Nom}} = 0.13$ 

POINT	MEAN	1/2P-P	1P	2P	3P	4P	5P	6P	7P	8P	9P	10P	
147	-0.18	0.44	0.14 178.87	0.19 351.02	0.10 52.05	0.11 236.99	0.06 325.83	0.07 82.90	0.03 129.13	0.06 115.59	0.02 33.23	0.03 326.05	Mag Phase
148	-0.05	0.38	0.26 195.74	0.08 337.49	0.04 89.70	0.04 284.95	0.06 70.92	0.07 294.48	0.05 128.08	0.06 220.90	0.01 252.65	0.07 339.33	Mag Phase
149	-0.14	0.42	0.24 210.66	0.10 353.04	0.05 20.61	0.04 169.09	0.05 315.41	0.05 77.39	0.06 278.44	0.09 237.35	0.01 279.42	0.05 316.28	Mag Phase

Table III. - Continued

(e) Continued

Run 7

 $\mu_{\text{Nom}} = 0.13$ 

POINT	MEAN	1/2P-P	1P	2P	3P	4P	5P	6P	7P	8P	9P	10P	
150	-0.10	0.47	0.21 201.11	0.14 328.69	0.03 236.98	0.07 229.00	0.08 22.99	0.03 257.24	0.04 281.73	0.03 71.99	0.07 78.95	0.07 334.01	Mag Phase
151	-0.16	0.32	0.17 222.32	0.01 106.63	0.10 327.58	0.08 247.58	0.04 65.88	0.02 324.84	0.06 90.18	0.02 17.33	0.06 56.73	0.02 287.35	Mag Phase
152	-0.20	0.37	0.22 249.99	0.04 260.03	0.11 299.03	0.03 297.94	0.05 51.90	0.02 183.37	0.02 91.14	0.02 247.82	0.02 201.85	0.05 333.48	Mag Phase
153	0.04	0.41	0.23 252.03	0.06 162.20	0.06 335.18	0.06 83.42	0.11 125.39	0.02 103.65	0.04 32.51	0.06 272.28	0.09 235.44	0.03 92.31	Mag Phase
154	-0.07	0.48	0.36 253.02	0.03 336.37	0.12 310.18	0.07 188.41	0.05 153.54	0.03 344.08	0.03 26.98	0.06 324.55	0.05 332.97	0.08 172.30	Mag Phase
155	-0.20	0.45	0.30 244.71	0.11 0.35	0.06 302.97	0.05 164.58	0.08 143.34	0.01 40.78	0.05 99.66	0.04 142.03	0.02 87.05	0.02 97.33	Mag Phase
156	-0.03	0.51	0.37 252.56	0.05 47.78	0.06 285.79	0.04 115.58	0.08 158.93	0.07 269.15	0.02 119.25	0.05 190.36	0.08 267.51	0.02 52.56	Mag Phase
157	-0.07	0.45	0.33 253.16	0.03 357.73	0.11 10.03	0.04 220.53	0.10 148.99	0.04 37.84	0.04 168.89	0.03 344.86	0.10 20.87	0.05 95.22	Mag Phase
158	-0.21	0.58	0.42 229.70	0.16 358.44	0.06 264.53	0.13 259.91	0.06 261.44	0.06 32.19	0.06 352.59	0.02 5.52	0.04 195.78	0.06 136.50	Mag Phase
159	-0.15	0.56	0.43 230.00	0.10 20.01	0.05 171.78	0.03 324.48	0.04 291.34	0.08 124.06	0.03 80.80	0.01 239.98	0.07 50.61	0.05 96.34	Mag Phase

Table III. - Continued

(e) Continued

Run 7

 $\mu_{\text{Nom}} = 0.13$ 

POINT	MEAN	1/2P-P	1P	2P	3P	4P	5P	6P	7P	8P	9P	10P	
160	-0.03	0.70	0.52 231.21	0.15 16.34	0.09 192.86	0.03 335.06	0.06 20.41	0.02 355.52	0.04 245.95	0.04 136.70	0.06 324.31	0.04 11.99	Mag Phase
161	-0.14	0.65	0.46 224.11	0.11 15.97	0.05 328.54	0.08 148.15	0.09 133.71	0.03 171.79	0.07 101.00	0.03 297.51	0.10 16.74	0.03 85.17	Mag Phase
162	0.01	0.58	0.44 216.00	0.09 18.39	0.11 109.45	0.06 301.50	0.05 286.15	0.06 29.80	0.04 38.36	0.02 111.59	0.02 178.07	0.02 190.96	Mag Phase
163	-0.09	0.72	0.55 221.35	0.15 9.35	0.06 202.65	0.07 349.07	0.03 197.44	0.06 158.03	0.05 125.46	0.07 154.76	0.03 299.60	0.04 244.77	Mag Phase
164	-0.02	0.68	0.52 211.40	0.10 323.95	0.05 95.31	0.05 271.12	0.07 6.05	0.05 353.43	0.06 167.12	0.07 152.26	0.04 229.63	0.03 341.35	Mag Phase
165	0.16	0.84	0.55 201.18	0.11 343.55	0.07 112.91	0.13 271.29	0.07 131.51	0.02 181.36	0.03 325.18	0.01 204.46	0.09 267.89	0.02 81.45	Mag Phase
166	0.07	0.62	0.48 201.91	0.06 334.82	0.05 66.24	0.03 20.42	0.13 73.57	0.04 27.16	0.02 146.86	0.02 203.59	0.09 104.05	0.06 358.78	Mag Phase
167	-0.12	0.79	0.55 199.78	0.04 17.26	0.14 143.50	0.06 307.31	0.12 76.21	0.02 1.20	0.03 27.08	0.03 355.66	0.03 256.55	0.03 123.82	Mag Phase

Table III. - Continued

(e) Continued

Run 7

 $\mu_{\text{Nom}} = 0.16$ 

POINT	MEAN	1/2P-P	1P	2P	3P	4P	5P	6P	7P	8P	9P	10P	
168	-0.16	0.63	0.46 185.01	0.01 120.09	0.06 158.20	0.03 210.33	0.07 105.42	0.06 305.00	0.06 164.83	0.03 255.11	0.04 122.64	0.16 218.69	Mag Phase
169	-0.09	0.68	0.46 187.60	0.03 282.37	0.12 27.03	0.14 144.43	0.11 79.74	0.02 320.49	0.04 47.23	0.03 168.73	0.05 260.07	0.06 64.24	Mag Phase
170	-0.20	0.59	0.35 181.83	0.07 301.69	0.10 335.24	0.04 171.38	0.10 22.92	0.03 229.87	0.01 174.91	0.07 184.34	0.05 266.14	0.12 127.34	Mag Phase
171	-0.20	0.62	0.26 173.30	0.12 6.54	0.12 0.82	0.10 205.69	0.01 337.90	0.06 319.84	0.06 146.51	0.04 203.07	0.04 317.81	0.09 305.52	Mag Phase
172	-0.08	0.67	0.30 159.15	0.10 343.83	0.11 78.39	0.15 278.38	0.08 113.69	0.02 300.44	0.09 83.43	0.08 11.14	0.11 228.42	0.10 318.14	Mag Phase
173	-0.28	0.33	0.20 171.20	0.09 321.48	0.01 307.50	0.01 156.03	0.05 359.15	0.04 288.71	0.02 254.64	0.04 114.11	0.06 136.23	0.03 255.65	Mag Phase
174	-0.52	0.31	0.23 189.05	0.02 289.53	0.03 237.90	0.04 8.98	0.03 185.05	0.03 265.70	0.02 61.91	0.03 272.63	0.03 44.23	0.06 137.76	Mag Phase
175	-0.46	0.39	0.19 188.25	0.09 304.68	0.01 42.30	0.07 42.52	0.05 124.78	0.03 22.42	0.11 196.07	0.09 127.23	0.11 143.29	0.04 3.47	Mag Phase
176	-0.49	0.38	0.21 182.22	0.05 15.05	0.04 317.91	0.09 176.51	0.00 209.25	0.02 336.14	0.05 29.32	0.04 171.41	0.03 298.59	0.04 125.80	Mag Phase
177	-0.47	0.32	0.21 173.16	0.02 120.88	0.06 29.95	0.02 218.61	0.06 55.60	0.00 300.53	0.01 121.31	0.01 209.73	0.04 70.03	0.05 280.11	Mag Phase

Table III. - Continued

Run 7													
(e) Continued													
$\mu_{\text{Nom}} = 0.16$													
POINT	MEAN	1/2P-P	1P	2P	3P	4P	5P	6P	7P	8P	9P	10P	
178	-0.43	0.36	0.16 216.44	0.03 91.10	0.12 356.23	0.07 317.71	0.05 108.09	0.03 161.84	0.03 123.67	0.08 274.31	0.04 350.67	0.06 221.19	Mag Phase
179	-0.50	0.59	0.25 185.74	0.02 169.15	0.16 351.44	0.14 197.28	0.05 32.44	0.03 340.43	0.01 232.61	0.05 20.65	0.12 16.19	0.05 102.69	Mag Phase
180	-0.33	0.60	0.27 215.74	0.13 51.83	0.03 249.48	0.04 213.82	0.12 52.18	0.01 249.41	0.08 224.34	0.05 35.14	0.06 41.36	0.11 330.41	Mag Phase
181	-0.39	0.47	0.31 224.12	0.06 41.53	0.05 85.23	0.04 299.10	0.08 201.09	0.02 43.85	0.02 316.80	0.04 230.62	0.03 200.54	0.04 99.85	Mag Phase
182	-0.23	0.69	0.35 223.16	0.09 122.05	0.07 196.08	0.03 192.40	0.12 97.15	0.06 305.87	0.06 48.24	0.11 265.82	0.07 63.75	0.03 224.83	Mag Phase
183	-0.23	0.57	0.46 213.09	0.10 4.42	0.05 152.57	0.02 147.01	0.03 143.51	0.05 77.79	0.03 81.61	0.05 216.88	0.06 11.83	0.01 186.94	Mag Phase
184	-0.35	0.63	0.58 208.88	0.07 349.78	0.05 233.34	0.02 334.58	0.06 66.40	0.05 218.93	0.08 121.20	0.05 259.34	0.09 183.09	0.03 157.20	Mag Phase
185	-0.19	0.50	0.42 214.31	0.13 353.97	0.09 304.99	0.02 70.96	0.11 318.99	0.05 66.00	0.06 161.62	0.07 182.89	0.05 192.33	0.04 319.04	Mag Phase
186	-0.24	0.62	0.48 210.24	0.07 30.34	0.08 298.62	0.03 243.01	0.11 308.81	0.05 49.94	0.06 5.39	0.02 267.09	0.03 103.51	0.07 195.21	Mag Phase
187	-0.20	0.74	0.52 214.71	0.17 49.55	0.14 176.44	0.10 107.79	0.10 347.17	0.06 114.67	0.05 163.59	0.10 212.77	0.03 152.87	0.04 172.75	Mag Phase
188	-0.08	0.75	0.59 207.98	0.10 3.49	0.17 187.19	0.02 229.77	0.08 311.10	0.03 109.71	0.04 109.69	0.05 175.44	0.08 166.78	0.10 169.42	Mag Phase

Table III. - Continued

(e) Continued

Run 7

 $\mu_{\text{Nom}} = 0.20$ 

POINT	MEAN	1/2P-P	1P	2P	3P	4P	5P	6P	7P	8P	9P	10P	
189	-0.03	0.74	0.61 196.05	0.06 70.33	0.08 142.83	0.02 268.58	0.07 324.36	0.01 156.39	0.02 134.44	0.04 219.78	0.02 76.89	0.02 68.98	Mag Phase
190	0.00	0.71	0.55 189.89	0.03 62.33	0.03 169.14	0.01 264.16	0.09 74.23	0.04 176.90	0.05 251.20	0.05 281.00	0.02 330.86	0.13 301.35	Mag Phase
191	-0.01	0.70	0.59 187.44	0.02 61.68	0.03 146.46	0.05 11.54	0.05 68.33	0.06 187.58	0.01 60.21	0.07 248.42	0.03 189.79	0.07 126.15	Mag Phase
192	0.11	0.80	0.53 186.29	0.03 133.64	0.07 23.44	0.07 263.59	0.07 62.72	0.02 45.37	0.06 161.38	0.17 301.43	0.03 314.08	0.08 230.04	Mag Phase
193	-0.27	0.73	0.52 186.29	0.15 41.54	0.09 69.82	0.03 227.30	0.10 24.41	0.02 330.39	0.05 333.01	0.08 114.67	0.05 166.48	0.09 112.45	Mag Phase
194	0.03	0.64	0.46 176.14	0.15 60.13	0.01 199.75	0.04 347.77	0.08 339.64	0.09 126.26	0.09 142.73	0.04 148.22	0.05 52.97	0.05 323.23	Mag Phase
195	-0.10	0.79	0.55 176.60	0.21 52.42	0.07 158.73	0.03 172.21	0.05 6.54	0.08 50.31	0.08 182.96	0.03 195.38	0.07 68.38	0.06 75.14	Mag Phase
196	-0.05	0.67	0.52 164.21	0.15 44.97	0.12 143.00	0.02 180.94	0.03 352.05	0.08 107.34	0.02 319.57	0.07 135.33	0.06 27.98	0.03 204.73	Mag Phase
197	0.15	0.65	0.48 165.67	0.13 317.76	0.01 206.11	0.04 0.11	0.06 154.68	0.08 115.82	0.04 173.32	0.06 8.89	0.10 84.97	0.06 318.10	Mag Phase
198	-0.02	0.69	0.47 168.65	0.01 344.09	0.06 110.35	0.07 352.93	0.08 122.68	0.05 234.54	0.09 239.12	0.09 76.30	0.08 108.79	0.04 47.62	Mag Phase



Table III. - Continued

Run 7													
(e) Continued													
$\mu_{\text{Nom}} = 0.20$													
POINT	MEAN	1/2P-P	1P	2P	3P	4P	5P	6P	7P	8P	9P	10P	
199	0.11	0.63	0.38 158.31	0.02 267.10	0.13 70.71	0.02 305.39	0.11 111.94	0.02 268.83	0.03 178.77	0.15 300.07	0.06 36.33	0.04 180.16	Mag Phase
200	-0.03	0.55	0.36 167.60	0.11 324.52	0.10 14.85	0.01 6.28	0.06 113.38	0.05 38.63	0.08 66.60	0.03 337.77	0.03 212.95	0.03 279.87	Mag Phase
201	0.09	0.42	0.26 171.62	0.10 5.95	0.03 208.78	0.04 341.78	0.10 29.55	0.09 6.27	0.03 66.78	0.07 231.20	0.03 329.48	0.06 32.11	Mag Phase
202	0.21	0.47	0.35 164.05	0.09 3.02	0.10 88.08	0.04 136.31	0.01 128.47	0.06 10.85	0.07 2.62	0.03 71.04	0.07 106.72	0.01 90.33	Mag Phase
203	0.30	0.36	0.25 170.46	0.04 22.11	0.06 153.91	0.05 5.62	0.03 277.38	0.05 66.99	0.04 100.47	0.05 196.60	0.03 99.03	0.03 15.26	Mag Phase
204	0.24	0.47	0.21 159.31	0.05 127.62	0.12 24.67	0.05 90.87	0.11 140.32	0.14 339.63	0.06 41.13	0.05 312.65	0.02 312.65	0.05 78.54	Mag Phase
205	0.29	0.49	0.27 174.98	0.10 138.17	0.06 79.01	0.06 68.70	0.06 84.66	0.11 316.94	0.03 314.18	0.03 109.40	0.02 223.06	0.04 106.51	Mag Phase
206	0.01	0.44	0.22 193.06	0.11 120.54	0.07 49.69	0.11 64.26	0.02 72.72	0.08 309.27	0.02 206.54	0.05 240.19	0.04 17.15	0.03 3.40	Mag Phase
207	0.19	0.35	0.21 225.69	0.16 47.73	0.09 351.19	0.05 85.53	0.07 357.99	0.05 113.15	0.06 73.35	0.02 261.01	0.04 303.51	0.04 334.71	Mag Phase
208	0.03	0.33	0.19 224.80	0.10 60.85	0.08 345.76	0.07 101.71	0.06 335.72	0.08 315.32	0.04 12.94	0.05 122.83	0.01 6.84	0.00 264.33	Mag Phase
209	0.09	0.49	0.24 182.33	0.12 40.95	0.11 48.78	0.15 34.26	0.07 288.81	0.04 117.55	0.01 251.85	0.05 153.84	0.03 312.68	0.06 297.78	Mag Phase

Table III. - Continued

(e) Concluded

$\mu_{Nom} = 0.20$

Run 7

POINT	MEAN	1/2P-P	1P	2P	3P	4P	5P	6P	7P	8P	9P	10P	
210	0.29	0.58	0.40 184.37	0.09 37.69	0.10 72.95	0.06 98.16	0.03 123.18	0.08 312.70	0.02 341.96	0.04 142.84	0.03 166.47	0.03 94.31	Mag Phase

Table III. - Continued

(f) Blade chordwise bending moment, in-lbs, 45.00 percent radius

Run 7

$\mu_{Nom} = 0.06$

POINT	MEAN	1/2P-P	1P	2P	3P	4P	5P	6P	7P	8P	9P	10P	
126	-32.75	13.02	0.67 98.69	0.77 22.60	3.09 153.71	2.27 292.92	6.23 305.34	4.28 329.46	0.49 175.83	0.65 269.51	0.58 156.78	0.25 203.45	Mag Phase

$\mu_{Nom} = 0.07$

POINT	MEAN	1/2P-P	1P	2P	3P	4P	5P	6P	7P	8P	9P	10P	
127	-32.23	17.88	2.33 17.75	2.82 36.66	5.92 166.12	2.38 307.13	3.94 25.67	7.55 29.20	0.48 171.51	1.73 238.89	0.52 187.86	0.11 258.54	Mag Phase

$\mu_{Nom} = 0.08$

POINT	MEAN	1/2P-P	1P	2P	3P	4P	5P	6P	7P	8P	9P	10P	
128	-29.46	30.31	9.08 4.67	4.24 33.46	11.11 169.49	3.91 265.37	3.06 7.66	6.25 355.70	0.71 117.09	2.93 215.50	0.29 164.64	0.57 62.86	Mag Phase
128A	-22.48	47.20	19.54 9.96	9.61 22.35	19.48 172.40	1.65 259.01	3.13 311.45	6.58 355.79	3.81 236.24	1.58 282.51	1.23 358.93	0.74 123.57	Mag Phase

$\mu_{Nom} = 0.09$

POINT	MEAN	1/2P-P	1P	2P	3P	4P	5P	6P	7P	8P	9P	10P	
129	-17.89	60.64	23.86 13.99	10.92 26.97	21.21 168.12	1.91 186.10	9.54 304.71	12.41 332.79	3.14 169.36	1.74 315.43	1.50 344.49	0.64 162.09	Mag Phase
130	-33.88	10.77	0.54 37.81	1.56 61.42	3.54 169.76	2.44 299.12	2.92 350.96	3.66 1.00	0.38 43.61	0.89 250.29	0.29 160.56	0.18 203.15	Mag Phase

Table III. - Continued

(f) Continued

Run 7

 $\mu_{\text{Nom}} = 0.09$ 

POINT	MEAN	1/2P-P	1P	2P	3P	4P	5P	6P	7P	8P	9P	10P	
131	-32.52	15.57	2.80 10.48	2.97 49.37	6.20 165.61	2.85 299.25	3.19 47.77	5.70 42.56	0.88 162.09	1.27 312.00	0.22 178.58	0.29 344.17	Mag Phase
132	-29.43	30.12	9.80 3.79	3.99 18.55	13.29 163.29	3.84 275.24	3.15 286.18	7.11 349.09	0.12 290.05	1.50 175.60	0.18 177.03	0.47 68.13	Mag Phase
133	-22.12	43.13	17.35 10.28	10.02 25.01	17.89 171.59	1.66 305.53	5.66 313.15	6.09 32.63	2.31 175.21	1.21 304.76	0.36 300.52	0.54 71.33	Mag Phase
134	-34.24	10.79	0.56 59.13	1.68 63.03	3.51 172.06	2.42 304.76	3.55 349.54	3.07 0.11	0.18 93.00	0.92 251.37	0.38 166.53	0.21 219.99	Mag Phase
135	-34.19	8.36	0.77 30.75	1.37 49.78	2.77 177.74	2.12 319.09	3.72 3.69	1.69 15.92	0.14 72.52	0.54 54.97	0.21 170.01	0.06 271.94	Mag Phase
136	-32.74	12.55	2.57 8.91	2.42 46.79	4.97 167.14	2.37 298.11	2.08 25.08	4.34 87.39	0.09 135.99	1.23 177.49	0.29 134.88	0.18 305.47	Mag Phase
137	-29.84	27.58	9.67 4.53	3.55 21.69	12.01 165.00	3.15 277.24	5.45 298.81	5.42 349.22	0.59 275.32	0.63 84.11	0.08 305.01	0.35 89.22	Mag Phase
138	-22.57	40.92	15.24 8.05	8.86 28.12	15.41 175.17	1.75 338.84	8.08 340.15	6.50 108.30	2.90 216.12	1.27 48.95	0.65 306.79	0.75 42.89	Mag Phase
139	-32.87	13.80	2.96 6.02	2.80 42.41	5.35 169.14	2.08 292.39	2.15 25.08	4.56 89.18	0.28 182.33	0.08 348.36	0.24 137.94	0.20 7.30	Mag Phase
140	-34.16	8.46	0.71 22.57	1.54 55.52	3.05 178.25	2.04 321.98	3.45 5.36	1.36 8.72	0.23 100.07	0.71 225.82	0.32 186.01	0.23 260.35	Mag Phase

Table III. - Continued

(f) Continued

Run 7

 $\mu_{\text{Nom}} = 0.09$ 

POINT	MEAN	1/2P-P	1P	2P	3P	4P	5P	6P	7P	8P	9P	10P	
141	-34.39	13.53	0.60 54.11	1.87 72.08	3.86 175.22	3.43 301.99	4.82 346.01	3.14 356.16	0.28 89.36	0.24 150.70	0.42 164.63	0.21 210.21	Mag Phase
142	-32.63	18.80	3.09 3.87	3.63 61.84	7.66 163.07	4.11 295.72	0.97 356.08	7.29 35.74	0.68 147.63	0.52 308.90	0.60 129.18	0.13 288.40	Mag Phase
143	-29.47	37.57	11.49 5.05	4.80 30.10	15.87 168.62	5.81 276.65	3.03 313.59	9.91 352.22	0.70 206.75	1.91 219.22	0.32 215.20	0.78 73.96	Mag Phase
144	-22.45	52.24	19.88 10.80	10.65 28.19	20.79 171.43	1.67 297.42	7.00 317.85	10.53 3.27	3.60 218.61	1.82 357.88	0.57 348.19	0.36 108.61	Mag Phase
145	-32.88	19.22	2.93 1.17	3.83 54.40	7.36 158.73	3.61 285.24	2.01 59.04	8.43 27.35	0.71 153.50	1.00 209.36	0.85 98.91	0.35 286.52	Mag Phase
146	-34.59	12.51	0.53 60.70	1.99 75.33	3.84 173.94	3.25 306.52	3.91 7.23	3.95 2.58	0.33 78.49	0.90 257.13	0.37 171.35	0.29 220.22	Mag Phase

 $\mu_{\text{Nom}} = 0.13$ 

POINT	MEAN	1/2P-P	1P	2P	3P	4P	5P	6P	7P	8P	9P	10P	
147	-35.50	5.17	1.65 274.93	1.37 90.13	1.81 180.36	1.76 344.53	2.69 345.61	0.97 22.02	0.38 355.61	0.55 36.27	0.23 177.30	0.09 268.20	Mag Phase
148	-35.05	15.38	1.40 306.80	3.28 74.71	4.25 189.73	3.70 320.61	6.33 356.40	1.97 69.62	0.95 68.50	0.75 169.84	0.46 191.86	0.20 246.80	Mag Phase
149	-33.08	22.65	6.79 339.48	6.05 68.96	7.80 166.01	4.72 299.43	4.50 339.76	3.76 136.07	1.02 138.86	0.70 14.17	0.35 203.47	0.21 11.93	Mag Phase

Table III. - Continued

(f) Continued

Run 7

 $\mu_{\text{Nom}} = 0.13$ 

POINT	MEAN	1/2P-P	1P	2P	3P	4P	5P	6P	7P	8P	9P	10P	
150	-28.75	43.16	16.78 357.50	9.25 40.89	14.20 170.30	4.42 286.70	7.51 6.35	9.37 87.00	0.70 277.40	1.97 249.10	1.25 42.11	0.62 128.55	Mag Phase
151	-25.08	41.64	21.47 4.28	12.01 38.74	15.82 171.98	1.41 315.84	4.87 356.59	1.64 52.83	1.93 292.94	2.74 110.27	0.77 153.27	0.72 179.78	Mag Phase
152	-33.44	22.51	6.56 339.86	6.15 69.27	8.13 170.81	4.17 294.78	3.17 345.02	4.64 132.67	0.43 142.29	1.10 164.90	0.39 198.43	0.15 28.68	Mag Phase
153	-35.38	15.68	1.45 311.83	3.51 72.00	4.29 185.10	3.46 323.33	6.11 3.97	3.19 68.01	0.97 117.02	0.94 333.73	0.44 216.75	0.32 278.89	Mag Phase
154	-35.84	5.70	1.64 284.33	1.25 61.09	1.55 173.15	0.85 350.09	3.05 327.25	0.88 102.72	0.41 2.08	0.29 227.95	0.25 163.94	0.10 273.51	Mag Phase
155	-35.43	14.66	1.52 312.56	3.13 69.68	3.94 189.88	3.59 324.39	6.26 358.52	2.25 79.08	0.67 77.33	0.49 149.79	0.33 215.66	0.17 251.37	Mag Phase
156	-33.65	23.51	6.79 340.78	4.81 62.36	8.04 164.24	3.94 287.13	4.00 328.88	6.33 125.18	1.26 64.48	0.27 347.19	0.30 147.44	0.23 337.32	Mag Phase
157	-29.59	42.86	15.74 357.52	8.34 38.97	14.05 173.25	3.82 292.68	10.39 7.21	9.45 92.96	1.07 56.50	2.53 241.34	0.96 35.51	0.51 97.09	Mag Phase
158	-25.58	43.53	20.51 4.23	10.78 36.62	15.51 171.29	1.33 358.04	9.03 2.56	3.47 109.26	2.48 47.51	2.51 131.81	0.74 102.97	0.32 114.45	Mag Phase
159	-33.66	20.27	5.87 340.18	5.12 66.91	7.50 168.84	3.28 295.01	3.08 348.31	3.74 109.28	1.27 80.43	1.51 271.93	0.58 155.43	0.30 343.23	Mag Phase

Table III. - Continued

(f) Continued

Run 7

 $\mu_{\text{Nom}} = 0.13$ 

POINT	MEAN	1/2P-P	1P	2P	3P	4P	5P	6P	7P	8P	9P	10P	
160	-35.48	15.04	1.71 317.40	3.44 66.38	4.22 182.96	3.35 318.86	5.55 355.55	2.98 57.79	0.73 80.19	1.04 252.92	0.26 218.17	0.26 271.76	Mag Phase
161	-35.87	5.36	1.68 297.25	1.45 44.54	1.36 174.09	0.35 12.16	2.83 355.18	1.01 204.86	0.29 25.80	0.86 136.71	0.27 143.06	0.01 49.60	Mag Phase
162	-35.33	12.47	1.95 321.84	2.60 60.54	3.72 186.73	3.06 322.09	5.65 354.33	1.35 79.29	0.49 80.25	1.01 335.98	0.20 192.75	0.10 299.51	Mag Phase
163	-33.76	23.32	6.83 342.75	4.43 53.01	8.12 163.87	3.48 283.21	5.09 311.76	4.46 117.89	1.54 65.15	0.79 313.34	0.51 100.85	0.24 351.61	Mag Phase
164	-29.66	40.60	15.39 355.16	8.10 27.78	14.12 169.37	3.72 283.04	9.58 333.79	8.13 71.31	1.50 47.53	1.79 245.29	1.21 19.66	0.58 81.62	Mag Phase
165	-25.52	44.04	19.79 4.13	10.46 31.00	15.70 173.06	1.88 341.96	9.73 340.46	1.49 94.38	2.51 45.50	0.88 303.86	1.06 67.41	0.51 159.88	Mag Phase
166	-33.82	21.12	6.54 341.23	4.46 57.83	7.89 173.84	3.06 294.63	4.14 336.71	5.21 112.08	1.07 88.05	0.20 113.01	0.46 137.95	0.23 341.45	Mag Phase
167	-35.65	13.16	2.00 317.49	2.59 58.17	3.87 186.49	2.91 324.05	5.33 355.93	2.03 70.85	0.76 94.19	1.02 188.55	0.36 205.03	0.24 256.91	Mag Phase

Table III. - Continued

(f) Continued

Run 7

 $\mu_{\text{Nom}} = 0.16$ 

POINT	MEAN	1/2P-P	1P	2P	3P	4P	5P	6P	7P	8P	9P	10P	
168	-36.03	6.03	2.12 288.85	1.44 46.75	1.31 179.75	0.53 70.88	3.46 352.01	1.18 178.25	0.36 14.50	0.63 8.34	0.10 144.28	0.11 309.62	Mag Phase
169	-35.35	14.10	2.90 308.57	2.84 55.09	3.63 191.89	3.01 327.12	6.12 4.13	2.07 120.41	0.53 72.04	1.30 270.15	0.29 267.74	0.21 287.38	Mag Phase
170	-34.66	29.05	9.28 335.03	4.35 57.59	9.19 165.68	3.74 288.15	5.48 320.04	6.44 137.16	1.07 97.76	1.96 335.10	0.27 92.89	0.28 15.30	Mag Phase
171	-30.39	42.05	18.25 353.03	9.84 31.15	13.80 173.46	3.30 265.77	7.27 8.13	9.48 118.02	1.86 29.79	2.39 332.69	1.51 48.50	0.73 113.68	Mag Phase
172	-26.23	44.55	22.95 3.78	11.74 32.57	15.06 172.87	0.41 263.88	6.23 352.89	2.35 183.99	2.97 87.44	0.70 9.44	0.92 90.61	0.53 147.48	Mag Phase
173	-34.81	25.39	8.41 334.71	4.47 54.80	8.77 167.98	2.98 291.49	4.87 344.28	6.02 125.57	1.13 121.88	1.68 14.85	0.35 129.68	0.23 354.84	Mag Phase
174	-36.42	5.71	2.14 285.39	1.75 45.77	1.32 174.26	0.46 128.92	3.07 359.19	0.99 204.56	0.40 15.10	0.45 59.44	0.17 130.36	0.07 16.85	Mag Phase
175	-36.84	7.94	2.19 283.65	1.81 56.68	1.76 189.04	0.71 5.47	4.66 357.88	0.87 167.81	0.38 2.69	0.48 332.01	0.22 182.58	0.18 280.23	Mag Phase
176	-36.60	17.78	3.37 310.40	3.83 62.98	4.07 192.21	3.60 331.36	6.48 21.86	4.02 130.85	0.64 85.49	0.63 202.30	0.42 267.67	0.26 299.27	Mag Phase
177	-34.75	31.48	9.66 340.56	5.27 65.87	10.23 171.26	5.01 292.72	5.51 338.37	7.37 157.34	1.13 108.36	1.36 321.33	0.24 74.69	0.43 41.88	Mag Phase



Table III. - Continued

Run 7													
(f) Continued													
$\mu_{\text{Nom}} = 0.16$													
POINT	MEAN	1/2P-P	1P	2P	3P	4P	5P	6P	7P	8P	9P	10P	
178	-29.22	44.51	19.89 359.19	11.01 37.68	14.00 174.41	2.22 282.10	5.64 21.44	11.33 143.10	1.38 17.74	2.51 336.40	1.19 69.70	0.47 134.58	Mag Phase
179	-24.73	45.88	24.45 5.26	12.37 31.61	14.20 164.45	0.72 116.06	6.24 337.31	1.31 179.61	1.98 54.14	2.72 87.14	1.05 29.87	0.48 191.69	Mag Phase
180	-34.72	26.29	8.98 334.57	5.94 54.29	8.70 170.03	3.92 279.60	5.97 348.14	4.73 134.85	1.14 100.42	1.28 280.15	0.06 136.02	0.34 18.79	Mag Phase
181	-36.99	7.69	2.08 282.84	1.74 58.99	1.62 186.11	0.96 7.70	4.11 356.60	1.18 166.53	0.41 331.46	0.81 320.95	0.21 216.05	0.17 282.18	Mag Phase
182	-37.21	8.40	2.07 279.38	1.67 66.35	2.27 184.65	1.64 342.61	4.06 345.43	1.23 100.82	0.29 334.10	0.82 8.53	0.21 178.08	0.12 286.62	Mag Phase
183	-36.52	18.49	3.63 313.09	4.04 72.09	4.40 194.15	3.68 325.46	5.63 30.60	4.85 120.04	0.80 109.92	0.96 13.91	0.16 284.80	0.23 349.22	Mag Phase
184	-34.46	29.69	10.63 341.89	6.67 59.24	9.42 171.83	5.00 279.52	6.82 347.02	5.10 130.53	0.65 111.80	0.70 11.02	0.58 319.87	0.48 56.86	Mag Phase
185	-28.63	43.98	21.07 0.98	11.41 41.79	13.78 175.55	1.52 270.52	3.78 11.83	11.46 151.70	0.91 5.28	2.60 12.19	1.56 101.63	0.18 132.93	Mag Phase
186	-24.38	45.12	25.28 6.77	12.84 34.49	14.20 167.33	1.19 114.78	5.93 320.36	0.65 172.78	1.19 16.98	1.78 108.10	0.86 96.05	0.11 123.17	Mag Phase
187	-34.37	27.98	9.63 339.02	7.01 62.92	9.16 174.04	4.32 279.70	5.59 359.57	4.55 130.98	1.06 110.49	0.24 224.84	0.60 295.04	0.46 45.84	Mag Phase
188	-37.33	7.94	2.26 283.13	1.79 61.44	2.01 197.11	1.40 350.71	4.10 355.26	1.24 151.59	0.42 35.64	0.98 88.23	0.23 155.20	0.10 252.29	Mag Phase

Table III. - Continued

(f) Continued

Run 7

$\mu_{Nom} = 0.20$

POINT	MEAN	1/2P-P	1P	2P	3P	4P	5P	6P	7P	8P	9P	10P	
189	-37.65	8.52	3.37 275.24	1.53 74.61	2.33 196.58	1.81 354.51	4.45 346.36	0.91 120.22	0.78 352.43	0.77 222.52	0.39 195.15	0.09 240.38	Mag Phase
190	-37.12	20.96	6.01 304.49	4.69 70.64	4.35 202.10	3.58 335.79	7.04 57.33	3.60 156.77	0.90 91.03	0.96 9.75	0.35 78.74	0.08 51.92	Mag Phase
191	-34.78	39.75	14.32 338.04	7.18 65.47	12.24 177.19	6.05 281.63	8.68 15.40	7.90 152.93	1.93 334.34	0.39 131.33	0.66 42.59	0.35 140.03	Mag Phase
192	-31.84	46.86	19.09 346.91	10.80 44.95	13.33 173.98	5.60 256.52	8.50 53.91	13.83 135.64	1.99 2.87	1.06 287.30	1.54 36.94	0.44 125.15	Mag Phase
193	-27.94	42.78	24.47 356.22	13.55 38.64	14.33 169.89	4.03 222.57	2.30 98.67	9.79 163.70	1.45 323.38	2.21 73.37	1.85 65.78	0.53 149.94	Mag Phase
194	-25.49	44.02	26.75 1.30	13.89 36.83	14.08 169.56	3.19 202.41	2.76 12.42	8.49 159.96	0.64 19.79	0.36 57.88	1.88 70.87	0.53 157.25	Mag Phase
195	-34.97	36.24	13.49 336.00	8.58 60.52	10.11 181.71	5.70 274.33	8.93 22.38	5.13 136.09	0.93 343.38	1.07 73.86	0.37 37.04	0.52 160.61	Mag Phase
196	-37.70	8.10	3.43 276.02	1.86 69.30	2.22 200.51	1.34 12.65	4.30 17.41	0.60 63.81	0.97 359.44	0.42 249.18	0.40 219.50	0.17 292.85	Mag Phase
197	-37.41	7.20	2.98 278.69	1.24 58.12	1.62 189.29	1.06 49.89	4.13 7.44	0.70 132.55	0.92 344.16	0.55 102.01	0.21 204.69	0.17 326.22	Mag Phase
198	-37.22	17.48	5.08 300.39	3.65 57.97	3.58 190.21	2.99 334.33	5.91 25.31	4.21 129.48	0.48 65.24	0.71 100.11	0.18 175.51	0.07 248.72	Mag Phase

Table III. - Continued

Run 7													
(f) Continued													
$\mu_{\text{Nom}} = 0.20$													
POINT	MEAN	1/2P-P	1P	2P	3P	4P	5P	6P	7P	8P	9P	10P	
199	-35.72	32.93	12.69 336.95	5.65 66.14	10.41 177.75	5.16 283.44	6.55 350.04	6.53 146.21	0.18 260.22	0.79 324.70	0.89 117.98	0.36 123.07	Mag Phase
200	-29.60	44.70	22.14 353.38	12.72 37.21	14.08 171.82	4.05 233.54	2.72 21.07	11.70 147.90	0.92 18.00	2.83 33.18	1.46 63.59	0.56 134.00	Mag Phase
201	-24.99	50.24	26.40 4.55	13.24 33.59	13.71 168.42	2.33 211.23	7.96 336.46	4.10 107.52	1.64 209.20	1.76 147.78	1.50 53.75	0.70 142.91	Mag Phase
202	-35.59	28.85	11.90 332.00	5.39 57.93	9.84 174.92	4.36 273.10	6.56 342.57	5.37 119.26	0.41 142.81	1.32 58.90	0.62 121.37	0.31 119.33	Mag Phase
203	-37.64	6.84	3.02 277.62	1.52 56.50	1.60 188.80	1.04 56.76	3.56 9.93	1.34 125.26	0.80 8.61	0.71 312.95	0.25 207.24	0.25 316.45	Mag Phase
204	-37.37	6.76	2.52 276.96	1.38 49.58	1.23 173.50	1.11 85.91	3.98 353.79	0.96 164.46	0.50 333.32	0.04 144.65	0.27 167.48	0.09 286.76	Mag Phase
205	-37.15	15.42	3.95 300.14	3.14 44.74	2.95 184.67	1.85 341.72	7.24 358.23	3.41 114.64	0.38 52.12	0.61 63.36	0.16 217.31	0.22 269.44	Mag Phase
206	-36.02	27.03	10.50 328.67	4.58 54.69	7.62 170.36	3.33 286.30	6.43 343.14	4.71 145.29	1.30 118.83	1.32 324.41	0.41 96.54	0.29 30.56	Mag Phase
207	-31.50	46.83	19.90 348.58	10.77 33.13	12.90 169.19	4.60 225.00	5.63 343.83	15.09 116.80	1.16 20.16	2.62 337.61	1.21 68.05	0.55 132.05	Mag Phase
208	-27.10	52.07	25.40 2.20	12.59 33.46	14.08 170.32	2.98 216.39	10.52 322.35	7.63 147.93	2.22 182.34	0.92 122.45	1.21 30.75	0.73 117.20	Mag Phase
209	-35.95	23.71	10.02 323.44	5.09 54.12	6.54 168.25	3.03 292.05	6.67 358.74	3.94 105.92	1.32 115.67	0.97 350.11	0.22 127.08	0.13 12.36	Mag Phase

Table III. - Continued

(f) Concluded

$\mu_{Nom} = 0.20$

Run 7

POINT	MEAN	1/2P-P	1P	2P	3P	4P	5P	6P	7P	8P	9P	10P	
210	-37.53	14.68	4.28 299.92	2.28 44.37	3.26 191.98	2.55 340.04	7.24 9.43	3.70 70.95	0.60 65.48	1.04 339.96	0.30 224.28	0.29 314.07	Mag Phase

Table III. - Continued

(g) Blade flapwise bending moment, in-lbs., 51.00 percent radius

Run 7

$\mu_{Nom} = 0.06$

POINT	MEAN	1/2P-P	1P	2P	3P	4P	5P	6P	7P	8P	9P	10P	
126	24.69	14.84	7.48 273.35	3.45 124.57	7.00 289.78	0.57 278.96	0.91 122.58	0.93 73.64	0.22 106.97	2.07 159.05	0.32 118.40	0.07 302.97	Mag Phase

$\mu_{Nom} = 0.07$

POINT	MEAN	1/2P-P	1P	2P	3P	4P	5P	6P	7P	8P	9P	10P	
127	28.10	21.07	10.38 271.69	5.19 131.49	10.09 294.32	0.96 271.27	1.36 134.63	1.51 81.33	0.18 54.70	2.86 147.37	0.33 99.76	0.11 298.65	Mag Phase

$\mu_{Nom} = 0.08$

POINT	MEAN	1/2P-P	1P	2P	3P	4P	5P	6P	7P	8P	9P	10P	
128	31.77	24.63	12.57 268.81	5.02 126.29	12.43 290.12	1.32 271.78	1.57 117.80	1.78 69.74	0.17 330.33	2.53 125.71	0.30 98.06	0.04 234.05	Mag Phase
128A	34.14	29.75	13.63 270.46	5.95 139.32	14.21 279.25	1.41 249.40	1.26 113.13	1.94 66.32	0.88 355.16	4.11 130.29	0.48 75.34	0.10 278.64	Mag Phase

$\mu_{Nom} = 0.09$

POINT	MEAN	1/2P-P	1P	2P	3P	4P	5P	6P	7P	8P	9P	10P	
129	34.55	31.44	12.98 273.89	6.04 157.41	14.40 276.95	1.62 233.11	1.05 103.27	1.88 64.78	1.06 341.07	5.74 124.48	0.60 75.41	0.12 279.12	Mag Phase
130	25.15	15.66	7.32 276.85	4.09 143.59	6.89 288.15	0.47 253.37	1.04 117.88	0.75 78.27	0.35 261.70	2.52 146.38	0.14 96.72	0.13 312.41	Mag Phase

Table III. - Continued

(g) Continued

Run 7

 $\mu_{\text{Nom}} = 0.09$ 

POINT	MEAN	1/2P-P	1P	2P	3P	4P	5P	6P	7P	8P	9P	10P	
131	28.55	20.76	10.10 272.75	5.20 139.26	9.48 288.67	0.72 269.72	1.23 117.31	1.08 82.41	0.20 310.92	2.77 144.11	0.21 66.23	0.12 283.08	Mag Phase
132	31.86	24.29	11.85 269.19	5.92 132.61	11.77 281.90	0.86 262.19	1.38 109.97	1.23 69.62	0.49 278.87	2.58 114.16	0.10 9.33	0.14 181.35	Mag Phase
133	33.85	28.06	12.62 272.64	6.22 144.05	13.10 276.05	0.92 259.50	1.07 97.55	1.64 66.88	0.47 313.91	3.92 128.57	0.22 60.70	0.07 238.14	Mag Phase
134	25.17	15.75	7.39 277.64	4.15 144.73	6.95 289.61	0.45 259.61	1.09 119.73	0.76 81.43	0.36 268.04	2.53 149.12	0.14 101.16	0.13 314.25	Mag Phase
135	25.35	13.72	6.88 279.83	3.84 145.54	5.94 297.01	0.26 266.73	0.83 141.46	0.50 95.40	0.22 301.72	1.71 165.95	0.12 84.44	0.03 0.91	Mag Phase
136	28.71	17.83	9.44 273.04	4.76 140.41	8.20 288.98	0.49 270.97	0.86 123.61	0.72 78.50	0.20 31.64	1.48 132.05	0.28 79.57	0.03 150.18	Mag Phase
137	32.08	21.22	11.27 270.78	5.65 142.25	10.09 283.68	0.56 269.69	0.79 115.43	0.78 73.36	0.32 24.96	1.10 119.48	0.24 81.56	0.12 113.81	Mag Phase
138	33.99	23.62	11.79 274.34	6.09 154.37	11.32 278.71	0.51 256.33	0.74 68.16	0.90 81.82	0.35 69.28	1.24 139.65	0.24 92.78	0.10 99.27	Mag Phase
139	28.82	17.71	9.36 274.46	4.81 142.97	8.26 290.90	0.50 277.37	0.79 129.20	0.67 80.56	0.20 36.82	1.32 139.77	0.24 89.56	0.06 139.04	Mag Phase
140	25.34	13.70	6.85 280.64	3.81 146.41	5.98 296.71	0.25 285.32	0.80 137.76	0.49 94.05	0.25 314.82	1.71 167.22	0.12 109.59	0.02 214.32	Mag Phase

Table III. - Continued

(g) Continued

Run 7

 $\mu_{\text{Nom}} = 0.09$ 

POINT	MEAN	1/2P-P	1P	2P	3P	4P	5P	6P	7P	8P	9P	10P	
141	24.74	17.32	7.50 277.55	4.15 155.55	7.66 289.84	0.62 261.36	1.15 128.59	1.07 77.82	0.41 275.68	3.39 145.14	0.12 93.19	0.16 295.40	Mag Phase
142	28.00	23.31	10.30 274.03	5.58 143.86	11.16 288.88	1.04 265.55	1.53 120.20	1.58 78.55	0.29 288.39	3.95 142.74	0.14 84.83	0.23 295.10	Mag Phase
143	31.37	26.50	12.20 271.55	6.10 136.66	13.70 286.70	1.21 266.00	1.78 114.85	1.96 70.83	0.50 274.18	3.45 120.55	0.16 202.14	0.13 227.87	Mag Phase
144	33.70	31.08	13.21 273.50	6.23 148.40	14.74 278.69	1.44 253.12	1.34 106.21	2.00 66.41	0.76 334.19	5.36 127.77	0.52 83.29	0.16 247.89	Mag Phase
145	28.01	23.21	10.27 272.82	5.51 141.61	10.99 284.90	1.04 262.89	1.53 112.42	1.56 69.89	0.25 273.26	4.09 129.14	0.17 82.18	0.20 269.84	Mag Phase
146	24.74	17.34	7.45 278.90	4.17 156.52	7.59 290.62	0.58 265.05	1.12 129.10	0.99 82.61	0.44 268.12	3.47 145.49	0.16 95.88	0.17 282.27	Mag Phase

 $\mu_{\text{Nom}} = 0.13$ 

POINT	MEAN	1/2P-P	1P	2P	3P	4P	5P	6P	7P	8P	9P	10P	
147	22.46	7.50	2.72 297.54	3.49 198.83	3.95 308.16	0.55 281.80	0.30 149.40	0.32 85.38	0.22 12.99	1.04 186.67	0.05 74.33	0.10 284.89	Mag Phase
148	25.09	13.61	4.90 283.77	5.46 185.37	7.29 297.22	0.62 267.72	0.67 145.08	0.94 76.70	0.68 9.23	2.00 158.74	0.23 64.25	0.24 278.44	Mag Phase
149	27.80	19.41	7.33 279.03	6.91 178.04	10.32 291.24	0.81 270.95	1.02 146.90	1.53 74.83	1.08 11.11	2.84 141.58	0.47 50.78	0.42 280.19	Mag Phase

Table III. - Continued

(g) Continued

Run 7

 $\mu_{\text{Nom}} = 0.13$ 

POINT	MEAN	1/2P-P	1P	2P	3P	4P	5P	6P	7P	8P	9P	10P	
150	30.28	24.59	9.23 275.74	6.76 171.08	12.31 280.09	0.71 261.09	1.28 143.41	1.66 59.23	0.99 347.49	4.55 129.99	0.57 46.55	0.58 268.44	Mag Phase
151	31.34	26.39	9.77 277.16	6.40 168.27	12.73 274.83	0.79 224.09	1.48 141.43	1.64 55.88	0.97 339.05	5.07 122.38	0.68 46.34	0.49 258.91	Mag Phase
152	27.98	19.66	7.41 280.00	6.79 179.28	10.48 292.94	0.81 274.66	1.03 150.66	1.51 77.66	1.00 10.53	3.03 144.08	0.41 52.87	0.40 284.37	Mag Phase
153	25.19	14.01	5.00 284.55	5.54 185.42	7.41 296.64	0.62 266.45	0.65 147.99	0.92 79.46	0.67 10.91	2.12 156.72	0.31 65.81	0.25 279.14	Mag Phase
154	22.72	7.60	2.63 305.23	3.34 186.65	3.88 303.65	0.43 283.38	0.20 149.10	0.28 84.85	0.16 333.37	1.06 159.48	0.02 287.97	0.15 274.19	Mag Phase
155	25.52	13.98	4.85 287.34	5.22 179.73	6.97 296.87	0.53 279.14	0.70 139.05	0.82 79.83	0.63 334.87	2.55 154.55	0.11 71.25	0.23 283.74	Mag Phase
156	28.34	18.98	7.13 280.08	6.58 169.82	9.91 288.31	0.67 274.63	1.16 124.59	1.17 68.20	0.76 303.52	3.18 127.59	0.05 49.81	0.39 243.69	Mag Phase
157	31.17	23.29	9.02 278.51	7.07 166.19	12.03 283.91	0.55 261.47	1.45 127.88	1.29 61.42	0.95 298.60	3.53 134.89	0.09 172.41	0.49 247.66	Mag Phase
158	32.11	24.43	9.81 278.08	6.56 164.14	12.38 275.33	0.53 205.82	1.59 113.52	1.42 50.83	1.05 294.27	3.22 134.96	0.18 147.53	0.52 229.67	Mag Phase
159	28.41	19.02	7.20 280.92	6.46 172.66	9.88 290.99	0.69 279.92	1.16 127.60	1.14 78.70	0.79 306.18	3.19 136.10	0.04 216.30	0.36 258.98	Mag Phase



Table III. - Continued

(g) Continued

Run 7

 $\mu_{\text{Nom}} = 0.13$ 

POINT	MEAN	1/2P-P	1P	2P	3P	4P	5P	6P	7P	8P	9P	10P	
160	25.84	14.67	5.13 286.04	5.45 176.19	7.32 292.61	0.53 273.58	0.77 134.14	0.88 73.97	0.57 326.17	2.67 140.21	0.17 38.70	0.25 264.65	Mag Phase
161	23.22	7.66	2.73 308.23	3.22 177.00	3.77 306.81	0.39 284.46	0.27 123.06	0.19 65.86	0.25 279.92	0.98 154.94	0.11 307.65	0.10 270.11	Mag Phase
162	26.15	13.55	4.79 287.44	5.08 168.95	6.78 296.64	0.41 271.88	0.79 129.82	0.60 69.42	0.54 280.47	2.08 142.91	0.16 291.92	0.20 278.88	Mag Phase
163	29.08	18.19	7.08 278.99	6.54 160.81	9.72 286.24	0.45 258.70	1.27 110.61	0.87 63.53	0.62 254.18	2.35 107.97	0.18 237.86	0.23 239.53	Mag Phase
164	31.89	21.07	8.97 275.14	6.95 154.22	11.76 278.57	0.45 238.67	1.42 102.67	1.07 40.29	0.80 245.70	1.91 98.74	0.22 209.66	0.21 237.08	Mag Phase
165	32.82	22.48	9.56 276.22	6.60 157.62	12.18 276.54	0.54 200.76	1.60 103.86	1.13 42.44	0.99 240.08	1.89 113.75	0.17 146.35	0.18 221.54	Mag Phase
166	29.26	17.82	7.04 281.85	6.43 165.01	9.60 294.42	0.45 265.55	1.21 124.49	0.77 80.81	0.76 271.21	2.02 130.03	0.21 262.59	0.26 279.07	Mag Phase
167	26.17	13.56	4.80 288.93	5.60 168.07	6.75 296.56	0.34 278.33	0.80 127.86	0.44 79.26	0.55 277.72	1.88 144.86	0.19 285.67	0.17 262.18	Mag Phase

Table III. - Continued

(g) Continued

Run 7

 $\mu_{\text{Nom}} = 0.16$ 

POINT	MEAN	1/2P-P	1P	2P	3P	4P	5P	6P	7P	8P	9P	10P	
168	23.34	7.11	2.16 336.96	3.47 186.58	3.55 315.83	0.61 283.44	0.15 182.15	0.13 83.45	0.06 224.50	0.89 167.57	0.03 48.85	0.05 267.02	Mag Phase
169	26.30	12.30	3.10 304.89	5.81 177.99	6.45 303.41	0.71 260.06	0.68 140.74	0.41 67.44	0.29 244.80	2.15 134.29	0.06 330.88	0.16 264.18	Mag Phase
170	29.15	17.94	4.80 290.41	7.81 171.48	9.50 293.25	0.77 239.09	1.12 120.88	0.73 59.52	0.62 239.09	3.28 115.47	0.15 231.46	0.23 236.43	Mag Phase
171	31.80	21.27	6.58 282.74	7.92 167.85	10.79 282.22	0.87 197.50	1.47 119.05	0.88 50.82	1.13 226.41	4.46 113.06	0.27 201.55	0.21 230.52	Mag Phase
172	32.71	23.54	7.60 280.17	7.32 165.70	11.20 274.99	1.32 182.53	1.68 113.95	0.88 39.83	1.58 236.03	4.64 119.45	0.30 166.73	0.20 213.88	Mag Phase
173	29.27	17.53	4.81 291.99	7.76 172.04	9.37 293.95	0.75 238.26	1.11 123.70	0.71 61.09	0.65 237.51	2.93 116.00	0.18 273.52	0.21 242.96	Mag Phase
174	23.37	7.01	2.12 337.73	3.42 187.99	3.47 317.78	0.64 292.62	0.19 189.72	0.10 76.72	0.04 239.52	0.80 175.74	0.02 16.40	0.10 260.49	Mag Phase
175	23.28	7.30	1.83 332.30	3.80 192.64	4.06 314.50	0.61 288.14	0.19 169.67	0.18 96.50	0.18 142.16	0.79 159.55	0.03 119.02	0.06 241.88	Mag Phase
176	26.04	12.86	3.14 300.11	6.14 184.76	7.24 303.43	0.72 269.86	0.56 155.88	0.49 92.73	0.21 159.35	2.41 135.24	0.19 99.85	0.11 254.46	Mag Phase
177	28.79	18.92	5.01 289.49	7.88 178.20	10.25 296.64	0.71 245.85	1.09 139.40	0.87 87.16	0.42 217.05	3.80 140.71	0.32 155.01	0.20 258.93	Mag Phase

Table III. - Continued

Run 7													
(g) Continued													
$\mu_{\text{Nom}} = 0.16$													
POINT	MEAN	1/2P-P	1P	2P	3P	4P	5P	6P	7P	8P	9P	10P	
178	31.29	24.38	7.01 281.90	7.28 170.20	11.17 278.36	1.05 183.84	1.35 135.15	0.86 85.21	1.22 210.48	5.66 131.83	0.53 137.69	0.22 251.05	Mag Phase
179	32.01	26.00	7.96 277.38	7.00 164.47	11.13 263.95	1.65 170.03	1.53 119.43	0.80 62.81	1.23 197.86	5.89 109.73	0.50 107.22	0.27 231.69	Mag Phase
180	28.96	18.70	5.02 287.58	7.67 173.91	10.25 289.99	0.74 238.55	1.08 132.36	0.81 75.29	0.58 211.72	3.75 119.44	0.19 128.17	0.25 237.33	Mag Phase
181	23.21	7.28	1.92 331.55	3.78 190.30	3.98 310.84	0.66 287.43	0.14 185.57	0.16 71.27	0.15 127.07	0.77 152.54	0.04 138.32	0.08 222.60	Mag Phase
182	23.05	7.44	1.73 316.62	3.94 198.31	4.38 308.59	0.72 284.33	0.29 185.66	0.21 109.14	0.20 94.02	0.76 168.41	0.07 89.22	0.02 1.07	Mag Phase
183	25.67	12.51	3.30 293.13	6.27 192.69	7.44 305.36	0.78 275.64	0.59 165.00	0.59 91.43	0.28 71.21	1.88 147.50	0.38 111.10	0.05 126.42	Mag Phase
184	28.32	18.01	5.40 280.88	7.87 180.79	10.43 292.03	0.82 245.17	0.98 156.43	0.91 82.60	0.15 78.88	2.66 122.72	0.44 102.83	0.18 249.90	Mag Phase
185	30.63	24.25	7.37 279.46	6.92 171.21	11.25 278.30	1.11 195.13	1.32 162.93	0.94 90.16	0.43 223.78	4.79 150.36	0.75 117.62	0.32 302.59	Mag Phase
186	31.36	25.50	8.06 276.24	6.92 163.39	11.15 266.35	1.60 182.69	1.43 154.56	0.87 69.85	0.46 211.85	5.05 132.27	0.68 93.62	0.42 273.45	Mag Phase
187	28.48	18.09	5.44 283.74	7.89 181.58	10.55 293.03	0.85 246.67	1.00 158.90	0.92 83.98	0.06 8.83	2.54 129.29	0.40 119.44	0.20 252.14	Mag Phase
188	23.05	7.70	1.86 320.02	3.89 201.07	4.30 314.48	0.72 295.26	0.36 193.40	0.21 107.92	0.25 102.95	0.91 191.96	0.13 116.94	0.07 265.64	Mag Phase

Table III. - Continued

(g) Continued

Run 7

 $\mu_{\text{Nom}} = 0.20$ 

POINT	MEAN	1/2P-P	1P	2P	3P	4P	5P	6P	7P	8P	9P	10P	
189	23.21	8.21	1.62 14.28	3.84 206.08	4.24 317.11	0.82 303.38	0.19 230.79	0.17 124.58	0.12 231.50	0.99 222.84	0.24 193.23	0.12 222.36	Mag Phase
190	26.30	13.11	2.01 334.71	6.36 201.92	7.33 310.77	0.98 301.22	0.29 162.42	0.29 126.61	0.45 213.17	1.05 218.56	0.20 188.41	0.14 268.49	Mag Phase
191	29.13	17.22	3.11 302.58	8.29 189.68	10.00 295.09	0.82 280.81	0.53 151.15	0.52 133.10	1.16 223.08	2.66 175.21	0.35 149.78	0.24 249.11	Mag Phase
192	30.36	19.53	4.09 294.69	7.59 181.81	10.12 278.90	0.27 233.31	0.88 149.33	0.84 144.73	1.60 210.45	3.95 160.86	0.45 138.10	0.34 242.90	Mag Phase
193	31.39	23.08	5.16 289.48	6.98 171.89	10.69 265.38	0.56 176.38	1.19 151.38	0.93 145.43	2.12 210.28	5.35 155.46	0.39 136.50	0.40 233.77	Mag Phase
194	31.68	22.86	5.82 286.58	6.70 171.05	10.46 261.11	0.48 181.80	1.35 141.80	0.95 146.09	2.31 211.37	4.78 158.68	0.27 190.11	0.39 235.06	Mag Phase
195	29.27	17.80	3.26 303.18	8.24 190.55	10.10 297.46	0.87 282.87	0.61 169.04	0.50 129.19	1.07 246.91	3.39 186.47	0.27 132.29	0.30 278.62	Mag Phase
196	23.29	8.35	1.73 15.72	3.73 207.74	4.11 320.98	0.82 311.94	0.19 232.63	0.11 119.32	0.07 196.40	1.19 244.68	0.22 211.65	0.14 246.28	Mag Phase
197	23.44	7.64	2.20 16.81	3.29 202.66	3.38 322.58	0.92 317.40	0.27 228.22	0.03 122.59	0.06 298.71	1.56 244.17	0.20 192.35	0.15 263.35	Mag Phase
198	26.35	12.89	2.09 341.04	5.89 192.16	6.42 306.08	1.03 300.93	0.45 156.35	0.48 93.99	0.31 266.43	2.33 192.50	0.15 84.96	0.23 287.82	Mag Phase

Table III. - Continued

Run 7													
(g) Continued													
$\mu_{\text{Nom}} = 0.20$													
POINT	MEAN	1/2P-P	1P	2P	3P	4P	5P	6P	7P	8P	9P	10P	
199	29.25	18.26	3.13 312.53	8.19 188.05	9.63 300.91	0.99 301.35	0.91 149.33	0.80 106.95	1.02 265.28	4.01 189.63	0.35 115.38	0.35 305.55	Mag Phase
200	31.87	21.88	4.88 295.40	7.50 172.71	10.16 269.71	0.27 225.86	1.53 131.39	0.83 103.14	2.05 231.38	6.01 160.23	0.40 113.66	0.50 255.69	Mag Phase
201	32.48	22.53	5.81 286.77	7.03 169.78	9.63 260.08	0.24 222.15	1.72 121.96	0.70 91.86	2.41 222.29	6.21 151.81	0.17 146.53	0.48 243.49	Mag Phase
202	29.39	18.03	3.14 313.59	8.09 184.44	9.53 296.38	1.04 299.44	0.92 145.47	0.77 97.87	0.96 256.25	3.73 180.53	0.31 93.67	0.34 286.16	Mag Phase
203	23.43	7.53	2.18 18.86	3.22 203.64	3.29 324.62	0.86 318.86	0.25 241.23	0.08 103.50	0.03 288.04	1.50 245.13	0.13 188.53	0.08 281.28	Mag Phase
204	23.53	6.83	2.47 16.55	2.94 197.04	2.78 322.69	0.85 311.98	0.32 235.22	0.05 244.68	0.07 50.35	1.22 231.82	0.09 174.29	0.13 231.04	Mag Phase
205	26.54	11.08	2.40 355.56	5.48 187.66	5.39 306.76	1.13 298.85	0.46 178.76	0.34 88.12	0.37 295.65	1.82 178.47	0.13 74.78	0.20 250.58	Mag Phase
206	29.62	15.78	2.77 326.29	7.58 183.80	8.21 298.45	1.26 297.92	0.68 157.40	0.66 84.77	0.84 278.70	2.76 169.08	0.11 16.82	0.30 260.87	Mag Phase
207	32.54	18.70	4.10 302.61	7.83 174.40	8.99 270.99	0.61 291.90	1.14 136.74	0.90 73.76	1.09 247.43	4.08 148.41	0.16 13.78	0.42 234.61	Mag Phase
208	33.40	20.08	5.20 291.29	7.34 174.17	9.37 263.47	0.66 254.09	1.39 130.21	0.74 60.51	1.65 254.40	4.83 149.78	0.05 84.07	0.42 222.67	Mag Phase
209	29.71	15.35	2.82 328.43	7.50 180.19	8.06 295.27	1.18 295.41	0.71 152.55	0.66 83.16	0.67 269.78	2.34 155.40	0.13 344.31	0.29 247.82	Mag Phase

Table III. - Continued

Run 7													
(g) Concluded													
$\mu_{Nom} = 0.20$													
POINT	MEAN	1/2P-P	1P	2P	3P	4P	5P	6P	7P	8P	9P	10P	
210	26.63	11.12	2.37 357.23	5.55 189.14	5.51 311.52	1.09 303.30	0.38 178.78	0.32 93.36	0.34 300.46	1.64 189.36	0.04 113.80	0.20 256.30	Mag Phase

Table III. - Continued

(h) Blade torsional moment, in-lbs., 60.00 percent radius

Run 7

$\mu_{Nom} = 0.06$

POINT	MEAN	1/2P-P	1P	2P	3P	4P	5P	6P	7P	8P	9P	10P	
126	3.67	3.28	0.99 5.26	1.36 97.72	0.97 135.80	0.27 168.43	1.07 242.20	0.65 142.21	0.17 332.47	0.03 290.34	0.09 261.71	0.02 28.89	Mag Phase

$\mu_{Nom} = 0.07$

POINT	MEAN	1/2P-P	1P	2P	3P	4P	5P	6P	7P	8P	9P	10P	
127	5.77	5.24	1.29 16.03	2.55 98.89	0.99 128.03	0.80 177.40	1.50 225.08	0.66 163.66	0.28 0.93	0.11 20.21	0.13 6.32	0.02 133.59	Mag Phase

$\mu_{Nom} = 0.08$

POINT	MEAN	1/2P-P	1P	2P	3P	4P	5P	6P	7P	8P	9P	10P	
128	8.05	7.17	1.76 21.39	3.49 81.31	0.93 121.53	1.33 178.17	1.90 215.88	0.70 171.67	0.40 320.67	0.13 2.15	0.14 353.00	0.02 73.89	Mag Phase
128A	9.30	10.10	3.29 21.25	3.97 70.94	1.01 352.90	2.04 215.20	2.72 252.91	1.26 278.59	0.56 350.92	0.25 229.86	0.16 284.39	0.14 260.37	Mag Phase

$\mu_{Nom} = 0.09$

POINT	MEAN	1/2P-P	1P	2P	3P	4P	5P	6P	7P	8P	9P	10P	
129	9.21	11.94	4.45 18.90	3.20 58.41	1.96 331.77	2.63 250.96	3.23 281.88	1.90 269.15	1.32 301.80	0.54 253.18	0.31 283.27	0.18 263.79	Mag Phase
130	4.52	3.30	1.11 3.79	1.63 109.19	0.60 126.01	0.44 182.33	1.14 235.00	0.44 148.97	0.18 358.99	0.01 38.92	0.04 304.76	0.06 107.28	Mag Phase

Table III. - Continued

(h) Continued

Run 7

 $\mu_{\text{Nom}} = 0.09$ 

POINT	MEAN	1/2P-P	1P	2P	3P	4P	5P	6P	7P	8P	9P	10P	
131	6.57	5.02	1.39 9.07	2.75 100.41	0.68 124.92	0.81 185.26	1.34 225.37	0.38 171.40	0.31 6.38	0.03 104.28	0.08 1.19	0.03 87.61	Mag Phase
132	8.66	6.33	1.80 14.93	3.78 82.40	0.52 112.26	1.03 185.86	1.48 208.88	0.51 194.58	0.35 331.75	0.06 283.63	0.14 341.58	0.04 88.39	Mag Phase
133	8.94	8.53	4.01 32.10	3.08 84.76	1.27 349.94	1.67 204.73	2.02 241.78	1.45 252.67	0.83 325.24	0.13 240.05	0.09 350.09	0.11 248.82	Mag Phase
134	4.70	3.36	1.16 4.36	1.65 110.00	0.56 127.95	0.47 187.77	1.17 237.06	0.42 151.05	0.20 3.84	0.02 60.70	0.03 309.96	0.06 116.62	Mag Phase
135	4.50	2.91	1.12 8.35	1.59 113.45	0.44 130.22	0.39 204.77	0.82 251.39	0.17 156.82	0.12 30.05	0.04 135.56	0.02 338.81	0.03 121.13	Mag Phase
136	6.45	4.37	1.39 13.00	2.65 100.76	0.50 119.11	0.79 187.41	0.83 227.33	0.04 187.27	0.11 45.53	0.09 39.34	0.05 345.80	0.03 67.90	Mag Phase
137	8.57	5.52	1.78 19.33	3.58 86.45	0.39 107.32	1.02 185.15	0.83 211.58	0.48 242.73	0.20 14.92	0.12 296.32	0.14 358.78	0.05 79.21	Mag Phase
138	8.64	7.11	4.25 39.72	2.87 95.35	0.74 10.59	1.21 204.83	1.18 192.27	1.93 269.97	0.80 356.51	0.15 308.68	0.14 58.13	0.06 218.18	Mag Phase
139	6.65	4.43	1.46 13.58	2.68 102.47	0.50 119.82	0.81 189.71	0.81 231.48	0.05 196.41	0.16 39.28	0.07 56.60	0.03 349.22	0.03 111.69	Mag Phase
140	4.61	2.89	1.15 8.37	1.58 113.10	0.43 130.39	0.41 204.40	0.80 251.11	0.21 161.81	0.10 17.93	0.06 116.42	0.02 355.18	0.04 101.25	Mag Phase



Table III. - Continued

(h) Continued

Run 7

 $\mu_{\text{Nom}} = 0.09$ 

POINT	MEAN	1/2P-P	1P	2P	3P	4P	5P	6P	7P	8P	9P	10P	
141	4.92	3.44	1.17 4.88	1.74 110.11	0.65 117.89	0.45 176.72	1.25 240.53	0.60 144.66	0.19 355.12	0.01 33.65	0.02 5.22	0.05 101.05	Mag Phase
142	6.94	5.78	1.47 8.70	3.03 99.19	0.77 115.65	0.90 183.60	1.87 221.74	0.64 159.10	0.34 4.96	0.07 315.42	0.11 340.99	0.03 85.00	Mag Phase
143	8.96	7.37	2.00 17.67	4.13 81.13	0.54 111.67	1.32 188.38	1.88 218.48	0.70 194.62	0.49 345.52	0.13 322.56	0.19 345.39	0.04 133.46	Mag Phase
144	9.48	10.50	3.82 23.03	3.32 68.76	1.60 349.31	2.39 218.82	2.89 260.61	1.50 254.90	0.83 329.69	0.35 239.84	0.19 296.60	0.16 258.64	Mag Phase
145	6.98	5.79	1.49 7.53	2.97 96.76	0.79 111.89	1.00 179.07	1.79 214.10	0.66 153.04	0.35 357.02	0.08 350.84	0.10 336.10	0.03 78.24	Mag Phase
146	5.00	3.43	1.19 4.32	1.73 111.92	0.66 118.41	0.48 181.62	1.21 239.50	0.63 150.59	0.19 352.09	0.03 94.20	0.03 30.21	0.07 111.99	Mag Phase

 $\mu_{\text{Nom}} = 0.13$ 

POINT	MEAN	1/2P-P	1P	2P	3P	4P	5P	6P	7P	8P	9P	10P	
147	3.76	1.78	1.11 11.49	0.81 140.92	0.43 120.98	0.44 136.23	0.32 221.45	0.29 150.25	0.10 55.19	0.03 77.36	0.04 62.43	0.04 97.87	Mag Phase
148	5.71	3.48	1.52 13.64	1.87 131.64	0.97 91.58	0.73 159.74	0.72 216.08	0.37 127.97	0.20 359.05	0.12 55.10	0.09 66.51	0.08 92.13	Mag Phase
149	7.91	5.54	1.85 14.05	3.13 117.66	1.47 76.19	1.13 167.71	1.36 217.01	0.44 113.30	0.37 352.69	0.13 11.67	0.09 41.23	0.06 45.37	Mag Phase

Table III. - Continued

(h) Continued

Run 7

 $\mu_{\text{Nom}} = 0.13$ 

POINT	MEAN	1/2P-P	1P	2P	3P	4P	5P	6P	7P	8P	9P	10P	
150	10.13	6.96	2.59 12.47	4.09 87.03	1.46 10.55	1.58 209.04	1.43 232.22	0.46 269.14	0.39 335.83	0.06 14.97	0.05 77.90	0.02 268.78	Mag Phase
151	10.43	9.55	3.60 14.26	4.15 74.85	2.41 346.35	2.33 257.56	1.62 282.34	0.64 298.40	0.45 331.62	0.26 265.32	0.16 311.42	0.09 311.66	Mag Phase
152	8.10	5.66	1.91 15.03	3.17 118.28	1.45 73.72	1.27 177.88	1.36 219.84	0.37 112.34	0.31 358.42	0.15 18.80	0.06 52.99	0.05 40.03	Mag Phase
153	5.87	3.53	1.56 13.06	1.88 133.01	0.98 94.52	0.72 158.91	0.74 218.76	0.40 133.04	0.25 0.25	0.10 57.87	0.10 71.14	0.07 98.07	Mag Phase
154	3.61	1.69	1.24 11.49	0.71 136.30	0.30 137.35	0.39 148.79	0.30 233.48	0.20 165.47	0.03 31.83	0.05 132.81	0.03 121.70	0.04 104.50	Mag Phase
155	5.55	3.38	1.54 12.00	1.84 128.24	0.74 95.19	0.65 174.78	0.85 236.50	0.24 139.43	0.23 347.73	0.10 83.45	0.07 104.11	0.06 79.18	Mag Phase
156	7.68	5.41	1.86 12.47	3.09 111.05	1.03 72.58	1.07 173.25	1.40 220.29	0.24 64.63	0.35 322.47	0.09 51.38	0.03 31.11	0.03 51.64	Mag Phase
157	9.97	6.67	2.58 14.95	4.20 89.26	1.06 7.43	1.47 211.35	1.28 239.98	0.52 318.04	0.44 331.09	0.20 26.12	0.00 261.94	0.02 280.54	Mag Phase
158	10.17	9.37	3.59 13.99	4.05 73.44	2.05 333.09	2.42 256.32	1.69 270.37	0.84 290.40	0.67 290.80	0.27 300.36	0.15 278.04	0.08 316.43	Mag Phase
159	7.76	5.33	1.90 13.34	3.06 114.13	1.03 72.47	1.09 181.24	1.36 226.98	0.22 103.11	0.34 332.49	0.09 64.61	0.05 23.53	0.03 76.36	Mag Phase

Table III. - Continued

(h) Continued

Run 7

 $\mu_{\text{Nom}} = 0.13$ 

POINT	MEAN	1/2P-P	1P	2P	3P	4P	5P	6P	7P	8P	9P	10P	
160	5.82	3.61	1.61 10.38	2.00 125.91	0.79 90.82	0.70 170.37	0.91 230.76	0.27 136.52	0.26 333.31	0.10 70.65	0.09 74.83	0.06 72.96	Mag Phase
161	3.52	1.59	1.25 11.57	0.73 128.30	0.13 165.01	0.36 154.56	0.37 237.94	0.07 137.60	0.05 26.58	0.05 139.70	0.02 101.78	0.03 99.94	Mag Phase
162	5.48	3.31	1.52 11.74	1.92 122.30	0.46 94.57	0.58 171.15	0.90 236.42	0.15 95.37	0.19 350.92	0.15 109.40	0.05 86.80	0.03 87.50	Mag Phase
163	7.67	5.06	1.89 10.82	3.16 108.18	0.70 64.44	0.79 180.68	1.42 222.75	0.27 11.51	0.27 318.39	0.15 66.87	0.03 18.32	0.05 66.93	Mag Phase
164	9.90	6.68	2.66 13.90	4.27 85.63	0.81 352.77	1.24 211.83	1.14 233.68	0.74 327.51	0.31 328.09	0.20 22.88	0.03 86.61	0.02 315.44	Mag Phase
165	9.85	9.82	3.88 18.46	3.98 79.12	1.70 332.98	2.08 257.14	1.94 284.09	1.27 345.76	0.43 307.66	0.18 354.79	0.14 272.37	0.08 302.46	Mag Phase
166	7.84	5.05	1.95 13.67	3.13 113.72	0.67 70.21	0.86 196.44	1.36 236.91	0.23 20.99	0.24 341.53	0.13 74.70	0.04 78.42	0.04 97.56	Mag Phase
167	5.52	3.31	1.58 11.61	1.92 124.74	0.46 99.84	0.60 177.07	0.89 238.10	0.14 109.67	0.15 336.93	0.11 93.65	0.05 58.72	0.05 93.42	Mag Phase

Table III. - Continued

(h) Continued

Run 7

 $\mu_{\text{Nom}} = 0.16$ 

POINT	MEAN	1/2P-P	1P	2P	3P	4P	5P	6P	7P	8P	9P	10P	
168	3.51	1.61	1.45 12.16	0.56 133.43	0.11 219.97	0.42 143.15	0.16 226.35	0.13 155.33	0.06 99.74	0.08 148.75	0.02 96.68	0.05 106.99	Mag Phase
169	5.52	3.05	1.81 17.36	1.79 128.11	0.49 72.67	0.52 160.48	0.67 227.85	0.22 81.01	0.11 347.29	0.20 109.46	0.04 58.27	0.07 105.83	Mag Phase
170	7.87	4.69	2.22 16.35	3.20 113.94	1.04 38.43	0.70 187.83	1.19 226.24	0.33 16.71	0.27 311.11	0.20 103.21	0.02 32.36	0.09 89.85	Mag Phase
171	10.00	7.87	3.13 14.16	4.09 87.05	2.24 344.46	1.71 246.88	1.39 246.18	0.79 328.41	0.32 294.45	0.13 99.63	0.11 264.51	0.03 65.85	Mag Phase
172	10.09	10.81	4.11 12.22	4.15 70.89	3.35 335.99	2.67 279.18	1.91 302.51	1.59 343.32	0.92 323.50	0.23 357.76	0.26 306.92	0.10 28.01	Mag Phase
173	7.98	4.77	2.29 17.66	3.22 114.92	1.09 37.15	0.69 194.84	1.18 227.97	0.38 1.52	0.25 324.11	0.16 100.73	0.04 3.86	0.09 97.25	Mag Phase
174	3.64	1.68	1.46 13.51	0.53 130.52	0.14 236.23	0.50 150.64	0.13 229.31	0.14 146.30	0.09 102.24	0.06 154.89	0.00 85.57	0.05 117.72	Mag Phase
175	4.08	2.03	1.47 14.21	0.65 139.22	0.20 152.08	0.61 142.81	0.28 191.50	0.26 146.35	0.09 93.07	0.09 137.85	0.03 41.77	0.07 101.80	Mag Phase
176	6.16	3.50	1.86 16.14	1.98 133.08	0.79 77.28	0.73 163.71	0.66 210.01	0.30 120.12	0.06 25.73	0.19 112.68	0.06 60.77	0.10 92.52	Mag Phase
177	8.43	5.12	2.34 17.16	3.35 116.15	1.43 51.50	0.91 188.64	1.16 224.75	0.26 38.35	0.16 330.15	0.15 104.21	0.05 343.35	0.12 92.03	Mag Phase

Table III. - Continued

Run 7													(h) Continued	
													$\mu_{\text{Nom}} = 0.16$	
POINT	MEAN	1/2P-P	1P	2P	3P	4P	5P	6P	7P	8P	9P	10P		
178	10.34	9.88	3.55 11.88	4.42 79.98	2.86 345.02	2.34 262.12	1.72 277.42	1.06 323.73	0.43 307.37	0.07 325.92	0.18 288.62	0.06 36.48	Mag Phase	
179	10.06	12.72	4.84 7.21	4.31 62.86	3.96 328.44	3.19 281.61	2.53 312.80	1.69 330.35	0.86 309.74	0.44 301.76	0.25 290.86	0.15 51.79	Mag Phase	
180	8.60	5.22	2.41 15.37	3.34 113.58	1.51 42.41	1.00 186.72	1.20 216.56	0.20 40.98	0.18 314.33	0.13 82.38	0.06 311.88	0.09 85.17	Mag Phase	
181	4.09	2.04	1.49 13.15	0.66 136.78	0.16 149.89	0.62 140.15	0.27 181.81	0.28 136.82	0.10 93.13	0.10 122.60	0.04 45.51	0.06 86.80	Mag Phase	
182	4.40	2.25	1.37 11.57	0.91 142.17	0.40 109.00	0.50 125.68	0.32 179.04	0.26 132.74	0.11 101.73	0.12 131.32	0.05 47.30	0.08 67.42	Mag Phase	
183	6.48	3.69	1.84 16.45	2.03 138.36	1.08 78.64	0.70 153.48	0.60 185.60	0.32 115.84	0.10 59.61	0.19 120.84	0.08 57.70	0.09 85.63	Mag Phase	
184	8.90	5.37	2.33 17.70	3.36 116.25	1.84 51.05	0.99 168.95	0.96 203.97	0.29 76.18	0.09 355.80	0.11 40.32	0.08 9.51	0.09 57.76	Mag Phase	
185	10.71	9.74	3.58 14.08	4.55 78.95	3.07 347.51	2.29 257.75	1.29 286.21	0.85 318.39	0.27 292.98	0.21 261.82	0.19 305.75	0.14 43.90	Mag Phase	
186	10.44	12.80	4.82 11.42	4.69 66.45	3.93 332.84	2.88 284.04	2.34 338.01	1.33 339.89	0.59 316.71	0.53 296.95	0.30 317.18	0.14 46.19	Mag Phase	
187	9.04	5.36	2.41 18.50	3.39 116.67	1.82 49.02	1.08 179.09	1.01 204.82	0.26 87.23	0.09 355.66	0.13 36.72	0.09 3.95	0.08 74.12	Mag Phase	
188	4.41	2.26	1.44 15.09	0.86 146.11	0.35 111.48	0.52 138.70	0.33 188.97	0.26 145.20	0.10 119.59	0.10 156.17	0.05 85.41	0.07 97.31	Mag Phase	

Table III. - Continued

(h) Continued

Run 7

 $\mu_{\text{Nom}} = 0.20$ 

POINT	MEAN	1/2P-P	1P	2P	3P	4P	5P	6P	7P	8P	9P	10P	
189	4.46	2.26	1.66 14.08	0.70 149.99	0.12 97.64	0.44 121.70	0.39 194.36	0.42 143.01	0.16 123.04	0.04 110.49	0.07 63.11	0.05 103.57	Mag Phase
190	6.79	4.20	2.20 20.01	1.92 142.58	0.86 63.24	0.69 141.76	0.79 174.41	0.57 124.44	0.15 45.45	0.06 174.61	0.10 100.45	0.08 124.60	Mag Phase
191	9.20	5.24	2.83 19.49	3.47 113.85	1.96 23.79	0.85 216.82	1.02 204.13	0.11 53.67	0.24 301.39	0.07 219.25	0.06 127.38	0.08 138.09	Mag Phase
192	10.18	8.94	3.45 14.64	4.21 87.76	3.54 346.09	2.53 255.17	1.36 254.15	0.78 298.88	0.56 293.86	0.06 214.04	0.11 206.50	0.09 254.31	Mag Phase
193	10.63	13.03	4.50 8.77	5.34 68.53	5.17 336.36	3.91 271.34	1.78 305.28	1.61 330.90	0.81 324.39	0.16 242.96	0.14 273.66	0.08 312.85	Mag Phase
194	10.33	13.78	5.28 6.48	5.51 61.53	5.39 330.12	3.78 275.99	2.24 339.81	2.08 347.98	1.25 342.30	0.25 12.53	0.12 338.96	0.04 273.62	Mag Phase
195	9.33	5.18	2.95 20.56	3.39 116.19	2.02 28.57	0.89 225.13	1.03 215.25	0.04 143.54	0.28 313.02	0.13 242.11	0.05 68.42	0.03 170.23	Mag Phase
196	4.50	2.28	1.68 16.02	0.63 149.44	0.01 107.42	0.51 137.89	0.39 187.20	0.44 152.16	0.17 118.82	0.05 138.89	0.08 82.36	0.06 114.23	Mag Phase
197	4.08	2.21	1.84 15.54	0.30 131.14	0.29 259.76	0.68 135.38	0.08 173.07	0.37 166.07	0.13 125.28	0.06 167.56	0.06 71.90	0.06 90.84	Mag Phase
198	6.24	3.44	2.31 19.31	1.52 129.83	0.39 45.39	0.76 140.91	0.47 202.89	0.38 133.29	0.08 340.44	0.07 164.85	0.10 53.35	0.07 75.38	Mag Phase

Table III. - Continued

Run 7													
(h) Continued													
$\mu_{\text{Nom}} = 0.20$													
POINT	MEAN	1/2P-P	1P	2P	3P	4P	5P	6P	7P	8P	9P	10P	
199	8.51	4.60	2.88 19.07	3.18 115.74	1.52 24.80	0.79 199.92	0.88 238.06	0.11 54.28	0.28 329.41	0.07 191.98	0.08 60.17	0.02 68.32	Mag Phase
200	10.38	11.26	4.15 12.28	4.91 71.10	4.41 336.87	2.68 265.70	1.64 297.24	1.44 327.22	0.83 332.30	0.06 6.55	0.11 317.68	0.16 302.74	Mag Phase
201	9.87	13.17	5.57 8.76	4.90 55.79	5.02 324.18	2.82 272.56	2.82 350.01	2.09 6.31	1.21 357.60	0.43 28.15	0.18 9.42	0.06 253.97	Mag Phase
202	8.59	4.80	2.96 17.91	3.16 112.00	1.53 15.30	0.92 194.27	0.96 227.95	0.04 99.39	0.26 324.32	0.08 235.10	0.10 43.70	0.02 92.34	Mag Phase
203	4.04	2.28	1.85 15.83	0.24 129.67	0.33 265.52	0.68 138.52	0.09 163.87	0.34 167.84	0.11 130.48	0.07 164.58	0.06 74.19	0.05 105.58	Mag Phase
204	3.57	2.38	1.84 12.82	0.12 108.36	0.48 257.50	0.63 128.97	0.03 34.88	0.25 162.82	0.13 126.16	0.07 151.95	0.05 78.84	0.03 89.36	Mag Phase
205	5.63	2.98	2.33 19.00	1.27 128.84	0.22 35.79	0.60 131.07	0.27 241.05	0.26 119.39	0.06 357.50	0.10 132.74	0.07 53.98	0.05 67.00	Mag Phase
206	7.82	4.25	2.84 19.66	2.73 116.90	1.28 25.50	0.37 173.76	0.71 247.47	0.16 75.60	0.31 329.36	0.11 136.22	0.10 48.15	0.02 68.23	Mag Phase
207	10.13	8.95	3.77 15.35	4.01 77.75	3.53 335.88	1.96 250.44	1.34 266.06	0.74 309.89	0.41 310.11	0.08 172.48	0.04 327.76	0.10 289.07	Mag Phase
208	10.10	13.01	4.71 9.53	4.41 58.80	4.71 333.04	2.46 287.24	2.69 333.24	2.07 0.69	1.29 356.44	0.29 29.60	0.14 336.91	0.05 302.75	Mag Phase
209	7.96	4.30	2.91 18.94	2.75 115.69	1.34 22.75	0.35 172.06	0.71 240.10	0.07 90.92	0.33 326.80	0.09 117.62	0.08 43.55	0.03 107.90	Mag Phase

Table III. - Continued

(h) Concluded

$\mu_{Nom} = 0.20$

Run 7

POINT	MEAN	1/2P-P	1P	2P	3P	4P	5P	6P	7P	8P	9P	10P	
210	5.66	3.07	2.36 21.01	1.36 133.16	0.24 63.34	0.61 131.02	0.25 256.85	0.31 140.62	0.08 10.10	0.09 136.24	0.08 56.14	0.03 101.29	Mag Phase



Table III. - Continued

(i) Blade flapwise bending moment, in-lbs., 63.00 percent radius

Run 7

$\mu_{Nom} = 0.06$

POINT	MEAN	1/2P-P	1P	2P	3P	4P	5P	6P	7P	8P	9P	10P	
126	18.67	17.41	11.39 272.03	3.17 134.20	6.23 298.43	0.84 36.38	3.69 166.56	1.35 91.03	0.03 183.54	0.32 222.02	0.36 267.71	0.17 95.05	Mag Phase

$\mu_{Nom} = 0.07$

POINT	MEAN	1/2P-P	1P	2P	3P	4P	5P	6P	7P	8P	9P	10P	
127	22.02	23.34	15.23 271.81	4.77 147.86	8.41 300.96	1.68 29.04	5.78 164.91	2.23 93.56	0.12 321.18	0.33 230.11	0.31 291.34	0.20 138.11	Mag Phase

$\mu_{Nom} = 0.08$

POINT	MEAN	1/2P-P	1P	2P	3P	4P	5P	6P	7P	8P	9P	10P	
128	25.13	25.66	17.31 270.15	4.31 164.46	10.24 297.31	2.74 23.07	6.54 151.37	2.49 82.24	0.24 302.79	0.41 219.22	0.31 265.77	0.08 153.32	Mag Phase
128A	26.03	27.45	16.82 273.17	6.49 181.80	11.15 279.99	3.66 26.96	4.10 151.13	2.71 72.55	0.41 337.40	0.54 191.87	0.43 242.13	0.15 125.67	Mag Phase

$\mu_{Nom} = 0.09$

POINT	MEAN	1/2P-P	1P	2P	3P	4P	5P	6P	7P	8P	9P	10P	
129	25.83	27.93	16.19 277.57	7.98 191.42	11.51 275.05	3.99 33.05	2.79 156.10	2.69 68.48	0.58 303.36	0.75 187.89	0.57 224.67	0.13 126.00	Mag Phase
130	18.34	15.82	10.05 276.59	3.92 163.45	5.79 293.60	0.98 18.31	4.19 154.84	1.21 89.54	0.38 278.80	0.32 215.27	0.19 247.33	0.26 100.74	Mag Phase

Table III. - Continued

(i) Continued

Run 7

$\mu_{\text{Nom}} = 0.09$

POINT	MEAN	1/2P-P	1P	2P	3P	4P	5P	6P	7P	8P	9P	10P	
131	21.76	20.58	13.48 273.21	4.77 164.82	7.71 295.07	1.67 17.23	4.97 153.90	1.64 92.13	0.34 284.91	0.34 215.47	0.13 261.99	0.20 87.31	Mag Phase
132	24.88	24.31	15.63 270.31	5.60 167.34	9.40 288.34	1.99 14.16	5.70 145.87	1.87 77.60	0.37 269.04	0.36 195.43	0.12 246.25	0.14 36.68	Mag Phase
133	26.25	26.04	16.64 275.70	7.12 176.98	10.17 278.05	2.77 18.12	3.24 139.37	1.99 78.95	0.31 303.84	0.61 191.25	0.20 241.44	0.16 76.98	Mag Phase
134	18.36	15.82	10.11 277.03	4.02 164.08	5.78 295.52	1.11 17.59	4.15 157.73	1.20 92.77	0.40 278.21	0.28 218.67	0.12 275.13	0.26 102.99	Mag Phase
135	18.79	14.75	9.90 279.72	3.62 163.90	5.11 303.50	0.68 20.39	3.22 172.78	0.85 110.01	0.30 323.06	0.19 216.74	0.11 269.44	0.15 150.79	Mag Phase
136	22.47	19.28	13.36 273.97	4.55 163.62	6.78 295.61	1.15 17.16	3.54 158.57	1.04 90.99	0.13 335.49	0.15 195.27	0.18 268.76	0.01 17.94	Mag Phase
137	25.84	23.05	15.95 272.25	5.82 171.17	8.18 289.00	1.57 5.89	3.32 152.98	1.06 87.63	0.09 356.21	0.15 199.49	0.21 257.98	0.12 293.96	Mag Phase
138	27.33	24.11	17.00 277.19	7.41 179.81	9.16 281.78	2.14 10.19	2.42 104.12	0.95 89.03	0.22 91.06	0.21 206.05	0.28 264.95	0.17 298.96	Mag Phase
139	22.51	19.43	13.33 275.15	4.69 166.14	6.85 296.85	1.20 14.71	3.36 165.36	1.04 96.09	0.16 348.77	0.09 222.82	0.16 258.24	0.08 186.90	Mag Phase
140	18.81	14.83	9.83 280.19	3.64 164.41	5.10 302.80	0.70 21.19	3.16 173.76	0.89 114.27	0.26 309.98	0.22 215.70	0.10 274.81	0.16 149.52	Mag Phase

Table III. - Continued

(i) Continued

Run 7

$\mu_{Nom} = 0.09$

POINT	MEAN	1/2P-P	1P	2P	3P	4P	5P	6P	7P	8P	9P	10P	
141	17.91	16.94	10.01 278.08	4.27 176.03	6.37 296.03	1.19 17.85	4.79 166.44	1.54 92.40	0.48 288.99	0.37 217.14	0.11 298.65	0.38 89.66	Mag Phase
142	20.96	22.99	13.32 274.08	5.38 169.15	9.06 293.88	2.03 28.64	6.64 160.56	2.41 87.38	0.42 281.51	0.46 224.75	0.28 295.15	0.37 89.02	Mag Phase
143	23.98	25.45	15.24 273.14	5.93 175.12	10.70 292.70	2.83 25.02	7.32 151.84	2.65 78.87	0.57 266.13	0.48 209.87	0.25 297.96	0.27 51.50	Mag Phase
144	25.35	27.67	16.18 276.22	7.27 186.04	11.57 277.43	4.05 25.90	4.15 152.14	2.90 76.48	0.42 316.79	0.82 195.52	0.46 248.20	0.26 91.01	Mag Phase
145	21.00	22.62	13.34 272.84	5.36 167.13	8.96 290.05	2.22 20.91	6.45 151.93	2.36 80.52	0.42 270.28	0.47 207.35	0.25 280.08	0.36 83.74	Mag Phase
146	17.86	16.94	10.04 278.72	4.35 177.87	6.33 296.54	1.20 18.66	4.78 167.29	1.53 96.27	0.45 287.40	0.33 212.76	0.12 329.41	0.36 80.97	Mag Phase

$\mu_{Nom} = 0.13$

POINT	MEAN	1/2P-P	1P	2P	3P	4P	5P	6P	7P	8P	9P	10P	
147	14.87	8.81	3.79 296.00	4.36 215.09	4.17 305.86	1.03 349.06	1.50 197.66	0.50 118.45	0.25 329.12	0.26 252.46	0.20 280.53	0.11 168.72	Mag Phase
148	16.95	14.40	6.65 284.21	6.35 204.69	7.32 293.84	1.71 5.79	3.42 183.54	1.03 89.94	0.36 336.48	0.34 237.04	0.27 238.53	0.49 134.90	Mag Phase
149	19.27	20.73	9.61 280.01	7.92 197.91	9.76 288.63	3.12 15.50	5.52 181.90	1.79 86.84	0.43 337.11	0.50 248.62	0.28 246.85	0.72 115.56	Mag Phase

Table III. - Continued

(i) Continued

Run 7

 $\mu_{\text{Nom}} = 0.13$ 

POINT	MEAN	1/2P-P	1P	2P	3P	4P	5P	6P	7P	8P	9P	10P	
150	21.69	24.47	11.67 276.74	8.05 191.62	10.58 276.41	4.89 24.24	6.02 168.89	2.08 78.65	0.34 337.76	0.48 216.79	0.58 197.63	0.73 126.36	Mag Phase
151	22.48	25.61	12.38 277.72	7.86 188.61	10.65 268.84	5.03 36.49	6.19 158.42	2.11 81.94	0.31 333.66	0.61 210.79	0.86 206.12	0.52 128.51	Mag Phase
152	19.38	20.89	9.71 280.59	7.87 199.72	9.85 290.03	3.26 19.01	5.71 184.17	1.81 87.28	0.45 348.91	0.47 253.38	0.28 252.37	0.74 120.49	Mag Phase
153	17.01	14.77	6.80 284.55	6.39 204.77	7.44 293.81	1.72 5.38	3.44 186.89	1.05 94.76	0.36 338.10	0.33 244.13	0.25 252.97	0.45 130.44	Mag Phase
154	15.12	7.70	3.46 302.88	3.87 204.99	3.97 304.86	1.02 345.96	1.19 199.66	0.37 103.11	0.24 301.78	0.14 214.68	0.03 345.16	0.08 74.28	Mag Phase
155	17.41	13.46	6.42 287.24	5.86 200.78	6.84 297.06	1.75 0.98	3.41 186.92	0.91 96.61	0.44 307.47	0.26 231.66	0.15 296.81	0.27 109.03	Mag Phase
156	19.84	18.38	9.21 280.88	7.39 191.63	9.04 288.80	2.93 5.06	5.19 165.60	1.41 74.15	0.65 277.22	0.39 230.80	0.23 276.73	0.49 89.43	Mag Phase
157	22.51	21.19	11.49 279.33	8.04 188.43	10.01 284.29	3.99 24.46	5.22 155.52	1.45 67.50	0.69 281.97	0.27 253.80	0.16 296.96	0.43 82.01	Mag Phase
158	23.27	22.11	12.52 279.06	7.91 187.00	9.79 272.92	4.26 37.81	5.29 135.50	1.31 61.19	0.74 266.94	0.43 239.72	0.25 262.83	0.36 52.05	Mag Phase
159	19.85	18.68	9.30 281.75	7.38 194.82	9.04 290.66	2.77 9.12	5.28 170.93	1.42 77.78	0.64 283.24	0.45 230.35	0.18 282.87	0.50 105.60	Mag Phase

Table III. - Continued

(i) Continued

Run 7

$\mu_{Nom} = 0.13$

POINT	MEAN	1/2P-P	1P	2P	3P	4P	5P	6P	7P	8P	9P	10P	
160	17.63	14.19	6.82 285.99	6.07 197.55	7.05 292.56	1.82 357.41	3.67 179.28	1.09 81.73	0.50 294.75	0.30 222.64	0.11 278.13	0.40 98.79	Mag Phase
161	15.58	7.88	3.57 306.14	3.66 198.57	3.72 307.04	0.98 339.28	1.34 179.99	0.30 86.21	0.31 282.80	0.17 206.04	0.02 170.56	0.07 102.66	Mag Phase
162	18.02	13.14	6.41 289.20	5.58 191.12	6.30 297.86	1.61 349.23	3.51 169.49	0.78 80.24	0.61 280.74	0.26 205.44	0.10 346.63	0.19 90.99	Mag Phase
163	20.71	17.44	9.39 281.74	7.28 184.26	8.65 288.22	2.35 353.97	4.95 152.65	1.12 63.70	0.72 258.91	0.23 216.96	0.18 312.94	0.24 60.96	Mag Phase
164	23.32	19.94	11.65 278.42	7.95 177.68	9.53 281.12	3.14 10.24	5.32 137.45	1.20 45.37	0.86 246.24	0.26 233.45	0.26 318.45	0.21 12.15	Mag Phase
165	24.01	20.76	12.77 279.76	8.00 182.32	9.56 276.98	3.21 29.94	5.00 127.96	1.17 47.29	0.91 241.25	0.30 242.15	0.39 305.62	0.17 358.55	Mag Phase
166	20.82	17.20	9.40 284.72	7.08 189.37	8.56 296.44	2.28 6.61	4.78 167.09	1.06 80.00	0.78 274.20	0.29 233.69	0.14 358.93	0.18 83.73	Mag Phase
167	18.10	12.96	6.52 289.70	5.42 191.09	6.35 299.09	1.54 349.49	3.35 168.59	0.72 82.63	0.62 281.61	0.21 202.64	0.08 21.78	0.18 91.18	Mag Phase

Table III. - Continued

(i) Continued

Run 7

 $\mu_{\text{Nom}} = 0.16$ 

POINT	MEAN	1/2P-P	1P	2P	3P	4P	5P	6P	7P	8P	9P	10P	
168	15.60	7.21	2.59 330.82	3.77 202.21	3.72 309.34	1.14 334.47	0.86 213.10	0.40 129.53	0.04 347.70	0.21 196.75	0.09 177.74	0.11 56.09	Mag Phase
169	18.01	12.41	4.25 300.44	5.98 194.25	6.41 296.96	1.78 353.61	2.91 175.93	0.79 103.73	0.51 313.80	0.35 172.62	0.17 133.52	0.14 63.05	Mag Phase
170	20.52	17.32	6.80 288.53	8.15 188.23	8.92 288.22	2.69 3.33	4.56 161.51	1.04 86.77	0.83 292.04	0.45 171.78	0.14 145.35	0.35 24.72	Mag Phase
171	22.77	20.53	9.28 281.66	8.62 185.72	9.28 274.50	3.57 25.89	5.50 149.18	1.02 79.95	1.11 280.97	0.53 152.89	0.14 141.92	0.39 358.74	Mag Phase
172	23.45	21.44	10.87 279.70	8.25 185.75	9.47 265.15	3.44 39.79	6.10 133.41	1.05 64.06	1.39 275.38	0.56 158.45	0.03 205.81	0.47 342.50	Mag Phase
173	20.58	16.96	6.74 289.54	7.99 187.97	8.77 288.51	2.55 7.44	4.33 161.19	0.93 84.02	0.85 292.10	0.39 183.44	0.12 129.35	0.34 28.18	Mag Phase
174	15.58	7.31	2.54 331.08	3.73 203.92	3.58 311.69	1.18 342.04	0.98 209.72	0.36 133.96	0.13 338.00	0.20 213.26	0.11 180.44	0.08 71.94	Mag Phase
175	15.41	7.68	2.47 319.23	4.26 207.90	4.38 308.68	1.21 338.59	0.95 199.13	0.49 128.64	0.12 334.98	0.16 179.54	0.12 206.10	0.06 59.20	Mag Phase
176	17.69	13.10	4.36 295.37	6.55 199.84	7.42 298.06	1.93 355.11	2.96 189.44	0.82 112.28	0.44 329.64	0.28 173.21	0.20 178.91	0.11 127.78	Mag Phase
177	20.02	18.92	6.95 287.37	8.46 195.29	9.92 291.52	3.01 16.48	5.08 178.92	1.09 99.68	0.79 313.10	0.50 187.10	0.23 201.16	0.23 56.34	Mag Phase

Table III. - Continued

Run 7													
(i) Continued													
$\mu_{\text{Nom}} = 0.16$													
POINT	MEAN	1/2P-P	1P	2P	3P	4P	5P	6P	7P	8P	9P	10P	
178	21.98	22.28	9.68 279.91	8.09 190.44	10.07 269.72	4.05 38.32	5.71 164.07	0.99 90.60	1.07 285.50	0.76 165.01	0.23 209.69	0.32 358.77	Mag Phase
179	22.52	22.99	11.14 275.94	8.09 185.09	9.92 254.47	3.68 33.61	5.79 134.77	0.94 57.38	1.27 265.31	0.74 151.20	0.28 211.32	0.49 317.92	Mag Phase
180	20.12	18.83	6.99 285.45	8.20 191.04	9.93 284.50	3.02 4.81	5.26 169.55	1.13 91.44	0.74 296.31	0.49 169.10	0.21 164.15	0.23 29.69	Mag Phase
181	15.33	7.61	2.41 322.78	4.21 204.74	4.20 304.50	1.26 330.95	1.01 196.58	0.44 116.90	0.09 356.99	0.24 181.57	0.12 191.55	0.08 260.97	Mag Phase
182	15.07	8.24	2.43 310.34	4.68 213.00	4.57 303.23	1.29 330.49	1.53 197.64	0.73 128.97	0.24 52.71	0.10 225.42	0.12 208.53	0.03 348.99	Mag Phase
183	17.18	13.70	4.70 289.72	7.07 206.77	7.84 299.16	1.69 347.99	3.09 194.25	0.92 113.42	0.33 2.56	0.19 174.81	0.15 219.84	0.08 255.32	Mag Phase
184	19.39	19.49	7.45 280.75	8.50 195.89	10.68 286.94	2.72 7.19	5.57 182.43	1.18 87.57	0.65 331.22	0.18 202.39	0.17 244.06	0.28 11.21	Mag Phase
185	21.28	23.90	10.10 279.46	7.73 191.87	10.65 269.74	4.27 38.12	5.94 183.44	0.72 89.31	0.90 312.62	0.55 192.26	0.45 251.60	0.30 2.56	Mag Phase
186	21.67	24.42	11.17 276.25	7.81 184.60	10.63 257.38	3.68 30.04	5.93 160.44	0.68 52.82	0.99 297.52	0.55 178.33	0.52 234.49	0.42 330.60	Mag Phase
187	19.44	19.64	7.54 282.94	8.59 197.19	10.72 286.84	2.72 10.01	5.55 184.53	1.21 90.66	0.69 331.45	0.25 226.42	0.20 239.66	0.16 41.72	Mag Phase
188	15.04	8.19	2.59 313.75	4.62 214.79	4.52 309.60	1.22 337.78	1.65 204.48	0.56 138.52	0.12 77.99	0.10 239.66	0.16 268.70	0.04 222.65	Mag Phase

Table III. - Continued

(i) Continued

Run 7

 $\mu_{\text{Nom}} = 0.20$ 

POINT	MEAN	1/2P-P	1P	2P	3P	4P	5P	6P	7P	8P	9P	10P	
189	14.81	8.92	1.74 4.18	4.68 220.07	4.60 308.05	1.10 319.22	1.34 213.92	0.47 156.97	0.18 159.12	0.18 253.41	0.17 272.52	0.16 233.22	Mag Phase
190	17.22	14.66	2.62 322.82	7.59 214.64	7.56 305.35	1.57 337.28	2.14 186.54	0.66 147.05	0.23 169.56	0.28 244.55	0.15 229.72	0.16 143.17	Mag Phase
191	19.33	19.56	4.43 295.84	9.89 204.02	9.93 288.62	1.61 9.54	3.54 186.05	0.84 140.10	0.48 201.84	0.49 222.93	0.03 55.32	0.48 110.08	Mag Phase
192	20.32	19.84	5.72 289.04	9.42 199.63	9.92 268.23	2.31 45.91	4.26 184.31	1.06 150.19	0.77 202.66	0.64 213.38	0.16 7.08	0.53 83.14	Mag Phase
193	21.30	21.99	7.12 285.43	8.77 192.94	10.53 252.03	2.88 59.68	4.73 167.65	0.91 140.76	0.93 203.56	0.87 204.70	0.37 354.05	0.87 53.40	Mag Phase
194	21.26	21.68	8.11 283.13	8.52 192.43	10.13 248.08	2.74 50.21	5.18 147.75	0.83 139.59	0.98 211.45	0.80 215.40	0.48 0.77	1.02 48.27	Mag Phase
195	19.39	19.72	4.66 297.54	9.78 204.75	10.05 291.23	1.73 9.55	3.80 192.60	0.96 144.71	0.32 214.34	0.57 230.76	0.07 61.78	0.59 111.04	Mag Phase
196	14.79	8.67	1.87 4.74	4.62 221.97	4.37 311.78	1.14 322.40	1.11 215.88	0.48 160.76	0.22 149.18	0.20 251.00	0.19 284.60	0.11 228.73	Mag Phase
197	15.28	7.22	2.20 9.50	4.01 216.31	3.59 314.06	1.47 315.88	0.88 245.58	0.42 176.41	0.18 107.54	0.24 246.18	0.11 209.86	0.19 175.24	Mag Phase
198	17.54	13.32	2.45 327.38	6.57 205.67	6.63 299.50	1.72 330.80	2.05 192.61	0.74 142.21	0.04 147.83	0.49 232.38	0.13 176.59	0.47 92.62	Mag Phase



Table III. - Continued

Run 7													
(i) Continued													
$\mu_{\text{Nom}} = 0.20$													
POINT	MEAN	1/2P-P	1P	2P	3P	4P	5P	6P	7P	8P	9P	10P	
199	19.96	19.31	4.32 306.43	9.30 203.56	9.52 293.22	2.02 4.03	3.78 193.73	1.07 141.59	0.22 233.87	0.78 239.62	0.11 220.35	0.69 111.20	Mag Phase
200	22.17	20.05	6.80 288.85	8.96 192.54	9.88 256.38	2.71 38.60	5.03 157.82	1.15 128.90	0.80 225.79	1.26 215.89	0.20 242.53	0.80 67.66	Mag Phase
201	22.42	21.21	8.40 280.92	8.68 191.23	9.07 246.46	2.68 23.59	6.11 130.42	1.14 109.85	0.84 222.34	1.22 208.33	0.06 288.48	0.96 56.10	Mag Phase
202	20.01	19.42	4.30 305.67	9.14 200.21	9.37 288.13	2.21 0.71	3.92 185.64	1.02 133.71	0.15 217.99	0.81 233.85	0.12 227.21	0.74 98.46	Mag Phase
203	15.18	7.19	2.13 12.01	3.87 219.55	3.53 312.28	1.34 319.07	0.90 245.64	0.47 169.56	0.21 116.06	0.26 254.36	0.12 236.58	0.22 174.13	Mag Phase
204	15.44	6.07	2.44 10.87	3.24 211.55	3.04 311.58	1.30 309.17	0.71 277.56	0.41 169.43	0.24 108.27	0.16 217.45	0.09 211.36	0.06 188.29	Mag Phase
205	17.75	11.07	2.63 338.97	5.81 202.59	5.69 296.73	1.38 323.69	1.20 200.12	0.65 127.18	0.17 25.87	0.29 244.68	0.20 204.09	0.38 105.87	Mag Phase
206	20.21	16.28	3.66 313.30	8.10 199.57	8.37 289.29	1.65 359.20	2.42 192.05	0.76 129.27	0.01 154.89	0.47 228.92	0.20 212.65	0.46 93.62	Mag Phase
207	22.60	17.68	5.59 289.69	8.79 191.95	8.95 257.65	2.51 29.88	4.05 167.93	0.80 116.18	0.20 218.57	0.79 212.27	0.37 222.05	0.58 56.83	Mag Phase
208	23.15	18.94	7.77 279.97	8.36 195.84	9.16 250.35	2.10 41.25	4.33 131.27	0.83 97.80	0.33 255.60	0.89 219.99	0.36 232.13	0.61 54.09	Mag Phase
209	20.35	16.13	3.67 311.04	7.95 195.91	8.38 286.01	1.68 353.44	2.27 183.29	0.72 125.62	0.06 47.64	0.38 230.44	0.18 233.52	0.36 75.45	Mag Phase

Table III. - Continued

(i) Concluded

$\mu_{Nom} = 0.20$

Run 7

POINT	MEAN	1/2P-P	1P	2P	3P	4P	5P	6P	7P	8P	9P	10P	
210	17.87	11.22	2.67 338.82	5.92 204.15	5.82 303.05	1.37 327.70	1.08 206.70	0.58 136.80	0.10 55.67	0.27 247.36	0.18 220.79	0.33 115.50	Mag Phase

Table III. - Continued

(j) Blade flapwise bending moment, in-lbs., 74.00 percent radius

Run 7

$\mu_{Nom} = 0.06$

POINT	MEAN	1/2P-P	1P	2P	3P	4P	5P	6P	7P	8P	9P	10P	
126	12.13	16.22	11.55 274.11	2.15 202.92	3.92 315.96	2.04 55.64	4.95 173.36	0.87 124.20	0.39 272.92	2.40 329.75	0.48 302.06	0.13 114.38	Mag Phase

$\mu_{Nom} = 0.07$

POINT	MEAN	1/2P-P	1P	2P	3P	4P	5P	6P	7P	8P	9P	10P	
127	13.04	20.69	13.20 274.63	4.93 223.39	4.76 314.13	4.61 52.41	7.60 173.03	1.28 120.84	0.36 271.41	3.54 319.75	0.49 283.87	0.14 115.17	Mag Phase

$\mu_{Nom} = 0.08$

POINT	MEAN	1/2P-P	1P	2P	3P	4P	5P	6P	7P	8P	9P	10P	
128	14.44	24.37	14.43 273.24	7.28 235.94	6.41 302.21	7.51 48.17	8.53 161.99	1.43 117.45	0.06 214.11	3.25 294.16	0.46 267.42	0.14 45.57	Mag Phase
128A	14.21	25.70	14.37 278.21	9.23 221.47	8.40 271.77	9.61 47.73	4.99 153.50	1.06 122.35	0.79 175.51	4.80 303.85	0.97 240.29	0.22 102.93	Mag Phase

$\mu_{Nom} = 0.09$

POINT	MEAN	1/2P-P	1P	2P	3P	4P	5P	6P	7P	8P	9P	10P	
129	13.42	26.92	14.20 284.78	10.55 218.14	9.31 264.59	10.50 50.54	3.09 157.15	1.08 120.96	1.02 172.78	6.67 298.88	1.12 240.84	0.32 106.26	Mag Phase
130	10.66	14.66	9.76 277.85	3.72 209.88	3.44 305.95	2.55 40.10	5.44 162.95	0.62 138.10	0.15 28.56	3.00 320.92	0.26 256.45	0.27 112.93	Mag Phase

Table III. - Continued

(j) Continued

Run 7

$\mu_{Nom} = 0.09$

POINT	MEAN	1/2P-P	1P	2P	3P	4P	5P	6P	7P	8P	9P	10P	
131	12.87	18.88	12.85 274.80	5.30 220.27	4.55 304.35	3.98 44.87	6.51 162.19	0.86 136.89	0.07 249.41	3.33 316.76	0.38 248.86	0.30 98.17	Mag Phase
132	14.62	21.96	14.54 272.10	7.21 222.56	5.75 293.44	5.40 42.57	7.38 154.46	0.89 121.40	0.31 121.83	3.23 286.84	0.29 223.09	0.27 44.58	Mag Phase
133	14.88	23.42	15.08 280.52	9.31 216.73	6.66 273.55	7.09 42.87	4.02 151.09	1.00 121.74	0.51 179.40	4.56 302.03	0.55 243.94	0.19 69.02	Mag Phase
134	10.66	14.69	9.78 278.25	3.70 210.30	3.45 307.37	2.62 41.79	5.43 165.39	0.62 140.76	0.11 39.45	3.01 324.09	0.27 267.77	0.27 117.65	Mag Phase
135	11.30	13.18	9.88 282.09	3.53 214.04	2.91 320.66	1.67 43.09	4.20 183.05	0.51 134.29	0.09 226.15	2.02 339.00	0.20 289.38	0.14 147.45	Mag Phase
136	13.71	17.34	12.95 277.02	5.47 220.60	3.81 308.34	2.87 39.52	4.81 168.94	0.58 112.63	0.35 227.90	1.80 306.55	0.35 265.64	0.03 150.67	Mag Phase
137	15.88	20.65	15.08 276.09	8.01 221.61	4.77 297.93	3.93 35.22	4.61 163.81	0.62 113.33	0.49 206.49	1.36 287.30	0.39 273.00	0.10 271.62	Mag Phase
138	16.52	21.06	16.06 283.83	10.25 216.59	5.54 283.78	5.14 35.22	2.75 122.87	0.84 101.54	0.69 233.36	1.35 303.67	0.49 285.54	0.16 245.88	Mag Phase
139	13.73	17.52	12.87 278.10	5.60 221.24	3.90 308.61	2.90 38.66	4.72 176.15	0.54 114.20	0.33 233.82	1.60 312.57	0.34 275.61	0.04 204.91	Mag Phase
140	11.26	13.14	9.74 282.43	3.58 215.19	2.91 319.36	1.65 44.30	4.20 183.85	0.53 139.04	0.13 206.25	2.01 342.00	0.20 290.93	0.10 143.35	Mag Phase

Table III. - Continued

(j) Continued

Run 7

$\mu_{Nom} = 0.09$

POINT	MEAN	1/2P-P	1P	2P	3P	4P	5P	6P	7P	8P	9P	10P	
141	9.95	15.88	9.48 278.16	4.01 214.73	4.11 300.36	3.03 49.46	6.15 173.25	0.86 161.22	0.18 76.26	4.05 320.49	0.36 255.17	0.42 94.19	Mag Phase
142	11.50	22.35	12.17 273.94	5.15 218.49	5.97 292.61	5.61 53.71	8.54 167.46	1.13 150.30	0.23 47.01	4.88 316.28	0.49 246.82	0.49 87.92	Mag Phase
143	12.90	24.57	13.42 275.35	7.38 225.31	7.13 287.11	8.20 48.45	9.54 160.78	1.14 149.48	0.40 70.82	4.49 292.76	0.15 271.26	0.36 49.18	Mag Phase
144	13.26	27.03	14.30 282.55	9.34 216.98	9.17 268.18	10.02 48.69	4.94 153.12	1.32 132.86	0.75 167.31	6.36 302.87	1.06 245.37	0.37 84.19	Mag Phase
145	11.55	22.09	12.18 272.88	5.21 215.75	5.91 288.76	5.77 45.83	8.34 158.79	1.20 142.22	0.21 25.82	5.04 303.27	0.49 236.83	0.48 71.73	Mag Phase
146	9.95	15.82	9.44 279.17	4.07 215.60	4.06 300.41	3.09 50.45	6.08 173.18	0.84 167.28	0.25 81.16	4.18 321.02	0.38 251.46	0.39 102.71	Mag Phase

$\mu_{Nom} = 0.13$

POINT	MEAN	1/2P-P	1P	2P	3P	4P	5P	6P	7P	8P	9P	10P	
147	7.17	9.11	3.30 298.10	4.27 233.60	3.50 303.83	1.39 8.32	2.00 194.26	0.31 144.42	0.26 243.77	1.08 358.25	0.03 255.62	0.16 102.76	Mag Phase
148	7.91	15.76	6.21 285.19	6.19 224.68	5.96 292.03	2.94 24.17	4.40 181.83	0.36 144.77	0.65 225.82	2.22 331.04	0.30 235.47	0.27 83.95	Mag Phase
149	9.07	21.87	9.08 281.34	7.94 221.02	7.59 283.83	5.51 30.38	7.17 183.23	0.60 143.34	1.09 219.25	3.27 312.17	0.75 234.30	0.37 89.19	Mag Phase

Table III. - Continued

(j) Continued

Run 7

$\mu_{Nom} = 0.13$

POINT	MEAN	1/2P-P	1P	2P	3P	4P	5P	6P	7P	8P	9P	10P	
150	10.35	25.82	11.27 276.61	8.52 214.76	7.69 265.93	8.43 36.35	8.34 168.88	0.99 160.35	1.28 205.68	5.17 301.69	1.07 241.74	0.50 68.16	Mag Phase
151	10.75	27.13	12.35 277.64	8.56 212.78	7.97 254.87	9.02 45.01	8.38 159.20	1.11 163.39	1.23 206.34	6.00 295.70	1.28 243.80	0.49 63.42	Mag Phase
152	9.14	22.01	9.15 281.93	7.98 222.83	7.60 285.00	5.79 33.64	7.34 185.04	0.61 144.26	0.95 222.21	3.49 314.61	0.70 239.63	0.38 89.80	Mag Phase
153	7.99	16.11	6.36 285.05	6.22 224.59	6.07 292.20	3.03 24.47	4.37 184.78	0.36 144.25	0.69 228.15	2.37 329.99	0.40 233.29	0.25 89.10	Mag Phase
154	7.58	8.19	3.10 303.01	3.63 223.82	3.35 302.93	1.45 6.28	1.58 201.81	0.36 170.96	0.18 236.90	1.17 331.57	0.09 162.36	0.19 96.07	Mag Phase
155	8.49	15.10	6.18 287.93	5.79 222.84	5.29 294.57	3.01 22.90	4.39 189.53	0.72 175.12	0.39 200.13	2.88 327.78	0.24 219.36	0.36 98.34	Mag Phase
156	9.70	19.76	9.01 283.05	7.41 216.73	6.55 284.28	5.20 22.90	6.73 169.64	0.81 154.45	0.41 176.57	3.72 300.88	0.28 211.84	0.45 65.52	Mag Phase
157	11.26	21.76	11.30 280.55	8.33 214.09	6.61 275.00	7.47 39.45	7.04 159.25	1.31 177.97	0.61 180.22	4.15 306.03	0.31 242.50	0.48 59.39	Mag Phase
158	11.68	24.37	12.60 279.79	8.59 212.08	6.51 258.17	8.23 46.32	6.91 140.02	1.60 177.22	0.76 176.80	3.84 303.27	0.37 255.52	0.48 37.71	Mag Phase
159	9.70	19.67	9.04 283.87	7.45 220.17	6.51 285.85	5.07 28.03	6.77 175.51	0.80 156.54	0.31 171.45	3.73 310.17	0.24 215.31	0.47 71.64	Mag Phase

Table III. - Continued

(j) Continued

Run 7

 $\mu_{\text{Nom}} = 0.13$ 

POINT	MEAN	1/2P-P	1P	2P	3P	4P	5P	6P	7P	8P	9P	10P	
160	8.67	15.63	6.53 287.13	5.98 220.33	5.31 290.35	3.26 18.28	4.70 184.04	0.66 166.88	0.35 202.04	3.03 313.53	0.32 202.52	0.35 87.04	Mag Phase
161	8.07	7.11	3.17 305.92	3.31 218.83	3.03 301.73	1.43 6.29	1.63 187.79	0.29 172.26	0.12 44.64	1.13 330.97	0.16 147.71	0.17 91.64	Mag Phase
162	9.11	13.05	6.24 289.90	5.11 215.93	4.80 293.13	2.59 15.53	4.34 175.63	0.72 178.00	0.18 73.05	2.42 317.30	0.24 143.01	0.37 95.20	Mag Phase
163	10.46	18.09	9.27 282.59	6.94 212.33	6.29 283.07	4.15 17.90	6.03 157.97	0.82 171.01	0.21 48.07	2.90 285.56	0.16 126.25	0.43 70.55	Mag Phase
164	11.97	20.03	11.59 278.26	7.72 207.82	6.42 273.31	6.14 27.67	6.44 142.61	1.27 174.87	0.18 65.69	2.47 273.81	0.03 121.33	0.34 54.35	Mag Phase
165	12.38	21.25	12.71 279.42	8.00 210.68	6.21 265.94	6.62 42.23	6.14 130.56	1.37 180.78	0.37 38.81	2.41 287.08	0.28 243.14	0.23 44.43	Mag Phase
166	10.51	17.60	9.31 284.95	6.77 218.25	6.24 291.84	4.11 29.18	5.88 172.77	0.73 186.52	0.21 64.56	2.49 306.83	0.11 117.85	0.38 96.10	Mag Phase
167	9.20	12.67	6.36 289.76	4.99 216.22	4.72 295.50	2.42 14.52	4.14 175.12	0.64 180.58	0.18 81.84	2.29 319.91	0.22 146.90	0.34 93.74	Mag Phase

Table III. - Continued

(j) Continued

Run 7

 $\mu_{\text{Nom}} = 0.16$ 

POINT	MEAN	1/2P-P	1P	2P	3P	4P	5P	6P	7P	8P	9P	10P	
168	7.80	6.79	2.09 330.21	3.29 220.15	3.22 303.30	1.34 350.00	0.89 219.56	0.30 158.81	0.03 280.12	1.03 344.50	0.06 213.87	0.13 117.79	Mag Phase
169	8.42	13.23	3.88 300.27	5.51 217.87	5.27 294.38	2.38 9.82	3.27 176.86	0.49 165.98	0.12 237.13	2.59 311.83	0.09 198.92	0.33 110.73	Mag Phase
170	9.46	19.43	6.40 288.87	7.77 214.67	6.91 287.12	3.92 18.76	5.25 161.37	0.45 162.95	0.11 160.29	3.89 294.68	0.11 49.20	0.48 94.01	Mag Phase
171	10.52	21.97	8.93 281.34	8.83 214.04	6.29 270.88	5.90 39.50	6.59 147.43	0.58 168.79	0.22 56.46	5.25 291.94	0.27 359.76	0.41 95.00	Mag Phase
172	10.85	25.83	10.71 279.05	8.79 214.84	6.19 257.68	6.12 50.13	7.68 130.87	0.57 171.62	0.60 72.98	5.61 297.40	0.40 324.04	0.34 88.80	Mag Phase
173	9.47	18.52	6.41 288.91	7.57 215.17	6.82 287.28	3.72 21.55	4.98 162.26	0.31 170.07	0.05 212.43	3.48 295.56	0.20 95.59	0.40 96.31	Mag Phase
174	7.80	6.61	2.09 331.46	3.29 221.94	3.11 305.63	1.46 354.59	1.03 212.90	0.31 153.51	0.05 216.77	0.93 350.82	0.05 188.79	0.13 119.16	Mag Phase
175	7.33	8.67	2.11 319.66	4.01 226.28	3.83 305.26	1.58 347.08	1.03 200.37	0.36 140.36	0.24 292.08	0.98 333.09	0.05 261.66	0.14 109.04	Mag Phase
176	8.00	15.83	4.05 298.22	6.30 222.44	6.13 296.76	2.83 8.57	3.50 192.53	0.47 148.97	0.41 284.57	3.00 312.03	0.31 257.55	0.34 117.75	Mag Phase
177	8.82	21.71	6.67 290.67	8.49 221.15	7.61 288.34	4.91 28.28	6.02 181.28	0.43 156.23	0.33 291.57	4.69 316.93	0.38 311.62	0.55 107.39	Mag Phase



Table III. - Continued

Run 7													
(j) Continued													
$\mu_{\text{Nom}} = 0.16$													
POINT	MEAN	1/2P-P	1P	2P	3P	4P	5P	6P	7P	8P	9P	10P	
178	9.55	24.15	9.46 282.10	8.83 219.04	7.06 261.86	7.15 43.88	6.67 162.97	0.63 162.37	0.52 349.20	6.96 307.29	0.67 295.99	0.69 99.20	Mag Phase
179	9.83	26.91	11.24 276.88	8.95 213.27	6.82 243.84	6.68 37.70	7.08 132.18	0.48 151.09	0.47 341.41	7.36 284.98	0.73 260.54	0.82 70.73	Mag Phase
180	8.82	21.36	6.70 287.98	8.24 217.67	7.66 281.84	4.80 17.64	6.15 171.19	0.54 140.09	0.18 324.41	4.62 296.07	0.26 281.47	0.58 87.39	Mag Phase
181	7.29	8.31	2.06 322.16	3.87 222.40	3.68 301.58	1.60 344.57	1.07 198.06	0.34 127.56	0.25 282.69	0.98 325.26	0.06 278.75	0.14 86.05	Mag Phase
182	6.71	9.81	2.05 312.51	4.61 230.72	4.18 299.35	1.65 342.19	1.88 200.48	0.41 132.68	0.30 261.31	0.89 335.17	0.20 272.64	0.07 171.07	Mag Phase
183	7.25	17.29	4.21 292.23	7.13 227.79	6.91 298.17	2.59 2.04	3.99 196.56	0.54 126.74	0.52 266.16	2.39 320.15	0.51 275.14	0.20 155.35	Mag Phase
184	8.00	22.84	6.82 284.06	8.91 220.69	8.82 283.78	4.55 17.37	7.01 183.99	0.59 109.41	0.54 267.67	3.47 296.73	0.55 258.67	0.44 108.80	Mag Phase
185	9.01	23.52	9.46 281.45	8.70 220.36	8.02 261.97	7.81 44.35	7.32 180.49	0.46 135.35	0.49 301.53	5.81 322.79	0.79 286.80	0.61 116.38	Mag Phase
186	9.28	25.63	10.73 277.27	8.54 213.82	7.97 247.26	7.17 35.57	7.58 154.01	0.46 126.96	0.46 285.66	6.15 304.24	0.76 260.07	0.73 89.50	Mag Phase
187	8.05	22.45	6.94 285.29	8.99 222.07	8.74 283.01	4.63 22.34	6.89 185.41	0.61 115.54	0.36 271.30	3.39 303.50	0.46 270.10	0.47 107.15	Mag Phase
188	6.68	9.62	2.11 316.05	4.54 233.75	4.03 305.17	1.72 354.16	2.14 210.90	0.45 141.20	0.34 269.79	1.01 358.73	0.18 292.01	0.07 152.43	Mag Phase

Table III. - Continued

(j) Continued

Run 7

 $\mu_{\text{Nom}} = 0.20$ 

POINT	MEAN	1/2P-P	1P	2P	3P	4P	5P	6P	7P	8P	9P	10P	
189	6.27	8.29	1.35 16.15	4.40 233.07	4.18 299.51	1.11 339.37	1.81 209.11	0.54 135.77	0.24 88.84	1.04 47.81	0.30 16.43	0.11 22.09	Mag Phase
190	6.58	14.54	2.09 327.50	7.68 229.88	6.62 299.42	2.35 357.84	3.17 188.02	0.49 118.54	0.48 16.31	1.01 43.05	0.36 11.40	0.02 88.17	Mag Phase
191	6.86	20.19	3.90 297.64	10.30 223.86	8.48 281.02	3.70 26.69	5.03 190.10	0.41 64.68	1.01 29.65	2.59 352.69	0.66 324.04	0.12 286.89	Mag Phase
192	7.14	20.74	5.25 290.31	10.64 223.37	8.62 258.73	5.19 43.94	5.85 189.47	0.64 15.45	1.52 17.27	4.01 339.01	0.85 304.31	0.15 245.24	Mag Phase
193	7.58	24.14	6.76 285.35	10.30 220.99	9.41 241.26	6.14 49.54	6.29 173.02	0.98 3.25	1.92 12.50	5.51 332.49	0.94 289.42	0.25 227.92	Mag Phase
194	7.61	25.30	7.96 281.16	10.22 221.54	9.01 235.95	6.02 41.18	6.73 155.14	1.08 352.43	1.99 10.13	4.90 335.69	0.64 291.19	0.24 207.40	Mag Phase
195	6.92	20.25	3.99 301.28	10.18 225.13	8.54 283.90	3.67 26.63	5.38 197.84	0.38 77.30	0.88 54.85	3.36 4.08	0.64 320.57	0.09 237.14	Mag Phase
196	6.26	7.74	1.43 13.40	4.42 234.86	3.99 303.42	1.19 334.49	1.60 210.63	0.58 138.25	0.17 84.93	1.23 66.27	0.30 29.89	0.09 27.36	Mag Phase
197	7.08	6.97	1.62 19.97	3.55 229.21	3.18 308.62	1.51 321.83	1.14 235.20	0.48 138.37	0.26 135.70	1.71 66.91	0.22 24.59	0.02 110.54	Mag Phase
198	7.31	13.08	1.84 337.90	6.52 224.13	5.74 294.74	2.31 348.93	3.07 195.07	0.17 110.31	0.09 71.40	2.36 15.68	0.24 307.44	0.24 175.28	Mag Phase

Table III. - Continued

Run 7													
(j) Continued													
$\mu_{Nom} = 0.20$													
POINT	MEAN	1/2P-P	1P	2P	3P	4P	5P	6P	7P	8P	9P	10P	
199	7.92	20.14	3.61 314.84	9.48 225.53	8.06 287.21	3.65 24.15	5.41 197.13	0.35 36.44	0.72 73.11	3.90 10.50	0.57 325.18	0.29 189.90	Mag Phase
200	8.51	24.99	6.14 290.52	10.36 220.57	8.47 247.82	5.66 40.58	7.16 160.84	0.61 27.60	1.35 43.97	5.87 340.87	0.85 304.42	0.20 165.36	Mag Phase
201	8.76	29.01	8.31 280.71	10.52 220.50	7.41 235.18	6.06 27.73	8.85 136.95	0.75 15.01	1.63 26.72	6.19 332.81	0.73 306.11	0.28 161.72	Mag Phase
202	7.88	19.93	3.54 313.48	9.36 222.57	7.98 282.13	3.74 18.59	5.58 188.31	0.42 36.04	0.60 58.37	3.56 1.57	0.52 312.52	0.23 179.86	Mag Phase
203	7.06	6.78	1.61 19.52	3.50 229.69	3.04 308.41	1.42 323.96	1.13 236.23	0.46 132.87	0.21 130.90	1.70 67.35	0.19 22.35	0.01 126.10	Mag Phase
204	7.70	5.75	1.69 16.28	2.76 221.68	2.69 305.53	1.35 307.10	0.66 269.73	0.35 136.39	0.22 166.80	1.29 54.58	0.13 4.88	0.05 99.19	Mag Phase
205	7.92	10.65	1.92 346.96	5.47 219.99	4.93 292.61	1.69 336.61	1.72 193.92	0.20 101.63	0.28 155.86	1.79 359.51	0.20 300.50	0.09 139.53	Mag Phase
206	8.37	17.19	2.66 319.78	8.09 222.22	7.13 284.80	2.67 18.38	3.79 188.66	0.28 38.49	0.39 125.56	2.60 349.61	0.21 343.39	0.18 119.89	Mag Phase
207	8.99	20.42	4.74 290.33	9.86 219.97	7.36 249.35	5.07 37.97	6.28 167.81	0.46 11.39	0.35 76.88	3.87 328.43	0.33 329.66	0.22 86.22	Mag Phase
208	9.16	25.94	6.72 278.33	10.30 225.03	7.39 239.72	5.07 45.57	7.12 138.38	0.80 26.35	0.66 79.81	4.68 328.83	0.52 326.45	0.18 77.31	Mag Phase
209	8.35	16.81	2.75 318.58	7.96 220.38	7.13 282.06	2.63 10.53	3.52 179.55	0.27 34.34	0.25 137.10	2.18 335.20	0.15 0.58	0.17 101.91	Mag Phase

Table III. - Continued

(j) Concluded

$\mu_{Nom} = 0.20$

Run 7

POINT	MEAN	1/2P-P	1P	2P	3P	4P	5P	6P	7P	8P	9P	10P	
210	8.00	10.80	1.94 346.67	5.58 222.88	5.03 298.78	1.66 342.76	1.53 199.50	0.29 106.52	0.22 166.43	1.59 11.44	0.16 351.06	0.10 116.20	Mag Phase

Table III. - Continued

(k) Blade chordwise bending moment, in-lbs., 77.23 percent radius

Run 7

$\mu_{Nom} = 0.06$

POINT	MEAN	1/2P-P	1P	2P	3P	4P	5P	6P	7P	8P	9P	10P	
126	-24.43	7.18	2.69 280.22	0.53 167.88	0.94 239.83	0.88 337.30	1.84 272.69	1.45 339.53	0.38 203.49	1.09 302.89	0.27 172.21	0.10 207.58	Mag Phase

$\mu_{Nom} = 0.07$

POINT	MEAN	1/2P-P	1P	2P	3P	4P	5P	6P	7P	8P	9P	10P	
127	-23.49	9.40	2.77 292.30	1.10 135.80	2.60 233.00	1.69 0.78	1.66 114.37	3.47 43.53	0.51 191.60	1.89 279.10	0.42 236.40	0.17 312.19	Mag Phase

$\mu_{Nom} = 0.08$

POINT	MEAN	1/2P-P	1P	2P	3P	4P	5P	6P	7P	8P	9P	10P	
128	-21.34	11.53	3.30 314.79	1.27 110.62	4.96 224.77	1.85 340.95	2.09 107.84	2.59 15.58	0.69 139.14	2.30 239.65	0.40 241.12	0.50 48.28	Mag Phase
128A	-18.27	18.07	4.10 328.15	2.29 53.84	8.76 214.13	2.00 1.94	0.19 13.76	3.33 8.70	1.70 224.42	2.30 286.71	0.62 323.76	0.41 178.16	Mag Phase

$\mu_{Nom} = 0.09$

POINT	MEAN	1/2P-P	1P	2P	3P	4P	5P	6P	7P	8P	9P	10P	
129	-16.63	21.06	4.73 330.09	2.50 41.21	9.47 211.48	1.69 13.91	3.53 311.53	5.85 343.88	1.90 158.32	2.77 288.87	1.20 325.39	0.56 172.71	Mag Phase
130	-23.81	6.15	2.73 282.37	0.97 168.89	1.66 236.50	1.08 337.44	0.50 113.75	1.34 14.46	0.17 46.56	1.41 294.21	0.13 200.92	0.09 191.58	Mag Phase

Table III. - Continued

(k) Continued

Run 7

 $\mu_{\text{Nom}} = 0.09$ 

POINT	MEAN	1/2P-P	1P	2P	3P	4P	5P	6P	7P	8P	9P	10P	
131	-22.22	9.68	2.82 287.93	1.29 137.46	2.89 226.37	1.42 343.61	2.15 107.72	2.71 58.20	0.66 167.68	2.04 309.39	0.19 227.95	0.50 357.09	Mag Phase
132	-20.43	11.98	3.49 307.29	1.34 111.71	5.64 209.05	1.88 327.53	1.07 149.54	2.81 0.43	0.32 157.56	1.39 231.75	0.15 211.14	0.42 39.62	Mag Phase
133	-17.58	17.79	4.15 319.37	2.21 58.20	8.05 213.50	2.26 4.36	1.44 332.12	2.97 44.30	0.96 177.47	2.10 299.39	0.23 342.23	0.06 93.61	Mag Phase
134	-23.77	6.17	2.79 280.03	1.00 167.58	1.62 238.19	1.17 344.58	0.33 90.52	1.06 16.22	0.12 111.15	1.41 296.37	0.22 204.69	0.07 262.35	Mag Phase
135	-23.41	5.31	2.95 286.10	0.78 189.21	1.17 246.69	0.98 347.94	0.33 29.58	0.59 45.59	0.07 163.54	0.89 357.92	0.14 214.09	0.08 358.72	Mag Phase
136	-22.15	6.26	3.07 288.16	1.16 158.33	2.38 228.17	1.13 338.12	1.10 112.76	2.35 93.52	0.32 181.31	0.70 232.46	0.18 210.43	0.30 329.82	Mag Phase
137	-20.19	9.61	3.63 307.72	1.33 139.14	4.78 208.86	1.61 324.90	0.99 288.71	2.18 354.01	0.41 221.03	0.24 298.08	0.17 273.29	0.28 69.39	Mag Phase
138	-17.42	15.65	4.16 313.40	1.27 82.02	6.63 215.81	1.98 5.32	3.37 4.19	3.06 114.13	1.39 228.93	0.90 6.49	0.37 25.49	0.24 64.55	Mag Phase
139	-22.58	7.14	3.08 289.34	1.08 161.30	2.50 228.73	1.00 335.38	0.94 114.89	2.38 95.28	0.41 195.47	0.68 311.33	0.15 221.26	0.33 0.85	Mag Phase
140	-23.73	4.85	2.79 284.66	0.80 183.63	1.27 247.18	1.04 351.14	0.24 35.84	0.39 35.36	0.16 150.39	0.70 300.89	0.20 211.59	0.15 272.60	Mag Phase

Table III. - Continued

(k) Continued

Run 7

 $\mu_{\text{Nom}} = 0.09$ 

POINT	MEAN	1/2P-P	1P	2P	3P	4P	5P	6P	7P	8P	9P	10P	
141	-23.69	6.34	2.40 277.43	1.14 164.27	1.97 239.64	1.43 336.35	0.18 325.46	0.92 12.70	0.27 141.66	1.32 314.34	0.17 208.73	0.04 118.95	Mag Phase
142	-22.57	11.56	2.56 287.05	1.81 130.89	3.56 226.53	2.00 343.41	2.17 148.80	3.36 51.11	0.64 165.62	2.22 309.78	0.21 131.53	0.34 330.89	Mag Phase
143	-20.50	15.52	3.38 317.65	1.79 112.58	6.69 214.08	2.81 331.71	1.71 132.36	3.96 3.28	0.66 176.63	2.44 257.18	0.29 270.34	0.54 56.51	Mag Phase
144	-17.54	21.17	4.28 324.65	2.62 57.20	9.37 214.20	2.62 6.01	1.88 328.41	5.16 15.40	1.65 207.14	2.56 313.75	0.54 300.56	0.13 237.67	Mag Phase
145	-22.60	11.59	2.59 286.11	1.77 126.42	3.49 223.00	1.80 340.84	2.70 125.44	3.87 41.30	0.68 159.38	2.04 279.15	0.37 85.64	0.51 309.53	Mag Phase
146	-23.96	6.71	2.39 280.35	1.17 167.09	1.93 241.18	1.44 342.26	0.58 101.69	1.36 15.60	0.21 127.07	1.86 301.26	0.18 224.16	0.09 210.31	Mag Phase

 $\mu_{\text{Nom}} = 0.13$ 

POINT	MEAN	1/2P-P	1P	2P	3P	4P	5P	6P	7P	8P	9P	10P	
147	-24.95	4.11	1.71 292.77	1.11 206.75	1.08 269.57	1.04 352.50	0.55 322.64	0.39 47.40	0.21 314.37	0.71 10.34	0.14 178.41	0.01 328.21	Mag Phase
148	-24.30	6.51	2.12 291.73	1.70 167.91	2.55 248.34	1.99 337.58	1.23 2.89	1.12 80.23	0.13 121.68	0.53 285.34	0.32 224.31	0.16 339.26	Mag Phase
149	-22.79	10.84	3.07 304.71	2.58 140.29	3.68 229.83	2.74 330.37	0.42 241.54	2.14 127.70	0.92 188.48	1.47 316.98	0.48 259.71	0.71 17.97	Mag Phase

Table III. - Continued

(k) Continued

Run 7

 $\mu_{\text{Nom}} = 0.13$ 

POINT	MEAN	1/2P-P	1P	2P	3P	4P	5P	6P	7P	8P	9P	10P	
150	-20.60	18.09	4.44 322.85	2.52 102.36	6.52 215.87	3.01 333.06	2.02 59.07	4.89 88.28	0.88 200.33	3.09 271.00	0.85 1.21	0.67 48.20	Mag Phase
151	-19.42	14.71	5.01 329.76	2.66 76.81	7.23 213.96	2.57 352.53	1.70 80.91	1.39 75.53	0.75 228.97	1.04 239.19	0.77 248.93	0.36 11.37	Mag Phase
152	-23.51	10.12	3.20 303.92	2.47 141.51	3.86 232.12	2.54 333.06	0.83 176.77	2.58 127.00	0.72 204.03	0.88 270.79	0.47 261.32	0.71 28.35	Mag Phase
153	-24.95	7.37	2.39 293.37	1.58 168.15	2.56 249.15	2.06 340.30	1.19 13.21	1.69 75.40	0.50 165.47	1.51 322.40	0.42 244.94	0.31 326.65	Mag Phase
154	-25.33	4.07	2.04 297.92	0.82 207.23	1.05 275.57	0.82 1.39	0.98 307.18	0.52 121.08	0.14 320.15	0.44 307.29	0.16 156.68	0.03 195.10	Mag Phase
155	-24.66	6.11	2.60 294.32	1.42 171.40	2.35 251.29	2.05 342.21	1.22 352.19	1.14 94.69	0.21 155.03	0.75 314.55	0.22 254.92	0.08 344.12	Mag Phase
156	-22.87	10.38	3.40 304.80	2.32 144.30	3.58 223.59	2.32 326.71	0.49 184.87	3.33 123.85	0.48 114.60	1.37 294.58	0.18 262.61	0.57 352.66	Mag Phase
157	-20.68	18.22	4.57 320.93	2.17 108.74	6.23 218.69	2.72 342.78	3.40 38.33	4.82 95.82	0.76 128.72	2.89 263.76	0.76 0.97	0.65 51.92	Mag Phase
158	-19.47	13.41	5.05 328.80	2.00 81.79	6.85 213.22	2.49 6.56	3.57 39.58	2.42 112.50	1.32 87.33	0.86 200.68	0.10 318.04	0.70 28.95	Mag Phase
159	-23.53	10.09	3.37 302.42	2.24 146.24	3.60 229.09	2.21 334.32	0.75 152.48	2.18 111.41	0.57 124.61	2.21 286.01	0.20 189.87	0.62 1.46	Mag Phase



Table III. - Continued

(k) Continued

Run 7

 $\mu_{\text{Nom}} = 0.13$ 

POINT	MEAN	1/2P-P	1P	2P	3P	4P	5P	6P	7P	8P	9P	10P	
160	-24.73	6.83	2.71 291.77	1.49 164.62	2.40 243.10	1.98 336.84	0.82 348.09	1.40 73.92	0.23 153.66	1.61 285.55	0.25 240.81	0.17 308.24	Mag Phase
161	-25.18	3.73	2.21 297.33	0.59 211.12	0.96 276.38	0.53 5.84	0.68 342.82	0.61 203.53	0.16 25.51	0.21 104.90	0.24 143.30	0.01 146.21	Mag Phase
162	-24.22	6.33	2.80 293.02	1.29 168.21	2.19 247.50	1.78 338.37	0.93 358.04	0.78 101.97	0.18 128.77	1.44 323.07	0.08 178.39	0.07 357.23	Mag Phase
163	-22.82	9.71	3.37 302.93	2.13 139.90	3.67 220.70	2.04 320.14	0.48 256.37	2.51 119.67	0.62 92.50	1.36 290.65	0.30 88.48	0.34 356.44	Mag Phase
164	-20.78	15.11	4.52 317.15	1.92 102.67	6.21 212.21	2.60 329.29	2.57 1.48	4.02 73.76	0.85 81.24	1.84 250.40	0.81 4.50	0.51 71.30	Mag Phase
165	-19.74	12.97	4.79 329.38	1.63 78.81	6.55 215.61	2.50 0.91	3.38 8.34	1.25 89.21	1.43 63.46	1.14 279.06	0.18 50.71	0.08 53.84	Mag Phase
166	-23.46	9.28	3.39 303.19	1.96 147.00	3.64 231.33	1.94 333.44	0.16 198.25	2.70 116.94	0.43 124.37	0.67 300.97	0.26 127.81	0.31 1.47	Mag Phase
167	-24.83	5.21	2.75 293.41	1.18 168.82	2.13 245.91	1.69 338.60	0.91 2.29	0.94 88.72	0.31 121.28	0.62 263.16	0.20 205.33	0.16 259.11	Mag Phase

Table III. - Continued

(k) Continued

Run 7

 $\mu_{\text{Nom}} = 0.16$ 

POINT	MEAN	1/2P-P	1P	2P	3P	4P	5P	6P	7P	8P	9P	10P	
168	-25.29	4.08	1.80 301.10	0.59 208.33	0.95 278.72	0.48 18.74	1.31 344.30	0.66 172.75	0.17 15.56	0.77 358.26	0.04 163.19	0.12 308.82	Mag Phase
169	-24.74	7.20	2.47 298.39	1.30 171.80	2.36 257.95	1.75 341.93	1.52 11.64	1.23 123.77	0.07 120.40	1.70 285.62	0.28 295.70	0.15 318.56	Mag Phase
170	-23.89	12.39	3.62 310.06	2.45 145.26	3.77 224.71	2.27 324.67	0.73 304.76	3.39 135.90	0.46 129.55	2.27 307.06	0.33 35.91	0.43 20.05	Mag Phase
171	-21.23	17.19	5.05 324.04	2.22 97.39	6.18 219.42	2.05 333.32	2.66 52.32	4.85 117.34	0.97 45.34	3.01 301.35	1.37 29.48	0.45 94.97	Mag Phase
172	-20.29	14.96	5.46 338.24	2.15 77.24	6.49 216.43	1.86 0.60	2.71 49.81	1.37 157.64	1.99 82.36	2.02 292.65	0.59 25.72	0.30 58.73	Mag Phase
173	-24.08	10.98	3.68 310.58	2.32 144.40	3.73 227.26	1.99 328.33	0.70 16.67	3.11 125.85	0.58 152.10	1.53 325.46	0.29 78.68	0.31 9.01	Mag Phase
174	-25.64	3.85	1.94 309.22	0.50 205.36	0.89 283.39	0.35 14.72	1.05 348.97	0.50 192.97	0.20 11.70	0.53 22.90	0.09 120.41	0.09 29.05	Mag Phase
175	-25.72	4.66	1.91 303.52	0.70 204.89	1.22 278.90	0.75 356.78	1.63 356.63	0.59 153.23	0.26 342.02	0.69 330.46	0.11 181.22	0.10 321.72	Mag Phase
176	-24.90	8.83	2.61 301.41	1.49 164.49	2.66 257.57	2.25 342.87	1.66 33.03	2.19 130.71	0.04 113.53	1.20 276.62	0.54 289.41	0.27 344.08	Mag Phase
177	-23.33	13.55	3.75 314.23	2.59 145.32	4.22 227.32	2.77 329.31	0.46 315.35	3.80 155.00	0.41 148.47	2.46 308.08	0.42 359.99	0.76 39.20	Mag Phase

Table III. - Continued

Run 7													
(k) Continued													
$\mu_{\text{Nom}} = 0.16$													
POINT	MEAN	1/2P-P	1P	2P	3P	4P	5P	6P	7P	8P	9P	10P	
178	-20.83	18.43	5.37 327.29	2.37 85.03	6.61 220.10	2.49 349.06	2.04 75.99	5.70 141.73	0.80 34.07	3.85 307.52	0.92 17.04	0.51 42.75	Mag Phase
179	-19.64	13.56	5.77 338.58	2.19 71.02	6.37 210.86	2.03 359.66	1.97 35.47	0.94 137.29	1.41 60.22	1.12 259.28	1.11 337.07	0.54 5.73	Mag Phase
180	-23.97	11.39	3.86 307.64	2.29 133.46	4.14 228.93	2.45 321.35	0.79 27.26	2.68 133.28	0.49 125.40	2.43 279.88	0.33 317.09	0.69 17.20	Mag Phase
181	-26.01	4.67	2.04 299.97	0.76 197.05	1.19 276.15	0.85 358.88	1.37 352.35	0.67 154.60	0.33 322.89	0.95 322.66	0.14 235.40	0.13 315.63	Mag Phase
182	-25.68	4.75	2.06 293.99	0.91 203.78	1.40 266.63	1.16 345.17	1.16 334.20	0.78 108.74	0.23 297.85	0.77 350.48	0.17 214.11	0.10 286.17	Mag Phase
183	-24.82	9.22	2.76 294.93	1.66 167.70	2.83 258.88	2.25 335.07	1.34 55.37	2.67 120.67	0.24 161.00	1.31 326.64	0.49 286.61	0.30 358.92	Mag Phase
184	-23.30	11.86	3.69 308.24	2.52 133.81	4.42 231.21	2.80 315.18	0.68 349.88	2.78 126.56	0.36 188.39	1.37 294.12	0.85 301.05	0.71 48.18	Mag Phase
185	-20.47	17.63	5.23 325.74	2.62 82.76	6.74 221.44	2.42 351.41	1.29 120.63	5.64 148.78	0.28 27.25	3.21 334.14	0.75 55.63	0.63 39.83	Mag Phase
186	-19.34	13.62	5.48 337.58	2.70 70.20	6.65 213.40	2.13 357.78	0.57 48.53	0.71 131.49	0.61 54.89	1.32 277.17	0.35 338.04	0.92 37.27	Mag Phase
187	-23.72	11.15	3.74 305.63	2.59 133.67	4.51 233.39	2.54 320.62	0.56 63.25	2.62 127.81	0.44 156.04	1.39 277.98	0.92 297.73	0.71 40.05	Mag Phase
188	-26.22	4.74	1.94 292.06	0.85 211.40	1.45 274.23	1.10 353.35	1.15 337.63	0.80 147.59	0.21 355.22	0.67 54.27	0.06 186.35	0.07 307.99	Mag Phase

Table III. - Continued

(k) Continued

Run 7

 $\mu_{\text{Nom}} = 0.20$ 

POINT	MEAN	1/2P-P	1P	2P	3P	4P	5P	6P	7P	8P	9P	10P	
189	-26.53	4.96	1.95 290.82	0.92 206.27	1.59 269.58	1.08 350.87	1.45 330.69	0.71 128.77	0.45 9.97	0.05 205.02	0.16 197.71	0.09 308.49	Mag Phase
190	-25.69	9.42	2.84 296.73	1.68 166.82	2.89 264.52	2.17 342.64	2.72 75.80	2.15 152.05	0.53 72.22	0.95 14.37	0.25 49.22	0.13 358.27	Mag Phase
191	-23.92	15.23	4.31 313.95	2.84 138.51	5.13 227.63	2.97 311.86	2.37 30.90	3.96 152.69	1.40 342.78	0.82 8.67	0.41 25.03	0.08 228.76	Mag Phase
192	-22.67	19.16	5.16 322.02	2.66 102.42	6.33 222.17	2.32 305.03	3.08 85.09	6.62 135.80	1.83 9.56	1.90 329.67	1.27 29.24	0.09 321.56	Mag Phase
193	-20.91	19.24	6.03 333.75	3.12 78.22	7.30 213.44	1.78 304.47	2.63 136.69	4.43 163.59	1.76 357.42	2.50 12.54	1.21 47.43	0.35 270.92	Mag Phase
194	-20.53	18.42	6.37 340.15	3.04 73.98	7.27 212.43	1.79 310.10	2.05 97.40	3.69 162.73	1.73 13.94	2.01 347.22	1.30 65.41	0.33 206.73	Mag Phase
195	-24.64	13.38	4.22 315.25	2.72 129.96	4.77 237.19	2.74 309.28	2.34 40.04	2.66 138.92	0.71 6.41	1.64 27.04	0.29 353.42	0.29 202.96	Mag Phase
196	-27.16	4.38	1.84 296.37	0.84 205.29	1.45 273.88	0.85 357.08	1.27 12.00	0.47 107.75	0.54 13.39	0.17 54.62	0.20 232.85	0.20 329.54	Mag Phase
197	-26.68	4.68	1.77 304.06	0.74 212.22	1.10 279.32	0.62 0.88	1.50 356.15	0.58 138.40	0.44 358.34	0.92 78.00	0.08 213.24	0.19 335.50	Mag Phase
198	-25.98	7.37	2.67 301.60	1.27 170.32	2.43 259.88	1.91 338.95	1.59 33.16	2.22 132.26	0.28 40.60	1.01 33.15	0.08 236.46	0.13 247.91	Mag Phase

Table III. - Continued

(k) Continued

$\mu_{Nom} = 0.20$

Run 7	POINT	MEAN	1/2P-P	1P	2P	3P	4P	5P	6P	7P	8P	9P	10P	
	199	-24.68	13.34	4.34 320.02	2.54 151.08	4.52 235.20	2.61 317.10	1.25 341.49	3.28 148.06	0.19 2.14	1.88 1.41	0.65 116.96	0.20 111.93	Mag Phase
	200	-21.65	20.74	5.89 332.24	2.83 85.22	6.96 215.93	1.81 303.89	1.87 109.63	5.64 148.96	1.31 28.72	3.88 4.91	1.13 47.59	0.10 0.46	Mag Phase
	201	-20.62	16.29	6.29 345.62	2.43 79.63	6.79 211.07	2.33 312.89	2.75 34.97	1.96 109.88	0.41 19.35	1.44 337.57	1.10 28.92	0.21 92.57	Mag Phase
	202	-25.21	12.67	4.36 317.47	2.45 149.66	4.51 233.05	2.29 311.86	1.20 334.58	2.76 122.00	0.17 79.29	2.09 23.99	0.47 121.55	0.13 142.94	Mag Phase
	203	-27.15	4.20	1.75 307.81	0.52 198.08	1.23 278.54	0.53 3.11	1.28 359.02	0.91 131.80	0.45 18.54	0.60 23.71	0.12 202.07	0.24 321.94	Mag Phase
	204	-26.87	4.34	2.00 312.16	0.42 200.08	0.95 281.50	0.28 9.01	1.70 348.58	0.59 162.48	0.22 319.48	0.48 58.81	0.13 178.68	0.10 324.42	Mag Phase
	205	-26.29	6.86	2.57 308.56	0.95 167.58	2.19 258.84	1.22 336.48	2.54 356.81	1.79 117.38	0.21 50.28	0.83 21.18	0.18 257.57	0.25 304.85	Mag Phase
	206	-25.53	10.96	3.99 317.39	1.95 149.75	3.54 236.42	1.95 316.52	1.69 335.52	2.42 145.38	0.67 122.95	1.73 334.80	0.41 79.21	0.37 34.33	Mag Phase
	207	-22.70	19.41	5.47 327.11	2.18 94.05	6.04 212.65	1.60 287.73	0.70 22.94	7.10 117.88	0.73 27.41	3.19 333.75	1.09 54.12	0.24 67.34	Mag Phase
	208	-21.29	17.60	6.11 341.08	2.29 76.10	6.60 211.21	1.54 305.53	2.84 349.88	3.65 144.27	0.83 144.95	1.26 343.96	1.10 22.15	0.65 66.60	Mag Phase
	209	-25.88	10.28	4.09 312.57	2.05 142.75	3.54 239.60	1.92 317.22	1.95 7.26	2.13 110.51	0.65 129.42	1.36 338.30	0.29 91.44	0.22 23.75	Mag Phase

Table III. - Continued

(k) Concluded

$\mu_{Nom} = 0.20$

Run 7

POINT	MEAN	1/2P-P	1P	2P	3P	4P	5P	6P	7P	8P	9P	10P	
210	-26.54	7.26	2.82 308.48	1.21 185.59	2.21 261.36	1.51 338.82	2.60 7.64	1.84 79.67	0.26 74.95	1.20 352.21	0.19 231.58	0.33 324.21	Mag Phase

Table III. - Continued

(l) Blade torsional moment, in-lbs., 85.00 percent radius

Run 7

$\mu_{Nom} = 0.06$

POINT	MEAN	1/2P-P	1P	2P	3P	4P	5P	6P	7P	8P	9P	10P	
126	1.61	2.16	0.67 50.58	0.46 101.98	0.75 124.43	0.23 125.75	0.60 256.92	0.24 213.22	0.21 72.78	0.12 93.03	0.09 217.40	0.13 276.86	Mag Phase

$\mu_{Nom} = 0.07$

POINT	MEAN	1/2P-P	1P	2P	3P	4P	5P	6P	7P	8P	9P	10P	
127	3.02	3.25	0.60 53.92	0.84 84.82	1.33 117.44	0.50 166.63	0.92 273.43	0.57 195.05	0.45 56.06	0.12 96.31	0.03 200.10	0.06 290.65	Mag Phase

$\mu_{Nom} = 0.08$

POINT	MEAN	1/2P-P	1P	2P	3P	4P	5P	6P	7P	8P	9P	10P	
128	4.56	4.30	1.08 32.35	0.83 82.05	2.04 100.14	0.78 212.59	0.95 232.37	0.44 219.07	0.27 32.58	0.27 84.08	0.13 270.03	0.10 111.74	Mag Phase

$\mu_{Nom} = 0.09$

POINT	MEAN	1/2P-P	1P	2P	3P	4P	5P	6P	7P	8P	9P	10P	
128	5.38	5.96	2.16 9.62	1.66 83.93	1.39 61.69	1.09 225.61	1.66 267.14	0.60 270.52	0.35 41.16	0.17 110.17	0.03 17.15	0.07 201.86	Mag Phase
129	5.14	7.00	3.16 15.82	1.29 84.13	1.34 42.75	1.49 260.61	1.71 283.96	0.95 253.17	0.30 341.70	0.20 136.21	0.06 130.42	0.12 149.03	Mag Phase
130	1.60	2.21	0.65 37.26	0.96 92.96	0.61 91.49	0.17 189.37	0.52 237.29	0.27 162.54	0.12 91.26	0.14 143.92	0.03 314.90	0.13 319.58	Mag Phase

Table III. - Continued

(I) Continued

Run 7

 $\mu_{\text{Nom}} = 0.09$ 

POINT	MEAN	1/2P-P	1P	2P	3P	4P	5P	6P	7P	8P	9P	10P	
131	2.31	2.17	0.64 347.44	1.01 96.27	0.58 92.95	0.26 230.26	0.66 253.96	0.23 217.87	0.10 66.33	0.19 146.71	0.10 142.45	0.06 137.05	Mag Phase
132	3.43	3.08	0.89 28.09	1.17 39.31	0.73 33.05	0.40 204.01	0.70 247.86	0.24 288.27	0.18 22.13	0.08 126.66	0.13 270.74	0.08 42.84	Mag Phase
133	4.76	5.24	2.94 28.04	1.26 120.74	1.67 51.33	1.21 216.37	1.07 260.48	0.84 254.51	0.46 38.29	0.18 153.22	0.02 24.00	0.07 238.70	Mag Phase
134	1.64	2.23	0.71 52.87	1.03 98.31	0.60 102.77	0.27 208.71	0.63 242.76	0.23 181.57	0.12 57.49	0.06 100.08	0.02 39.28	0.19 35.81	Mag Phase
135	1.61	2.07	0.68 58.16	1.03 102.88	0.46 110.92	0.28 229.55	0.49 256.75	0.08 194.23	0.14 66.97	0.07 110.55	0.05 144.25	0.18 47.35	Mag Phase
136	2.30	2.30	0.63 357.40	1.14 88.34	0.51 71.37	0.26 254.89	0.54 267.22	0.20 255.09	0.07 142.59	0.14 142.45	0.06 164.10	0.06 59.21	Mag Phase
137	3.50	2.78	0.95 29.30	1.19 38.73	0.75 33.68	0.33 195.06	0.39 263.70	0.31 324.56	0.13 30.06	0.08 283.55	0.20 354.51	0.06 116.63	Mag Phase
138	4.57	4.50	3.13 34.71	1.34 126.92	1.41 66.93	0.97 229.34	0.62 205.61	0.97 284.43	0.48 51.14	0.06 118.40	0.13 203.40	0.06 344.34	Mag Phase
139	2.47	2.77	0.81 34.21	1.41 84.62	0.78 74.23	0.04 286.84	0.31 265.93	0.09 149.45	0.23 94.12	0.21 115.12	0.04 73.83	0.20 108.99	Mag Phase
140	1.60	1.93	0.61 48.03	1.02 100.07	0.57 97.84	0.13 215.17	0.41 260.91	0.17 204.64	0.09 131.19	0.08 151.78	0.04 146.21	0.13 70.09	Mag Phase



Table III. - Continued

(I) Continued

Run 7

 $\mu_{\text{Nom}} = 0.09$ 

POINT	MEAN	1/2P-P	1P	2P	3P	4P	5P	6P	7P	8P	9P	10P	
141	1.58	1.73	0.50 4.03	0.78 99.08	0.62 82.20	0.08 342.65	0.60 270.52	0.11 191.08	0.10 39.42	0.15 144.42	0.06 157.69	0.04 145.32	Mag Phase
142	2.36	2.44	0.59 334.07	1.09 105.35	0.81 100.94	0.27 189.91	0.71 246.45	0.22 189.17	0.21 54.49	0.18 113.50	0.13 295.65	0.02 284.26	Mag Phase
143	3.35	3.86	0.90 14.76	1.12 45.06	0.58 45.45	0.54 200.50	1.03 233.93	0.39 228.70	0.29 66.44	0.40 128.04	0.11 179.28	0.10 175.96	Mag Phase
144	5.12	6.28	2.60 21.34	1.18 91.93	1.72 50.63	1.40 225.04	1.69 275.38	0.91 243.27	0.43 22.05	0.27 130.94	0.11 330.57	0.14 165.74	Mag Phase
145	2.38	2.37	0.57 341.04	1.07 97.27	0.73 91.36	0.27 195.22	0.73 241.38	0.29 201.70	0.14 53.86	0.21 109.57	0.07 277.16	0.07 121.04	Mag Phase
146	1.73	2.29	0.61 48.52	1.06 98.99	0.77 94.59	0.12 168.98	0.56 251.03	0.28 183.09	0.09 119.37	0.20 136.39	0.05 173.13	0.17 46.28	Mag Phase

 $\mu_{\text{Nom}} = 0.13$ 

POINT	MEAN	1/2P-P	1P	2P	3P	4P	5P	6P	7P	8P	9P	10P	
147	0.86	0.84	0.43 13.67	0.29 162.97	0.33 116.94	0.17 134.68	0.11 234.48	0.07 165.29	0.06 75.77	0.05 112.07	0.02 6.19	0.05 229.59	Mag Phase
148	1.66	1.63	0.62 10.98	0.65 145.64	0.70 98.77	0.19 151.09	0.25 240.99	0.12 157.94	0.12 74.07	0.14 88.92	0.00 326.43	0.09 197.43	Mag Phase
149	2.53	2.46	0.77 11.07	1.06 129.17	1.04 89.13	0.27 172.50	0.46 238.76	0.10 164.29	0.19 55.76	0.15 76.65	0.04 257.50	0.10 225.73	Mag Phase

Table III. - Continued

(I) Continued

Run 7

 $\mu_{\text{Nom}} = 0.13$ 

POINT	MEAN	1/2P-P	1P	2P	3P	4P	5P	6P	7P	8P	9P	10P	
150	4.06	4.26	1.64 6.88	0.81 93.54	2.11 27.55	1.25 256.49	0.86 225.07	0.34 290.28	0.17 116.93	0.18 102.72	0.10 226.58	0.11 220.22	Mag Phase
151	5.43	5.69	2.17 12.38	1.89 90.16	1.67 22.06	1.75 271.79	1.26 285.23	0.27 254.72	0.40 333.05	0.14 17.08	0.17 211.04	0.14 219.20	Mag Phase
152	2.68	3.25	0.78 30.71	1.26 125.51	1.19 92.62	0.40 162.96	0.50 227.43	0.24 172.46	0.11 118.07	0.08 118.56	0.18 241.53	0.26 227.77	Mag Phase
153	1.97	2.65	0.87 56.10	1.10 123.34	1.09 98.10	0.42 122.89	0.17 212.04	0.12 146.55	0.08 46.98	0.07 114.89	0.03 296.61	0.11 250.33	Mag Phase
154	0.91	1.44	0.47 53.35	0.51 145.65	0.48 137.95	0.30 162.09	0.19 213.59	0.10 185.08	0.06 104.63	0.09 118.62	0.05 141.22	0.09 193.66	Mag Phase
155	1.82	2.46	0.89 65.79	1.17 123.75	0.94 105.13	0.30 150.63	0.29 247.76	0.05 289.97	0.15 356.98	0.11 73.49	0.05 319.64	0.11 189.82	Mag Phase
156	2.51	2.94	0.72 19.97	1.17 122.14	0.98 90.86	0.40 172.80	0.51 224.80	0.08 133.81	0.10 75.09	0.17 115.28	0.11 185.95	0.16 220.09	Mag Phase
157	4.03	4.27	1.71 4.96	0.87 97.40	1.94 29.57	1.29 258.22	0.86 232.45	0.38 321.43	0.13 117.29	0.06 91.31	0.06 243.02	0.06 203.46	Mag Phase
158	5.45	5.79	2.29 18.01	2.02 88.30	1.48 27.76	1.73 262.06	1.13 279.51	0.09 261.85	0.45 316.44	0.16 105.89	0.20 233.27	0.21 115.54	Mag Phase
159	2.88	3.64	1.13 54.94	1.66 113.49	1.36 90.37	0.47 145.48	0.38 224.39	0.06 175.80	0.09 348.31	0.07 66.96	0.24 285.35	0.20 221.49	Mag Phase

Table III. - Continued

(I) Continued

Run 7

 $\mu_{\text{Nom}} = 0.13$ 

POINT	MEAN	1/2P-P	1P	2P	3P	4P	5P	6P	7P	8P	9P	10P	
160	2.05	2.69	1.03 70.96	1.28 122.26	0.91 101.64	0.22 169.47	0.38 260.67	0.09 303.79	0.12 3.54	0.14 101.19	0.07 190.89	0.16 200.99	Mag Phase
161	0.98	1.36	0.66 70.68	0.60 128.50	0.39 127.23	0.12 145.87	0.11 281.15	0.08 17.51	0.07 33.29	0.03 145.37	0.07 263.15	0.08 289.10	Mag Phase
162	1.90	2.45	1.05 69.05	1.19 118.38	0.74 102.69	0.17 184.12	0.43 257.45	0.12 312.91	0.06 351.63	0.16 122.26	0.04 141.76	0.11 174.87	Mag Phase
163	2.74	3.28	1.03 43.03	1.45 107.84	1.09 83.84	0.27 155.55	0.47 222.10	0.07 75.17	0.05 149.45	0.16 113.99	0.16 245.76	0.14 233.70	Mag Phase
164	4.26	4.24	1.62 26.94	1.40 82.65	1.70 20.80	1.17 251.97	0.43 238.97	0.82 0.08	0.17 94.80	0.24 85.30	0.14 282.24	0.32 196.39	Mag Phase
165	5.18	5.96	2.72 27.66	1.73 95.05	1.47 43.46	1.84 258.36	1.00 301.13	0.46 2.09	0.13 299.21	0.03 227.58	0.10 122.70	0.09 282.13	Mag Phase
166	2.83	3.42	1.15 54.90	1.61 110.87	1.25 91.73	0.32 139.43	0.29 240.23	0.17 47.91	0.07 36.04	0.06 131.14	0.17 274.06	0.18 298.13	Mag Phase
167	1.93	2.51	1.06 72.99	1.22 122.86	0.73 109.51	0.19 187.48	0.36 267.22	0.12 331.97	0.07 352.63	0.12 123.19	0.04 224.34	0.18 223.96	Mag Phase

Table III. - Continued

(I) Continued

Run 7

$\mu_{Nom} = 0.16$

POINT	MEAN	1/2P-P	1P	2P	3P	4P	5P	6P	7P	8P	9P	10P	
168	0.93	1.34	0.67 73.95	0.55 143.98	0.35 147.62	0.22 136.46	0.07 118.85	0.12 113.51	0.10 92.10	0.03 120.86	0.06 64.59	0.12 43.74	Mag Phase
169	1.80	2.31	1.15 67.92	1.13 123.67	0.83 104.73	0.30 132.07	0.22 242.13	0.07 357.27	0.15 352.54	0.09 70.35	0.05 333.67	0.04 279.00	Mag Phase
170	2.71	3.64	1.30 55.59	1.56 116.59	1.14 88.63	0.43 148.82	0.49 203.50	0.16 130.18	0.09 170.60	0.28 134.99	0.07 282.95	0.12 205.64	Mag Phase
171	4.54	4.80	2.13 32.46	1.34 89.36	2.35 30.01	1.48 275.64	0.44 239.67	0.31 39.73	0.28 135.60	0.29 123.14	0.25 202.89	0.23 290.00	Mag Phase
172	5.45	6.62	2.78 19.81	1.73 77.92	1.87 17.57	1.91 283.53	1.23 316.74	0.50 350.95	0.38 346.14	0.31 165.30	0.19 10.25	0.23 188.29	Mag Phase
173	2.75	3.57	1.28 62.17	1.67 122.46	1.14 102.18	0.56 160.65	0.59 205.77	0.08 130.49	0.04 0.32	0.17 128.97	0.09 30.80	0.07 349.97	Mag Phase
174	0.97	1.39	0.71 72.05	0.55 140.98	0.36 152.85	0.26 143.37	0.05 118.34	0.10 97.80	0.11 94.71	0.07 152.48	0.05 350.45	0.05 259.04	Mag Phase
175	1.11	1.71	0.68 70.58	0.59 148.83	0.50 148.88	0.36 150.74	0.16 180.42	0.13 144.10	0.13 110.43	0.13 137.76	0.04 190.14	0.14 179.00	Mag Phase
176	2.00	2.63	1.12 64.09	1.19 128.67	1.06 106.17	0.48 134.46	0.24 189.54	0.08 107.31	0.13 25.33	0.13 69.98	0.17 11.37	0.14 311.54	Mag Phase
177	2.78	3.08	1.15 42.79	1.34 121.86	1.09 85.57	0.27 169.78	0.42 232.27	0.05 104.98	0.08 54.04	0.14 141.79	0.12 293.47	0.27 290.69	Mag Phase

Table III. - Continued

Run 7													
(I) Continued													
$\mu_{Nom} = 0.16$													
POINT	MEAN	1/2P-P	1P	2P	3P	4P	5P	6P	7P	8P	9P	10P	
178	4.95	6.09	2.54 24.04	1.66 92.62	2.45 20.09	1.66 278.62	1.10 295.79	0.40 27.93	0.40 67.66	0.30 124.05	0.24 145.15	0.37 200.88	Mag Phase
179	5.47	7.40	3.16 9.72	2.00 70.68	1.95 3.06	1.99 286.37	1.63 313.54	0.48 0.71	0.24 295.90	0.36 92.96	0.09 194.27	0.19 146.65	Mag Phase
180	3.07	3.88	1.47 62.10	1.82 120.57	1.39 93.86	0.55 156.75	0.48 213.21	0.08 14.86	0.19 354.85	0.16 85.43	0.17 337.65	0.18 253.51	Mag Phase
181	1.17	1.57	0.80 70.43	0.62 136.25	0.47 132.81	0.32 131.37	0.07 133.04	0.11 102.00	0.12 78.07	0.09 100.63	0.02 347.77	0.04 309.30	Mag Phase
182	1.26	1.74	0.70 69.55	0.72 146.15	0.59 133.55	0.35 140.31	0.18 164.82	0.14 128.34	0.15 97.76	0.11 119.60	0.07 110.73	0.02 50.93	Mag Phase
183	2.17	2.82	1.18 67.70	1.27 132.40	1.11 106.61	0.45 130.64	0.16 188.38	0.03 29.63	0.13 39.16	0.16 78.75	0.06 55.35	0.01 314.15	Mag Phase
184	2.82	2.56	1.00 35.63	1.23 125.75	1.12 79.33	0.23 153.53	0.35 234.25	0.02 286.19	0.07 359.35	0.05 14.71	0.14 300.34	0.24 279.93	Mag Phase
185	5.14	5.92	2.31 3.59	1.64 80.49	2.30 8.64	1.67 286.11	1.16 296.38	0.22 16.98	0.08 94.51	0.12 98.17	0.34 229.70	0.40 232.00	Mag Phase
186	5.71	7.05	3.04 10.33	2.21 72.91	1.76 4.56	1.79 293.73	1.28 334.62	0.29 355.77	0.05 168.41	0.15 86.62	0.08 140.72	0.32 184.68	Mag Phase
187	3.20	4.10	1.48 66.38	1.89 122.69	1.48 94.49	0.56 147.66	0.36 205.25	0.07 159.25	0.13 63.86	0.31 65.96	0.08 7.74	0.19 138.36	Mag Phase
188	1.35	1.70	0.84 73.86	0.70 144.55	0.57 132.23	0.32 132.88	0.09 151.44	0.11 109.34	0.14 93.88	0.07 108.07	0.04 17.70	0.07 13.68	Mag Phase

Table III. - Continued

(I) Continued

Run 7

 $\mu_{\text{Nom}} = 0.20$ 

POINT	MEAN	1/2P-P	1P	2P	3P	4P	5P	6P	7P	8P	9P	10P	
189	1.26	1.82	0.91 70.18	0.63 149.14	0.50 140.09	0.32 124.85	0.14 149.85	0.16 127.18	0.11 103.68	0.02 153.28	0.03 121.17	0.09 78.83	Mag Phase
190	2.15	3.08	1.25 65.97	1.15 145.84	0.92 123.69	0.59 149.76	0.50 185.62	0.27 162.66	0.07 140.62	0.12 155.03	0.13 104.32	0.06 164.33	Mag Phase
191	3.13	3.46	1.53 57.25	1.18 114.72	1.39 70.23	0.43 137.16	0.44 200.53	0.15 92.40	0.21 132.54	0.26 166.02	0.02 47.73	0.21 100.18	Mag Phase
192	4.00	5.95	2.16 10.41	1.05 91.45	2.71 23.64	1.55 281.59	0.99 278.88	0.67 269.15	0.33 233.27	0.41 181.30	0.40 155.05	0.07 80.31	Mag Phase
193	5.29	7.90	3.02 12.56	2.42 60.92	3.04 4.78	2.03 292.23	0.99 315.65	0.40 10.34	0.31 131.09	0.51 168.69	0.10 264.50	0.05 219.49	Mag Phase
194	5.53	8.42	3.43 13.89	2.52 58.43	2.59 356.39	2.04 284.16	1.41 337.35	0.93 14.78	0.17 82.16	0.45 162.82	0.12 123.51	0.13 140.49	Mag Phase
195	3.51	3.80	1.43 58.05	1.44 142.02	1.49 82.35	0.58 207.00	0.79 216.44	0.19 157.61	0.22 244.90	0.47 210.78	0.33 122.56	0.16 200.51	Mag Phase
196	1.36	1.78	1.02 80.59	0.62 151.40	0.36 142.56	0.31 118.33	0.20 132.09	0.18 141.06	0.05 121.27	0.04 330.92	0.08 51.49	0.06 26.81	Mag Phase
197	1.18	1.55	0.99 76.04	0.46 142.92	0.23 150.79	0.34 109.61	0.15 89.15	0.10 163.96	0.02 196.44	0.04 292.69	0.05 8.18	0.04 319.62	Mag Phase
198	2.10	2.56	1.53 74.39	1.13 131.72	0.70 114.02	0.36 115.40	0.03 123.69	0.11 82.41	0.06 31.76	0.08 252.96	0.10 341.34	0.22 346.99	Mag Phase

Table III. - Continued

Run 7													(l) Continued	
													$\mu_{\text{Nom}} = 0.20$	
POINT	MEAN	1/2P-P	1P	2P	3P	4P	5P	6P	7P	8P	9P	10P		
199	3.20	3.63	2.13 67.65	1.43 91.83	1.52 64.53	0.36 135.84	0.56 241.84	0.21 235.04	0.21 181.74	0.29 190.41	0.09 274.43	0.08 56.69	Mag Phase	
200	5.14	7.01	2.82 26.56	1.68 67.71	2.49 5.16	2.04 280.25	1.23 311.51	0.69 321.99	0.51 14.88	0.32 212.21	0.12 342.65	0.09 217.82	Mag Phase	
201	5.46	7.92	3.48 12.45	2.40 52.08	2.37 350.17	1.47 285.12	1.62 343.09	1.03 31.66	0.30 81.30	0.41 164.18	0.07 149.55	0.14 163.04	Mag Phase	
202	3.38	3.60	2.13 67.22	1.40 79.22	1.50 59.60	0.33 154.47	0.53 229.84	0.34 202.34	0.16 168.87	0.25 163.68	0.12 249.93	0.16 359.50	Mag Phase	
203	1.55	1.67	0.90 48.22	0.74 169.29	0.35 79.93	0.34 100.28	0.06 355.31	0.24 214.59	0.12 71.79	0.11 255.35	0.04 258.53	0.06 228.94	Mag Phase	
204	1.27	1.46	0.89 59.99	0.38 171.34	0.25 76.66	0.22 89.26	0.04 204.17	0.06 237.57	0.06 137.81	0.11 247.98	0.07 204.74	0.09 136.45	Mag Phase	
205	2.67	2.38	1.52 47.12	0.90 150.39	0.67 63.70	0.07 136.44	0.33 230.11	0.26 164.52	0.31 70.72	0.04 234.31	0.10 356.73	0.06 245.26	Mag Phase	
206	4.32	2.71	1.94 39.25	1.28 128.78	0.93 71.14	0.04 168.87	0.46 252.03	0.09 157.39	0.14 25.47	0.14 134.05	0.05 305.33	0.07 240.32	Mag Phase	
207	5.41	5.34	2.63 22.87	1.43 70.31	1.99 359.36	1.13 288.87	0.82 302.94	0.47 353.94	0.34 38.36	0.38 108.30	0.21 100.79	0.17 122.66	Mag Phase	
208	5.60	7.32	3.11 17.05	1.99 54.15	2.40 355.92	1.49 305.15	1.58 330.61	1.00 15.07	0.44 24.93	0.29 149.20	0.07 188.98	0.11 100.66	Mag Phase	
209	3.67	3.41	2.06 54.52	1.43 131.53	1.81 60.42	0.23 307.31	0.74 219.48	0.10 236.27	0.15 286.33	0.09 194.83	0.17 78.72	0.24 82.74	Mag Phase	

Table III. - Continued

(I) Concluded

$\mu_{Nom} = 0.20$

Run 7

POINT	MEAN	1/2P-P	1P	2P	3P	4P	5P	6P	7P	8P	9P	10P	
210	2.21	2.58	1.73 76.55	0.72 122.35	0.35 77.50	0.22 103.06	0.23 233.91	0.16 190.75	0.10 89.58	0.10 136.26	0.02 255.89	0.14 112.47	Mag Phase



Table III. - Continued

(m) Fixed-system strain-gage balance normal force, lbs.

Run 7

$\mu_{Nom} = 0.06$

POINT	MEAN	1/2P-P	1P	2P	3P	4P	5P	6P	7P	8P	9P	10P	
126	124.47	64.37	5.95 159.22	5.77 153.51	1.69 143.36	40.32 105.17	3.24 143.77	8.57 167.84	0.40 344.01	15.91 195.67	0.92 291.01	7.40 205.57	Mag Phase

$\mu_{Nom} = 0.07$

POINT	MEAN	1/2P-P	1P	2P	3P	4P	5P	6P	7P	8P	9P	10P	
127	190.40	65.62	6.71 172.27	4.93 158.10	1.61 147.79	46.27 130.92	3.57 157.74	8.92 213.29	2.29 95.85	22.27 181.84	4.47 242.81	3.06 307.86	Mag Phase

$\mu_{Nom} = 0.08$

POINT	MEAN	1/2P-P	1P	2P	3P	4P	5P	6P	7P	8P	9P	10P	
128	250.98	64.91	11.00 183.06	3.48 127.45	3.37 126.06	52.59 124.76	0.78 305.78	6.51 225.90	2.97 329.74	16.80 131.27	2.48 160.39	2.40 299.33	Mag Phase
128A	305.66	110.11	40.42 198.33	7.36 158.64	12.35 93.84	50.13 121.84	3.06 47.89	4.80 261.70	3.66 72.64	27.58 139.31	4.10 182.18	2.27 8.61	Mag Phase

$\mu_{Nom} = 0.09$

POINT	MEAN	1/2P-P	1P	2P	3P	4P	5P	6P	7P	8P	9P	10P	
129	329.14	111.32	42.63 204.83	7.85 171.62	10.38 114.48	49.65 112.83	8.86 58.79	2.08 253.48	3.79 4.67	33.64 128.88	1.30 235.25	4.05 62.55	Mag Phase
130	136.36	52.51	10.36 168.32	2.06 144.42	2.05 152.96	32.16 115.78	0.99 69.66	8.62 176.04	0.49 287.48	12.09 184.09	1.30 320.70	2.61 271.24	Mag Phase

Table III. - Continued

(m) Continued

Run 7

 $\mu_{\text{Nom}} = 0.09$ 

POINT	MEAN	1/2P-P	1P	2P	3P	4P	5P	6P	7P	8P	9P	10P	
131	198.00	60.55	10.21 175.47	2.37 148.84	3.04 135.71	42.18 121.24	3.29 77.90	8.76 175.16	0.65 199.65	15.45 176.06	2.28 266.93	1.49 283.91	Mag Phase
132	255.94	84.50	34.06 176.13	5.14 82.77	3.96 52.78	58.32 109.36	2.21 230.11	5.05 135.30	2.99 203.84	10.37 96.48	4.88 66.41	6.44 287.72	Mag Phase
133	303.74	103.34	42.81 205.27	5.04 170.66	13.65 102.70	46.81 119.05	2.86 25.21	4.85 221.35	0.62 325.58	22.46 135.67	3.94 216.03	1.40 348.72	Mag Phase
134	137.67	52.21	11.08 174.51	1.12 139.84	2.30 144.00	32.82 118.22	1.41 48.48	7.59 171.00	1.02 266.38	12.92 185.33	0.99 330.96	2.52 287.42	Mag Phase
135	129.10	44.96	11.52 176.02	1.66 111.77	1.91 138.74	26.74 125.50	0.33 85.51	7.06 184.10	1.56 248.61	9.47 204.52	0.46 172.53	1.32 350.01	Mag Phase
136	190.83	49.71	12.08 180.38	1.23 123.08	3.17 125.72	33.33 120.45	3.76 81.28	5.89 165.34	2.02 173.68	8.04 186.28	2.43 225.08	0.49 180.13	Mag Phase
137	251.37	72.81	36.42 177.24	4.92 69.42	4.69 32.55	45.24 110.11	1.70 128.87	3.45 118.04	1.28 186.31	2.87 104.28	3.14 67.12	5.27 265.59	Mag Phase
138	299.45	93.50	43.09 208.65	4.70 173.23	11.35 102.34	37.25 114.81	2.65 123.69	3.63 244.10	3.87 139.34	13.74 168.02	5.97 181.53	1.05 193.53	Mag Phase
139	192.09	50.37	12.38 181.84	0.54 126.43	3.02 129.81	35.72 123.00	3.70 84.00	5.15 169.07	1.65 180.52	9.23 182.83	1.88 222.63	1.26 18.93	Mag Phase
140	129.32	45.76	11.63 178.63	0.97 94.79	2.21 148.22	27.92 126.81	1.83 355.77	6.74 186.95	1.79 233.14	9.30 198.85	1.36 180.86	1.90 343.50	Mag Phase

Table III. - Continued

(m) Continued

Run 7

 $\mu_{\text{Nom}} = 0.09$ 

POINT	MEAN	1/2P-P	1P	2P	3P	4P	5P	6P	7P	8P	9P	10P	
141	146.56	63.37	10.84 173.14	1.84 162.91	2.94 172.73	37.60 116.82	1.31 118.80	10.15 172.42	0.56 206.48	20.03 176.95	2.19 273.87	1.36 290.57	Mag Phase
142	207.61	84.60	12.04 182.13	2.33 154.10	4.69 163.79	53.52 117.97	1.24 75.09	9.53 168.70	0.97 318.24	27.09 161.98	7.68 141.33	0.57 290.77	Mag Phase
143	264.63	101.92	35.86 174.73	6.53 90.33	3.83 89.71	69.48 113.58	2.05 353.69	3.98 128.68	1.54 142.74	22.75 125.17	9.74 91.23	6.60 321.90	Mag Phase
144	311.82	124.38	45.82 201.07	7.85 168.59	14.67 104.41	57.33 120.82	4.40 359.72	3.87 251.84	3.10 342.44	31.37 134.47	3.05 198.61	4.45 0.06	Mag Phase
145	207.50	79.85	10.47 176.93	1.35 154.49	3.98 158.34	52.52 114.28	0.14 114.79	9.40 168.41	0.82 101.41	27.61 157.00	4.42 187.21	2.90 350.30	Mag Phase
146	146.92	61.62	11.34 176.23	1.10 120.13	3.27 167.24	37.01 119.26	0.33 186.15	9.85 176.36	1.24 242.00	19.61 174.43	1.67 281.87	2.76 337.21	Mag Phase

 $\mu_{\text{Nom}} = 0.13$ 

POINT	MEAN	1/2P-P	1P	2P	3P	4P	5P	6P	7P	8P	9P	10P	
147	98.29	35.73	13.66 180.38	3.12 45.23	0.58 268.79	19.18 126.59	4.00 326.61	5.95 205.23	0.30 256.08	5.68 200.96	1.33 16.68	1.03 319.47	Mag Phase
148	166.80	59.27	16.10 179.96	2.12 31.38	1.69 187.62	35.42 125.48	3.18 0.85	8.71 197.28	1.99 180.48	17.89 177.08	1.72 126.38	3.77 333.64	Mag Phase
149	232.82	79.44	17.52 182.38	0.79 16.89	3.63 179.68	45.00 121.39	3.90 304.47	9.00 197.94	2.74 312.74	31.26 154.78	9.03 140.20	3.32 307.22	Mag Phase

Table III. - Continued

(m) Continued

Run 7

 $\mu_{\text{Nom}} = 0.13$ 

POINT	MEAN	1/2P-P	1P	2P	3P	4P	5P	6P	7P	8P	9P	10P	
150	292.73	130.91	50.68 190.41	8.12 149.06	10.66 97.93	48.42 123.33	8.97 311.31	7.32 209.75	4.94 333.74	40.47 141.86	7.51 120.90	5.86 37.09	Mag Phase
151	317.38	133.45	53.58 203.80	8.61 168.91	14.01 110.38	43.36 114.59	5.55 287.54	7.35 253.63	4.95 337.52	36.39 140.02	2.37 207.70	3.80 41.02	Mag Phase
152	234.49	80.55	17.39 186.35	0.68 323.06	3.94 176.57	47.43 124.57	3.01 295.65	8.37 195.22	2.86 335.82	31.19 159.18	7.64 146.95	3.21 346.74	Mag Phase
153	168.07	63.45	15.78 182.98	1.09 14.77	2.03 186.54	36.18 123.25	2.59 330.78	7.99 191.17	0.64 197.97	20.17 175.30	1.94 155.80	4.99 340.20	Mag Phase
154	83.15	34.89	15.19 183.21	3.87 16.79	0.67 62.27	18.02 129.75	7.19 9.50	6.55 204.05	1.26 212.99	5.30 171.49	0.54 13.35	1.45 353.07	Mag Phase
155	152.56	59.75	17.95 181.79	2.93 18.58	1.77 157.66	35.05 128.79	5.87 337.22	9.50 188.33	0.87 201.96	16.77 169.53	2.64 171.76	2.53 346.35	Mag Phase
156	217.57	82.80	22.91 178.43	3.29 38.68	3.40 161.16	47.55 115.07	4.66 314.47	9.63 166.44	2.46 283.73	26.08 137.71	10.91 109.12	1.74 342.51	Mag Phase
157	278.24	127.94	51.55 193.03	7.26 151.08	11.33 100.92	54.07 119.27	12.36 311.80	7.41 183.38	4.77 298.06	33.56 150.92	6.22 142.57	2.55 69.25	Mag Phase
158	303.20	131.57	53.21 204.20	7.35 165.26	14.04 115.75	53.02 107.28	8.90 320.71	5.90 215.67	6.93 308.96	32.27 145.32	1.33 231.52	1.02 279.73	Mag Phase
159	216.98	76.22	19.08 184.19	2.14 65.37	4.11 173.83	47.56 121.19	3.15 303.11	9.04 186.77	6.10 329.35	23.70 140.82	8.74 106.32	3.36 346.42	Mag Phase

Table III. - Continued

(m) Continued

Run 7

 $\mu_{\text{Nom}} = 0.13$ 

POINT	MEAN	1/2P-P	1P	2P	3P	4P	5P	6P	7P	8P	9P	10P	
160	160.16	64.24	16.98 181.27	2.23 13.65	2.07 165.15	37.47 122.60	6.60 325.22	8.86 182.85	0.78 344.18	18.96 153.36	2.77 168.02	3.81 331.99	Mag Phase
161	76.33	32.44	16.09 182.61	3.25 11.69	1.18 50.45	15.39 136.79	7.53 35.86	4.48 214.88	1.85 238.06	4.96 164.13	0.33 216.78	0.92 353.95	Mag Phase
162	145.56	50.15	19.72 182.70	2.66 22.17	1.80 166.35	31.38 129.02	4.04 10.91	8.37 186.65	2.01 217.63	10.28 149.46	2.39 136.17	2.30 0.21	Mag Phase
163	211.02	69.04	21.78 181.86	3.13 41.52	3.74 157.32	47.19 112.33	2.83 348.48	9.77 152.28	3.26 216.65	12.35 127.53	3.55 105.62	2.19 250.98	Mag Phase
164	271.23	104.78	48.80 190.03	5.42 131.53	10.27 81.85	56.36 110.45	12.32 310.18	7.97 142.11	5.66 246.53	18.03 120.36	3.75 125.50	2.90 108.75	Mag Phase
165	295.50	114.42	51.88 206.89	6.10 169.27	13.76 113.20	53.20 108.48	11.31 323.76	4.36 161.82	5.51 271.65	17.68 150.96	1.60 207.48	2.98 242.94	Mag Phase
166	211.41	63.34	20.10 187.41	1.63 70.18	4.32 174.49	46.06 124.51	2.45 332.46	8.45 183.29	3.59 298.32	11.83 133.04	2.58 112.19	2.79 340.83	Mag Phase
167	144.74	55.08	17.50 182.33	2.09 11.05	1.64 157.55	35.00 126.79	4.14 353.34	8.04 189.76	1.47 226.70	11.41 151.19	1.22 200.40	4.45 333.72	Mag Phase

Table III. - Continued

(m) Continued

Run 7

 $\mu_{\text{Nom}} = 0.16$ 

POINT	MEAN	1/2P-P	1P	2P	3P	4P	5P	6P	7P	8P	9P	10P	
168	72.20	35.61	18.57 185.01	4.57 8.63	1.04 21.47	16.03 139.90	9.82 38.67	5.47 217.11	1.30 221.36	4.80 176.33	0.92 54.96	1.14 354.30	Mag Phase
169	143.20	50.73	22.77 184.41	3.49 12.70	1.35 187.67	30.17 129.32	8.38 16.81	7.55 186.33	2.41 199.73	10.92 147.98	1.96 91.86	3.23 342.27	Mag Phase
170	212.37	80.69	38.34 175.80	5.87 50.68	3.87 261.84	46.99 111.33	8.84 337.05	8.29 146.26	2.79 224.99	18.79 108.57	6.21 47.29	5.68 311.88	Mag Phase
171	270.82	107.12	54.25 196.80	6.00 155.50	12.17 101.30	48.79 117.73	13.92 340.90	6.77 173.03	6.71 243.33	19.10 133.75	3.85 80.41	0.82 338.11	Mag Phase
172	296.36	115.47	57.31 206.85	6.57 171.17	13.37 117.77	50.23 106.54	11.03 333.67	6.44 172.77	7.64 283.65	19.07 140.79	1.59 52.25	3.27 296.44	Mag Phase
173	211.54	77.09	36.61 179.65	5.97 56.51	1.50 266.80	47.40 115.61	8.68 344.88	8.27 155.57	5.28 259.45	14.35 112.62	2.87 52.93	5.39 298.45	Mag Phase
174	72.66	36.19	18.29 183.14	4.97 5.90	1.87 47.17	15.28 143.18	8.80 44.49	3.93 231.46	1.21 234.97	4.97 191.47	0.23 312.53	0.36 298.88	Mag Phase
175	91.15	37.95	16.81 182.60	3.94 10.20	0.62 33.88	20.16 136.80	9.67 36.13	6.21 224.05	1.57 202.28	4.85 187.38	1.85 86.46	1.81 14.61	Mag Phase
176	162.65	55.37	21.57 184.17	3.01 5.28	1.90 190.88	34.24 131.83	11.47 11.10	8.95 198.72	3.12 208.18	15.26 159.11	2.06 110.60	3.03 328.38	Mag Phase
177	230.60	89.59	40.65 173.52	8.03 61.74	3.43 231.52	51.54 117.98	12.40 348.73	5.65 168.81	4.56 273.86	21.53 130.65	8.37 67.16	7.18 305.21	Mag Phase

Table III. - Continued

(m) Continued														
$\mu_{Nom} = 0.16$														
Run 7	POINT	MEAN	1/2P-P	1P	2P	3P	4P	5P	6P	7P	8P	9P	10P	
	178	288.72	127.30	58.20 200.46	8.02 167.79	14.03 117.71	44.24 118.92	15.62 340.35	5.49 216.05	7.29 271.34	31.44 141.66	2.64 126.08	2.67 12.00	Mag Phase
	179	312.31	128.59	60.42 206.18	8.04 166.26	12.69 119.03	43.14 98.11	13.13 314.74	5.06 217.00	5.04 311.79	30.80 118.70	6.21 40.63	4.69 52.73	Mag Phase
	180	230.29	77.77	26.44 188.95	1.27 111.64	4.46 186.49	49.60 115.86	9.39 319.31	9.18 170.61	9.31 274.78	23.20 105.62	7.24 75.18	5.47 350.66	Mag Phase
	181	90.79	37.57	18.14 183.18	3.79 4.91	0.49 12.97	18.46 135.02	9.82 26.23	5.28 214.70	1.55 201.44	4.62 180.17	1.64 69.05	1.21 18.42	Mag Phase
	182	109.90	42.14	15.96 180.71	3.12 6.43	0.32 188.42	23.86 123.57	7.57 10.73	6.33 193.57	1.67 156.31	5.11 191.20	2.59 88.78	1.98 297.76	Mag Phase
	183	180.21	57.08	19.32 185.01	2.12 8.71	2.49 204.13	34.65 130.17	9.66 14.03	8.03 199.79	2.32 190.23	14.45 183.20	1.91 111.15	1.41 328.19	Mag Phase
	184	248.33	74.19	24.68 189.40	0.88 102.93	4.69 193.79	44.79 117.68	9.03 310.10	7.14 189.17	8.07 282.78	19.56 136.96	6.04 135.64	0.75 101.92	Mag Phase
	185	306.77	121.95	58.60 201.30	9.60 171.80	13.72 125.83	35.63 120.82	11.08 331.25	5.76 257.99	6.06 321.12	26.17 161.00	3.24 217.56	3.62 130.26	Mag Phase
	186	328.77	124.07	59.93 205.78	9.92 174.58	12.45 120.62	33.33 98.61	9.07 310.70	4.96 259.23	4.12 14.73	28.65 148.95	2.60 104.81	7.55 128.75	Mag Phase
	187	248.42	74.84	24.39 191.72	0.47 133.22	4.40 192.02	46.62 121.23	8.48 309.08	7.99 194.12	6.79 298.09	20.36 144.95	6.87 139.87	1.66 21.30	Mag Phase
	188	109.97	41.11	17.12 185.19	3.34 355.58	0.26 242.66	21.46 139.35	10.28 26.90	6.28 214.06	1.28 200.68	5.61 208.22	1.73 125.50	1.15 344.53	Mag Phase

Table III. - Continued

(m) Continued

Run 7

 $\mu_{\text{Nom}} = 0.20$ 

POINT	MEAN	1/2P-P	1P	2P	3P	4P	5P	6P	7P	8P	9P	10P	
189	111.26	43.92	19.20 184.81	5.55 358.63	0.86 143.33	23.66 134.38	12.27 30.92	6.65 199.14	1.08 209.03	5.76 186.03	0.55 220.27	3.10 324.27	Mag Phase
190	183.88	58.63	24.78 188.48	3.43 11.64	1.46 179.11	35.58 139.39	15.28 44.20	8.22 204.35	3.74 237.32	13.64 183.47	3.57 189.35	3.34 350.12	Mag Phase
191	251.84	96.51	50.67 177.72	9.81 76.55	0.96 167.84	50.20 124.51	13.84 0.58	6.46 150.18	5.93 273.93	17.61 159.58	7.56 111.44	9.78 335.07	Mag Phase
192	279.22	112.66	59.68 191.41	8.49 141.14	10.69 118.78	39.26 132.14	17.32 340.50	7.08 180.00	5.23 295.49	25.65 169.22	10.94 125.41	2.09 77.91	Mag Phase
193	304.91	123.78	65.26 204.05	9.21 181.11	13.39 126.10	26.84 100.34	17.00 332.00	1.48 359.59	4.15 260.82	28.16 155.39	6.86 94.70	5.40 142.28	Mag Phase
194	316.31	131.61	65.98 207.72	8.93 176.56	12.85 126.24	30.61 91.44	23.14 331.60	1.02 332.35	1.97 258.00	31.01 167.94	10.35 106.29	6.33 175.44	Mag Phase
195	249.92	76.60	29.12 195.23	1.08 17.83	4.21 178.13	44.69 130.64	11.05 349.29	8.41 189.04	10.19 300.44	19.37 168.62	6.72 170.24	4.90 359.55	Mag Phase
196	110.11	45.62	21.00 188.73	5.10 357.59	1.10 123.94	22.68 145.34	13.06 37.92	7.15 217.48	1.20 245.48	6.28 200.98	0.61 201.10	3.47 14.20	Mag Phase
197	86.16	46.19	21.36 187.65	5.70 7.37	0.95 5.50	19.73 142.59	11.71 30.51	6.80 217.25	1.04 195.69	6.02 231.94	0.77 97.24	2.66 21.14	Mag Phase
198	158.02	61.13	24.92 187.00	4.14 8.99	1.37 176.22	33.54 125.40	14.07 23.08	8.64 190.83	1.08 228.82	13.05 185.60	2.09 158.79	3.43 322.15	Mag Phase



Table III. - Continued

Run 7													
(m) Continued													
$\mu_{Nom} = 0.20$													
POINT	MEAN	1/2P-P	1P	2P	3P	4P	5P	6P	7P	8P	9P	10P	
199	227.29	91.77	43.49 180.55	7.96 69.76	3.01 263.46	48.12 122.00	13.78 13.70	6.97 165.29	4.10 311.67	20.26 160.59	7.89 107.43	7.60 344.50	Mag Phase
200	284.03	129.67	65.58 201.38	7.92 168.40	14.91 117.28	36.76 107.29	13.48 343.44	3.12 171.23	9.45 268.81	29.47 156.18	5.79 105.81	1.48 37.63	Mag Phase
201	306.92	143.97	67.28 206.52	6.92 160.10	12.89 122.02	36.98 90.35	23.85 315.10	1.47 109.41	6.19 263.60	35.63 151.91	13.54 83.38	2.51 121.43	Mag Phase
202	226.43	92.17	42.86 181.04	8.10 73.08	2.32 260.38	46.86 118.47	12.11 4.03	7.08 168.24	5.29 326.64	20.66 146.07	8.01 87.73	9.12 339.04	Mag Phase
203	84.13	44.59	21.18 187.96	5.35 6.28	1.00 24.87	18.55 144.82	12.35 35.80	5.91 226.19	1.25 201.84	5.64 231.89	1.12 104.10	2.28 43.32	Mag Phase
204	62.44	43.48	21.34 185.38	6.22 358.62	1.30 13.21	16.39 141.77	11.29 37.70	6.46 224.81	0.79 183.50	4.84 219.52	0.12 13.55	1.80 64.49	Mag Phase
205	133.65	56.68	25.76 187.75	4.52 8.19	1.38 149.78	28.90 120.46	13.28 16.02	8.31 189.96	0.44 147.56	11.65 168.07	1.51 115.99	3.12 350.22	Mag Phase
206	201.06	77.88	34.22 187.35	6.45 51.33	3.44 200.63	43.16 117.08	13.84 11.66	10.42 177.98	4.46 315.90	18.13 131.44	7.13 87.02	6.66 357.16	Mag Phase
207	262.70	114.43	61.27 197.82	7.24 149.30	13.21 106.12	41.28 110.07	16.46 340.70	6.96 159.86	6.77 257.16	20.03 148.57	7.06 74.74	2.88 341.46	Mag Phase
208	287.46	129.59	68.08 206.75	5.57 154.08	14.35 115.47	42.31 97.89	22.64 316.81	6.27 154.45	11.13 280.40	20.63 158.80	7.29 45.68	5.92 294.60	Mag Phase
209	201.44	68.30	25.97 191.62	3.02 28.54	5.49 199.24	40.11 118.33	9.00 354.19	9.50 189.87	3.02 304.05	17.99 134.78	4.75 89.37	4.84 325.55	Mag Phase

Table III. - Continued

Run 7													
(m) Concluded													
$\mu_{Nom} = 0.20$													
POINT	MEAN	1/2P-P	1P	2P	3P	4P	5P	6P	7P	8P	9P	10P	
210	133.19	60.06	22.11 188.76	3.53 10.28	1.32 247.20	31.20 129.69	8.47 352.76	10.84 215.40	0.14 332.48	12.41 174.39	1.05 13.04	3.60 1.54	Mag Phase

Table III. - Continued

(n) Fixed-system strain-gage balance axial force, lbs.

Run 7

$\mu_{Nom} = 0.06$

POINT	MEAN	1/2P-P	1P	2P	3P	4P	5P	6P	7P	8P	9P	10P	
126	0.73	24.71	0.99 136.34	1.58 33.18	3.79 240.44	13.03 114.80	1.72 335.63	8.59 339.84	2.98 115.90	2.20 167.19	2.04 5.25	5.42 333.67	Mag Phase

$\mu_{Nom} = 0.07$

POINT	MEAN	1/2P-P	1P	2P	3P	4P	5P	6P	7P	8P	9P	10P	
127	1.12	29.24	1.58 177.70	1.22 40.58	5.85 243.31	14.64 139.98	1.49 350.07	11.49 29.34	2.89 162.79	4.31 178.62	3.17 71.18	2.60 85.35	Mag Phase

$\mu_{Nom} = 0.08$

POINT	MEAN	1/2P-P	1P	2P	3P	4P	5P	6P	7P	8P	9P	10P	
128	-0.05	27.44	3.73 207.47	1.83 58.07	7.78 192.90	14.72 147.14	0.78 116.27	8.15 26.53	1.25 163.58	4.40 100.58	2.93 49.97	2.12 123.04	Mag Phase
128A	-2.39	32.74	12.02 227.54	4.23 140.02	6.11 47.35	16.54 134.04	2.35 197.10	6.18 7.06	8.79 205.78	5.36 82.46	5.35 65.37	2.68 39.58	Mag Phase

$\mu_{Nom} = 0.09$

POINT	MEAN	1/2P-P	1P	2P	3P	4P	5P	6P	7P	8P	9P	10P	
129	-4.70	39.62	15.76 235.94	3.96 163.35	9.30 61.01	17.07 138.52	4.21 218.35	3.25 9.19	3.61 236.99	9.41 93.46	3.07 46.37	3.88 355.46	Mag Phase
130	-6.63	25.42	1.48 163.76	1.10 49.31	9.83 213.44	11.22 126.52	0.29 302.96	8.56 349.40	2.15 64.70	3.99 190.81	2.07 5.92	1.38 54.93	Mag Phase

Table III. - Continued

(n) Continued

Run 7

 $\mu_{\text{Nom}} = 0.09$ 

POINT	MEAN	1/2P-P	1P	2P	3P	4P	5P	6P	7P	8P	9P	10P	
131	-6.65	28.63	2.51 190.21	1.69 52.58	10.88 212.30	13.82 134.73	1.32 273.90	9.10 346.52	2.20 343.77	4.69 168.35	0.27 150.23	1.20 87.85	Mag Phase
132	-7.59	33.83	8.00 204.00	7.64 73.23	13.94 234.12	12.73 138.94	2.20 73.65	0.35 158.46	4.81 88.32	3.14 64.17	4.91 37.53	1.59 155.52	Mag Phase
133	-10.48	30.00	14.10 227.07	3.98 144.86	3.38 49.83	15.79 135.81	2.93 175.82	6.75 357.32	6.41 199.92	4.34 67.26	4.41 100.87	1.99 59.81	Mag Phase
134	-6.64	23.71	1.60 168.66	1.03 50.01	10.52 212.20	11.20 128.45	0.33 246.76	7.14 345.94	2.41 47.88	3.43 190.46	1.82 7.12	1.18 68.39	Mag Phase
135	-14.27	22.88	1.93 172.85	1.04 49.78	9.04 219.60	9.79 133.36	0.15 312.16	6.31 357.74	3.97 22.59	3.33 215.67	1.60 334.78	1.44 114.06	Mag Phase
136	-14.41	22.78	3.03 188.78	1.54 49.86	9.86 211.35	11.69 132.05	2.00 250.47	6.03 339.25	2.59 326.63	3.08 182.93	1.07 273.87	0.73 159.52	Mag Phase
137	-15.00	34.89	9.02 200.00	7.73 68.95	15.41 237.42	10.98 137.23	0.67 123.58	0.73 142.07	6.81 76.86	0.90 23.61	2.61 6.58	2.27 152.51	Mag Phase
138	-18.65	30.63	14.54 223.89	3.96 141.14	5.63 336.44	13.93 129.36	1.61 224.57	4.95 5.50	7.77 167.41	1.38 31.05	4.83 102.22	2.97 77.37	Mag Phase
139	-14.64	20.55	3.26 191.98	1.54 51.22	8.46 206.20	11.92 138.00	2.08 264.35	5.18 340.62	2.10 305.05	3.24 165.49	0.76 307.70	1.35 164.17	Mag Phase
140	-14.41	25.40	2.10 172.62	0.94 53.79	9.36 211.13	10.10 135.94	0.09 190.48	5.86 359.56	4.88 4.66	3.18 215.73	1.65 322.17	2.15 123.07	Mag Phase

Table III. - Continued

(n) Continued

Run 7

 $\mu_{\text{Nom}} = 0.09$ 

POINT	MEAN	1/2P-P	1P	2P	3P	4P	5P	6P	7P	8P	9P	10P	
141	1.58	29.79	1.48 167.60	1.11 56.07	12.42 219.38	12.13 130.23	1.09 342.46	10.08 341.12	1.36 4.50	4.61 182.85	1.54 332.54	1.61 92.68	Mag Phase
142	1.35	39.97	2.70 193.86	1.79 59.54	14.78 219.24	16.25 134.31	1.58 298.50	10.54 334.31	2.06 213.05	6.77 150.32	3.24 79.93	2.83 82.22	Mag Phase
143	0.72	38.79	8.51 209.03	8.87 74.57	16.98 221.26	15.31 149.07	2.22 94.86	1.09 166.37	5.30 84.57	6.04 103.37	3.84 23.53	0.54 209.31	Mag Phase
144	-2.40	35.10	15.34 231.11	4.96 148.39	5.15 67.69	18.34 138.52	3.05 181.96	6.28 358.56	5.66 206.90	7.93 88.08	3.05 78.43	1.74 60.48	Mag Phase
145	1.05	35.14	2.81 196.55	1.58 51.11	13.27 208.85	15.89 131.51	1.12 343.85	10.13 340.49	0.92 356.83	6.41 153.37	1.65 47.15	0.69 138.29	Mag Phase
146	1.30	28.88	1.61 169.14	0.99 55.77	13.42 219.65	11.78 132.12	0.81 6.37	9.52 345.27	3.09 24.80	3.58 187.81	1.78 346.49	2.02 127.08	Mag Phase

 $\mu_{\text{Nom}} = 0.13$ 

POINT	MEAN	1/2P-P	1P	2P	3P	4P	5P	6P	7P	8P	9P	10P	
147	3.23	17.45	1.06 135.99	0.60 41.64	6.33 236.70	6.85 136.49	1.02 138.99	5.74 6.95	1.43 44.51	1.77 213.39	1.54 331.31	1.64 80.53	Mag Phase
148	2.90	31.91	1.69 170.61	0.95 52.73	11.04 215.10	11.51 136.96	0.56 190.98	9.15 359.77	5.56 334.65	3.58 202.00	1.79 316.46	2.22 122.84	Mag Phase
149	2.64	34.20	3.42 210.12	1.45 61.80	14.38 221.05	14.01 140.80	0.20 14.86	10.04 359.89	3.52 4.81	5.86 154.39	2.69 65.49	3.36 86.17	Mag Phase

Table III. - Continued

(n) Continued

Run 7

 $\mu_{\text{Nom}} = 0.13$ 

POINT	MEAN	1/2P-P	1P	2P	3P	4P	5P	6P	7P	8P	9P	10P	
150	1.05	42.08	12.06 225.11	7.45 131.05	5.44 235.78	15.03 131.52	3.72 156.63	10.60 346.24	5.57 87.11	8.01 152.12	5.67 23.73	6.21 359.07	Mag Phase
151	-0.67	39.81	15.87 234.71	6.79 165.32	5.41 89.23	15.94 136.16	0.89 142.37	7.05 7.90	1.22 229.37	8.45 93.97	3.57 25.68	3.66 43.13	Mag Phase
152	2.00	32.79	3.68 214.16	1.51 75.89	13.31 216.39	14.01 146.91	0.97 315.45	10.58 358.27	3.09 8.14	6.55 161.15	3.39 63.53	2.30 130.21	Mag Phase
153	2.91	28.77	1.53 177.82	0.94 57.47	11.45 219.50	11.80 137.16	0.43 84.39	8.84 355.11	2.39 332.70	3.07 195.60	2.39 340.75	2.74 137.02	Mag Phase
154	-4.58	17.59	1.47 161.95	0.73 46.71	3.94 180.08	6.57 136.65	1.55 195.69	6.70 9.77	2.85 340.76	1.95 210.57	1.44 340.69	2.39 122.28	Mag Phase
155	-4.48	35.13	2.36 174.33	0.94 51.09	12.03 205.54	11.21 140.81	0.81 190.14	10.38 351.87	5.56 321.01	4.69 197.80	0.93 315.13	3.70 113.17	Mag Phase
156	-5.25	37.17	4.32 197.13	3.10 61.32	16.07 212.42	13.59 138.01	0.85 257.03	9.77 333.05	4.62 357.88	6.02 142.73	5.17 41.10	5.45 39.33	Mag Phase
157	-7.32	42.77	12.80 220.56	6.96 130.89	8.19 244.05	16.10 135.56	3.68 137.52	9.39 326.68	6.47 93.72	9.17 157.34	4.67 64.01	7.68 34.31	Mag Phase
158	-9.18	41.60	16.08 230.53	5.90 164.90	0.92 245.93	16.94 133.95	1.67 187.96	7.10 334.68	1.34 131.72	9.03 107.42	2.01 72.85	6.50 67.03	Mag Phase
159	-6.03	34.00	4.13 206.82	2.16 75.76	13.58 214.17	14.32 143.74	1.51 310.88	9.42 344.68	3.27 27.23	5.64 147.06	5.63 47.99	4.53 86.23	Mag Phase

Table III. - Continued

(n) Continued

Run 7

 $\mu_{\text{Nom}} = 0.13$ 

POINT	MEAN	1/2P-P	1P	2P	3P	4P	5P	6P	7P	8P	9P	10P	
160	-5.25	31.71	2.29 176.95	1.05 49.83	12.00 208.09	11.83 136.58	0.66 149.49	10.00 345.83	3.34 322.09	3.84 179.41	1.52 341.88	4.08 114.74	Mag Phase
161	-12.66	16.22	2.07 167.51	0.58 22.75	4.01 136.85	6.00 143.63	1.67 217.09	4.78 23.38	4.24 2.61	1.83 200.69	1.72 349.41	1.18 121.16	Mag Phase
162	-12.70	31.54	3.21 176.33	0.91 51.18	10.59 210.54	10.82 139.38	1.00 228.06	8.68 354.14	6.35 316.58	3.26 189.65	0.77 271.41	3.40 110.82	Mag Phase
163	-13.68	32.71	4.70 195.94	2.80 63.38	15.88 211.32	13.85 134.38	1.21 273.79	9.91 323.05	4.81 334.27	3.73 133.65	3.64 19.48	4.70 50.58	Mag Phase
164	-15.96	40.14	12.83 214.74	6.68 111.19	7.58 236.97	15.31 127.37	3.99 124.82	8.72 300.82	6.89 53.77	5.91 111.75	3.23 77.59	7.41 349.77	Mag Phase
165	-17.40	38.25	16.42 229.12	5.17 163.52	2.16 15.85	17.08 134.88	1.59 159.09	8.87 324.99	3.59 136.35	4.32 95.09	3.27 101.98	5.80 79.63	Mag Phase
166	-14.46	31.11	4.79 205.41	1.91 73.20	13.74 217.29	14.01 147.47	1.53 314.76	9.39 346.99	2.87 10.80	4.20 147.24	3.66 42.01	3.34 104.00	Mag Phase
167	-13.81	31.72	2.63 178.15	0.75 56.35	9.76 209.24	11.65 139.58	0.38 223.51	8.94 358.99	5.25 327.83	3.47 191.19	0.62 4.44	4.31 114.49	Mag Phase

Table III. - Continued

(n) Continued

Run 7

 $\mu_{\text{Nom}} = 0.16$ 

POINT	MEAN	1/2P-P	1P	2P	3P	4P	5P	6P	7P	8P	9P	10P	
168	-11.91	16.71	2.17 170.92	0.76 23.65	3.26 122.38	5.77 145.54	2.27 228.72	5.61 25.84	3.38 358.14	1.79 207.26	1.87 342.32	1.23 143.00	Mag Phase
169	-12.21	27.80	3.36 178.26	0.70 30.52	8.03 210.70	10.42 138.17	1.63 236.42	7.89 351.60	6.14 325.06	2.76 186.07	1.14 261.18	3.29 121.71	Mag Phase
170	-13.53	37.23	6.68 187.03	6.72 52.26	21.34 226.27	13.40 139.41	0.73 267.05	7.33 329.62	9.15 0.16	3.46 89.00	2.47 27.91	0.77 21.68	Mag Phase
171	-16.17	38.93	13.79 220.00	6.62 140.19	1.11 289.66	15.81 136.26	3.76 166.79	9.93 326.35	6.17 51.47	3.56 122.99	1.32 87.92	4.88 54.14	Mag Phase
172	-17.78	44.15	17.09 230.80	6.12 175.24	6.38 43.86	15.96 134.94	1.25 190.96	11.14 329.88	4.74 83.89	7.69 96.69	2.58 172.51	3.77 107.24	Mag Phase
173	-14.61	37.71	6.73 191.43	7.14 62.87	18.12 233.64	13.09 142.32	1.34 281.57	7.67 327.14	5.00 25.63	2.95 119.00	3.32 43.87	4.12 99.34	Mag Phase
174	-12.51	17.21	2.17 168.22	0.88 26.65	6.59 111.66	4.53 149.18	2.10 242.95	4.20 37.23	3.33 12.60	1.77 215.19	1.81 354.98	1.32 162.92	Mag Phase
175	-4.66	19.19	1.55 156.65	0.60 22.65	3.93 140.97	6.87 144.00	1.98 230.38	7.00 29.06	4.11 352.72	1.80 228.49	1.59 324.36	2.50 136.50	Mag Phase
176	-4.83	32.68	2.73 177.90	0.72 49.63	9.48 215.56	10.82 143.52	1.79 205.81	10.36 0.54	7.44 332.12	3.33 188.25	2.22 295.71	3.44 140.73	Mag Phase
177	-5.73	37.64	6.62 194.91	8.41 56.98	23.68 232.31	12.42 150.35	1.40 222.76	4.83 2.18	9.04 37.97	3.78 87.83	3.63 21.63	0.47 25.35	Mag Phase



Table III. - Continued

Run 7													
(n) Continued													
$\mu_{\text{Nom}} = 0.16$													
POINT	MEAN	1/2P-P	1P	2P	3P	4P	5P	6P	7P	8P	9P	10P	
178	-8.38	37.33	14.82 228.96	7.58 155.52	2.28 100.66	15.30 138.11	3.48 172.36	9.17 335.40	0.64 325.63	6.08 97.72	2.30 35.47	4.13 48.64	Mag Phase
179	-10.96	47.73	18.19 234.42	7.09 175.45	6.71 59.69	14.30 126.65	1.01 154.08	9.77 337.17	3.27 347.56	12.10 78.09	3.05 309.02	2.61 345.40	Mag Phase
180	-6.74	32.99	5.36 210.58	2.22 112.13	11.84 216.57	13.52 141.76	0.85 14.76	11.20 332.88	3.86 340.57	4.79 109.29	4.22 14.73	2.23 63.74	Mag Phase
181	-4.35	16.68	1.68 159.42	0.39 36.81	3.81 154.82	6.41 142.17	2.15 219.52	5.88 19.67	4.17 352.22	1.35 218.81	1.29 317.51	1.78 128.22	Mag Phase
182	3.82	19.79	0.88 159.73	0.79 57.15	4.14 211.96	7.82 132.41	1.64 201.45	7.19 356.15	2.98 314.51	1.19 219.11	1.55 277.35	2.56 111.63	Mag Phase
183	3.41	29.00	1.93 174.96	0.97 62.01	9.51 233.30	10.83 141.00	2.26 200.64	9.78 5.51	5.49 333.53	2.76 196.40	2.04 297.27	2.57 142.81	Mag Phase
184	2.32	32.03	4.94 219.65	1.66 133.35	11.68 229.06	12.73 142.46	1.65 128.76	9.73 350.46	2.76 324.25	4.14 132.02	2.39 15.82	3.83 34.79	Mag Phase
185	-0.44	36.45	15.31 235.67	8.61 159.02	2.79 101.64	14.48 139.15	3.91 172.01	6.67 4.52	2.79 135.48	5.00 96.35	2.31 100.29	3.15 62.26	Mag Phase
186	-2.73	41.81	18.60 239.83	7.59 171.56	7.58 60.45	13.94 128.58	2.42 123.44	6.48 10.35	1.27 118.99	8.58 89.00	0.80 8.06	3.29 25.24	Mag Phase
187	1.57	32.67	5.54 222.31	2.18 132.52	11.41 216.82	12.78 147.86	1.26 110.46	11.38 356.16	3.53 338.20	4.37 156.36	4.46 35.78	2.94 83.35	Mag Phase
188	3.65	17.57	1.25 159.06	0.59 45.85	3.37 195.54	7.11 147.22	2.37 213.74	6.80 18.53	3.41 3.94	1.72 222.71	1.79 333.70	2.10 148.91	Mag Phase

Table III. - Continued

(n) Continued

Run 7

 $\mu_{\text{Nom}} = 0.20$ 

POINT	MEAN	1/2P-P	1P	2P	3P	4P	5P	6P	7P	8P	9P	10P	
189	6.05	17.47	1.01 142.67	0.78 62.60	3.92 245.94	7.28 141.47	2.20 212.70	6.48 5.98	1.79 338.76	2.08 215.14	1.03 319.40	2.22 100.91	Mag Phase
190	4.94	24.85	2.01 185.94	0.88 41.77	7.92 248.04	10.62 149.29	1.88 236.04	9.57 13.04	5.69 349.10	2.75 192.56	3.14 348.32	2.23 167.61	Mag Phase
191	3.54	38.96	8.44 211.18	9.37 72.38	19.34 256.32	9.23 147.34	1.56 195.64	4.44 330.51	5.31 67.36	5.77 142.26	4.98 23.23	2.28 36.10	Mag Phase
192	1.59	38.63	12.68 228.18	10.19 129.20	3.28 240.95	11.33 127.11	4.53 161.44	12.08 329.45	8.96 33.43	7.43 175.55	2.63 39.04	6.55 50.48	Mag Phase
193	0.06	44.37	17.24 239.73	9.92 169.56	8.94 63.58	13.43 131.37	2.63 179.22	4.41 308.66	5.88 354.91	8.84 106.01	3.24 150.47	6.37 47.55	Mag Phase
194	-1.23	48.77	19.13 242.89	9.37 180.50	13.62 67.73	12.92 130.09	5.38 137.41	5.23 339.22	6.72 16.37	10.30 123.25	3.51 116.95	6.99 74.63	Mag Phase
195	2.85	29.56	6.20 231.47	2.21 178.78	7.86 223.97	11.55 158.04	0.71 101.84	12.53 0.22	4.66 9.70	4.86 164.46	2.48 49.99	2.85 136.71	Mag Phase
196	6.18	15.83	1.12 148.00	0.58 40.03	1.66 213.28	7.07 150.51	1.96 214.82	6.62 28.53	2.40 20.43	1.99 233.03	1.37 330.54	1.75 144.38	Mag Phase
197	-1.54	17.02	1.46 161.36	0.67 45.06	1.38 28.98	6.45 149.03	2.05 214.46	6.91 23.82	2.57 348.12	2.42 239.24	1.65 311.51	1.83 161.54	Mag Phase
198	-2.21	23.34	2.57 178.27	0.89 26.58	4.18 236.47	10.31 135.64	2.35 221.32	9.70 356.13	3.85 316.73	4.00 196.87	3.09 300.91	1.96 143.75	Mag Phase

Table III. - Continued

Run 7													
(n) Continued													
$\mu_{\text{Nom}} = 0.20$													
POINT	MEAN	1/2P-P	1P	2P	3P	4P	5P	6P	7P	8P	9P	10P	
199	-3.53	35.72	6.83 200.43	7.18 61.50	19.98 252.47	12.27 151.53	1.78 270.51	6.50 356.07	7.09 75.70	5.51 140.81	2.40 25.08	2.91 22.23	Mag Phase
200	-7.32	44.87	16.22 229.99	8.95 160.25	6.33 68.81	13.98 131.97	2.54 192.90	8.66 312.41	5.51 354.20	7.05 110.75	3.17 116.05	5.53 47.15	Mag Phase
201	-9.88	55.01	19.56 236.43	8.03 183.43	11.00 48.05	13.03 122.94	3.60 98.97	10.35 329.05	13.72 17.02	13.45 118.83	2.88 75.33	5.70 58.16	Mag Phase
202	-4.16	36.25	7.15 203.66	7.76 67.30	16.39 257.99	12.25 146.32	1.67 276.13	7.88 349.29	6.16 82.02	5.99 137.30	2.86 43.27	1.28 358.39	Mag Phase
203	-1.04	16.46	1.61 162.53	0.42 43.00	2.44 76.90	5.97 150.67	2.37 224.58	6.01 30.58	2.89 347.62	1.63 244.31	1.71 332.95	1.77 172.92	Mag Phase
204	-8.57	17.92	2.33 164.83	0.56 27.24	3.83 75.17	5.49 147.79	2.48 231.18	6.41 28.17	2.21 342.44	1.59 243.09	1.27 319.53	2.43 155.33	Mag Phase
205	-9.60	24.81	3.22 179.06	1.45 19.89	3.17 149.10	9.55 130.60	2.39 214.29	9.43 356.02	4.22 284.54	3.06 185.69	3.20 301.39	2.16 124.50	Mag Phase
206	-11.26	32.84	6.10 197.36	4.54 63.30	15.26 245.35	12.44 140.70	2.08 247.23	10.45 343.55	0.69 67.89	2.92 147.95	2.51 36.91	1.98 76.91	Mag Phase
207	-14.23	43.87	15.29 221.40	8.07 145.14	5.07 38.67	14.12 129.31	3.45 177.24	9.90 310.97	3.16 20.65	4.98 140.30	3.47 122.79	5.07 60.57	Mag Phase
208	-16.61	62.64	19.18 231.82	8.36 177.43	14.77 47.82	13.53 128.69	2.57 111.60	14.73 322.61	12.14 8.74	9.59 123.35	2.31 169.80	3.81 91.85	Mag Phase
209	-12.24	30.85	4.67 204.19	0.98 30.88	13.17 240.78	12.14 137.79	0.77 302.02	11.14 352.71	3.55 54.54	4.38 138.45	3.15 36.82	3.75 107.70	Mag Phase

Table III. - Continued

Run 7													
(n) Concluded													
$\mu_{Nom} = 0.20$													
POINT	MEAN	1/2P-P	1P	2P	3P	4P	5P	6P	7P	8P	9P	10P	
210	-10.19	25.10	2.59	0.91	5.15	10.09	0.41	12.30	1.61	2.62	1.73	2.90	Mag
			179.48	17.97	287.38	141.02	121.55	22.79	332.43	201.22	336.58	143.01	Phase

Table III. - Continued

(o) Fixed-system strain-gage balance pitching moment, in-lbs.

Run 7

$\mu_{Nom} = 0.06$

POINT	MEAN	1/2P-P	1P	2P	3P	4P	5P	6P	7P	8P	9P	10P	
126	85.44	804.73	112.35	31.06	131.07	643.40	18.62	14.90	6.06	20.76	6.40	26.57	Mag Phase
			128.36	29.87	250.90	119.08	177.77	325.16	122.10	342.23	52.28	16.10	

$\mu_{Nom} = 0.07$

POINT	MEAN	1/2P-P	1P	2P	3P	4P	5P	6P	7P	8P	9P	10P	
127	122.37	904.58	101.04	28.62	199.47	708.32	14.67	20.31	6.47	45.55	16.81	9.14	Mag Phase
			176.32	52.52	251.36	149.16	197.36	15.94	169.69	337.53	70.04	107.20	

$\mu_{Nom} = 0.08$

POINT	MEAN	1/2P-P	1P	2P	3P	4P	5P	6P	7P	8P	9P	10P	
128	129.25	975.40	265.54	63.00	259.33	713.26	21.51	33.34	14.48	53.18	5.68	3.31	Mag Phase
			222.25	72.65	201.81	149.28	300.80	11.65	110.73	242.82	4.68	28.30	
128A	159.07	1707.90	988.44	181.24	216.50	731.84	38.83	6.52	39.59	62.39	9.06	8.30	Mag Phase
			232.69	144.46	79.28	147.33	5.36	276.79	246.99	267.13	5.90	227.20	

$\mu_{Nom} = 0.09$

POINT	MEAN	1/2P-P	1P	2P	3P	4P	5P	6P	7P	8P	9P	10P	
129	141.73	1884.04	1201.68	151.24	252.92	718.18	56.82	24.65	6.96	87.30	10.82	15.85	Mag Phase
			244.37	171.50	85.76	145.94	58.95	261.60	292.26	247.81	84.36	215.57	
130	9.89	868.81	112.36	25.72	328.23	538.46	5.31	15.79	9.76	18.29	8.59	7.77	Mag Phase
			160.95	21.41	220.57	131.93	187.09	341.12	80.02	327.19	81.06	85.34	

Table III. - Continued

(o) Continued

Run 7

 $\mu_{\text{Nom}} = 0.09$ 

POINT	MEAN	1/2P-P	1P	2P	3P	4P	5P	6P	7P	8P	9P	10P	
131	50.72	970.82	156.70 197.90	41.75 45.68	359.63 218.57	656.86 139.09	1.64 9.74	24.21 339.24	6.96 24.19	26.27 322.65	12.77 60.56	3.77 79.50	Mag Phase
132	76.96	1484.93	679.30 202.85	279.20 77.95	358.66 244.12	686.61 133.62	30.25 333.74	51.49 275.96	13.24 25.82	47.13 216.16	22.84 211.08	8.43 76.19	Mag Phase
133	77.29	1714.46	1081.49 233.96	167.30 149.96	147.46 109.73	684.07 142.34	47.89 357.79	13.93 300.09	21.16 274.59	42.67 253.48	10.51 32.31	3.10 246.22	Mag Phase
134	9.02	882.91	112.09 167.26	23.36 14.81	352.10 218.58	538.08 133.49	3.10 150.88	13.76 329.40	9.85 76.03	17.94 331.82	9.05 74.15	7.58 103.49	Mag Phase
135	-69.76	744.82	130.45 172.79	22.99 8.51	301.95 225.80	456.24 138.60	4.85 190.75	13.29 342.55	9.59 60.94	12.13 339.27	5.20 36.12	5.76 169.40	Mag Phase
136	-24.30	803.83	194.29 197.04	40.24 42.63	324.11 218.41	533.09 137.00	3.29 95.38	18.03 321.41	10.13 348.72	8.74 328.04	10.23 45.20	1.02 255.62	Mag Phase
137	23.90	1414.22	707.44 200.69	277.84 73.59	389.97 250.46	555.36 132.94	15.08 345.18	33.53 268.06	2.67 48.92	30.36 210.23	11.06 200.03	7.11 38.60	Mag Phase
138	-13.65	1571.47	1059.45 231.25	163.63 145.44	63.48 6.16	587.27 135.04	26.04 333.24	16.08 257.95	36.66 278.12	16.69 322.46	6.58 0.11	8.66 328.25	Mag Phase
139	-42.49	766.85	198.46 202.63	39.58 37.66	276.76 213.03	552.27 139.78	1.49 49.36	16.65 329.87	7.22 9.72	12.61 309.66	9.96 49.05	4.53 215.61	Mag Phase
140	-73.50	756.16	142.62 176.04	23.39 9.87	315.62 218.44	468.64 139.54	3.01 317.46	11.79 344.52	8.65 37.55	13.37 338.77	7.63 19.11	7.37 176.44	Mag Phase

Table III. - Continued

(o) Continued

Run 7

$\mu_{Nom} = 0.09$

POINT	MEAN	1/2P-P	1P	2P	3P	4P	5P	6P	7P	8P	9P	10P	
141	74.19	993.80	121.04	24.12	413.22	600.21	10.19	18.97	6.70	29.04	11.86	4.54	Mag
			171.40	33.63	224.77	134.89	182.51	330.64	51.54	324.92	56.03	133.85	Phase
142	130.85	1196.92	202.20	42.09	501.42	761.49	12.88	34.12	18.27	56.21	18.45	7.36	Mag
			205.38	63.40	223.40	138.85	139.08	317.13	130.99	297.15	341.60	76.51	Phase
143	177.70	1596.56	730.49	279.85	456.48	789.29	37.89	55.41	7.47	72.26	26.55	12.47	Mag
			205.15	78.06	227.44	141.21	336.96	279.74	204.84	240.51	240.94	120.27	Phase
144	167.53	1989.30	1190.38	185.67	208.77	820.69	48.73	16.31	12.99	70.26	12.37	9.68	Mag
			236.07	155.57	109.63	146.18	11.19	274.55	274.09	251.93	21.39	182.60	Phase
145	115.35	1117.55	187.78	38.30	436.18	762.06	5.21	23.44	9.18	51.31	20.39	4.81	Mag
			208.05	39.37	213.69	134.24	209.99	331.59	91.83	306.07	23.97	132.88	Phase
146	88.32	1008.16	129.45	25.05	442.89	588.58	8.27	17.70	11.68	28.87	11.45	7.57	Mag
			172.91	29.43	224.65	137.12	209.21	335.58	66.12	324.37	60.41	159.57	Phase

$\mu_{Nom} = 0.13$

POINT	MEAN	1/2P-P	1P	2P	3P	4P	5P	6P	7P	8P	9P	10P	
147	92.43	586.41	99.76	27.05	220.00	333.16	9.91	9.74	6.66	7.35	3.94	4.09	Mag
			147.58	351.56	240.38	140.55	332.25	352.92	133.39	321.25	82.31	144.52	Phase
148	97.56	940.26	148.36	27.67	369.93	594.20	6.46	17.41	10.66	28.50	6.86	7.38	Mag
			178.72	15.95	220.56	142.20	25.07	344.26	14.88	328.77	8.28	169.74	Phase
149	136.15	1100.82	247.21	28.62	487.59	699.87	6.39	28.97	16.56	62.65	17.12	7.79	Mag
			222.17	52.82	225.37	144.25	269.51	341.34	114.03	298.74	328.80	84.68	Phase

Table III. - Continued

(o) Continued

Run 7

$\mu_{Nom} = 0.13$

POINT	MEAN	1/2P-P	1P	2P	3P	4P	5P	6P	7P	8P	9P	10P	
150	164.12	1749.64	1003.82 225.75	270.68 134.94	168.22 203.49	756.75 143.11	14.49 346.26	35.89 342.14	30.83 151.83	88.15 276.52	12.00 321.28	17.36 181.53	Mag Phase
151	158.65	1995.19	1237.56 239.02	242.09 166.24	226.10 125.21	732.65 144.00	57.09 346.11	9.07 153.64	15.27 260.80	78.37 265.77	17.51 48.33	11.20 208.85	Mag Phase
152	103.40	1108.23	260.55 225.75	26.34 69.72	445.74 221.13	171.80 147.61	4.65 249.38	31.25 346.17	18.79 111.59	66.90 300.62	14.88 349.18	3.73 110.17	Mag Phase
153	79.53	955.70	133.04 183.77	23.65 10.86	384.90 224.26	600.89 140.69	1.62 274.35	14.89 339.84	6.16 46.62	29.26 327.03	10.01 24.38	10.92 169.58	Mag Phase
154	-22.41	456.92	111.41 164.09	24.50 358.09	139.12 189.97	311.77 141.76	21.10 36.81	11.36 358.12	4.34 39.64	11.73 308.54	4.89 56.78	7.95 172.33	Mag Phase
155	8.81	933.14	175.34 181.29	30.82 21.52	407.02 211.64	578.05 144.73	11.69 14.08	18.55 342.08	8.88 16.55	28.15 313.13	7.14 357.07	11.31 174.98	Mag Phase
156	21.16	1179.17	318.12 204.04	100.27 62.51	515.79 216.95	707.75 137.49	10.33 315.60	30.07 319.28	15.00 92.97	50.71 272.49	15.31 271.64	5.68 126.99	Mag Phase
157	21.33	1773.29	1013.27 224.05	244.32 133.37	216.70 219.61	776.32 140.83	24.73 335.09	48.71 323.83	22.05 119.88	69.42 283.86	16.64 340.32	8.23 166.12	Mag Phase
158	11.19	2018.43	1208.68 237.06	201.16 164.76	137.42 178.53	777.67 135.92	63.15 358.87	15.08 292.00	8.53 86.13	79.24 263.47	11.18 50.73	3.19 222.21	Mag Phase
159	-16.63	1086.22	280.95 216.90	56.98 76.31	453.74 219.11	718.77 142.54	7.55 320.64	32.05 333.32	17.62 109.09	49.49 277.23	10.24 254.36	7.93 158.21	Mag Phase



Table III. - Continued

(o) Continued

Run 7

 $\mu_{\text{Nom}} = 0.13$ 

POINT	MEAN	1/2P-P	1P	2P	3P	4P	5P	6P	7P	8P	9P	10P	
160	-28.86	967.22	164.20 185.41	29.86 11.30	404.22 213.51	604.18 138.59	12.47 347.33	18.96 334.12	6.38 33.69	34.15 299.53	11.23 7.40	13.91 164.98	Mag Phase
161	-123.36	439.65	143.13 171.66	22.10 336.41	126.73 148.46	273.28 147.15	23.89 60.49	8.60 9.29	5.83 64.78	10.64 300.10	6.30 34.19	4.41 175.93	Mag Phase
162	-74.79	838.16	215.37 184.07	27.99 28.05	356.69 215.74	525.32 143.19	10.84 45.10	15.77 343.64	6.81 0.49	20.62 293.71	5.16 324.86	12.23 179.54	Mag Phase
163	-58.59	1167.15	307.71 203.82	90.40 66.97	503.90 216.06	701.45 132.38	11.41 330.28	30.14 312.06	9.84 29.25	26.60 249.09	5.50 310.41	5.29 90.41	Mag Phase
164	-56.98	1635.96	938.70 218.89	229.10 113.84	158.51 214.87	755.15 129.15	20.44 340.52	59.21 302.04	25.39 50.16	49.29 241.45	11.60 306.77	6.46 174.51	Mag Phase
165	-59.16	1913.32	1166.05 236.43	177.99 162.98	95.41 135.54	775.07 133.40	47.63 355.29	31.41 300.67	10.56 356.15	35.78 263.43	8.88 62.34	1.51 95.24	Mag Phase
166	-105.16	1070.84	289.45 215.06	51.68 76.93	449.00 222.11	690.16 144.35	13.78 327.16	30.93 335.75	13.17 70.72	33.01 264.05	2.15 72.87	6.71 152.23	Mag Phase
167	-129.38	869.20	164.83 182.22	17.87 0.55	324.18 215.47	577.27 140.74	11.56 1.51	17.03 346.45	9.92 15.15	24.50 299.56	8.12 21.94	14.23 160.40	Mag Phase

Table III. - Continued

(o) Continued

Run 7

 $\mu_{\text{Nom}} = 0.16$ 

POINT	MEAN	1/2P-P	1P	2P	3P	4P	5P	6P	7P	8P	9P	10P	
168	-103.52	426.00	139.46 173.02	23.16 348.37	101.42 130.49	272.04 150.04	31.02 66.49	8.83 4.58	5.16 66.80	9.85 301.50	4.46 53.57	4.40 175.87	Mag Phase
169	-67.76	751.54	215.03 184.91	21.99 0.53	266.32 215.37	503.69 143.54	23.88 50.90	15.21 338.22	9.70 356.52	18.13 297.48	1.82 321.35	10.62 168.16	Mag Phase
170	-62.90	1557.26	544.79 188.20	221.32 60.15	625.87 238.26	666.12 135.19	30.35 337.21	28.20 302.39	15.66 47.22	41.96 239.95	7.42 186.63	16.14 113.56	Mag Phase
171	-85.21	1707.40	1008.25 226.49	227.93 140.26	109.07 136.47	737.98 138.11	32.55 5.52	40.04 327.32	18.65 51.83	39.17 248.99	7.99 254.70	8.54 202.67	Mag Phase
172	-79.81	1930.17	1209.25 239.48	201.27 173.69	166.07 91.69	745.57 133.62	54.01 10.33	30.06 302.08	17.23 61.54	42.69 250.78	1.67 257.80	4.24 170.53	Mag Phase
173	-117.26	1456.75	520.74 194.70	223.89 72.47	514.13 243.84	663.37 137.45	25.20 358.31	38.23 311.64	24.89 69.03	38.32 241.04	2.24 84.48	12.83 126.28	Mag Phase
174	-120.88	476.84	143.00 172.06	30.70 359.03	201.95 118.32	255.23 154.20	28.32 75.66	7.84 16.04	5.89 46.69	9.89 317.97	7.02 61.81	1.60 214.19	Mag Phase
175	-37.87	487.59	114.02 160.28	27.27 336.63	124.74 150.38	337.19 148.96	27.35 69.79	10.94 6.10	6.33 22.25	12.95 329.85	3.10 32.84	8.95 185.66	Mag Phase
176	-6.67	847.29	188.95 186.96	21.33 6.85	308.94 220.65	560.43 147.84	21.30 52.18	16.84 346.67	11.85 13.15	26.67 304.81	4.36 351.39	11.17 183.98	Mag Phase
177	5.17	1680.75	578.67 192.25	268.12 63.96	695.64 241.87	684.51 143.64	44.69 344.29	35.18 319.36	28.45 109.69	50.58 243.77	13.90 202.89	16.74 105.09	Mag Phase

Table III. - Continued

Run 7													
(o) Continued													
$\mu_{\text{Nom}} = 0.16$													
POINT	MEAN	1/2P-P	1P	2P	3P	4P	5P	6P	7P	8P	9P	10P	
178	2.26	1882.00	1133.84 233.91	250.73 157.61	194.14 140.31	717.57 142.48	54.20 5.63	22.31 340.25	15.36 77.80	57.81 258.01	11.03 355.31	11.93 185.63	Mag Phase
179	-33.95	2058.12	1331.18 241.52	228.39 176.83	182.80 104.31	689.61 128.86	68.44 9.41	7.17 213.77	12.54 48.51	69.45 229.74	10.23 169.96	17.49 212.97	Mag Phase
180	-46.55	1178.92	376.56 222.90	60.37 131.37	379.60 221.03	721.57 137.55	9.44 5.91	42.58 325.90	36.65 80.82	63.78 233.79	5.10 262.12	13.08 151.27	Mag Phase
181	-36.21	463.02	129.63 168.59	19.96 333.44	122.33 165.94	310.28 146.99	27.27 57.51	9.46 359.28	6.21 15.84	8.86 318.23	2.54 77.58	6.61 182.27	Mag Phase
182	54.17	551.11	89.45 161.26	28.01 11.77	135.99 214.50	388.35 136.26	19.09 41.42	12.25 334.39	4.96 25.15	9.08 325.43	3.44 265.89	8.17 146.45	Mag Phase
183	68.15	874.13	157.01 190.71	25.88 29.03	300.50 237.45	573.95 146.54	21.83 54.15	17.84 346.16	9.56 21.84	22.36 331.06	0.94 64.80	6.47 202.84	Mag Phase
184	90.31	1199.09	385.94 231.53	53.90 161.94	384.16 233.26	681.51 140.96	19.43 350.53	35.16 339.99	30.30 93.63	46.00 259.44	14.04 349.44	3.55 118.88	Mag Phase
185	90.50	1930.60	1192.49 238.39	285.12 163.87	175.66 144.52	669.53 147.34	64.98 6.29	7.02 111.38	11.86 185.32	54.24 282.74	14.54 41.00	9.03 271.05	Mag Phase
186	70.11	2046.64	1377.63 244.40	246.15 176.80	187.34 94.08	627.68 134.68	68.07 2.11	25.31 207.57	15.03 299.59	48.53 269.92	6.38 225.29	22.59 270.97	Mag Phase
187	43.11	1196.15	394.06 234.21	56.89 156.35	366.06 223.22	688.60 144.40	13.59 345.02	40.60 349.67	30.55 106.11	47.19 267.94	11.21 345.20	3.08 148.99	Mag Phase
188	31.34	486.89	113.82 171.75	28.83 353.06	116.18 203.56	357.34 151.80	31.44 54.59	14.14 8.10	6.79 49.42	9.63 336.12	3.44 32.26	5.92 196.65	Mag Phase

Table III. - Continued

(o) Continued

Run 7

 $\mu_{\text{Nom}} = 0.20$ 

POINT	MEAN	1/2P-P	1P	2P	3P	4P	5P	6P	7P	8P	9P	10P	
189	92.45	562.43	99.58 153.13	25.08 3.99	133.42 251.40	368.00 147.23	27.96 52.93	10.78 347.00	1.59 93.22	14.43 320.59	1.68 66.82	11.59 147.71	Mag Phase
190	79.42	839.00	174.82 193.15	32.65 1.24	255.95 252.58	570.94 155.18	26.36 80.68	17.71 355.58	10.64 48.09	22.15 331.71	10.95 15.41	4.81 198.51	Mag Phase
191	106.07	1627.60	715.87 205.64	258.74 85.01	535.07 266.86	627.27 146.23	41.21 25.24	45.86 317.54	7.22 110.45	48.88 285.25	18.55 233.74	17.63 129.96	Mag Phase
192	62.25	1649.01	1013.30 227.73	304.64 145.51	93.60 192.44	609.94 143.69	25.07 105.81	41.08 338.29	24.01 117.28	51.71 292.89	16.70 289.07	17.22 227.55	Mag Phase
193	80.61	1950.43	1310.93 243.71	313.99 181.74	236.56 87.98	542.95 137.22	66.35 357.41	39.00 210.50	22.62 343.15	61.95 283.97	17.68 223.20	19.33 280.24	Mag Phase
194	67.24	2025.39	1406.80 248.06	294.73 191.81	359.26 81.51	546.05 132.68	81.66 10.71	46.61 232.43	31.45 350.88	55.37 295.59	21.18 235.05	22.70 303.08	Mag Phase
195	48.08	1161.98	441.15 243.41	72.93 211.78	252.16 234.82	648.50 152.40	9.04 43.75	38.69 359.34	38.38 114.98	51.92 285.93	9.07 342.55	4.09 206.11	Mag Phase
196	69.18	482.62	99.70 165.49	32.23 348.32	60.90 226.17	363.77 156.21	29.89 59.17	13.37 9.10	6.32 78.18	14.04 341.27	1.79 27.28	10.22 190.73	Mag Phase
197	20.14	464.85	114.71 169.42	29.83 349.41	41.68 29.46	318.40 154.52	29.53 58.15	11.92 5.40	5.24 49.18	12.10 335.35	1.55 15.38	8.76 203.52	Mag Phase
198	35.04	723.04	172.33 183.17	33.40 342.91	130.84 240.85	534.85 140.69	30.27 58.70	15.82 339.51	5.32 52.04	24.01 327.41	9.88 353.82	4.11 170.10	Mag Phase

Table III. - Continued

Run 7													
(o) Continued													
$\mu_{\text{Nom}} = 0.20$													
POINT	MEAN	1/2P-P	1P	2P	3P	4P	5P	6P	7P	8P	9P	10P	
199	45.45	1576.78	569.57 198.49	196.19 72.29	582.20 265.12	652.05 145.94	32.12 7.52	35.97 331.21	22.19 120.99	46.23 287.29	12.22 259.36	13.60 129.37	Mag Phase
200	5.99	1880.31	1198.44 235.39	266.13 171.21	242.10 104.22	615.66 134.78	51.01 5.14	18.76 271.00	12.44 62.27	60.44 273.64	9.40 268.58	8.10 233.68	Mag Phase
201	-13.61	1991.60	1376.45 243.86	244.74 195.65	272.02 70.33	591.85 123.13	75.76 2.84	41.03 236.94	34.95 22.12	73.82 279.42	23.78 210.27	19.00 277.05	Mag Phase
202	13.70	1475.95	564.10 201.48	206.07 79.91	474.93 271.30	645.29 141.91	19.35 354.02	41.82 334.08	30.74 126.07	53.12 274.17	13.41 238.35	16.53 127.74	Mag Phase
203	36.76	419.78	117.81 166.67	21.58 335.73	67.55 84.65	294.07 156.11	32.57 60.70	10.33 6.86	4.66 38.19	10.01 343.52	2.30 0.66	7.97 218.22	Mag Phase
204	-21.02	404.91	132.36 166.75	25.99 334.69	109.69 80.20	262.36 152.55	32.28 62.39	10.41 4.83	3.78 32.41	11.52 326.21	2.72 47.45	8.89 227.50	Mag Phase
205	-22.28	657.07	192.76 185.56	43.20 359.59	104.94 152.70	460.85 135.26	31.75 49.72	14.64 338.51	4.42 15.22	19.90 308.37	8.59 339.80	10.35 185.22	Mag Phase
206	-30.44	1278.86	425.93 202.75	121.97 74.22	438.16 252.81	626.21 137.12	24.63 30.80	29.97 330.01	16.71 109.55	35.70 268.93	9.09 256.73	15.56 167.95	Mag Phase
207	-54.22	1781.83	1072.02 228.03	237.76 158.76	201.04 79.70	645.61 132.58	29.71 13.42	38.56 311.75	18.34 75.94	41.58 265.82	12.98 257.42	11.25 181.13	Mag Phase
208	-71.60	2062.98	1310.24 239.69	250.68 190.85	413.65 66.93	624.41 127.60	80.58 7.52	41.03 286.28	38.03 58.64	49.39 272.35	7.28 166.85	3.12 198.18	Mag Phase
209	-73.02	1037.00	262.87 218.03	19.34 351.78	410.12 245.88	605.71 137.09	10.23 54.06	25.28 342.16	17.51 80.35	34.90 272.71	1.42 243.39	9.37 167.36	Mag Phase

Table III. - Continued

(o) Concluded

$\mu_{Nom} = 0.20$

Run 7

POINT	MEAN	1/2P-P	1P	2P	3P	4P	5P	6P	7P	8P	9P	10P	
210	-54.06	695.25	135.22 183.13	33.51 337.41	152.86 291.32	496.33 144.12	10.87 16.24	19.45 5.40	4.41 75.46	25.51 322.94	3.35 80.97	12.34 185.55	Mag Phase

Table III. - Continued

(p) Fixed-system strain-gage balance rolling moment, in-lbs.

Run 7

$\mu_{Nom} = 0.06$

POINT	MEAN	1/2P-P	1P	2P	3P	4P	5P	6P	7P	8P	9P	10P	
126	-52.39	405.50	89.25 43.11	85.65 105.29	26.49 102.98	217.92 11.76	18.55 293.49	60.20 252.49	6.56 213.20	39.29 187.38	7.93 183.35	2.18 350.72	Mag Phase

$\mu_{Nom} = 0.07$

POINT	MEAN	1/2P-P	1P	2P	3P	4P	5P	6P	7P	8P	9P	10P	
127	-83.96	297.75	83.77 97.02	10.09 189.02	48.06 122.46	186.76 29.82	12.92 178.04	66.10 286.14	9.61 274.47	44.86 266.60	9.99 251.40	2.16 124.11	Mag Phase

$\mu_{Nom} = 0.08$

POINT	MEAN	1/2P-P	1P	2P	3P	4P	5P	6P	7P	8P	9P	10P	
128	-155.57	434.85	226.76 147.06	129.40 262.57	83.35 161.02	154.53 24.29	29.56 209.99	44.35 293.08	7.77 121.89	33.10 260.68	14.12 254.03	6.96 15.02	Mag Phase
128A	-211.86	1098.86	660.42 168.97	362.72 238.49	170.95 101.07	271.88 46.80	63.00 319.00	33.60 311.51	24.26 247.50	45.27 282.54	22.44 252.60	12.07 202.26	Mag Phase

$\mu_{Nom} = 0.09$

POINT	MEAN	1/2P-P	1P	2P	3P	4P	5P	6P	7P	8P	9P	10P	
129	-243.77	1268.74	812.04 176.02	305.69 235.49	273.13 109.12	297.68 51.87	76.26 338.92	19.90 293.95	33.03 258.51	45.81 279.37	21.46 256.01	25.51 255.19	Mag Phase
130	-64.72	234.59	88.42 77.49	35.52 149.06	49.08 99.23	121.38 15.98	16.82 196.16	48.76 256.56	10.99 222.01	27.74 210.90	1.63 203.78	3.19 269.06	Mag Phase

Table III. - Continued

(p) Continued

Run 7

 $\mu_{\text{Nom}} = 0.09$ 

POINT	MEAN	1/2P-P	1P	2P	3P	4P	5P	6P	7P	8P	9P	10P	
131	-85.27	283.06	130.15 121.23	47.54 213.44	45.54 154.67	169.74 30.52	26.27 205.03	53.60 262.02	6.80 265.16	29.06 259.49	3.95 302.24	1.23 333.82	Mag Phase
132	-127.20	686.29	456.27 147.81	219.02 190.61	128.34 185.90	206.37 20.97	63.41 246.00	35.18 265.46	4.99 171.75	39.55 243.54	16.92 220.03	8.68 272.54	Mag Phase
133	-177.23	1094.51	705.30 168.52	348.52 240.54	200.22 87.93	236.44 46.68	81.69 310.78	32.57 307.23	15.41 243.06	39.43 265.53	16.68 248.88	11.42 225.35	Mag Phase
134	-53.40	225.94	88.48 83.11	47.41 161.34	50.87 104.05	125.56 21.66	18.26 198.96	47.69 257.56	14.38 212.07	25.35 211.49	0.83 327.34	3.20 264.82	Mag Phase
135	-60.94	198.95	100.53 86.94	21.86 150.33	36.40 98.29	102.92 33.75	11.66 213.12	37.76 256.86	14.07 222.20	24.20 187.35	2.39 106.15	1.80 283.88	Mag Phase
136	-91.48	289.38	159.08 120.41	60.83 193.99	52.25 166.53	142.69 34.60	29.59 187.48	33.95 255.00	10.49 272.50	23.18 239.06	1.19 101.09	0.66 0.99	Mag Phase
137	-121.00	675.22	464.73 146.11	233.67 187.92	146.65 190.03	188.82 27.67	61.19 244.61	24.26 262.88	3.20 176.73	31.39 264.15	10.60 213.43	5.35 294.81	Mag Phase
138	-167.72	1047.81	683.13 165.38	366.66 235.32	171.03 90.65	226.33 60.01	84.14 310.62	19.14 307.14	8.42 309.94	24.27 288.09	22.39 275.63	8.15 175.37	Mag Phase
139	-111.42	304.63	161.42 125.94	68.08 206.21	43.13 174.85	142.13 38.23	24.32 185.00	38.98 248.60	9.41 243.41	22.71 228.53	0.85 16.21	1.05 67.20	Mag Phase
140	-82.57	216.22	111.54 90.61	23.07 169.65	63.57 69.94	108.56 40.94	7.97 245.56	37.26 246.59	13.06 220.40	19.68 194.03	1.69 84.91	1.08 316.98	Mag Phase



Table III. - Continued

(p) Continued

Run 7

 $\mu_{\text{Nom}} = 0.09$ 

POINT	MEAN	1/2P-P	1P	2P	3P	4P	5P	6P	7P	8P	9P	10P	
141	-54.63	276.04	103.26 90.30	55.53 145.67	29.86 85.54	142.19 8.03	21.72 234.00	56.36 268.52	20.57 228.37	16.28 214.32	1.91 115.64	2.87 284.86	Mag Phase
142	-94.59	321.10	166.23 125.57	82.93 185.44	65.58 115.87	175.81 34.61	61.61 202.42	52.94 260.98	23.21 246.54	35.59 252.86	12.37 257.76	9.08 316.78	Mag Phase
143	-128.93	786.59	514.51 148.62	246.05 182.95	93.35 178.04	238.33 21.52	82.65 246.01	39.06 286.18	24.67 224.84	56.03 262.54	15.33 249.26	6.63 300.67	Mag Phase
144	-186.16	1254.21	798.75 169.06	323.72 236.99	256.90 88.67	289.33 48.38	101.81 311.96	44.94 303.61	31.49 231.03	48.87 267.53	20.56 237.56	14.11 265.45	Mag Phase
145	-99.08	337.35	167.19 126.62	49.34 197.51	43.32 121.62	190.25 23.60	33.46 188.77	59.85 251.86	21.15 242.33	43.70 238.67	9.03 257.69	2.68 32.79	Mag Phase
146	-45.65	270.68	113.39 89.63	49.38 144.56	44.33 91.69	134.28 12.58	26.13 221.97	55.88 266.22	15.95 244.53	16.41 222.63	1.11 214.74	2.59 286.37	Mag Phase

 $\mu_{\text{Nom}} = 0.13$ 

POINT	MEAN	1/2P-P	1P	2P	3P	4P	5P	6P	7P	8P	9P	10P	
147	-5.17	172.03	74.64 57.51	9.49 295.37	59.60 87.78	73.87 37.17	22.15 284.30	36.83 264.31	17.68 253.10	14.18 206.75	1.44 39.28	1.17 208.70	Mag Phase
148	-14.16	280.10	118.51 100.00	11.37 139.31	91.74 86.83	115.13 34.11	25.66 299.90	49.31 255.13	10.70 236.77	20.87 249.66	1.11 199.55	2.66 257.42	Mag Phase
149	-61.50	367.78	214.30 145.19	50.43 224.43	77.74 122.63	181.75 28.20	44.82 243.95	45.95 272.23	13.39 231.32	38.36 261.41	3.70 236.83	6.05 321.72	Mag Phase

Table III. - Continued

(p) Continued

Run 7

 $\mu_{\text{Nom}} = 0.13$ 

POINT	MEAN	1/2P-P	1P	2P	3P	4P	5P	6P	7P	8P	9P	10P	
150	-125.24	1133.45	678.69 164.68	350.51 230.04	200.31 88.97	269.99 47.49	92.14 294.26	58.85 307.40	39.14 232.10	40.30 275.75	14.76 194.28	4.28 337.68	Mag Phase
151	-162.72	1286.81	830.26 172.95	258.80 251.70	384.68 98.04	210.60 52.86	99.48 307.32	48.91 323.48	19.91 229.04	41.12 264.14	9.77 240.86	20.87 283.27	Mag Phase
152	-81.98	395.58	223.27 149.46	72.53 227.94	83.20 122.81	175.22 33.59	47.38 248.07	49.84 271.44	14.96 255.75	44.91 240.46	5.50 240.96	3.25 351.03	Mag Phase
153	-25.04	283.99	102.73 103.31	15.94 153.74	93.45 85.27	127.65 35.85	17.71 277.17	56.18 247.84	17.00 234.98	20.29 237.22	1.35 231.89	1.97 276.35	Mag Phase
154	27.17	180.30	77.81 70.62	37.24 332.73	64.84 63.55	62.47 37.01	15.67 310.17	33.49 248.53	14.18 259.36	20.89 181.21	1.95 64.56	0.50 23.58	Mag Phase
155	25.34	289.23	129.16 99.66	9.69 170.85	109.54 82.78	100.66 38.60	32.87 302.94	49.51 255.16	16.52 269.45	13.77 210.19	1.33 351.27	2.49 290.36	Mag Phase
156	-20.68	379.90	240.07 136.18	50.94 210.51	81.26 144.79	163.50 23.92	35.56 256.48	52.70 249.56	12.29 238.28	23.77 242.48	10.30 271.28	6.53 244.02	Mag Phase
157	-94.58	1053.87	663.03 163.13	340.26 231.76	160.69 103.04	245.44 52.60	84.58 308.51	48.12 297.66	24.49 255.53	35.01 258.04	9.94 211.01	8.39 243.56	Mag Phase
158	-133.78	1158.61	791.52 171.47	251.08 251.98	320.12 101.13	189.03 49.38	99.32 323.76	40.61 305.93	6.50 293.13	33.75 240.70	13.35 217.33	29.93 263.37	Mag Phase
159	-46.33	369.64	227.63 144.66	73.27 213.98	87.25 148.18	156.39 32.19	35.30 259.84	56.37 258.33	10.74 246.61	33.79 236.60	8.89 293.90	2.68 297.18	Mag Phase

Table III. - Continued

(p) Continued

Run 7

 $\mu_{\text{Nom}} = 0.13$ 

POINT	MEAN	1/2P-P	1P	2P	3P	4P	5P	6P	7P	8P	9P	10P	
160	6.76	287.42	123.93 103.84	19.37 163.36	107.74 83.95	109.13 36.97	26.30 296.52	55.32 241.16	14.92 245.54	13.95 209.22	2.06 269.14	1.66 294.06	Mag Phase
161	4.65	221.99	96.61 81.10	48.22 342.76	83.01 52.16	58.55 49.30	21.30 12.32	26.39 263.42	13.83 285.42	17.36 185.89	1.73 124.28	0.38 160.10	Mag Phase
162	0.16	242.47	154.44 102.33	11.88 116.54	74.95 84.40	85.06 46.33	23.24 308.00	45.13 256.92	12.78 260.72	10.15 169.03	0.18 330.54	1.32 291.32	Mag Phase
163	-61.35	342.97	222.37 134.98	73.19 180.65	78.89 147.59	144.39 25.91	38.03 254.44	50.36 238.29	10.73 255.26	21.08 213.83	5.37 246.15	6.88 250.69	Mag Phase
164	-137.28	954.79	621.89 159.26	330.88 218.61	111.04 132.73	216.92 37.55	74.89 299.28	45.15 274.57	14.50 251.14	24.07 244.40	6.73 213.82	4.86 225.67	Mag Phase
165	-170.59	1111.89	757.74 170.77	290.63 243.05	251.20 101.58	173.28 58.88	100.71 320.22	36.30 291.23	3.88 342.26	25.68 224.52	9.25 218.55	19.86 261.66	Mag Phase
166	-102.49	347.32	228.79 144.03	70.51 211.82	90.59 157.30	133.68 38.22	33.74 271.86	54.02 255.01	3.69 248.66	28.65 215.35	6.89 295.43	3.90 302.19	Mag Phase
167	-55.39	229.58	116.62 101.66	16.38 192.52	89.99 84.23	98.94 52.85	17.54 285.10	52.46 237.43	9.78 258.49	23.70 204.80	3.75 298.14	2.55 312.05	Mag Phase

Table III. - Continued

(p) Continued

Run 7

 $\mu_{\text{Nom}} = 0.16$ 

POINT	MEAN	1/2P-P	1P	2P	3P	4P	5P	6P	7P	8P	9P	10P	
168	12.15	208.69	86.87 78.24	65.45 343.48	82.18 49.11	64.45 54.30	18.77 24.37	29.56 262.52	12.64 262.79	14.96 159.22	2.54 15.95	0.30 251.04	Mag Phase
169	22.27	230.25	141.04 101.92	14.30 356.05	66.00 68.40	95.18 54.65	20.44 345.64	38.83 255.13	14.22 236.89	5.40 142.35	2.13 24.40	1.54 311.73	Mag Phase
170	-29.52	533.92	298.53 133.22	133.91 154.88	184.18 159.67	132.72 34.84	48.14 256.48	48.73 245.66	8.06 270.35	11.55 211.69	9.69 290.42	8.59 241.63	Mag Phase
171	-103.41	965.33	642.17 165.99	331.17 234.64	111.92 100.25	178.51 55.75	75.30 341.40	45.89 288.90	9.83 282.36	21.25 230.63	11.10 256.92	4.59 270.62	Mag Phase
172	-150.67	1133.74	791.54 174.25	219.48 247.73	282.77 100.84	146.17 59.69	106.74 338.09	36.45 288.11	15.87 94.67	33.64 214.27	3.94 304.36	25.47 280.82	Mag Phase
173	-78.74	495.32	286.01 138.33	92.32 157.59	155.93 166.96	130.17 40.53	34.83 258.58	49.99 247.79	7.93 281.10	31.74 201.17	4.49 280.91	10.79 247.20	Mag Phase
174	29.11	235.88	84.00 74.45	70.06 354.15	96.97 50.42	63.02 55.24	26.63 38.91	25.71 284.23	11.92 278.82	18.46 181.38	3.41 59.25	0.41 241.03	Mag Phase
175	42.77	236.51	67.94 63.02	61.85 357.49	92.05 53.86	66.66 45.20	21.20 18.26	44.15 268.62	8.67 233.14	16.84 203.58	4.51 59.23	0.67 36.39	Mag Phase
176	29.89	285.42	122.58 105.26	16.91 49.51	83.94 68.94	106.09 46.05	28.79 356.01	50.17 270.37	16.06 267.72	7.46 225.90	1.85 110.95	1.47 253.77	Mag Phase
177	-28.22	591.16	351.52 140.03	183.59 149.59	143.41 155.25	165.32 24.06	48.41 259.64	44.75 279.99	26.62 268.98	32.03 238.21	7.99 269.80	12.54 222.19	Mag Phase

Table III. - Continued

(p) Continued

$\mu_{Nom} = 0.16$

Run 7	POINT	MEAN	1/2P-P	1P	2P	3P	4P	5P	6P	7P	8P	9P	10P	
	178	-107.93	1149.68	740.46 171.89	295.11 243.14	269.35 87.98	182.91 54.81	106.08 337.30	52.60 308.10	11.27 271.79	33.29 244.83	13.09 275.46	10.03 249.77	Mag Phase
	179	-158.59	1326.83	880.12 175.10	204.08 244.63	408.65 100.26	159.88 44.96	119.75 327.70	44.77 285.04	15.01 152.96	41.32 202.84	4.09 232.80	25.87 263.90	Mag Phase
	180	-49.71	430.03	270.49 153.71	81.22 230.30	104.84 151.58	140.18 31.22	40.58 309.92	59.82 256.14	9.75 201.61	43.69 201.48	12.88 280.96	2.97 290.40	Mag Phase
	181	65.73	232.41	76.69 73.48	55.55 349.84	109.42 53.89	64.35 47.03	21.78 21.52	35.76 266.40	8.85 263.99	8.80 184.58	3.27 64.04	0.43 9.30	Mag Phase
	182	78.77	196.30	56.83 62.48	35.20 36.29	60.89 38.50	90.25 36.49	8.50 339.57	39.63 250.61	4.02 221.40	14.39 198.80	5.66 33.43	1.63 323.83	Mag Phase
	183	39.73	250.95	105.26 109.51	20.84 76.96	27.63 81.93	123.91 44.33	18.12 0.85	52.00 270.75	16.29 262.08	15.81 238.92	1.99 90.03	1.53 280.20	Mag Phase
	184	-8.18	468.29	294.50 158.85	67.42 223.65	96.78 152.51	167.62 31.66	43.85 289.00	50.93 276.54	27.66 213.46	22.98 216.31	6.68 271.42	4.53 328.61	Mag Phase
	185	-104.58	1293.17	806.26 175.46	281.75 249.79	378.66 102.85	202.35 64.01	103.76 327.05	52.91 329.72	18.83 281.77	29.79 254.58	14.44 273.25	16.07 290.66	Mag Phase
	186	-135.49	1492.94	941.80 177.74	187.77 231.59	519.09 109.86	192.47 55.99	129.48 321.05	44.30 303.33	17.65 226.12	40.77 233.38	12.02 271.26	18.44 301.80	Mag Phase
	187	-71.56	481.34	301.89 160.76	90.15 244.64	106.90 142.60	167.49 35.00	39.85 293.99	54.85 284.75	24.31 233.44	39.13 224.89	7.01 276.25	3.22 307.40	Mag Phase
	188	19.29	216.59	73.41 73.72	37.55 342.78	98.08 46.35	76.39 47.41	25.58 354.78	36.19 273.28	9.20 293.61	9.84 202.43	4.37 73.09	0.46 247.60	Mag Phase

Table III. Continued

(p) Continued

Run 7

 $\mu_{\text{Nom}} = 0.20$ 

POINT	MEAN	1/2P-P	1P	2P	3P	4P	5P	6P	7P	8P	9P	10P	
189	10.62	197.88	63.56 52.80	42.67 347.45	45.99 55.36	94.55 47.59	14.93 61.78	32.95 245.18	19.39 241.72	5.67 200.12	3.86 113.71	1.40 243.72	Mag Phase
190	-4.62	231.81	112.13 108.83	30.97 358.72	48.56 96.83	125.46 58.58	36.32 92.09	44.24 274.16	26.87 266.73	8.00 174.18	4.50 117.77	2.68 291.25	Mag Phase
191	-59.33	761.60	479.37 151.30	254.48 177.99	191.83 168.17	205.08 43.80	49.88 275.25	32.43 299.95	28.06 302.85	10.45 223.11	1.52 332.99	11.66 278.10	Mag Phase
192	-113.12	1100.49	682.91 167.82	308.49 218.72	193.78 115.79	254.06 65.82	63.08 354.15	41.46 318.62	25.53 288.09	13.78 165.24	5.57 224.75	8.63 320.44	Mag Phase
193	-162.87	1342.20	895.56 177.55	204.68 245.30	446.51 113.09	182.13 80.77	97.36 350.03	28.32 356.40	28.58 10.89	21.09 208.29	16.21 352.53	15.05 265.83	Mag Phase
194	-174.33	1447.70	964.78 181.43	151.50 241.36	510.98 120.92	163.07 77.30	121.75 345.50	26.66 341.16	14.79 42.70	20.74 200.65	8.90 48.58	16.72 319.45	Mag Phase
195	-86.64	504.22	331.02 170.64	95.42 252.78	139.70 153.64	159.74 57.89	37.39 36.81	42.26 300.68	14.89 208.50	22.15 203.69	4.57 317.83	4.59 301.62	Mag Phase
196	36.88	217.02	59.18 58.06	66.98 332.90	68.32 54.82	89.70 55.29	26.76 80.09	36.93 263.25	14.67 263.00	10.83 182.18	3.27 87.57	0.51 295.25	Mag Phase
197	64.16	203.74	55.72 65.26	73.64 339.48	57.07 32.88	84.87 56.94	18.91 70.18	32.18 267.02	9.70 254.31	17.61 170.50	4.73 43.44	0.69 24.43	Mag Phase
198	57.91	228.40	94.51 95.40	65.52 40.51	37.68 76.74	127.42 48.04	40.73 83.23	46.62 256.04	31.34 226.54	13.27 175.93	2.92 62.62	2.17 320.32	Mag Phase

Table III. Continued

Run 7													
(p) Continued													
$\mu_{\text{Nom}} = 0.20$													
POINT	MEAN	1/2P-P	1P	2P	3P	4P	5P	6P	7P	8P	9P	10P	
199	-8.11	579.19	324.53 147.32	117.31 147.80	230.77 172.76	156.61 53.69	17.52 204.01	44.92 271.53	22.49 241.23	17.94 245.36	6.57 358.58	12.82 256.95	Mag Phase
200	-103.35	1154.19	771.37 173.46	237.71 235.42	304.22 98.19	177.60 72.40	87.41 353.70	33.62 325.39	24.27 331.48	21.34 206.26	16.58 314.84	21.21 264.18	Mag Phase
201	-160.60	1313.50	918.25 177.55	149.35 223.44	395.57 107.48	151.25 70.48	117.64 334.33	18.86 314.57	7.83 66.13	22.13 209.31	9.51 59.24	32.70 296.09	Mag Phase
202	-42.99	554.48	333.06 149.09	89.84 172.26	219.78 174.60	150.01 51.18	7.03 205.02	40.15 262.82	16.69 210.38	27.12 215.42	6.48 352.01	11.91 266.90	Mag Phase
203	79.59	220.57	73.30 59.55	74.43 334.16	74.03 44.30	79.55 57.09	24.11 59.05	30.43 267.51	15.67 258.35	14.84 152.58	3.88 49.11	0.19 335.11	Mag Phase
204	103.77	229.01	69.61 56.31	83.90 332.57	76.62 41.42	78.05 57.70	27.61 67.62	28.76 255.67	13.94 245.54	18.56 160.22	4.32 40.41	0.18 123.90	Mag Phase
205	81.52	244.61	101.46 98.77	73.78 31.92	56.70 20.29	117.15 48.66	36.06 56.36	42.73 255.60	26.09 212.79	18.30 158.03	4.65 8.06	0.21 342.65	Mag Phase
206	38.05	424.64	231.28 142.25	74.40 80.06	131.39 182.05	161.46 47.45	19.36 140.73	55.48 243.30	21.25 166.98	16.04 205.80	6.82 7.77	8.86 263.24	Mag Phase
207	-50.13	982.92	680.75 167.14	254.21 223.63	152.89 102.49	177.23 59.79	56.30 352.12	34.26 277.57	22.48 288.45	27.42 181.25	11.17 277.23	14.09 272.27	Mag Phase
208	-110.47	1164.62	843.13 175.27	176.62 232.43	276.74 101.67	131.30 72.16	115.97 337.38	19.41 270.66	20.35 22.23	38.75 196.74	9.99 78.74	34.10 295.77	Mag Phase
209	-2.16	373.81	171.69 148.67	50.73 11.03	125.28 172.90	145.02 45.29	20.65 60.03	54.93 233.29	15.94 139.53	33.59 181.95	4.93 1.66	5.81 288.52	Mag Phase

Table III. Continued

(p) Concluded

$\mu_{Nom} = 0.20$

Run 7

POINT	MEAN	1/2P-P	1P	2P	3P	4P	5P	6P	7P	8P	9P	10P	
210	70.20	201.26	60.29 86.72	47.51 10.11	33.69 254.52	112.76 48.82	16.29 88.54	57.59 253.58	21.23 223.46	30.87 195.20	2.51 25.75	3.77 6.09	Mag Phase



Table III. - Continued

(q) Fixed-system strain-gage balance yawing moment, in-lbs

Run 7

$\mu_{Nom} = 0.06$

POINT	MEAN	1/2P-P	1P	2P	3P	4P	5P	6P	7P	8P	9P	10P	
126	420.97	78.03	27.77 240.81	13.12 306.83	6.42 278.97	36.82 125.83	17.11 278.32	19.37 27.67	4.30 25.15	5.22 6.37	1.60 101.31	2.33 318.63	Mag Phase

$\mu_{Nom} = 0.07$

POINT	MEAN	1/2P-P	1P	2P	3P	4P	5P	6P	7P	8P	9P	10P	
127	632.30	194.06	43.92 309.80	2.94 28.55	11.51 334.61	120.72 108.07	45.96 188.83	12.08 103.39	4.98 26.07	14.79 35.06	1.67 69.16	1.48 40.70	Mag Phase

$\mu_{Nom} = 0.08$

POINT	MEAN	1/2P-P	1P	2P	3P	4P	5P	6P	7P	8P	9P	10P	
128	944.55	391.15	76.66 338.66	19.94 88.87	23.79 19.11	286.44 49.60	77.75 169.07	30.93 92.53	1.10 5.03	6.52 356.31	1.40 249.33	1.61 22.43	Mag Phase
128A	1378.33	535.78	137.38 348.51	28.78 12.95	63.85 329.86	410.29 337.33	38.74 165.67	33.93 317.12	21.16 333.72	11.43 279.60	4.66 223.60	5.53 208.72	Mag Phase

$\mu_{Nom} = 0.09$

POINT	MEAN	1/2P-P	1P	2P	3P	4P	5P	6P	7P	8P	9P	10P	
129	1634.22	775.70	186.67 353.62	40.15 34.73	78.91 329.87	608.94 337.11	36.59 169.58	53.96 344.38	10.61 18.77	20.65 285.25	11.76 182.40	10.01 251.48	Mag Phase
130	439.12	116.00	32.12 271.91	8.03 343.95	14.84 266.41	67.70 117.04	2.34 201.17	18.59 50.65	8.36 3.37	6.19 23.07	1.76 109.03	1.31 314.81	Mag Phase

Table III. - Continued

(q) Continued

Run 7

 $\mu_{\text{Nom}} = 0.09$ 

POINT	MEAN	1/2P-P	1P	2P	3P	4P	5P	6P	7P	8P	9P	10P	
131	655.95	210.49	51.98 312.40	11.31 42.12	8.56 16.60	137.45 71.41	43.42 159.52	25.49 52.54	10.59 357.06	4.02 8.60	2.84 51.17	1.27 39.55	Mag Phase
132	974.55	406.11	60.22 335.33	24.03 303.48	29.74 359.79	241.74 22.29	161.65 153.71	31.58 295.42	16.19 291.46	3.94 42.07	7.43 175.95	1.94 231.69	Mag Phase
133	1406.35	503.19	150.30 349.37	35.68 11.79	63.80 321.45	373.20 336.05	56.88 194.15	34.47 331.83	19.16 336.88	5.73 278.47	3.34 195.90	3.94 231.57	Mag Phase
134	450.17	103.07	31.47 278.63	9.59 354.88	14.11 275.19	63.39 123.79	2.48 190.35	15.86 31.48	10.31 343.54	4.19 44.08	1.70 101.51	0.51 305.32	Mag Phase
135	447.29	93.18	33.82 283.42	7.49 356.02	11.46 261.49	54.33 135.03	4.09 289.74	18.44 29.14	9.14 355.85	1.63 310.44	1.15 101.68	0.81 340.93	Mag Phase
136	670.07	186.76	48.59 308.32	15.93 30.00	13.14 7.26	117.07 78.14	45.74 152.20	20.58 38.46	14.42 5.13	8.62 352.19	4.19 78.39	0.84 262.12	Mag Phase
137	990.63	353.22	63.29 334.39	22.65 311.31	32.34 2.85	221.75 27.65	118.06 155.70	36.31 289.09	17.36 293.86	4.82 113.73	5.79 143.50	0.92 7.62	Mag Phase
138	1416.26	456.04	137.17 350.98	34.23 20.07	60.77 318.98	328.52 345.20	62.22 177.97	32.47 1.78	27.29 321.36	2.52 328.88	3.91 254.56	3.19 199.83	Mag Phase
139	678.70	188.31	46.59 315.87	18.56 31.35	9.89 44.00	110.40 64.71	49.80 162.58	26.57 31.92	12.37 333.45	4.27 317.52	2.72 80.47	3.96 82.25	Mag Phase
140	460.97	95.66	33.83 281.28	6.57 3.67	22.35 247.30	49.47 136.10	3.55 288.25	17.52 30.46	7.28 347.71	3.44 8.56	1.69 100.27	1.02 3.53	Mag Phase

Table III. - Continued

(q) Continued

Run 7

 $\mu_{\text{Nom}} = 0.09$ 

POINT	MEAN	1/2P-P	1P	2P	3P	4P	5P	6P	7P	8P	9P	10P	
141	461.22	125.83	36.57 280.36	9.89 343.45	11.80 237.31	78.17 121.43	7.38 220.52	19.02 46.18	9.76 357.79	5.52 338.89	1.70 77.27	1.89 285.52	Mag Phase
142	676.95	224.65	59.39 299.29	9.65 37.49	8.00 268.90	88.08 61.84	108.61 153.89	17.49 40.79	14.11 344.34	8.54 321.56	4.21 316.74	1.68 2.69	Mag Phase
143	1001.54	527.59	65.77 336.75	25.43 308.54	25.79 352.97	329.44 13.58	176.32 157.04	49.93 289.83	19.13 282.97	5.45 148.77	7.22 176.05	2.27 188.66	Mag Phase
144	1433.79	597.55	162.80 348.28	31.00 7.89	67.36 318.65	456.15 331.51	53.20 190.16	38.77 328.54	25.48 10.25	17.06 275.10	6.51 187.37	6.22 255.68	Mag Phase
145	682.42	198.28	61.94 312.80	8.29 36.76	3.85 345.37	103.74 54.63	61.76 165.12	29.45 28.68	10.07 353.49	11.48 345.71	1.54 340.74	3.45 69.60	Mag Phase
146	465.69	123.69	39.48 280.65	9.00 346.08	14.95 256.42	71.88 128.53	5.10 183.85	24.83 33.92	8.85 348.82	4.94 52.35	2.23 105.19	0.62 318.54	Mag Phase

 $\mu_{\text{Nom}} = 0.13$ 

POINT	MEAN	1/2P-P	1P	2P	3P	4P	5P	6P	7P	8P	9P	10P	
147	351.29	80.00	28.62 252.08	2.83 55.18	22.14 262.79	33.60 156.68	13.55 1.09	23.26 32.57	7.41 0.86	4.61 281.41	1.08 80.36	0.19 244.87	Mag Phase
148	470.01	151.13	41.84 279.46	2.71 25.30	28.70 263.74	93.42 121.63	6.87 345.56	19.56 22.39	6.45 344.51	6.73 357.10	1.79 95.26	1.39 213.38	Mag Phase
149	685.99	209.49	70.39 318.66	12.02 56.29	10.89 294.78	103.06 86.57	68.06 178.79	20.28 43.38	12.68 0.38	12.87 276.17	6.33 347.61	1.12 348.56	Mag Phase

Table III. - Continued

(q) Continued

Run 7

 $\mu_{\text{Nom}} = 0.13$ 

POINT	MEAN	1/2P-P	1P	2P	3P	4P	5P	6P	7P	8P	9P	10P	
150	1014.80	217.88	117.56 342.37	22.23 321.50	58.12 311.79	90.74 310.38	43.92 190.89	17.85 356.11	12.43 328.70	9.57 256.90	7.80 225.64	3.07 272.20	Mag Phase
151	1234.37	463.42	176.56 352.51	36.67 349.43	90.45 314.72	298.31 323.93	93.16 184.15	25.65 348.11	29.85 359.72	16.80 267.28	3.47 171.86	8.58 264.32	Mag Phase
152	696.09	210.76	68.09 320.59	13.80 65.54	10.81 292.72	87.66 75.51	77.34 185.68	32.45 49.29	10.66 356.88	14.28 319.26	5.90 0.76	1.42 74.29	Mag Phase
153	474.91	135.61	40.24 290.58	4.66 32.73	27.85 262.98	82.95 120.51	3.24 287.51	30.35 15.25	8.16 329.84	3.30 239.98	1.87 95.39	0.26 312.10	Mag Phase
154	362.90	68.86	26.29 253.69	3.09 97.94	21.69 248.18	24.97 150.45	7.84 338.49	19.38 23.40	5.12 336.02	1.39 332.83	1.30 120.33	0.65 30.65	Mag Phase
155	489.08	163.41	40.77 283.32	3.42 22.51	34.59 264.34	92.91 119.86	10.46 336.32	24.36 52.94	10.32 352.10	5.31 334.37	1.65 44.65	0.58 2.71	Mag Phase
156	701.50	247.05	56.80 312.83	10.03 28.50	10.70 339.60	147.99 74.85	78.75 154.27	28.87 25.40	15.55 333.14	15.43 263.52	4.77 277.71	3.15 235.86	Mag Phase
157	1034.19	253.78	114.94 339.98	22.17 331.17	52.53 323.88	129.84 332.70	61.69 174.23	26.06 1.98	12.22 343.01	6.07 283.75	5.10 242.80	5.96 262.78	Mag Phase
158	1249.93	451.65	158.44 348.50	35.59 353.51	82.64 315.81	308.52 328.97	86.36 169.25	40.60 350.00	11.47 338.73	16.89 284.73	5.90 191.37	12.31 266.30	Mag Phase
159	694.95	246.95	56.00 315.58	14.91 38.89	12.91 351.29	134.86 73.87	77.17 170.08	39.83 47.95	10.01 0.26	14.81 274.46	4.77 299.97	1.48 312.60	Mag Phase

Table III. - Continued

(q) Continued

Run 7

 $\mu_{\text{Nom}} = 0.13$ 

POINT	MEAN	1/2P-P	1P	2P	3P	4P	5P	6P	7P	8P	9P	10P	
160	505.69	162.89	41.17 287.96	5.73 14.37	31.85 262.77	100.18 106.50	4.65 348.56	26.58 37.83	6.03 323.48	2.43 351.28	1.71 50.12	0.46 3.19	Mag Phase
161	369.39	74.73	30.33 261.11	4.57 143.91	25.14 239.78	17.80 140.86	12.12 30.41	18.92 32.61	4.84 2.80	3.70 300.25	0.94 24.40	0.79 71.52	Mag Phase
162	506.91	161.77	47.77 282.86	4.25 10.96	24.36 259.00	94.38 112.00	12.95 26.31	21.53 43.45	9.09 358.86	4.30 252.34	0.22 93.81	1.91 71.57	Mag Phase
163	728.66	249.05	54.24 310.84	12.62 13.96	12.12 331.78	159.70 63.49	63.69 152.59	37.62 15.80	15.46 348.86	10.42 249.12	2.76 255.30	4.16 285.60	Mag Phase
164	1071.39	251.32	103.07 340.86	23.44 330.90	50.99 331.80	134.73 356.70	69.58 166.30	32.93 348.37	5.78 313.70	10.00 235.66	4.66 212.90	5.51 222.88	Mag Phase
165	1288.44	449.03	148.70 351.02	33.94 10.01	75.19 318.67	314.41 339.21	70.70 183.65	45.72 357.43	17.84 330.61	11.42 264.80	2.76 172.00	8.35 271.34	Mag Phase
166	734.56	257.01	54.48 316.81	14.20 40.72	13.52 2.06	154.74 67.25	61.27 170.54	44.04 44.41	8.65 357.21	16.07 273.52	3.04 254.05	1.63 311.68	Mag Phase
167	507.97	142.67	38.45 286.97	7.55 24.70	27.23 265.63	88.10 105.81	13.20 349.60	21.60 27.19	6.02 331.54	6.29 331.93	1.32 86.57	2.57 31.28	Mag Phase

Table III. - Continued

(q) Continued

Run 7

 $\mu_{\text{Nom}} = 0.16$ 

POINT	MEAN	1/2P-P	1P	2P	3P	4P	5P	6P	7P	8P	9P	10P	
168	374.16	65.36	33.30 263.56	4.09 141.82	25.13 241.35	13.03 173.93	11.51 30.12	19.62 22.20	4.76 337.35	1.30 246.61	0.73 117.95	0.63 211.17	Mag Phase
169	507.46	151.94	45.57 280.58	1.77 86.00	22.28 245.47	86.94 111.94	21.86 50.81	14.71 30.07	9.33 359.90	1.07 101.98	1.99 111.31	0.79 194.96	Mag Phase
170	727.84	246.65	39.14 300.84	24.74 349.63	27.69 334.05	125.02 59.00	110.01 124.69	38.85 1.91	10.90 314.39	10.01 228.92	1.50 249.01	3.82 230.33	Mag Phase
171	1067.71	261.73	113.50 339.89	23.23 347.18	46.69 327.65	142.99 6.66	65.94 150.50	29.20 10.35	12.47 318.87	12.71 252.32	4.64 221.30	4.59 284.51	Mag Phase
172	1287.78	424.40	154.34 348.77	38.73 2.07	83.25 317.77	276.96 353.67	85.75 187.97	52.76 16.23	19.86 319.87	13.26 276.37	3.09 188.13	8.50 277.87	Mag Phase
173	736.53	237.80	45.77 296.82	20.32 349.22	20.91 354.53	113.94 65.86	103.36 142.85	45.75 12.40	11.63 352.80	12.45 252.42	1.95 349.52	3.90 257.03	Mag Phase
174	374.68	71.13	35.96 261.45	6.21 166.83	27.11 236.54	15.24 186.60	11.39 75.24	15.88 40.01	1.55 290.45	2.96 318.25	0.61 89.18	0.78 172.55	Mag Phase
175	376.16	75.06	32.53 251.06	2.94 177.93	27.72 241.88	21.09 153.62	9.51 52.83	19.15 17.11	2.81 303.51	2.85 341.73	0.57 78.28	1.00 80.52	Mag Phase
176	501.07	159.77	53.23 283.03	4.97 348.45	24.68 243.96	88.30 119.71	19.72 54.98	15.02 63.19	7.43 13.04	5.10 342.18	2.21 52.03	1.66 142.05	Mag Phase
177	728.33	301.83	33.87 308.19	31.68 353.24	17.94 304.02	150.50 62.80	142.55 136.21	29.74 16.94	8.17 282.03	15.95 217.64	2.97 223.88	4.36 203.99	Mag Phase

Table III. - Continued

Run 7													
(q) Continued													
$\mu_{\text{Nom}} = 0.16$													
POINT	MEAN	1/2P-P	1P	2P	3P	4P	5P	6P	7P	8P	9P	10P	
178	1079.85	288.56	136.58 342.65	28.53 347.98	65.47 309.47	152.92 325.50	77.77 172.75	26.37 10.00	11.91 10.63	12.35 255.75	4.51 211.64	4.97 258.38	Mag Phase
179	1313.81	434.34	186.94 350.57	44.38 3.59	106.55 311.99	270.25 330.19	87.71 185.31	38.09 357.36	17.18 344.66	23.34 253.87	11.11 169.75	10.78 249.81	Mag Phase
180	735.87	257.43	75.04 310.04	14.07 45.60	11.76 351.17	134.24 57.22	70.57 160.56	47.80 43.48	15.00 43.51	12.38 224.66	3.70 269.51	1.33 18.21	Mag Phase
181	373.86	79.59	33.51 251.33	2.78 158.58	30.02 246.33	26.28 143.49	17.53 42.85	14.97 19.49	2.46 336.52	0.90 308.25	0.22 87.82	0.36 95.63	Mag Phase
182	365.83	61.31	26.97 249.39	2.65 355.22	19.04 224.99	31.22 161.37	2.72 355.41	14.47 2.76	1.94 301.21	3.51 296.35	0.39 153.94	1.24 63.19	Mag Phase
183	484.39	135.87	49.56 291.26	5.02 345.68	10.02 232.72	82.94 124.77	14.37 58.70	13.41 32.70	9.84 19.62	5.65 272.59	1.80 117.08	1.83 110.05	Mag Phase
184	712.26	213.42	85.04 313.01	15.48 59.41	9.33 323.79	102.41 63.97	49.25 173.61	29.04 56.11	19.35 55.61	16.39 246.60	2.48 330.76	3.53 353.39	Mag Phase
185	1074.05	354.65	154.40 345.82	27.30 359.97	86.06 313.01	210.27 313.17	68.75 172.20	19.54 38.52	21.32 6.06	11.79 267.24	4.38 217.89	5.61 284.90	Mag Phase
186	1290.99	509.80	209.86 351.12	47.40 11.37	120.46 314.94	299.97 317.88	85.59 205.08	35.89 7.68	25.29 13.61	18.54 268.61	6.91 208.07	8.31 280.68	Mag Phase
187	718.77	204.82	83.33 313.30	15.17 73.56	6.98 308.89	85.18 46.66	66.40 179.44	35.03 68.40	18.96 60.23	12.56 244.71	2.16 342.83	1.52 334.71	Mag Phase
188	370.77	91.91	32.29 259.97	2.73 84.76	27.95 234.53	29.60 128.02	8.63 55.95	19.44 48.82	2.62 24.14	6.02 311.68	0.11 60.64	0.87 156.07	Mag Phase

Table III. - Continued

(q) Continued

Run 7

 $\mu_{\text{Nom}} = 0.20$ 

POINT	MEAN	1/2P-P	1P	2P	3P	4P	5P	6P	7P	8P	9P	10P	
189	366.29	78.19	31.93 244.48	2.95 162.06	13.23 236.00	30.63 139.37	16.55 106.20	9.19 31.52	5.62 31.46	7.70 4.51	0.74 53.18	1.69 257.76	Mag Phase
190	485.41	160.48	58.60 293.66	6.44 168.21	11.89 252.85	84.22 127.49	39.25 104.23	13.72 44.85	10.65 34.62	4.79 275.63	0.86 80.07	1.47 273.96	Mag Phase
191	714.69	334.86	58.71 325.73	37.37 30.35	38.85 324.40	166.00 64.49	146.14 158.48	31.17 22.21	19.98 354.19	12.00 277.89	2.76 214.54	7.04 251.83	Mag Phase
192	891.20	200.47	124.56 328.45	24.63 36.22	55.44 321.47	64.14 13.74	38.58 158.41	17.04 49.74	9.88 61.52	12.29 316.93	1.32 205.10	5.69 283.06	Mag Phase
193	1091.53	446.32	185.45 344.68	37.20 21.64	109.01 315.56	283.02 337.51	81.60 172.46	23.55 38.64	10.56 344.79	18.30 310.09	7.12 237.08	6.26 264.47	Mag Phase
194	1205.36	492.60	210.18 348.64	53.93 18.77	125.15 320.61	290.09 345.15	73.17 211.50	33.88 358.39	7.23 351.44	14.02 313.45	6.87 231.49	7.38 305.39	Mag Phase
195	719.28	265.88	97.44 320.12	18.52 96.09	16.53 331.91	145.71 66.30	61.87 179.84	32.78 69.99	21.41 65.20	13.61 272.46	1.49 355.04	2.04 300.56	Mag Phase
196	370.23	95.61	32.61 256.86	4.37 140.87	18.00 243.44	27.81 164.35	29.96 100.96	21.19 25.60	5.34 333.32	6.23 13.74	1.78 84.83	0.41 294.88	Mag Phase
197	378.38	74.50	27.35 243.46	6.30 196.80	15.32 234.73	19.59 194.93	24.01 95.46	15.83 38.27	3.57 4.67	6.01 346.60	1.44 46.63	0.69 154.71	Mag Phase
198	500.10	161.14	48.04 283.92	5.33 257.74	11.74 234.43	73.00 126.11	41.24 95.28	17.91 43.72	13.12 14.46	7.59 317.29	1.25 105.63	0.89 182.93	Mag Phase



Table III. - Continued

Run 7													
(q) Continued													
$\mu_{\text{Nom}} = 0.20$													
POINT	MEAN	1/2P-P	1P	2P	3P	4P	5P	6P	7P	8P	9P	10P	
199	717.15	275.43	44.93 301.78	28.61 15.94	27.94 350.22	111.49 61.64	145.86 141.43	41.58 14.17	18.52 4.40	8.66 252.98	2.98 293.62	7.11 250.34	Mag Phase
200	1087.25	375.96	157.03 335.99	34.80 6.99	73.47 307.83	220.72 333.38	97.32 152.67	35.25 4.13	11.32 350.99	19.24 286.66	5.24 224.21	8.98 261.68	Mag Phase
201	1312.78	508.78	202.10 346.68	60.32 12.94	108.48 314.54	329.40 348.12	74.77 208.58	39.95 357.80	6.00 303.50	23.16 311.86	9.34 195.10	12.93 276.35	Mag Phase
202	724.57	262.99	44.40 291.79	27.74 22.15	28.32 4.07	96.71 47.31	132.12 137.21	41.72 21.35	17.57 4.17	13.01 266.66	3.21 281.50	7.77 273.04	Mag Phase
203	374.32	75.71	26.74 251.12	8.45 176.27	18.46 236.76	22.70 205.00	25.32 104.66	16.87 31.88	3.82 348.44	2.85 48.97	0.34 129.08	0.41 170.73	Mag Phase
204	369.84	82.98	37.40 257.09	11.93 165.19	20.26 225.87	23.67 244.68	30.18 84.86	13.80 14.24	2.70 323.34	2.88 0.71	0.94 11.54	0.98 107.64	Mag Phase
205	504.36	127.11	41.34 282.93	6.73 207.30	15.41 195.91	48.79 153.96	33.59 95.10	12.44 22.62	5.94 353.17	7.50 313.91	1.27 200.82	2.42 98.14	Mag Phase
206	706.91	230.27	59.48 293.35	17.07 337.15	16.16 28.19	127.29 74.69	85.76 135.80	39.48 19.22	12.42 4.31	7.62 245.26	3.29 276.48	4.46 233.66	Mag Phase
207	1055.61	304.67	120.83 327.09	20.83 27.81	46.75 313.11	147.02 339.44	109.60 137.61	32.30 359.65	10.53 350.82	12.91 281.12	1.97 228.72	7.74 270.11	Mag Phase
208	1283.10	490.21	172.30 342.12	52.66 16.34	84.18 312.03	325.91 353.13	72.13 167.73	52.00 15.75	10.36 6.16	17.85 324.88	6.96 154.20	12.88 282.51	Mag Phase
209	718.63	205.19	64.19 303.94	1.19 271.20	15.83 33.62	135.95 75.57	43.27 125.28	38.53 21.19	12.71 349.10	10.32 263.80	3.14 287.85	3.21 289.55	Mag Phase

Table III. - Continued

(q) Concluded

$\mu_{Nom} = 0.20$

Run 7

POINT	MEAN	1/2P-P	1P	2P	3P	4P	5P	6P	7P	8P	9P	10P	Mag Phase
210	505.09	105.23	34.81 297.12	5.65 197.03	7.68 99.02	37.56 133.58	31.38 72.56	21.11 18.07	5.89 351.18	1.88 247.10	1.50 105.27	1.91 23.57	

Table III. - Continued

(r) Fixed-system strain-gage balance side force, lbs

Run 7

$\mu_{Nom} = 0.06$

POINT	MEAN	1/2P-P	1P	2P	3P	4P	5P	6P	7P	8P	9P	10P	
126	-2.14	22.86	1.21 84.33	2.95 102.45	0.45 79.77	12.04 6.20	2.27 284.51	5.01 218.44	0.67 169.31	4.67 150.87	1.77 187.40	0.81 159.19	Mag Phase

$\mu_{Nom} = 0.07$

POINT	MEAN	1/2P-P	1P	2P	3P	4P	5P	6P	7P	8P	9P	10P	
127	-4.10	19.32	1.47 112.57	0.30 189.63	1.00 98.22	12.99 29.62	2.84 185.93	6.21 252.45	1.42 217.02	2.86 230.26	1.35 252.96	0.40 257.23	Mag Phase

$\mu_{Nom} = 0.08$

POINT	MEAN	1/2P-P	1P	2P	3P	4P	5P	6P	7P	8P	9P	10P	
128	-7.18	31.93	4.93 148.90	4.63 258.08	1.88 137.75	22.88 18.19	5.54 177.37	5.28 256.51	0.13 55.66	1.05 286.10	1.53 229.41	0.60 222.75	Mag Phase
128A	-10.04	56.92	15.39 169.76	15.87 235.50	4.27 72.54	34.24 354.77	3.81 295.52	1.91 194.64	1.09 178.11	2.83 304.53	2.25 216.75	0.93 343.58	Mag Phase

$\mu_{Nom} = 0.09$

POINT	MEAN	1/2P-P	1P	2P	3P	4P	5P	6P	7P	8P	9P	10P	
129	-11.65	69.18	17.81 175.47	12.14 228.85	6.97 89.68	43.01 353.58	5.25 307.49	3.58 170.32	3.08 218.54	2.21 311.50	2.62 200.42	1.38 49.20	Mag Phase
130	-2.92	13.45	1.44 104.72	1.13 138.11	0.97 74.03	7.69 17.83	1.41 192.59	3.88 229.32	1.32 182.27	2.47 170.81	0.40 220.06	0.28 54.15	Mag Phase

Table III. - Continued

(r) Continued

Run 7

 $\mu_{\text{Nom}} = 0.09$ 

POINT	MEAN	1/2P-P	1P	2P	3P	4P	5P	6P	7P	8P	9P	10P	
131	-4.57	22.46	2.58 132.30	1.34 207.09	1.06 132.69	15.41 27.81	4.07 180.14	5.60 230.67	1.07 165.19	1.77 202.06	0.58 285.27	0.04 124.69	Mag Phase
132	-6.76	41.39	13.09 150.16	9.18 191.05	3.06 180.84	26.55 5.01	10.05 186.46	1.16 197.09	2.02 79.80	3.26 249.04	1.41 229.43	0.50 90.21	Mag Phase
133	-9.10	54.27	16.33 169.69	15.20 239.52	5.53 60.66	30.92 354.04	6.66 281.55	0.89 188.71	1.99 153.15	1.99 273.98	2.13 224.00	0.54 8.42	Mag Phase
134	-2.93	13.36	1.45 106.42	1.51 152.77	1.07 77.86	7.86 22.19	1.46 193.97	3.79 227.59	1.69 171.09	2.42 166.86	0.10 223.37	0.26 16.74	Mag Phase
135	-2.91	11.67	1.67 104.83	0.71 129.71	0.72 74.32	6.44 37.08	0.69 218.57	3.32 226.02	1.57 178.56	2.59 161.65	0.30 131.77	0.25 24.38	Mag Phase
136	-4.48	19.68	3.54 129.68	1.72 181.12	1.17 145.11	12.99 33.91	4.49 172.87	3.56 218.74	1.27 193.77	1.57 216.00	0.15 274.28	0.10 350.16	Mag Phase
137	-6.24	38.40	13.27 148.36	10.00 187.02	3.63 181.21	23.79 13.06	9.19 197.06	1.12 111.56	1.84 82.16	3.18 252.39	0.37 223.42	0.18 89.45	Mag Phase
138	-8.16	50.17	16.27 165.89	15.75 233.12	4.61 64.37	25.87 7.16	7.01 278.04	1.50 141.62	2.80 111.09	2.43 264.89	1.47 258.81	0.56 331.83	Mag Phase
139	-4.74	20.93	3.74 133.56	1.96 194.90	1.04 155.98	13.76 32.30	4.07 175.74	4.73 219.37	1.40 165.36	2.51 182.57	0.05 281.76	0.36 291.60	Mag Phase
140	-2.98	11.64	1.95 105.77	0.73 155.26	1.30 40.85	6.94 41.56	0.45 256.92	3.54 219.33	1.56 164.25	2.13 151.61	0.06 67.63	0.30 13.34	Mag Phase

Table III. - Continued

(r) Continued

Run 7

 $\mu_{\text{Nom}} = 0.09$ 

POINT	MEAN	1/2P-P	1P	2P	3P	4P	5P	6P	7P	8P	9P	10P	
141	-2.87	16.73	1.56 114.12	1.92 135.34	0.78 65.67	8.74 10.83	1.52 230.94	4.49 241.50	1.73 181.18	1.77 166.56	0.08 226.90	0.55 59.02	Mag Phase
142	-5.15	26.20	3.27 146.36	3.13 176.70	1.77 105.60	15.10 16.86	10.26 172.78	5.51 222.55	2.44 169.28	2.54 219.63	0.97 267.31	0.46 144.72	Mag Phase
143	-7.35	49.52	14.57 149.92	10.63 181.48	1.87 172.29	33.92 2.69	12.13 193.63	0.21 192.81	0.91 93.46	3.72 259.82	1.22 222.86	0.17 126.15	Mag Phase
144	-10.05	64.47	18.41 169.98	14.23 233.55	7.30 66.89	36.55 352.43	8.23 289.90	2.26 216.63	3.25 184.24	2.78 270.49	1.58 205.76	0.67 66.51	Mag Phase
145	-5.40	24.28	2.98 135.75	1.59 187.95	1.28 100.61	16.74 11.74	5.55 174.14	6.45 223.34	2.07 185.34	2.97 201.85	0.98 232.82	0.15 8.31	Mag Phase
146	-3.11	15.33	1.60 109.57	1.73 135.86	1.14 68.12	8.52 13.80	1.96 203.29	4.74 235.42	1.39 193.69	1.35 157.25	0.20 215.82	0.45 40.01	Mag Phase

 $\mu_{\text{Nom}} = 0.13$ 

POINT	MEAN	1/2P-P	1P	2P	3P	4P	5P	6P	7P	8P	9P	10P	
147	-1.94	11.51	0.92 97.00	0.21 274.35	1.27 69.84	4.17 39.41	1.79 298.68	3.52 233.55	1.89 212.19	1.46 170.08	0.30 125.18	0.13 338.16	Mag Phase
148	-3.30	15.51	2.25 125.95	0.54 123.72	2.14 61.01	8.32 39.95	2.70 300.45	4.13 220.62	1.16 166.66	0.78 249.74	0.07 278.19	0.88 39.91	Mag Phase
149	-5.71	22.95	4.47 153.31	1.67 218.14	2.19 100.25	15.69 20.49	5.85 211.06	4.58 234.16	2.14 159.57	2.25 256.89	0.35 175.14	0.62 106.46	Mag Phase

Table III. - Continued

(r) Continued

Run 7

 $\mu_{\text{Nom}} = 0.13$ 

POINT	MEAN	1/2P-P	1P	2P	3P	4P	5P	6P	7P	8P	9P	10P	
150	-8.73	47.22	17.39 165.54	16.68 227.11	6.28 63.25	20.19 6.63	7.00 279.15	3.07 243.52	1.87 194.71	1.65 332.91	2.49 178.46	0.53 143.25	Mag Phase
151	-10.44	46.88	19.18 172.29	11.98 252.94	11.32 81.30	25.32 349.78	7.07 279.27	2.17 253.21	2.21 165.27	1.85 307.78	2.11 168.91	1.32 82.77	Mag Phase
152	-6.22	24.62	4.69 158.92	2.53 219.80	2.35 101.60	15.88 20.69	6.43 219.77	5.87 243.26	1.90 182.11	3.27 233.51	0.59 210.29	0.54 65.43	Mag Phase
153	-3.64	17.08	1.82 127.38	0.68 147.96	2.29 61.25	9.22 37.44	1.54 281.53	5.59 219.54	1.73 174.35	1.59 173.88	0.36 143.49	0.69 29.21	Mag Phase
154	-1.74	10.90	1.45 110.70	1.02 328.53	1.31 36.60	3.55 36.58	1.68 309.14	3.39 218.61	1.56 188.60	1.86 149.06	0.29 114.14	0.19 15.18	Mag Phase
155	-2.75	16.16	2.50 117.55	0.49 151.62	2.46 57.07	7.72 44.97	3.35 306.93	4.56 229.94	1.34 192.80	0.95 157.23	0.38 222.03	0.45 23.12	Mag Phase
156	-4.94	24.67	6.15 145.15	1.74 199.51	1.94 122.65	15.81 22.33	4.69 195.98	5.49 214.49	2.08 150.63	0.81 258.02	0.95 223.53	0.48 70.93	Mag Phase
157	-8.09	45.82	17.28 165.46	16.26 229.37	4.75 72.68	20.24 8.51	5.42 289.47	2.86 219.56	1.16 188.90	0.27 12.50	2.14 202.10	0.20 81.55	Mag Phase
158	-9.88	46.72	18.83 172.51	11.75 254.23	9.22 83.73	25.18 347.87	5.85 304.09	2.42 215.38	0.55 126.51	0.42 91.27	1.73 207.99	1.65 64.62	Mag Phase
159	-5.50	25.36	5.86 152.13	2.50 204.22	2.21 124.88	15.33 26.51	4.95 213.39	6.52 233.48	1.98 172.44	1.48 195.91	1.20 229.67	0.35 333.52	Mag Phase

Table III. - Continued

(r) Continued

Run 7

 $\mu_{\text{Nom}} = 0.13$ 

POINT	MEAN	1/2P-P	1P	2P	3P	4P	5P	6P	7P	8P	9P	10P	
160	-3.28	17.96	2.37 117.97	0.67 147.01	2.45 61.82	8.99 40.13	2.16 302.86	5.58 217.97	1.59 170.38	1.18 128.08	0.42 164.41	0.58 347.03	Mag Phase
161	-1.46	10.00	1.76 116.22	1.39 338.79	1.65 24.73	3.60 43.39	2.25 10.77	2.87 233.05	1.63 220.64	1.27 153.18	0.65 134.57	0.13 281.85	Mag Phase
162	-2.32	14.51	2.84 119.12	0.57 114.74	1.63 63.41	7.37 52.11	2.39 319.58	4.30 230.72	0.85 186.90	1.47 127.58	0.25 144.06	0.52 341.76	Mag Phase
163	-4.54	24.52	5.67 144.06	2.53 172.85	1.76 126.61	15.69 22.21	4.41 210.56	5.56 202.75	1.29 148.17	1.17 171.61	0.65 232.14	0.31 37.04	Mag Phase
164	-7.60	44.97	16.85 160.36	15.36 217.07	2.24 93.79	20.87 3.08	5.62 267.15	3.13 195.73	0.54 127.17	0.45 257.57	1.64 189.54	0.20 94.48	Mag Phase
165	-8.79	49.48	18.56 171.15	12.98 242.80	6.88 82.50	23.66 353.90	7.81 297.50	3.68 205.82	1.62 123.47	1.34 117.85	1.21 218.52	1.12 55.35	Mag Phase
166	-4.95	25.18	5.89 152.66	2.55 202.83	2.16 135.99	15.28 31.45	4.04 229.96	6.68 229.18	1.06 158.97	2.16 185.63	0.92 242.24	0.28 349.16	Mag Phase
167	-2.66	15.00	2.31 120.82	0.52 170.06	2.04 59.78	8.43 53.25	1.76 310.77	5.13 213.30	0.96 167.27	1.96 172.66	0.35 251.74	0.43 336.58	Mag Phase

Table III. - Continued

(r) Continued

Run 7

 $\mu_{\text{Nom}} = 0.16$ 

POINT	MEAN	1/2P-P	1P	2P	3P	4P	5P	6P	7P	8P	9P	10P	
168	-1.15	8.91	1.39 121.61	1.85 338.43	1.68 21.92	3.74 50.22	1.91 18.46	3.03 228.59	1.51 199.83	1.55 129.90	0.35 134.95	0.23 16.20	Mag Phase
169	-2.09	13.42	2.70 126.29	0.12 356.28	1.37 50.33	7.81 57.05	2.37 1.04	3.39 223.89	1.14 174.74	1.10 73.19	0.35 115.77	0.69 343.12	Mag Phase
170	-4.34	24.58	9.58 142.08	5.38 144.49	4.85 148.11	14.31 21.49	5.02 182.74	4.69 198.63	1.30 102.71	0.47 302.86	0.63 254.55	0.65 56.85	Mag Phase
171	-7.37	44.29	16.96 168.55	15.65 231.87	3.26 65.66	17.74 11.65	3.69 347.82	3.53 225.59	1.17 114.66	0.29 256.58	0.99 227.98	0.40 326.02	Mag Phase
172	-9.41	48.73	19.64 174.78	9.85 249.83	7.67 83.62	21.67 359.71	7.30 315.52	3.92 209.30	2.91 115.33	1.84 129.61	0.29 228.38	1.22 55.08	Mag Phase
173	-5.35	23.25	9.04 148.52	3.52 141.44	4.23 151.97	13.34 27.05	4.63 183.17	5.75 207.62	1.00 133.75	2.44 202.05	0.49 254.71	0.83 26.80	Mag Phase
174	-0.86	8.40	1.05 107.19	1.88 353.49	2.06 26.64	3.48 48.43	2.57 39.22	2.41 248.04	1.00 195.24	1.68 153.53	0.42 102.57	0.16 3.12	Mag Phase
175	-0.94	10.44	1.06 129.93	1.67 354.37	1.89 32.29	4.06 44.08	2.31 21.17	4.01 237.27	0.93 159.58	1.81 162.64	0.63 71.56	0.15 324.21	Mag Phase
176	-2.54	15.19	2.01 139.41	0.58 68.08	1.98 51.81	8.27 47.22	3.28 7.78	4.17 244.30	1.07 191.06	0.46 13.82	0.30 125.68	0.65 352.31	Mag Phase
177	-5.10	29.19	11.64 144.95	7.40 136.02	4.03 145.83	18.19 19.24	6.68 177.47	3.28 230.81	0.92 147.85	1.37 270.18	0.50 210.24	0.56 43.80	Mag Phase



Table III. - Continued

Run 7													(r) Continued	
													$\mu_{\text{Nom}} = 0.16$	
POINT	MEAN	1/2P-P	1P	2P	3P	4P	5P	6P	7P	8P	9P	10P		
178	-8.50	45.17	19.03 174.71	13.95 240.28	8.09 69.29	17.73 357.77	5.83 330.90	3.51 242.87	0.61 238.52	0.93 50.38	1.19 185.36	0.47 33.20	Mag Phase	
179	-10.56	49.24	20.88 175.03	8.73 246.79	11.33 86.87	22.52 343.64	8.59 307.60	3.96 225.49	2.36 137.24	1.43 124.62	1.70 143.97	1.59 64.41	Mag Phase	
180	-5.60	28.72	6.86 166.63	3.44 216.59	2.73 131.46	15.46 17.90	2.03 260.02	7.51 227.97	1.75 176.14	2.40 187.52	0.43 201.67	0.20 187.64	Mag Phase	
181	-0.90	9.27	1.16 122.29	1.51 341.22	2.63 32.92	4.00 47.15	2.74 25.74	3.17 235.34	0.82 175.87	1.15 139.92	0.49 86.10	0.25 3.23	Mag Phase	
182	-0.92	10.06	1.15 120.23	0.97 49.12	1.35 14.14	4.86 36.04	0.93 330.32	3.42 218.04	0.61 154.63	1.73 158.80	0.77 33.13	0.20 317.58	Mag Phase	
183	-2.94	14.82	1.70 134.13	0.76 90.66	0.80 67.17	9.00 44.90	2.23 7.92	4.32 239.79	1.16 213.14	0.75 186.82	0.19 88.19	0.20 27.68	Mag Phase	
184	-5.45	28.70	7.07 172.13	2.65 213.57	2.76 132.05	16.31 17.31	3.40 255.49	5.07 237.72	2.76 179.97	0.48 209.42	0.40 111.78	0.90 152.47	Mag Phase	
185	-9.40	44.24	20.41 177.33	12.87 245.52	11.52 87.68	18.21 355.01	5.72 318.12	2.25 260.79	1.10 191.59	0.91 145.83	1.07 218.44	0.92 100.29	Mag Phase	
186	-10.75	50.99	22.01 178.11	7.20 228.62	14.84 98.71	22.66 343.44	10.78 301.87	2.52 242.02	2.90 181.91	0.71 194.85	1.27 167.05	1.30 119.09	Mag Phase	
187	-6.49	29.93	7.48 172.42	3.75 231.60	3.09 124.12	16.72 14.77	3.44 241.77	5.58 250.81	2.82 206.88	1.78 222.01	0.74 139.24	0.48 121.31	Mag Phase	
188	-1.63	11.58	0.88 110.89	1.02 336.46	2.37 26.24	5.13 43.66	2.34 354.64	3.26 241.32	0.90 224.40	0.91 176.96	0.72 103.26	0.39 11.74	Mag Phase	

Table III. - Continued

(r) Continued

Run 7

 $\mu_{\text{Nom}} = 0.20$ 

POINT	MEAN	1/2P-P	1P	2P	3P	4P	5P	6P	7P	8P	9P	10P	
189	-1.87	10.24	0.82 136.66	1.04 334.96	1.21 40.92	5.57 44.92	1.66 70.98	2.47 211.15	1.63 207.68	0.79 124.78	0.84 115.87	0.45 40.68	Mag Phase
190	-3.45	17.19	1.85 136.78	0.30 334.93	1.31 85.78	9.19 55.57	5.32 92.55	3.51 238.61	2.24 222.75	1.35 109.57	1.09 141.78	0.92 69.42	Mag Phase
191	-6.45	38.36	15.14 151.63	10.72 164.30	5.34 163.05	21.29 30.42	6.66 195.92	1.56 238.48	1.82 161.31	1.66 26.19	1.14 133.10	0.95 78.38	Mag Phase
192	-8.82	48.49	18.30 172.50	13.76 208.39	5.42 93.90	17.96 29.84	4.27 23.21	2.17 279.37	1.53 260.86	3.51 85.52	1.76 179.95	0.15 269.24	Mag Phase
193	-11.09	43.84	22.04 179.13	8.22 239.24	12.75 101.01	19.53 358.82	4.60 0.39	0.49 205.79	1.82 41.37	1.41 130.41	0.90 253.42	0.20 345.84	Mag Phase
194	-11.55	48.21	23.11 183.88	5.19 240.56	14.55 111.27	20.27 358.15	8.69 335.49	0.44 269.60	1.57 78.35	2.56 129.69	1.20 234.53	0.68 198.66	Mag Phase
195	-7.53	32.28	8.13 183.27	4.39 232.57	4.00 138.13	17.27 35.92	2.61 77.49	4.87 265.18	2.51 181.52	0.51 145.56	0.51 117.83	0.43 50.90	Mag Phase
196	-1.86	12.38	0.56 137.21	2.08 323.24	1.67 39.24	4.97 52.80	3.58 91.00	3.37 226.93	1.53 205.98	1.56 134.68	0.80 119.56	0.44 59.34	Mag Phase
197	-1.37	9.69	1.34 150.47	2.11 324.01	1.27 16.40	4.17 52.62	2.45 84.02	2.76 234.17	1.32 197.98	1.94 147.81	0.55 75.95	0.39 39.63	Mag Phase
198	-2.74	14.75	1.56 131.59	1.94 48.11	1.00 72.28	8.20 46.73	5.13 85.08	3.58 224.30	2.57 189.55	1.33 132.81	0.51 136.96	0.77 27.09	Mag Phase

Table III. - Continued

Run 7													(r) Continued	
													$\mu_{\text{Nom}} = 0.20$	
POINT	MEAN	1/2P-P	1P	2P	3P	4P	5P	6P	7P	8P	9P	10P		
199	-5.71	27.52	10.95 152.75	4.91 131.64	6.57 160.25	15.62 30.37	8.23 154.34	3.23 212.77	2.64 166.24	0.81 358.76	0.04 21.26	1.08 51.39	Mag Phase	
200	-9.70	42.86	19.87 176.61	10.72 229.06	8.76 84.08	17.27 357.34	3.74 17.19	1.37 236.75	0.89 24.53	2.55 104.63	1.06 232.24	0.96 36.49	Mag Phase	
201	-11.78	49.01	22.10 178.01	5.10 220.28	10.84 96.68	21.29 355.85	9.70 315.34	1.44 226.35	1.79 74.31	2.16 100.63	1.36 204.92	0.76 93.38	Mag Phase	
202	-6.60	27.76	11.51 153.94	3.42 154.94	6.20 162.90	14.61 21.99	6.63 148.64	4.11 209.24	2.67 170.47	0.91 204.45	0.29 153.11	1.17 59.61	Mag Phase	
203	-1.66	9.33	1.42 96.04	2.15 315.14	1.84 29.98	3.87 51.17	2.68 73.19	2.62 232.80	1.37 195.82	1.93 129.38	0.55 95.57	0.35 49.28	Mag Phase	
204	-1.13	10.32	0.49 80.34	2.36 313.21	1.64 29.00	3.52 45.38	3.45 74.69	2.70 217.16	1.45 182.18	1.74 129.75	0.44 70.76	0.26 34.62	Mag Phase	
205	-2.61	12.08	2.21 132.80	2.18 41.01	1.35 10.61	6.35 44.55	3.81 68.20	3.43 217.71	2.13 161.67	2.02 128.52	0.46 67.61	0.63 344.04	Mag Phase	
206	-4.74	22.36	6.97 155.35	3.56 69.90	3.38 165.14	14.95 35.26	5.60 138.60	5.63 200.52	2.53 147.08	0.94 119.50	0.53 254.87	1.07 27.03	Mag Phase	
207	-8.21	44.55	19.04 170.83	11.87 213.16	4.26 81.86	15.79 359.51	3.04 52.41	3.40 198.26	0.73 135.70	2.71 112.24	0.88 265.59	0.75 25.34	Mag Phase	
208	-10.46	52.11	21.59 177.38	6.90 228.48	7.30 89.04	21.20 356.53	8.46 328.73	4.03 199.64	1.79 119.33	3.54 136.88	0.78 231.50	1.10 72.24	Mag Phase	
209	-5.54	21.01	4.38 163.12	1.52 8.33	3.48 152.91	13.79 36.90	3.16 85.68	6.61 204.76	1.84 150.50	2.92 145.85	0.82 183.45	0.84 19.83	Mag Phase	

Table III. - Continued

Run 7													
(r) Concluded													
$\mu_{Nom} = 0.20$													
POINT	MEAN	1/2P-P	1P	2P	3P	4P	5P	6P	7P	8P	9P	10P	
210	-2.57	13.10	1.07	0.95	0.69	7.17	3.13	5.55	2.13	3.57	0.72	0.47	Mag
			100.96	7.87	230.30	44.17	83.42	222.32	185.87	160.61	130.02	40.83	Phase

Table III. - Continued

(s) Pitch link load, blade 1, lbs

Run 7

$\mu_{Nom} = 0.06$

POINT	MEAN	1/2P-P	1P	2P	3P	4P	5P	6P	7P	8P	9P	10P	
126	4.12	5.24	2.83 339.52	1.65 88.20	0.68 224.13	0.42 200.58	1.11 270.36	0.77 160.48	0.37 273.46	0.35 290.51	0.14 299.23	0.02 57.67	Mag Phase

$\mu_{Nom} = 0.07$

POINT	MEAN	1/2P-P	1P	2P	3P	4P	5P	6P	7P	8P	9P	10P	
127	5.87	6.15	3.31 359.65	3.06 91.96	0.75 253.01	1.03 189.72	1.24 245.60	0.87 175.91	0.30 319.14	0.46 302.02	0.03 107.46	0.10 167.00	Mag Phase

$\mu_{Nom} = 0.08$

POINT	MEAN	1/2P-P	1P	2P	3P	4P	5P	6P	7P	8P	9P	10P	
128	7.70	7.90	4.41 12.99	3.77 76.95	0.78 267.72	1.75 190.94	1.73 229.52	1.02 189.43	0.55 294.18	0.45 290.22	0.08 225.36	0.08 171.20	Mag Phase
128A	8.81	14.34	7.74 23.00	4.39 61.07	1.88 298.06	2.57 209.63	3.21 244.69	1.71 271.94	0.55 312.54	1.04 254.04	0.56 243.29	0.31 272.77	Mag Phase

$\mu_{Nom} = 0.09$

POINT	MEAN	1/2P-P	1P	2P	3P	4P	5P	6P	7P	8P	9P	10P	
129	9.00	17.00	9.50 23.13	3.69 45.81	2.70 295.66	3.18 237.74	3.80 270.83	2.56 268.79	2.03 289.08	1.84 264.60	0.92 261.80	0.64 288.03	Mag Phase
130	4.98	5.16	3.10 354.61	2.10 100.57	0.46 243.92	0.57 171.27	1.24 256.03	0.53 152.68	0.27 322.53	0.36 287.42	0.04 303.82	0.11 144.68	Mag Phase

Table III. - Continued

(s) Continued

Run 7

 $\mu_{\text{Nom}} = 0.09$ 

POINT	MEAN	1/2P-P	1P	2P	3P	4P	5P	6P	7P	8P	9P	10P	
131	6.50	6.08	3.71 6.34	3.17 95.38	0.69 259.84	0.91 180.53	1.34 244.59	0.52 173.84	0.33 336.26	0.36 278.46	0.07 248.27	0.09 148.27	Mag Phase
132	8.16	8.00	5.14 19.24	4.02 77.54	0.63 257.48	1.18 186.24	1.55 218.60	0.75 213.30	0.48 304.61	0.52 253.85	0.11 214.42	0.08 341.05	Mag Phase
133	8.54	12.19	8.24 29.03	3.29 73.13	1.65 302.19	2.07 194.98	2.55 234.23	1.85 247.20	1.10 305.80	0.85 259.20	0.22 227.69	0.31 265.93	Mag Phase
134	5.15	5.11	3.08 353.02	2.02 102.44	0.45 248.20	0.60 177.15	1.29 258.97	0.52 158.63	0.26 330.29	0.34 292.08	0.05 280.60	0.10 143.37	Mag Phase
135	4.72	4.65	3.08 357.35	1.89 106.40	0.34 271.76	0.44 183.29	0.88 278.07	0.26 171.90	0.16 337.70	0.21 304.74	0.05 316.24	0.08 201.58	Mag Phase
136	6.09	5.47	3.70 9.80	2.94 96.62	0.51 276.87	0.81 183.82	0.78 251.16	0.20 169.20	0.08 291.84	0.19 286.37	0.11 264.56	0.06 183.84	Mag Phase
137	7.81	7.20	4.92 20.18	3.71 80.79	0.57 278.07	1.02 176.94	0.91 218.27	0.66 246.09	0.15 332.19	0.37 254.91	0.12 249.87	0.06 1.39	Mag Phase
138	8.13	11.26	8.10 31.89	3.02 83.90	0.91 302.81	1.48 184.26	1.78 199.87	2.23 257.65	1.04 337.58	0.48 264.19	0.18 59.89	0.21 258.08	Mag Phase
139	6.27	5.45	3.88 12.04	2.89 98.56	0.41 279.60	0.85 185.94	0.72 254.94	0.18 178.60	0.06 304.31	0.23 291.96	0.11 268.15	0.04 222.01	Mag Phase
140	4.68	4.44	3.14 2.80	1.82 107.12	0.34 269.68	0.46 187.72	0.86 275.47	0.30 172.61	0.17 325.81	0.18 316.72	0.07 309.43	0.08 191.49	Mag Phase

Table III. - Continued

(s) Continued

Run 7

 $\mu_{\text{Nom}} = 0.09$ 

POINT	MEAN	1/2P-P	1P	2P	3P	4P	5P	6P	7P	8P	9P	10P	
141	5.31	5.46	3.09 354.25	2.12 103.92	0.48 257.94	0.63 169.25	1.23 265.31	0.73 155.77	0.30 325.24	0.53 292.53	0.01 23.99	0.10 115.59	Mag Phase
142	6.77	6.64	3.79 3.30	3.49 95.66	0.83 265.01	1.08 181.53	1.79 237.72	0.83 167.09	0.38 325.42	0.61 292.14	0.04 248.87	0.16 132.95	Mag Phase
143	8.26	9.02	5.36 18.48	4.40 76.84	0.89 268.89	1.70 195.24	1.96 230.59	1.00 211.93	0.62 319.74	0.70 269.83	0.13 263.11	0.02 24.98	Mag Phase
144	8.80	14.62	8.27 24.04	3.70 56.50	2.19 301.29	2.93 211.92	3.58 253.18	2.00 254.82	1.22 301.54	1.35 260.27	0.63 245.80	0.44 284.66	Mag Phase
145	6.82	6.56	3.82 4.22	3.43 94.03	0.70 262.39	1.24 180.66	1.73 231.41	0.89 160.57	0.38 313.23	0.59 282.98	0.02 281.15	0.15 131.63	Mag Phase
146	5.32	5.44	3.11 353.95	2.12 105.39	0.43 258.10	0.66 176.06	1.13 263.91	0.76 158.85	0.31 327.59	0.50 295.71	0.02 38.10	0.12 128.64	Mag Phase

 $\mu_{\text{Nom}} = 0.13$ 

POINT	MEAN	1/2P-P	1P	2P	3P	4P	5P	6P	7P	8P	9P	10P	
147	4.31	3.08	2.91 2.12	0.89 131.63	0.06 61.05	0.69 138.71	0.17 240.43	0.34 162.27	0.06 336.31	0.13 342.84	0.07 51.95	0.06 71.17	Mag Phase
148	5.83	4.31	3.50 10.69	2.07 128.48	0.34 58.75	1.06 156.12	0.36 248.10	0.46 147.47	0.22 310.00	0.30 327.99	0.12 29.98	0.09 105.39	Mag Phase
149	7.69	6.38	4.36 15.51	3.47 113.84	0.92 25.88	1.82 163.37	0.92 244.36	0.57 147.17	0.42 304.28	0.56 314.38	0.06 15.56	0.12 110.86	Mag Phase

Table III. - Continued

(s) Continued

Run 7

 $\mu_{\text{Nom}} = 0.13$ 

POINT	MEAN	1/2P-P	1P	2P	3P	4P	5P	6P	7P	8P	9P	10P	
150	9.52	9.88	6.30 21.04	4.40 80.40	1.77 326.51	2.50 195.33	1.39 258.50	0.70 254.50	0.53 298.15	1.03 291.77	0.32 241.32	0.09 351.99	Mag Phase
151	9.82	14.51	7.90 22.57	4.59 66.19	2.89 317.76	2.78 233.43	2.33 291.83	1.04 279.23	0.83 304.07	1.58 282.08	0.60 264.97	0.47 340.26	Mag Phase
152	7.71	6.52	4.46 18.81	3.56 115.88	1.06 24.32	1.95 175.30	0.85 248.22	0.46 148.71	0.43 298.39	0.52 320.26	0.13 13.25	0.09 102.19	Mag Phase
153	5.87	4.54	3.59 9.13	2.20 129.95	0.37 52.21	1.06 155.23	0.38 248.03	0.50 147.67	0.24 322.47	0.32 320.91	0.09 28.16	0.09 112.02	Mag Phase
154	3.73	3.09	2.95 7.81	0.72 133.19	0.16 221.80	0.55 152.58	0.24 249.79	0.23 181.78	0.11 289.10	0.13 305.16	0.03 60.31	0.06 95.96	Mag Phase
155	5.31	4.29	3.39 10.89	2.01 125.13	0.18 11.83	0.91 168.15	0.65 264.47	0.30 161.51	0.28 321.54	0.33 315.92	0.07 51.24	0.09 106.10	Mag Phase
156	7.10	5.94	4.31 16.68	3.30 108.10	0.63 1.45	1.61 168.53	1.21 245.76	0.20 114.82	0.46 300.92	0.54 301.28	0.09 10.73	0.10 55.59	Mag Phase
157	9.01	9.49	6.26 23.68	4.41 84.09	1.56 317.28	2.27 195.74	1.47 259.84	0.53 301.03	0.56 310.68	0.80 304.09	0.12 299.60	0.18 347.60	Mag Phase
158	9.26	13.68	7.77 22.63	4.38 66.05	2.76 305.79	2.82 234.27	2.47 273.06	1.16 269.20	1.03 281.76	1.25 285.91	0.50 281.09	0.49 317.67	Mag Phase
159	7.13	6.07	4.41 17.37	3.28 113.19	0.70 8.79	1.62 176.49	1.18 251.83	0.25 144.42	0.44 308.33	0.56 312.01	0.07 53.39	0.11 59.30	Mag Phase



Table III. - Continued

(s) Continued

Run 7

 $\mu_{\text{Nom}} = 0.13$ 

POINT	MEAN	1/2P-P	1P	2P	3P	4P	5P	6P	7P	8P	9P	10P	
160	5.88	4.63	3.63 9.02	2.15 122.71	0.23 20.07	0.99 165.93	0.70 259.10	0.32 156.69	0.36 311.57	0.36 304.94	0.09 39.17	0.11 102.36	Mag Phase
161	3.74	3.12	3.01 9.40	0.67 125.80	0.18 268.85	0.48 154.25	0.42 252.02	0.07 186.41	0.10 313.60	0.14 311.81	0.03 96.88	0.04 98.74	Mag Phase
162	5.17	4.26	3.36 11.00	2.03 118.15	0.20 308.39	0.74 162.51	0.91 259.98	0.14 126.25	0.24 333.10	0.28 290.41	0.06 64.32	0.08 104.99	Mag Phase
163	6.97	5.89	4.40 15.68	3.30 104.92	0.58 330.99	1.10 171.29	1.53 242.65	0.14 10.66	0.38 308.86	0.38 275.82	0.06 31.42	0.09 59.77	Mag Phase
164	8.96	10.00	6.22 21.95	4.46 80.89	1.42 299.91	1.69 192.41	1.70 251.50	0.72 322.98	0.44 312.18	0.52 274.12	0.04 151.34	0.11 302.86	Mag Phase
165	9.03	14.07	7.96 24.38	4.26 72.07	2.30 302.05	2.26 235.21	2.95 278.24	1.27 335.45	0.72 299.70	0.82 288.69	0.26 272.03	0.40 322.50	Mag Phase
166	7.16	5.91	4.50 18.64	3.34 112.13	0.61 339.03	1.15 186.30	1.45 258.79	0.12 18.21	0.36 322.66	0.38 304.91	0.07 75.80	0.09 73.40	Mag Phase
167	5.21	4.39	3.68 12.19	2.09 123.40	0.16 312.32	0.78 167.97	0.94 262.00	0.12 133.98	0.21 315.90	0.24 304.79	0.08 74.11	0.09 97.90	Mag Phase

Table III. - Continued

(s) Continued

Run 7

 $\mu_{\text{Nom}} = 0.16$ 

POINT	MEAN	1/2P-P	1P	2P	3P	4P	5P	6P	7P	8P	9P	10P	
168	3.33	3.49	3.27 11.27	0.53 126.32	0.31 266.75	0.51 148.93	0.18 254.69	0.13 187.11	0.06 350.26	0.13 319.75	0.03 104.97	0.06 131.93	Mag Phase
169	5.01	4.37	3.72 15.28	1.92 125.20	0.32 342.72	0.72 158.60	0.65 262.64	0.16 116.91	0.21 331.00	0.26 294.90	0.09 103.69	0.09 110.50	Mag Phase
170	7.07	6.59	4.64 19.40	3.41 110.89	1.13 349.89	1.21 174.01	1.32 255.59	0.16 2.56	0.45 313.93	0.50 291.84	0.09 124.40	0.09 57.22	Mag Phase
171	9.04	11.44	6.53 22.64	4.53 82.04	2.58 321.67	2.19 219.84	2.06 265.14	0.70 303.96	0.60 302.29	0.92 278.28	0.20 244.35	0.24 319.09	Mag Phase
172	9.28	15.46	8.11 21.66	4.79 64.70	3.55 316.97	2.58 256.36	3.12 295.29	1.61 327.54	1.50 325.26	1.45 303.37	0.49 318.55	0.58 340.87	Mag Phase
173	7.18	6.81	4.82 19.68	3.50 113.04	1.20 355.19	1.18 177.98	1.26 255.06	0.27 343.26	0.42 320.02	0.48 293.87	0.09 109.85	0.09 63.36	Mag Phase
174	3.40	3.60	3.21 15.66	0.43 132.30	0.34 265.40	0.61 155.57	0.18 263.93	0.13 183.16	0.02 32.92	0.12 324.44	0.04 129.18	0.04 150.19	Mag Phase
175	4.02	3.62	3.18 13.36	0.54 141.29	0.21 238.99	0.76 147.60	0.26 205.93	0.28 160.38	0.06 1.05	0.13 302.31	0.07 95.85	0.06 132.22	Mag Phase
176	5.78	4.62	3.77 16.09	2.08 130.56	0.50 19.70	1.02 162.64	0.35 222.77	0.32 143.41	0.22 319.11	0.33 303.54	0.08 120.10	0.11 117.83	Mag Phase
177	7.73	6.72	4.82 21.89	3.60 113.68	1.35 12.04	1.56 183.15	0.95 253.12	0.07 39.79	0.44 319.37	0.63 319.46	0.01 61.11	0.13 77.86	Mag Phase

Table III. - Continued

Run 7													
(s) Continued													
$\mu_{\text{Nom}} = 0.16$													
POINT	MEAN	1/2P-P	1P	2P	3P	4P	5P	6P	7P	8P	9P	10P	
178	9.45	13.58	7.14 22.75	4.90 74.74	3.26 325.53	2.70 236.78	2.29 285.86	1.10 304.61	0.96 312.37	1.37 294.82	0.48 286.29	0.33 342.23	Mag Phase
179	9.36	18.01	8.98 18.56	4.90 56.07	4.15 311.56	2.87 259.32	3.56 304.55	1.95 317.69	1.62 309.79	2.03 286.21	0.74 294.60	0.52 339.04	Mag Phase
180	7.86	7.08	5.00 20.27	3.62 112.95	1.45 7.05	1.64 176.68	0.99 248.30	0.04 173.26	0.46 307.19	0.63 298.92	0.02 17.03	0.14 53.92	Mag Phase
181	4.11	3.53	3.18 11.58	0.61 134.60	0.15 268.26	0.76 143.82	0.22 189.40	0.29 153.00	0.03 332.50	0.10 297.86	0.05 69.63	0.06 101.44	Mag Phase
182	4.67	3.21	3.08 7.65	0.87 136.61	0.13 59.97	0.66 130.99	0.20 176.03	0.30 136.79	0.01 29.05	0.08 273.82	0.07 67.09	0.04 65.11	Mag Phase
183	6.27	4.78	3.97 15.48	2.17 136.93	0.72 43.26	0.98 154.46	0.25 144.95	0.35 129.01	0.11 309.51	0.23 296.21	0.07 75.97	0.07 54.81	Mag Phase
184	8.30	7.17	5.01 21.51	3.62 114.36	1.66 22.48	1.71 167.65	0.38 250.23	0.19 115.41	0.34 285.00	0.58 300.64	0.08 350.37	0.18 17.91	Mag Phase
185	10.01	13.53	7.33 24.16	5.09 73.66	3.44 327.93	2.85 231.72	1.68 305.30	1.00 288.83	0.80 294.46	1.24 298.75	0.57 300.72	0.34 359.64	Mag Phase
186	9.88	17.94	9.03 21.00	5.28 59.44	4.18 314.89	2.53 256.99	3.29 330.61	1.54 323.75	1.25 309.40	1.86 297.33	0.76 314.33	0.60 347.87	Mag Phase
187	8.53	7.35	5.13 21.93	3.68 115.87	1.71 19.09	1.82 175.44	0.42 236.29	0.14 130.52	0.36 294.80	0.55 309.69	0.12 11.94	0.17 34.17	Mag Phase
188	4.66	3.30	3.25 12.11	0.86 144.25	0.16 37.26	0.67 147.03	0.19 174.12	0.27 151.85	0.02 270.07	0.06 298.53	0.05 97.07	0.03 82.61	Mag Phase

Table III. - Continued

(s) Continued

Run 7

 $\mu_{\text{Nom}} = 0.20$ 

POINT	MEAN	1/2P-P	1P	2P	3P	4P	5P	6P	7P	8P	9P	10P	
189	4.60	3.87	3.61 9.22	0.71 150.09	0.21 342.65	0.48 142.84	0.40 213.62	0.40 149.31	0.07 100.93	0.11 7.87	0.04 78.28	0.05 108.22	Mag Phase
190	6.52	5.48	4.38 21.13	2.02 142.73	0.82 17.29	1.03 155.55	0.53 181.66	0.56 125.36	0.16 25.88	0.15 353.21	0.14 134.97	0.15 101.96	Mag Phase
191	8.58	7.73	5.59 23.27	3.75 113.01	2.21 0.23	1.62 202.16	0.77 233.56	0.07 333.73	0.41 313.12	0.57 321.68	0.14 268.12	0.15 64.34	Mag Phase
192	9.49	11.77	6.80 23.46	4.59 84.95	3.88 333.52	3.25 233.64	1.55 273.32	0.93 289.49	0.92 301.43	0.95 305.60	0.43 269.22	0.21 349.67	Mag Phase
193	9.98	17.29	8.41 20.07	6.03 63.95	5.39 325.70	4.15 252.91	2.55 307.18	1.88 319.35	1.56 329.43	1.55 302.75	0.66 299.23	0.53 353.52	Mag Phase
194	9.69	18.44	9.49 18.52	6.26 56.35	5.53 319.84	3.68 256.51	3.34 329.06	2.35 339.55	2.17 341.08	1.62 323.47	0.43 338.68	0.56 15.25	Mag Phase
195	8.63	7.85	5.79 25.34	3.64 115.31	2.20 7.23	1.68 205.30	0.78 247.91	0.12 251.04	0.43 320.87	0.69 330.33	0.12 287.42	0.17 66.77	Mag Phase
196	4.53	4.12	3.63 16.15	0.65 152.42	0.26 318.94	0.59 152.81	0.37 208.67	0.40 158.17	0.13 115.55	0.09 43.79	0.06 108.58	0.05 141.27	Mag Phase
197	3.74	4.10	3.63 17.66	0.24 139.78	0.47 277.56	0.79 146.97	0.16 251.46	0.35 182.25	0.09 150.93	0.12 40.74	0.04 113.14	0.03 155.80	Mag Phase
198	5.57	5.09	4.27 20.57	1.60 129.36	0.62 336.72	1.05 151.19	0.36 245.88	0.34 145.09	0.11 324.49	0.30 342.99	0.08 79.13	0.11 102.42	Mag Phase

Table III. - Continued

(s) Continued

$\mu_{Nom} = 0.20$

Run 7	POINT	MEAN	1/2P-P	1P	2P	3P	4P	5P	6P	7P	8P	9P	10P	
	199	7.63	7.46	5.43 24.47	3.37 115.50	1.79 357.98	1.56 192.71	1.02 281.65	0.13 302.58	0.40 337.15	0.66 352.17	0.06 301.47	0.10 101.18	Mag Phase
	200	9.41	14.93	7.72 22.64	5.55 67.42	4.74 325.72	3.10 238.94	2.79 298.90	1.61 311.99	1.30 332.88	1.47 324.09	0.55 306.72	0.48 341.68	Mag Phase
	201	9.16	17.88	9.72 20.12	5.69 51.93	5.10 312.25	2.74 244.97	4.19 331.16	2.30 0.55	2.00 353.55	1.74 337.25	0.48 5.18	0.34 19.66	Mag Phase
	202	7.69	7.66	5.56 23.08	3.38 111.48	1.94 352.40	1.74 187.93	1.05 268.26	0.17 265.24	0.39 324.83	0.65 345.45	0.07 329.21	0.12 83.97	Mag Phase
	203	3.99	4.13	3.59 19.53	0.13 125.84	0.47 276.38	0.78 151.18	0.15 251.21	0.30 181.14	0.06 150.35	0.11 42.07	0.05 119.95	0.04 176.93	Mag Phase
	204	3.20	4.07	3.47 19.38	0.09 42.40	0.69 256.01	0.71 138.27	0.20 276.34	0.23 184.57	0.08 135.03	0.10 22.15	0.05 145.26	0.05 173.82	Mag Phase
	205	4.99	4.78	4.15 20.05	1.26 124.82	0.48 321.81	0.91 138.79	0.44 278.92	0.19 131.53	0.09 330.65	0.26 334.89	0.05 99.15	0.06 110.79	Mag Phase
	206	6.92	6.92	5.16 22.02	2.78 112.54	1.52 355.55	1.03 176.13	0.95 285.41	0.01 292.18	0.39 328.60	0.47 339.71	0.04 160.04	0.09 90.90	Mag Phase
	207	9.11	12.23	7.09 21.48	4.53 71.69	3.81 320.29	2.59 220.81	2.05 281.93	0.79 286.15	0.60 309.96	0.90 300.45	0.35 260.21	0.22 325.93	Mag Phase
	208	9.14	17.06	8.81 20.26	5.26 53.86	4.71 318.23	2.21 256.16	4.09 319.92	2.08 350.54	1.88 354.91	1.44 332.67	0.47 324.37	0.46 356.99	Mag Phase
	209	7.02	7.04	5.28 21.88	2.79 113.17	1.59 357.44	1.00 171.82	0.89 273.53	0.07 263.52	0.42 324.14	0.46 329.32	0.03 112.06	0.08 51.90	Mag Phase

Table III. - Continued

(s) Concluded

$\mu_{Nom} = 0.20$

Run 7

POINT	MEAN	1/2P-P	1P	2P	3P	4P	5P	6P	7P	8P	9P	10P	
210	5.00	4.73	4.29 22.76	1.38 129.83	0.37 328.83	0.86 142.40	0.42 291.52	0.21 147.91	0.13 349.05	0.23 346.09	0.10 100.63	0.06 127.77	Mag Phase

Table III. - Continued

(t) Pitch link load, blade 2, lbs

Run 7

$\mu_{Nom} = 0.06$

POINT	MEAN	1/2P-P	1P	2P	3P	4P	5P	6P	7P	8P	9P	10P	
126	-0.24	7.86	4.38 266.30	2.43 278.99	2.48 48.95	0.82 192.88	0.43 193.08	1.14 341.20	0.33 353.37	0.76 272.34	0.25 347.05	0.32 132.17	Mag Phase

$\mu_{Nom} = 0.07$

POINT	MEAN	1/2P-P	1P	2P	3P	4P	5P	6P	7P	8P	9P	10P	
127	2.56	8.74	5.01 281.67	4.36 274.16	2.08 58.52	1.04 197.29	0.76 92.28	1.09 5.10	0.37 37.37	0.73 301.55	0.31 35.40	0.06 158.63	Mag Phase

$\mu_{Nom} = 0.08$

POINT	MEAN	1/2P-P	1P	2P	3P	4P	5P	6P	7P	8P	9P	10P	
128	5.44	10.62	6.52 286.37	5.14 255.94	2.29 58.83	1.38 198.44	1.30 83.50	1.45 12.13	0.40 345.78	0.71 279.95	0.13 62.81	0.09 15.06	Mag Phase
128A	7.91	17.44	11.02 280.29	4.35 223.73	2.68 49.09	2.58 261.45	2.61 119.68	2.49 50.43	1.21 332.65	1.32 225.32	0.78 101.97	0.34 28.57	Mag Phase

$\mu_{Nom} = 0.09$

POINT	MEAN	1/2P-P	1P	2P	3P	4P	5P	6P	7P	8P	9P	10P	
129	8.29	20.90	13.65 281.10	3.50 199.24	1.75 38.92	1.62 300.11	2.64 171.55	5.02 101.75	3.05 25.81	1.61 251.99	0.91 153.44	0.74 75.02	Mag Phase
130	7.17	13.81	10.61 236.43	4.05 273.51	2.68 74.22	0.90 53.45	0.83 177.18	0.70 276.77	0.42 64.93	0.64 286.52	0.29 329.19	0.62 126.11	Mag Phase

Table III. - Continued

(t) Continued

Run 7

 $\mu_{\text{Nom}} = 0.09$ 

POINT	MEAN	1/2P-P	1P	2P	3P	4P	5P	6P	7P	8P	9P	10P	
131	9.67	12.28	9.21 235.81	4.84 271.15	1.83 91.02	0.60 36.75	0.38 92.27	0.92 302.39	0.41 68.12	0.16 297.22	0.31 11.99	0.16 139.77	Mag Phase
132	11.44	13.13	9.34 243.64	4.71 260.02	1.63 84.07	0.88 218.76	0.97 101.96	1.11 10.63	0.25 13.75	0.62 254.32	0.21 50.74	0.03 202.71	Mag Phase
133	12.40	15.61	11.64 251.23	3.68 199.30	2.18 18.06	2.17 257.74	2.31 122.94	2.84 57.62	1.28 333.77	1.12 232.20	0.72 128.01	0.22 44.51	Mag Phase
134	8.82	14.02	11.72 242.36	3.89 265.36	2.54 73.39	0.76 47.28	1.08 193.86	0.66 274.17	0.59 61.35	0.57 295.77	0.29 334.39	0.71 122.11	Mag Phase
135	8.05	12.07	10.82 248.33	3.74 273.42	2.30 91.19	1.21 52.36	0.50 216.87	0.84 267.86	0.47 96.56	0.19 329.63	0.22 334.21	0.36 175.96	Mag Phase
136	10.29	11.26	9.71 242.04	3.94 268.13	1.64 115.71	0.76 12.36	0.27 40.60	0.53 280.04	0.31 97.94	0.04 333.58	0.24 12.48	0.10 241.61	Mag Phase
137	11.05	12.22	9.25 247.19	4.17 267.19	1.82 101.22	0.50 235.07	0.67 58.72	0.41 29.22	0.13 98.02	0.34 250.38	0.23 0.56	0.10 246.12	Mag Phase
138	12.52	14.29	11.96 260.80	2.40 213.44	1.93 33.42	1.23 250.60	2.34 108.30	1.61 82.29	0.66 312.47	0.74 234.06	0.10 97.97	0.10 343.10	Mag Phase
139	11.35	11.66	10.26 245.12	3.65 272.94	1.63 140.30	0.79 16.90	0.52 354.96	0.45 298.50	0.23 162.37	0.11 288.71	0.29 24.79	0.11 259.63	Mag Phase
140	9.88	11.50	10.44 246.04	3.01 267.96	1.73 113.83	1.09 65.28	0.46 254.33	0.91 276.56	0.36 102.87	0.09 10.70	0.30 1.12	0.23 201.06	Mag Phase



Table III. - Continued

(t) Continued

Run 7

 $\mu_{\text{Nom}} = 0.09$ 

POINT	MEAN	1/2P-P	1P	2P	3P	4P	5P	6P	7P	8P	9P	10P	
141	10.13	13.37	10.34 240.95	3.20 259.86	1.99 85.33	0.66 127.51	0.81 190.57	1.18 301.03	0.44 58.72	0.57 274.21	0.33 352.67	0.59 116.22	Mag Phase
142	12.38	14.88	10.06 233.58	5.29 271.31	1.34 86.65	0.76 181.40	0.46 98.89	1.10 333.38	0.39 83.81	0.71 280.45	0.45 354.39	0.23 104.01	Mag Phase
143	12.67	15.32	9.92 242.08	5.77 259.56	2.12 74.45	1.95 230.50	1.46 116.06	1.68 24.36	0.54 16.15	1.01 257.35	0.19 69.94	0.18 63.07	Mag Phase
144	13.09	17.93	11.72 250.38	3.80 204.64	3.01 27.13	3.33 270.72	2.72 131.40	3.90 59.18	1.71 345.94	1.18 236.26	0.91 118.48	0.34 57.22	Mag Phase
145	13.11	15.12	10.58 234.98	5.20 267.62	1.10 110.93	0.97 157.45	0.48 98.50	1.18 329.36	0.20 73.65	0.61 274.28	0.27 1.46	0.17 112.29	Mag Phase
146	11.50	14.32	11.53 242.96	3.49 268.38	2.07 86.96	1.12 108.38	0.95 178.54	1.30 292.20	0.34 71.49	0.46 282.75	0.38 357.41	0.60 124.94	Mag Phase

 $\mu_{\text{Nom}} = 0.13$ 

POINT	MEAN	1/2P-P	1P	2P	3P	4P	5P	6P	7P	8P	9P	10P	
147	7.86	12.51	12.06 260.50	2.32 273.08	2.76 108.99	1.53 100.11	0.73 302.14	1.36 293.64	0.52 122.69	0.15 112.01	0.38 353.97	0.33 223.39	Mag Phase
148	10.49	11.86	9.98 264.36	3.56 277.92	2.30 145.83	1.97 107.13	1.01 23.70	1.77 305.55	0.17 3.67	0.20 203.14	0.29 72.20	0.21 191.55	Mag Phase
149	13.02	15.01	10.16 250.57	5.35 283.33	2.92 129.18	1.38 126.36	1.03 43.25	1.11 352.09	0.16 43.56	0.43 292.24	0.30 72.92	0.03 40.69	Mag Phase

Table III. - Continued

(t) Continued

Run 7

 $\mu_{\text{Nom}} = 0.13$ 

POINT	MEAN	1/2P-P	1P	2P	3P	4P	5P	6P	7P	8P	9P	10P	
150	13.38	15.19	11.60 252.85	4.40 265.25	3.14 70.64	2.71 260.07	1.70 104.25	2.06 35.86	1.20 326.78	1.12 265.72	0.79 107.63	0.18 22.27	Mag Phase
151	13.91	18.40	12.66 267.69	4.32 243.60	3.33 40.60	2.78 281.83	0.25 62.31	1.30 34.97	1.61 328.62	1.27 257.76	0.73 120.94	0.10 2.81	Mag Phase
152	13.92	15.45	11.35 254.50	5.02 279.73	2.32 144.64	1.35 142.51	1.11 30.86	0.95 1.87	0.30 316.87	0.62 297.78	0.23 99.15	0.08 199.35	Mag Phase
153	11.88	12.80	10.47 256.69	2.97 271.21	2.59 146.66	2.19 116.17	1.07 7.88	1.72 301.35	0.06 138.81	0.23 211.53	0.26 56.86	0.15 204.22	Mag Phase
154	8.17	11.59	11.57 274.34	1.38 252.22	2.56 137.86	1.27 101.95	0.94 3.81	1.16 302.69	0.36 205.58	0.29 167.86	0.40 40.92	0.05 154.18	Mag Phase
155	9.86	11.74	10.31 265.81	2.56 276.13	1.95 148.68	1.43 106.05	0.91 33.46	1.48 311.26	0.11 166.14	0.30 220.76	0.51 60.54	0.20 149.36	Mag Phase
156	12.40	13.74	10.15 250.72	4.67 284.80	2.31 134.64	0.82 130.91	0.80 53.25	0.59 340.69	0.12 99.47	0.52 286.59	0.41 38.17	0.13 165.51	Mag Phase
157	12.87	14.51	12.00 257.79	4.50 270.82	2.50 84.01	2.18 274.43	1.76 121.35	1.71 50.50	1.13 348.09	1.19 278.72	0.55 128.56	0.17 119.31	Mag Phase
158	12.86	17.38	12.69 265.80	3.84 263.64	3.55 51.25	2.94 289.53	1.38 161.20	1.57 69.98	1.64 343.61	1.56 274.63	0.51 154.09	0.23 118.72	Mag Phase
159	12.16	14.48	11.12 251.68	4.85 288.61	2.18 143.96	0.61 124.66	0.79 49.34	0.58 0.29	0.07 28.31	0.56 305.82	0.38 57.16	0.18 172.43	Mag Phase

Table III. - Continued

(t) Continued

Run 7

 $\mu_{\text{Nom}} = 0.13$ 

POINT	MEAN	1/2P-P	1P	2P	3P	4P	5P	6P	7P	8P	9P	10P	
160	12.14	13.08	11.47 256.74	2.69 272.03	2.07 154.42	1.05 110.40	0.74 357.93	1.35 303.19	0.14 196.19	0.36 246.43	0.45 34.71	0.15 141.41	Mag Phase
161	8.89	10.07	9.78 279.11	1.41 231.00	1.84 164.72	1.08 98.26	0.96 40.78	0.90 314.11	0.35 272.95	0.28 232.00	0.24 77.28	0.27 124.81	Mag Phase
162	10.87	11.29	9.73 260.53	2.40 282.61	1.89 154.91	0.77 82.25	0.65 32.70	1.06 300.82	0.21 240.11	0.42 229.90	0.44 62.36	0.16 150.82	Mag Phase
163	11.27	12.84	10.57 251.50	4.29 287.15	1.99 128.19	0.22 120.28	0.60 42.92	0.40 314.45	0.07 39.98	0.33 268.98	0.46 43.41	0.18 142.81	Mag Phase
164	10.98	13.29	11.20 260.27	4.37 271.91	2.65 80.19	2.05 259.09	1.59 108.06	1.12 52.71	0.90 331.43	0.95 247.60	0.43 110.83	0.16 124.24	Mag Phase
165	11.40	16.56	12.09 268.75	3.42 270.08	3.39 53.58	3.05 282.22	1.65 145.07	1.49 76.82	1.60 340.41	1.30 257.00	0.44 139.12	0.26 74.93	Mag Phase
166	11.25	13.74	11.27 256.76	4.67 290.47	2.21 141.79	0.36 115.10	0.78 63.73	0.40 10.95	0.22 298.76	0.35 288.75	0.43 103.44	0.28 177.51	Mag Phase
167	11.11	13.40	11.72 259.38	2.43 269.28	2.26 167.23	1.03 85.64	0.96 8.50	1.04 307.86	0.35 244.66	0.33 248.98	0.55 69.64	0.23 142.07	Mag Phase

Table III. - Continued

(t) Continued

Run 7

 $\mu_{\text{Nom}} = 0.16$ 

POINT	MEAN	1/2P-P	1P	2P	3P	4P	5P	6P	7P	8P	9P	10P	
168	7.82	10.51	10.51 284.10	0.97 229.36	1.92 174.50	1.00 88.65	1.15 52.73	0.87 313.51	0.48 285.56	0.39 239.74	0.14 77.37	0.31 137.35	Mag Phase
169	10.45	10.93	10.05 269.78	2.18 292.37	1.44 154.83	1.04 89.30	1.16 30.58	0.87 318.33	0.24 280.80	0.33 242.80	0.44 100.50	0.38 156.80	Mag Phase
170	11.10	13.39	12.10 262.77	3.90 293.47	2.11 129.03	0.97 112.28	0.90 47.07	0.57 357.92	0.20 280.06	0.46 263.16	0.43 95.58	0.21 191.48	Mag Phase
171	11.03	14.09	12.25 268.17	3.93 275.38	2.92 72.57	1.66 258.00	1.44 122.79	1.28 79.12	0.96 338.84	0.88 271.25	0.43 125.44	0.28 110.93	Mag Phase
172	11.41	15.00	12.86 273.13	3.24 261.46	3.96 43.10	1.89 262.94	0.81 210.30	1.07 136.20	0.84 18.81	0.73 284.33	0.08 100.51	0.46 145.46	Mag Phase
173	11.09	13.70	11.32 259.54	4.37 297.94	2.27 111.71	0.77 132.84	0.77 37.47	0.39 62.06	0.35 273.63	0.31 292.23	0.26 121.56	0.16 198.76	Mag Phase
174	7.00	7.80	7.37 278.28	0.99 280.15	1.02 176.21	0.98 126.38	0.93 62.21	0.51 2.81	0.29 297.30	0.27 304.44	0.08 148.74	0.32 212.11	Mag Phase
175	5.96	6.87	6.67 283.26	1.59 294.86	1.28 154.35	1.01 120.96	1.14 38.40	0.63 330.74	0.56 287.94	0.19 301.22	0.20 99.90	0.29 201.56	Mag Phase
176	10.62	11.10	9.23 264.14	2.73 290.63	1.93 149.97	0.89 132.12	1.42 40.64	0.87 341.39	0.44 305.33	0.35 288.15	0.33 111.08	0.37 168.96	Mag Phase
177	12.17	14.90	11.24 256.50	4.58 293.98	2.42 121.65	0.54 163.46	1.11 64.70	0.88 38.58	0.46 338.29	0.55 300.92	0.33 127.34	0.29 188.64	Mag Phase

Table III. - Continued

Run 7													
(t) Continued													
$\mu_{\text{Nom}} = 0.16$													
POINT	MEAN	1/2P-P	1P	2P	3P	4P	5P	6P	7P	8P	9P	10P	
178	11.71	15.65	13.22 268.07	4.45 265.58	2.85 71.15	1.96 276.94	0.96 146.51	1.08 91.63	1.00 2.33	1.02 284.20	0.45 145.67	0.24 141.64	Mag Phase
179	12.04	17.05	13.57 270.79	3.92 247.34	4.13 34.49	1.48 276.65	1.10 215.52	1.53 104.18	1.43 21.26	0.90 271.35	0.17 148.47	0.31 140.40	Mag Phase
180	12.08	14.62	11.17 257.53	4.95 290.78	2.14 116.44	0.93 144.82	1.05 41.05	0.77 30.84	0.55 307.90	0.52 289.86	0.23 130.47	0.31 165.78	Mag Phase
181	7.85	7.81	7.57 278.70	1.09 272.73	1.21 160.63	0.86 106.46	1.27 36.29	0.67 325.15	0.42 282.99	0.18 247.59	0.22 79.79	0.32 172.73	Mag Phase
182	5.11	6.57	5.74 278.08	2.06 302.53	1.69 130.74	0.86 105.06	1.18 13.31	0.79 304.39	0.38 256.09	0.15 231.42	0.27 74.25	0.32 188.92	Mag Phase
183	9.56	10.62	7.40 259.50	3.04 304.94	1.98 134.80	0.83 161.38	1.74 29.23	0.68 325.38	0.45 306.41	0.23 343.64	0.14 104.98	0.25 216.38	Mag Phase
184	12.89	15.49	10.70 251.71	4.88 290.51	2.17 111.80	0.91 177.93	1.35 53.99	1.25 47.57	0.79 329.55	0.54 300.98	0.26 127.15	0.09 153.08	Mag Phase
185	12.27	15.40	12.90 266.40	4.40 266.62	3.13 63.39	2.21 269.93	1.11 154.88	1.07 89.99	1.02 356.58	0.61 306.43	0.31 160.30	0.23 174.33	Mag Phase
186	11.99	16.67	14.08 270.47	4.02 257.81	3.96 29.41	1.78 266.79	0.92 215.82	1.27 124.65	1.22 27.07	0.58 303.72	0.08 207.05	0.28 158.47	Mag Phase
187	12.50	15.97	11.32 259.52	4.94 288.79	2.56 116.46	1.01 159.96	1.52 67.05	1.39 47.96	0.81 324.92	0.63 300.56	0.32 145.99	0.26 176.94	Mag Phase
188	8.55	10.13	8.86 264.63	1.26 265.05	1.43 168.98	0.89 133.48	1.49 36.41	0.76 326.26	0.35 288.94	0.16 256.24	0.22 66.21	0.25 197.39	Mag Phase

Table III. - Continued

(t) Continued

Run 7

 $\mu_{\text{Nom}} = 0.20$ 

POINT	MEAN	1/2P-P	1P	2P	3P	4P	5P	6P	7P	8P	9P	10P	
189	6.35	7.99	7.40 269.94	1.41 290.68	1.30 141.27	0.77 130.20	1.20 33.88	0.73 326.10	0.24 246.07	0.25 279.83	0.13 65.37	0.20 194.04	Mag Phase
190	10.25	11.44	10.15 272.49	3.53 323.70	1.40 144.99	1.50 137.11	1.51 49.57	0.66 337.28	0.23 351.70	0.59 322.99	0.10 116.30	0.30 244.96	Mag Phase
191	11.94	16.18	12.25 268.02	5.28 284.18	3.13 80.03	2.44 213.45	1.16 118.46	1.69 71.79	0.99 347.75	0.75 300.99	0.24 148.10	0.24 242.93	Mag Phase
192	11.26	15.83	12.08 270.86	4.84 257.62	4.26 56.01	2.89 235.06	1.57 180.65	1.80 87.03	0.92 10.87	1.08 305.81	0.27 222.36	0.31 188.52	Mag Phase
193	10.49	19.16	14.22 273.79	5.02 249.35	4.67 41.00	2.60 225.97	2.68 218.69	0.97 178.31	0.71 30.30	0.90 311.95	0.44 282.32	0.53 172.85	Mag Phase
194	8.21	20.01	14.43 275.33	4.42 243.90	5.47 41.52	3.56 240.54	1.60 205.49	0.42 32.76	1.44 14.23	0.93 295.75	0.11 304.54	0.22 191.93	Mag Phase
195	9.15	15.29	11.52 273.45	5.30 299.13	3.45 97.15	2.26 216.11	1.26 108.32	1.61 66.09	0.96 348.60	0.68 310.03	0.31 145.48	0.12 218.70	Mag Phase
196	7.09	12.38	11.18 271.54	1.67 309.96	1.72 176.76	1.31 115.48	1.41 54.65	0.93 341.83	0.34 289.64	0.36 281.21	0.16 74.23	0.30 167.49	Mag Phase
197	5.41	11.08	10.66 273.62	1.29 306.43	1.29 178.81	1.21 114.37	1.16 48.56	0.79 342.82	0.34 300.74	0.30 250.23	0.19 103.51	0.31 176.28	Mag Phase
198	5.97	10.79	9.50 275.37	3.17 317.37	1.75 135.73	0.88 165.93	0.95 39.46	0.48 358.49	0.35 323.68	0.26 303.05	0.19 157.57	0.36 209.30	Mag Phase

Table III. - Continued

Run 7													
(t) Continued													
$\mu_{\text{Nom}} = 0.20$													
POINT	MEAN	1/2P-P	1P	2P	3P	4P	5P	6P	7P	8P	9P	10P	
199	7.30	13.16	10.27 281.01	5.02 299.26	3.08 109.07	1.84 214.00	0.84 82.33	0.87 60.66	0.64 10.91	0.54 315.97	0.19 141.06	0.28 249.71	Mag Phase
200	8.20	17.03	12.94 278.59	4.65 262.30	4.14 59.12	2.22 249.13	1.94 206.15	1.77 148.08	0.91 45.94	1.12 309.47	0.31 237.79	0.33 171.81	Mag Phase
201	8.01	19.66	14.38 278.66	4.13 247.06	5.31 27.74	2.42 223.74	2.16 260.12	0.42 263.82	1.04 15.28	0.66 300.27	0.29 302.12	0.12 188.24	Mag Phase
202	7.68	14.09	10.82 275.08	4.94 300.29	3.29 101.16	1.82 207.80	0.84 75.13	1.00 49.31	0.66 332.73	0.45 294.32	0.27 127.22	0.17 231.74	Mag Phase
203	5.70	11.30	11.12 274.62	1.04 298.46	1.03 186.08	1.13 120.62	1.12 57.36	0.76 345.89	0.31 317.62	0.31 261.43	0.15 88.72	0.32 183.10	Mag Phase
204	3.95	9.72	9.78 277.45	0.76 309.03	0.87 177.80	1.03 113.56	0.84 51.52	0.72 347.37	0.26 285.28	0.31 261.32	0.14 139.91	0.25 184.94	Mag Phase
205	5.01	9.86	9.25 277.58	2.86 315.76	1.25 127.08	0.89 151.89	0.55 13.14	0.42 341.64	0.22 285.77	0.22 308.81	0.23 127.33	0.28 209.14	Mag Phase
206	5.88	11.83	10.02 280.21	4.31 295.65	2.47 103.87	1.46 183.10	0.48 29.90	0.56 17.27	0.21 346.92	0.43 315.61	0.15 127.44	0.28 239.96	Mag Phase
207	7.15	15.93	11.90 280.88	4.18 258.01	4.43 50.98	2.88 232.75	1.52 146.52	1.57 76.65	0.94 347.90	1.02 280.68	0.28 143.95	0.25 134.61	Mag Phase
208	7.39	19.17	13.02 281.54	3.53 238.56	6.05 30.66	3.47 228.81	0.99 247.80	0.94 34.16	0.84 341.29	0.59 265.38	0.26 17.90	0.04 186.53	Mag Phase
209	5.97	12.45	10.30 278.57	4.24 300.87	2.69 100.65	1.26 174.38	0.55 18.43	0.57 32.57	0.26 312.23	0.43 310.03	0.20 130.25	0.20 217.45	Mag Phase

Table III. - Continued

Run 7													
(t) Concluded													
$\mu_{Nom} = 0.20$													
POINT	MEAN	1/2P-P	1P	2P	3P	4P	5P	6P	7P	8P	9P	10P	
210	4.59	10.67	10.28	2.77	1.63	1.02	1.01	0.76	0.40	0.35	0.26	0.28	Mag
			279.49	318.06	153.28	139.16	23.30	14.83	276.16	308.89	166.22	224.27	Phase



Table III. - Continued

(u) Pitch link load, blade 3, lbs

Run 7

$\mu_{Nom} = 0.06$

POINT	MEAN	1/2P-P	1P	2P	3P	4P	5P	6P	7P	8P	9P	10P	
126	8.11	8.51	4.66 158.66	2.36 58.89	2.17 31.34	0.37 119.62	1.89 92.16	1.48 167.23	0.52 73.92	0.29 274.11	0.22 69.48	0.26 122.14	Mag Phase

$\mu_{Nom} = 0.07$

POINT	MEAN	1/2P-P	1P	2P	3P	4P	5P	6P	7P	8P	9P	10P	
127	9.98	10.07	4.94 164.88	3.80 68.52	2.19 44.01	0.84 121.88	2.22 90.80	1.36 169.44	0.53 115.59	0.29 312.77	0.15 121.33	0.28 142.24	Mag Phase

$\mu_{Nom} = 0.08$

POINT	MEAN	1/2P-P	1P	2P	3P	4P	5P	6P	7P	8P	9P	10P	
128	11.95	9.98	5.47 166.22	4.12 61.73	1.74 38.66	0.88 162.74	2.21 66.66	0.84 204.41	0.36 108.41	0.37 329.52	0.21 36.43	0.22 172.42	Mag Phase
128A	13.60	13.89	7.65 177.14	5.15 63.63	1.58 35.90	1.55 181.44	2.40 65.16	2.58 299.38	1.27 185.96	0.53 267.16	0.69 75.17	0.39 303.00	Mag Phase

$\mu_{Nom} = 0.09$

POINT	MEAN	1/2P-P	1P	2P	3P	4P	5P	6P	7P	8P	9P	10P	
129	13.47	17.97	8.60 180.76	4.94 47.78	2.22 96.07	1.91 240.96	3.33 82.17	1.24 302.10	1.80 164.20	1.82 262.55	1.39 95.86	0.73 297.68	Mag Phase
130	10.42	7.35	4.67 176.49	2.31 70.14	1.37 37.80	1.06 91.48	1.78 81.89	0.53 116.89	0.36 88.51	0.19 28.23	0.07 115.71	0.19 90.37	Mag Phase

Table III. - Continued

(u) Continued

Run 7

 $\mu_{\text{Nom}} = 0.09$ 

POINT	MEAN	1/2P-P	1P	2P	3P	4P	5P	6P	7P	8P	9P	10P	
131	11.28	8.62	5.18 162.92	3.20 71.48	1.66 31.09	0.94 104.43	1.57 72.05	0.48 189.18	0.24 98.24	0.30 350.81	0.11 90.30	0.10 86.01	Mag Phase
132	12.14	8.80	5.66 165.55	4.09 72.24	1.64 27.59	0.75 112.25	1.22 46.58	0.81 204.86	0.10 51.13	0.38 327.42	0.13 8.11	0.11 128.92	Mag Phase
133	12.62	13.06	7.10 176.40	5.02 68.01	1.25 63.67	1.10 192.31	1.71 68.99	2.92 286.09	1.31 162.32	0.68 309.86	0.38 102.94	0.41 260.80	Mag Phase
134	10.33	7.21	4.50 175.59	2.27 73.39	1.30 40.31	0.96 95.83	1.78 83.23	0.49 119.72	0.32 96.75	0.19 26.64	0.06 101.53	0.19 95.71	Mag Phase
135	9.60	5.44	4.38 182.95	1.92 74.69	0.90 40.09	0.85 95.74	1.12 90.90	0.26 144.35	0.17 134.12	0.25 352.70	0.10 14.25	0.13 121.29	Mag Phase
136	10.50	7.17	5.00 163.84	2.67 71.85	1.05 23.73	0.81 105.59	0.93 65.88	0.32 200.16	0.13 123.35	0.29 332.31	0.16 7.54	0.07 92.95	Mag Phase
137	11.46	7.84	5.50 164.24	3.60 74.84	1.22 32.58	0.74 124.68	0.85 28.75	0.49 222.73	0.05 25.68	0.16 302.34	0.16 351.58	0.03 96.71	Mag Phase
138	12.46	11.42	7.03 178.68	4.71 73.43	1.02 49.92	1.10 192.03	1.13 56.98	2.53 300.79	1.05 211.45	0.39 265.90	0.34 130.70	0.23 323.67	Mag Phase
139	10.57	7.21	5.18 160.20	2.56 78.61	0.92 19.98	0.76 108.72	0.84 74.90	0.36 206.72	0.19 122.29	0.24 332.75	0.10 13.21	0.05 110.72	Mag Phase
140	9.51	5.36	4.13 178.56	1.73 76.08	0.71 42.22	0.76 107.16	1.08 90.95	0.34 158.36	0.21 140.65	0.25 2.84	0.08 29.39	0.13 129.60	Mag Phase

Table III. - Continued

(u) Continued

Run 7

$\mu_{Nom} = 0.09$

POINT	MEAN	1/2P-P	1P	2P	3P	4P	5P	6P	7P	8P	9P	10P	
141	10.07	8.03	4.29 177.04	2.65 85.57	1.55 40.60	1.19 117.05	2.23 91.47	0.93 150.74	0.36 119.24	0.22 320.94	0.10 151.82	0.18 129.09	Mag Phase
142	11.45	9.65	5.13 160.33	3.26 76.05	1.83 38.98	1.36 139.23	2.13 71.49	0.91 181.46	0.43 102.05	0.39 339.53	0.12 110.11	0.20 101.35	Mag Phase
143	12.36	10.80	5.81 164.42	4.55 71.47	1.94 38.69	1.33 149.07	2.11 64.82	1.10 204.91	0.34 129.83	0.46 317.88	0.17 41.89	0.15 159.66	Mag Phase
144	12.81	14.15	7.29 173.28	5.23 64.65	1.62 75.54	1.36 208.95	2.35 69.99	3.16 294.39	1.31 164.45	0.89 270.24	0.72 87.61	0.52 288.45	Mag Phase
145	11.84	9.95	5.48 160.06	3.31 74.92	1.72 30.39	1.27 128.95	2.28 66.82	0.86 174.19	0.41 86.39	0.38 329.73	0.18 101.37	0.22 96.92	Mag Phase
146	10.64	7.87	4.49 173.67	2.33 83.06	1.50 46.42	1.36 118.10	2.20 91.55	0.82 152.23	0.41 118.22	0.20 337.72	0.09 169.37	0.18 129.91	Mag Phase

$\mu_{Nom} = 0.13$

POINT	MEAN	1/2P-P	1P	2P	3P	4P	5P	6P	7P	8P	9P	10P	
147	7.67	4.67	4.08 187.14	1.19 106.46	0.88 33.12	0.92 118.28	0.90 70.63	0.48 119.94	0.13 58.78	0.10 69.43	0.11 281.15	0.12 67.29	Mag Phase
148	9.20	5.88	4.34 185.15	2.44 107.43	0.89 38.31	1.35 125.61	1.32 67.55	0.57 149.64	0.29 134.45	0.40 336.97	0.13 231.87	0.15 80.03	Mag Phase
149	11.45	8.63	5.27 172.49	3.48 95.44	0.99 45.35	1.71 127.98	1.55 69.83	0.32 190.00	0.48 144.69	0.73 324.32	0.04 231.26	0.23 89.30	Mag Phase

Table III. - Continued

(u) Continued

Run 7

 $\mu_{\text{Nom}} = 0.13$ 

POINT	MEAN	1/2P-P	1P	2P	3P	4P	5P	6P	7P	8P	9P	10P	
150	12.87	10.65	6.31 172.94	4.64 82.04	0.79 76.48	1.55 136.38	1.95 79.65	1.17 281.23	1.04 145.73	1.00 308.23	0.24 60.95	0.14 16.50	Mag Phase
151	13.25	14.90	7.49 177.35	5.11 70.66	1.25 105.03	0.75 271.77	2.85 103.42	2.52 310.60	1.58 146.94	1.29 298.73	0.69 79.62	0.54 324.91	Mag Phase
152	11.97	8.62	5.39 177.08	3.41 91.36	0.98 54.97	1.88 136.04	1.57 78.09	0.21 177.05	0.41 142.03	0.71 332.02	0.03 359.66	0.24 92.53	Mag Phase
153	10.11	5.66	4.61 192.01	2.30 101.68	0.76 43.95	1.40 122.83	1.35 67.02	0.61 151.26	0.31 142.71	0.39 340.10	0.15 241.16	0.15 81.57	Mag Phase
154	7.29	4.63	3.95 189.05	0.99 104.37	0.89 33.86	0.66 108.29	0.91 68.31	0.43 143.03	0.10 41.20	0.03 343.83	0.11 319.10	0.08 79.23	Mag Phase
155	8.71	5.84	4.32 186.58	2.13 106.23	0.94 47.64	1.09 121.57	1.70 83.28	0.52 159.41	0.29 130.18	0.23 321.35	0.08 249.85	0.13 98.83	Mag Phase
156	10.81	8.95	5.36 169.30	3.10 88.09	1.21 45.88	1.50 121.49	2.04 70.98	0.15 229.04	0.44 139.62	0.50 321.73	0.02 229.95	0.15 77.66	Mag Phase
157	12.24	11.85	6.49 173.67	4.67 84.27	1.27 58.35	1.86 141.83	2.58 80.42	1.05 289.74	1.06 156.67	0.82 326.14	0.16 102.37	0.08 23.58	Mag Phase
158	12.57	15.20	7.60 177.93	5.19 71.08	1.58 75.65	0.70 232.21	3.43 101.91	2.81 321.93	1.81 152.36	1.49 312.92	0.60 108.05	0.54 332.40	Mag Phase
159	11.12	8.98	5.66 172.39	3.00 87.59	1.20 58.35	1.46 124.03	2.06 79.49	0.09 235.73	0.44 154.51	0.48 334.82	0.04 230.15	0.17 85.03	Mag Phase

Table III. - Continued

(u) Continued

Run 7

 $\mu_{\text{Nom}} = 0.13$ 

POINT	MEAN	1/2P-P	1P	2P	3P	4P	5P	6P	7P	8P	9P	10P	
160	9.69	6.41	4.82 181.61	1.87 91.02	0.83 48.23	1.20 120.43	1.74 80.61	0.44 136.88	0.39 121.83	0.27 319.61	0.08 246.31	0.13 82.60	Mag Phase
161	6.85	4.29	3.73 185.89	1.05 103.97	0.66 48.29	0.53 108.19	0.80 80.00	0.27 158.95	0.09 61.24	0.09 326.29	0.08 341.92	0.05 99.47	Mag Phase
162	8.17	5.58	4.15 182.79	2.04 101.07	0.89 52.77	0.96 115.34	1.46 79.23	0.28 146.48	0.27 121.07	0.18 305.99	0.06 262.08	0.11 80.04	Mag Phase
163	10.27	8.97	5.60 166.08	2.99 87.04	1.37 50.67	1.09 111.97	2.05 66.71	0.29 310.96	0.32 130.82	0.21 313.57	0.09 296.56	0.14 63.88	Mag Phase
164	12.02	11.78	6.62 171.27	4.55 82.61	1.64 41.27	1.47 127.42	2.50 63.84	0.81 313.51	0.82 155.82	0.37 324.83	0.07 76.32	0.18 353.82	Mag Phase
165	12.43	13.37	7.48 178.30	4.96 75.72	1.78 65.26	0.11 218.07	2.81 92.51	2.48 330.62	1.52 160.48	0.91 324.19	0.45 117.05	0.40 340.24	Mag Phase
166	10.38	9.14	5.85 167.57	2.91 89.35	1.35 61.91	1.18 128.67	1.97 83.72	0.31 335.93	0.29 142.85	0.22 322.57	0.06 313.60	0.11 88.61	Mag Phase
167	8.53	5.71	4.38 179.17	1.67 92.38	0.70 62.65	0.97 127.52	1.44 82.44	0.23 138.44	0.31 112.16	0.21 325.37	0.10 258.53	0.09 92.43	Mag Phase

Table III. - Continued

(u) Continued

Run 7

$\mu_{Nom} = 0.16$

POINT	MEAN	1/2P-P	1P	2P	3P	4P	5P	6P	7P	8P	9P	10P	
168	5.73	4.56	3.96 181.19	0.64 106.48	0.87 54.62	0.57 120.97	0.70 72.90	0.45 174.07	0.18 60.31	0.07 311.60	0.05 314.76	0.03 120.18	Mag Phase
169	7.37	5.52	4.45 180.68	1.68 105.02	1.08 60.18	1.07 127.30	1.42 78.20	0.29 169.34	0.33 114.31	0.24 311.05	0.11 259.70	0.10 75.45	Mag Phase
170	9.81	8.76	5.92 170.29	2.66 92.48	1.61 57.91	1.55 126.25	1.96 73.03	0.37 317.26	0.38 120.74	0.29 291.85	0.18 262.92	0.14 65.10	Mag Phase
171	11.92	11.34	7.11 177.58	4.24 87.24	1.60 68.51	1.52 135.96	2.62 86.53	1.29 335.46	0.80 158.33	0.62 309.17	0.16 153.46	0.30 357.43	Mag Phase
172	12.57	14.61	8.09 179.88	4.61 71.82	1.91 93.61	0.68 357.47	3.05 112.03	3.13 350.52	1.92 168.36	1.26 339.66	0.46 162.10	0.54 357.38	Mag Phase
173	10.39	9.12	6.21 173.18	2.77 86.69	1.75 59.26	1.69 125.34	2.09 78.65	0.49 310.70	0.34 115.83	0.31 297.43	0.22 262.85	0.13 72.94	Mag Phase
174	5.81	4.47	3.80 183.36	0.72 112.86	0.88 54.46	0.55 125.02	0.73 81.34	0.40 190.26	0.16 63.55	0.09 344.39	0.03 338.77	0.03 108.00	Mag Phase
175	5.95	4.57	3.92 178.38	0.69 117.35	0.97 46.28	0.67 129.21	0.78 72.71	0.40 169.33	0.16 106.31	0.10 341.87	0.11 272.15	0.07 103.88	Mag Phase
176	7.89	5.81	4.41 180.02	1.72 113.27	0.99 57.15	1.22 133.81	1.63 86.65	0.30 199.23	0.48 122.02	0.43 309.58	0.13 257.19	0.09 86.40	Mag Phase
177	10.34	9.36	5.84 171.12	2.81 96.14	1.62 54.19	2.01 135.25	2.12 81.31	0.27 276.46	0.61 130.36	0.49 298.84	0.17 261.55	0.15 90.99	Mag Phase

Table III. - Continued

Run 7													
(u) Continued													
$\mu_{\text{Nom}} = 0.16$													
POINT	MEAN	1/2P-P	1P	2P	3P	4P	5P	6P	7P	8P	9P	10P	
178	12.13	12.90	7.43 177.83	4.60 79.03	1.41 74.55	1.13 156.96	3.09 104.88	2.10 330.90	1.49 158.42	1.30 316.03	0.33 119.56	0.38 357.49	Mag Phase
179	12.51	16.67	8.55 178.31	4.96 60.92	2.08 89.56	0.96 320.58	3.11 124.28	3.58 343.40	2.44 162.01	1.99 316.43	0.64 147.04	0.71 339.15	Mag Phase
180	10.97	9.05	6.13 174.05	2.92 87.94	1.50 51.67	1.82 126.87	2.07 69.96	0.22 279.07	0.64 113.16	0.55 281.57	0.14 242.52	0.13 47.72	Mag Phase
181	6.28	4.36	3.83 178.14	0.69 110.62	0.93 45.66	0.64 128.18	0.81 67.98	0.33 162.77	0.15 78.14	0.09 333.14	0.10 265.78	0.06 82.95	Mag Phase
182	6.19	4.38	3.74 172.26	0.89 110.38	0.79 40.73	0.91 123.46	0.72 55.05	0.59 130.73	0.14 103.34	0.17 273.01	0.10 256.55	0.09 75.36	Mag Phase
183	8.24	5.73	4.24 178.76	2.01 117.96	0.80 52.56	1.48 129.29	1.25 66.12	0.38 133.42	0.42 135.38	0.38 307.69	0.19 259.53	0.15 69.01	Mag Phase
184	10.73	8.70	5.47 170.14	3.35 93.05	1.01 60.44	2.01 123.30	1.34 47.78	0.32 325.76	0.59 110.45	0.47 301.24	0.12 217.75	0.22 44.02	Mag Phase
185	12.52	13.20	7.38 179.14	4.85 77.47	1.12 96.49	0.65 183.42	2.72 101.88	2.33 329.98	1.42 155.02	1.00 325.57	0.28 128.78	0.45 4.29	Mag Phase
186	12.84	16.16	8.74 179.09	5.44 62.92	1.86 98.74	1.45 299.62	2.52 123.84	2.79 348.44	1.68 166.57	1.14 317.94	0.52 134.42	0.71 354.56	Mag Phase
187	11.33	8.52	5.86 177.57	3.19 89.58	1.12 54.40	2.08 126.67	1.31 63.86	0.24 340.76	0.59 117.27	0.51 308.06	0.11 227.06	0.23 55.59	Mag Phase
188	7.06	4.64	3.87 180.23	0.97 119.08	0.77 43.82	0.87 140.59	0.81 69.23	0.60 146.42	0.11 108.32	0.16 317.29	0.11 292.56	0.13 99.41	Mag Phase

Table III. - Continued

(u) Continued

Run 7

 $\mu_{\text{Nom}} = 0.20$ 

POINT	MEAN	1/2P-P	1P	2P	3P	4P	5P	6P	7P	8P	9P	10P	
189	6.02	5.38	4.15 179.75	0.70 110.37	0.92 49.28	0.94 131.14	0.64 100.86	0.88 163.02	0.32 35.20	0.11 25.20	0.08 244.56	0.08 90.86	Mag Phase
190	8.58	6.48	4.97 184.08	1.89 122.92	0.75 66.77	1.83 129.16	1.35 103.98	0.83 170.75	0.20 89.90	0.48 3.92	0.11 235.65	0.16 96.80	Mag Phase
191	10.91	9.47	6.40 179.48	3.04 95.32	1.32 57.95	2.80 116.13	1.82 96.33	0.46 3.27	0.46 151.46	0.82 344.67	0.16 172.38	0.23 63.09	Mag Phase
192	11.57	11.76	7.27 182.08	4.07 80.44	1.45 75.09	1.69 109.51	2.92 103.40	1.88 331.24	1.32 155.08	1.35 336.58	0.33 141.32	0.25 12.71	Mag Phase
193	12.13	17.19	8.57 182.47	5.37 65.03	1.54 94.68	1.03 332.61	3.66 120.14	3.67 346.44	2.13 176.49	1.79 344.16	0.61 171.13	0.65 17.24	Mag Phase
194	12.40	18.40	9.59 181.78	5.41 60.00	2.03 90.42	1.86 350.16	3.89 126.89	4.07 353.11	2.65 179.96	2.01 347.56	0.85 184.89	0.70 18.66	Mag Phase
195	11.24	9.21	6.65 184.96	3.14 94.14	1.27 67.52	2.54 116.59	1.88 98.33	0.47 19.52	0.50 155.97	0.84 349.45	0.09 192.89	0.20 90.88	Mag Phase
196	7.24	4.89	3.93 192.86	0.76 99.54	0.94 55.67	1.09 139.33	0.75 99.74	0.85 181.69	0.25 49.49	0.15 25.25	0.07 283.28	0.07 103.65	Mag Phase
197	5.43	5.51	4.46 183.70	0.42 79.35	1.38 57.92	0.98 145.43	0.67 96.09	0.74 179.01	0.16 70.70	0.15 8.63	0.09 296.84	0.07 117.85	Mag Phase
198	7.66	6.17	5.01 183.36	1.47 107.52	1.26 64.79	1.69 129.24	4.54 88.45	0.56 177.74	0.30 112.98	0.43 344.10	0.09 210.48	0.10 79.03	Mag Phase



Table III. - Continued

Run 7													(u) Continued	
													$\mu_{\text{Nom}} = 0.20$	
POINT	MEAN	1/2P-P	1P	2P	3P	4P	5P	6P	7P	8P	9P	10P		
199	10.14	9.82	6.47 178.66	2.70 94.61	2.02 68.16	2.50 129.25	2.22 99.74	0.37 2.18	0.44 167.50	0.59 355.29	0.07 277.57	0.14 97.25	Mag Phase	
200	11.79	15.39	8.15 181.14	4.54 66.84	2.62 96.42	0.23 61.53	4.06 114.73	3.53 330.94	2.12 160.64	1.90 333.72	0.67 149.64	0.57 4.31	Mag Phase	
201	12.09	20.84	9.99 177.21	4.66 55.06	2.46 95.96	1.99 9.45	4.25 137.28	5.02 352.82	3.44 174.95	2.74 343.51	1.04 175.36	0.62 12.17	Mag Phase	
202	10.49	9.76	6.64 180.45	2.69 84.67	2.27 65.42	2.52 124.96	2.27 94.33	0.40 6.97	0.42 157.66	0.56 336.00	0.13 285.92	0.16 79.55	Mag Phase	
203	5.59	5.37	4.29 184.87	0.42 98.22	1.33 60.64	0.91 146.91	0.63 96.33	0.73 181.72	0.18 70.62	0.17 22.30	0.07 297.73	0.06 127.13	Mag Phase	
204	4.62	5.10	4.22 183.68	0.33 61.19	1.27 59.97	0.89 135.81	0.45 74.81	0.68 184.79	0.14 56.98	0.06 5.72	0.01 214.38	0.04 67.94	Mag Phase	
205	6.83	5.66	4.80 184.54	1.34 102.39	1.41 66.15	1.40 121.94	1.18 86.99	0.52 160.28	0.25 97.65	0.29 330.46	0.10 207.09	0.08 58.52	Mag Phase	
206	9.10	8.87	6.40 176.76	2.33 89.51	2.24 71.05	1.91 125.32	2.13 94.43	0.16 3.72	0.40 142.84	0.42 314.41	0.17 257.72	0.15 79.00	Mag Phase	
207	11.43	10.99	7.69 180.15	3.47 75.47	2.50 78.47	1.34 112.75	3.28 90.80	1.79 320.06	1.30 144.79	1.05 318.79	0.44 158.27	0.43 355.73	Mag Phase	
208	11.77	17.80	8.94 180.06	4.08 55.64	2.67 92.76	1.84 32.70	3.74 120.42	4.79 352.26	3.22 179.68	2.19 359.66	1.03 185.94	0.68 6.73	Mag Phase	
209	9.59	9.13	6.85 179.91	2.60 81.81	2.31 70.43	1.84 125.59	2.16 91.94	0.26 5.66	0.41 124.56	0.44 308.02	0.17 264.16	0.17 65.49	Mag Phase	

Table III. - Continued

(u) Concluded

$\mu_{Nom} = 0.20$

Run 7

POINT	MEAN	1/2P-P	1P	2P	3P	4P	5P	6P	7P	8P	9P	10P	
210	7.60	5.73	5.10 190.07	1.27 82.96	1.26 70.99	1.48 128.80	1.29 99.47	0.29 163.92	0.26 124.57	0.25 353.08	0.11 244.98	0.09 84.86	Mag Phase

Table III. - Continued

(v) Pitch link load, blade 4, lbs

Run 7

$\mu_{Nom} = 0.06$

POINT	MEAN	1/2P-P	1P	2P	3P	4P	5P	6P	7P	8P	9P	10P	
126	-3.42	6.76	3.28 37.75	1.91 255.33	1.59 202.54	0.18 215.89	1.49 26.19	1.38 12.09	0.65 180.66	0.41 300.31	0.18 183.58	0.19 53.66	Mag Phase

$\mu_{Nom} = 0.07$

POINT	MEAN	1/2P-P	1P	2P	3P	4P	5P	6P	7P	8P	9P	10P	
127	-0.38	7.79	3.23 37.66	3.17 261.70	0.82 226.73	0.36 177.97	1.45 26.20	1.56 19.04	0.86 202.64	0.52 329.18	0.06 107.04	0.23 94.27	Mag Phase

$\mu_{Nom} = 0.08$

POINT	MEAN	1/2P-P	1P	2P	3P	4P	5P	6P	7P	8P	9P	10P	
128	2.98	9.35	3.52 74.25	5.04 260.43	0.49 280.08	0.74 111.26	1.51 357.00	1.60 3.41	0.79 199.38	0.25 353.59	0.13 335.13	0.19 353.78	Mag Phase
128A	8.91	12.74	6.92 59.76	5.72 255.44	1.15 353.72	1.23 155.53	1.80 313.83	0.69 7.08	0.40 262.74	0.40 289.77	0.21 273.57	0.12 327.47	Mag Phase

$\mu_{Nom} = 0.09$

POINT	MEAN	1/2P-P	1P	2P	3P	4P	5P	6P	7P	8P	9P	10P	
129	8.95	13.33	7.76 69.48	6.79 254.52	1.35 11.07	1.27 175.87	1.47 323.77	0.51 43.86	0.37 260.53	0.90 295.05	0.33 302.75	0.05 322.32	Mag Phase
130	-0.82	6.00	2.76 14.44	2.84 272.55	0.38 247.08	0.38 100.72	1.25 25.50	0.48 343.21	0.50 209.72	0.17 317.70	0.17 183.58	0.04 66.30	Mag Phase

Table III. - Continued

(v) Continued

Run 7

 $\mu_{\text{Nom}} = 0.09$ 

POINT	MEAN	1/2P-P	1P	2P	3P	4P	5P	6P	7P	8P	9P	10P	
131	4.45	10.45	7.46 17.49	3.41 273.30	0.87 31.86	0.32 134.54	1.16 25.19	0.62 354.79	0.49 196.34	0.23 325.95	0.18 136.55	0.13 18.33	Mag Phase
132	5.96	10.86	5.51 36.38	5.80 275.10	0.95 345.61	0.86 40.09	1.16 12.70	0.87 351.90	0.83 192.34	0.17 353.21	0.10 132.16	0.19 353.13	Mag Phase
133	7.77	11.66	6.40 59.25	5.56 256.74	1.33 15.90	0.82 152.01	1.26 310.26	0.39 48.19	0.44 244.35	0.29 324.32	0.13 258.32	0.19 17.61	Mag Phase
134	1.26	7.68	4.74 17.11	2.74 263.19	0.46 308.76	0.18 63.00	1.51 34.07	0.41 1.95	0.53 222.68	0.25 335.17	0.15 150.91	0.01 212.25	Mag Phase
135	-1.26	5.33	2.56 16.21	2.61 269.74	0.54 258.68	0.38 98.90	1.03 60.51	0.33 31.05	0.34 267.75	0.35 8.79	0.02 166.51	0.12 310.43	Mag Phase
136	3.78	10.24	7.50 20.24	3.30 272.70	0.87 41.55	0.45 106.66	1.07 41.98	0.57 0.11	0.31 213.28	0.33 350.37	0.05 136.52	0.13 1.02	Mag Phase
137	4.89	9.57	4.82 38.50	5.14 274.29	0.92 339.12	0.90 52.57	0.88 5.43	0.58 11.67	0.60 213.38	0.17 324.58	0.11 171.73	0.12 294.20	Mag Phase
138	7.65	10.83	6.38 59.07	5.03 256.26	1.02 27.26	0.87 136.35	1.18 305.23	0.16 246.46	0.01 121.50	0.23 288.77	0.12 247.53	0.11 335.54	Mag Phase
139	5.04	9.96	7.01 25.75	3.17 274.90	1.12 48.08	0.63 114.77	1.06 48.10	0.72 351.83	0.30 220.91	0.26 352.46	0.05 66.18	0.17 335.08	Mag Phase
140	0.64	6.37	3.35 25.67	2.72 275.72	0.07 162.69	0.58 96.30	1.25 56.30	0.47 12.13	0.27 260.48	0.32 20.15	0.09 238.01	0.17 327.93	Mag Phase

Table III. - Continued

(v) Continued

Run 7

 $\mu_{\text{Nom}} = 0.09$ 

POINT	MEAN	1/2P-P	1P	2P	3P	4P	5P	6P	7P	8P	9P	10P	
141	-1.14	6.18	2.33 6.66	2.99 282.68	0.37 281.64	0.25 149.41	1.33 47.26	0.91 10.11	0.57 218.56	0.41 331.11	0.17 180.81	0.00 155.77	Mag Phase
142	4.52	11.41	7.64 17.62	3.59 279.01	1.18 13.27	0.69 153.27	1.52 26.86	1.18 352.41	0.56 196.00	0.35 324.71	0.17 157.00	0.12 358.02	Mag Phase
143	6.35	11.93	5.91 33.81	6.01 276.09	1.04 339.60	0.62 47.08	1.44 13.69	1.36 1.05	1.02 209.78	0.47 338.06	0.14 168.48	0.09 11.74	Mag Phase
144	7.55	12.30	6.50 59.65	5.85 261.60	1.46 7.34	1.23 182.72	2.18 312.64	0.67 50.17	0.48 245.71	0.70 307.69	0.20 287.44	0.04 288.98	Mag Phase
145	5.33	11.70	7.84 20.24	3.42 275.64	1.26 16.66	0.89 142.86	1.59 20.69	1.11 341.10	0.54 175.49	0.30 326.08	0.14 131.01	0.15 334.00	Mag Phase
146	-0.70	6.27	2.90 15.11	3.03 278.45	0.53 305.03	0.27 150.08	1.23 49.70	0.78 6.62	0.53 226.70	0.36 344.90	0.19 185.83	0.05 289.67	Mag Phase

 $\mu_{\text{Nom}} = 0.13$ 

POINT	MEAN	1/2P-P	1P	2P	3P	4P	5P	6P	7P	8P	9P	10P	
147	-3.69	4.39	1.27 36.58	2.45 275.28	0.33 349.29	1.04 105.90	0.40 51.99	0.75 329.63	0.15 227.43	0.14 124.60	0.13 276.17	0.22 311.61	Mag Phase
148	-2.75	4.54	0.86 247.76	3.42 294.78	0.72 317.47	0.63 130.18	0.47 56.95	0.63 354.63	0.44 220.67	0.37 358.16	0.14 213.20	0.20 280.55	Mag Phase
149	3.43	8.26	3.97 36.98	4.21 285.89	0.99 349.27	0.88 128.92	0.62 25.68	0.86 346.91	0.55 221.72	0.45 344.18	0.16 245.65	0.11 305.25	Mag Phase

Table III. - Continued

(v) Continued

Run 7

 $\mu_{\text{Nom}} = 0.13$ 

POINT	MEAN	1/2P-P	1P	2P	3P	4P	5P	6P	7P	8P	9P	10P	
150	7.09	11.94	5.70 50.32	5.83 289.57	2.00 9.46	1.43 108.93	1.11 356.28	0.91 24.39	1.20 243.21	0.83 335.54	0.24 230.82	0.19 293.34	Mag Phase
151	8.62	12.98	6.71 59.94	5.55 272.63	1.58 6.76	1.60 133.63	1.82 3.49	0.42 47.35	0.94 236.23	1.21 336.72	0.22 286.82	0.32 261.51	Mag Phase
152	5.46	10.04	6.12 34.14	3.45 276.27	1.22 39.04	1.40 159.11	0.70 67.46	0.88 347.44	0.55 202.46	0.48 345.34	0.12 236.31	0.20 326.03	Mag Phase
153	0.47	4.78	0.99 326.07	3.13 291.23	0.74 308.08	0.59 145.41	0.49 80.89	0.61 359.22	0.41 223.17	0.36 13.03	0.19 210.69	0.18 286.63	Mag Phase
154	-3.39	2.97	1.35 305.54	1.81 271.05	0.35 255.23	0.44 181.85	0.33 87.07	0.32 47.00	0.09 144.88	0.12 59.44	0.11 234.36	0.10 328.65	Mag Phase
155	-2.49	4.52	1.23 330.33	2.96 290.68	0.26 306.77	0.71 172.41	0.82 64.79	0.34 33.29	0.42 225.88	0.36 12.10	0.14 227.55	0.19 295.91	Mag Phase
156	1.36	6.53	2.19 38.94	3.57 286.90	0.48 343.53	1.12 128.80	1.21 30.31	0.44 345.28	0.59 208.26	0.47 340.95	0.19 264.97	0.31 278.05	Mag Phase
157	6.46	11.12	5.03 54.48	6.13 293.13	1.45 4.62	1.51 116.73	1.10 22.12	0.74 55.78	0.97 228.39	0.70 356.83	0.11 225.04	0.15 298.87	Mag Phase
158	7.70	12.12	5.63 67.88	6.11 279.49	1.43 350.77	1.64 130.15	2.01 4.69	0.39 50.96	0.80 227.21	0.88 341.99	0.10 285.11	0.21 253.41	Mag Phase
159	4.37	9.87	5.85 34.46	3.75 280.47	0.98 47.43	1.23 158.36	0.91 64.49	0.55 9.01	0.57 214.45	0.41 354.26	0.19 244.39	0.13 320.07	Mag Phase

Table III. - Continued

(v) Continued

Run 7

 $\mu_{\text{Nom}} = 0.13$ 

POINT	MEAN	1/2P-P	1P	2P	3P	4P	5P	6P	7P	8P	9P	10P	
160	0.51	5.93	2.26 26.04	2.96 272.80	0.51 307.74	0.81 162.46	0.79 53.68	0.51 14.87	0.43 217.91	0.27 7.76	0.15 226.26	0.16 288.38	Mag Phase
161	-5.64	2.72	0.80 163.91	1.94 264.44	0.29 39.54	0.52 131.93	0.23 67.37	0.33 54.77	0.12 133.93	0.13 354.21	0.11 303.87	0.08 300.19	Mag Phase
162	-4.05	4.65	1.70 246.93	3.11 287.50	0.33 267.27	0.55 169.31	0.68 45.53	0.28 72.62	0.36 225.55	0.28 0.74	0.12 227.88	0.15 287.37	Mag Phase
163	3.22	9.10	5.50 33.11	3.93 282.90	0.81 55.29	0.86 129.51	0.80 43.65	0.28 359.07	0.45 214.97	0.30 342.27	0.16 241.55	0.13 280.48	Mag Phase
164	6.20	10.66	5.10 54.34	5.98 285.30	1.40 344.42	1.44 92.24	1.05 10.30	0.65 30.83	0.73 217.23	0.45 335.59	0.11 241.14	0.14 254.52	Mag Phase
165	7.46	11.41	5.66 65.38	5.45 271.14	0.80 351.79	1.36 136.81	1.72 4.07	0.30 35.64	0.49 239.41	0.60 335.83	0.16 257.96	0.24 258.89	Mag Phase
166	4.04	9.23	5.60 39.77	3.90 285.25	0.94 73.84	0.99 148.54	0.70 65.79	0.35 9.94	0.41 232.46	0.27 354.71	0.23 267.02	0.10 308.67	Mag Phase
167	1.05	5.21	2.53 44.09	2.20 267.20	0.14 19.96	0.74 161.08	0.63 55.58	0.37 47.25	0.20 223.78	0.26 349.59	0.18 242.91	0.16 281.33	Mag Phase

Table III. - Continued

(v) Continued

Run 7

 $\mu_{\text{Nom}} = 0.16$ 

POINT	MEAN	1/2P-P	1P	2P	3P	4P	5P	6P	7P	8P	9P	10P	
168	-5.82	3.27	0.96 232.51	1.85 271.24	0.11 134.50	0.59 161.78	0.10 134.61	0.53 63.40	0.13 158.21	0.18 15.07	0.03 319.09	0.11 293.63	Mag Phase
169	-4.00	3.64	0.73 248.10	2.81 295.39	0.20 327.48	0.71 153.87	0.42 69.60	0.46 49.31	0.35 225.76	0.41 357.95	0.07 215.81	0.23 293.82	Mag Phase
170	3.16	8.54	4.99 45.15	3.87 282.36	0.39 133.59	1.06 162.37	0.52 79.37	0.29 32.24	0.51 222.72	0.42 332.45	0.15 282.17	0.18 271.48	Mag Phase
171	5.80	9.74	4.43 73.37	5.70 297.74	0.93 333.64	1.96 127.64	0.91 28.40	0.71 66.54	0.82 215.51	0.74 341.49	0.12 180.46	0.31 273.40	Mag Phase
172	7.31	11.18	5.25 77.42	5.76 266.63	0.24 320.23	1.92 158.29	1.66 27.72	0.42 18.10	0.68 223.15	0.94 334.29	0.09 245.12	0.41 268.04	Mag Phase
173	3.81	8.91	4.81 48.63	4.27 281.03	0.75 130.81	1.19 158.76	0.48 88.79	0.33 40.10	0.48 224.28	0.35 333.18	0.11 267.16	0.20 262.13	Mag Phase
174	-6.14	3.41	1.17 201.83	1.90 279.13	0.21 109.97	0.53 179.31	0.27 45.51	0.52 65.81	0.13 194.43	0.25 18.95	0.01 47.87	0.16 318.02	Mag Phase
175	-5.41	3.22	0.67 216.06	1.91 280.61	0.36 20.47	0.65 162.41	0.12 157.34	0.75 47.62	0.23 171.26	0.31 0.41	0.05 11.96	0.16 292.81	Mag Phase
176	-3.16	4.35	0.80 265.31	3.39 302.83	0.76 329.63	0.76 164.86	0.48 119.78	0.62 34.00	0.46 222.96	0.48 6.49	0.11 200.97	0.21 300.41	Mag Phase
177	3.39	8.86	4.69 44.33	3.95 287.77	0.35 31.14	1.33 158.64	0.72 95.57	0.66 11.20	0.73 226.11	0.57 2.29	0.06 283.23	0.20 292.17	Mag Phase



Table III. - Continued

Run 7													
(v) Continued													
$\mu_{\text{Nom}} = 0.16$													
POINT	MEAN	1/2P-P	1P	2P	3P	4P	5P	6P	7P	8P	9P	10P	
178	6.65	10.90	4.61 70.28	6.24 293.16	1.18 348.69	2.08 131.94	0.96 40.61	0.73 76.96	1.22 230.14	1.02 0.83	0.05 343.92	0.24 257.31	Mag Phase
179	8.13	12.37	4.85 74.94	7.24 247.71	0.30 219.65	2.38 173.99	1.35 21.51	0.12 23.83	0.93 216.04	1.14 334.18	0.08 355.82	0.35 249.68	Mag Phase
180	4.06	9.12	4.77 44.57	4.37 280.64	0.58 105.33	1.41 154.41	0.63 106.63	0.60 23.89	0.62 205.77	0.60 347.98	0.05 305.97	0.15 262.43	Mag Phase
181	-5.25	3.01	0.87 229.87	1.87 283.68	0.12 2.91	0.53 160.19	0.16 144.77	0.59 37.86	0.22 166.78	0.22 358.70	0.03 297.35	0.15 285.95	Mag Phase
182	-4.69	3.34	0.41 254.02	1.85 285.29	0.71 359.47	0.51 123.37	0.21 146.54	0.84 15.89	0.20 115.31	0.18 346.63	0.06 328.29	0.10 257.80	Mag Phase
183	-2.73	5.33	1.24 253.03	3.46 306.51	1.07 329.97	0.67 141.47	0.33 137.70	0.90 3.19	0.23 225.51	0.39 9.00	0.06 216.11	0.20 274.47	Mag Phase
184	4.63	9.51	5.27 37.90	4.05 279.90	0.44 44.89	1.44 138.58	0.27 133.05	0.78 340.09	0.70 211.85	0.55 343.43	0.05 251.95	0.15 250.82	Mag Phase
185	7.82	11.81	5.10 66.52	6.65 292.37	0.87 17.10	2.55 126.35	0.64 338.02	0.53 59.85	1.18 228.61	0.92 1.50	0.04 286.86	0.31 262.80	Mag Phase
186	8.62	13.55	5.55 73.65	7.11 253.16	0.49 306.37	2.24 157.58	1.43 4.44	0.29 32.93	1.15 210.78	1.10 339.64	0.10 19.68	0.43 254.16	Mag Phase
187	4.67	9.27	4.89 42.98	4.43 280.75	0.59 47.85	1.52 146.66	0.39 159.82	0.70 349.69	0.66 220.11	0.52 348.23	0.06 279.10	0.16 251.93	Mag Phase
188	-4.23	3.45	0.10 129.70	2.21 299.31	0.80 10.51	0.41 126.84	0.15 183.75	0.73 23.71	0.18 142.39	0.15 358.98	0.08 326.14	0.12 270.24	Mag Phase

Table III. - Continued

(v) Continued

Run 7

 $\mu_{\text{Nom}} = 0.20$ 

POINT	MEAN	1/2P-P	1P	2P	3P	4P	5P	6P	7P	8P	9P	10P	
189	-4.78	3.36	0.97 231.77	1.97 306.61	0.47 48.05	0.38 156.02	0.27 215.45	0.73 37.17	0.14 206.13	0.22 4.52	0.08 270.28	0.23 307.59	Mag Phase
190	-3.01	5.91	2.46 234.92	3.54 310.80	1.36 317.52	0.68 187.35	0.95 182.59	0.61 57.87	0.34 236.48	0.37 20.45	0.05 251.80	0.22 327.39	Mag Phase
191	3.48	8.96	3.38 54.08	4.69 285.55	1.11 245.65	1.96 177.87	1.24 191.61	0.85 22.98	0.81 225.82	0.48 3.22	0.12 126.11	0.35 297.10	Mag Phase
192	4.41	8.84	2.87 84.18	5.42 294.79	0.70 244.94	2.57 160.16	0.56 196.66	0.83 42.30	1.03 224.17	0.87 5.11	0.16 138.84	0.41 289.64	Mag Phase
193	6.57	11.93	4.04 99.27	6.77 278.84	0.93 242.98	3.86 146.45	0.59 20.90	0.65 61.09	1.48 218.83	1.25 342.68	0.05 119.30	0.40 274.81	Mag Phase
194	7.26	13.59	4.36 98.68	7.54 264.83	1.58 256.29	3.79 149.99	1.12 35.69	0.84 88.92	1.75 225.53	1.23 346.08	0.09 300.46	0.38 277.94	Mag Phase
195	3.71	8.90	2.90 63.18	5.17 285.35	1.24 218.30	2.09 179.15	1.14 201.18	0.72 35.35	0.71 232.38	0.62 13.98	0.11 112.91	0.39 294.23	Mag Phase
196	-4.16	3.68	0.73 193.17	2.30 306.03	0.53 42.38	0.38 172.00	0.34 235.22	0.64 49.85	0.17 191.80	0.22 2.87	0.04 289.11	0.22 310.37	Mag Phase
197	-6.10	4.34	1.84 225.31	2.12 289.53	0.07 57.27	0.71 203.47	0.36 237.85	0.70 56.00	0.14 164.23	0.25 28.93	0.04 132.09	0.19 307.08	Mag Phase
198	-4.03	6.12	3.04 239.25	3.52 298.12	1.21 286.67	0.80 200.82	0.75 172.93	0.67 54.78	0.26 217.81	0.46 29.12	0.14 144.34	0.15 299.68	Mag Phase

Table III. - Continued

(v) Continued

$\mu_{Nom} = 0.20$

Run 7	POINT	MEAN	1/2P-P	1P	2P	3P	4P	5P	6P	7P	8P	9P	10P	
	199	2.91	9.21	3.44 54.65	4.66 285.51	1.84 229.96	1.79 197.94	1.17 182.23	0.54 65.26	0.60 229.47	0.50 24.39	0.08 109.81	0.26 319.69	Mag Phase
	200	5.49	10.53	3.25 95.29	6.21 278.06	1.60 255.41	3.43 159.37	0.15 24.84	0.48 87.36	1.15 211.68	0.95 349.55	0.09 142.09	0.38 277.21	Mag Phase
	201	6.05	13.16	3.54 105.79	10.02 237.09	2.49 204.06	3.07 200.43	0.63 347.92	1.12 14.29	0.99 226.82	1.18 346.53	0.23 94.87	0.42 256.87	Mag Phase
	202	3.23	8.92	2.74 58.78	5.02 283.00	1.68 208.04	1.76 188.27	1.11 182.25	0.63 62.33	0.59 228.60	0.52 5.24	0.07 69.51	0.30 299.18	Mag Phase
	203	-6.10	4.24	1.76 229.72	2.31 294.38	0.01 69.81	0.65 207.44	0.31 237.07	0.67 59.04	0.16 183.73	0.23 36.18	0.06 194.66	0.19 313.19	Mag Phase
	204	-7.43	5.40	2.62 229.77	2.11 275.38	0.47 175.70	0.74 197.22	0.11 209.13	0.66 67.85	0.12 116.69	0.22 32.94	0.03 26.67	0.15 329.71	Mag Phase
	205	-5.25	6.26	3.45 241.41	3.31 289.99	1.14 258.01	0.78 207.67	0.41 135.03	0.55 53.85	0.17 217.69	0.34 19.63	0.08 185.21	0.11 315.12	Mag Phase
	206	1.37	8.07	2.85 69.62	4.04 288.46	1.61 214.18	1.38 184.67	0.85 128.59	0.53 93.92	0.40 235.92	0.55 5.72	0.07 160.24	0.17 299.97	Mag Phase
	207	4.82	10.14	3.59 92.33	5.81 278.94	1.76 250.11	3.08 156.50	0.70 79.35	0.74 64.35	0.80 204.66	0.72 348.68	0.06 350.91	0.40 277.85	Mag Phase
	208	5.47	12.29	3.25 96.33	9.23 241.01	3.03 211.34	3.21 205.31	0.43 347.81	1.37 9.53	0.49 214.54	0.85 358.72	0.24 131.23	0.39 279.39	Mag Phase
	209	2.30	8.50	2.66 66.46	4.54 281.39	2.08 190.25	1.63 174.30	0.70 124.73	0.46 85.30	0.29 238.83	0.64 347.62	0.08 129.30	0.20 288.10	Mag Phase

Table III. - Concluded

(v) Concluded

$\mu_{Nom} = 0.20$

Run 7

POINT	MEAN	1/2P-P	1P	2P	3P	4P	5P	6P	7P	8P	9P	10P	Mag Phase
210	-1.87	4.55	0.25 358.96	3.21 275.13	0.66 252.60	1.10 200.70	0.43 123.74	0.59 60.16	0.16 170.82	0.33 17.07	0.07 179.37	0.17 304.25	

Table IV. – Rotor Performance, Control Positions, Blade Loads, Fixed System Loads,  
and Pitch Link Loads at  $\mu = 0.25$

(a) Rotor performance and control positions

Run 8

$\mu_{Nom} = 0.25$

POINT	$\alpha_s$	$B_1$	$A_1$	$\theta$	$\mu$	$C_L$	$C_D$	$C_Q$
214	0.0	2.3	1.2	2.0	0.251	0.00216	0.00004	0.00012
215	0.0	3.4	1.6	4.0	0.253	0.00377	0.00002	0.00017
216	0.1	4.7	2.1	6.0	0.254	0.00528	-0.00001	0.00027
217	0.1	5.3	2.2	7.0	0.252	0.00591	-0.00003	0.00035
218	0.0	5.5	2.4	7.5	0.253	0.00614	-0.00006	0.00039
219	0.0	4.7	2.0	6.0	0.252	0.00528	-0.00002	0.00027
220	0.0	3.5	1.6	4.0	0.251	0.00378	0.00002	0.00017
221	-2.0	2.1	1.1	2.0	0.253	0.00150	0.00000	0.00013
222	-2.0	3.2	1.7	4.0	0.253	0.00308	-0.00008	0.00018
223	-2.0	4.4	2.0	6.0	0.254	0.00468	-0.00017	0.00027
224	-2.0	5.0	2.3	7.0	0.253	0.00533	-0.00022	0.00034
225	-2.0	5.5	2.5	8.0	0.252	0.00591	-0.00026	0.00043
226	-2.0	5.9	2.7	8.5	0.252	0.00611	-0.00029	0.00048
227	-2.0	4.4	2.0	6.0	0.252	0.00469	-0.00017	0.00027
228	-2.0	3.2	1.6	4.0	0.252	0.00310	-0.00009	0.00018
229	-4.0	3.0	1.6	4.0	0.252	0.00246	-0.00015	0.00018
230	-4.0	4.0	2.1	6.0	0.252	0.00404	-0.00028	0.00027
231	-4.0	4.7	2.3	7.0	0.252	0.00476	-0.00035	0.00034
232	-4.0	5.3	2.5	8.0	0.252	0.00538	-0.00041	0.00042
233	-4.0	5.5	2.7	8.5	0.252	0.00565	-0.00044	0.00047
234	-4.0	4.1	2.0	6.0	0.251	0.00403	-0.00028	0.00027
235	-6.0	2.7	1.5	4.0	0.251	0.00184	-0.00016	0.00018
236	-6.0	3.8	2.0	6.0	0.251	0.00337	-0.00035	0.00027
237	-6.0	4.4	2.2	7.0	0.251	0.00416	-0.00044	0.00033
238	-6.0	5.0	2.4	8.0	0.252	0.00485	-0.00053	0.00041
239	-6.0	5.3	2.6	8.5	0.251	0.00518	-0.00058	0.00046
240	-6.0	5.6	2.7	9.0	0.253	0.00544	-0.00061	0.00051
241	-6.0	6.0	2.7	9.5	0.254	0.00567	-0.00066	0.00056
242	-6.0	5.0	2.4	8.0	0.252	0.00484	-0.00053	0.00041
243	-6.0	3.9	2.0	6.0	0.252	0.00335	-0.00034	0.00027

Table IV. - Continued

(b) Blade flapwise bending moment, in-lbs, 23.00 percent radius

Run 8

$\mu_{Nom} = 0.25$

POINT	MEAN	1/2P-P	1P	2P	3P	4P	5P	6P	7P	8P	9P	10P	
214	49.17	4.81	1.57 63.87	0.85 223.44	2.31 333.33	0.93 331.91	1.69 141.33	1.04 350.03	0.85 293.59	0.25 20.70	0.20 318.96	0.03 174.41	Mag Phase
215	53.01	8.42	1.74 67.13	2.01 190.56	4.56 329.80	1.12 241.22	1.26 321.57	0.76 303.21	0.55 343.56	2.26 297.74	0.48 258.37	0.12 81.86	Mag Phase
216	56.54	13.51	1.91 43.32	2.28 147.45	6.25 314.26	2.33 226.23	2.24 335.13	0.82 305.37	1.28 8.36	4.91 298.86	0.93 273.01	0.28 74.66	Mag Phase
217	58.17	18.33	2.51 30.39	3.15 94.87	7.44 293.99	4.11 220.80	4.90 338.46	1.35 309.94	1.95 342.61	6.29 294.81	0.94 262.54	0.55 58.51	Mag Phase
218	58.60	19.86	2.68 27.04	3.83 80.86	7.58 288.42	4.78 224.55	5.85 334.61	1.44 311.08	2.11 331.45	7.23 295.69	1.12 251.19	0.61 59.40	Mag Phase
219	56.42	14.12	2.13 38.00	2.43 141.79	6.37 310.30	2.53 218.67	2.89 338.20	0.96 302.46	1.36 1.39	4.71 289.94	0.75 263.40	0.42 57.32	Mag Phase
220	52.19	7.87	1.75 65.34	1.96 193.14	4.43 334.13	0.97 243.68	1.14 330.07	0.79 318.15	0.79 351.18	2.00 302.58	0.41 273.74	0.18 106.87	Mag Phase
221	48.14	3.78	1.78 47.80	0.44 269.27	1.67 318.64	0.63 353.18	0.73 150.54	0.87 337.02	0.68 281.41	0.78 86.40	0.23 359.09	0.03 243.60	Mag Phase
222	52.05	6.32	1.87 47.75	1.26 193.84	3.73 324.85	0.51 245.56	1.00 296.46	1.08 318.86	0.64 305.25	0.99 351.69	0.26 323.93	0.18 92.47	Mag Phase
223	55.75	11.78	2.11 35.81	2.43 152.32	6.02 322.58	2.31 232.51	2.74 359.12	1.54 321.10	0.92 318.65	2.57 338.61	0.55 299.46	0.34 102.48	Mag Phase

Table IV. - Continued

(b) Continued

Run 8

 $\mu_{\text{Nom}} = 0.25$ 

POINT	MEAN	1/2P-P	1P	2P	3P	4P	5P	6P	7P	8P	9P	10P	
224	57.49	14.75	2.50 26.37	2.76 106.72	6.38 300.23	3.70 216.75	4.38 345.09	1.72 310.00	1.13 308.08	4.06 308.31	0.71 252.43	0.43 81.95	Mag Phase
225	58.81	18.23	2.92 19.70	3.75 72.66	7.10 284.49	5.32 212.59	6.06 316.67	1.46 308.43	1.27 290.88	6.59 308.84	0.86 255.59	0.43 43.63	Mag Phase
226	59.24	17.64	3.38 18.05	4.08 70.31	7.19 283.29	4.55 210.03	6.16 293.40	1.05 306.52	1.29 308.14	6.35 316.35	0.89 288.13	0.44 26.98	Mag Phase
227	55.71	11.43	2.10 32.83	2.38 152.13	5.90 319.76	2.28 226.65	2.70 0.88	1.66 322.43	1.11 321.24	2.25 328.27	0.49 286.65	0.35 97.90	Mag Phase
228	52.00	6.12	1.90 45.47	1.36 188.74	3.68 321.52	0.36 258.40	0.81 283.49	1.09 320.51	0.81 297.67	0.83 356.76	0.23 327.27	0.18 72.82	Mag Phase
229	51.13	5.88	2.04 38.14	1.27 183.90	3.19 324.93	0.03 150.51	0.92 234.42	0.63 332.22	0.63 293.57	0.97 48.74	0.30 327.29	0.12 246.29	Mag Phase
230	54.91	9.37	2.23 27.88	2.14 155.88	5.25 320.38	1.54 223.95	0.85 353.57	1.18 304.95	0.70 260.69	1.40 5.04	0.45 298.40	0.06 207.91	Mag Phase
231	56.71	11.01	2.59 21.85	2.44 129.42	5.73 311.68	2.61 212.63	2.11 356.21	1.37 304.27	0.89 257.56	1.92 338.52	0.55 290.28	0.02 9.36	Mag Phase
232	58.50	12.56	3.26 16.50	2.98 85.79	6.15 291.55	4.01 207.62	3.31 343.30	1.42 306.72	1.31 256.04	2.78 331.26	0.64 273.51	0.11 236.46	Mag Phase
233	59.11	13.43	3.59 11.02	3.59 65.73	6.69 277.84	4.48 197.26	3.19 306.00	0.96 289.48	1.24 228.95	3.60 315.98	0.77 263.06	0.19 241.78	Mag Phase

Table IV. - Continued

(b) Concluded

Run 8

$\mu_{Nom} = 0.25$

POINT	MEAN	1/2P-P	1P	2P	3P	4P	5P	6P	7P	8P	9P	10P	
234	54.80	9.37	2.28 27.25	2.07 151.82	5.15 316.57	1.57 219.66	0.93 341.18	1.16 297.89	0.76 257.89	1.58 359.04	0.42 285.39	0.06 196.49	Mag Phase
235	50.04	6.21	2.16 27.31	1.37 174.34	2.90 318.72	0.53 57.54	1.52 223.46	0.32 322.22	0.44 283.89	0.62 37.17	0.21 330.58	0.11 245.12	Mag Phase
236	53.80	8.14	2.44 28.04	2.22 155.72	4.68 322.75	0.76 208.84	1.01 294.47	0.65 294.60	0.50 297.32	0.70 358.51	0.24 294.26	0.07 275.35	Mag Phase
237	55.83	10.08	2.70 21.01	2.66 136.41	5.37 309.56	1.74 196.93	1.47 324.91	0.71 276.80	0.41 267.92	0.92 319.82	0.30 260.87	0.04 276.86	Mag Phase
238	57.67	10.77	3.20 17.65	2.93 117.28	5.61 303.64	2.73 200.60	2.09 349.86	0.77 296.35	0.72 270.30	1.35 318.75	0.38 280.91	0.07 303.66	Mag Phase
239	58.66	10.33	3.57 14.72	3.09 92.91	5.73 289.40	3.29 194.72	2.17 339.03	0.55 309.15	0.73 275.84	1.63 326.69	0.36 280.97	0.13 256.90	Mag Phase
240	59.30	11.79	3.90 12.28	3.61 71.65	6.13 279.34	3.91 190.53	2.49 317.72	0.30 339.11	0.48 261.48	2.45 318.87	0.43 293.63	0.27 255.60	Mag Phase
241	59.72	14.40	4.24 11.90	4.09 65.10	6.33 282.23	3.51 190.27	3.07 265.05	0.79 127.75	0.36 152.23	2.91 337.02	0.58 316.29	0.24 271.20	Mag Phase
242	57.53	10.10	3.23 16.27	2.89 116.08	5.58 300.83	2.55 197.75	1.81 350.40	0.75 296.90	0.71 272.23	0.95 318.26	0.37 273.11	0.09 257.66	Mag Phase
243	53.68	8.46	2.49 27.19	2.29 153.65	4.61 317.73	0.76 202.99	1.04 281.10	0.65 288.70	0.55 278.50	1.10 338.19	0.30 283.68	0.08 231.83	Mag Phase



Table IV. - Continued

(c) Blade chordwise bending moment, in-lbs, 30.00 percent radius

Run 8

$\mu_{Nom} = 0.25$

POINT	MEAN	1/2P-P	1P	2P	3P	4P	5P	6P	7P	8P	9P	10P	
214	-32.55	7.72	4.13 267.61	1.94 71.51	1.72 198.51	0.68 51.20	3.22 359.64	0.60 260.55	0.44 299.49	0.17 241.54	0.09 164.49	0.05 144.55	Mag Phase
215	-31.57	17.48	8.76 303.74	4.87 81.01	2.92 195.12	1.90 342.18	5.80 49.50	2.31 153.68	0.21 301.37	0.58 105.77	0.25 85.70	0.08 89.68	Mag Phase
216	-27.86	35.39	21.45 336.58	8.49 60.02	7.01 164.01	4.94 248.91	5.67 37.81	4.05 49.99	1.17 275.44	1.16 143.90	0.38 76.58	0.25 55.30	Mag Phase
217	-23.72	50.10	29.34 343.29	11.76 29.79	8.77 164.23	7.18 201.02	7.93 95.27	7.59 62.89	1.40 273.12	1.16 111.57	0.64 102.39	0.22 78.18	Mag Phase
218	-21.17	57.03	32.28 345.51	13.16 21.14	9.12 162.45	7.76 191.03	9.01 114.94	9.68 34.24	1.39 246.46	2.12 95.86	0.63 112.50	0.14 56.12	Mag Phase
219	-27.47	37.89	21.76 335.20	7.31 56.81	8.74 165.82	4.45 232.31	6.35 25.13	4.36 34.30	1.25 272.59	1.16 112.84	0.38 75.13	0.26 36.28	Mag Phase
220	-31.82	16.57	8.42 305.58	4.75 81.66	2.85 203.31	2.04 345.96	6.17 47.07	1.13 163.81	0.07 182.33	0.37 152.80	0.23 106.60	0.12 99.58	Mag Phase
221	-32.70	7.11	2.60 272.96	1.45 59.13	0.95 190.41	1.43 115.63	3.37 349.97	0.77 244.81	0.52 290.46	0.21 221.67	0.12 204.67	0.06 173.85	Mag Phase
222	-31.34	12.25	6.22 300.74	2.74 70.72	2.23 204.38	1.15 350.02	6.40 33.21	0.65 53.05	0.28 9.41	0.29 133.21	0.14 117.33	0.06 146.70	Mag Phase
223	-28.40	29.51	17.85 333.23	5.12 63.59	6.85 167.07	3.17 250.23	6.58 4.53	0.69 346.36	0.41 263.22	0.52 132.94	0.43 118.67	0.10 243.19	Mag Phase

Table IV. - Continued

(c) Continued

Run 8

$\mu_{Nom} = 0.25$

POINT	MEAN	1/2P-P	1P	2P	3P	4P	5P	6P	7P	8P	9P	10P	
224	-25.05	44.03	24.49 339.04	8.60 26.17	8.39 162.56	5.84 202.05	7.58 39.33	5.86 32.69	0.84 300.72	1.02 93.29	0.53 96.43	0.07 321.89	Mag Phase
225	-20.44	55.38	30.71 346.85	12.32 7.97	8.82 162.44	6.52 177.08	7.28 79.20	9.26 17.42	0.58 203.39	2.05 75.28	0.77 117.55	0.15 224.49	Mag Phase
226	-18.04	66.17	34.57 353.41	13.58 6.17	8.94 169.16	6.21 171.32	8.49 357.66	16.80 54.88	3.02 198.02	1.92 83.23	0.32 59.44	0.19 269.49	Mag Phase
227	-28.26	29.02	17.19 332.30	5.85 57.94	6.20 166.54	3.30 249.77	6.82 5.30	1.60 316.19	0.49 254.49	0.91 125.73	0.39 110.91	0.06 225.86	Mag Phase
228	-31.78	11.61	5.57 300.92	2.33 63.71	2.32 201.72	1.61 345.16	6.80 16.56	1.18 22.31	0.33 335.11	0.57 145.57	0.13 126.53	0.06 134.61	Mag Phase
229	-31.58	10.82	3.91 305.06	1.62 60.38	2.15 203.68	1.20 15.23	6.83 9.60	1.17 20.36	0.31 324.40	0.11 245.93	0.04 160.14	0.06 124.27	Mag Phase
230	-29.05	23.95	13.46 326.88	4.29 57.65	4.76 156.99	1.77 269.41	7.67 354.08	0.85 136.74	0.26 125.09	0.25 26.35	0.22 101.92	0.03 201.49	Mag Phase
231	-26.56	36.39	20.26 335.72	5.49 35.92	8.31 159.87	3.30 223.35	8.57 357.66	3.33 41.44	0.43 298.56	0.54 88.90	0.28 107.46	0.07 287.53	Mag Phase
232	-22.24	49.40	27.28 344.09	10.48 9.79	8.52 164.37	6.46 185.40	5.59 15.89	7.61 42.23	0.77 43.78	0.82 56.03	0.49 132.17	0.10 302.70	Mag Phase
233	-19.44	57.12	31.46 347.34	12.34 359.02	9.13 163.84	6.05 168.50	2.60 321.79	10.47 23.52	1.82 121.13	0.63 77.98	0.48 138.89	0.21 229.54	Mag Phase

Table IV. - Continued

(c) Concluded

Run 8

 $\mu_{\text{Nom}} = 0.25$ 

POINT	MEAN	1/2P-P	1P	2P	3P	4P	5P	6P	7P	8P	9P	10P	
234	-28.95	22.26	12.96 324.07	4.39 57.90	4.48 155.75	1.55 271.44	7.07 355.18	1.13 93.07	0.24 166.69	0.41 80.47	0.24 96.96	0.04 127.58	Mag Phase
235	-31.89	10.64	3.08 303.64	1.00 85.17	2.14 185.34	1.51 7.97	6.90 348.66	2.12 7.52	0.23 321.86	0.49 258.22	0.04 207.11	0.09 64.82	Mag Phase
236	-29.30	18.13	9.88 324.10	3.66 57.82	3.62 158.50	1.37 319.95	6.54 8.17	1.64 102.94	0.31 131.03	0.22 203.19	0.13 106.33	0.08 154.81	Mag Phase
237	-27.28	29.14	16.46 331.33	4.69 36.22	6.95 150.14	2.21 209.82	7.14 342.21	2.49 76.26	0.27 166.63	0.09 354.89	0.15 85.28	0.06 231.04	Mag Phase
238	-24.26	43.96	23.83 341.02	8.26 17.22	8.80 164.68	4.53 200.57	8.08 346.77	7.73 60.03	0.03 77.73	0.11 215.64	0.18 125.99	0.04 227.73	Mag Phase
239	-21.71	50.10	27.95 344.56	11.15 6.89	8.70 162.09	5.16 181.39	6.29 332.89	9.60 51.39	1.14 62.11	0.60 11.10	0.30 136.97	0.07 257.25	Mag Phase
240	-18.98	56.42	31.52 347.89	13.62 359.44	9.02 163.18	6.24 166.06	3.58 329.23	10.73 48.33	2.10 92.48	0.62 42.05	0.33 141.88	0.09 233.55	Mag Phase
241	-16.35	64.23	35.12 354.65	14.61 355.96	9.38 168.95	6.43 169.00	9.97 303.85	16.08 65.19	4.67 144.90	0.86 100.40	0.27 259.04	0.16 268.00	Mag Phase
242	-24.07	43.31	23.46 340.60	8.13 14.80	8.74 161.75	4.13 197.90	7.85 337.58	7.73 45.04	0.17 83.24	0.44 40.78	0.20 116.43	0.03 4.35	Mag Phase
243	-29.31	17.50	9.12 320.55	3.92 57.84	3.38 158.65	1.60 317.78	6.78 2.68	1.63 81.37	0.36 141.68	0.51 207.54	0.18 84.54	0.09 125.82	Mag Phase

Table IV. - Continued

(d) Blade torsional moment, in-lbs, 35.00 percent radius

Run 8

$\mu_{Nom} = 0.25$

POINT	MEAN	1/2P-P	1P	2P	3P	4P	5P	6P	7P	8P	9P	10P	
214	3.03	3.07	1.99 11.78	0.30 203.48	0.58 243.16	0.51 93.06	0.38 190.61	0.58 156.15	0.45 109.89	0.10 86.51	0.04 164.58	0.09 146.52	Mag Phase
215	5.33	4.58	2.61 21.10	1.75 133.66	0.79 339.72	1.08 148.42	0.53 121.25	0.60 115.68	0.40 86.85	0.27 93.45	0.11 85.79	0.13 137.83	Mag Phase
216	7.65	7.61	3.51 19.19	4.15 96.22	3.66 340.65	2.57 230.80	0.88 242.86	0.70 268.24	0.39 349.35	0.11 50.02	0.16 258.76	0.19 260.99	Mag Phase
217	8.75	16.96	4.66 11.03	6.72 65.34	7.87 322.80	5.83 231.71	0.88 261.58	1.50 251.56	0.75 317.06	0.28 216.74	0.43 242.71	0.42 259.30	Mag Phase
218	8.79	20.17	5.40 10.51	7.80 57.05	8.99 319.59	7.05 236.65	0.65 280.92	2.08 251.90	1.14 323.17	0.57 216.03	0.50 242.18	0.42 258.23	Mag Phase
219	7.84	8.22	3.56 16.94	4.36 92.72	4.03 333.92	2.83 223.70	0.81 242.15	0.75 246.93	0.41 332.84	0.05 60.13	0.16 243.68	0.20 235.90	Mag Phase
220	5.51	4.54	2.69 22.13	1.71 138.47	0.70 345.81	1.07 149.97	0.34 130.92	0.64 126.00	0.38 94.47	0.30 103.39	0.11 116.05	0.12 162.48	Mag Phase
221	2.33	3.39	2.04 12.05	0.59 351.30	1.42 261.60	0.66 135.81	0.13 243.86	0.42 159.59	0.36 121.20	0.10 113.72	0.05 157.17	0.08 158.69	Mag Phase
222	4.67	4.17	2.84 20.49	0.92 103.92	1.11 290.55	1.19 139.63	0.07 46.23	0.54 129.51	0.31 115.61	0.11 115.24	0.08 124.04	0.09 132.99	Mag Phase
223	7.09	7.17	3.63 19.60	3.56 98.46	3.22 334.39	2.07 209.27	0.48 285.43	0.42 196.34	0.13 317.57	0.11 259.29	0.04 269.98	0.04 235.31	Mag Phase

Table IV. - Continued

(d) Continued

Run 8

$\mu_{Nom} = 0.25$

POINT	MEAN	1/2P-P	1P	2P	3P	4P	5P	6P	7P	8P	9P	10P	
224	8.34	13.07	4.24 17.73	5.49 70.25	6.41 317.59	4.38 218.10	0.86 302.16	1.00 228.72	0.53 293.77	0.31 225.68	0.21 226.10	0.24 231.35	Mag Phase
225	8.69	19.68	5.42 15.07	7.54 49.21	9.29 309.53	6.85 225.76	1.75 339.16	2.06 242.16	1.73 317.08	0.63 217.83	0.31 257.31	0.31 248.11	Mag Phase
226	8.61	18.26	6.40 13.34	8.10 48.52	9.30 309.49	5.70 234.13	3.73 351.51	1.69 309.28	2.40 349.08	0.33 284.18	0.24 328.63	0.20 226.91	Mag Phase
227	7.29	7.14	3.71 18.48	3.49 97.28	3.11 332.46	1.92 204.32	0.59 280.65	0.46 180.57	0.12 326.79	0.09 260.38	0.05 254.31	0.06 221.66	Mag Phase
228	4.78	4.12	2.88 18.96	0.87 106.91	0.99 281.74	1.14 131.72	0.06 267.51	0.58 130.87	0.32 103.40	0.12 88.96	0.08 115.82	0.11 127.69	Mag Phase
229	3.90	4.05	2.85 19.46	0.59 88.25	1.29 276.08	1.08 125.71	0.36 312.61	0.39 145.72	0.27 127.93	0.09 180.56	0.05 167.33	0.06 142.17	Mag Phase
230	6.23	6.21	3.65 17.58	2.75 93.50	2.28 327.92	1.19 162.88	0.53 313.36	0.35 143.51	0.07 66.80	0.09 244.85	0.02 183.99	0.02 151.10	Mag Phase
231	7.55	8.08	4.05 18.60	4.22 80.23	3.91 319.47	2.13 192.57	0.94 303.12	0.55 185.08	0.06 265.29	0.20 239.50	0.10 216.58	0.09 215.10	Mag Phase
232	8.81	15.32	4.87 17.49	6.31 55.91	7.60 309.54	4.81 212.38	1.53 311.42	1.29 224.96	0.73 302.49	0.41 251.12	0.13 227.75	0.17 228.67	Mag Phase
233	8.90	18.08	5.49 11.54	7.45 42.03	9.11 299.00	5.77 210.99	2.75 302.41	1.82 243.59	1.85 308.58	0.35 246.96	0.18 269.24	0.16 175.39	Mag Phase

Table IV. - Continued

(d) Concluded

Run 8

$\mu_{Nom} = 0.25$

POINT	MEAN	1/2P-P	1P	2P	3P	4P	5P	6P	7P	8P	9P	10P	
234	6.29	6.23	3.63 16.61	2.77 90.84	2.33 322.95	1.32 162.57	0.44 316.28	0.38 144.67	0.10 56.52	0.07 223.37	0.02 232.53	0.02 167.60	Mag Phase
235	3.06	3.77	2.79 13.81	0.47 91.26	1.09 262.81	0.97 97.78	0.45 281.98	0.35 133.86	0.20 129.18	0.06 136.77	0.04 166.66	0.04 138.36	Mag Phase
236	5.33	5.31	3.45 19.14	2.25 103.01	1.67 327.00	0.91 140.65	0.30 316.33	0.38 123.70	0.17 120.42	0.04 126.30	0.00 17.21	0.04 143.77	Mag Phase
237	6.54	7.28	3.98 12.88	3.52 85.06	3.07 322.59	1.41 169.65	0.80 306.02	0.21 169.40	0.11 312.08	0.05 268.90	0.02 253.57	0.02 215.98	Mag Phase
238	7.90	9.51	4.48 15.50	4.84 74.45	4.98 317.73	2.48 206.96	1.40 297.11	0.62 237.52	0.26 281.99	0.15 268.40	0.12 238.06	0.11 223.27	Mag Phase
239	8.62	13.72	4.91 13.13	5.82 57.44	7.03 308.54	3.72 213.09	1.83 291.34	1.31 233.13	0.69 281.16	0.44 257.19	0.14 263.64	0.21 239.14	Mag Phase
240	8.89	17.40	5.37 9.76	7.00 42.97	8.79 302.05	4.92 215.30	2.50 287.86	2.06 244.38	1.48 291.85	0.54 266.99	0.22 277.66	0.16 218.34	Mag Phase
241	8.71	19.95	6.04 6.55	7.74 39.84	8.91 302.10	4.66 220.46	4.45 306.06	3.36 294.37	2.98 324.38	1.06 318.90	0.41 330.63	0.13 220.91	Mag Phase
242	7.99	9.57	4.50 14.65	4.82 72.34	4.90 315.22	2.39 204.75	1.45 286.57	0.73 228.98	0.30 268.16	0.24 267.36	0.14 224.10	0.13 221.76	Mag Phase
243	5.41	5.33	3.46 17.85	2.25 101.45	1.67 322.55	0.93 136.70	0.25 308.09	0.41 109.08	0.16 105.73	0.08 117.46	0.01 173.17	0.04 126.17	Mag Phase

Table IV. - Continued

(e) Blade flapwise bending moment, in-lbs, 37.00 percent radius

Run 8

$\mu_{Nom} = 0.25$

POINT	MEAN	1/2P-P	1P	2P	3P	4P	5P	6P	7P	8P	9P	10P	
214	-0.45	0.43	0.32 185.30	0.14 122.89	0.03 110.91	0.06 97.63	0.08 85.03	0.04 228.66	0.04 42.17	0.05 71.98	0.01 252.57	0.07 64.12	Mag Phase
215	-0.47	0.52	0.29 165.69	0.17 44.40	0.10 35.69	0.03 180.76	0.04 291.48	0.07 10.44	0.07 171.84	0.05 334.41	0.04 164.95	0.04 269.59	Mag Phase
216	-0.46	0.47	0.21 173.69	0.16 359.07	0.16 7.63	0.06 94.98	0.06 345.01	0.04 51.92	0.02 260.70	0.07 233.74	0.04 255.59	0.02 68.37	Mag Phase
217	-0.41	0.83	0.33 175.23	0.33 5.88	0.21 39.13	0.08 125.91	0.12 16.16	0.11 47.38	0.12 219.69	0.06 180.20	0.03 187.18	0.03 101.92	Mag Phase
218	-0.57	0.65	0.27 166.46	0.29 21.31	0.14 26.65	0.03 219.68	0.10 346.05	0.14 97.44	0.02 140.17	0.04 168.01	0.04 108.54	0.03 84.29	Mag Phase
219	-0.63	0.54	0.23 140.86	0.24 354.41	0.16 21.23	0.02 231.83	0.16 2.63	0.10 74.38	0.06 194.31	0.06 196.83	0.07 157.86	0.02 76.31	Mag Phase
220	-0.78	0.58	0.28 133.72	0.29 22.74	0.15 64.94	0.08 251.01	0.09 332.85	0.05 113.08	0.08 249.37	0.02 37.25	0.06 190.69	0.07 94.57	Mag Phase
221	-0.54	0.50	0.25 133.25	0.15 357.42	0.06 8.54	0.09 199.20	0.10 279.36	0.09 39.94	0.05 206.81	0.04 183.91	0.05 112.98	0.04 321.79	Mag Phase
222	-0.62	0.40	0.21 130.81	0.15 335.05	0.08 35.31	0.11 152.46	0.06 288.10	0.05 51.61	0.05 299.90	0.04 78.52	0.03 93.87	0.04 30.82	Mag Phase
223	-0.54	0.43	0.25 110.23	0.12 12.57	0.09 29.62	0.01 122.16	0.13 58.86	0.05 57.16	0.07 180.91	0.03 290.05	0.03 220.46	0.01 96.22	Mag Phase

Table IV. - Continued

(e) Continued

Run 8

$\mu_{Nom} = 0.25$

POINT	MEAN	1/2P-P	1P	2P	3P	4P	5P	6P	7P	8P	9P	10P	
224	-0.30	0.35	0.15 117.35	0.12 358.53	0.06 330.35	0.06 134.64	0.10 93.23	0.04 55.77	0.07 164.70	0.03 209.39	0.01 142.95	0.04 329.91	Mag Phase
225	-0.47	0.29	0.08 36.48	0.07 86.64	0.09 321.47	0.04 111.85	0.04 314.84	0.06 119.46	0.01 60.27	0.06 139.06	0.04 250.83	0.03 161.42	Mag Phase
226	-0.63	0.36	0.08 70.96	0.20 49.62	0.08 290.22	0.06 173.26	0.07 333.91	0.10 100.08	0.04 100.58	0.05 134.22	0.02 6.95	0.03 118.99	Mag Phase
227	-0.55	0.27	0.05 163.94	0.08 354.48	0.04 337.46	0.04 86.25	0.07 68.51	0.05 31.68	0.05 157.78	0.03 136.92	0.04 318.57	0.07 114.22	Mag Phase
228	-0.40	0.32	0.07 209.89	0.16 36.87	0.09 356.58	0.04 90.59	0.08 294.47	0.07 123.36	0.02 283.59	0.04 200.78	0.03 318.71	0.02 30.64	Mag Phase
229	-0.41	0.26	0.05 239.34	0.08 28.57	0.06 310.42	0.07 120.77	0.07 241.11	0.02 109.08	0.07 59.41	0.02 171.89	0.04 323.17	0.04 57.22	Mag Phase
230	-0.39	0.30	0.09 273.98	0.09 8.51	0.03 81.71	0.08 18.69	0.06 93.26	0.01 231.04	0.06 174.68	0.04 113.86	0.04 161.25	0.09 40.22	Mag Phase
231	-0.51	0.43	0.19 269.59	0.12 23.82	0.07 194.18	0.02 81.28	0.06 265.45	0.08 53.96	0.03 131.66	0.04 171.72	0.03 171.07	0.07 62.19	Mag Phase
232	-0.44	0.51	0.24 255.75	0.14 45.84	0.08 326.74	0.04 88.62	0.09 7.90	0.05 123.04	0.09 148.14	0.08 127.96	0.03 291.65	0.01 325.77	Mag Phase
233	-0.73	0.52	0.25 243.69	0.13 19.29	0.03 286.50	0.03 96.26	0.12 357.76	0.09 230.79	0.10 95.46	0.05 96.03	0.05 229.23	0.03 74.89	Mag Phase



Table IV. - Continued

(e) Concluded

Run 8

$\mu_{Nom} = 0.25$

POINT	MEAN	1/2P-P	1P	2P	3P	4P	5P	6P	7P	8P	9P	10P	
234	-0.65	0.27	0.12 239.71	0.13 8.06	0.04 106.15	0.03 49.55	0.06 277.82	0.04 86.64	0.02 93.60	0.06 90.54	0.08 339.27	0.03 57.16	Mag Phase
235	-0.89	0.34	0.14 219.64	0.08 12.38	0.05 246.53	0.05 160.70	0.10 172.41	0.06 344.63	0.04 165.57	0.03 125.46	0.07 319.87	0.04 66.65	Mag Phase
236	-0.67	0.40	0.18 229.86	0.11 359.28	0.06 37.60	0.01 78.65	0.05 43.90	0.04 116.46	0.06 147.95	0.04 183.71	0.05 185.07	0.02 288.14	Mag Phase
237	-0.69	0.41	0.23 230.68	0.16 18.50	0.02 145.06	0.02 92.59	0.04 30.25	0.04 306.41	0.03 27.98	0.08 118.34	0.03 82.13	0.02 225.13	Mag Phase
238	-0.38	0.43	0.29 234.47	0.11 2.84	0.02 228.97	0.07 94.86	0.07 12.75	0.06 116.95	0.04 165.30	0.03 197.16	0.02 133.16	0.02 195.63	Mag Phase
239	-0.60	0.34	0.24 244.26	0.08 11.89	0.03 200.61	0.05 126.76	0.07 54.30	0.04 6.98	0.02 138.49	0.03 123.48	0.03 318.28	0.02 161.53	Mag Phase
240	-0.35	0.50	0.29 207.64	0.12 358.64	0.01 195.59	0.04 122.72	0.09 358.31	0.02 260.00	0.05 162.54	0.05 104.13	0.02 164.27	0.04 223.45	Mag Phase
241	-0.36	0.44	0.29 208.32	0.08 37.77	0.03 130.56	0.04 69.74	0.08 335.42	0.03 210.57	0.01 34.62	0.05 109.84	0.04 170.08	0.03 143.05	Mag Phase
242	-0.36	0.44	0.32 204.90	0.06 323.47	0.02 4.51	0.07 265.38	0.07 66.61	0.05 325.78	0.02 72.53	0.03 97.77	0.04 319.04	0.02 105.20	Mag Phase
243	-0.36	0.34	0.22 210.13	0.11 23.06	0.08 36.54	0.03 59.16	0.03 190.58	0.04 110.52	0.04 181.12	0.02 164.65	0.01 72.21	0.01 209.69	Mag Phase

Table IV. - Continued

(f) Blade chordwise bending moment, in-lbs, 45.00 percent radius

Run 8

$\mu_{Nom} = 0.25$

POINT	MEAN	1/2P-P	1P	2P	3P	4P	5P	6P	7P	8P	9P	10P	
214	-42.97	10.37	4.82 268.66	2.66 70.71	2.02 199.29	0.93 38.68	4.66 0.85	1.02 281.36	1.18 297.92	0.41 247.63	0.26 198.96	0.05 292.60	Mag Phase
215	-43.03	24.16	8.51 297.22	5.61 76.99	4.59 204.26	3.33 340.05	8.78 45.57	3.72 150.78	0.33 300.15	0.61 67.49	0.70 44.58	0.11 78.54	Mag Phase
216	-40.30	38.93	16.78 330.98	9.04 64.11	9.60 176.40	6.01 268.00	8.91 35.09	6.63 53.99	2.27 272.93	1.79 185.36	0.74 55.45	0.67 106.46	Mag Phase
217	-36.34	53.37	21.94 339.64	10.50 38.28	12.57 165.58	7.28 214.44	10.94 92.03	13.26 66.11	3.02 287.77	0.50 279.17	1.27 32.97	1.09 72.88	Mag Phase
218	-33.83	56.35	23.73 343.01	10.99 28.80	13.29 160.75	7.89 202.81	12.30 113.77	16.67 37.44	2.55 272.26	2.15 66.48	1.35 331.74	1.67 79.95	Mag Phase
219	-39.84	41.01	16.93 329.18	7.83 63.54	11.60 174.70	5.08 253.45	9.98 24.24	6.95 38.16	2.34 267.07	1.10 132.94	0.48 46.89	0.95 89.30	Mag Phase
220	-42.85	22.69	8.17 297.80	5.62 77.80	4.51 212.64	3.56 344.61	9.47 44.39	1.78 158.31	0.12 160.51	0.84 248.37	0.53 52.06	0.06 324.69	Mag Phase
221	-42.27	10.42	3.65 270.22	1.89 69.17	1.14 176.36	1.49 108.89	4.65 351.00	1.31 255.29	1.21 285.26	0.59 176.60	0.27 224.45	0.09 262.47	Mag Phase
222	-41.93	16.48	6.61 291.25	3.32 71.24	3.19 208.14	2.26 342.03	9.43 31.21	1.22 45.01	0.64 18.91	0.35 125.33	0.39 8.27	0.22 224.85	Mag Phase
223	-40.27	31.40	14.37 325.63	5.58 69.83	8.83 179.68	4.31 279.03	10.34 7.99	0.95 342.74	0.89 246.87	0.49 121.36	1.34 107.01	0.56 104.57	Mag Phase

Table IV. - Continued

(f) Continued

Run 8

 $\mu_{\text{Nom}} = 0.25$ 

POINT	MEAN	1/2P-P	1P	2P	3P	4P	5P	6P	7P	8P	9P	10P	
224	-37.35	44.66	18.49 333.20	7.33 37.13	11.20 166.16	5.98 222.05	11.23 37.64	9.83 36.43	1.59 298.32	1.50 75.25	0.63 38.55	0.66 97.17	Mag Phase
225	-32.65	52.12	22.23 343.78	9.02 14.43	12.35 157.65	6.62 194.69	10.11 78.40	15.74 20.38	0.64 260.67	4.11 46.83	0.68 249.49	0.96 86.23	Mag Phase
226	-30.11	68.83	24.24 352.18	10.07 11.84	12.59 162.68	6.35 192.24	12.08 356.60	29.28 55.69	5.04 200.30	3.68 54.69	2.62 326.55	1.39 127.53	Mag Phase
227	-40.18	31.25	13.83 324.82	6.21 63.36	8.18 179.72	4.59 276.42	10.71 8.28	2.54 313.23	1.05 245.25	1.98 126.73	1.35 97.42	0.20 86.07	Mag Phase
228	-42.24	16.09	5.88 290.43	2.88 64.07	3.23 206.37	2.81 339.79	10.05 15.92	2.18 21.15	0.82 342.36	1.39 149.62	0.25 321.04	0.26 229.40	Mag Phase
229	-41.88	13.52	4.62 291.94	2.05 61.93	2.70 204.21	1.89 4.30	9.73 10.51	2.01 22.78	0.64 332.31	0.13 295.27	0.32 294.54	0.28 299.29	Mag Phase
230	-40.81	27.19	11.36 318.21	4.47 62.18	6.00 175.19	3.27 292.25	11.55 356.44	1.47 146.78	0.68 141.56	1.22 12.18	0.72 75.04	0.16 317.82	Mag Phase
231	-38.80	37.41	15.93 328.68	4.94 48.11	10.13 169.27	4.15 251.72	12.85 359.08	5.17 42.62	0.78 272.34	1.54 79.74	0.52 125.89	0.24 61.16	Mag Phase
232	-34.93	46.80	20.19 339.10	7.59 17.54	11.27 163.68	6.64 202.68	7.87 15.13	12.44 43.56	1.45 25.93	2.48 30.87	0.56 224.16	0.31 117.48	Mag Phase
233	-32.17	55.90	22.63 344.60	8.53 4.55	12.08 157.82	6.38 187.31	3.65 319.63	17.61 25.32	2.63 114.17	1.43 28.82	1.56 231.25	0.69 33.06	Mag Phase

Table IV. - Continued

(f) Concluded

Run 8

$\mu_{Nom} = 0.25$

POINT	MEAN	1/2P-P	1P	2P	3P	4P	5P	6P	7P	8P	9P	10P	
234	-40.58	25.39	11.11 315.61	4.51 62.38	5.76 173.70	3.12 292.59	10.75 356.98	1.84 98.94	0.69 171.17	1.39 57.39	0.68 78.21	0.19 289.92	Mag Phase
235	-41.89	14.94	3.73 291.73	1.32 78.12	2.53 185.55	2.10 1.53	9.74 350.01	3.52 8.31	0.63 327.20	1.39 261.74	0.31 263.75	0.28 271.46	Mag Phase
236	-40.92	21.98	9.01 314.76	3.90 56.23	4.61 176.38	2.76 323.91	9.96 9.05	2.80 104.82	0.71 121.75	0.60 225.19	0.40 62.07	0.28 275.92	Mag Phase
237	-39.56	30.93	13.56 323.67	4.62 42.17	8.42 162.93	2.68 250.06	10.96 344.69	4.02 82.18	0.73 153.49	0.41 328.51	0.77 100.86	0.19 345.68	Mag Phase
238	-37.03	45.26	18.35 334.55	6.90 25.83	11.05 170.32	4.63 224.77	12.12 347.80	12.49 61.79	0.32 122.80	0.66 253.05	0.11 237.24	0.22 108.79	Mag Phase
239	-34.72	50.08	20.79 339.55	8.63 14.21	11.48 162.98	5.11 199.94	9.10 333.65	15.87 53.40	2.49 51.39	2.27 339.64	0.45 204.72	0.37 142.39	Mag Phase
240	-31.82	56.53	22.89 344.82	10.13 4.69	12.00 159.36	6.49 180.79	4.96 327.07	18.18 50.74	3.91 81.48	2.62 352.89	1.37 268.10	0.34 50.02	Mag Phase
241	-29.06	67.47	24.82 353.34	10.67 1.22	12.30 163.20	6.83 183.95	14.28 302.81	27.52 66.27	8.92 143.94	2.70 39.35	2.78 307.89	1.28 57.28	Mag Phase
242	-36.86	42.96	18.07 334.05	6.80 23.35	11.00 167.57	4.21 224.28	11.71 338.81	12.37 46.64	0.59 86.61	1.26 29.86	0.32 171.75	0.34 141.71	Mag Phase
243	-40.88	22.45	8.61 311.46	4.18 55.56	4.54 176.66	3.06 319.56	10.30 3.26	2.82 82.93	0.83 137.41	1.60 224.33	0.60 63.12	0.26 299.08	Mag Phase

Table IV. - Continued

(g) Blade flapwise bending moment, in-lbs, 51.00 percent radius

Run 8

$\mu_{Nom} = 0.25$

POINT	MEAN	1/2P-P	1P	2P	3P	4P	5P	6P	7P	8P	9P	10P	
214	23.60	7.72	3.09 40.18	3.48 233.84	4.01 332.90	0.94 311.06	0.72 311.10	0.47 197.13	0.60 102.40	0.22 266.65	0.06 217.23	0.09 324.62	Mag Phase
215	26.94	12.05	3.21 30.42	6.47 219.31	6.96 322.34	1.14 304.09	0.29 308.86	0.15 202.50	0.37 160.58	1.83 115.05	0.22 88.88	0.04 115.44	Mag Phase
216	30.19	15.65	3.13 11.25	7.15 203.52	8.67 298.29	0.45 300.38	0.11 51.79	0.25 147.67	0.90 186.25	4.19 116.93	0.61 119.76	0.14 167.35	Mag Phase
217	31.82	17.43	3.62 352.02	5.47 183.78	8.75 265.98	0.45 85.34	0.54 167.57	0.70 139.09	1.57 156.28	5.52 115.10	0.76 119.42	0.26 159.19	Mag Phase
218	32.34	18.16	3.94 341.81	4.87 174.03	8.86 254.84	0.77 97.16	0.68 169.12	0.79 145.18	1.80 148.21	6.41 116.18	0.85 107.07	0.30 157.84	Mag Phase
219	30.27	15.71	3.21 10.98	7.12 200.04	8.60 292.84	0.33 298.00	0.21 135.66	0.38 138.01	1.00 177.91	4.04 108.43	0.55 120.30	0.24 170.12	Mag Phase
220	26.98	12.17	3.14 31.61	6.41 221.48	6.95 328.34	1.13 312.67	0.23 328.10	0.20 195.48	0.55 164.59	1.61 115.89	0.19 99.77	0.05 357.34	Mag Phase
221	23.61	6.19	3.48 36.10	2.14 244.11	2.58 335.76	0.82 326.42	0.54 300.68	0.37 179.29	0.45 76.86	0.96 278.58	0.22 223.44	0.05 345.18	Mag Phase
222	26.91	9.78	3.54 25.45	4.65 221.76	5.50 324.25	1.08 319.59	0.24 301.62	0.50 162.54	0.52 95.33	0.61 194.14	0.25 191.77	0.04 332.37	Mag Phase
223	30.20	14.88	3.47 11.84	6.69 205.90	7.86 306.44	0.80 329.06	0.29 252.05	0.80 156.17	0.79 111.05	1.87 162.75	0.44 157.97	0.02 42.40	Mag Phase

Table IV. - Continued

(g) Continued

Run 8

 $\mu_{\text{Nom}} = 0.25$ 

POINT	MEAN	1/2P-P	1P	2P	3P	4P	5P	6P	7P	8P	9P	10P	
224	31.94	14.88	3.78 356.49	5.28 191.48	7.36 272.22	0.55 26.35	0.57 199.04	1.04 140.77	0.98 102.00	3.23 128.96	0.48 107.81	0.02 104.32	Mag Phase
225	33.44	16.96	4.40 341.82	3.57 171.39	7.72 245.39	1.06 68.44	0.62 165.22	0.89 137.86	1.23 90.59	5.59 130.01	0.66 110.04	0.17 110.31	Mag Phase
226	33.71	16.60	4.51 334.06	3.64 173.08	8.09 245.25	0.76 74.55	0.38 127.74	0.58 148.85	1.07 113.69	5.53 137.63	0.79 127.49	0.19 143.12	Mag Phase
227	30.28	14.51	3.37 9.41	6.68 203.39	7.78 303.93	0.80 324.49	0.35 238.75	0.91 156.93	0.89 119.07	1.56 152.68	0.41 142.36	0.03 30.15	Mag Phase
228	26.89	9.93	3.39 23.03	4.65 216.89	5.39 320.55	1.02 314.35	0.27 303.61	0.53 163.53	0.66 93.41	0.56 211.89	0.25 188.39	0.06 300.81	Mag Phase
229	26.95	9.21	3.93 26.13	4.03 215.33	4.69 327.21	1.03 315.72	0.37 312.90	0.35 195.07	0.50 93.68	1.02 245.50	0.24 179.74	0.08 38.35	Mag Phase
230	30.20	13.25	3.88 18.39	5.63 203.27	7.01 307.13	0.97 314.74	0.35 278.15	0.66 142.70	0.79 65.37	1.16 202.05	0.38 146.74	0.13 46.98	Mag Phase
231	31.85	13.80	3.73 12.62	5.34 194.15	7.07 291.17	0.69 333.04	0.40 243.41	0.77 134.99	1.05 62.37	1.46 167.65	0.49 133.71	0.14 65.76	Mag Phase
232	33.72	12.93	3.84 357.27	3.39 180.42	6.76 257.34	0.80 41.99	0.36 215.01	0.86 136.43	1.42 70.65	2.28 156.74	0.52 121.29	0.26 65.79	Mag Phase
233	34.42	13.34	4.01 342.96	2.60 168.03	7.21 238.69	0.90 47.30	0.22 186.29	0.66 123.60	1.31 48.92	3.13 140.83	0.76 108.21	0.31 59.58	Mag Phase

Table IV. - Continued

(g) Concluded

Run 8

$\mu_{Nom} = 0.25$

POINT	MEAN	1/2P-P	1P	2P	3P	4P	5P	6P	7P	8P	9P	10P	
234	30.18	13.36	3.81 17.60	5.48 200.57	6.91 303.85	0.94 314.29	0.33 275.17	0.63 133.54	0.85 62.96	1.31 193.70	0.32 133.54	0.13 31.58	Mag Phase
235	26.98	9.05	4.24 22.33	3.79 202.20	4.34 320.15	0.97 299.08	0.23 323.90	0.29 222.14	0.23 89.72	0.76 230.14	0.20 184.65	0.05 130.53	Mag Phase
236	30.02	12.28	4.18 22.07	5.37 196.63	6.56 310.71	0.97 305.12	0.20 295.94	0.27 159.78	0.38 98.59	0.60 201.94	0.15 136.70	0.06 71.05	Mag Phase
237	31.73	13.66	4.15 16.82	5.89 187.53	7.18 290.99	0.82 301.06	0.26 239.60	0.33 120.96	0.46 66.41	0.66 156.29	0.23 97.16	0.08 35.58	Mag Phase
238	33.38	13.88	4.08 11.25	5.52 184.89	7.10 277.72	0.37 338.25	0.30 225.31	0.45 134.53	0.79 76.10	1.03 146.50	0.33 126.69	0.07 102.53	Mag Phase
239	34.32	13.02	4.05 1.61	4.50 177.42	6.94 256.65	0.37 37.87	0.26 212.93	0.34 146.61	0.77 80.99	1.38 153.41	0.32 123.04	0.15 73.97	Mag Phase
240	34.99	12.93	4.03 351.56	3.28 169.82	7.22 240.39	0.54 60.48	0.20 176.00	0.25 168.76	0.57 72.18	2.18 142.84	0.45 133.53	0.27 74.75	Mag Phase
241	35.37	13.50	4.05 341.24	2.76 170.50	7.23 242.77	0.51 39.19	0.09 91.43	0.30 266.45	0.31 1.47	2.71 161.40	0.67 147.20	0.24 90.93	Mag Phase
242	33.43	13.42	4.06 9.35	5.55 183.11	7.02 275.86	0.33 325.99	0.32 244.00	0.42 133.82	0.75 78.22	0.66 153.97	0.31 115.77	0.09 99.34	Mag Phase
243	30.07	12.40	4.23 19.77	5.37 193.36	6.48 305.73	0.96 300.09	0.19 283.97	0.27 160.81	0.47 82.45	0.96 172.54	0.22 121.37	0.07 80.44	Mag Phase

Table IV. - Continued

(h) Blade torsional moment, in-lbs, 60.00 percent radius

Run 8

$\mu_{Nom} = 0.25$

POINT	MEAN	1/2P-P	1P	2P	3P	4P	5P	6P	7P	8P	9P	10P	
214	4.42	3.10	2.13 12.46	0.37 217.47	0.52 209.50	0.57 93.35	0.28 184.55	0.49 152.86	0.33 110.04	0.12 94.94	0.07 101.26	0.10 92.67	Mag Phase
215	6.71	4.23	2.75 20.48	1.47 140.04	0.27 24.30	0.97 138.60	0.43 135.61	0.50 123.81	0.32 84.38	0.19 94.73	0.08 79.51	0.11 90.81	Mag Phase
216	9.01	6.71	3.46 19.84	3.41 97.82	2.88 348.22	1.89 235.26	0.82 245.20	0.60 252.53	0.32 5.55	0.15 19.00	0.02 204.69	0.04 294.27	Mag Phase
217	10.10	14.45	4.50 12.61	5.55 65.83	6.63 326.51	4.79 238.73	0.97 274.11	1.24 248.82	0.51 334.95	0.05 216.32	0.11 200.67	0.14 267.81	Mag Phase
218	10.11	17.34	5.15 12.00	6.46 57.35	7.68 322.81	5.96 243.32	0.86 293.39	1.60 246.90	0.80 340.31	0.27 215.68	0.11 213.10	0.13 266.61	Mag Phase
219	9.21	7.03	3.52 17.61	3.58 93.86	3.18 341.21	2.12 228.99	0.80 243.21	0.67 233.57	0.31 346.48	0.10 4.43	0.02 116.95	0.04 208.67	Mag Phase
220	6.89	4.18	2.81 21.57	1.45 144.62	0.23 44.96	0.99 140.54	0.30 154.95	0.56 133.38	0.31 92.37	0.23 101.67	0.09 102.97	0.09 110.62	Mag Phase
221	3.88	3.17	2.23 13.12	0.50 334.40	1.04 250.91	0.64 127.55	0.05 191.28	0.36 149.56	0.29 110.54	0.12 95.59	0.06 94.72	0.09 81.81	Mag Phase
222	6.15	3.76	3.01 20.20	0.64 110.66	0.55 267.87	1.09 130.97	0.05 159.39	0.52 133.69	0.25 103.56	0.10 97.31	0.07 103.44	0.11 81.11	Mag Phase
223	8.49	5.79	3.69 19.57	2.88 98.70	2.30 341.92	1.48 206.57	0.47 267.09	0.48 185.24	0.10 340.58	0.10 300.98	0.01 259.42	0.08 101.84	Mag Phase



Table IV. - Continued

(h) Continued

Run 8

$\mu_{Nom} = 0.25$

POINT	MEAN	1/2P-P	1P	2P	3P	4P	5P	6P	7P	8P	9P	10P	
224	9.70	10.64	4.23 17.34	4.54 69.57	5.15 321.98	3.40 222.86	0.89 290.66	0.89 217.34	0.34 312.25	0.20 269.31	0.06 205.02	0.01 117.45	Mag Phase
225	10.04	16.66	5.32 14.92	6.38 48.08	7.83 313.64	5.63 232.59	1.67 331.29	1.58 235.18	1.25 325.28	0.38 234.43	0.07 272.83	0.05 274.02	Mag Phase
226	9.85	15.21	6.21 12.46	6.85 47.42	7.77 314.14	4.83 241.91	3.08 351.41	1.16 296.44	1.72 357.69	0.43 295.93	0.13 26.53	0.06 195.32	Mag Phase
227	8.69	5.83	3.76 18.76	2.84 97.47	2.19 340.48	1.36 200.97	0.57 264.29	0.55 171.07	0.11 354.76	0.11 295.43	0.02 194.23	0.09 102.04	Mag Phase
228	6.21	3.68	3.02 19.10	0.62 115.34	0.49 252.41	1.07 123.50	0.12 213.33	0.56 134.33	0.27 92.95	0.12 69.74	0.08 90.80	0.11 81.16	Mag Phase
229	5.51	3.86	3.01 20.47	0.34 100.78	0.80 254.16	0.99 119.80	0.23 305.70	0.37 142.21	0.20 110.44	0.08 130.23	0.06 104.53	0.09 101.84	Mag Phase
230	7.81	4.91	3.77 18.69	2.20 95.63	1.42 337.66	0.92 149.08	0.39 299.50	0.36 134.93	0.11 30.66	0.01 245.49	0.03 77.89	0.07 79.06	Mag Phase
231	9.05	6.96	4.13 19.60	3.44 80.68	2.88 326.10	1.48 191.10	0.80 291.69	0.51 175.55	0.07 339.44	0.13 271.46	0.02 172.49	0.04 101.30	Mag Phase
232	10.26	12.60	4.93 18.02	5.22 55.09	6.22 314.11	3.67 218.74	1.40 305.49	1.02 218.12	0.49 318.64	0.25 274.14	0.03 292.16	0.03 184.85	Mag Phase
233	10.26	15.08	5.45 10.89	6.20 41.57	7.57 304.30	4.62 218.79	2.40 304.34	1.46 237.95	1.26 320.77	0.30 268.28	0.08 357.39	0.05 355.79	Mag Phase

Table IV. - Continued

(h) Concluded

Run 8

 $\mu_{\text{Nom}} = 0.25$ 

POINT	MEAN	1/2P-P	1P	2P	3P	4P	5P	6P	7P	8P	9P	10P	
234	7.85	4.97	3.77 17.88	2.22 92.94	1.46 331.73	1.02 150.66	0.31 299.84	0.37 135.73	0.13 30.02	0.01 258.63	0.02 57.76	0.07 79.42	Mag Phase
235	4.84	3.88	2.98 15.82	0.25 113.64	0.69 237.14	0.94 96.75	0.28 278.00	0.32 131.17	0.16 116.57	0.10 93.82	0.03 84.77	0.04 71.47	Mag Phase
236	7.04	4.48	3.60 21.29	1.81 107.57	0.87 337.92	0.83 129.47	0.18 304.41	0.33 125.71	0.12 104.09	0.08 86.22	0.03 73.81	0.05 103.09	Mag Phase
237	8.21	5.86	4.10 15.68	2.87 87.01	2.12 331.33	1.04 161.05	0.58 299.99	0.20 161.81	0.11 319.87	0.04 337.79	0.02 7.12	0.04 44.14	Mag Phase
238	9.50	8.47	4.52 18.03	4.00 75.62	3.83 324.18	1.77 210.07	1.14 292.06	0.59 231.28	0.18 287.48	0.14 313.54	0.02 215.98	0.03 188.74	Mag Phase
239	10.16	11.36	4.97 15.53	4.77 56.82	5.70 313.75	2.83 220.62	1.54 288.47	1.11 230.21	0.46 283.96	0.25 283.66	0.11 310.02	0.06 256.78	Mag Phase
240	10.38	14.63	5.42 10.58	5.80 42.59	7.38 307.33	3.88 222.77	2.22 290.72	1.72 241.66	1.03 299.01	0.38 271.65	0.14 325.27	0.07 217.28	Mag Phase
241	10.05	16.97	6.03 6.37	6.41 38.63	7.33 307.63	3.76 228.26	3.56 309.61	2.64 292.22	2.09 332.28	0.74 318.76	0.22 8.68	0.05 181.20	Mag Phase
242	9.58	8.52	4.56 16.92	3.98 73.47	3.78 321.72	1.71 208.21	1.18 282.50	0.67 222.63	0.23 274.05	0.20 289.01	0.02 202.88	0.03 214.75	Mag Phase
243	7.11	4.52	3.63 19.65	1.81 105.70	0.88 333.54	0.85 125.80	0.14 289.96	0.36 111.58	0.11 82.66	0.12 77.66	0.02 37.70	0.04 93.67	Mag Phase

Table IV. - Continued

(i) Blade flapwise bending moment, in-lbs, 63.00 percent radius

Run 8

$\mu_{Nom} = 0.25$

POINT	MEAN	1/2P-P	1P	2P	3P	4P	5P	6P	7P	8P	9P	10P	
214	14.75	9.33	3.31 52.36	4.12 232.45	4.10 327.79	0.92 251.31	1.62 319.52	0.73 183.79	0.55 148.10	0.16 168.99	0.15 254.80	0.21 210.07	Mag Phase
215	17.37	15.13	3.84 39.18	8.12 223.89	6.88 316.88	1.07 325.64	1.05 128.95	0.27 124.32	0.54 173.44	0.44 140.83	0.24 267.47	0.30 185.79	Mag Phase
216	19.69	19.79	3.60 25.17	9.94 213.32	8.33 286.40	1.35 24.68	2.31 147.60	0.29 144.66	1.01 182.32	0.67 140.22	0.59 270.42	0.37 163.91	Mag Phase
217	21.13	19.76	3.83 3.38	8.79 202.76	9.00 245.29	3.42 51.82	4.63 152.77	0.82 139.30	1.35 162.70	0.86 121.96	0.74 255.86	0.44 128.61	Mag Phase
218	21.66	19.15	3.88 346.53	8.32 199.12	9.57 232.07	4.40 57.98	5.66 149.31	0.80 136.45	1.33 155.57	0.87 122.20	0.96 246.98	0.48 122.23	Mag Phase
219	19.75	20.15	3.49 22.26	9.87 209.99	8.41 279.94	1.63 29.28	2.79 150.97	0.45 127.88	1.02 172.92	0.66 125.01	0.58 262.59	0.46 140.45	Mag Phase
220	17.43	15.09	3.69 39.83	8.03 225.87	6.98 323.50	1.19 330.29	0.99 142.74	0.26 127.28	0.57 182.74	0.36 139.51	0.29 281.25	0.27 203.85	Mag Phase
221	15.17	7.01	3.24 46.80	2.57 234.67	2.64 335.20	1.04 271.90	0.95 308.60	0.70 191.56	0.41 139.45	0.13 273.84	0.26 251.18	0.28 215.10	Mag Phase
222	17.58	11.56	3.60 35.83	6.13 223.64	5.42 320.09	1.23 305.56	0.66 108.47	0.55 166.88	0.55 145.52	0.05 93.97	0.36 281.18	0.31 185.72	Mag Phase
223	19.96	18.63	3.46 27.38	9.08 215.01	7.76 294.24	1.42 26.86	2.31 172.14	0.56 151.27	0.85 158.37	0.31 127.04	0.61 298.78	0.41 177.16	Mag Phase

Table IV. - Continued

(i) Continued

Run 8

$\mu_{Nom} = 0.25$

POINT	MEAN	1/2P-P	1P	2P	3P	4P	5P	6P	7P	8P	9P	10P	
224	21.23	18.18	3.51 11.31	8.41 207.95	7.61 255.08	2.96 42.39	3.71 158.37	0.72 147.62	1.11 142.48	0.52 95.41	0.83 270.72	0.48 165.36	Mag Phase
225	22.49	18.78	3.68 347.36	7.00 202.48	8.67 224.12	4.86 43.54	5.58 133.23	0.66 167.42	1.23 131.31	0.64 113.14	1.06 252.60	0.33 155.93	Mag Phase
226	22.72	18.61	3.66 331.30	7.29 203.87	9.19 223.65	4.03 41.65	5.88 116.67	0.47 209.26	1.12 137.12	0.45 136.77	1.05 261.26	0.25 148.36	Mag Phase
227	20.01	18.49	3.48 26.04	9.03 213.01	7.75 293.08	1.41 19.55	2.20 172.82	0.66 152.58	0.92 153.38	0.22 125.72	0.61 284.99	0.46 177.02	Mag Phase
228	17.60	11.52	3.56 33.97	6.21 220.34	5.35 315.85	1.18 292.49	0.57 90.76	0.47 168.68	0.55 143.71	0.06 90.60	0.34 285.14	0.27 196.81	Mag Phase
229	18.15	9.80	3.81 31.67	5.13 219.67	4.81 322.68	1.48 292.02	0.65 37.93	0.54 202.58	0.46 158.10	0.17 227.48	0.34 277.05	0.34 222.13	Mag Phase
230	20.35	15.22	3.85 30.54	7.45 212.56	7.07 298.27	0.98 323.52	0.69 174.09	0.49 170.04	0.54 144.99	0.08 189.48	0.53 282.99	0.40 207.94	Mag Phase
231	21.41	16.36	3.66 26.67	7.85 208.91	7.04 279.20	1.34 5.00	1.88 169.21	0.59 175.57	0.70 147.05	0.09 169.37	0.64 272.73	0.43 197.52	Mag Phase
232	22.68	14.93	3.49 8.17	6.76 209.10	6.97 239.97	2.73 35.09	3.19 156.67	0.70 176.69	0.92 131.25	0.16 153.75	0.70 264.60	0.39 212.06	Mag Phase
233	23.24	15.84	3.36 348.85	6.30 206.19	7.77 219.24	3.38 30.73	3.45 124.50	0.68 180.64	0.84 112.95	0.29 151.62	0.83 239.17	0.43 189.02	Mag Phase

Table IV. - Continued

(i) Concluded

Run 8

$\mu_{Nom} = 0.25$

POINT	MEAN	1/2P-P	1P	2P	3P	4P	5P	6P	7P	8P	9P	10P	
234	20.30	15.14	3.80 31.42	7.39 210.13	6.91 295.50	0.95 323.46	0.76 158.90	0.47 173.79	0.52 136.76	0.13 195.37	0.58 273.41	0.41 207.71	Mag Phase
235	18.35	8.88	3.92 24.46	4.53 210.03	4.70 314.03	1.58 273.07	1.11 29.86	0.46 192.24	0.31 148.08	0.09 137.11	0.18 275.52	0.33 209.51	Mag Phase
236	20.44	13.67	3.97 25.67	6.54 209.27	6.80 302.18	1.28 305.18	0.69 119.71	0.24 153.83	0.29 146.64	0.03 159.11	0.28 294.85	0.18 208.52	Mag Phase
237	21.47	15.90	4.05 20.62	7.52 203.00	7.39 280.99	1.32 328.67	1.25 142.38	0.27 158.97	0.42 141.57	0.06 125.74	0.32 259.03	0.15 198.50	Mag Phase
238	22.60	15.94	3.89 12.76	7.73 206.12	7.28 265.69	1.54 8.14	1.94 162.83	0.41 178.61	0.55 141.88	0.14 122.15	0.38 271.43	0.26 211.01	Mag Phase
239	23.27	14.68	3.83 0.97	6.97 205.13	7.13 242.19	2.12 21.17	2.20 150.20	0.59 184.91	0.69 140.19	0.23 147.91	0.40 265.59	0.26 216.79	Mag Phase
240	23.70	15.08	3.84 346.14	6.20 207.46	7.56 223.03	2.87 24.11	2.72 132.52	0.56 198.53	0.54 132.51	0.29 148.88	0.43 245.72	0.26 220.48	Mag Phase
241	23.84	15.53	3.90 328.49	6.08 212.78	7.76 224.26	2.71 22.57	3.11 96.04	0.95 258.30	0.23 140.58	0.28 187.66	0.56 249.45	0.34 214.29	Mag Phase
242	22.71	15.64	3.92 12.24	7.61 203.65	7.20 264.38	1.42 5.42	1.68 159.79	0.53 183.32	0.56 140.82	0.15 151.96	0.38 255.06	0.33 202.60	Mag Phase
243	20.55	13.60	4.14 25.29	6.54 205.02	6.67 297.84	1.24 298.00	0.77 102.08	0.27 156.45	0.33 135.34	0.13 135.13	0.25 277.07	0.22 191.12	Mag Phase

Table IV. - Continued

(j) Blade flapwise bending moment, in-lbs, 74.00 percent radius

Run 8

$\mu_{Nom} = 0.25$

POINT	MEAN	1/2P-P	1P	2P	3P	4P	5P	6P	7P	8P	9P	10P	
214	6.20	8.68	2.05 68.86	3.30 234.48	3.82 319.07	0.95 245.56	2.06 325.47	0.36 125.82	0.44 281.93	0.17 63.25	0.07 328.99	0.02 21.60	Mag Phase
215	6.91	15.29	2.58 43.78	6.94 233.86	6.10 305.35	1.98 357.08	1.25 136.12	0.87 98.17	0.58 344.59	2.29 288.96	0.32 266.08	0.28 331.22	Mag Phase
216	7.32	21.89	1.99 17.09	9.32 229.81	7.91 267.13	4.16 35.94	2.62 139.39	1.29 113.65	1.07 3.20	4.97 292.17	0.66 297.72	0.58 336.96	Mag Phase
217	7.93	24.47	2.43 336.53	9.40 226.55	10.30 227.37	7.54 44.07	5.53 147.08	1.58 113.27	1.68 330.61	6.45 288.60	0.88 295.23	0.79 322.46	Mag Phase
218	8.16	27.75	2.74 316.13	9.27 225.31	11.46 216.30	9.00 47.76	6.69 144.54	1.89 111.19	2.00 323.05	7.41 289.37	0.97 282.46	0.82 316.17	Mag Phase
219	7.21	22.24	2.11 6.69	9.47 228.03	8.22 261.66	4.44 32.82	3.18 146.32	1.23 113.69	1.10 348.81	4.85 282.59	0.61 291.64	0.63 328.19	Mag Phase
220	6.80	14.94	2.48 44.72	6.88 237.10	6.23 311.84	2.15 357.05	1.04 150.12	0.81 105.74	0.78 348.44	2.06 291.22	0.25 276.66	0.20 353.84	Mag Phase
221	7.01	7.29	2.05 63.22	2.07 236.53	2.49 330.50	1.40 268.08	1.03 312.43	0.47 150.88	0.29 215.85	1.10 95.55	0.22 36.91	0.06 83.47	Mag Phase
222	7.50	10.81	2.36 45.86	5.41 233.79	4.80 310.13	1.84 326.75	1.00 112.42	0.64 104.50	0.40 286.52	0.62 351.42	0.20 18.95	0.18 11.68	Mag Phase
223	7.96	18.81	2.14 31.89	8.45 232.10	7.25 277.07	3.72 33.70	3.16 165.63	1.04 111.38	0.91 303.66	2.21 326.85	0.37 327.02	0.35 355.38	Mag Phase

Table IV. - Continued

(j) Continued

Run 8

 $\mu_{\text{Nom}} = 0.25$ 

POINT	MEAN	1/2P-P	1P	2P	3P	4P	5P	6P	7P	8P	9P	10P	
224	8.22	20.65	1.72 0.08	8.83 229.65	8.33 236.38	6.45 35.26	5.15 152.64	1.38 109.74	1.09 276.70	3.68 298.27	0.34 275.71	0.44 333.26	Mag Phase
225	8.73	27.70	2.13 311.26	8.47 230.28	10.51 209.54	9.73 36.25	7.68 130.11	2.12 117.06	1.35 266.37	5.99 301.69	0.49 296.08	0.62 313.38	Mag Phase
226	8.60	30.58	2.94 289.13	9.01 232.31	11.10 210.66	9.07 35.91	8.20 116.11	2.19 128.26	1.35 282.16	5.98 308.21	0.76 311.14	0.62 317.99	Mag Phase
227	7.90	18.63	2.03 28.62	8.47 230.67	7.24 276.61	3.76 27.28	3.03 164.59	1.02 103.81	1.02 307.67	1.92 314.04	0.30 318.39	0.32 346.30	Mag Phase
228	7.41	10.66	2.17 44.13	5.40 231.02	4.93 306.45	1.82 315.98	0.83 105.02	0.66 101.39	0.53 278.81	0.49 7.94	0.21 23.13	0.19 10.25	Mag Phase
229	8.41	9.06	2.31 38.80	4.46 230.19	4.33 314.89	1.85 298.73	0.83 60.46	0.55 124.95	0.32 274.93	1.03 63.24	0.18 14.72	0.03 353.15	Mag Phase
230	8.65	13.58	2.28 30.50	6.97 230.40	6.53 284.61	2.04 355.80	1.18 160.49	0.51 102.96	0.63 253.76	1.00 8.86	0.20 329.73	0.17 328.84	Mag Phase
231	8.80	16.08	1.92 18.23	7.86 230.08	6.86 261.93	3.44 16.82	2.85 162.26	0.75 119.33	1.00 246.18	1.46 329.75	0.25 313.60	0.24 327.45	Mag Phase
232	9.08	17.24	1.71 335.57	7.97 234.30	8.11 222.38	6.29 29.77	4.67 153.77	1.27 118.95	1.32 253.91	2.34 324.13	0.25 291.75	0.23 304.06	Mag Phase
233	9.25	21.32	2.25 304.02	8.21 230.96	9.36 204.79	7.45 23.58	5.14 122.18	1.56 110.25	1.31 236.64	3.17 311.35	0.53 294.33	0.39 282.48	Mag Phase

Table IV. - Continued

(j) Concluded

Run 8

 $\mu_{\text{Nom}} = 0.25$ 

POINT	MEAN	1/2P-P	1P	2P	3P	4P	5P	6P	7P	8P	9P	10P	
234	8.55	13.47	2.18 30.60	6.85 228.28	6.34 281.99	2.12 355.13	1.28 150.36	0.51 106.66	0.73 255.33	1.20 2.15	0.15 328.04	0.13 336.98	Mag Phase
235	9.25	8.06	2.37 26.04	3.77 220.49	4.21 307.62	2.14 274.08	1.39 42.48	0.50 107.69	0.01 245.12	0.82 50.83	0.23 15.72	0.06 306.84	Mag Phase
236	9.41	11.73	2.37 24.12	5.86 227.34	6.13 290.08	1.63 332.80	1.17 120.89	0.49 101.72	0.27 308.61	0.56 14.17	0.07 346.80	0.08 338.14	Mag Phase
237	9.56	14.46	2.24 13.32	6.97 223.05	6.91 265.58	2.44 354.66	1.81 143.03	0.41 102.36	0.43 259.74	0.66 315.90	0.11 274.40	0.09 306.72	Mag Phase
238	9.69	15.60	2.10 350.20	7.82 228.64	7.39 248.22	3.64 19.19	2.82 161.87	0.59 130.45	0.75 260.98	1.13 311.47	0.15 293.57	0.19 346.28	Mag Phase
239	9.81	15.14	2.28 328.04	7.73 229.69	7.84 224.63	4.89 24.17	3.26 149.48	0.96 126.70	0.68 260.37	1.38 321.97	0.15 293.15	0.16 314.38	Mag Phase
240	9.84	17.88	2.84 307.98	7.77 232.23	8.82 206.87	6.31 24.45	3.93 132.07	1.16 123.40	0.47 252.48	2.22 315.75	0.32 314.16	0.26 282.74	Mag Phase
241	9.67	20.51	3.64 290.43	8.12 234.94	9.25 208.63	6.12 23.48	4.53 98.76	1.00 133.47	0.27 218.59	2.71 332.72	0.55 327.45	0.36 301.85	Mag Phase
242	9.67	15.12	2.02 349.73	7.64 226.23	7.38 246.55	3.37 16.52	2.54 158.90	0.65 129.58	0.73 260.87	0.69 307.46	0.15 288.54	0.16 328.63	Mag Phase
243	9.46	11.72	2.36 23.07	5.79 223.48	6.07 285.66	1.66 327.28	1.17 104.25	0.55 93.62	0.36 282.17	0.96 344.06	0.16 310.49	0.11 319.00	Mag Phase



Table IV. - Continued

(k) Blade chordwise bending moment, in-lbs, 77.23 percent radius

Run 8

 $\mu_{\text{Nom}} = 0.25$ 

POINT	MEAN	1/2P-P	1P	2P	3P	4P	5P	6P	7P	8P	9P	10P	
214	-34.36	5.69	1.83 283.66	0.37 164.18	1.31 285.44	0.34 351.83	2.45 350.29	0.26 262.86	0.69 301.20	0.21 248.23	0.18 205.37	0.12 315.56	Mag Phase
215	-33.36	10.36	3.07 299.52	1.42 156.98	2.69 269.99	1.87 343.36	3.94 49.56	2.20 140.72	0.24 10.16	0.82 304.04	0.52 2.29	0.22 351.28	Mag Phase
216	-30.97	15.57	4.90 319.44	2.72 119.82	4.57 230.80	2.60 293.71	3.88 43.89	3.34 70.29	1.16 282.51	2.39 260.34	0.72 358.96	0.20 77.54	Mag Phase
217	-29.06	24.40	6.50 327.16	2.82 86.99	6.55 205.97	2.20 255.04	5.94 100.87	6.71 76.20	2.16 297.09	3.34 282.75	1.73 347.72	0.66 25.96	Mag Phase
218	-28.27	25.30	7.13 332.93	2.88 73.57	7.16 198.14	2.16 250.27	7.36 117.48	7.63 47.97	1.96 292.14	2.62 300.12	2.65 320.93	0.98 49.40	Mag Phase
219	-31.35	16.07	5.08 317.64	2.75 125.52	5.23 222.83	2.10 285.95	4.14 34.67	3.22 57.10	1.32 272.15	1.80 263.39	0.65 334.16	0.47 77.64	Mag Phase
220	-33.63	10.02	3.27 304.23	1.44 158.85	2.84 277.35	1.99 347.24	4.15 47.94	1.33 143.30	0.19 54.71	1.40 273.93	0.45 357.48	0.27 333.37	Mag Phase
221	-33.66	4.81	1.93 301.33	0.42 169.87	0.73 305.64	0.15 142.60	2.18 342.38	0.51 224.79	0.62 275.85	0.66 133.90	0.03 253.70	0.09 324.37	Mag Phase
222	-32.86	8.42	3.04 303.35	1.03 171.33	2.32 277.54	1.32 340.43	4.17 33.68	0.86 78.52	0.28 32.50	0.09 344.21	0.45 353.99	0.11 300.61	Mag Phase
223	-31.37	12.66	4.97 317.51	2.13 144.69	4.07 241.63	1.90 312.36	4.04 15.71	0.51 114.40	0.70 242.80	0.83 305.69	0.74 83.26	0.77 73.36	Mag Phase

Table IV. - Continued

(k) Continued

Run 8

$\mu_{Nom} = 0.25$

POINT	MEAN	1/2P-P	1P	2P	3P	4P	5P	6P	7P	8P	9P	10P	
224	-29.71	18.37	5.85 321.20	1.80 102.64	5.46 212.75	1.81 262.18	4.79 53.94	4.64 51.08	1.08 277.26	1.13 304.55	0.85 341.60	0.71 62.10	Mag Phase
225	-27.90	22.19	6.73 333.37	1.88 61.76	6.77 195.71	1.90 258.23	6.67 87.64	6.81 31.52	0.70 272.20	2.80 340.49	1.73 294.58	0.99 39.57	Mag Phase
226	-27.31	31.82	6.99 341.47	1.98 60.31	7.39 199.68	2.20 266.97	6.05 26.38	14.01 60.70	2.21 207.26	2.68 341.13	3.15 321.49	0.88 86.68	Mag Phase
227	-32.01	11.78	4.93 315.61	2.02 137.09	4.09 242.02	2.00 307.28	4.20 14.46	0.29 316.57	0.76 245.18	0.38 168.15	0.80 75.77	0.54 52.81	Mag Phase
228	-33.61	9.05	3.12 303.88	0.97 180.83	2.46 271.14	1.49 335.01	4.34 18.25	1.14 50.55	0.36 341.97	0.71 153.66	0.30 331.31	0.15 273.76	Mag Phase
229	-33.21	8.42	2.95 311.57	0.93 187.13	1.96 280.15	0.97 343.26	4.33 11.07	0.94 52.16	0.33 334.92	0.30 48.76	0.23 309.14	0.24 322.55	Mag Phase
230	-32.45	12.15	4.53 313.78	1.55 145.02	3.21 251.32	1.56 311.59	4.95 357.27	1.20 137.08	0.43 152.57	1.11 0.33	0.54 67.16	0.25 7.39	Mag Phase
231	-31.16	13.55	5.42 316.66	1.60 125.39	4.42 224.56	1.57 284.39	5.02 1.60	2.49 59.68	0.64 243.03	0.65 34.64	0.22 118.66	0.54 42.74	Mag Phase
232	-29.10	17.74	6.20 323.29	1.60 67.45	5.69 204.00	1.92 234.21	2.88 33.04	5.78 54.01	0.45 332.56	2.03 356.89	0.71 280.52	0.45 69.88	Mag Phase
233	-28.30	21.58	6.66 329.26	1.78 46.13	6.61 191.75	2.00 229.42	1.31 11.17	7.99 32.55	1.01 129.55	1.74 330.43	1.59 262.18	1.16 11.08	Mag Phase

Table IV. - Continued

(k) Concluded

Run 8

$\mu_{Nom} = 0.25$

POINT	MEAN	1/2P-P	1P	2P	3P	4P	5P	6P	7P	8P	9P	10P	
234	-33.06	11.30	4.54 309.18	1.62 142.48	3.23 248.78	1.55 310.94	4.63 358.38	1.39 106.37	0.44 183.14	1.03 33.45	0.49 67.06	0.28 356.78	Mag Phase
235	-33.58	8.34	2.76 309.13	1.10 182.90	1.61 271.63	0.92 328.63	4.39 354.14	1.49 22.44	0.33 348.66	0.70 274.53	0.18 283.54	0.31 281.42	Mag Phase
236	-32.79	11.03	4.08 313.53	1.38 147.44	2.73 258.03	1.45 326.99	4.41 12.41	1.73 109.78	0.42 110.15	0.32 253.13	0.33 54.69	0.25 298.40	Mag Phase
237	-31.94	12.68	5.06 315.12	1.60 129.14	3.70 226.29	1.24 285.44	4.55 347.32	2.14 89.49	0.38 164.17	0.49 316.03	0.53 100.93	0.28 8.50	Mag Phase
238	-30.44	17.98	5.83 319.59	1.52 99.89	5.17 216.64	1.54 255.15	4.59 348.14	5.81 66.57	0.24 213.26	0.87 276.73	0.23 292.60	0.30 70.34	Mag Phase
239	-29.33	18.79	6.11 322.03	1.71 65.48	5.74 202.95	1.50 230.56	3.17 334.20	7.25 59.69	0.91 46.69	2.08 327.91	0.38 266.86	0.31 92.79	Mag Phase
240	-28.16	21.79	6.46 327.33	2.06 39.24	6.29 193.01	1.80 211.14	1.49 340.22	8.22 56.34	1.68 82.60	2.51 333.54	1.42 287.72	0.66 23.44	Mag Phase
241	-27.49	31.48	6.73 335.20	2.47 33.99	6.72 194.22	2.22 221.61	5.97 315.27	12.56 66.88	4.12 142.41	2.45 4.44	2.25 316.35	1.51 48.12	Mag Phase
242	-30.89	17.04	5.65 318.50	1.48 98.52	5.10 214.33	1.45 252.61	4.45 337.45	5.62 52.34	0.15 172.70	0.82 0.33	0.22 222.12	0.26 119.92	Mag Phase
243	-33.59	11.33	3.77 311.02	1.41 144.63	2.83 254.01	1.61 319.77	4.58 6.38	1.71 88.65	0.45 129.10	1.01 248.67	0.43 51.39	0.31 319.02	Mag Phase

Table IV. - Continued

(l) Blade torsional moment, in-lbs, 85.00 percent radius

Run 8

$\mu_{Nom} = 0.25$

POINT	MEAN	1/2P-P	1P	2P	3P	4P	5P	6P	7P	8P	9P	10P	
214	2.10	2.17	1.17 38.08	0.54 189.23	0.40 165.78	0.60 72.91	0.15 192.08	0.19 213.06	0.18 147.78	0.13 126.65	0.11 108.63	0.05 58.92	Mag Phase
215	3.53	3.31	2.06 43.18	0.92 157.30	0.39 122.21	0.55 111.97	0.33 180.70	0.22 176.80	0.27 96.25	0.32 93.10	0.17 39.88	0.07 336.54	Mag Phase
216	4.61	4.59	2.51 37.23	1.18 95.21	1.47 15.44	0.62 282.49	0.44 281.41	0.19 276.55	0.35 68.24	0.70 100.28	0.48 102.53	0.17 106.84	Mag Phase
217	5.31	7.85	3.19 32.90	2.28 57.51	3.19 341.11	2.28 254.01	0.77 291.21	0.52 272.43	0.40 37.66	0.59 101.86	0.24 99.34	0.11 359.32	Mag Phase
218	5.45	9.29	3.43 28.43	2.79 48.10	3.94 337.16	2.91 255.42	0.93 307.05	0.60 269.44	0.59 29.97	0.63 119.15	0.21 91.26	0.13 337.48	Mag Phase
219	4.71	5.08	2.82 35.62	0.95 87.09	1.76 6.69	0.80 256.63	0.32 308.48	0.18 209.49	0.46 40.84	0.59 105.03	0.34 94.25	0.21 142.13	Mag Phase
220	2.96	3.34	2.21 71.09	0.69 139.73	0.47 83.77	0.31 145.68	0.60 187.57	0.28 134.42	0.12 79.51	0.33 114.95	0.30 58.57	0.27 341.76	Mag Phase
221	1.84	2.28	1.65 49.18	0.70 304.21	0.59 227.91	0.48 135.76	0.12 105.83	0.12 160.74	0.13 116.98	0.04 67.09	0.01 144.75	0.05 87.85	Mag Phase
222	3.16	3.07	2.47 47.16	0.44 239.85	0.33 159.85	0.57 133.95	0.13 159.96	0.10 138.69	0.17 121.20	0.05 96.54	0.12 85.21	0.08 291.11	Mag Phase
223	4.67	3.99	2.87 43.97	1.00 107.15	0.83 19.11	0.68 206.30	0.24 280.09	0.36 203.72	0.09 56.71	0.22 151.87	0.08 45.98	0.07 189.76	Mag Phase

Table IV. - Continued

(I) Continued

Run 8

 $\mu_{\text{Nom}} = 0.25$ 

POINT	MEAN	1/2P-P	1P	2P	3P	4P	5P	6P	7P	8P	9P	10P	
224	5.34	6.16	3.19 38.10	1.84 63.04	2.26 336.74	1.49 236.51	0.61 298.15	0.38 233.59	0.15 37.56	0.26 107.72	0.11 73.52	0.04 319.39	Mag Phase
225	5.58	8.97	3.62 27.46	2.88 37.22	4.06 326.59	2.59 243.58	1.31 324.12	0.49 256.79	0.67 4.38	0.60 130.26	0.12 68.76	0.05 252.98	Mag Phase
226	5.53	9.20	3.90 22.16	3.26 34.59	4.05 329.92	2.15 251.31	1.76 339.99	0.51 334.16	0.80 29.68	0.57 150.25	0.07 102.05	0.14 239.72	Mag Phase
227	4.79	3.90	2.91 41.95	0.76 105.64	0.86 20.77	0.60 220.64	0.21 296.00	0.32 218.38	0.26 64.63	0.08 138.20	0.24 71.52	0.04 245.15	Mag Phase
228	3.02	2.82	2.22 56.01	0.11 266.50	0.14 102.71	0.37 148.77	0.43 164.24	0.42 99.74	0.08 37.40	0.07 182.06	0.10 164.68	0.04 232.91	Mag Phase
229	2.92	2.74	2.22 49.40	0.41 285.17	0.47 192.36	0.53 129.11	0.05 80.50	0.06 181.31	0.10 140.51	0.09 142.16	0.06 45.91	0.03 338.15	Mag Phase
230	4.46	3.08	2.77 40.80	0.62 108.67	0.40 39.88	0.39 152.86	0.11 332.99	0.15 206.05	0.19 71.25	0.10 186.34	0.12 70.70	0.10 257.06	Mag Phase
231	5.17	4.36	3.07 40.18	1.31 79.21	0.97 348.07	0.56 192.97	0.40 286.93	0.25 191.99	0.08 90.49	0.09 134.55	0.06 75.90	0.02 232.69	Mag Phase
232	5.70	6.95	3.57 35.21	2.25 45.38	2.87 326.20	1.61 234.43	0.84 311.26	0.36 234.28	0.24 19.71	0.17 110.34	0.13 54.75	0.05 284.53	Mag Phase
233	5.68	8.36	3.75 25.13	2.85 28.72	3.77 316.64	2.05 235.54	1.44 305.69	0.53 262.40	0.62 347.90	0.27 111.16	0.06 46.58	0.05 226.26	Mag Phase

Table IV. - Continued

(l) Concluded

Run 8

$\mu_{Nom} = 0.25$

POINT	MEAN	1/2P-P	1P	2P	3P	4P	5P	6P	7P	8P	9P	10P	
234	4.39	3.15	2.79 38.84	0.35 91.25	0.57 30.76	0.24 154.91	0.26 49.85	0.07 187.70	0.41 89.56	0.13 169.82	0.23 121.88	0.18 246.81	Mag Phase
235	2.99	2.54	1.85 30.78	0.14 239.33	0.47 199.79	0.58 101.68	0.09 241.83	0.10 135.14	0.07 133.55	0.05 144.59	0.04 62.70	0.02 10.73	Mag Phase
236	4.26	2.90	2.45 39.15	0.64 120.14	0.14 75.47	0.45 121.77	0.09 290.37	0.10 139.79	0.05 100.28	0.08 114.66	0.04 62.14	0.01 340.70	Mag Phase
237	4.89	3.57	2.88 36.82	1.08 89.27	0.64 1.71	0.43 154.23	0.24 283.26	0.11 194.88	0.02 325.91	0.07 104.79	0.03 41.50	0.02 297.73	Mag Phase
238	5.53	5.25	3.29 38.51	1.59 70.28	1.52 342.56	0.68 225.55	0.55 291.81	0.27 241.98	0.01 57.50	0.10 70.42	0.10 70.15	0.02 78.34	Mag Phase
239	5.78	6.61	3.52 33.40	2.02 45.52	2.62 326.67	1.27 241.18	0.82 296.89	0.43 248.83	0.13 326.39	0.09 69.30	0.16 42.87	0.04 14.51	Mag Phase
240	5.79	8.26	3.75 25.89	2.65 28.28	3.65 318.91	1.83 244.16	1.24 298.60	0.67 261.43	0.43 328.77	0.10 83.25	0.15 38.24	0.02 336.95	Mag Phase
241	5.62	9.48	4.00 19.21	3.09 24.46	3.74 321.01	1.65 249.11	1.79 313.32	1.11 304.48	0.88 349.69	0.08 105.18	0.16 84.04	0.09 203.22	Mag Phase
242	5.61	5.28	3.30 37.52	1.58 67.70	1.50 340.04	0.67 224.57	0.55 282.15	0.30 233.31	0.02 239.60	0.04 39.00	0.09 63.26	0.02 34.81	Mag Phase
243	4.23	3.03	2.41 32.13	0.39 111.53	0.27 3.72	0.36 88.00	0.21 352.84	0.24 59.87	0.23 65.23	0.26 89.27	0.17 93.98	0.10 125.71	Mag Phase

Table IV. - Continued

(m) Fixed-system strain-gage balance normal force, lbs

Run 8

$\mu_{Nom} = 0.25$

POINT	MEAN	1/2P-P	1P	2P	3P	4P	5P	6P	7P	8P	9P	10P	
214	100.24	47.47	25.31 186.22	7.97 1.80	0.97 108.00	19.89 138.71	15.00 59.27	7.01 212.58	0.90 245.84	5.98 181.70	1.43 177.46	0.97 97.22	Mag Phase
215	169.67	74.22	30.34 189.48	6.01 18.60	1.77 182.00	37.34 135.23	18.94 46.76	8.17 207.52	1.15 295.62	21.20 147.47	6.40 182.56	2.36 317.30	Mag Phase
216	234.27	79.89	34.11 194.83	2.83 29.61	6.32 169.02	38.63 120.98	7.07 23.41	8.62 177.51	8.39 270.64	30.06 123.50	7.93 139.05	1.24 6.75	Mag Phase
217	263.51	120.60	64.74 201.06	9.49 196.42	12.20 127.38	29.91 105.45	15.70 318.83	3.36 162.50	10.65 222.18	30.17 121.18	5.00 47.22	3.32 52.41	Mag Phase
218	272.85	132.40	69.81 206.14	11.86 225.44	10.82 112.12	31.72 84.15	22.02 281.43	3.83 106.88	15.61 222.79	31.28 115.98	8.49 54.64	2.32 157.27	Mag Phase
219	235.67	107.65	55.12 181.71	9.61 93.42	3.58 121.28	50.24 119.43	10.17 7.34	10.05 150.28	7.56 257.12	29.65 114.83	10.98 73.31	15.34 347.78	Mag Phase
220	170.57	73.72	29.83 191.97	4.90 24.36	2.56 201.60	38.23 142.07	13.48 57.01	9.06 222.68	0.88 282.21	20.84 164.04	5.96 208.98	2.81 20.02	Mag Phase
221	70.71	40.59	24.05 191.34	7.07 357.79	2.01 68.38	15.58 134.99	12.66 61.52	6.88 197.52	1.28 215.94	3.81 237.90	0.36 27.97	1.84 42.50	Mag Phase
222	140.83	63.33	29.08 191.64	6.21 20.01	1.39 163.57	31.20 128.92	12.67 43.04	10.63 204.22	0.72 351.92	13.49 157.28	4.05 204.81	1.87 352.70	Mag Phase
223	209.08	87.93	47.62 186.00	8.82 78.13	1.21 134.67	44.65 121.15	14.87 31.91	9.54 170.47	5.01 327.74	21.92 129.15	7.39 79.34	7.11 329.83	Mag Phase

Table IV. - Continued

(m) Continued

Run 8

$\mu_{Nom} = 0.25$

POINT	MEAN	1/2P-P	1P	2P	3P	4P	5P	6P	7P	8P	9P	10P	
224	238.02	114.07	65.10 194.31	7.12 147.56	11.10 99.71	37.91 115.32	11.91 333.12	10.46 170.34	8.21 248.01	23.35 125.60	6.81 96.59	1.88 12.50	Mag Phase
225	263.23	140.63	74.65 207.34	10.40 214.81	11.98 94.17	35.60 79.46	21.65 274.61	5.00 126.81	14.50 228.85	27.18 104.62	10.01 46.61	3.10 295.18	Mag Phase
226	273.30	186.55	78.77 217.51	5.14 246.20	13.80 84.01	43.45 72.30	46.92 302.92	8.79 127.93	15.91 252.24	40.04 112.81	20.90 116.32	7.66 338.13	Mag Phase
227	209.84	76.29	42.38 188.85	6.29 75.52	5.26 162.97	43.36 124.48	11.57 31.70	12.58 176.14	6.96 296.92	21.19 121.83	5.35 78.56	6.87 359.47	Mag Phase
228	140.28	64.88	28.11 190.51	6.50 24.53	0.28 166.61	30.78 125.54	10.15 26.12	11.54 200.55	0.87 7.61	15.69 159.46	3.81 206.86	3.59 357.84	Mag Phase
229	113.49	59.08	27.82 189.41	6.55 25.49	1.13 58.35	26.59 133.44	8.02 38.32	10.35 214.82	0.45 111.41	8.72 168.90	1.36 197.01	3.81 40.46	Mag Phase
230	182.21	69.14	37.39 190.11	6.34 53.81	3.91 165.44	37.87 121.39	9.24 34.55	10.19 187.53	5.32 322.78	15.17 119.83	5.77 94.11	3.05 12.57	Mag Phase
231	214.13	99.05	57.77 182.90	10.51 91.88	3.15 64.38	44.28 112.03	12.91 348.14	7.88 147.98	3.20 315.75	19.85 99.49	10.24 42.68	11.06 326.25	Mag Phase
232	241.47	119.98	70.89 203.02	7.04 176.50	13.59 94.44	34.69 98.29	19.13 301.90	6.03 154.60	6.63 228.91	13.98 122.16	2.65 356.33	4.84 275.89	Mag Phase
233	253.12	138.22	76.55 209.02	6.51 208.54	12.29 77.58	34.51 69.94	34.59 272.24	5.00 111.35	9.24 218.93	12.41 90.31	9.67 21.44	8.17 274.75	Mag Phase



Table IV. - Continued

(m) Concluded

Run 8

 $\mu_{\text{Nom}} = 0.25$ 

POINT	MEAN	1/2P-P	1P	2P	3P	4P	5P	6P	7P	8P	9P	10P	
234	182.62	68.32	35.86 188.62	6.21 57.00	4.01 161.50	37.47 118.47	8.17 23.39	9.85 181.76	3.59 303.23	16.61 116.55	5.80 95.09	5.63 11.78	Mag Phase
235	87.43	61.08	26.82 186.99	6.37 19.14	1.06 321.07	25.39 125.58	4.53 348.72	12.13 211.03	0.87 83.52	5.56 159.96	1.13 206.19	3.52 28.90	Mag Phase
236	153.91	66.42	34.44 186.77	6.90 52.92	3.86 159.32	33.44 123.70	7.68 34.27	10.41 200.83	1.55 313.77	8.36 132.35	3.63 125.89	3.73 11.04	Mag Phase
237	188.63	78.92	46.60 182.83	7.94 77.86	2.14 95.57	40.34 103.48	10.57 350.31	6.64 160.21	1.67 314.64	10.48 92.23	3.92 54.43	5.15 314.81	Mag Phase
238	219.37	108.22	65.42 192.09	7.88 119.61	9.41 76.65	39.52 110.09	15.34 333.64	7.35 150.21	3.28 212.64	13.33 109.38	7.27 68.38	6.35 0.71	Mag Phase
239	234.41	120.18	72.26 201.81	5.69 141.58	12.19 83.93	33.34 95.10	20.18 309.31	3.62 162.91	5.43 206.50	12.38 116.54	1.48 63.72	3.63 276.93	Mag Phase
240	245.41	128.60	75.20 208.68	4.56 169.52	14.59 84.70	32.61 81.40	29.04 294.01	2.19 118.86	7.35 226.21	11.00 97.45	6.34 350.44	10.46 263.04	Mag Phase
241	254.87	159.39	82.96 215.89	0.90 197.88	17.65 81.09	33.21 72.35	44.98 295.37	5.18 90.88	12.37 256.23	15.22 92.55	9.34 63.79	14.82 296.74	Mag Phase
242	219.51	109.90	64.70 190.86	8.83 114.64	8.38 66.34	38.46 105.87	14.36 320.63	6.66 148.38	1.92 241.45	15.43 95.28	8.90 55.42	8.22 353.80	Mag Phase
243	153.80	64.58	31.95 186.84	6.39 47.54	4.42 165.21	32.14 119.95	5.67 19.80	10.97 201.14	1.52 308.59	11.32 129.52	4.75 117.65	4.16 29.41	Mag Phase

Table IV. - Continued

(n) Fixed-system strain-gage balance axial force, lbs

Run 8

 $\mu_{\text{Nom}} = 0.25$ 

POINT	MEAN	1/2P-P	1P	2P	3P	4P	5P	6P	7P	8P	9P	10P	
214	8.77	16.38	1.14 139.48	0.62 0.60	3.68 144.71	6.00 145.46	3.17 253.93	6.07 9.29	3.68 344.33	0.98 185.53	3.06 325.95	1.13 221.57	Mag Phase
215	7.24	23.64	2.08 180.10	1.15 31.65	8.42 230.85	10.78 147.67	3.36 228.32	8.58 359.96	2.85 323.15	3.08 155.40	2.69 359.90	2.87 139.85	Mag Phase
216	4.45	29.75	6.72 233.58	1.91 204.92	9.03 215.88	11.26 145.77	1.96 318.97	8.83 329.48	7.95 349.56	7.16 114.09	4.48 63.76	2.45 65.52	Mag Phase
217	2.46	40.85	15.14 238.32	12.46 151.58	5.48 47.12	13.69 131.19	2.37 225.24	6.15 253.45	9.80 306.41	10.26 87.00	2.83 129.20	2.16 23.04	Mag Phase
218	0.88	56.82	17.66 245.22	14.06 160.64	13.62 34.56	13.28 133.88	2.89 3.49	13.56 244.86	14.07 321.04	14.96 99.37	0.79 250.52	3.46 321.41	Mag Phase
219	4.20	39.61	9.62 217.85	10.00 74.83	9.86 256.06	9.22 138.71	0.42 291.72	9.85 299.19	1.85 7.30	7.00 104.06	7.64 46.67	2.12 263.88	Mag Phase
220	7.06	24.47	2.00 185.27	1.00 314.13	8.43 227.90	10.70 157.71	1.35 268.24	10.05 17.43	3.76 12.27	3.05 158.23	2.53 16.12	3.50 188.03	Mag Phase
221	1.53	17.62	1.26 166.11	1.24 9.06	5.88 91.85	4.38 138.51	2.84 247.95	5.99 359.31	3.87 327.73	0.85 197.40	1.85 290.16	0.71 279.70	Mag Phase
222	-0.10	19.98	2.59 180.00	1.30 348.59	4.21 207.62	8.54 141.79	2.23 267.67	9.74 1.80	2.49 312.96	3.46 168.90	1.98 322.78	0.91 136.94	Mag Phase
223	-2.53	34.69	8.00 207.15	8.25 63.52	13.96 253.98	11.09 153.05	3.03 279.13	7.08 311.73	5.30 79.02	7.30 112.91	5.68 33.86	3.14 23.41	Mag Phase

Table IV. - Continued

(n) Continued

Run 8

$\mu_{Nom} = 0.25$

POINT	MEAN	1/2P-P	1P	2P	3P	4P	5P	6P	7P	8P	9P	10P	
224	-4.54	34.99	13.72 220.95	10.46 108.97	3.02 338.42	11.54 127.61	1.68 189.04	8.12 279.44	7.06 28.17	7.93 116.55	0.89 4.67	4.86 21.17	Mag Phase
225	-6.58	65.65	18.62 236.65	12.35 151.49	18.82 23.52	12.18 123.68	4.17 0.10	15.90 255.04	15.51 312.06	14.23 90.15	0.59 327.03	5.01 323.53	Mag Phase
226	-8.70	77.66	22.48 244.19	11.91 176.16	31.14 35.33	10.93 126.40	10.79 85.44	22.42 306.43	17.44 353.51	14.51 119.57	5.34 345.27	4.14 354.97	Mag Phase
227	-2.68	31.29	7.32 212.71	4.57 71.84	10.21 229.19	10.87 149.20	3.60 296.51	10.15 325.08	3.36 28.51	4.41 118.16	4.87 19.87	0.22 349.34	Mag Phase
228	-0.27	23.47	2.37 179.33	1.12 329.43	2.94 268.54	8.65 139.20	1.05 273.32	11.02 358.17	3.01 311.51	4.01 167.01	2.12 333.56	2.25 136.90	Mag Phase
229	-7.68	21.84	2.86 185.31	1.76 3.80	1.34 2.84	7.33 146.98	1.84 301.59	10.89 20.74	2.48 316.40	2.16 181.72	1.97 321.79	1.80 166.60	Mag Phase
230	-9.69	26.40	6.46 202.96	2.80 56.05	9.33 233.07	10.36 143.75	3.95 285.89	8.94 339.84	0.61 350.98	3.67 120.46	3.22 356.78	2.63 43.36	Mag Phase
231	-11.33	38.78	12.36 205.41	10.07 57.31	11.05 262.50	9.74 134.57	0.80 297.92	5.69 288.82	3.62 48.82	6.41 83.05	5.68 12.18	3.55 304.62	Mag Phase
232	-13.27	46.29	17.80 226.84	10.01 131.53	13.48 34.43	12.14 128.08	0.68 213.65	10.17 269.41	8.32 257.69	5.27 76.52	2.16 132.69	2.14 58.32	Mag Phase
233	-14.47	65.78	20.37 232.06	10.83 153.74	24.06 22.01	10.96 117.59	5.16 29.80	16.91 260.99	14.06 300.79	7.99 78.85	0.85 179.52	2.34 269.03	Mag Phase

Table IV. - Continued

(n) Concluded

Run 8

$\mu_{Nom} = 0.25$

POINT	MEAN	1/2P-P	1P	2P	3P	4P	5P	6P	7P	8P	9P	10P	
234	-9.65	25.16	6.21 201.43	2.41 44.38	8.33 224.69	10.27 143.34	3.32 298.70	9.50 344.46	4.55 3.00	3.15 114.48	3.50 7.09	2.00 58.20	Mag Phase
235	-14.64	23.47	3.45 186.63	2.26 343.32	5.34 280.90	6.76 142.70	0.91 345.42	12.97 9.02	0.79 281.22	1.13 212.16	0.64 289.06	1.89 139.43	Mag Phase
236	-17.01	22.94	6.01 195.65	3.65 37.84	7.97 215.07	9.19 147.65	3.30 287.67	10.77 356.86	2.38 325.68	1.87 172.30	1.89 36.44	1.56 100.78	Mag Phase
237	-17.87	30.47	10.34 200.96	7.14 54.57	9.93 238.17	11.18 135.19	2.16 268.24	6.39 317.29	3.64 71.41	2.61 86.60	3.06 3.79	0.39 76.36	Mag Phase
238	-19.89	32.87	16.86 212.92	9.01 87.38	5.97 339.48	11.01 128.78	1.54 130.27	7.46 293.13	1.90 50.96	3.03 72.80	3.23 77.76	4.47 18.45	Mag Phase
239	-21.04	45.24	19.95 222.37	7.55 120.64	15.62 20.71	11.00 126.59	1.22 135.06	8.77 281.27	7.15 225.06	3.28 55.66	4.36 119.33	3.44 69.86	Mag Phase
240	-21.95	66.12	21.95 229.07	9.29 147.98	27.56 38.87	10.15 121.38	1.36 73.12	13.67 274.10	13.32 268.91	5.00 58.06	4.31 164.09	1.40 127.55	Mag Phase
241	-23.59	83.71	25.65 235.66	9.30 172.51	38.80 44.68	8.93 123.31	7.87 74.19	24.09 294.49	14.77 312.10	4.94 86.53	2.80 278.05	0.82 357.35	Mag Phase
242	-19.90	35.21	16.79 212.72	8.63 76.93	7.78 325.40	10.20 126.01	1.70 57.58	6.83 304.41	2.32 349.25	4.24 49.12	4.45 59.43	3.52 336.36	Mag Phase
243	-16.60	27.25	5.79 196.76	1.83 38.28	8.88 206.99	9.04 144.09	3.01 303.26	11.29 357.99	5.75 326.50	1.40 178.16	1.56 30.98	2.14 109.86	Mag Phase

Table IV. - Continued

(o) Fixed-system strain-gage balance pitching moment, in-lbs

Run 8

$\mu_{Nom} = 0.25$

POINT	MEAN	1/2P-P	1P	2P	3P	4P	5P	6P	7P	8P	9P	10P	
214	187.69	440.41	114.35 159.53	41.27 325.62	102.75 154.93	303.29 151.94	39.24 87.56	13.31 358.98	5.38 45.49	13.38 329.94	8.22 349.27	5.75 301.68	Mag Phase
215	172.34	842.50	183.51 195.43	44.24 358.40	264.46 236.48	561.77 151.64	38.52 81.32	14.07 343.90	4.27 105.45	40.31 301.57	20.87 351.73	3.33 206.63	Mag Phase
216	149.94	1145.90	494.18 245.14	89.22 237.82	277.95 226.25	567.79 143.44	9.86 62.55	31.32 335.49	33.63 68.27	64.97 255.24	19.14 313.61	6.45 340.84	Mag Phase
217	133.70	1851.68	1162.76 240.14	360.31 176.60	142.90 74.29	531.92 136.44	66.88 331.72	25.00 223.51	61.59 8.05	49.57 225.31	14.88 270.34	1.48 82.10	Mag Phase
218	117.81	1988.71	1305.89 246.69	387.56 184.54	351.12 39.69	481.88 130.62	102.14 329.01	50.89 221.87	104.21 15.72	57.82 205.54	21.12 281.37	2.04 314.21	Mag Phase
219	144.44	1285.70	757.77 213.57	229.16 112.10	253.35 270.18	592.29 139.54	29.21 55.83	58.83 314.39	31.59 66.61	57.25 240.64	33.19 239.55	20.35 136.16	Mag Phase
220	165.18	822.04	173.55 197.91	55.03 308.87	270.17 232.97	563.13 159.06	26.60 98.95	18.32 358.64	9.07 69.05	37.72 318.77	19.50 13.33	10.95 255.76	Mag Phase
221	135.33	407.65	100.26 174.91	41.73 349.39	163.87 95.87	239.95 145.89	38.06 87.85	10.33 337.41	4.42 31.66	11.26 338.70	3.48 300.10	3.59 267.76	Mag Phase
222	112.21	636.84	176.03 188.36	52.67 332.66	129.52 214.40	457.71 146.03	30.63 85.76	17.33 353.05	5.10 79.03	29.38 309.96	12.38 349.51	4.18 239.76	Mag Phase
223	102.51	1283.83	606.97 205.92	153.55 90.98	384.66 268.67	574.60 146.31	22.48 17.14	44.70 336.30	30.98 108.26	41.76 257.07	16.14 236.84	10.84 105.20	Mag Phase

Table IV. - Continued

(o) Continued

Run 8

 $\mu_{\text{Nom}} = 0.25$ 

POINT	MEAN	1/2P-P	1P	2P	3P	4P	5P	6P	7P	8P	9P	10P	
224	79.47	1555.22	1020.36 222.78	282.82 139.62	95.89 37.72	547.52 135.84	5.37 312.71	41.12 319.26	45.36 55.27	46.11 241.02	22.84 288.49	4.93 212.00	Mag Phase
225	75.16	1943.71	1316.29 240.69	319.51 176.29	528.54 31.68	492.71 123.00	88.78 325.88	49.79 229.47	95.37 14.76	62.96 196.98	18.31 256.93	7.92 36.51	Mag Phase
226	40.71	2290.38	1520.77 249.41	358.03 205.93	904.74 37.85	480.15 117.34	125.38 355.75	85.56 273.10	133.36 49.21	85.37 224.25	47.88 304.66	9.38 182.61	Mag Phase
227	96.99	1049.34	513.71 214.30	78.83 108.39	287.33 235.38	582.39 145.86	9.82 70.39	42.64 335.54	36.02 87.72	41.67 247.10	11.88 238.19	8.28 180.20	Mag Phase
228	107.74	656.50	157.51 187.77	53.91 317.97	91.67 273.84	452.25 141.39	14.58 75.52	19.23 347.70	5.36 75.85	32.78 311.27	12.78 351.01	7.43 200.54	Mag Phase
229	46.96	595.04	152.33 187.25	61.12 353.22	42.11 1.84	388.29 150.39	12.29 96.43	18.46 10.33	5.50 84.71	20.60 324.78	7.37 354.40	7.12 212.56	Mag Phase
230	36.44	901.78	391.88 209.64	48.34 55.69	273.60 238.30	524.19 142.39	18.45 87.10	22.80 342.25	16.36 119.12	27.48 253.35	10.12 265.28	6.68 169.63	Mag Phase
231	18.83	1327.48	818.51 205.52	207.96 91.40	295.60 280.81	540.98 135.91	26.48 27.81	43.49 303.64	23.14 89.00	40.19 228.18	20.29 206.42	16.90 109.43	Mag Phase
232	3.27	1802.51	1183.44 231.63	254.65 165.20	415.70 49.83	510.30 132.12	47.91 327.24	26.36 265.87	31.05 14.13	30.86 205.51	4.77 281.43	7.04 69.08	Mag Phase
233	-4.87	1972.63	1331.06 238.45	275.57 183.53	688.75 28.97	448.79 115.93	90.42 325.22	60.51 235.37	83.04 6.71	40.17 169.34	13.19 219.21	7.75 48.68	Mag Phase

Table IV. - Continued

(o) Concluded

Run 8

 $\mu_{\text{Nom}} = 0.25$ 

POINT	MEAN	1/2P-P	1P	2P	3P	4P	5P	6P	7P	8P	9P	10P	
234	29.15	846.01	367.10 208.83	38.74 40.91	251.46 230.13	518.85 140.41	9.44 76.55	23.88 338.79	10.96 74.77	28.24 249.72	11.93 255.08	10.02 168.55	Mag Phase
235	-5.57	599.36	148.28 185.82	74.79 336.48	167.58 281.21	361.22 141.56	2.75 208.86	19.73 350.10	1.24 44.71	16.13 310.71	2.88 324.98	8.35 205.46	Mag Phase
236	-33.87	746.34	332.46 201.37	72.29 42.22	220.95 217.65	472.25 145.14	14.02 81.61	21.20 352.48	2.83 69.74	17.81 270.32	7.87 283.94	8.19 193.24	Mag Phase
237	-35.17	1123.57	612.41 203.86	137.30 75.19	254.68 250.45	526.33 129.71	29.32 332.68	29.42 318.86	16.09 74.25	17.16 227.58	8.37 202.59	5.02 99.61	Mag Phase
238	-52.70	1527.55	1040.50 217.69	194.58 131.52	188.61 12.78	527.64 133.37	14.54 329.97	42.74 316.40	24.07 55.73	24.91 221.54	16.92 239.26	12.15 188.81	Mag Phase
239	-62.93	1808.44	1220.07 228.01	198.30 162.44	470.96 36.32	481.73 129.90	53.81 331.32	27.56 276.99	22.27 5.90	18.41 218.36	8.43 256.61	5.00 166.45	Mag Phase
240	-61.07	2150.86	1342.85 235.96	233.49 180.68	810.79 48.66	442.14 124.14	78.24 342.67	45.35 257.82	46.94 11.59	28.60 187.62	10.49 180.15	7.80 95.13	Mag Phase
241	-81.78	2533.54	1538.25 242.93	273.45 203.05	1140.22 51.39	390.91 121.69	108.74 349.25	82.72 270.92	92.69 45.49	44.79 199.46	12.44 266.54	12.23 129.71	Mag Phase
242	-56.82	1436.70	1009.73 216.16	181.22 130.15	230.06 351.15	499.61 130.52	18.93 328.32	34.33 319.02	21.15 68.66	33.39 216.69	19.16 222.31	15.33 175.69	Mag Phase
243	-40.97	728.44	288.25 206.17	33.86 20.58	270.39 210.81	459.14 141.54	7.29 76.96	21.14 350.15	8.30 15.90	20.66 286.49	12.69 267.45	8.51 204.26	Mag Phase

Table IV. - Continued

(p) Fixed-system strain-gage balance rolling moment, in-lbs.

Run 8

$\mu_{Nom} = 0.25$

POINT	MEAN	1/2P-P	1P	2P	3P	4P	5P	6P	7P	8P	9P	10P	
214	-42.87	307.46	77.33 40.66	93.11 340.32	107.95 60.95	106.19 72.53	48.80 108.82	45.58 244.72	16.85 259.16	18.47 207.75	3.25 76.55	1.61 225.55	Mag Phase
215	-85.61	335.90	107.63 101.88	54.10 18.14	88.57 101.27	151.83 85.48	71.50 114.54	51.02 249.51	27.43 250.98	32.89 223.17	4.81 159.50	4.26 336.77	Mag Phase
216	-176.69	576.51	378.88 169.82	42.94 109.93	157.96 149.74	182.37 77.47	46.45 122.49	40.95 250.83	29.17 232.30	35.51 194.47	11.46 266.03	6.86 312.58	Mag Phase
217	-236.85	1020.70	769.54 176.44	182.97 264.21	295.89 144.04	212.79 108.43	59.59 54.13	5.33 295.89	21.22 321.17	25.02 138.50	22.08 336.47	13.04 195.74	Mag Phase
218	-252.27	1202.47	877.67 182.93	169.05 297.01	399.80 145.32	215.93 122.56	55.64 35.12	29.10 115.65	33.68 45.29	26.45 131.21	30.50 25.15	25.01 244.00	Mag Phase
219	-177.78	760.25	518.93 157.77	171.00 193.39	266.38 172.23	201.60 70.21	20.98 137.26	49.21 243.93	12.95 239.14	21.44 196.66	16.16 264.87	14.93 307.73	Mag Phase
220	-75.81	300.02	84.67 110.63	75.23 359.22	95.34 94.33	141.64 84.87	52.04 121.65	61.81 261.21	20.34 257.52	33.79 230.18	3.81 171.42	2.29 52.96	Mag Phase
221	-1.41	272.05	58.51 43.12	121.83 343.56	84.23 50.16	74.41 72.13	40.39 96.07	42.90 240.52	6.00 210.16	17.62 202.53	4.27 82.03	0.42 301.65	Mag Phase
222	-26.74	263.06	97.09 94.33	120.41 358.49	35.30 68.07	103.52 79.22	59.01 104.02	54.62 248.06	28.43 248.89	39.54 202.86	3.81 121.69	5.32 58.15	Mag Phase
223	-99.99	632.49	356.08 149.43	27.90 146.60	230.59 186.47	151.24 82.53	51.65 123.32	63.66 243.08	21.60 253.89	24.13 225.88	2.44 203.01	14.68 270.68	Mag Phase



Table IV. - Continued

(p) Continued

Run 8

 $\mu_{\text{Nom}} = 0.25$ 

POINT	MEAN	1/2P-P	1P	2P	3P	4P	5P	6P	7P	8P	9P	10P	
224	-144.45	862.65	649.76 162.49	192.19 223.27	157.34 168.50	195.50 80.98	63.40 68.09	39.30 239.90	24.65 253.80	23.27 164.50	8.46 265.43	5.23 245.90	Mag Phase
225	-179.41	1042.22	843.30 177.90	145.54 293.92	306.31 136.74	175.81 116.31	61.10 25.29	34.24 138.32	18.95 8.75	31.22 143.06	27.04 1.66	24.06 223.99	Mag Phase
226	-208.25	1220.92	990.24 182.68	62.50 329.31	375.41 161.65	153.08 140.50	88.41 341.47	73.22 164.69	29.34 159.45	52.19 183.83	35.04 103.00	40.30 282.47	Mag Phase
227	-71.28	507.63	325.34 151.95	25.44 354.11	152.11 184.88	132.34 77.33	54.17 112.79	66.66 238.23	13.82 200.15	28.15 182.99	1.81 218.91	4.01 290.97	Mag Phase
228	3.42	254.28	75.35 91.34	123.23 1.24	12.32 355.10	103.49 72.90	37.87 91.30	61.11 239.62	23.72 246.15	41.03 188.69	4.83 117.48	4.17 45.39	Mag Phase
229	27.98	216.61	56.83 81.12	106.24 354.60	24.63 341.70	92.74 83.94	23.99 102.12	56.00 253.92	15.33 231.61	32.72 194.11	5.52 67.12	1.60 23.52	Mag Phase
230	-25.00	402.46	217.50 145.19	88.57 10.88	91.50 183.31	138.03 69.03	53.40 112.05	54.59 236.90	19.24 209.86	21.36 190.00	5.28 130.09	3.90 240.40	Mag Phase
231	-69.54	705.36	530.95 148.16	127.75 175.18	173.81 178.58	144.77 58.83	40.44 134.80	46.63 223.33	23.67 271.12	34.17 188.86	4.00 202.09	11.39 250.37	Mag Phase
232	-126.97	886.31	744.30 169.91	151.80 262.75	127.40 133.62	156.07 97.66	25.41 35.65	22.54 196.38	39.51 304.48	42.97 161.14	8.34 304.25	8.15 255.08	Mag Phase
233	-145.00	973.27	832.38 174.53	116.79 299.79	178.82 128.54	142.12 105.98	59.52 325.66	40.38 140.24	19.91 325.07	55.26 145.06	17.50 27.01	20.09 234.06	Mag Phase

Table IV. - Continued

(p) Concluded

Run 8

$\mu_{Nom} = 0.25$

POINT	MEAN	1/2P-P	1P	2P	3P	4P	5P	6P	7P	8P	9P	10P	
234	-29.33	401.52	218.29 138.75	86.69 343.81	86.42 175.38	135.08 63.29	43.15 105.88	55.81 225.00	5.25 221.02	26.96 182.96	3.39 94.75	0.77 248.20	Mag Phase
235	38.10	229.86	41.52 90.39	113.39 352.32	20.30 192.49	78.17 86.13	14.56 74.18	57.12 239.65	9.06 181.95	37.47 169.89	3.74 25.97	5.55 23.03	Mag Phase
236	-18.41	351.39	189.38 133.67	106.20 358.71	48.28 199.78	120.55 72.33	32.19 126.09	47.56 248.24	14.04 235.65	32.13 207.09	3.11 138.91	2.40 29.61	Mag Phase
237	-56.88	603.83	381.29 142.55	13.55 248.75	200.21 175.38	118.80 55.85	38.81 127.78	53.32 222.54	10.05 200.25	35.93 167.36	3.00 114.36	4.73 213.02	Mag Phase
238	-107.98	850.56	665.72 157.06	160.58 219.49	114.95 186.60	168.26 73.32	9.15 160.65	50.57 227.72	29.40 272.01	34.06 188.82	6.30 151.55	8.83 268.34	Mag Phase
239	-134.17	920.01	755.25 164.10	130.50 251.23	21.41 89.67	139.33 84.13	24.99 320.31	34.09 212.18	40.75 287.33	45.85 163.74	6.56 213.14	15.45 266.66	Mag Phase
240	-165.76	971.44	846.47 169.96	94.99 292.79	89.49 76.65	111.61 92.83	45.34 306.46	36.39 177.31	30.84 292.50	59.61 171.57	0.51 28.10	17.09 251.08	Mag Phase
241	-212.02	1085.91	982.32 174.79	60.89 329.91	107.07 106.11	116.80 112.69	91.85 300.80	55.03 164.29	17.89 251.22	66.79 180.22	19.14 105.54	21.86 277.89	Mag Phase
242	-115.94	794.68	630.21 156.09	122.71 216.24	129.49 189.55	155.35 68.01	13.90 194.09	49.86 224.35	25.80 264.36	36.98 170.06	6.82 201.33	6.48 288.79	Mag Phase
243	-39.61	332.80	170.37 138.43	102.32 341.13	52.48 153.60	111.81 70.19	30.74 104.46	50.98 229.58	13.50 229.45	37.72 194.98	1.96 115.15	3.74 342.93	Mag Phase

Table IV. - Continued

(q) Fixed-system strain-gage balance yawing moment, in-lbs

Run 8

$\mu_{Nom.} = 0.25$

POINT	MEAN	1/2P-P	1P	2P	3P	4P	5P	6P	7P	8P	9P	10P	
214	301.03	121.06	46.46 262.00	7.04 167.59	26.65 243.79	29.77 146.66	38.50 128.91	29.33 11.00	0.95 350.30	4.40 5.39	1.37 16.21	0.88 188.65	Mag Phase
215	408.78	219.98	68.28 294.30	7.23 130.48	15.99 284.52	147.71 118.89	67.05 124.43	7.71 51.63	3.38 359.48	11.33 310.56	2.14 319.17	1.70 317.38	Mag Phase
216	647.76	387.49	111.61 321.89	20.15 70.08	22.12 303.38	250.01 74.58	83.70 169.28	19.26 31.51	19.63 62.12	11.65 265.48	4.15 293.98	4.03 308.52	Mag Phase
217	845.79	495.47	149.47 333.71	16.01 57.70	62.30 338.33	294.37 345.90	146.89 143.18	9.95 34.74	19.07 32.29	9.91 284.51	1.14 101.36	7.76 227.77	Mag Phase
218	950.87	665.44	170.77 345.14	20.88 354.13	89.09 334.42	438.20 342.98	168.08 158.87	10.58 106.72	28.09 34.25	16.41 290.69	8.09 98.33	14.54 238.27	Mag Phase
219	654.77	414.47	55.31 324.86	43.41 41.35	48.77 350.45	221.43 42.73	173.75 155.87	38.61 26.98	21.53 7.60	16.45 250.26	8.78 243.56	7.82 260.61	Mag Phase
220	402.48	219.76	68.55 292.89	9.06 119.36	14.75 251.65	148.54 112.17	53.17 128.46	19.63 22.24	6.97 280.48	9.07 330.76	1.12 39.82	0.98 69.31	Mag Phase
221	305.36	103.44	24.74 256.61	7.77 147.68	16.15 230.97	44.80 133.95	39.00 117.70	17.60 337.20	1.54 312.73	9.06 358.03	0.73 48.81	0.53 335.35	Mag Phase
222	428.44	174.24	42.15 274.44	5.72 125.65	5.90 243.02	107.58 112.99	57.64 113.52	14.29 67.57	5.12 55.75	10.23 340.37	0.66 12.05	2.15 17.89	Mag Phase
223	650.74	427.53	47.92 299.12	31.22 31.19	31.50 16.53	241.67 53.24	165.73 144.78	60.69 30.04	24.92 37.47	11.13 261.33	5.11 243.43	9.95 267.92	Mag Phase

Table IV. - Continued

(q) Continued

Run 8

 $\mu_{\text{Nom.}} = 0.25$ 

POINT	MEAN	1/2P-P	1P	2P	3P	4P	5P	6P	7P	8P	9P	10P	
224	826.24	371.56	90.21 321.98	22.15 26.58	43.25 3.52	206.62 0.31	135.52 133.56	34.60 30.49	26.76 29.77	14.78 273.13	0.99 33.77	8.09 237.56	Mag Phase
225	1041.55	645.59	161.18 342.55	22.38 344.25	83.12 326.35	442.82 335.98	162.06 152.74	30.03 24.91	34.17 37.25	16.88 267.15	8.30 98.39	16.41 214.84	Mag Phase
226	1174.65	739.19	194.91 355.93	68.23 4.02	101.62 335.85	529.48 352.49	44.71 215.98	26.54 332.58	26.89 68.01	15.60 314.21	16.81 146.95	25.09 261.36	Mag Phase
227	652.35	413.30	55.76 310.65	20.15 27.41	13.72 9.51	254.34 53.39	143.41 142.80	61.25 34.69	19.28 32.41	8.53 281.36	3.88 245.54	5.62 251.40	Mag Phase
228	423.60	222.32	36.33 287.69	5.22 184.91	4.81 188.31	152.44 100.48	53.47 94.11	20.08 10.64	5.40 333.73	12.07 346.17	2.37 64.20	2.68 16.88	Mag Phase
229	431.53	161.92	37.63 279.29	4.09 153.12	5.30 205.52	90.46 116.24	45.43 100.60	19.72 26.57	5.67 335.98	6.92 18.00	0.51 48.84	1.39 39.07	Mag Phase
230	643.14	314.29	63.52 293.97	1.34 152.47	5.20 59.79	205.80 57.25	85.47 132.01	30.20 41.11	11.30 49.63	4.80 242.02	2.62 230.77	4.09 252.49	Mag Phase
231	801.83	376.51	46.35 314.60	32.22 12.41	34.28 357.17	205.94 39.83	161.34 142.73	39.06 15.43	23.06 1.07	10.81 249.20	4.31 203.83	8.49 231.75	Mag Phase
232	1013.95	500.89	111.04 329.43	19.83 354.17	41.48 341.34	364.93 336.19	125.12 140.48	50.23 351.72	27.52 39.26	10.43 283.32	3.89 86.96	6.45 246.55	Mag Phase
233	1137.67	634.31	148.15 344.77	33.08 340.46	60.62 317.10	487.16 332.33	106.46 149.81	44.29 350.35	32.96 42.62	9.36 304.45	10.20 78.83	12.39 212.09	Mag Phase

Table IV. - Continued

(q) Concluded

Run 8

$\mu_{\text{Nom.}} = 0.25$

POINT	MEAN	1/2P-P	1P	2P	3P	4P	5P	6P	7P	8P	9P	10P	
234	645.31	323.91	47.96 312.87	2.97 72.26	11.64 17.89	231.69 49.17	94.05 130.28	35.75 14.26	10.39 12.87	4.80 271.20	3.56 261.92	3.28 195.75	Mag Phase
235	414.23	138.55	36.51 269.37	8.35 212.31	5.41 314.08	80.52 96.61	30.58 76.81	27.34 334.69	4.56 338.20	6.36 32.37	0.63 5.82	3.82 359.86	Mag Phase
236	631.38	235.32	35.87 306.80	5.53 207.07	8.14 89.89	170.50 66.45	73.55 130.28	22.18 38.77	6.04 29.95	2.06 333.06	1.88 261.05	0.64 17.43	Mag Phase
237	785.58	356.90	36.33 318.56	10.67 42.14	35.65 358.12	218.03 18.76	148.42 128.08	47.86 8.65	15.55 342.03	3.64 168.62	1.93 180.58	3.76 215.70	Mag Phase
238	975.63	340.22	68.48 323.53	20.91 28.35	42.96 12.01	209.08 357.76	116.78 140.15	40.00 356.94	18.38 40.07	4.20 287.94	1.89 112.94	8.87 253.31	Mag Phase
239	1100.14	471.02	114.67 337.53	25.02 341.21	18.71 345.78	327.52 334.69	118.55 137.75	41.00 333.74	20.26 31.34	3.97 254.65	1.56 145.72	10.44 261.01	Mag Phase
240	1215.73	577.79	131.67 339.76	36.53 341.04	33.05 313.51	433.49 340.06	106.79 146.97	47.18 344.49	28.79 63.24	2.64 334.75	8.40 101.08	8.93 242.14	Mag Phase
241	1346.94	658.52	168.33 353.84	62.91 347.61	61.35 313.54	514.37 350.38	49.23 197.98	29.23 348.81	33.87 80.00	9.12 4.72	14.22 134.91	13.79 250.82	Mag Phase
242	978.88	342.47	73.32 328.25	19.41 12.86	42.18 10.34	212.12 353.12	117.37 136.89	43.32 348.08	10.80 36.95	13.12 226.81	1.48 179.03	7.77 244.17	Mag Phase
243	633.63	216.27	47.86 295.81	10.35 166.03	3.08 357.92	152.58 54.67	58.74 117.18	20.55 3.40	5.14 294.30	4.77 52.77	3.81 243.67	1.22 243.86	Mag Phase

Table IV. - Continued

(r) Fixed-system strain-gage balance side force, lbs

Run 8

$\mu_{Nom.} = 0.25$

POINT	MEAN	1/2P-P	1P	2P	3P	4P	5P	6P	7P	8P	9P	10P	
214	-2.24	18.73	0.92 319.55	2.84 324.68	2.69 43.52	6.29 73.25	5.33 115.55	4.87 210.79	1.30 197.99	1.72 162.93	1.30 113.59	0.28 49.24	Mag Phase
215	-4.54	28.89	1.16 96.30	1.22 24.81	2.50 83.29	12.92 84.78	9.31 112.99	4.07 208.75	2.03 199.32	2.47 203.87	0.79 183.49	0.34 96.27	Mag Phase
216	-8.47	32.44	8.80 182.42	3.00 111.33	4.60 138.16	20.40 57.74	7.26 134.47	4.23 214.34	2.69 189.64	1.03 152.95	1.60 173.03	0.52 82.32	Mag Phase
217	-10.75	40.04	19.43 180.38	7.32 251.27	8.97 133.60	14.70 10.13	9.83 103.35	3.51 189.99	0.53 218.16	3.73 55.44	1.37 173.69	0.51 226.87	Mag Phase
218	-11.37	42.81	22.03 185.05	7.42 288.64	12.57 138.69	17.17 356.57	7.50 111.84	3.02 164.49	2.06 106.10	3.70 59.15	1.66 120.69	0.33 247.20	Mag Phase
219	-8.69	40.73	16.56 160.05	6.11 174.38	7.55 163.89	21.62 37.64	9.29 149.33	6.16 197.53	2.35 159.12	0.27 148.55	1.68 159.19	0.97 89.70	Mag Phase
220	-4.65	25.93	0.84 178.56	2.27 352.06	2.92 85.98	13.40 81.08	7.04 114.80	5.64 227.07	1.77 217.51	2.60 191.89	1.04 191.39	0.84 43.65	Mag Phase
221	-1.75	14.56	0.55 78.07	4.07 334.81	2.14 38.18	4.84 86.87	4.41 103.29	3.74 207.24	0.56 163.70	1.59 165.60	0.72 88.84	0.33 67.86	Mag Phase
222	-3.53	22.32	2.19 130.79	4.46 347.70	1.29 59.42	8.99 80.51	7.35 97.92	3.88 213.38	2.41 210.00	3.42 171.65	1.09 162.81	0.22 131.09	Mag Phase
223	-6.87	33.75	11.51 157.22	1.38 69.45	6.37 175.29	18.46 46.61	11.26 134.93	7.07 198.23	2.49 204.94	0.71 174.18	1.59 175.96	1.23 83.77	Mag Phase

Table IV. - Continued

(r) Continued

Run 8

 $\mu_{\text{Nom.}} = 0.25$ 

POINT	MEAN	1/2P-P	1P	2P	3P	4P	5P	6P	7P	8P	9P	10P	
224	-8.55	45.58	19.34 165.86	8.35 213.19	4.11 152.97	16.27 18.65	10.21 87.34	5.03 180.22	2.77 204.87	1.83 78.69	2.10 129.35	0.26 357.02	Mag Phase
225	-10.34	39.84	21.78 180.35	6.70 280.31	9.27 133.28	17.93 341.79	6.25 79.83	5.30 148.51	2.31 161.46	2.65 61.09	2.02 106.70	0.21 331.60	Mag Phase
226	-11.11	48.82	24.40 183.42	4.44 337.58	12.27 164.24	19.65 349.24	8.07 346.15	7.03 151.77	5.28 180.57	2.36 147.61	3.59 123.13	1.88 2.89	Mag Phase
227	-6.62	31.55	9.85 161.10	1.83 350.33	4.25 175.60	18.58 44.38	9.56 122.58	7.76 203.84	2.54 170.83	1.59 131.83	1.27 160.46	1.13 42.54	Mag Phase
228	-3.37	21.89	1.59 126.76	4.40 349.66	0.28 7.23	11.25 75.95	5.75 83.34	5.44 205.69	1.70 200.63	3.51 159.79	1.39 143.74	0.45 34.78	Mag Phase
229	-2.63	16.70	0.64 165.07	3.60 335.64	0.73 312.53	8.31 87.11	3.95 97.89	5.38 223.90	1.04 174.78	3.47 162.38	0.65 93.43	0.31 75.19	Mag Phase
230	-5.16	28.43	6.56 170.72	3.29 356.40	2.46 172.88	16.61 45.10	7.88 112.31	5.54 203.02	2.12 202.41	1.72 150.25	1.20 149.08	0.34 35.38	Mag Phase
231	-7.08	38.53	17.57 151.22	4.53 164.77	4.77 171.17	18.05 26.05	9.31 130.10	5.11 182.28	2.32 194.72	1.81 163.03	1.24 112.44	1.15 50.15	Mag Phase
232	-8.95	42.95	21.19 175.81	7.20 252.55	3.65 126.39	18.01 346.26	5.50 89.07	5.69 158.27	2.33 226.32	3.29 136.96	1.11 107.65	0.10 16.14	Mag Phase
233	-9.56	44.75	22.36 176.63	6.19 288.58	5.56 132.01	21.21 334.25	2.55 343.29	5.80 134.09	2.64 177.58	4.17 112.47	1.88 81.24	0.20 9.59	Mag Phase

Table IV. - Continued

(r) Concluded

Run 8

$\mu_{Nom.} = 0.25$

POINT	MEAN	1/2P-P	1P	2P	3P	4P	5P	6P	7P	8P	9P	10P	
234	-5.28	29.66	6.62 147.44	4.03 324.61	2.10 158.99	17.86 39.57	6.84 109.69	6.77 195.40	1.32 183.24	1.95 153.05	1.06 147.41	0.71 346.57	Mag Phase
235	-1.71	15.57	1.20 193.83	3.69 324.37	0.57 184.80	7.59 81.37	2.75 67.62	5.25 204.81	1.22 151.42	4.09 133.72	0.39 49.10	0.42 96.46	Mag Phase
236	-3.84	24.83	6.39 145.93	4.21 343.64	1.22 191.46	14.28 52.98	5.61 122.05	4.46 208.67	1.87 215.62	1.87 180.82	0.73 165.25	0.35 327.34	Mag Phase
237	-5.44	34.56	12.69 146.06	1.15 237.54	5.19 168.86	17.09 13.62	9.39 125.29	5.94 181.57	1.38 156.97	2.02 132.67	0.52 142.66	0.72 19.25	Mag Phase
238	-7.27	44.65	20.91 161.22	7.22 210.05	2.71 177.66	16.86 10.93	4.44 120.18	6.46 184.19	2.64 233.29	2.29 157.15	0.70 155.00	0.64 52.88	Mag Phase
239	-7.94	43.74	21.12 166.31	6.67 248.33	0.55 109.13	18.49 343.33	2.44 76.08	5.84 168.60	2.31 233.84	3.91 144.71	0.40 145.83	0.53 62.75	Mag Phase
240	-9.13	48.18	23.35 172.33	5.59 285.79	1.69 78.49	22.30 340.47	0.73 340.74	6.12 148.85	3.28 212.77	4.74 151.34	1.13 105.31	0.44 275.11	Mag Phase
241	-10.24	54.25	26.15 173.92	5.21 321.24	1.95 138.68	23.07 350.45	7.82 295.74	6.66 144.10	5.11 203.22	5.64 159.82	2.71 115.20	1.23 315.42	Mag Phase
242	-7.19	40.40	18.71 160.33	5.40 210.06	3.41 181.56	16.83 4.51	4.26 133.96	6.79 184.66	1.97 218.42	2.76 135.14	0.76 161.00	0.52 33.51	Mag Phase
243	-3.81	23.85	5.29 163.06	3.78 314.05	1.40 144.64	13.28 46.26	5.10 99.96	5.88 198.30	1.35 167.13	2.19 154.00	0.48 176.49	0.62 14.53	Mag Phase



Table IV. - Continued

(s) Pitch link load, blade 1, lbs

Run 8

$\mu_{Nom.} = 0.25$

POINT	MEAN	1/2P-P	1P	2P	3P	4P	5P	6P	7P	8P	9P	10P	
214	4.16	4.88	3.97 18.32	0.52 226.27	0.52 224.51	0.32 84.15	0.51 199.71	0.40 153.44	0.32 94.52	0.12 15.91	0.09 215.46	0.04 195.71	Mag Phase
215	6.03	6.30	4.87 22.99	1.41 139.19	0.78 338.50	1.14 155.51	0.08 165.91	0.48 115.15	0.37 58.92	0.33 349.39	0.17 146.19	0.07 153.92	Mag Phase
216	7.95	9.38	6.18 23.76	3.79 92.62	3.45 338.10	2.71 226.42	1.28 260.33	0.78 268.46	0.77 348.12	0.98 315.88	0.35 250.23	0.05 305.23	Mag Phase
217	8.91	15.80	7.75 19.54	6.42 60.56	7.34 319.16	5.92 228.99	1.51 276.25	1.72 254.11	1.28 321.96	1.46 287.67	0.76 244.55	0.27 277.85	Mag Phase
218	8.98	18.58	8.62 20.02	7.66 52.73	8.29 315.34	7.04 233.90	1.44 288.36	2.48 255.31	1.80 324.58	1.76 279.74	0.94 244.97	0.24 297.47	Mag Phase
219	8.12	9.74	6.34 22.83	4.03 88.33	3.78 331.15	2.99 218.99	1.18 260.63	0.85 255.44	0.81 336.06	0.95 303.65	0.34 229.27	0.03 319.48	Mag Phase
220	6.24	6.31	4.93 26.29	1.38 140.72	0.73 342.61	1.15 160.24	0.15 270.10	0.51 124.44	0.35 61.87	0.25 11.52	0.20 165.12	0.08 171.73	Mag Phase
221	3.33	4.98	3.79 22.27	0.66 330.05	1.28 249.78	0.43 141.09	0.36 245.01	0.27 170.76	0.21 115.77	0.13 109.00	0.08 190.46	0.06 209.00	Mag Phase
222	5.14	6.22	4.81 25.41	0.59 97.30	1.03 286.70	1.19 144.91	0.38 293.03	0.33 132.56	0.10 74.47	0.20 10.35	0.14 153.49	0.12 121.93	Mag Phase
223	7.23	8.77	5.98 25.64	3.14 94.22	3.01 332.51	2.25 208.92	0.94 305.11	0.46 241.17	0.46 320.18	0.56 336.61	0.16 245.89	0.10 91.97	Mag Phase

Table IV. - Continued

(s) Continued

Run 8

 $\mu_{\text{Nom.}} = 0.25$ 

POINT	MEAN	1/2P-P	1P	2P	3P	4P	5P	6P	7P	8P	9P	10P	
224	8.29	12.68	6.90 24.43	5.20 65.62	5.87 314.81	4.56 216.31	1.37 303.04	1.08 243.99	0.97 302.63	0.99 293.26	0.45 216.83	0.05 249.83	Mag Phase
225	8.68	17.87	8.43 22.57	7.39 44.68	8.55 306.46	6.90 223.56	2.41 319.74	2.33 247.29	2.28 314.55	1.58 282.56	0.65 246.70	0.22 315.66	Mag Phase
226	8.57	19.15	9.60 22.41	8.07 44.09	8.56 305.65	5.59 230.13	4.02 334.74	1.98 306.62	2.85 344.87	1.57 312.07	0.40 292.42	0.13 31.18	Mag Phase
227	7.36	8.76	6.00 25.62	3.09 92.88	2.92 330.11	2.14 203.63	1.01 298.33	0.34 228.23	0.49 324.17	0.56 329.13	0.19 228.91	0.10 89.95	Mag Phase
228	5.29	6.08	4.79 25.15	0.53 103.90	0.88 279.80	1.09 135.78	0.43 269.96	0.34 129.44	0.16 64.02	0.21 13.12	0.16 130.32	0.11 115.70	Mag Phase
229	4.27	5.93	4.63 27.38	0.35 70.61	1.21 270.46	0.97 127.46	0.64 287.43	0.21 155.93	0.13 115.07	0.10 32.98	0.09 177.81	0.09 202.32	Mag Phase
230	6.39	7.77	5.76 25.30	2.35 88.26	2.18 325.77	1.32 167.87	0.83 302.12	0.17 188.32	0.17 308.25	0.35 348.17	0.12 226.91	0.03 118.96	Mag Phase
231	7.46	9.95	6.50 26.36	3.81 75.12	3.58 316.80	2.39 193.79	1.30 304.81	0.56 219.83	0.36 289.31	0.43 315.39	0.26 245.32	0.09 136.94	Mag Phase
232	8.51	15.24	7.58 25.69	6.14 50.94	6.99 306.07	4.97 210.44	1.96 307.23	1.41 241.02	1.12 292.62	0.80 300.89	0.24 255.23	0.16 263.07	Mag Phase
233	8.56	17.98	8.48 21.44	7.38 37.19	8.43 296.06	5.81 208.63	3.23 295.07	2.14 248.76	2.06 301.09	1.05 297.62	0.28 268.43	0.14 269.53	Mag Phase

Table IV. - Continued

(s) Concluded

Run 8

$\mu_{Nom.} = 0.25$

POINT	MEAN	1/2P-P	1P	2P	3P	4P	5P	6P	7P	8P	9P	10P	
234	6.31	7.73	5.78 24.78	2.32 85.64	2.14 321.77	1.42 166.26	0.76 301.39	0.23 185.95	0.14 314.35	0.36 340.89	0.09 226.08	0.04 95.13	Mag Phase
235	3.33	5.61	4.51 23.92	0.18 89.34	1.01 254.38	0.94 98.38	0.79 266.82	0.19 144.81	0.10 115.99	0.07 34.15	0.07 182.72	0.09 188.15	Mag Phase
236	5.29	6.93	5.49 26.84	1.86 99.32	1.53 325.30	0.98 145.82	0.64 296.18	0.21 152.74	0.03 12.38	0.19 11.13	0.09 230.02	0.08 133.01	Mag Phase
237	6.37	8.81	6.23 22.16	3.13 80.71	2.78 320.07	1.61 170.04	1.15 296.85	0.33 217.86	0.27 299.76	0.34 323.79	0.14 239.72	0.06 94.57	Mag Phase
238	7.52	11.57	7.06 24.71	4.44 69.67	4.48 313.84	2.72 202.14	1.79 296.56	0.76 253.99	0.46 289.63	0.46 316.84	0.23 250.60	0.03 207.55	Mag Phase
239	8.14	14.01	7.58 23.66	5.59 52.66	6.42 303.77	3.84 208.11	2.17 288.89	1.39 243.83	0.91 281.62	0.71 296.72	0.31 263.80	0.14 217.51	Mag Phase
240	8.37	17.09	8.37 20.81	6.90 38.89	8.09 298.02	5.00 210.19	2.95 284.56	2.16 249.42	1.79 292.22	1.15 295.92	0.35 283.97	0.15 259.58	Mag Phase
241	8.31	20.32	9.18 19.29	7.80 35.99	8.19 298.44	4.63 214.54	4.85 297.85	3.34 293.83	3.06 323.87	1.76 327.01	0.60 324.94	0.12 295.39	Mag Phase
242	7.60	11.61	7.04 24.63	4.45 68.30	4.39 310.34	2.61 199.39	1.83 288.31	0.86 245.30	0.46 279.23	0.48 303.53	0.26 236.60	0.04 178.35	Mag Phase
243	5.25	6.87	5.44 25.62	1.95 100.25	1.54 317.97	1.01 138.99	0.58 286.58	0.21 128.31	0.06 10.05	0.23 351.23	0.08 215.27	0.08 136.32	Mag Phase

Table IV. - Continued

(t) Pitch link load, blade 2, lbs

Run 8

$\mu_{Nom.} = 0.25$

POINT	MEAN	1/2P-P	1P	2P	3P	4P	5P	6P	7P	8P	9P	10P	
214	6.06	10.00	9.69 269.20	1.74 325.37	0.14 2.44	1.72 149.44	0.59 62.18	0.52 322.26	0.30 277.84	0.13 226.22	0.23 11.15	0.31 205.64	Mag Phase
215	7.25	11.77	10.70 272.60	3.29 319.01	1.58 126.67	1.23 152.38	0.58 20.13	0.47 319.43	0.20 245.88	0.46 337.22	0.08 91.45	0.44 237.28	Mag Phase
216	8.02	15.33	13.01 281.46	5.21 281.10	3.00 63.78	2.84 181.93	1.35 210.96	0.79 48.65	0.52 1.40	1.14 304.41	0.47 181.95	0.39 196.22	Mag Phase
217	7.30	19.38	14.08 280.33	4.61 255.86	4.26 43.25	2.29 176.19	4.57 222.30	1.50 232.89	0.33 293.33	1.06 295.27	0.64 188.67	0.42 162.87	Mag Phase
218	6.21	24.23	14.81 281.74	3.30 241.36	4.04 5.43	4.17 145.42	6.60 244.30	5.88 266.10	2.08 242.54	0.25 276.44	0.29 130.03	0.54 253.44	Mag Phase
219	7.19	14.41	11.45 279.80	5.18 276.54	3.59 63.48	2.76 186.36	1.26 199.06	0.89 38.14	0.54 351.36	1.15 281.92	0.47 161.30	0.25 173.07	Mag Phase
220	5.61	10.97	10.26 283.91	3.61 315.41	1.68 150.72	1.42 162.46	0.76 41.76	0.78 0.89	0.11 254.06	0.53 340.55	0.03 267.79	0.48 260.30	Mag Phase
221	1.30	9.44	8.16 282.64	1.22 263.41	0.99 325.46	2.12 145.52	0.48 99.23	0.49 320.81	0.24 298.11	0.21 207.03	0.12 333.34	0.16 164.36	Mag Phase
222	3.27	10.30	9.45 283.34	2.28 297.07	0.61 31.94	2.10 160.27	0.39 45.31	0.52 345.26	0.09 213.33	0.43 298.75	0.13 349.98	0.31 226.48	Mag Phase
223	5.47	12.92	10.22 285.73	4.73 277.71	3.28 51.67	3.46 181.42	0.51 210.45	0.70 353.25	0.29 14.48	0.91 289.80	0.26 146.69	0.29 205.76	Mag Phase

Table IV. - Continued

(t) Continued

Run 8

$\mu_{\text{Nom.}} = 0.25$

POINT	MEAN	1/2P-P	1P	2P	3P	4P	5P	6P	7P	8P	9P	10P	
224	5.92	17.38	12.38 285.49	4.55 245.14	4.05 21.45	3.89 172.44	3.01 202.96	0.43 311.32	0.64 353.42	1.24 258.70	0.52 148.91	0.32 162.29	Mag Phase
225	4.90	24.93	14.90 287.07	3.56 230.72	4.67 1.72	3.80 156.72	6.33 239.42	5.20 267.30	1.39 264.83	0.84 243.54	0.47 124.42	0.41 251.71	Mag Phase
226	3.99	32.46	15.48 292.82	4.01 190.13	8.29 354.40	7.22 173.82	4.39 288.63	10.20 332.00	4.87 326.52	1.58 232.81	1.20 123.27	1.04 14.28	Mag Phase
227	5.20	12.63	10.29 287.55	4.72 277.33	3.03 54.45	3.29 179.35	0.62 223.21	0.58 356.78	0.26 22.60	0.83 282.38	0.22 140.07	0.26 210.18	Mag Phase
228	3.64	10.47	9.79 286.33	2.47 298.40	0.68 53.52	2.25 160.96	0.36 23.58	0.58 355.26	0.07 254.68	0.48 302.11	0.10 358.13	0.36 222.63	Mag Phase
229	1.95	10.53	9.91 295.00	2.26 296.81	0.46 5.98	2.12 155.03	0.20 10.05	0.64 6.24	0.20 263.03	0.32 320.80	0.01 15.52	0.29 249.95	Mag Phase
230	3.52	11.55	9.90 290.90	4.30 275.69	2.67 52.28	2.73 169.76	0.67 244.48	0.62 357.68	0.14 323.32	0.65 288.91	0.09 150.63	0.19 215.92	Mag Phase
231	4.30	14.94	10.85 291.40	5.01 254.35	4.47 34.66	4.01 179.38	1.19 241.47	1.21 353.65	0.50 341.80	0.78 252.19	0.24 126.70	0.06 203.26	Mag Phase
232	4.68	18.84	13.13 291.17	4.11 233.26	5.11 16.86	4.16 179.44	3.93 230.22	1.55 325.69	1.09 346.03	0.74 262.50	0.45 163.39	0.08 164.45	Mag Phase
233	4.07	23.74	14.13 288.31	3.54 206.39	5.78 353.71	4.71 157.78	5.31 244.94	4.73 291.71	1.70 297.45	0.31 193.08	0.38 115.35	0.41 294.25	Mag Phase

Table IV. - Continued

(t) Concluded

Run 8

$\mu_{Nom.} = 0.25$

POINT	MEAN	1/2P-P	1P	2P	3P	4P	5P	6P	7P	8P	9P	10P	
234	3.53	11.68	9.77 284.89	4.10 276.24	2.85 40.94	2.61 167.17	0.74 243.73	0.59 355.07	0.13 327.47	0.60 282.56	0.13 125.47	0.14 220.81	Mag Phase
235	-0.31	9.71	8.75 290.17	2.21 288.75	1.17 22.28	1.96 155.65	0.59 325.70	0.60 1.96	0.32 242.74	0.16 318.77	0.05 132.95	0.16 238.63	Mag Phase
236	1.51	11.49	9.50 290.04	4.12 291.29	2.64 53.78	2.39 169.02	0.99 284.08	0.42 15.29	0.12 295.29	0.44 320.09	0.06 142.31	0.18 224.23	Mag Phase
237	2.49	13.18	10.01 289.68	5.33 270.83	4.08 44.48	3.35 171.87	1.14 249.19	0.84 12.69	0.18 345.24	0.54 265.18	0.15 102.45	0.13 222.20	Mag Phase
238	3.83	15.58	11.59 290.91	4.40 254.95	4.97 34.40	4.58 182.50	1.87 245.28	1.74 12.26	0.69 353.53	0.73 258.50	0.21 141.39	0.02 321.19	Mag Phase
239	3.98	17.55	12.57 290.73	3.79 237.46	5.53 24.06	5.00 183.14	3.13 239.36	2.34 3.28	1.37 1.87	0.69 246.93	0.36 179.56	0.09 11.11	Mag Phase
240	3.81	21.16	13.49 291.18	3.56 212.91	6.26 12.11	4.89 181.58	4.30 246.20	3.61 333.60	1.95 345.91	0.46 222.42	0.49 173.81	0.35 333.84	Mag Phase
241	3.15	30.50	15.30 296.05	4.33 187.64	8.02 356.17	7.02 172.40	4.45 294.86	9.61 336.16	3.98 329.33	1.15 195.93	0.69 133.35	0.99 352.10	Mag Phase
242	3.74	16.06	11.36 291.45	4.74 251.02	5.21 29.52	4.69 180.58	1.88 246.27	2.04 5.31	0.78 354.10	0.74 250.53	0.16 143.34	0.02 186.81	Mag Phase
243	1.68	10.99	9.01 291.55	4.52 279.53	2.67 48.17	2.38 164.53	0.96 266.72	0.42 2.36	0.14 279.13	0.50 310.07	0.07 138.53	0.16 207.50	Mag Phase

Table IV. - Continued

(u) Pitch link load, blade 3, lbs

Run 8

$\mu_{Nom.} = 0.25$

POINT	MEAN	1/2P-P	1P	2P	3P	4P	5P	6P	7P	8P	9P	10P	
214	5.75	6.13	4.85 186.24	0.41 46.82	1.62 66.54	1.02 129.66	0.69 51.69	0.94 170.57	0.03 230.82	0.17 303.56	0.07 345.93	0.12 94.73	Mag Phase
215	8.19	7.50	5.92 186.63	1.46 103.27	1.83 92.83	2.08 141.91	1.11 107.44	0.56 158.07	0.16 83.54	0.60 336.29	0.07 254.83	0.15 83.74	Mag Phase
216	10.27	10.14	7.42 185.60	3.29 78.82	2.71 92.76	2.26 139.22	1.85 80.33	0.69 318.68	0.78 144.66	1.18 337.05	0.20 156.05	0.18 39.96	Mag Phase
217	10.74	15.40	8.54 184.23	5.22 62.21	3.44 113.91	1.15 223.33	2.81 86.16	3.38 306.79	2.32 147.60	2.04 326.21	0.67 142.34	0.53 351.42	Mag Phase
218	10.85	18.74	9.19 185.56	5.83 63.19	3.53 132.29	2.76 281.51	2.24 88.03	5.00 310.43	3.12 156.93	2.36 340.26	0.77 154.44	0.64 354.34	Mag Phase
219	10.60	9.73	7.42 183.97	3.19 77.17	2.83 86.54	2.23 127.16	1.89 85.36	0.89 314.81	0.86 142.21	1.16 327.31	0.25 161.88	0.21 21.32	Mag Phase
220	8.64	7.19	5.95 187.22	1.44 92.56	1.79 97.07	1.92 149.44	1.16 123.78	0.50 171.96	0.14 119.42	0.56 351.39	0.09 263.97	0.18 122.20	Mag Phase
221	5.05	6.63	4.46 188.20	1.07 16.59	2.06 72.05	1.01 145.97	0.62 11.93	0.81 183.06	0.09 15.78	0.09 300.53	0.07 25.73	0.11 79.33	Mag Phase
222	7.63	7.13	5.94 187.36	1.28 71.43	2.00 81.46	1.71 140.67	1.18 84.11	0.75 197.49	0.26 83.50	0.41 328.63	0.12 165.21	0.08 85.29	Mag Phase
223	9.86	9.99	7.39 185.25	2.71 76.36	3.36 88.09	2.29 142.82	2.17 88.08	0.30 291.93	0.56 113.75	0.74 326.76	0.08 162.29	0.08 113.06	Mag Phase

Table IV. - Continued

(u) Continued

Run 8

$\mu_{Nom.} = 0.25$

POINT	MEAN	1/2P-P	1P	2P	3P	4P	5P	6P	7P	8P	9P	10P	
224	10.75	12.13	8.14 185.36	3.95 61.67	4.51 95.99	1.90 178.01	2.73 77.02	2.12 280.06	1.46 121.63	1.31 308.82	0.47 111.63	0.18 331.41	Mag Phase
225	11.23	17.89	9.15 185.77	5.52 53.50	5.14 114.77	2.71 252.76	2.83 77.80	4.95 289.54	2.67 136.51	2.01 314.10	0.86 132.71	0.52 307.92	Mag Phase
226	11.24	24.50	10.76 183.51	4.79 53.55	3.01 105.68	2.41 347.78	4.31 87.72	8.20 328.54	4.94 183.17	2.56 352.88	0.94 158.13	0.86 311.13	Mag Phase
227	10.20	10.05	7.20 186.75	2.86 74.88	3.44 89.36	2.33 136.75	2.14 87.93	0.22 295.99	0.54 111.49	0.73 320.00	0.09 119.93	0.07 119.90	Mag Phase
228	8.03	7.39	6.06 186.61	1.40 61.24	2.06 78.17	1.73 138.52	1.25 89.85	0.63 184.72	0.27 78.05	0.47 324.25	0.15 167.70	0.11 83.80	Mag Phase
229	7.11	7.57	6.08 190.09	1.16 53.23	2.08 76.80	1.81 136.46	1.04 87.27	0.60 179.58	0.09 358.29	0.25 325.87	0.03 266.69	0.06 134.13	Mag Phase
230	9.52	10.16	7.41 184.73	2.33 75.81	3.32 84.49	2.34 135.28	1.86 79.66	0.19 213.34	0.31 92.16	0.57 296.32	0.07 337.72	0.07 142.60	Mag Phase
231	10.77	11.57	8.05 188.76	2.64 72.37	4.02 85.07	2.40 134.93	2.86 78.02	0.76 264.92	0.74 99.67	0.92 284.65	0.06 142.23	0.04 28.83	Mag Phase
232	11.40	14.70	9.03 188.51	4.13 49.27	5.37 103.63	1.96 205.03	3.44 69.79	3.40 283.90	1.83 123.46	1.48 307.19	0.58 133.25	0.25 317.06	Mag Phase
233	11.58	18.38	9.84 183.32	4.97 41.08	5.33 108.29	1.96 244.47	3.64 62.39	5.34 287.18	2.71 128.97	2.06 313.04	0.89 133.86	0.44 301.94	Mag Phase



Table IV. - Continued

(u) Concluded

Run 8

$\mu_{Nom.} = 0.25$

POINT	MEAN	1/2P-P	1P	2P	3P	4P	5P	6P	7P	8P	9P	10P	
234	9.63	10.25	7.51 183.71	2.47 72.90	3.42 81.82	2.29 131.17	1.84 79.22	0.19 241.49	0.25 78.18	0.64 292.48	0.09 342.24	0.07 144.73	Mag Phase
235	6.71	7.42	6.03 186.69	1.30 45.92	2.21 68.66	1.48 123.66	1.02 70.53	0.60 165.16	0.12 330.88	0.09 316.81	0.05 201.37	0.09 116.16	Mag Phase
236	8.55	9.37	7.35 183.56	1.98 82.47	2.93 89.39	1.94 130.49	1.45 88.41	0.12 239.58	0.23 103.90	0.39 310.25	0.01 344.90	0.04 153.62	Mag Phase
237	10.15	10.81	7.89 184.02	2.56 83.22	3.32 81.01	2.50 121.07	2.02 70.85	0.37 268.59	0.32 76.74	0.52 272.70	0.08 295.82	0.08 111.09	Mag Phase
238	11.25	12.24	8.70 186.95	3.10 66.51	3.93 97.05	2.05 139.47	2.99 71.02	1.33 279.64	0.72 94.57	0.81 291.53	0.17 132.59	0.06 356.55	Mag Phase
239	11.56	14.26	9.24 185.95	4.06 48.30	5.10 103.05	1.53 174.86	3.60 67.00	2.80 284.40	1.29 120.60	1.31 300.40	0.52 132.75	0.22 334.46	Mag Phase
240	11.50	17.22	9.84 183.46	4.99 38.76	5.65 105.64	1.14 218.25	4.24 65.97	4.34 293.25	2.33 132.64	1.92 312.93	0.90 148.61	0.37 338.85	Mag Phase
241	11.13	22.99	10.96 181.71	4.94 36.94	4.18 106.03	1.04 338.57	5.51 76.19	7.39 316.02	4.05 159.14	2.70 334.62	1.17 166.37	0.50 308.92	Mag Phase
242	11.42	12.48	8.69 186.52	3.26 63.02	3.87 94.41	2.09 134.33	3.15 65.07	1.57 272.76	0.67 101.85	0.84 284.48	0.16 131.36	0.03 337.13	Mag Phase
243	8.78	9.16	7.38 182.94	1.90 84.69	2.76 85.92	1.71 124.34	1.56 85.86	0.13 281.19	0.22 100.14	0.44 315.87	0.01 198.14	0.04 148.86	Mag Phase

Table IV. - Continued

(v) Pitch link load, blade 4, lbs

Run 8

$\mu_{Nom.} = 0.25$

POINT	MEAN	1/2P-P	1P	2P	3P	4P	5P	6P	7P	8P	9P	10P	
214	-4.65	8.30	3.73 180.36	1.68 263.43	2.09 124.04	1.70 165.27	0.51 36.66	1.50 53.99	0.37 35.02	0.58 38.99	0.09 339.87	0.40 341.15	Mag Phase
215	-2.85	6.44	3.33 208.17	3.36 303.53	0.35 301.65	0.96 186.29	0.54 240.63	0.66 60.68	0.28 17.68	0.48 47.25	0.06 283.60	0.31 350.35	Mag Phase
216	1.12	8.69	1.27 144.74	5.72 277.12	2.81 216.05	2.48 184.37	0.79 217.38	0.38 14.76	0.34 323.48	0.70 29.35	0.06 228.87	0.35 327.96	Mag Phase
217	3.00	10.16	2.00 159.14	6.29 274.59	2.75 204.10	4.03 159.69	0.66 310.10	0.92 334.88	0.32 284.94	1.08 0.74	0.05 73.08	0.37 303.47	Mag Phase
218	3.71	14.47	2.39 156.25	7.76 261.32	3.47 207.47	5.72 154.11	1.28 8.83	1.40 326.56	0.52 257.21	1.61 342.81	0.14 74.51	0.46 294.54	Mag Phase
219	1.78	8.38	0.98 149.87	5.70 273.98	2.55 221.81	2.08 188.81	1.00 213.62	0.60 14.19	0.32 297.76	0.63 7.51	0.10 236.12	0.31 314.90	Mag Phase
220	-2.41	7.29	2.86 221.30	4.13 287.22	0.81 272.36	1.16 223.44	0.69 241.62	0.66 63.14	0.19 38.72	0.35 45.40	0.09 267.74	0.26 354.26	Mag Phase
221	-5.99	8.76	3.65 203.38	2.36 253.34	1.69 142.94	1.35 166.23	0.71 356.22	1.43 44.70	0.29 48.44	0.49 8.09	0.14 18.62	0.29 323.94	Mag Phase
222	-3.83	7.45	3.19 206.52	3.17 288.23	1.12 205.35	1.69 192.27	0.40 190.22	0.80 75.90	0.17 88.72	0.41 48.06	0.03 241.14	0.26 331.50	Mag Phase
223	0.36	9.90	0.59 130.33	5.56 284.87	3.55 227.54	2.26 212.37	0.67 202.59	0.39 92.09	0.13 271.84	0.47 36.11	0.13 235.78	0.16 351.61	Mag Phase

Table IV. - Continued

(v) Continued

Run 8

$\mu_{\text{Nom.}} = 0.25$

POINT	MEAN	1/2P-P	1P	2P	3P	4P	5P	6P	7P	8P	9P	10P	
224	1.88	9.53	1.53 170.40	5.57 275.93	3.15 213.14	3.25 165.43	0.23 308.92	0.28 30.16	0.09 268.36	0.69 8.73	0.14 242.57	0.27 306.33	Mag Phase
225	3.13	16.29	2.34 147.96	9.48 246.36	4.28 205.36	5.36 159.73	1.77 24.45	1.08 314.07	0.47 220.29	1.43 333.93	0.14 25.75	0.35 268.91	Mag Phase
226	2.93	18.93	2.24 151.17	11.93 243.16	6.18 213.52	4.62 189.10	1.87 39.98	1.85 21.05	0.61 183.39	1.45 349.14	0.38 109.34	0.18 275.84	Mag Phase
227	0.43	10.39	0.55 148.82	5.52 278.30	3.88 223.46	2.47 202.98	0.77 199.15	0.45 68.51	0.06 192.24	0.52 18.44	0.06 222.80	0.14 321.42	Mag Phase
228	-2.62	8.11	2.10 230.83	4.74 260.09	2.24 221.83	2.01 207.87	0.62 180.79	0.64 63.40	0.20 121.80	0.24 29.22	0.13 187.03	0.15 297.68	Mag Phase
229	-3.57	8.15	1.89 215.12	4.28 261.78	2.42 213.99	2.18 208.77	0.54 164.31	0.93 86.36	0.30 122.33	0.28 59.04	0.10 166.55	0.14 351.92	Mag Phase
230	-0.69	11.17	0.69 152.00	5.25 279.18	4.16 220.21	2.78 197.43	0.84 175.31	0.64 100.03	0.09 152.72	0.39 26.26	0.08 119.11	0.04 329.69	Mag Phase
231	0.73	10.71	1.50 162.56	5.52 278.42	3.62 233.58	3.02 183.04	0.72 153.86	0.55 78.19	0.37 169.76	0.31 14.09	0.06 280.25	0.13 331.86	Mag Phase
232	1.69	13.36	2.44 140.31	7.25 258.10	3.55 218.21	4.96 168.37	1.05 68.22	0.49 28.49	0.35 184.17	0.57 356.57	0.05 320.95	0.35 291.32	Mag Phase
233	1.84	17.26	1.84 156.96	10.94 236.03	5.79 198.46	3.67 168.68	1.72 4.54	1.14 346.19	0.59 94.95	0.58 344.47	0.30 104.50	0.25 223.74	Mag Phase

Table IV. - Concluded

(v) Concluded

Run 8

 $\mu_{\text{Nom.}} = 0.25$ 

POINT	MEAN	1/2P-P	1P	2P	3P	4P	5P	6P	7P	8P	9P	10P	
234	-0.51	10.75	0.79 167.40	5.36 273.08	4.02 210.45	2.68 193.15	0.67 159.80	0.69 85.63	0.10 147.56	0.49 1.28	0.06 95.96	0.12 295.95	Mag Phase
235	-4.26	8.99	1.00 235.84	4.19 251.77	2.95 213.48	2.20 200.60	0.80 142.21	0.69 70.66	0.35 91.46	0.15 64.19	0.04 165.98	0.10 7.28	Mag Phase
236	-2.09	10.45	0.91 165.76	4.54 286.13	3.79 219.21	2.89 198.48	1.06 168.18	0.44 96.04	0.18 70.43	0.26 51.34	0.04 148.49	0.07 0.83	Mag Phase
237	-0.28	9.93	1.77 180.74	5.27 285.06	3.38 236.13	2.35 182.15	1.14 136.29	0.53 122.37	0.22 181.32	0.32 14.73	0.04 303.92	0.13 342.70	Mag Phase
238	0.76	11.52	2.16 135.81	6.45 266.46	3.48 236.07	3.42 181.15	1.12 112.35	0.74 100.82	0.42 165.23	0.29 8.82	0.15 285.01	0.33 320.14	Mag Phase
239	1.41	16.13	1.56 145.46	10.26 244.34	5.72 209.42	2.87 187.16	0.93 12.05	1.00 45.49	0.57 97.67	0.34 54.97	0.12 179.77	0.12 309.48	Mag Phase
240	1.32	17.21	2.58 113.59	10.12 243.84	6.30 204.17	4.25 173.89	1.20 21.89	0.93 16.62	0.48 106.12	0.48 10.67	0.09 97.96	0.21 236.84	Mag Phase
241	1.36	19.62	2.71 126.68	11.37 244.14	7.46 204.49	4.89 180.14	1.55 4.01	1.48 12.85	0.59 104.01	0.84 14.48	0.46 110.52	0.18 224.07	Mag Phase
242	1.03	13.96	1.75 129.73	8.20 252.45	4.68 222.59	3.43 183.63	0.94 104.01	0.85 71.16	0.46 154.37	0.30 4.39	0.20 289.89	0.22 295.35	Mag Phase
243	-1.55	10.50	1.27 164.72	4.64 279.93	3.82 211.03	3.11 187.94	0.99 156.12	0.42 70.10	0.23 66.82	0.38 27.39	0.04 104.33	0.11 315.41	Mag Phase

Table V. – Rotor Performance, Control Positions, Blade Loads, Fixed System Loads, and Pitch Link Loads for  $\mu = 0.30$  and  $0.35$

(a) Rotor performance and control positions

Run 9

$\mu_{Nom} = 0.30$

POINT	$\alpha_s$	$B_1$	$A_1$	$\theta$	$\mu$	$C_L$	$C_D$	$C_Q$
247	-2.0	3.5	2.4	4.0	0.301	0.00266	-0.00008	0.00019
248	-2.0	4.8	2.9	6.0	0.302	0.00412	-0.00017	0.00028
249	-2.0	5.3	3.1	7.0	0.301	0.00483	-0.00021	0.00036
250	-2.0	5.6	3.2	7.5	0.301	0.00510	-0.00024	0.00040
251	-2.0	5.8	3.3	8.0	0.302	0.00537	-0.00025	0.00045
252	-2.0	4.7	2.8	6.0	0.301	0.00411	-0.00016	0.00028
253	-4.0	3.1	2.2	4.0	0.301	0.00194	-0.00010	0.00019
254	-4.0	4.4	2.8	6.0	0.301	0.00341	-0.00024	0.00028
255	-4.0	5.0	3.0	7.0	0.303	0.00411	-0.00031	0.00034
256	-4.0	5.5	3.3	8.0	0.301	0.00478	-0.00038	0.00043
257	-4.0	5.8	3.5	8.5	0.301	0.00503	-0.00041	0.00048
258	-4.0	6.0	3.7	9.0	0.301	0.00526	-0.00043	0.00054
259	-4.0	5.6	3.3	8.0	0.302	0.00477	-0.00038	0.00043
260	-4.0	4.4	2.7	6.0	0.300	0.00345	-0.00025	0.00028
261	-6.0	4.2	2.6	6.0	0.301	0.00272	-0.00028	0.00027
262	-6.0	4.6	2.9	7.0	0.300	0.00348	-0.00037	0.00033
263	-6.0	5.3	3.1	8.0	0.300	0.00416	-0.00047	0.00041
264	-6.0	5.8	3.4	9.0	0.302	0.00474	-0.00054	0.00051
265	-6.0	6.1	3.7	9.5	0.301	0.00497	-0.00058	0.00056
266	-6.0	6.4	3.9	10.0	0.302	0.00518	-0.00063	0.00063
267	-6.0	5.3	3.1	8.0	0.300	0.00417	-0.00047	0.00041
268	-6.0	4.1	2.6	6.0	0.300	0.00273	-0.00028	0.00027

$\mu_{Nom} = 0.35$

POINT	$\alpha_s$	$B_1$	$A_1$	$\theta$	$\mu$	$C_L$	$C_D$	$C_Q$
269	-6.0	4.1	3.2	6.0	0.352	0.00202	-0.00017	0.00027
270	-6.0	5.4	3.7	8.0	0.350	0.00341	-0.00036	0.00042
271	-6.0	6.0	4.1	9.0	0.351	0.00397	-0.00044	0.00051
272	-6.0	5.4	3.8	8.0	0.350	0.00338	-0.00036	0.00042
273	-6.0	4.0	3.2	6.0	0.351	0.00202	-0.00016	0.00027
274	-4.0	4.4	3.5	6.0	0.351	0.00280	-0.00016	0.00030
275	-4.0	5.0	3.8	7.0	0.351	0.00344	-0.00023	0.00036
276	-4.0	5.3	3.9	7.5	0.353	0.00379	-0.00027	0.00041
277	-4.0	5.6	4.1	8.0	0.352	0.00406	-0.00030	0.00045
278	-4.0	4.4	3.5	6.0	0.351	0.00274	-0.00016	0.00030

Table V. - Continued

(b) Blade flapwise bending moment, in-lbs, 23.00 percent radius

Run 9

$\mu_{Nom.} = 0.30$

POINT	MEAN	1/2P-P	1P	2P	3P	4P	5P	6P	7P	8P	9P	10P	
247	52.41	9.70	2.70 39.40	1.28 321.09	1.34 271.30	1.80 72.27	4.02 192.61	1.55 52.52	1.76 309.70	2.46 116.77	0.67 2.55	0.34 287.83	Mag Phase
248	55.91	8.43	3.12 33.22	0.38 49.36	2.87 304.06	1.55 150.99	1.77 193.06	1.39 52.23	1.62 293.06	3.02 99.66	0.75 339.66	0.55 264.68	Mag Phase
249	57.75	14.08	3.59 23.22	2.01 45.68	3.80 274.19	2.95 178.44	1.01 128.67	1.91 20.47	2.83 251.32	5.22 58.07	1.09 298.34	0.99 221.72	Mag Phase
250	58.47	17.10	3.92 19.89	3.18 34.99	4.24 263.68	4.45 184.41	0.23 279.04	2.27 27.63	3.11 244.61	6.02 43.57	1.13 296.89	1.15 221.44	Mag Phase
251	58.91	20.00	4.09 17.46	3.98 34.76	4.86 267.50	6.33 190.34	1.70 288.58	2.79 38.77	3.49 245.25	6.63 35.39	1.31 304.35	1.24 229.83	Mag Phase
252	55.83	8.57	3.11 30.48	0.26 31.69	2.83 305.16	1.54 146.88	1.97 189.80	1.39 46.82	1.61 286.74	3.11 93.30	0.76 334.61	0.55 258.98	Mag Phase
253	51.23	7.68	3.00 30.35	1.15 314.13	1.28 273.79	1.83 71.79	2.96 212.09	0.72 26.95	1.07 285.43	1.73 104.22	0.66 342.32	0.39 274.27	Mag Phase
254	54.82	8.63	3.36 27.27	0.13 297.20	2.96 310.15	0.96 109.83	2.43 219.84	0.78 24.48	1.40 278.38	1.94 72.08	0.67 333.57	0.44 250.33	Mag Phase
255	56.72	9.54	3.57 21.93	0.57 49.39	3.45 297.05	1.76 139.76	1.90 226.75	1.14 13.88	1.85 259.32	2.34 61.18	0.67 309.42	0.50 226.48	Mag Phase
256	58.58	12.03	3.97 17.56	2.75 33.98	4.42 267.27	3.44 163.39	1.60 248.03	1.96 16.27	2.68 250.40	2.76 43.59	0.79 311.40	0.75 226.06	Mag Phase

Table V. - Continued

(b) Continued

Run 9

$\mu_{Nom.} = 0.30$

POINT	MEAN	1/2P-P	1P	2P	3P	4P	5P	6P	7P	8P	9P	10P	
257	59.21	14.93	4.31 17.39	3.95 24.99	5.03 262.50	5.07 170.17	3.28 269.98	2.48 23.04	2.91 246.66	3.18 19.11	0.89 314.40	0.85 233.49	Mag Phase
258	59.50	18.97	4.54 17.74	4.57 22.83	5.31 259.35	7.17 178.94	5.06 280.52	3.42 27.31	3.53 260.82	4.10 357.89	1.00 305.49	1.02 233.92	Mag Phase
259	58.52	12.03	4.09 18.54	2.62 37.31	4.55 270.73	3.29 166.99	1.75 242.71	1.94 28.14	2.70 260.09	2.86 56.28	0.83 323.98	0.73 242.91	Mag Phase
260	54.68	8.61	3.36 24.27	0.13 249.87	2.93 306.51	0.94 101.29	2.73 204.87	0.84 18.27	1.45 267.94	1.98 66.02	0.74 316.33	0.48 235.78	Mag Phase
261	53.52	8.48	3.47 24.90	0.71 149.96	2.94 304.91	0.95 79.04	2.65 219.64	0.43 40.01	0.93 272.37	1.33 76.40	0.47 340.91	0.24 266.07	Mag Phase
262	55.48	9.43	3.57 18.60	0.66 125.27	3.58 304.71	1.16 127.06	2.56 233.09	0.54 29.99	1.05 271.38	1.31 51.39	0.53 326.54	0.33 246.51	Mag Phase
263	57.54	10.37	4.05 18.37	1.43 65.19	4.09 285.91	2.32 149.96	2.34 264.68	0.86 26.19	1.52 261.96	0.99 69.27	0.45 338.65	0.37 251.06	Mag Phase
264	59.21	13.66	4.45 18.48	3.30 32.80	5.29 267.98	4.59 161.97	4.33 272.62	1.75 31.34	2.25 260.44	1.00 334.09	0.66 1.64	0.52 252.31	Mag Phase
265	59.77	16.37	4.72 17.69	4.12 20.50	5.94 261.19	5.60 157.08	5.22 249.68	2.60 28.55	2.42 251.12	1.19 305.91	0.91 334.75	0.61 233.07	Mag Phase
266	60.06	19.29	5.00 17.85	4.39 18.65	5.91 263.01	5.78 152.15	6.92 229.31	2.93 33.18	2.20 249.93	1.44 315.73	1.21 319.37	0.78 225.52	Mag Phase

Table V. - Continued

(b) Continued

Run 9

$\mu_{Nom.} = 0.30$

POINT	MEAN	1/2P-P	1P	2P	3P	4P	5P	6P	7P	8P	9P	10P	
267	57.48	10.28	3.93 18.45	1.50 66.24	4.10 288.09	2.29 155.32	2.35 264.98	0.98 29.59	1.66 269.85	0.95 93.20	0.37 344.12	0.39 255.21	Mag Phase
268	53.53	8.97	3.39 23.27	0.72 147.89	2.96 303.94	1.07 83.60	3.17 217.05	0.37 44.45	0.83 267.55	1.22 83.14	0.54 335.27	0.28 255.63	Mag Phase

$\mu_{Nom.} = 0.35$

POINT	MEAN	1/2P-P	1P	2P	3P	4P	5P	6P	7P	8P	9P	10P	
269	53.31	13.90	3.75 25.37	2.09 343.07	2.30 246.22	3.52 88.84	5.78 225.02	1.39 72.31	1.94 332.91	3.25 144.73	0.78 45.82	0.50 311.71	Mag Phase
270	57.28	15.83	4.35 19.79	3.02 7.11	3.94 253.59	3.74 110.46	5.90 233.57	1.83 41.35	2.10 298.81	2.87 131.44	0.88 26.70	0.38 278.29	Mag Phase
271	58.97	19.31	4.91 19.97	3.92 5.80	4.72 253.14	5.02 123.98	8.11 236.46	2.58 33.48	2.57 276.80	3.37 161.94	1.07 15.91	0.48 264.15	Mag Phase
272	57.27	15.76	4.33 21.07	2.80 6.46	3.83 257.06	3.80 113.58	6.15 235.73	1.90 49.87	2.09 301.73	2.59 138.44	0.99 28.78	0.44 287.86	Mag Phase
273	53.39	14.12	3.74 23.29	2.19 339.74	2.24 244.83	3.63 85.77	5.99 222.83	1.40 69.69	1.83 328.88	3.23 138.34	0.82 37.54	0.48 306.78	Mag Phase
274	54.96	17.72	3.77 30.64	3.43 346.07	2.98 225.98	4.01 92.80	6.72 218.77	2.14 61.93	2.74 326.09	4.21 142.02	1.01 32.52	0.68 302.57	Mag Phase
275	56.81	18.57	4.12 27.87	3.64 350.10	3.67 231.11	4.15 97.64	6.82 212.35	2.47 41.24	2.61 303.86	4.14 126.33	1.21 6.28	0.73 269.24	Mag Phase



Table V. - Continued

(b) Concluded

Run 9

$\mu_{Nom.} = 0.35$

POINT	MEAN	1/2P-P	1P	2P	3P	4P	5P	6P	7P	8P	9P	10P	
276	57.76	19.94	4.27 27.18	4.02 356.96	3.99 242.40	4.42 111.06	7.47 223.17	2.76 44.49	2.78 302.52	4.29 142.92	1.30 19.47	0.73 275.85	Mag Phase
277	58.43	21.31	4.69 23.24	4.41 352.30	4.41 240.30	4.98 110.11	8.39 218.39	2.85 23.86	2.94 269.47	4.47 130.64	1.27 0.44	0.72 242.82	Mag Phase
278	54.86	18.95	3.75 29.30	3.42 341.57	2.85 218.59	4.43 81.36	7.40 209.41	2.24 59.62	2.94 323.37	4.82 135.49	1.10 23.93	0.75 290.58	Mag Phase

Table V. - Continued

(c) Blade chordwise bending moment, in-lbs, 30.00 percent radius

Run 9

$\mu_{Nom.} = 0.30$

POINT	MEAN	1/2P-P	1P	2P	3P	4P	5P	6P	7P	8P	9P	10P	
247	-33.23	12.69	5.81 290.71	2.12 42.51	1.09 281.73	1.32 239.94	2.70 29.83	5.31 319.97	0.72 320.76	0.21 332.14	0.29 219.29	0.06 187.58	Mag Phase
248	-30.31	24.33	16.22 323.89	4.92 27.60	2.34 140.23	1.45 168.56	5.89 5.32	4.04 344.57	0.12 189.59	0.16 238.98	0.31 159.30	0.24 172.57	Mag Phase
249	-26.60	40.28	22.98 331.35	7.22 358.66	4.01 138.54	4.83 167.87	4.76 22.77	8.51 343.19	1.41 82.97	0.36 208.30	0.84 139.19	0.22 171.77	Mag Phase
250	-23.91	45.59	25.18 333.62	10.32 346.26	3.45 129.22	6.67 164.50	6.62 60.70	9.91 346.98	2.93 74.39	0.98 305.09	1.14 128.62	0.23 177.84	Mag Phase
251	-21.19	50.43	27.21 339.89	12.58 345.77	3.57 134.77	6.86 163.26	7.60 65.11	11.14 7.40	3.91 100.04	1.00 299.92	1.72 139.87	0.56 221.93	Mag Phase
252	-29.94	24.71	16.33 322.43	5.01 31.46	2.57 143.00	1.11 150.12	6.03 4.49	4.44 339.61	0.23 171.62	0.15 61.27	0.31 148.37	0.18 162.04	Mag Phase
253	-32.22	9.39	3.42 285.78	2.35 38.96	0.79 212.67	2.28 172.66	4.84 341.17	2.58 311.02	0.92 305.55	0.43 266.75	0.26 232.90	0.11 107.01	Mag Phase
254	-29.49	17.94	11.68 314.52	4.08 15.65	1.96 146.72	0.81 147.12	6.92 358.05	2.12 318.21	0.18 291.05	0.33 297.90	0.19 92.20	0.18 89.72	Mag Phase
255	-27.24	31.82	17.74 323.60	5.08 3.95	4.56 139.61	2.95 145.60	8.69 346.65	6.02 8.22	0.27 88.92	0.57 213.25	0.30 104.37	0.25 137.53	Mag Phase
256	-22.25	47.85	24.43 334.42	10.75 339.00	4.73 134.16	7.00 147.89	4.81 11.26	11.85 5.93	2.98 54.29	0.64 258.96	0.83 114.70	0.34 153.24	Mag Phase

Table V. - Continued

(c) Continued

Run 9

 $\mu_{\text{Nom.}} = 0.30$ 

POINT	MEAN	1/2P-P	1P	2P	3P	4P	5P	6P	7P	8P	9P	10P	
257	-19.34	52.47	25.53 336.58	13.22 330.79	4.08 133.07	8.14 142.65	5.04 35.58	15.15 13.81	4.75 65.62	0.79 304.26	1.40 113.17	0.53 185.58	Mag Phase
258	-16.28	71.51	25.84 342.98	14.28 325.16	4.01 131.28	9.07 131.68	9.13 58.98	30.42 30.70	7.53 78.09	1.52 354.94	2.85 119.69	0.86 234.37	Mag Phase
259	-22.33	47.72	24.19 337.03	9.98 340.95	4.98 140.10	6.42 152.59	4.95 347.34	12.22 15.32	3.00 69.44	0.42 211.65	0.81 131.11	0.40 166.56	Mag Phase
260	-29.42	19.63	11.92 313.77	4.09 15.31	2.05 136.98	0.85 153.26	7.67 347.91	2.91 307.47	0.17 286.88	0.61 220.13	0.13 101.32	0.17 84.98	Mag Phase
261	-29.72	16.06	8.14 311.60	3.34 12.60	1.65 143.96	0.34 188.52	7.47 347.79	2.63 320.88	0.08 46.61	0.28 168.05	0.08 25.57	0.12 73.04	Mag Phase
262	-27.95	27.15	13.93 324.27	4.65 359.55	4.18 138.75	2.03 129.37	9.32 339.38	4.47 13.14	0.52 101.89	0.39 233.48	0.21 69.19	0.16 131.34	Mag Phase
263	-24.73	40.43	20.00 330.84	8.32 346.58	5.88 140.90	5.20 143.37	9.45 333.02	10.17 30.09	1.28 77.01	0.87 208.65	0.45 93.34	0.25 131.88	Mag Phase
264	-19.42	54.62	25.08 338.78	13.36 333.44	5.63 141.84	8.30 138.26	6.84 330.43	17.82 29.10	4.15 68.82	0.99 266.73	0.92 103.96	0.54 186.67	Mag Phase
265	-16.42	66.17	26.72 342.33	14.84 321.63	6.26 138.57	9.13 132.67	10.71 313.73	28.22 28.14	6.58 75.71	0.85 286.43	1.36 93.35	0.66 186.96	Mag Phase
266	-13.82	80.12	28.87 350.98	15.73 316.68	7.30 146.81	7.65 133.81	20.00 315.35	39.87 33.41	8.35 92.94	0.83 325.14	1.41 86.13	0.96 192.67	Mag Phase

Table V. - Continued

(c) Continued

Run 9

 $\mu_{\text{Nom.}} = 0.30$ 

POINT	MEAN	1/2P-P	1P	2P	3P	4P	5P	6P	7P	8P	9P	10P	
267	-24.49	41.20	20.36 333.76	8.45 347.31	5.78 145.89	5.07 148.08	8.04 326.49	10.76 29.11	1.45 78.68	0.77 186.21	0.44 105.72	0.27 133.37	Mag Phase
268	-30.13	16.35	7.55 311.85	3.73 19.63	1.64 145.24	0.77 193.29	8.65 344.63	1.45 312.77	0.13 236.45	0.30 155.42	0.09 289.04	0.14 85.52	Mag Phase

 $\mu_{\text{Nom.}} = 0.35$ 

POINT	MEAN	1/2P-P	1P	2P	3P	4P	5P	6P	7P	8P	9P	10P	
269	-29.70	20.47	4.58 291.01	3.72 311.55	0.86 220.78	1.99 176.89	10.24 315.46	6.13 307.80	1.44 322.86	0.62 343.59	0.69 258.30	0.28 84.00	Mag Phase
270	-24.50	40.94	14.87 317.30	10.33 305.21	2.60 122.16	4.01 115.23	11.64 326.92	12.24 321.84	3.21 26.60	0.51 78.73	0.59 317.48	0.42 94.94	Mag Phase
271	-20.24	51.43	18.76 326.57	13.17 309.83	4.05 131.60	6.11 130.65	12.72 320.26	20.01 338.58	5.25 39.59	0.58 186.10	1.04 353.34	0.86 131.65	Mag Phase
272	-24.25	40.76	14.89 318.42	10.26 305.71	2.63 133.22	4.23 122.19	11.46 328.52	13.15 332.78	3.22 29.06	0.20 239.27	0.60 318.02	0.40 97.86	Mag Phase
273	-30.01	19.55	4.75 293.99	3.94 307.54	1.03 216.29	2.20 170.45	9.92 302.30	4.90 305.95	1.64 321.68	1.04 341.32	0.69 254.15	0.30 76.23	Mag Phase
274	-29.28	25.98	7.26 296.35	5.15 299.43	0.35 262.26	2.36 184.04	9.99 319.80	8.59 304.09	2.37 344.76	0.92 351.92	0.83 265.59	0.38 96.57	Mag Phase
275	-26.74	37.54	12.72 306.19	8.18 291.82	1.23 104.05	2.01 135.50	12.22 315.09	11.78 300.87	2.96 1.00	0.38 345.58	0.84 270.00	0.47 84.99	Mag Phase

Table V. - Continued

(c) Concluded

Run 9

$\mu_{Nom.} = 0.35$

POINT	MEAN	1/2P-P	1P	2P	3P	4P	5P	6P	7P	8P	9P	10P	
276	-25.19	44.38	15.36	10.29	2.38	3.50	13.52	14.27	3.69	0.31	0.84	0.65	Mag
			317.21	297.79	112.07	129.22	330.61	316.94	26.07	287.42	302.21	109.39	Phase
277	-22.96	48.50	16.76	10.98	3.15	4.14	13.68	17.60	4.74	0.46	1.01	1.03	Mag
			320.91	298.82	114.56	135.18	321.86	310.52	14.93	159.25	311.50	101.97	Phase
278	-29.75	24.77	6.97	4.88	0.30	1.71	9.52	8.80	2.20	1.00	0.88	0.34	Mag
			299.21	297.17	340.40	188.18	300.17	299.60	330.09	352.51	244.36	62.32	Phase

Table V. - Continued

(d) Blade torsional moment, in-lbs, 35.00 percent radius

Run 9

$\mu_{Nom.} = 0.30$

POINT	MEAN	1/2P-P	1P	2P	3P	4P	5P	6P	7P	8P	9P	10P	
247	4.48	6.28	3.28 20.37	1.68 13.85	2.53 256.52	1.79 128.88	0.67 252.58	0.98 170.37	0.43 147.67	0.12 348.99	0.01 191.33	0.08 191.49	Mag Phase
248	6.86	8.10	4.21 20.37	3.72 65.23	3.79 301.13	2.79 163.58	0.74 335.24	0.91 157.57	0.27 170.56	0.09 282.63	0.07 118.22	0.07 167.87	Mag Phase
249	7.98	16.02	5.16 22.42	6.39 53.71	7.25 298.17	5.36 176.08	1.89 353.03	1.72 162.45	0.54 256.19	0.59 246.78	0.14 38.81	0.19 130.82	Mag Phase
250	8.15	20.82	5.92 22.92	7.90 44.51	9.12 295.78	7.10 181.51	2.75 359.56	2.68 184.88	1.29 279.44	0.82 240.12	0.29 4.99	0.11 118.92	Mag Phase
251	7.74	23.69	6.91 25.15	8.99 41.08	9.90 299.25	8.18 197.20	4.16 12.91	3.97 204.10	2.73 309.33	0.76 241.36	0.64 359.61	0.12 128.67	Mag Phase
252	6.96	8.18	4.25 18.82	3.62 64.07	3.71 298.32	2.80 156.72	0.85 332.22	0.86 151.39	0.25 153.59	0.09 278.70	0.09 110.72	0.06 152.36	Mag Phase
253	3.59	8.06	3.34 18.70	2.17 3.84	3.52 254.03	2.60 133.65	0.86 299.07	0.68 134.44	0.33 152.23	0.01 268.58	0.10 113.99	0.04 153.11	Mag Phase
254	5.89	8.10	4.18 15.95	3.00 50.13	3.56 288.00	2.98 140.83	1.22 334.86	0.82 138.59	0.24 169.26	0.03 27.32	0.04 335.95	0.03 204.98	Mag Phase
255	7.11	12.33	4.49 15.92	4.67 53.26	5.24 288.63	4.06 149.09	2.02 322.26	1.03 144.18	0.29 207.58	0.06 241.75	0.04 32.90	0.03 171.11	Mag Phase
256	8.16	19.23	5.52 19.58	7.35 40.02	9.08 291.51	6.32 173.29	2.47 330.02	2.20 176.34	1.34 255.90	0.69 240.99	0.24 306.05	0.07 129.76	Mag Phase

Table V. - Continued

(d) Continued

Run 9

 $\mu_{\text{Nom.}} = 0.30$ 

POINT	MEAN	1/2P-P	1P	2P	3P	4P	5P	6P	7P	8P	9P	10P	
257	8.08	23.21	6.28 22.80	8.64 32.06	10.47 291.18	8.16 183.55	2.84 346.24	4.33 189.17	2.55 273.92	0.85 222.83	0.55 309.13	0.14 156.84	Mag Phase
258	7.29	26.79	7.48 27.90	9.18 28.51	11.15 290.31	9.59 195.79	3.87 40.27	9.08 196.20	4.41 278.39	1.82 222.92	1.03 320.07	0.41 182.35	Mag Phase
259	8.18	19.04	5.59 21.03	7.28 43.27	9.03 296.16	6.08 177.08	2.82 328.98	1.95 184.80	1.33 269.57	0.64 264.41	0.31 323.39	0.06 142.79	Mag Phase
260	5.91	7.79	4.13 14.91	2.92 47.94	3.42 284.36	2.88 135.68	1.16 327.52	0.74 140.02	0.22 172.39	0.05 16.14	0.01 354.49	0.04 182.59	Mag Phase
261	4.95	6.84	3.99 18.00	2.33 55.27	2.91 282.39	2.27 133.37	0.97 312.99	0.64 119.05	0.24 150.02	0.08 341.69	0.02 243.28	0.04 157.08	Mag Phase
262	6.14	9.16	4.45 14.47	3.66 59.53	3.94 294.56	2.93 142.35	1.52 317.26	0.66 149.10	0.24 237.34	0.07 341.31	0.04 328.63	0.04 227.59	Mag Phase
263	7.48	14.39	4.95 16.06	5.74 52.17	6.59 293.28	4.39 162.97	2.39 314.84	0.97 172.59	0.59 252.04	0.18 263.66	0.10 281.46	0.09 206.42	Mag Phase
264	8.22	21.52	5.90 20.12	8.07 34.88	10.34 292.91	6.86 182.13	3.10 324.96	3.01 189.92	1.85 268.04	0.53 226.98	0.44 300.02	0.20 172.74	Mag Phase
265	7.96	24.63	6.73 20.61	8.95 23.15	11.17 287.09	8.10 184.28	3.73 318.89	5.08 190.51	3.24 268.23	0.77 216.14	0.75 290.28	0.32 137.89	Mag Phase
266	7.38	24.21	7.80 19.79	9.37 20.92	10.76 286.39	7.53 186.66	5.71 327.40	5.14 186.66	4.08 273.27	0.85 248.85	1.15 295.83	0.37 120.15	Mag Phase

Table V. - Continued

(d) Continued

Run 9

$\mu_{Nom.} = 0.30$

POINT	MEAN	1/2P-P	1P	2P	3P	4P	5P	6P	7P	8P	9P	10P	
267	7.58	14.52	4.97 17.44	5.86 54.44	6.68 297.02	4.54 168.99	2.20 318.47	1.12 179.85	0.65 259.41	0.25 281.05	0.12 298.27	0.10 203.91	Mag Phase
268	5.02	7.01	4.00 17.77	2.38 52.61	3.01 279.78	2.42 131.68	1.07 314.79	0.62 108.02	0.26 139.68	0.07 15.36	0.02 219.18	0.04 134.16	Mag Phase

$\mu_{Nom.} = 0.35$

POINT	MEAN	1/2P-P	1P	2P	3P	4P	5P	6P	7P	8P	9P	10P	
269	4.17	12.60	4.21 22.50	4.24 22.10	5.40 262.54	4.23 133.05	1.24 285.61	1.12 124.55	0.51 165.05	0.22 269.12	0.11 150.94	0.10 116.49	Mag Phase
270	6.66	18.54	5.46 20.25	7.22 35.39	8.19 278.91	6.38 146.00	2.07 310.38	2.38 129.88	0.84 210.04	0.45 257.11	0.15 218.38	0.09 107.23	Mag Phase
271	7.33	23.15	6.23 26.29	8.33 30.45	9.75 281.19	7.79 154.78	3.38 325.31	4.19 142.08	1.90 237.87	0.26 248.99	0.40 253.39	0.18 102.42	Mag Phase
272	6.62	18.67	5.41 21.37	7.19 36.64	8.19 280.85	6.40 148.37	2.24 311.42	2.28 135.30	0.87 220.72	0.37 262.27	0.16 226.98	0.09 109.14	Mag Phase
273	4.20	13.03	4.20 22.30	4.31 20.14	5.54 260.07	4.47 130.67	1.28 285.53	1.11 116.77	0.50 159.28	0.21 258.25	0.13 151.69	0.09 105.33	Mag Phase
274	5.41	16.44	4.59 23.71	5.79 23.45	6.72 267.00	5.62 139.25	0.85 312.97	1.75 125.33	0.63 184.94	0.33 274.62	0.13 158.40	0.06 95.01	Mag Phase
275	6.36	18.93	5.27 22.59	6.92 27.14	8.11 271.35	6.75 139.22	1.78 310.71	2.41 111.91	0.86 189.15	0.41 250.21	0.16 163.10	0.09 66.75	Mag Phase



Table V. - Continued

(d) Concluded

Run 9

$\mu_{Nom.} = 0.35$

POINT	MEAN	1/2P-P	1P	2P	3P	4P	5P	6P	7P	8P	9P	10P	
276	6.92	20.51	5.71 27.28	7.46 32.24	8.88 280.10	7.48 150.31	2.53 323.91	3.13 126.10	1.17 215.46	0.40 259.39	0.17 201.85	0.13 69.53	Mag Phase
277	7.19	22.57	6.13 27.86	7.86 25.25	9.43 274.35	8.30 146.03	3.26 326.26	4.46 119.89	1.73 211.77	0.38 237.19	0.27 223.76	0.12 51.53	Mag Phase
278	5.29	15.51	4.56 23.56	5.47 18.57	6.27 259.42	5.28 128.90	0.90 273.02	1.47 123.78	0.67 168.29	0.31 284.35	0.12 154.23	0.06 111.81	Mag Phase

Table V. - Continued

(e) Blade flapwise bending moment, in-lbs, 37.00 percent radius

Run 9

$\mu_{Nom.} = 0.30$

POINT	MEAN	1/2P-P	1P	2P	3P	4P	5P	6P	7P	8P	9P	10P	
247	0.12	0.39	0.10 107.34	0.11 2.08	0.11 5.68	0.05 112.49	0.06 147.01	0.11 293.19	0.07 14.67	0.02 86.49	0.09 331.16	0.09 15.81	Mag Phase
248	0.02	0.28	0.07 94.58	0.10 349.43	0.08 17.63	0.04 120.24	0.05 217.17	0.06 91.81	0.01 126.24	0.07 185.05	0.04 2.05	0.04 295.86	Mag Phase
249	0.11	0.45	0.06 331.47	0.13 348.58	0.16 325.43	0.07 53.27	0.03 338.20	0.10 18.28	0.07 124.97	0.06 83.40	0.04 359.51	0.07 29.03	Mag Phase
250	0.06	0.40	0.11 20.16	0.14 26.01	0.14 327.59	0.07 96.22	0.04 18.60	0.03 271.44	0.03 223.33	0.05 200.03	0.08 283.44	0.06 57.31	Mag Phase
251	-0.02	0.45	0.13 327.30	0.09 49.83	0.16 309.99	0.03 96.20	0.10 326.59	0.03 13.39	0.03 25.74	0.06 58.52	0.03 137.83	0.05 97.20	Mag Phase
252	-0.04	0.55	0.20 282.01	0.06 23.55	0.13 311.70	0.09 52.17	0.04 297.85	0.04 37.01	0.01 132.61	0.07 121.45	0.03 39.13	0.06 128.40	Mag Phase
253	-0.03	0.50	0.27 282.01	0.14 38.08	0.06 247.21	0.12 65.84	0.05 20.06	0.06 267.25	0.03 175.75	0.02 133.95	0.05 301.86	0.05 353.49	Mag Phase
254	0.03	0.47	0.30 279.37	0.12 65.37	0.06 338.30	0.07 52.43	0.01 343.90	0.05 277.88	0.02 192.49	0.02 97.57	0.04 141.31	0.07 189.49	Mag Phase
255	-0.25	0.50	0.30 264.12	0.07 45.61	0.10 270.31	0.10 57.75	0.07 313.71	0.05 167.30	0.05 192.31	0.01 29.77	0.01 0.90	0.02 83.94	Mag Phase
256	0.00	0.61	0.34 265.94	0.14 39.45	0.09 308.58	0.02 84.58	0.11 8.49	0.06 162.06	0.07 177.36	0.03 142.90	0.03 204.58	0.03 227.28	Mag Phase

Table V. - Continued

(e) Continued

Run 9

 $\mu_{\text{Nom.}} = 0.30$ 

POINT	MEAN	1/2P-P	1P	2P	3P	4P	5P	6P	7P	8P	9P	10P	
257	-0.03	0.46	0.27 256.02	0.13 49.60	0.08 252.66	0.06 132.21	0.03 300.47	0.04 8.08	0.07 204.49	0.04 96.28	0.02 39.72	0.03 319.85	Mag Phase
258	-0.02	0.51	0.34 256.21	0.09 35.06	0.09 271.55	0.06 132.71	0.05 22.44	0.07 205.33	0.08 208.04	0.02 133.00	0.06 299.15	0.03 352.18	Mag Phase
259	0.09	0.48	0.30 246.08	0.08 33.33	0.05 303.96	0.06 123.17	0.07 119.59	0.05 34.38	0.03 205.89	0.02 282.13	0.01 198.34	0.08 300.02	Mag Phase
260	-0.04	0.42	0.31 237.31	0.02 94.77	0.04 54.26	0.06 83.50	0.02 41.19	0.08 234.27	0.04 53.21	0.05 51.50	0.02 165.89	0.05 246.10	Mag Phase
261	0.28	0.42	0.31 221.87	0.04 74.53	0.04 14.82	0.03 127.34	0.04 198.12	0.02 332.94	0.06 109.29	0.02 72.46	0.05 67.04	0.05 89.18	Mag Phase
262	0.02	0.55	0.29 208.22	0.10 179.05	0.11 15.08	0.10 71.35	0.05 182.19	0.05 202.25	0.04 247.03	0.04 340.57	0.01 276.49	0.04 273.35	Mag Phase
263	-0.01	0.38	0.25 208.75	0.03 129.46	0.07 324.15	0.07 146.60	0.12 340.13	0.06 187.59	0.02 148.12	0.04 136.28	0.04 221.98	0.03 337.04	Mag Phase
264	0.16	0.38	0.25 202.53	0.11 144.21	0.03 240.07	0.07 131.37	0.04 316.57	0.06 20.18	0.01 249.85	0.05 77.75	0.03 140.54	0.01 210.65	Mag Phase
265	-0.02	0.42	0.17 208.67	0.09 68.99	0.04 339.96	0.08 76.10	0.14 342.78	0.07 188.00	0.05 296.04	0.03 53.98	0.09 168.35	0.02 325.37	Mag Phase
266	0.05	0.35	0.20 180.86	0.04 151.81	0.07 325.74	0.06 71.91	0.13 313.44	0.04 149.12	0.05 237.83	0.04 281.74	0.03 310.49	0.03 250.39	Mag Phase

Table V. - Continued

(e) Continued

Run 9

 $\mu_{\text{Nom.}} = 0.30$ 

POINT	MEAN	1/2P-P	1P	2P	3P	4P	5P	6P	7P	8P	9P	10P	
267	0.19	0.35	0.22 201.85	0.06 134.82	0.12 312.39	0.05 143.97	0.06 331.97	0.04 320.27	0.02 108.29	0.02 325.53	0.04 244.01	0.04 154.66	Mag Phase
268	0.20	0.33	0.08 195.74	0.05 10.40	0.07 17.49	0.05 64.83	0.08 122.86	0.04 355.93	0.09 178.07	0.07 227.66	0.06 340.51	0.02 0.77	Mag Phase

 $\mu_{\text{Nom.}} = 0.35$ 

POINT	MEAN	1/2P-P	1P	2P	3P	4P	5P	6P	7P	8P	9P	10P	
269	0.16	0.39	0.19 122.43	0.03 66.14	0.04 318.58	0.06 95.25	0.06 299.12	0.03 167.23	0.09 86.78	0.05 251.46	0.05 214.48	0.08 180.64	Mag Phase
270	0.11	0.30	0.11 94.14	0.05 13.80	0.06 306.14	0.12 124.27	0.11 323.02	0.08 69.57	0.04 175.22	0.05 160.29	0.03 46.99	0.05 21.29	Mag Phase
271	0.05	0.33	0.14 108.16	0.07 37.68	0.05 346.31	0.11 129.26	0.00 88.88	0.02 345.73	0.05 117.85	0.07 228.05	0.00 32.84	0.05 58.93	Mag Phase
272	0.09	0.35	0.14 96.34	0.08 20.03	0.01 343.98	0.09 134.43	0.13 20.09	0.04 56.00	0.07 152.45	0.01 242.68	0.02 174.41	0.03 285.87	Mag Phase
273	0.13	0.35	0.14 332.63	0.11 305.96	0.10 319.78	0.08 120.79	0.01 356.90	0.02 8.49	0.04 39.90	0.06 222.82	0.03 270.98	0.04 270.80	Mag Phase
274	-0.10	0.34	0.23 347.72	0.05 17.70	0.06 349.58	0.07 121.14	0.08 303.73	0.08 15.35	0.03 126.92	0.08 271.34	0.04 313.88	0.02 139.90	Mag Phase
275	-0.05	0.38	0.08 15.73	0.06 7.09	0.06 32.90	0.08 94.88	0.16 338.08	0.09 6.05	0.03 141.71	0.03 89.06	0.07 44.69	0.04 12.73	Mag Phase

Table V. - Continued

(e) Concluded

Run 9

$\mu_{Nom.} = 0.35$

POINT	MEAN	1/2P-P	1P	2P	3P	4P	5P	6P	7P	8P	9P	10P	
276	0.08	0.25	0.07 356.56	0.08 49.80	0.07 319.32	0.07 119.26	0.01 351.81	0.06 51.80	0.07 188.26	0.03 125.06	0.00 337.31	0.03 226.46	Mag Phase
277	-0.05	0.28	0.10 330.91	0.09 102.92	0.07 358.56	0.03 73.58	0.05 3.39	0.08 30.20	0.03 0.83	0.04 356.81	0.03 356.99	0.04 262.26	Mag Phase
278	-0.14	0.34	0.19 319.26	0.13 40.13	0.04 349.49	0.09 70.13	0.07 12.13	0.06 313.37	0.06 122.53	0.03 329.46	0.02 22.19	0.02 195.19	Mag Phase

Table V. - Continued

(f) Blade chordwise bending moment, in-lbs, 45.00 percent radius

Run 9

$\mu_{Nom.} = 0.30$

POINT	MEAN	1/2P-P	1P	2P	3P	4P	5P	6P	7P	8P	9P	10P	
247	-46.76	18.15	7.17 282.09	2.53 62.75	0.70 284.44	1.73 262.17	3.44 26.51	8.84 323.28	1.81 326.76	0.88 82.66	1.00 330.13	0.16 175.03	Mag Phase
248	-44.81	26.65	14.60 313.31	4.35 41.01	3.32 155.10	0.82 238.84	8.38 2.62	6.74 345.98	0.23 316.57	1.52 126.40	1.45 91.93	0.17 359.97	Mag Phase
249	-41.49	43.29	18.98 322.21	4.26 3.49	6.25 136.66	4.20 195.72	5.79 19.32	14.57 345.09	1.86 72.75	3.13 103.37	2.07 161.55	0.23 262.11	Mag Phase
250	-38.79	46.00	20.28 325.36	6.30 340.90	6.43 122.40	6.37 188.49	8.18 66.54	17.16 348.83	4.17 71.73	3.17 31.96	2.87 172.66	0.50 244.49	Mag Phase
251	-35.71	51.49	21.18 332.04	7.86 338.27	6.93 123.79	6.55 189.03	9.57 72.24	19.59 8.39	5.20 103.27	1.60 43.81	3.47 192.81	1.27 282.65	Mag Phase
252	-44.22	27.40	14.63 312.27	4.52 45.35	3.55 154.81	0.46 277.20	8.59 1.86	7.41 341.02	0.12 182.82	2.43 92.88	1.49 81.51	0.21 304.20	Mag Phase
253	-44.64	12.80	4.74 277.25	2.39 61.34	0.44 134.67	2.19 183.14	6.43 340.96	4.42 313.57	1.94 307.11	0.56 238.20	1.05 291.34	0.16 261.25	Mag Phase
254	-43.26	22.42	11.31 303.46	3.65 28.56	2.64 155.80	0.35 272.10	9.76 357.21	3.58 320.42	0.51 324.63	0.95 357.55	2.43 30.20	0.21 282.35	Mag Phase
255	-41.57	35.40	15.61 313.17	3.64 17.65	5.70 144.53	1.93 168.21	12.31 345.20	10.05 7.93	0.40 53.74	1.26 158.64	2.02 74.17	0.55 2.38	Mag Phase
256	-36.99	51.76	19.60 326.65	6.98 334.94	7.40 129.00	6.49 165.65	5.64 7.59	20.08 6.82	4.68 44.52	0.47 174.92	2.39 139.96	0.65 94.90	Mag Phase

Table V. - Continued

(f) Continued

Run 9

 $\mu_{\text{Nom.}} = 0.30$ 

POINT	MEAN	1/2P-P	1P	2P	3P	4P	5P	6P	7P	8P	9P	10P	
257	-33.87	58.60	20.19 329.63	8.89 322.39	7.24 120.89	7.57 162.25	5.74 40.59	25.91 15.14	7.37 59.63	1.01 4.60	3.58 160.02	0.29 176.06	Mag Phase
258	-29.93	86.19	19.99 335.14	9.71 314.36	7.83 115.45	7.68 149.98	11.60 64.71	52.40 31.79	12.64 77.87	1.04 359.60	5.86 180.46	1.44 310.68	Mag Phase
259	-36.98	52.41	19.33 328.98	6.24 336.75	7.59 134.58	5.85 173.14	6.40 339.14	20.69 15.95	4.77 61.19	2.28 135.53	2.40 150.28	0.47 105.90	Mag Phase
260	-43.17	23.23	11.42 303.62	3.77 28.48	2.67 148.34	0.47 255.95	10.82 347.40	4.92 309.64	0.54 326.21	1.17 198.03	2.15 16.95	0.29 287.31	Mag Phase
261	-43.01	21.33	8.47 300.98	3.15 22.16	2.26 152.97	0.78 287.10	10.54 347.63	4.42 324.03	0.50 21.39	1.26 130.58	2.03 355.00	0.20 250.13	Mag Phase
262	-42.17	30.81	12.71 313.14	3.87 7.94	5.08 148.41	0.88 129.00	13.40 339.08	7.45 13.58	1.10 84.06	0.46 243.19	2.54 41.68	0.27 27.02	Mag Phase
263	-39.67	45.37	16.90 320.58	6.05 348.98	7.70 142.01	4.20 156.35	13.53 331.44	16.87 30.34	2.39 74.39	2.65 189.04	2.52 86.34	0.57 77.58	Mag Phase
264	-34.37	63.32	19.88 331.25	9.16 328.20	8.60 131.55	7.70 154.02	9.39 325.46	30.15 30.06	6.99 63.29	3.20 250.69	3.42 127.47	0.94 108.13	Mag Phase
265	-31.07	86.76	20.28 335.42	10.16 313.53	9.41 125.82	8.42 150.41	14.69 309.44	48.29 29.23	11.42 74.69	2.36 234.18	3.18 138.95	0.60 68.18	Mag Phase
266	-28.40	121.45	20.70 344.24	10.70 307.45	10.24 132.79	7.13 155.21	27.66 312.30	68.64 34.27	15.22 93.80	0.53 274.08	0.85 153.69	0.90 143.32	Mag Phase

Table V. - Continued

(f) Continued

Run 9

$\mu_{Nom.} = 0.30$

POINT	MEAN	1/2P-P	1P	2P	3P	4P	5P	6P	7P	8P	9P	10P	
267	-39.68	46.25	17.05	6.02	7.64	4.04	11.67	17.95	2.58	2.96	2.57	0.26	Mag
			323.12	348.15	145.69	162.04	324.98	29.20	74.67	163.85	92.77	69.54	Phase
268	-43.65	21.51	8.18	3.57	2.21	0.88	12.19	2.50	0.21	1.35	1.90	0.34	Mag
			300.35	27.90	152.20	250.00	344.31	317.91	331.88	129.86	331.86	223.05	Phase

$\mu_{Nom.} = 0.35$

POINT	MEAN	1/2P-P	1P	2P	3P	4P	5P	6P	7P	8P	9P	10P	
269	-42.92	28.44	6.60	2.50	0.59	1.96	13.92	10.11	3.11	0.80	2.45	0.25	Mag
			282.71	297.04	100.39	191.98	314.93	310.85	327.38	344.89	270.97	293.59	Phase
270	-39.08	50.83	14.42	8.17	4.45	3.20	15.77	20.63	6.75	2.33	3.17	0.51	Mag
			306.39	292.70	107.58	134.59	324.03	323.81	20.59	89.88	338.74	62.49	Phase
271	-35.07	66.35	16.85	9.86	6.45	6.33	17.46	33.75	10.01	3.57	4.47	1.49	Mag
			316.38	295.82	112.47	155.70	316.38	339.99	34.23	163.45	14.52	80.18	Phase
272	-38.85	49.26	14.37	7.99	4.32	3.59	15.56	22.17	6.84	0.58	2.83	0.59	Mag
			307.23	292.70	113.64	140.87	325.95	334.49	23.22	203.52	337.78	75.09	Phase
273	-42.91	26.89	6.72	2.67	0.53	2.17	13.43	8.20	3.47	2.21	2.11	0.23	Mag
			283.48	292.26	117.23	184.39	301.79	308.61	324.12	339.05	273.79	316.08	Phase
274	-42.54	35.51	9.01	3.97	1.54	2.84	13.38	14.47	5.26	1.45	3.02	0.63	Mag
			287.86	275.84	58.12	205.76	318.35	307.53	343.20	9.80	298.97	355.88	Phase
275	-40.64	47.98	13.19	6.75	3.38	2.10	16.29	19.96	6.44	0.81	3.62	0.72	Mag
			297.37	271.42	79.25	184.80	312.86	304.19	354.79	52.42	303.99	33.44	Phase



Table V. - Continued

(f) Concluded

Run 9

$\mu_{Nom.} = 0.35$

POINT	MEAN	1/2P-P	1P	2P	3P	4P	5P	6P	7P	8P	9P	10P	
276	-39.34	55.19	14.98 307.40	8.48 279.09	4.83 93.03	3.14 167.62	18.05 327.84	24.22 319.40	7.68 18.91	0.57 199.72	3.42 338.78	0.92 75.89	Mag Phase
277	-37.14	60.96	15.53 310.77	8.63 278.80	5.67 92.56	4.74 172.15	18.15 318.86	29.86 312.71	9.27 9.71	3.47 128.07	3.46 345.77	0.94 62.58	Mag Phase
278	-42.66	35.40	8.44 288.88	3.63 272.70	1.93 45.39	2.39 211.77	13.04 298.48	14.69 303.01	4.97 331.27	1.45 22.82	2.87 291.82	0.64 356.48	Mag Phase

Table V. - Continued

(g) Blade flapwise bending moment, in-lbs, 51.00 percent radius

Run 9

$\mu_{Nom.} = 0.30$

POINT	MEAN	1/2P-P	1P	2P	3P	4P	5P	6P	7P	8P	9P	10P	
247	27.54	9.61	5.80 51.82	1.90 280.21	1.76 327.16	0.74 308.58	1.08 356.73	1.26 254.56	1.34 135.36	2.33 299.61	0.41 221.55	0.17 156.69	Mag Phase
248	31.02	12.18	6.46 47.23	3.82 227.48	3.83 295.85	0.59 300.05	0.63 349.19	1.35 260.68	1.37 125.20	2.57 284.74	0.22 209.65	0.25 146.18	Mag Phase
249	32.71	15.02	6.68 38.39	2.78 218.41	4.80 237.69	0.24 350.14	0.61 311.93	1.62 236.06	2.31 80.90	4.47 239.41	0.29 127.93	0.35 83.85	Mag Phase
250	33.60	16.02	6.91 32.93	1.69 225.38	5.58 213.36	0.58 40.27	0.39 302.47	1.82 236.52	2.41 75.23	5.18 223.24	0.35 136.23	0.44 75.62	Mag Phase
251	34.29	17.84	7.12 26.37	1.28 220.88	6.24 210.36	0.92 73.02	0.18 284.96	2.01 241.64	2.79 76.05	5.70 214.74	0.52 136.48	0.51 73.86	Mag Phase
252	30.97	12.28	6.41 46.06	4.09 227.27	3.86 296.42	0.65 296.97	0.61 348.25	1.34 254.76	1.38 118.30	2.65 278.76	0.21 206.98	0.23 134.41	Mag Phase
253	27.50	8.74	6.04 38.37	1.60 269.34	1.32 352.87	1.11 324.82	0.81 345.08	0.78 249.75	0.66 116.04	1.69 287.82	0.45 198.93	0.20 129.75	Mag Phase
254	30.88	11.48	6.74 40.09	3.22 224.21	3.56 312.42	1.16 312.62	0.67 354.84	0.96 251.30	1.18 115.17	1.66 258.11	0.41 199.31	0.21 121.05	Mag Phase
255	32.57	11.94	6.89 36.90	3.47 212.35	3.56 281.16	1.06 309.54	0.48 353.56	1.14 238.72	1.58 93.61	1.97 247.26	0.35 189.12	0.28 102.87	Mag Phase
256	34.43	12.87	6.77 31.54	1.68 212.64	5.12 218.54	0.59 353.43	0.38 348.31	1.48 232.78	2.19 80.35	2.31 226.41	0.47 181.06	0.40 82.13	Mag Phase

Table V. - Continued

(g) Continued

Run 9

 $\mu_{\text{Nom.}} = 0.30$ 

POINT	MEAN	1/2P-P	1P	2P	3P	4P	5P	6P	7P	8P	9P	10P	
257	35.19	14.44	6.93 26.36	0.86 248.50	6.15 204.41	0.83 33.96	0.22 60.52	1.51 234.71	2.34 75.34	2.72 200.15	0.63 169.08	0.46 73.77	Mag Phase
258	35.48	16.18	7.20 23.46	0.73 274.37	6.85 196.21	1.23 65.93	0.30 71.66	1.44 234.83	3.03 88.05	3.55 176.80	0.68 158.97	0.64 67.47	Mag Phase
259	34.52	13.14	6.91 32.87	1.78 214.16	5.12 223.97	0.58 350.25	0.47 5.16	1.52 241.50	2.22 88.94	2.42 238.70	0.49 188.76	0.41 99.20	Mag Phase
260	30.91	11.33	6.66 37.92	3.38 220.55	3.58 307.90	1.14 307.43	0.75 346.51	0.98 241.44	1.20 102.67	1.74 252.81	0.43 177.39	0.23 104.73	Mag Phase
261	30.60	10.65	6.64 33.48	3.00 201.24	3.53 308.84	1.15 311.01	0.69 353.61	0.71 256.36	0.69 97.16	1.24 262.32	0.29 192.66	0.13 98.30	Mag Phase
262	32.32	11.69	6.94 33.29	3.69 199.27	4.28 295.96	1.22 308.64	0.49 6.88	0.73 257.08	0.86 100.56	1.12 239.61	0.37 188.37	0.17 94.98	Mag Phase
263	34.21	11.90	7.10 30.27	3.06 189.83	3.96 256.60	0.99 320.22	0.33 30.60	0.83 257.06	1.28 88.08	0.83 262.44	0.38 199.96	0.21 99.95	Mag Phase
264	35.97	13.67	7.08 25.43	1.06 192.55	5.63 212.32	0.80 2.92	0.61 74.52	1.03 255.05	1.89 84.48	0.80 147.46	0.63 207.35	0.30 84.47	Mag Phase
265	36.47	14.71	7.09 19.37	0.61 252.00	6.63 203.81	0.82 21.95	0.75 57.77	1.25 237.74	2.19 76.35	0.93 117.57	0.85 172.51	0.42 64.22	Mag Phase
266	36.53	14.58	6.95 17.09	0.89 290.27	6.64 208.51	0.73 24.09	0.81 33.02	1.39 238.62	2.10 78.62	1.07 129.94	1.10 158.74	0.53 64.71	Mag Phase

Table V. - Continued

(g) Continued

Run 9

 $\mu_{\text{Nom.}} = 0.30$ 

POINT	MEAN	1/2P-P	1P	2P	3P	4P	5P	6P	7P	8P	9P	10P	
267	34.29	11.59	7.05 31.83	2.91 191.41	3.87 256.47	0.94 328.27	0.34 34.41	0.85 258.52	1.41 97.73	0.82 285.47	0.26 212.81	0.24 108.94	Mag Phase
268	30.64	10.39	6.66 32.69	3.05 202.83	3.45 309.09	1.19 311.54	0.71 354.73	0.67 256.69	0.60 96.76	1.19 270.86	0.40 186.07	0.14 112.84	Mag Phase

 $\mu_{\text{Nom.}} = 0.35$ 

POINT	MEAN	1/2P-P	1P	2P	3P	4P	5P	6P	7P	8P	9P	10P	
269	30.52	12.60	8.49 35.54	2.16 329.96	1.30 135.16	1.51 339.21	1.06 33.10	1.04 274.65	1.49 159.94	3.01 323.69	0.50 227.96	0.31 147.50	Mag Phase
270	34.50	14.44	9.89 34.47	1.87 343.50	3.76 177.76	1.62 339.35	1.12 62.49	1.20 256.27	1.63 118.92	2.53 311.42	0.65 199.13	0.27 102.68	Mag Phase
271	36.10	17.14	10.17 31.45	2.82 335.54	5.19 176.38	1.67 344.98	1.60 68.97	1.41 251.98	2.19 93.41	3.05 342.54	0.79 186.36	0.29 92.23	Mag Phase
272	34.51	14.15	9.83 34.66	1.80 337.45	3.52 177.18	1.67 339.97	1.21 64.57	1.23 263.33	1.64 120.94	2.29 318.49	0.73 202.33	0.32 118.76	Mag Phase
273	30.65	12.91	8.53 34.89	2.40 326.61	1.51 122.81	1.57 337.89	1.13 31.31	1.07 271.32	1.40 156.55	2.94 317.30	0.54 219.45	0.37 140.15	Mag Phase
274	31.03	16.42	9.09 43.45	4.34 341.54	3.17 140.66	1.54 346.88	1.39 37.84	1.50 265.10	2.17 154.43	3.68 319.94	0.60 199.39	0.37 130.71	Mag Phase
275	32.96	17.54	9.88 40.16	3.97 335.05	4.04 153.08	1.72 338.76	1.44 40.81	1.63 248.99	1.99 129.11	3.57 303.90	0.81 172.64	0.35 99.43	Mag Phase

Table V. - Continued

(g) Concluded

Run 9

$\mu_{Nom.} = 0.35$

POINT	MEAN	1/2P-P	1P	2P	3P	4P	5P	6P	7P	8P	9P	10P	
276	34.00	18.81	10.21 40.05	3.96 334.98	4.69 164.40	1.78 343.18	1.59 57.19	1.71 254.63	2.16 126.29	3.72 321.45	0.91 186.91	0.35 107.97	Mag Phase
277	34.77	20.08	10.47 35.17	4.55 326.13	5.04 159.92	1.91 337.46	1.73 53.00	1.64 238.82	2.36 91.05	3.94 309.99	0.86 169.97	0.29 69.96	Mag Phase
278	30.89	16.65	8.84 43.84	4.37 340.20	2.86 130.58	1.49 338.61	1.60 29.51	1.57 259.68	2.32 151.04	4.31 313.29	0.68 195.18	0.37 128.25	Mag Phase

Table V. - Continued

(h) Blade torsional moment, in-lbs, 60.00 percent radius

Run 9

$\mu_{Nom.} = 0.30$

POINT	MEAN	1/2P-P	1P	2P	3P	4P	5P	6P	7P	8P	9P	10P	
247	6.14	5.54	3.66 24.41	1.20 6.53	1.93 251.53	1.65 128.80	0.33 246.78	0.85 164.88	0.43 134.27	0.13 58.97	0.07 108.33	0.06 141.48	Mag Phase
248	8.51	7.32	4.50 25.45	2.91 66.15	2.76 303.48	2.40 160.66	0.55 349.41	0.88 158.27	0.33 138.40	0.06 350.45	0.02 202.44	0.09 137.99	Mag Phase
249	9.81	12.99	5.27 24.74	5.38 52.74	5.81 301.74	4.29 176.76	1.49 351.70	1.63 162.88	0.12 217.59	0.31 268.08	0.09 328.82	0.12 109.03	Mag Phase
250	10.06	16.99	5.84 23.79	6.77 42.90	7.42 298.76	5.75 182.86	2.27 355.85	2.25 181.73	0.73 287.02	0.41 249.81	0.20 298.03	0.20 113.82	Mag Phase
251	9.70	19.46	6.68 24.47	7.77 39.47	8.07 302.97	6.74 200.20	3.42 10.36	3.18 200.98	1.68 315.41	0.28 259.45	0.31 333.14	0.24 112.81	Mag Phase
252	8.61	7.21	4.56 24.02	2.80 64.83	2.69 300.24	2.41 153.57	0.65 344.71	0.85 153.13	0.32 121.02	0.06 330.88	0.02 142.31	0.10 123.39	Mag Phase
253	5.44	7.14	3.74 21.55	1.66 355.92	2.81 250.43	2.33 132.69	0.50 315.94	0.61 128.94	0.30 126.57	0.09 46.61	0.13 98.31	0.06 91.07	Mag Phase
254	7.69	7.11	4.62 19.98	2.22 50.29	2.58 286.28	2.62 138.48	0.91 344.70	0.76 136.35	0.20 129.65	0.11 53.30	0.02 278.99	0.05 119.24	Mag Phase
255	8.86	9.34	4.93 20.64	3.65 54.29	4.01 290.15	3.39 147.28	1.49 325.38	1.01 146.88	0.15 168.45	0.10 337.14	0.03 206.51	0.06 128.22	Mag Phase
256	9.97	16.19	5.69 21.62	6.14 39.66	7.43 294.75	4.94 175.36	1.96 328.94	2.01 176.79	0.72 246.86	0.38 274.61	0.23 291.82	0.08 119.62	Mag Phase

Table V. - Continued

(h) Continued

Run 9

 $\mu_{\text{Nom.}} = 0.30$ 

POINT	MEAN	1/2P-P	1P	2P	3P	4P	5P	6P	7P	8P	9P	10P	
257	9.94	20.27	6.39 23.69	7.32 30.84	8.65 294.55	6.61 187.14	2.29 344.22	3.61 189.40	1.61 271.81	0.34 247.73	0.39 298.04	0.10 97.69	Mag Phase
258	9.14	23.69	7.55 27.64	7.86 26.50	9.08 294.32	8.00 201.28	2.94 38.25	7.56 198.12	2.96 276.75	0.87 234.01	0.69 318.47	0.13 123.60	Mag Phase
259	10.04	15.84	5.78 22.81	6.15 42.33	7.39 299.11	4.73 179.12	2.18 329.89	1.78 186.15	0.74 263.30	0.48 293.34	0.22 300.39	0.11 142.87	Mag Phase
260	7.65	6.91	4.56 18.96	2.16 48.68	2.47 282.46	2.54 133.15	0.86 337.83	0.70 135.88	0.16 122.84	0.14 28.65	0.02 221.88	0.06 114.78	Mag Phase
261	6.87	6.55	4.41 21.11	1.68 56.57	2.04 279.22	2.05 131.07	0.60 325.90	0.59 116.70	0.21 129.89	0.11 15.47	0.02 136.17	0.04 105.37	Mag Phase
262	8.01	7.57	4.87 18.49	2.82 60.80	2.87 295.92	2.53 139.69	1.07 324.70	0.62 148.31	0.10 229.58	0.13 16.79	0.02 17.61	0.02 117.84	Mag Phase
263	9.29	11.11	5.42 20.44	4.59 52.46	5.26 296.36	3.58 163.35	1.73 316.92	0.97 174.87	0.33 240.13	0.21 325.10	0.12 299.62	0.05 194.09	Mag Phase
264	10.00	18.79	6.21 21.69	6.69 33.87	8.60 296.12	5.44 185.76	2.31 325.43	2.62 192.69	1.14 260.32	0.23 274.52	0.31 307.62	0.02 248.61	Mag Phase
265	9.77	21.60	6.97 20.67	7.62 21.92	9.25 291.21	6.47 189.22	2.85 318.58	4.41 194.36	2.19 264.93	0.41 247.95	0.49 296.28	0.10 119.22	Mag Phase
266	9.05	21.16	7.96 18.92	8.02 19.45	8.69 291.25	6.05 192.97	4.30 329.58	4.70 192.68	2.71 272.13	0.75 270.18	0.65 306.05	0.08 114.94	Mag Phase

Table V. - Continued

(h) Continued

Run 9

$\mu_{Nom.} = 0.30$

POINT	MEAN	1/2P-P	1P	2P	3P	4P	5P	6P	7P	8P	9P	10P	
267	9.38	11.23	5.39 21.49	4.67 55.15	5.32 300.25	3.70 169.10	1.61 322.36	1.10 181.50	0.39 249.99	0.26 314.63	0.11 304.28	0.07 166.09	Mag Phase
268	6.94	6.66	4.41 20.40	1.70 53.42	2.13 276.35	2.19 129.25	0.68 327.58	0.56 106.18	0.21 122.80	0.12 30.39	0.02 106.71	0.04 94.90	Mag Phase

$\mu_{Nom.} = 0.35$

POINT	MEAN	1/2P-P	1P	2P	3P	4P	5P	6P	7P	8P	9P	10P	
269	6.21	10.73	4.84 25.16	3.28 19.58	4.32 262.06	3.66 135.03	0.56 294.58	1.05 119.02	0.47 143.20	0.04 168.17	0.16 77.72	0.08 87.35	Mag Phase
270	8.68	15.58	6.07 23.22	5.92 34.78	6.68 280.88	5.28 148.25	1.19 316.17	2.17 128.72	0.67 186.85	0.25 232.56	0.06 109.27	0.04 85.64	Mag Phase
271	9.42	19.24	6.74 26.64	6.98 29.83	8.06 282.57	6.21 156.72	2.11 329.84	2.53 141.02	1.35 219.87	0.23 272.85	0.16 206.30	0.06 3.68	Mag Phase
272	8.61	15.59	6.03 24.29	5.86 35.72	6.66 282.37	5.32 150.39	1.30 317.52	2.07 133.53	0.64 197.81	0.20 249.95	0.05 158.10	0.03 140.11	Mag Phase
273	6.22	11.11	4.81 25.14	3.35 17.51	4.45 259.41	3.88 132.34	0.60 299.48	1.02 111.36	0.45 138.81	0.07 153.90	0.15 76.56	0.05 86.70	Mag Phase
274	7.29	14.31	5.23 26.97	4.69 20.60	5.50 267.36	4.85 141.65	0.38 6.43	1.58 123.00	0.53 156.05	0.05 232.07	0.14 91.47	0.08 138.56	Mag Phase
275	8.37	16.43	5.76 24.81	5.87 25.50	6.68 271.81	5.56 141.45	0.85 327.58	2.09 111.61	0.78 156.35	0.16 239.00	0.16 74.65	0.04 240.47	Mag Phase



Table V. - Continued

(h) Concluded

Run 9

$\mu_{Nom.} = 0.35$

POINT	MEAN	1/2P-P	1P	2P	3P	4P	5P	6P	7P	8P	9P	10P	
276	8.99	17.77	6.03 27.79	6.41 31.63	7.36 279.97	6.05 151.73	1.35 332.39	2.66 124.08	0.96 188.66	0.20 268.27	0.11 125.70	0.06 285.93	Mag Phase
277	9.33	19.50	6.38 27.17	6.80 24.91	7.87 274.20	6.60 146.91	1.92 332.53	3.68 116.94	1.34 189.61	0.25 279.51	0.12 160.64	0.10 314.94	Mag Phase
278	7.20	13.57	5.18 26.74	4.45 15.22	5.14 259.46	4.54 132.08	0.15 275.76	1.40 120.70	0.58 139.95	0.06 351.14	0.11 58.49	0.07 163.53	Mag Phase

Table V. - Continued

(i) Blade flapwise bending moment, in-lbs, 63.00 percent radius

Run 9

$\mu_{Nom.} = 0.30$

POINT	MEAN	1/2P-P	1P	2P	3P	4P	5P	6P	7P	8P	9P	10P	
247	16.95	10.90	5.03 63.84	2.74 274.71	2.21 328.27	3.14 291.09	3.11 1.76	0.98 248.20	0.59 169.62	0.19 35.44	0.32 351.07	0.43 270.83	Mag Phase
248	19.44	11.26	5.74 54.14	5.92 242.34	4.15 281.35	3.67 316.85	0.74 3.64	0.79 263.09	0.52 200.96	0.09 152.70	0.50 1.35	0.71 275.76	Mag Phase
249	20.56	13.36	5.64 44.80	5.57 241.60	5.88 217.04	4.33 338.31	0.63 217.05	0.66 233.18	0.42 174.93	0.46 204.48	0.48 332.25	1.03 234.85	Mag Phase
250	21.23	16.63	5.51 37.47	4.84 248.40	7.43 192.53	5.65 353.00	1.31 152.40	0.89 230.98	0.39 176.76	0.64 189.70	0.58 324.14	1.12 230.24	Mag Phase
251	21.83	19.70	5.52 26.85	4.69 251.53	8.76 188.14	7.42 8.46	2.43 134.45	1.19 240.78	0.33 179.60	0.76 186.03	0.52 323.07	1.17 235.59	Mag Phase
252	19.56	11.69	5.87 53.34	6.01 240.76	4.15 282.70	3.68 314.01	0.94 2.75	0.71 254.26	0.48 191.67	0.14 177.87	0.53 0.85	0.73 274.57	Mag Phase
253	17.56	10.11	5.39 48.67	2.22 260.72	1.70 4.52	3.16 291.16	1.89 21.79	0.51 232.92	0.39 163.34	0.08 55.98	0.29 2.15	0.44 274.10	Mag Phase
254	19.96	10.54	6.04 47.96	4.60 236.32	3.39 302.91	3.38 303.11	1.22 44.52	0.41 248.85	0.47 176.36	0.25 131.16	0.40 338.39	0.58 267.26	Mag Phase
255	21.17	12.02	6.08 43.25	5.37 228.69	3.47 261.44	3.88 310.25	1.17 80.62	0.45 234.04	0.51 158.03	0.30 125.95	0.43 325.19	0.59 240.12	Mag Phase
256	22.47	15.39	5.72 37.11	4.36 236.91	6.58 196.16	4.76 338.96	1.81 108.88	0.78 208.23	0.58 143.59	0.33 147.31	0.44 313.02	0.73 230.46	Mag Phase

Table V. - Continued

(i) Continued

Run 9

 $\mu_{\text{Nom.}} = 0.30$ 

POINT	MEAN	1/2P-P	1P	2P	3P	4P	5P	6P	7P	8P	9P	10P	
257	22.97	18.72	5.40 27.83	4.10 250.58	8.54 182.51	6.49 354.38	3.39 108.27	1.25 209.49	0.54 139.09	0.42 156.49	0.32 300.94	0.79 227.18	Mag Phase
258	23.19	22.07	5.25 21.15	4.13 256.50	10.10 175.57	8.58 9.16	4.84 112.74	1.96 207.71	0.68 149.18	0.67 160.42	0.27 281.50	0.81 223.83	Mag Phase
259	22.47	15.56	5.69 37.74	4.47 239.92	6.55 202.19	4.76 341.74	1.69 106.43	0.89 221.41	0.51 149.49	0.30 154.49	0.43 329.80	0.77 249.96	Mag Phase
260	19.91	10.79	5.95 45.63	4.76 232.77	3.52 298.55	3.28 296.20	1.51 24.13	0.47 239.07	0.50 158.97	0.24 107.06	0.36 335.81	0.58 248.39	Mag Phase
261	20.23	9.38	5.85 42.36	3.72 217.32	3.41 298.34	2.62 294.01	1.57 41.00	0.35 243.66	0.37 157.71	0.15 104.61	0.24 347.18	0.33 269.21	Mag Phase
262	21.48	12.21	6.12 40.20	4.76 218.05	4.16 281.54	3.13 306.23	1.59 65.29	0.41 239.21	0.44 173.11	0.26 124.44	0.27 313.75	0.44 255.49	Mag Phase
263	22.81	12.93	6.07 35.00	4.65 217.24	4.25 231.82	3.69 325.32	2.09 110.95	0.49 226.37	0.42 161.95	0.17 125.51	0.15 317.22	0.42 251.08	Mag Phase
264	24.11	17.86	5.62 26.11	3.61 235.05	7.71 189.55	5.54 351.03	4.09 108.44	1.00 216.95	0.51 137.67	0.38 111.52	0.20 308.15	0.44 249.72	Mag Phase
265	24.49	20.84	5.43 15.57	3.68 246.97	9.18 182.34	6.46 350.84	4.62 86.28	1.70 212.42	0.46 132.68	0.33 107.45	0.19 281.91	0.47 219.25	Mag Phase
266	24.52	22.37	5.22 9.63	3.87 256.36	9.19 187.18	6.40 346.17	5.51 65.94	2.29 219.82	0.37 156.14	0.25 112.70	0.44 284.08	0.65 212.40	Phase

Table V. - Continued

(i) Continued

Run 9

 $\mu_{\text{Nom.}} = 0.30$ 

POINT	MEAN	1/2P-P	1P	2P	3P	4P	5P	6P	7P	8P	9P	10P	
267	22.98	12.83	6.18 37.18	4.47 220.42	4.24 230.22	3.69 332.44	2.06 110.10	0.50 227.69	0.45 166.84	0.12 107.98	0.23 319.48	0.41 261.67	Mag Phase
268	20.56	9.54	6.10 41.43	3.66 216.90	3.28 300.16	2.78 293.69	2.01 35.58	0.38 251.19	0.37 156.89	0.17 60.84	0.28 338.20	0.38 260.40	Mag Phase

 $\mu_{\text{Nom.}} = 0.35$ 

POINT	MEAN	1/2P-P	1P	2P	3P	4P	5P	6P	7P	8P	9P	10P	
269	20.75	13.15	7.27 48.24	2.15 318.98	1.97 120.08	4.23 301.05	3.96 36.83	0.98 237.60	0.76 168.15	0.19 24.39	0.50 43.29	0.31 312.65	Mag Phase
270	23.67	15.97	8.17 45.38	2.12 312.77	5.55 165.51	4.91 321.45	4.16 51.98	0.96 206.14	0.71 140.34	0.10 10.95	0.39 41.90	0.26 287.48	Mag Phase
271	25.12	20.10	7.78 39.85	3.11 312.82	7.91 165.81	6.27 331.74	5.95 59.83	1.48 197.07	0.70 126.84	0.39 14.59	0.41 35.53	0.34 264.12	Mag Phase
272	23.78	16.03	8.16 45.04	2.25 305.54	5.31 164.63	5.06 323.60	4.28 54.80	1.00 213.69	0.72 149.00	0.15 56.74	0.39 48.80	0.28 289.30	Mag Phase
273	21.02	14.02	7.47 48.70	2.31 317.44	2.29 110.41	4.41 299.92	4.13 35.04	1.06 228.65	0.78 160.56	0.13 15.25	0.46 41.14	0.23 311.99	Mag Phase
274	20.69	16.56	7.93 59.39	4.05 335.25	4.35 127.22	4.88 310.96	4.83 30.22	1.13 228.96	0.93 158.60	0.19 13.56	0.65 51.78	0.34 318.46	Mag Phase
275	22.16	17.58	8.38 53.22	3.86 324.20	5.83 142.37	5.41 314.59	4.81 26.72	1.18 206.09	0.91 138.80	0.16 2.67	0.58 37.73	0.46 270.23	Mag Phase

Table V. - Continued

(i) Concluded

Run 9

$\mu_{Nom.} = 0.35$

POINT	MEAN	1/2P-P	1P	2P	3P	4P	5P	6P	7P	8P	9P	10P	
276	23.03	19.13	8.34 52.68	3.90 321.63	7.00 154.83	5.89 326.14	5.27 41.01	1.37 209.44	0.96 141.72	0.24 18.41	0.57 49.81	0.49 281.43	Mag Phase
277	23.71	20.67	8.15 46.38	4.61 313.68	7.85 150.86	6.55 322.68	5.91 39.40	1.40 188.43	0.89 119.46	0.35 343.38	0.55 17.78	0.54 255.98	Mag Phase
278	20.49	17.25	7.78 60.36	4.10 338.42	3.80 115.48	5.01 298.40	5.51 20.66	1.25 227.36	1.06 155.94	0.26 359.00	0.67 41.18	0.40 305.41	Mag Phase

Table V. - Continued

(j) Blade flapwise bending moment, in-lbs, 74.00 percent radius

Run 9

$\mu_{Nom.} = 0.30$

POINT	MEAN	1/2P-P	1P	2P	3P	4P	5P	6P	7P	8P	9P	10P	
247	7.34	11.91	2.68 87.93	2.26 279.76	2.26 336.23	4.03 293.85	3.80 2.30	0.96 136.34	0.66 327.82	2.78 113.95	0.47 36.54	0.10 19.93	Mag Phase
248	8.15	13.49	2.31 58.99	5.94 258.13	4.23 266.64	4.95 331.60	1.45 342.76	1.35 125.09	0.71 316.00	2.83 100.68	0.15 6.81	0.15 33.11	Mag Phase
249	8.21	19.89	1.55 37.07	6.52 257.03	6.77 207.33	6.95 352.18	1.23 277.23	2.05 96.50	1.57 267.01	4.64 57.16	0.34 272.33	0.04 358.06	Mag Phase
250	8.51	25.32	1.24 8.02	6.18 261.41	8.71 185.14	9.43 3.39	0.41 174.39	2.16 94.30	1.55 263.46	5.35 40.96	0.30 292.53	0.10 305.13	Mag Phase
251	8.87	29.94	1.69 331.89	6.66 263.91	10.39 182.52	12.59 15.02	1.62 116.42	2.03 102.08	1.95 266.52	5.79 32.81	0.48 301.51	0.23 279.95	Mag Phase
252	8.16	13.95	2.28 57.93	6.03 255.67	4.22 268.54	4.98 327.64	1.67 342.55	1.33 118.54	0.75 307.53	2.91 95.00	0.11 350.46	0.13 40.12	Mag Phase
253	8.84	9.52	2.86 67.06	1.60 255.87	1.86 22.95	4.05 293.96	2.02 22.64	0.99 139.49	0.14 291.55	2.05 102.44	0.42 12.67	0.10 331.44	Mag Phase
254	9.44	9.73	2.90 55.16	4.37 247.56	2.69 287.91	4.19 311.76	1.24 42.37	1.16 112.64	0.68 312.85	1.92 73.45	0.29 13.83	0.08 324.23	Mag Phase
255	9.82	11.86	2.62 44.84	5.45 242.54	3.48 237.56	5.22 322.47	0.94 80.94	1.31 103.75	1.09 281.65	2.12 61.86	0.11 2.99	0.12 316.65	Mag Phase
256	9.98	18.50	1.55 22.70	5.53 249.92	8.08 186.00	7.43 351.89	1.55 106.61	1.84 104.97	1.56 262.32	2.43 43.06	0.29 339.14	0.21 262.42	Mag Phase

Table V. - Continued

(j) Continued

Run 9

 $\mu_{\text{Nom.}} = 0.30$ 

POINT	MEAN	1/2P-P	1P	2P	3P	4P	5P	6P	7P	8P	9P	10P	
257	10.19	23.83	1.38 335.06	5.60 255.61	10.43 174.24	10.49 3.51	3.41 101.47	1.93 115.67	1.71 253.95	2.86 19.60	0.51 341.57	0.27 259.23	Mag Phase
258	10.34	28.43	1.80 301.65	5.86 259.57	12.06 169.91	14.42 15.49	5.02 106.44	1.91 139.87	2.47 269.12	3.59 355.81	0.64 339.70	0.47 251.59	Mag Phase
259	9.99	18.17	1.59 19.21	5.51 252.50	7.90 191.71	7.28 354.03	1.41 109.34	1.75 114.78	1.60 269.27	2.61 55.19	0.34 349.39	0.19 276.39	Mag Phase
260	9.38	10.25	2.85 54.72	4.39 244.81	2.86 285.03	4.07 305.09	1.62 18.55	1.17 107.47	0.64 294.55	1.97 67.21	0.28 348.65	0.09 303.04	Mag Phase
261	10.37	8.76	3.02 52.32	3.19 230.53	2.73 284.32	3.01 299.11	1.70 46.81	0.83 120.48	0.26 280.31	1.49 76.33	0.27 9.20	0.02 318.61	Mag Phase
262	10.63	11.42	2.89 44.69	4.47 234.55	3.70 262.74	3.83 316.36	1.76 68.83	0.93 127.92	0.51 276.97	1.32 54.02	0.28 10.63	0.04 303.36	Mag Phase
263	11.00	13.09	2.44 30.00	4.96 235.94	4.94 211.15	5.19 339.32	2.34 114.57	1.26 129.50	0.98 261.17	0.93 74.95	0.20 26.44	0.15 283.40	Mag Phase
264	11.41	17.94	1.90 345.49	5.00 247.45	9.43 179.65	8.67 1.85	4.67 107.66	1.58 139.93	1.48 259.56	0.79 335.68	0.56 25.43	0.22 263.14	Mag Phase
265	11.52	20.90	2.32 313.31	5.32 251.61	11.11 173.04	10.46 0.42	5.48 82.67	1.53 141.19	1.82 255.72	0.92 300.70	0.77 348.16	0.31 237.89	Mag Phase
266	11.44	22.93	3.02 299.82	5.84 257.52	11.14 178.02	10.57 355.94	6.85 64.96	1.58 159.18	1.75 257.69	1.17 312.21	0.98 330.05	0.40 245.69	Phase

Table V. - Continued

(j) Continued

Run 9

$\mu_{Nom.} = 0.30$

POINT	MEAN	1/2P-P	1P	2P	3P	4P	5P	6P	7P	8P	9P	10P	
267	11.02	13.11	2.46	5.00	5.12	5.26	2.19	1.27	1.09	0.87	0.13	0.18	Mag Phase
			31.48	239.84	211.16	345.41	113.20	132.56	270.33	95.92	38.22	284.50	
268	10.38	9.35	3.02	3.30	2.63	3.37	2.24	0.80	0.15	1.35	0.36	0.10	Mag Phase
			51.26	230.65	286.51	298.97	39.98	119.01	248.56	84.40	4.60	328.48	

$\mu_{Nom.} = 0.35$

POINT	MEAN	1/2P-P	1P	2P	3P	4P	5P	6P	7P	8P	9P	10P	
269	11.32	15.23	3.74	1.26	2.58	5.92	4.76	1.39	0.83	3.34	0.43	0.30	Mag Phase
			67.05	300.29	109.12	301.64	31.35	175.04	4.91	140.13	40.60	309.96	
270	12.38	16.18	3.41	2.00	6.47	6.66	4.89	1.49	0.89	2.66	0.48	0.24	Mag Phase
			59.98	283.45	157.48	326.70	41.78	153.79	293.59	128.39	12.41	246.98	
271	13.04	21.65	2.21	2.80	9.14	8.80	7.04	1.94	1.77	3.13	0.62	0.31	Mag Phase
			47.47	286.03	158.28	337.61	52.49	149.26	257.83	159.84	358.08	247.19	
272	12.50	16.21	3.42	2.22	6.30	6.82	5.07	1.55	1.01	2.41	0.57	0.31	Mag Phase
			57.85	279.00	156.37	328.35	46.07	158.58	287.34	134.33	19.40	275.09	
273	11.29	15.77	3.79	1.39	2.95	6.19	4.83	1.46	0.81	3.25	0.50	0.30	Mag Phase
			66.28	300.77	99.48	299.44	29.08	171.92	0.39	133.89	33.77	299.19	
274	10.26	19.08	3.99	2.37	5.12	6.96	5.71	1.55	1.41	3.95	0.54	0.33	Mag Phase
			83.59	330.63	115.74	311.88	20.71	162.33	350.13	135.89	14.33	292.28	
275	11.04	18.26	3.80	2.44	6.70	7.50	5.75	1.71	1.14	3.78	0.69	0.33	Mag Phase
			77.54	307.67	133.94	317.45	14.94	146.88	320.54	120.79	339.90	254.37	



Table V. - Continued

(j) Concluded

Run 9

$\mu_{Nom.} = 0.35$

POINT	MEAN	1/2P-P	1P	2P	3P	4P	5P	6P	7P	8P	9P	10P	
276	11.49	20.01	3.42 77.09	2.66 301.99	7.93 147.58	8.14 329.96	6.29 28.36	1.90 154.88	1.24 306.62	3.85 138.90	0.77 358.00	0.32 264.49	Mag Phase
277	11.81	22.28	2.78 69.96	3.34 294.68	8.98 143.50	9.12 327.27	7.06 27.68	1.93 139.60	1.58 261.56	4.01 127.89	0.67 339.19	0.30 217.68	Mag Phase
278	10.11	20.81	4.01 88.64	2.41 338.61	4.43 103.13	7.24 299.51	6.62 11.76	1.48 157.68	1.50 345.82	4.65 129.98	0.63 7.20	0.39 289.21	Mag Phase

Table V. - Continued

(k) Blade chordwise bending moment, in-lbs, 77.23 percent radius

Run 9

 $\mu_{\text{Nom.}} = 0.30$ 

POINT	MEAN	1/2P-P	1P	2P	3P	4P	5P	6P	7P	8P	9P	10P	
247	-40.55	9.50	2.89 295.70	0.53 57.88	1.25 301.86	1.41 270.38	2.53 3.29	3.35 323.93	1.11 332.07	1.49 98.78	1.03 343.08	0.18 110.45	Mag Phase
248	-38.12	12.12	4.98 310.36	0.82 96.49	1.90 246.41	1.07 288.92	4.27 354.76	2.53 351.46	0.10 316.55	2.03 106.48	1.05 89.89	0.50 33.06	Mag Phase
249	-35.81	16.47	6.30 314.07	0.76 63.93	3.06 192.35	1.77 235.71	2.83 0.38	6.46 351.05	0.38 108.55	3.64 76.60	1.39 176.22	0.74 19.94	Mag Phase
250	-34.56	19.37	6.92 318.15	1.30 13.23	3.56 171.17	2.34 226.29	3.65 57.78	7.57 352.46	1.37 89.31	4.39 35.92	2.14 191.04	0.65 356.74	Mag Phase
251	-33.47	21.34	7.71 327.57	1.70 6.96	4.52 167.43	2.47 249.59	5.40 67.20	8.48 8.89	1.90 121.89	3.26 38.16	2.65 219.61	1.36 344.63	Mag Phase
252	-37.23	12.99	5.14 308.74	0.96 102.35	1.93 243.23	1.02 297.13	4.41 353.63	2.83 346.49	0.10 170.60	2.71 90.21	1.01 85.07	0.32 11.62	Mag Phase
253	-37.22	7.48	2.86 303.06	0.38 81.36	0.51 318.43	0.99 237.47	3.40 344.04	1.37 313.33	0.95 309.31	0.52 122.89	0.69 306.48	0.12 277.62	Mag Phase
254	-35.96	12.49	4.82 306.38	0.53 87.95	1.54 261.93	0.79 289.80	4.86 355.90	1.02 327.40	0.36 349.29	1.22 30.46	1.99 28.69	0.20 306.27	Mag Phase
255	-34.56	14.23	5.81 307.01	0.84 102.09	2.16 214.57	0.76 236.32	5.81 344.25	4.30 16.14	0.05 326.86	0.99 94.31	1.53 77.29	0.76 6.18	Mag Phase
256	-32.10	19.61	6.34 315.32	1.06 12.28	3.83 173.31	2.27 196.63	2.65 8.27	8.54 11.43	1.36 41.84	0.84 47.40	1.67 156.38	0.77 46.85	Mag Phase

Table V. - Continued

(k) Continued

Run 9

 $\mu_{\text{Nom.}} = 0.30$ 

POINT	MEAN	1/2P-P	1P	2P	3P	4P	5P	6P	7P	8P	9P	10P	
257	-31.06	23.31	6.84 321.65	1.86 344.38	4.53 159.68	2.49 207.18	3.72 50.70	10.67 18.82	2.50 63.59	1.74 17.69	2.65 179.08	0.71 15.96	Mag Phase
258	-30.11	37.51	7.36 333.23	2.05 328.30	5.46 153.84	1.45 229.76	8.15 73.99	21.29 34.24	4.77 81.68	1.07 336.00	4.51 208.26	1.66 5.31	Mag Phase
259	-32.37	19.96	6.28 316.76	0.88 18.28	3.81 178.69	2.19 208.97	3.00 342.17	8.91 20.28	1.49 63.72	1.86 94.02	1.68 163.72	0.68 53.43	Mag Phase
260	-35.90	12.91	4.74 303.69	0.59 76.98	1.48 260.70	0.80 281.49	5.41 346.17	1.58 312.83	0.39 339.82	0.41 117.22	1.79 15.72	0.26 309.00	Mag Phase
261	-35.91	11.41	4.16 308.20	0.52 94.83	1.46 259.87	0.75 284.84	5.07 349.75	1.50 332.43	0.39 31.89	1.16 103.58	1.64 355.76	0.11 256.57	Mag Phase
262	-35.10	13.65	5.29 310.34	0.68 97.90	1.97 233.14	0.37 295.92	6.30 342.37	3.10 22.95	0.57 81.20	0.33 9.54	2.06 41.39	0.39 19.30	Mag Phase
263	-33.76	17.90	6.18 311.29	0.83 60.15	3.08 195.94	1.10 190.00	5.86 334.39	7.35 35.31	0.78 84.37	1.32 176.77	1.74 89.48	0.62 55.04	Mag Phase
264	-31.53	25.84	6.42 320.08	1.60 348.11	4.49 168.73	2.18 190.05	3.57 346.30	12.63 33.89	2.57 67.24	2.10 262.19	2.25 139.11	0.94 61.53	Mag Phase
265	-30.52	36.25	6.62 327.21	2.32 328.10	5.41 158.24	2.67 201.30	5.82 330.79	20.31 32.21	4.53 76.41	1.83 240.07	2.09 165.44	1.18 28.86	Mag Phase
266	-30.09	52.94	6.69 336.05	2.52 322.09	6.01 160.78	3.09 221.95	12.26 327.55	29.57 36.68	6.69 94.62	0.92 269.03	1.19 233.15	0.70 40.86	Phase

Table V. - Continued

(k) Continued

Run 9

 $\mu_{\text{Nom.}} = 0.30$ 

POINT	MEAN	1/2P-P	1P	2P	3P	4P	5P	6P	7P	8P	9P	10P	
267	-34.51	17.83	6.06 315.32	0.78 64.08	3.09 198.69	1.12 196.05	5.02 329.34	7.74 33.26	0.73 77.79	1.77 152.64	1.75 95.29	0.37 41.47	Mag Phase
268	-36.91	11.39	3.86 310.25	0.71 94.83	1.41 258.47	0.86 270.79	5.92 347.09	0.64 335.88	0.24 31.42	1.23 108.76	1.52 336.04	0.30 226.04	Mag Phase

 $\mu_{\text{Nom.}} = 0.35$ 

POINT	MEAN	1/2P-P	1P	2P	3P	4P	5P	6P	7P	8P	9P	10P	
269	-36.83	13.18	3.95 308.55	0.61 330.09	0.33 166.51	1.01 248.74	6.74 326.43	3.71 306.74	1.70 334.60	0.67 125.46	1.51 270.21	0.41 254.34	Mag Phase
270	-34.92	21.62	6.38 311.01	1.52 325.86	2.19 159.79	0.90 181.96	7.47 334.39	8.05 325.64	3.10 17.14	2.02 99.50	1.94 339.21	0.17 42.31	Mag Phase
271	-33.21	29.09	6.59 317.04	2.21 320.04	3.57 147.96	2.54 195.21	8.10 335.31	13.20 342.61	3.84 30.98	3.14 164.06	2.38 20.00	0.96 50.02	Mag Phase
272	-35.35	20.66	6.45 312.26	1.36 321.57	2.11 161.55	1.04 183.12	7.45 336.97	8.80 336.57	3.08 18.70	0.68 163.29	1.71 336.78	0.17 52.58	Mag Phase
273	-37.38	12.87	4.08 308.69	0.62 317.78	0.33 157.56	1.09 238.96	6.34 315.93	2.82 303.21	1.86 329.37	0.51 21.78	1.21 277.26	0.37 259.22	Mag Phase
274	-37.23	16.24	4.43 304.54	1.06 329.74	0.89 113.78	1.50 242.98	6.79 331.10	5.51 305.63	2.91 343.44	1.01 96.66	1.90 301.53	0.52 322.11	Mag Phase
275	-36.18	20.97	5.82 306.06	1.40 311.21	1.74 128.42	1.31 235.78	8.04 323.70	7.81 305.05	3.21 350.25	1.36 96.93	2.29 306.40	0.37 9.51	Mag Phase

Table V. - Continued

(k) Concluded

Run 9

$\mu_{Nom.} = 0.35$

POINT	MEAN	1/2P-P	1P	2P	3P	4P	5P	6P	7P	8P	9P	10P	
276	-35.37	23.16	6.19 311.26	1.81 309.15	2.42 135.99	1.61 218.87	8.96 337.78	9.47 320.82	3.42 12.50	1.21 152.59	1.99 341.01	0.47 56.90	Mag Phase
277	-34.28	27.18	6.29 313.33	2.21 304.95	3.12 128.36	2.62 210.36	9.09 333.34	11.57 314.62	3.65 3.66	3.32 126.67	1.64 357.36	0.54 356.89	Mag Phase
278	-37.77	15.80	4.39 302.66	1.13 342.62	0.85 91.00	1.63 247.67	6.68 315.14	5.63 300.86	2.84 333.23	1.54 99.01	1.94 301.93	0.32 329.48	Mag Phase

Table V. - Continued

(I) Fixed-system strain-gage balance normal force, lbs

Run 9

$\mu_{Nom.} = 0.30$

POINT	MEAN	1/2P-P	1P	2P	3P	4P	5P	6P	7P	8P	9P	10P	
247	123.17	60.09	29.83 196.73	12.75 20.63	5.14 106.68	6.51 346.55	8.78 148.09	4.58 236.67	2.55 72.75	17.58 302.00	4.17 2.37	3.04 85.56	Mag Phase
248	186.94	68.63	49.13 197.96	9.90 54.09	6.64 93.35	13.11 76.95	12.96 24.45	5.81 263.81	4.50 84.92	11.79 272.31	4.09 230.63	3.17 241.30	Mag Phase
249	218.19	104.27	72.06 193.62	10.12 147.74	6.97 55.75	19.82 41.23	13.12 291.13	4.86 168.54	8.36 66.42	10.88 187.98	9.69 109.75	1.74 83.28	Mag Phase
250	230.11	125.66	80.32 197.46	12.94 180.70	8.28 56.80	24.42 30.07	17.23 274.47	7.15 155.99	5.34 90.23	20.24 171.24	15.30 138.60	7.49 154.61	Mag Phase
251	241.82	127.67	86.08 205.34	16.81 203.57	7.67 66.05	32.91 20.56	24.53 167.15	6.27 183.15	1.28 30.49	17.55 190.78	5.97 166.96	13.32 194.24	Mag Phase
252	186.74	70.70	49.25 194.24	10.09 55.90	6.03 102.32	14.16 75.27	11.24 23.10	5.87 251.49	4.74 72.19	14.45 264.58	4.12 214.66	1.95 210.42	Mag Phase
253	91.24	51.48	34.79 195.63	11.36 31.27	7.22 80.52	4.89 358.48	4.04 120.55	4.08 180.77	0.72 131.66	9.59 288.01	4.18 334.09	3.18 55.56	Mag Phase
254	156.63	66.89	49.40 193.00	11.03 60.83	8.90 68.82	16.46 82.73	9.76 37.28	4.80 200.19	2.90 113.74	10.40 246.01	2.54 168.66	0.76 238.10	Mag Phase
255	186.64	86.58	60.94 191.56	11.33 80.04	9.04 39.16	20.44 63.34	18.14 333.06	1.85 159.97	7.70 38.73	4.81 227.00	3.07 15.52	4.30 314.96	Mag Phase
256	216.55	117.22	76.53 205.14	7.17 177.47	12.27 47.75	26.51 23.43	25.61 287.88	3.64 105.27	5.98 92.58	12.98 176.33	8.73 152.45	7.67 212.01	Mag Phase

Table V. - Continued

(I) Continued

Run 9

 $\mu_{\text{Nom.}} = 0.30$ 

POINT	MEAN	1/2P-P	1P	2P	3P	4P	5P	6P	7P	8P	9P	10P	
257	227.60	130.61	83.94 210.08	11.14 205.13	11.69 38.07	32.20 15.76	29.32 267.53	3.63 134.56	2.43 147.70	12.78 184.14	5.28 221.58	12.01 225.28	Mag Phase
258	237.62	149.67	87.73 217.05	15.33 223.54	12.79 25.89	40.39 17.08	73.83 255.04	7.90 132.34	7.04 198.45	3.36 169.55	3.73 44.24	16.47 227.97	Mag Phase
259	216.16	116.94	76.63 205.82	6.24 162.73	11.71 38.02	29.05 28.42	23.14 290.60	5.46 130.15	7.40 92.89	13.09 183.61	8.85 164.75	6.20 225.22	Mag Phase
260	157.78	59.37	46.62 189.65	11.33 58.50	7.69 66.99	15.00 78.78	8.61 44.61	5.71 199.06	3.06 101.35	9.77 238.02	1.54 180.54	0.73 225.90	Mag Phase
261	127.39	56.35	47.55 190.50	11.84 55.85	9.36 64.16	13.17 86.68	7.74 94.44	5.04 191.26	1.97 130.77	7.98 242.44	2.03 184.53	1.35 300.70	Mag Phase
262	160.90	79.88	56.36 190.50	13.54 73.34	9.19 37.81	20.33 73.90	13.14 343.80	0.22 239.59	2.90 38.04	3.19 212.49	1.90 113.61	3.49 355.13	Mag Phase
263	190.40	112.23	69.43 198.34	10.14 108.12	12.83 35.68	23.53 62.35	21.97 317.29	1.75 71.94	7.48 65.46	3.77 191.61	4.67 71.99	5.19 352.97	Mag Phase
264	216.28	130.91	80.95 215.66	6.58 203.97	14.01 41.04	32.75 33.72	34.62 287.57	4.92 97.80	3.51 138.92	7.66 235.35	6.12 244.38	15.45 264.44	Mag Phase
265	226.69	155.71	82.66 220.91	6.25 236.33	15.52 33.28	37.51 22.65	48.96 271.74	9.27 94.44	4.96 199.39	5.45 315.25	4.35 28.04	19.55 274.54	Mag Phase
266	234.26	179.36	84.69 225.71	5.07 291.40	21.29 33.63	41.15 14.24	69.71 281.39	14.05 97.18	4.30 221.10	2.21 301.83	14.86 97.28	23.10 288.05	Mag Phase

Table V. - Continued

(I) Continued

Run 9

 $\mu_{\text{Nom.}} = 0.30$ 

POINT	MEAN	1/2P-P	1P	2P	3P	4P	5P	6P	7P	8P	9P	10P	
267	191.50	112.92	70.81	7.65	11.70	20.74	21.67	0.64	7.77	8.18	6.07	1.29	Mag
			203.50	116.51	39.99	60.23	311.52	73.82	81.00	183.54	131.61	359.68	Phase
268	128.68	59.38	49.10	11.23	10.24	13.46	8.44	5.86	2.01	7.51	1.48	1.41	Mag
			190.27	58.13	73.42	82.14	78.90	196.77	118.66	230.95	179.31	280.43	Phase

 $\mu_{\text{Nom.}} = 0.35$ 

POINT	MEAN	1/2P-P	1P	2P	3P	4P	5P	6P	7P	8P	9P	10P	
269	96.96	100.20	64.41	11.79	13.01	13.23	10.87	6.45	2.34	23.83	3.94	5.91	Mag
			211.05	8.99	46.93	302.79	216.47	262.84	222.26	350.38	13.92	17.00	Phase
270	159.58	127.15	89.85	2.19	15.93	17.85	19.08	4.47	5.58	13.10	3.48	7.48	Mag
			209.91	260.46	10.54	10.09	257.56	321.13	106.70	344.33	44.40	305.01	Phase
271	184.21	154.39	100.07	5.91	16.32	28.36	29.04	1.59	9.76	6.57	0.32	8.57	Mag
			212.33	235.15	2.72	17.55	261.83	18.37	116.51	15.60	21.50	295.60	Phase
272	158.93	127.25	89.57	1.76	16.89	15.52	19.65	5.06	6.87	10.73	3.50	6.86	Mag
			209.60	348.63	7.23	10.07	268.42	322.37	92.21	346.37	53.85	313.55	Phase
273	98.03	104.08	66.65	11.61	14.51	12.26	8.24	5.51	3.22	24.49	6.97	6.87	Mag
			208.22	19.59	40.75	307.52	219.47	267.27	216.68	343.71	348.74	356.60	Phase
274	131.48	107.77	67.98	4.85	11.72	12.40	12.81	7.42	3.57	28.42	6.58	11.10	Mag
			210.74	3.69	24.85	330.94	248.98	276.78	166.94	330.62	342.28	316.62	Phase
275	158.86	122.81	86.31	0.83	15.40	18.02	17.48	6.38	5.37	18.94	3.29	7.31	Mag
			206.70	205.29	358.05	347.87	253.60	283.08	90.08	309.81	325.76	274.03	Phase



Table V. - Continued

(l) Concluded

Run 9

$\mu_{Nom.} = 0.35$

POINT	MEAN	1/2P-P	1P	2P	3P	4P	5P	6P	7P	8P	9P	10P	
276	175.16	139.05	95.69	3.50	18.62	23.10	22.29	5.45	7.14	15.01	2.89	7.01	Mag
			208.30	183.44	358.28	2.41	258.08	294.13	91.57	334.06	12.45	317.72	Phase
277	186.27	151.80	101.83	6.98	15.81	27.18	26.55	2.42	8.07	10.81	2.09	6.63	Mag
			206.93	199.93	352.73	6.87	243.94	216.79	94.78	320.79	181.36	252.35	Phase
278	128.99	112.18	67.07	7.30	10.41	18.50	11.68	6.66	4.65	30.44	5.78	9.90	Mag
			211.90	10.64	28.41	321.65	240.97	278.74	150.01	325.50	348.65	325.38	Phase

Table V. - Continued

(m) Fixed-system strain-gage balance axial force, lbs

Run 9

$\mu_{Nom.} = 0.30$

POINT	MEAN	1/2P-P	1P	2P	3P	4P	5P	6P	7P	8P	9P	10P	
247	2.69	19.97	2.90 209.89	3.48 241.89	10.88 140.08	1.12 44.60	3.58 340.86	3.23 285.29	3.48 118.52	2.11 321.31	0.58 26.11	1.05 158.60	Mag Phase
248	-0.56	21.96	8.74 215.30	3.36 107.02	5.27 102.31	5.04 123.29	2.75 262.66	2.78 175.04	5.75 128.59	1.58 285.43	2.05 305.35	3.32 88.40	Mag Phase
249	-2.14	36.28	15.49 217.94	8.96 70.80	10.35 342.20	8.77 87.48	1.84 66.28	3.98 212.49	12.24 82.46	2.24 199.40	1.35 294.70	6.73 17.75	Mag Phase
250	-3.35	48.68	18.59 224.74	11.51 88.89	16.75 5.69	9.62 85.37	1.86 86.59	6.08 222.85	11.22 78.32	2.72 147.95	2.17 45.52	10.72 28.91	Mag Phase
251	-3.91	62.01	21.50 233.45	12.68 108.59	22.91 17.75	10.27 95.40	4.75 34.81	11.97 224.35	5.34 161.52	0.49 94.50	1.09 135.52	5.93 43.34	Mag Phase
252	0.02	19.84	8.89 212.14	3.28 63.09	4.04 138.82	5.15 118.19	2.29 272.96	1.33 215.34	4.43 97.08	1.54 264.71	1.63 257.88	2.81 103.06	Mag Phase
253	-3.88	22.80	3.72 201.68	2.42 243.56	17.54 111.93	0.79 133.36	2.73 303.20	3.67 301.63	0.62 104.30	1.78 329.24	0.96 288.84	1.36 246.75	Mag Phase
254	-6.75	25.57	8.61 204.01	3.53 63.60	10.53 102.73	6.57 130.12	4.30 281.87	1.99 332.67	2.25 352.10	1.47 249.55	0.49 177.48	1.88 50.94	Mag Phase
255	-8.08	26.67	12.60 208.66	5.46 41.13	5.66 357.25	7.95 111.50	0.62 20.89	3.20 229.26	4.53 102.59	0.74 207.62	1.31 241.65	1.56 349.59	Mag Phase
256	-10.28	61.54	18.47 225.36	9.06 122.45	27.78 11.15	9.58 98.46	4.06 62.49	10.49 216.17	11.50 147.31	1.67 242.12	2.99 77.61	9.89 68.54	Mag Phase

Table V. - Continued

(m) Continued

Run 9

 $\mu_{\text{Nom.}} = 0.30$ 

POINT	MEAN	1/2P-P	1P	2P	3P	4P	5P	6P	7P	8P	9P	10P	
257	-11.38	69.17	21.18 232.13	11.85 120.72	33.71 13.30	9.28 95.73	5.80 37.92	13.98 220.28	7.05 206.40	1.11 222.12	3.91 114.71	6.63 74.17	Mag Phase
258	-12.42	87.81	23.68 240.32	13.21 126.27	39.35 10.08	9.87 96.05	12.59 41.60	25.45 247.70	9.82 295.45	0.33 246.11	2.12 82.49	5.29 7.72	Mag Phase
259	-10.47	55.97	18.03 226.62	8.01 115.29	26.08 2.82	8.94 101.25	4.55 51.77	9.21 241.59	8.83 162.58	2.45 250.75	2.02 86.13	9.40 74.96	Mag Phase
260	-6.71	25.45	8.06 201.63	2.61 39.26	10.24 100.17	6.08 127.63	4.95 289.58	3.44 335.74	2.82 357.13	1.64 267.93	0.66 305.20	0.63 2.92	Mag Phase
261	-13.42	29.58	8.93 200.03	1.92 67.83	11.17 121.23	5.47 141.50	6.25 299.49	5.38 335.10	3.03 345.37	2.11 263.08	1.89 52.53	1.53 80.12	Mag Phase
262	-14.91	24.97	12.13 206.45	3.78 39.05	4.69 48.79	8.67 127.75	3.10 285.88	2.35 278.79	1.58 110.04	1.63 273.15	1.34 44.09	1.55 61.11	Mag Phase
263	-16.77	36.85	16.74 213.49	5.54 79.08	19.15 14.27	9.79 119.38	2.40 61.89	4.54 235.03	3.25 126.48	2.54 275.39	1.87 9.11	4.36 47.54	Mag Phase
264	-18.64	75.10	21.83 231.57	11.36 143.81	34.62 19.17	9.32 117.62	6.57 58.64	14.15 246.37	15.01 217.49	4.06 274.04	5.59 117.80	8.43 124.37	Mag Phase
265	-20.01	86.89	23.98 236.73	12.95 151.50	42.32 17.16	8.98 100.40	11.96 45.29	22.39 252.08	12.42 264.36	6.18 248.44	2.53 114.76	4.01 115.07	Mag Phase
266	-21.86	107.31	27.18 241.56	15.62 172.28	49.25 21.41	8.06 91.47	17.50 61.29	31.27 274.32	10.24 305.96	9.94 232.57	3.65 95.12	4.17 107.98	Mag Phase

Table V. - Continued

(m) Continued

Run 9

 $\mu_{\text{Nom.}} = 0.30$ 

POINT	MEAN	1/2P-P	1P	2P	3P	4P	5P	6P	7P	8P	9P	10P	
267	-16.67	41.63	17.28 216.71	3.90 105.66	18.70 7.62	9.41 125.93	3.32 44.08	4.37 214.44	8.49 144.19	2.16 246.00	3.48 27.69	7.97 73.17	Mag Phase
268	-13.26	34.26	8.93 200.30	2.19 41.51	17.00 115.08	5.78 139.89	6.64 293.59	5.26 336.96	2.21 300.78	1.39 260.87	2.04 22.42	0.92 34.77	Mag Phase

 $\mu_{\text{Nom.}} = 0.35$ 

POINT	MEAN	1/2P-P	1P	2P	3P	4P	5P	6P	7P	8P	9P	10P	
269	-7.43	41.90	11.44 217.12	7.76 214.39	19.74 38.29	7.80 355.17	6.58 324.79	1.76 330.19	4.25 71.75	6.07 320.66	5.75 309.92	1.65 231.56	Mag Phase
270	-11.13	63.68	19.28 215.64	6.40 152.96	31.83 354.45	7.89 44.80	6.94 333.29	7.13 201.02	12.70 134.44	9.10 283.00	7.45 344.87	3.42 346.14	Mag Phase
271	-13.48	74.43	22.97 219.95	7.95 155.97	36.66 356.08	8.26 56.82	9.71 343.71	10.77 219.75	16.90 187.24	8.52 270.62	5.97 342.95	4.68 18.10	Mag Phase
272	-11.57	65.44	19.05 216.47	6.57 162.85	32.29 354.99	7.88 41.94	6.35 339.23	7.33 207.81	14.72 137.28	9.33 280.54	8.30 350.49	3.52 35.16	Mag Phase
273	-6.92	43.70	12.32 216.31	7.05 214.07	20.50 34.29	7.77 354.65	5.46 316.65	1.44 311.12	3.56 59.77	6.30 308.24	7.03 304.28	3.21 263.00	Mag Phase
274	-0.53	46.99	11.91 219.99	7.56 177.59	18.83 11.48	8.25 1.63	5.50 327.71	5.35 194.54	4.32 123.97	7.45 289.89	7.59 314.87	1.86 233.07	Mag Phase
275	-2.39	58.47	16.19 216.00	5.15 145.82	27.23 340.59	6.80 21.56	6.58 322.52	8.44 183.57	12.16 114.04	8.82 253.52	8.55 310.58	1.94 17.65	Mag Phase

Table V. - Continued

(m) Concluded

Run 9

$\mu_{Nom.} = 0.35$

POINT	MEAN	1/2P-P	1P	2P	3P	4P	5P	6P	7P	8P	9P	10P	
276	-3.24	65.46	18.61 217.48	6.02 123.89	36.68 341.50	7.59 46.11	8.18 340.83	7.83 193.07	13.46 151.45	8.82 270.60	7.78 343.81	4.32 20.11	Mag Phase
277	-4.49	61.71	20.32 216.99	5.90 108.27	32.87 343.27	7.98 47.43	9.73 329.22	9.14 203.16	13.76 153.40	8.56 240.95	5.43 314.43	4.57 4.65	Mag Phase
278	-0.34	46.28	11.91 219.46	7.30 186.04	18.17 11.08	9.27 354.33	5.95 322.41	5.20 216.03	5.07 124.38	8.42 292.78	6.77 310.31	1.68 233.76	Mag Phase

Table V. - Continued

(n) Fixed-system strain-gage balance pitching moment, in-lbs.

Run 9

$\mu_{Nom.} = 0.30$

POINT	MEAN	1/2P-P	1P	2P	3P	4P	5P	6P	7P	8P	9P	10P	
247	182.80	492.29	178.72 220.75	145.04 237.77	309.34 143.67	35.28 128.44	35.56 175.86	1.00 143.40	2.18 34.86	22.68 105.17	13.26 164.78	6.10 214.36	Mag Phase
248	157.06	970.64	608.00 218.22	158.77 184.33	183.95 94.06	261.38 138.09	19.67 35.40	9.60 55.62	4.92 33.50	26.39 78.36	2.99 20.64	9.27 71.70	Mag Phase
249	154.74	1392.22	1081.23 217.92	301.28 141.48	325.58 0.86	334.24 110.09	52.62 237.19	12.47 348.25	16.37 205.58	26.94 317.62	21.17 265.10	2.06 332.84	Mag Phase
250	146.34	1696.66	1241.26 225.06	305.21 142.45	504.42 19.21	358.03 105.98	81.46 229.17	24.35 262.48	15.36 240.21	42.78 309.88	32.06 301.57	12.65 315.43	Mag Phase
251	160.21	1890.44	1416.60 235.58	272.03 159.56	632.08 25.86	356.56 109.93	93.72 269.53	38.73 230.51	30.05 304.60	24.51 343.60	12.84 356.09	21.72 357.99	Mag Phase
252	163.40	901.71	596.86 214.06	119.74 178.27	116.39 122.72	265.34 132.51	6.93 64.94	4.51 7.67	6.44 316.74	24.27 74.53	4.54 3.44	3.51 73.53	Mag Phase
253	132.77	733.64	214.88 206.06	86.37 237.60	523.63 115.29	59.97 131.53	19.41 170.87	5.26 247.15	5.21 16.72	11.27 81.87	10.05 142.78	4.36 221.62	Mag Phase
254	101.50	1060.33	566.44 206.20	99.43 167.00	342.71 95.09	297.63 131.95	10.91 76.18	11.51 3.51	16.22 25.54	14.92 68.75	2.83 226.08	7.34 63.13	Mag Phase
255	88.63	1181.98	824.29 208.84	143.94 146.85	248.58 13.17	340.86 119.06	24.63 304.82	8.77 318.46	6.20 144.13	11.70 25.26	12.37 168.23	11.55 98.20	Mag Phase
256	78.62	1933.74	1196.92 228.27	321.22 176.49	830.95 19.42	336.36 105.68	85.13 278.62	28.37 204.00	14.37 308.59	14.23 344.31	11.44 290.88	9.66 27.48	Mag Phase

Table V. - Continued

(n) Continued

Run 9

 $\mu_{\text{Nom.}} = 0.30$ 

POINT	MEAN	1/2P-P	1P	2P	3P	4P	5P	6P	7P	8P	9P	10P	
257	71.22	2068.34	1335.70 235.34	298.79 173.16	972.37 19.05	319.34 106.73	93.57 293.17	37.86 227.62	46.93 332.70	12.28 82.68	5.44 34.03	18.65 27.46	Mag Phase
258	80.08	2190.63	1467.11 243.40	297.21 172.36	1117.87 13.74	348.76 104.98	121.75 306.05	69.78 236.42	96.57 354.44	40.31 144.46	8.25 212.47	29.73 37.08	Mag Phase
259	70.85	1779.82	1164.85 228.41	316.98 177.83	770.68 10.72	326.89 106.50	82.33 287.42	13.80 212.30	19.04 300.86	20.46 343.39	12.76 303.42	7.19 42.34	Mag Phase
260	91.62	987.84	521.22 203.66	72.10 170.97	324.18 93.44	286.13 129.01	13.58 100.89	12.23 359.77	14.24 20.48	15.44 48.35	4.94 175.19	6.05 49.94	Mag Phase
261	19.40	1012.53	542.06 205.23	92.20 197.36	352.20 114.11	247.67 138.42	19.64 128.40	13.85 29.12	15.01 47.81	12.32 31.61	4.25 133.38	5.17 85.77	Mag Phase
262	14.71	1174.37	740.96 207.67	101.53 171.74	227.45 43.80	339.32 129.06	30.71 311.46	16.49 350.30	21.94 39.48	9.55 101.35	3.90 225.04	8.83 105.68	Mag Phase
263	-15.92	1651.75	1023.25 215.95	227.62 166.75	626.95 23.68	380.58 122.64	48.63 296.21	11.36 25.73	2.93 356.80	5.27 3.90	12.58 203.84	14.07 147.30	Mag Phase
264	-18.42	2134.52	1321.88 236.03	352.73 196.53	1003.16 24.84	355.59 117.37	103.29 319.53	39.32 229.63	41.21 346.45	28.32 114.82	6.75 146.86	18.44 85.15	Mag Phase
265	-32.93	2332.98	1420.92 241.44	377.22 200.12	1216.63 20.92	348.63 103.72	114.66 319.02	62.98 242.47	84.34 5.55	47.93 132.60	20.68 190.42	27.24 92.59	Mag Phase
266	-57.73	2622.28	1564.87 245.97	541.83 211.30	1446.75 24.37	311.81 88.69	145.50 330.48	96.55 253.06	117.72 15.08	36.31 151.53	26.03 231.75	32.85 114.42	Mag Phase

Table V. - Continued

(n) Continued

Run 9

$\mu_{Nom.} = 0.30$

POINT	MEAN	1/2P-P	1P	2P	3P	4P	5P	6P	7P	8P	9P	10P	
267	-15.16	1568.95	1038.54 220.54	250.09 183.97	587.26 17.82	351.30 129.40	68.99 298.31	19.12 62.74	1.35 185.04	11.81 13.00	4.72 265.20	10.27 147.38	Mag Phase
268	7.52	1168.20	539.98 204.70	89.71 200.40	536.24 113.00	255.54 133.98	21.26 108.92	17.79 21.18	16.23 32.70	8.98 27.80	4.75 85.92	5.70 60.39	Mag Phase

$\mu_{Nom.} = 0.35$

POINT	MEAN	1/2P-P	1P	2P	3P	4P	5P	6P	7P	8P	9P	10P	
269	99.50	1288.83	702.89 226.34	296.15 221.73	607.08 46.84	105.24 354.71	41.52 200.15	11.64 357.83	29.70 31.16	33.99 153.74	15.76 179.44	10.63 178.20	Mag Phase
270	71.94	2006.24	1172.10 219.13	346.98 178.84	943.82 1.95	212.68 77.69	61.47 267.36	13.50 99.90	38.38 344.23	38.20 106.37	11.57 147.72	16.03 93.80	Mag Phase
271	43.62	2273.03	1348.50 222.94	389.91 185.14	1065.71 1.94	294.89 82.64	93.92 278.17	9.21 224.78	50.07 340.99	46.57 114.76	13.94 171.35	14.72 105.26	Mag Phase
272	62.35	2013.83	1154.15 218.93	363.20 183.64	969.66 2.07	190.78 78.12	61.64 265.68	11.90 93.59	29.88 352.20	37.69 102.76	15.43 124.09	18.67 105.05	Mag Phase
273	109.07	1370.05	735.05 222.53	259.77 214.73	654.75 42.36	114.99 3.17	28.07 179.91	22.32 10.33	31.24 23.37	39.87 147.11	21.59 169.54	8.58 162.69	Mag Phase
274	158.65	1383.07	775.30 223.15	325.66 196.02	593.15 18.67	144.15 23.52	21.50 212.85	8.05 169.86	39.47 357.42	46.64 119.70	21.46 138.03	16.55 116.41	Mag Phase
275	143.84	1786.99	1055.41 216.92	351.23 172.23	820.68 349.45	168.50 50.44	53.50 240.30	16.57 117.96	41.61 314.91	48.51 74.82	13.55 95.52	20.75 66.44	Mag Phase



Table V. - Continued

(n) Concluded

Run 9

$\mu_{Nom.} = 0.35$

POINT	MEAN	1/2P-P	1P	2P	3P	4P	5P	6P	7P	8P	9P	10P	
276	148.20	2126.02	1195.04	388.55	1088.78	222.21	67.97	16.34	37.96	43.48	11.24	23.57	Mag Phase
			218.11	166.73	349.26	73.20	247.35	133.39	324.87	88.19	115.21	90.68	
277	125.10	2110.96	1296.01	334.78	960.37	293.83	80.09	2.64	40.80	32.77	4.27	18.10	Mag Phase
			218.41	162.86	350.54	73.42	232.30	139.84	314.41	77.30	96.74	55.27	
278	157.67	1367.16	790.32	330.63	552.59	185.03	26.79	6.01	39.59	51.13	19.34	10.17	Mag Phase
			225.45	201.24	20.01	5.90	220.93	122.35	351.56	115.35	135.85	117.35	

Table V. - Continued

(o) Fixed-system strain-gage balance rolling moment, in-lbs

Run 9

 $\mu_{\text{Nom.}} = 0.30$ 

POINT	MEAN	1/2P-P	1P	2P	3P	4P	5P	6P	7P	8P	9P	10P	
247	-94.71	289.91	88.97 129.48	151.06 339.93	98.73 123.91	123.84 107.40	79.70 116.69	16.78 238.35	17.78 60.48	11.68 86.23	4.15 108.59	9.36 240.30	Mag Phase
248	-145.81	553.96	364.80 152.74	56.42 352.10	105.36 199.74	151.40 91.84	113.42 105.33	20.93 215.84	15.15 49.74	23.18 165.21	24.51 131.22	11.88 253.03	Mag Phase
249	-191.03	949.21	696.90 158.63	151.60 217.82	173.14 144.15	284.31 81.82	83.53 101.99	35.61 177.62	16.26 297.85	30.89 123.99	24.85 85.77	15.31 184.95	Mag Phase
250	-203.05	1123.16	831.06 161.87	176.23 248.73	79.68 126.55	288.42 88.71	88.03 109.13	36.71 155.95	32.20 302.81	42.24 96.06	25.94 65.34	16.98 144.17	Mag Phase
251	-210.14	1212.76	929.29 171.28	206.03 287.28	201.12 107.65	275.21 106.77	42.26 140.99	40.16 127.90	38.69 349.80	59.49 123.93	17.78 61.41	32.21 173.33	Mag Phase
252	-131.27	512.29	339.87 146.98	23.23 336.88	83.41 172.11	150.82 84.55	109.17 114.35	20.67 212.04	13.56 49.93	26.62 150.73	21.56 117.51	9.39 254.48	Mag Phase
253	-38.01	308.79	95.18 113.49	131.72 340.77	117.49 96.37	132.27 107.49	48.67 79.52	19.33 168.91	9.44 50.71	13.03 83.02	5.44 93.98	5.64 219.12	Mag Phase
254	-81.16	479.74	296.27 139.91	78.44 332.48	66.81 234.59	120.85 101.56	89.61 95.12	22.01 227.19	17.95 358.25	21.17 178.02	17.46 106.26	6.94 246.36	Mag Phase
255	-114.31	713.01	493.34 147.52	83.89 184.00	194.79 176.40	168.87 86.24	63.79 87.85	46.44 187.34	2.73 327.42	34.08 144.00	17.34 104.48	13.26 266.76	Mag Phase
256	-157.98	966.51	742.52 166.75	114.32 261.20	99.09 182.16	229.96 107.50	59.13 99.79	66.36 146.84	33.05 286.98	63.48 128.94	22.57 88.11	19.06 216.61	Mag Phase

Table V. - Continued

(o) Continued

Run 9

 $\mu_{\text{Nom.}} = 0.30$ 

POINT	MEAN	1/2P-P	1P	2P	3P	4P	5P	6P	7P	8P	9P	10P	
257	-173.16	1013.81	830.80 172.80	157.89 303.60	94.77 141.01	219.70 118.30	32.50 88.75	56.19 132.33	26.51 319.25	64.74 124.01	21.73 83.37	26.99 174.19	Mag Phase
258	-174.29	1114.79	936.30 178.51	173.69 326.57	226.46 152.03	220.28 132.80	7.48 52.90	51.64 131.94	21.81 47.44	68.44 120.03	33.64 59.31	49.33 165.84	Mag Phase
259	-153.90	946.72	730.41 167.15	93.72 261.46	124.79 182.12	223.04 114.46	42.28 110.22	68.56 160.51	39.12 286.26	69.61 143.17	28.07 101.47	22.02 230.23	Mag Phase
260	-82.41	444.55	275.85 132.87	70.53 318.60	44.78 218.90	132.31 95.26	81.63 96.73	22.59 199.92	14.09 24.07	23.41 170.08	11.52 111.54	6.93 249.08	Mag Phase
261	-60.35	426.51	264.73 131.16	112.19 325.42	14.15 174.33	131.07 110.60	54.67 104.76	28.15 211.66	12.93 256.54	30.63 170.92	10.73 99.10	8.15 252.11	Mag Phase
262	-71.89	605.00	440.73 145.33	7.14 328.44	148.79 200.98	114.99 107.91	54.75 86.27	34.33 194.65	1.09 242.94	21.93 141.28	14.09 111.20	9.72 255.87	Mag Phase
263	-113.55	790.78	600.46 152.76	98.59 207.05	167.73 198.44	201.09 102.27	45.62 83.25	54.00 170.06	23.69 240.47	47.03 154.22	21.25 123.26	18.57 268.88	Mag Phase
264	-142.74	972.20	805.34 172.81	110.20 324.85	134.02 188.95	206.15 134.39	17.44 104.28	87.79 153.67	29.88 271.62	84.42 160.82	30.98 124.75	22.21 240.99	Mag Phase
265	-152.93	1047.81	876.88 175.02	124.78 358.75	215.32 180.84	188.38 133.95	18.44 328.96	102.37 143.70	25.96 231.55	100.39 143.24	35.38 105.27	29.47 219.62	Mag Phase
266	-171.48	1211.80	1009.06 177.86	102.93 33.75	305.06 185.15	226.59 135.40	63.79 308.84	121.26 141.57	64.17 205.53	116.42 147.50	52.92 107.54	42.60 223.31	Mag Phase

Table V. - Continued

(o) Continued

Run 9

$\mu_{Nom.} = 0.30$

POINT	MEAN	1/2P-P	1P	2P	3P	4P	5P	6P	7P	8P	9P	10P	
267	-106.58	780.09	607.64	64.92	173.61	197.34	32.63	45.03	31.00	47.31	26.56	18.24	Mag
			155.93	216.85	203.73	113.47	109.70	171.78	235.08	146.79	119.52	248.19	Phase
268	-51.08	410.04	281.00	91.42	16.74	120.62	58.33	27.67	7.98	29.73	6.19	11.51	Mag
			129.14	328.56	71.05	109.96	89.64	207.29	255.49	170.54	101.52	257.73	Phase

$\mu_{Nom.} = 0.35$

POINT	MEAN	1/2P-P	1P	2P	3P	4P	5P	6P	7P	8P	9P	10P	
269	-30.61	611.60	321.85	95.05	173.75	128.22	90.13	20.77	27.75	45.54	5.48	10.28	Mag
			145.41	5.32	298.13	119.03	38.56	103.07	59.57	82.79	91.19	173.00	Phase
270	-73.15	933.19	630.75	22.80	195.04	229.56	147.64	72.80	29.89	90.36	18.00	12.06	Mag
			154.65	339.24	235.51	129.68	60.05	122.18	101.68	91.78	30.90	117.32	Phase
271	-93.15	1053.37	711.63	102.58	141.40	299.35	137.01	98.76	43.58	121.95	31.35	7.50	Mag
			159.10	353.35	208.62	140.26	74.46	136.41	153.01	104.67	37.29	58.03	Phase
272	-79.77	937.44	621.79	18.04	239.14	231.81	134.13	62.91	34.09	81.22	19.39	10.48	Mag
			153.27	19.74	226.64	133.96	56.83	135.47	118.07	97.46	62.16	139.65	Phase
273	-37.13	617.93	337.62	68.99	179.68	129.77	86.46	14.58	19.64	49.22	6.78	11.81	Mag
			145.27	26.13	287.99	119.72	32.95	85.40	69.16	79.16	108.95	189.60	Phase
274	-49.84	673.98	384.16	70.05	172.21	115.27	141.69	36.38	41.61	63.71	6.13	7.32	Mag
			151.62	23.23	253.34	124.05	56.40	95.63	56.51	62.24	29.92	154.71	Phase
275	-63.67	881.46	568.90	18.95	226.67	213.86	133.99	60.24	52.26	88.26	18.21	16.98	Mag
			152.31	277.15	216.72	123.34	47.74	106.40	65.42	57.80	29.61	109.80	Phase

Table V. - Continued

(o) Concluded

Run 9

$\mu_{Nom.} = 0.35$

POINT	MEAN	1/2P-P	1P	2P	3P	4P	5P	6P	7P	8P	9P	10P	
276	-65.26	983.29	670.72	20.74	223.08	277.56	146.15	75.15	34.93	83.96	23.65	17.28	Mag
			155.96	278.83	221.78	133.50	61.78	133.63	104.96	81.68	19.19	115.13	Phase
277	-80.15	1052.12	726.59	51.73	142.70	309.71	154.13	73.68	39.49	86.31	29.64	13.26	Mag
			153.80	330.63	195.90	125.08	53.91	119.20	95.52	68.68	7.80	68.05	Phase
278	-37.57	685.25	403.22	61.30	185.65	122.01	120.53	39.84	52.35	64.17	12.02	10.31	Mag
			152.47	34.39	265.85	125.16	56.26	100.20	44.98	66.94	53.67	167.00	Phase

Table V. - Continued

(p) Fixed-system strain-gage balance yawing moment, in-lbs

Run 9

$\mu_{Nom.} = 0.30$

POINT	MEAN	1/2P-P	1P	2P	3P	4P	5P	6P	7P	8P	9P	10P	
247	460.65	254.41	55.70 307.38	15.41 136.54	16.34 322.88	190.53 106.25	69.86 109.02	19.10 357.70	4.98 259.69	2.37 50.14	3.22 135.81	3.22 258.50	Mag Phase
248	684.26	258.76	58.04 307.75	24.56 78.34	23.86 346.52	141.16 66.08	115.90 135.74	24.33 1.51	11.41 23.40	10.53 82.02	4.08 140.30	3.79 255.38	Mag Phase
249	863.45	218.45	86.25 322.47	19.20 63.31	58.46 344.63	62.19 317.32	87.04 109.71	31.11 309.89	13.85 341.58	8.90 351.04	3.81 62.71	6.63 211.32	Mag Phase
250	979.52	339.25	122.18 343.11	7.49 150.23	42.08 355.97	149.14 303.89	113.04 72.01	26.45 284.89	22.72 319.64	7.29 351.37	6.66 8.49	2.68 205.41	Mag Phase
251	1095.36	504.16	165.60 341.63	18.82 168.76	44.73 319.69	271.44 317.59	115.48 97.42	9.88 158.39	20.09 349.70	12.16 46.13	8.61 40.31	11.62 152.06	Mag Phase
252	681.14	235.66	59.23 325.63	8.30 96.32	23.84 311.02	86.33 45.10	130.01 131.55	17.33 350.42	11.14 33.55	4.86 75.21	1.32 109.44	4.43 250.06	Mag Phase
253	450.75	287.16	39.52 288.91	26.68 151.92	18.35 298.01	205.47 92.85	68.60 61.01	26.28 285.22	6.11 206.46	7.40 102.39	4.95 120.22	2.65 222.65	Mag Phase
254	672.02	258.25	46.22 303.59	13.76 114.71	14.09 0.89	141.30 65.95	120.51 116.13	14.79 28.34	7.12 332.83	11.42 83.23	3.96 186.43	1.80 260.73	Mag Phase
255	820.83	257.51	34.22 325.62	23.04 42.37	61.26 337.89	131.52 3.19	116.00 114.97	27.13 322.66	18.09 302.43	6.51 58.83	2.81 156.26	6.25 245.07	Mag Phase
256	1042.15	414.93	102.22 336.32	15.20 316.54	50.54 348.91	276.59 323.09	115.94 95.29	43.82 300.89	23.24 2.24	10.18 28.82	3.70 47.75	9.79 221.10	Mag Phase

Table V. - Continued

(p) Continued

Run 9

 $\mu_{\text{Nom.}} = 0.30$ 

POINT	MEAN	1/2P-P	1P	2P	3P	4P	5P	6P	7P	8P	9P	10P	
257	1166.79	511.67	136.27 347.06	14.92 233.55	40.95 324.45	335.84 319.06	116.66 100.52	28.03 283.12	29.62 17.02	7.51 45.83	10.34 47.50	10.16 173.20	Mag Phase
258	1301.59	561.63	161.82 0.04	27.51 256.97	76.36 314.66	385.56 323.51	85.20 110.51	31.66 199.02	33.93 19.34	15.52 38.73	20.58 64.85	22.76 152.63	Mag Phase
259	1042.63	377.31	82.41 339.47	18.59 323.21	49.50 338.23	255.23 321.58	116.82 101.52	42.09 309.36	24.28 12.02	10.46 5.14	4.47 46.77	10.41 244.82	Mag Phase
260	670.52	282.41	45.86 318.24	6.75 181.78	11.05 338.62	195.61 57.47	92.24 108.16	18.06 356.30	1.79 308.17	11.97 66.21	6.21 195.31	2.68 261.05	Mag Phase
261	647.07	261.01	50.60 322.92	27.40 154.79	11.41 357.81	199.24 65.39	69.03 113.70	12.73 11.20	4.04 315.24	5.67 53.08	5.45 157.73	3.40 266.60	Mag Phase
262	795.40	253.47	38.33 309.93	30.04 81.84	40.44 345.70	121.40 6.64	126.03 107.70	25.82 338.17	10.06 309.29	9.37 91.62	3.25 164.86	4.54 249.84	Mag Phase
263	987.15	262.66	55.96 332.07	18.92 17.33	61.36 355.35	158.80 344.51	84.41 113.29	46.39 297.68	18.64 355.46	6.83 42.12	3.28 178.06	9.04 256.74	Mag Phase
264	1222.59	488.72	99.79 344.16	12.57 328.96	47.53 337.58	353.13 335.69	85.23 99.98	58.67 299.16	43.30 34.53	10.24 73.05	7.13 83.93	11.22 236.40	Mag Phase
265	1360.26	616.01	128.68 354.89	43.27 313.77	72.95 320.74	437.68 333.61	45.26 48.01	48.75 282.40	42.79 44.70	12.28 22.07	15.31 99.35	15.84 209.97	Mag Phase
266	1506.12	796.82	148.39 10.05	80.35 336.66	94.56 322.19	432.42 342.79	131.53 345.20	84.10 282.78	43.53 40.07	19.14 349.08	22.39 120.84	22.88 214.24	Mag Phase

Table V. - Continued

(p) Continued

Run 9

$\mu_{Nom.} = 0.30$

POINT	MEAN	1/2P-P	1P	2P	3P	4P	5P	6P	7P	8P	9P	10P	
267	989.01	305.14	63.42	14.68	66.01	206.69	93.14	33.68	22.20	5.75	3.11	8.96	Mag
			331.99	5.44	1.46	341.56	121.44	318.36	1.22	3.12	150.78	245.75	Phase
268	650.71	260.18	35.92	33.01	9.96	197.46	71.77	24.39	6.79	6.34	6.63	4.06	Mag
			310.14	138.80	331.13	49.40	104.66	353.68	220.07	46.57	145.30	279.48	Phase

$\mu_{Nom.} = 0.35$

POINT	MEAN	1/2P-P	1P	2P	3P	4P	5P	6P	7P	8P	9P	10P	
269	651.77	445.39	104.69	17.42	10.02	310.19	107.34	37.22	7.10	12.10	7.35	1.93	Mag
			320.00	140.14	84.94	55.71	62.37	227.49	339.62	111.38	115.62	354.62	Phase
270	997.00	439.72	85.18	23.82	35.39	268.51	149.93	51.40	35.40	7.34	10.73	7.00	Mag
			317.32	184.98	12.46	17.38	91.00	276.56	333.57	58.61	124.98	169.96	Phase
271	1226.14	617.02	128.13	36.17	31.58	480.59	105.32	49.39	48.52	16.81	9.69	6.09	Mag
			331.74	242.17	334.74	0.91	86.65	293.52	348.13	40.83	138.24	188.88	Phase
272	996.46	455.96	69.36	20.68	55.97	298.00	135.61	34.88	39.77	14.02	12.66	6.34	Mag
			333.24	143.02	8.51	22.15	84.19	284.90	337.93	68.94	117.03	184.19	Phase
273	651.99	426.65	73.80	25.33	9.17	326.75	92.40	27.43	1.62	14.25	9.64	3.74	Mag
			331.35	113.51	67.26	51.17	64.22	214.27	241.98	131.24	128.01	232.55	Phase
274	709.09	416.82	87.50	16.10	14.94	281.78	132.20	29.51	11.26	13.32	10.78	4.61	Mag
			318.36	128.23	20.35	46.79	88.17	228.98	336.78	122.08	124.07	226.05	Phase
275	869.28	371.26	72.04	9.22	49.36	192.60	146.15	46.20	29.28	11.29	10.69	7.85	Mag
			319.07	133.21	344.85	26.29	85.38	267.62	312.95	54.18	83.41	141.89	Phase



Table V. - Continued

(p) Concluded

Run 9

$\mu_{Nom.} = 0.35$

POINT	MEAN	1/2P-P	1P	2P	3P	4P	5P	6P	7P	8P	9P	10P	
276	969.82	323.61	85.95 327.84	25.63 234.19	45.82 356.19	171.00 3.50	145.63 72.96	50.74 285.09	38.63 325.71	14.01 70.88	7.19 105.61	5.74 164.21	Mag Phase
277	1076.33	420.25	98.31 338.61	20.94 233.83	46.83 326.84	245.38 12.12	143.89 55.14	35.67 271.47	47.45 312.09	15.37 3.86	4.98 62.18	4.30 130.07	Mag Phase
278	709.34	416.12	79.84 326.36	11.34 171.55	15.92 30.66	299.29 61.20	104.34 76.06	30.68 225.45	7.00 8.80	12.93 106.19	9.89 110.32	3.55 239.64	Mag Phase

Table V. - Continued

(q) Fixed-system strain-gage balance side force, lbs

Run 9

$\mu_{Nom.} = 0.30$

POINT	MEAN	1/2P-P	1P	2P	3P	4P	5P	6P	7P	8P	9P	10P	
247	-2.98	25.86	1.58 180.39	4.91 315.47	2.60 109.28	15.68 102.13	9.35 109.13	1.39 221.78	1.78 35.63	0.25 74.19	0.88 189.36	0.29 105.40	Mag Phase
248	-5.78	29.26	11.81 171.53	2.34 13.26	2.81 208.22	13.60 67.76	13.06 109.52	3.19 172.06	0.74 337.87	1.47 134.22	0.48 122.11	0.32 86.44	Mag Phase
249	-7.55	40.15	21.33 165.41	6.85 195.62	4.61 123.63	12.27 54.30	11.40 93.08	5.01 125.12	0.58 247.23	2.83 97.27	0.37 22.14	0.55 49.77	Mag Phase
250	-7.96	41.25	24.58 161.46	7.74 227.82	2.85 98.01	8.05 40.92	13.45 85.05	6.83 114.08	0.82 354.54	5.43 98.88	0.76 10.52	0.52 77.90	Mag Phase
251	-8.83	36.92	25.68 174.81	7.82 264.80	7.12 101.22	6.52 5.42	9.39 92.44	7.31 121.36	0.72 32.40	5.82 117.43	1.38 43.43	0.88 124.52	Mag Phase
252	-5.57	26.06	9.63 157.62	0.98 278.52	2.19 182.93	11.17 56.41	13.37 116.23	2.76 162.58	0.72 289.07	2.02 123.57	0.26 124.09	0.14 356.02	Mag Phase
253	-1.81	25.79	2.69 151.82	3.40 309.79	3.14 79.59	16.52 96.16	7.04 62.37	2.15 124.00	1.29 7.79	1.28 28.58	0.61 122.46	0.48 53.73	Mag Phase
254	-3.79	25.59	9.73 157.27	3.10 305.16	2.46 251.40	11.10 72.98	11.57 95.18	2.03 179.36	1.11 330.02	1.50 162.76	0.89 186.89	0.32 74.53	Mag Phase
255	-5.29	28.79	16.36 155.40	4.01 175.21	5.05 182.50	10.73 35.40	9.12 87.47	5.03 145.88	0.73 126.79	3.44 98.15	0.64 190.07	0.40 99.66	Mag Phase
256	-6.84	37.97	22.04 172.14	6.14 244.95	3.28 175.70	7.31 356.39	10.84 80.91	9.01 120.79	2.01 211.44	6.37 107.22	0.52 110.54	0.36 59.29	Mag Phase

Table V. - Continued

(q) Continued

Run 9

 $\mu_{\text{Nom.}} = 0.30$ 

POINT	MEAN	1/2P-P	1P	2P	3P	4P	5P	6P	7P	8P	9P	10P	
257	-7.20	35.04	23.46 175.86	7.10 276.26	3.84 143.24	7.88 318.70	8.33 70.65	7.31 117.92	1.24 196.07	6.44 107.88	0.66 84.94	0.15 163.84	Mag Phase
258	-7.32	39.29	26.49 177.32	7.41 303.25	8.79 154.43	7.67 313.62	5.63 54.69	4.59 113.88	2.78 118.58	5.91 86.92	1.02 74.20	1.75 222.44	Mag Phase
259	-6.76	36.76	23.03 171.29	5.64 247.18	4.33 180.19	5.72 353.55	9.17 82.50	9.22 138.49	2.32 229.74	6.32 122.20	0.84 164.14	0.52 82.47	Mag Phase
260	-3.89	28.05	8.20 144.73	4.08 278.98	1.73 245.62	14.41 64.99	10.29 94.51	3.67 163.29	1.00 340.85	1.54 106.32	0.99 172.27	0.13 5.83	Mag Phase
261	-2.85	26.16	8.14 137.08	4.43 282.05	0.60 271.20	14.21 76.48	7.20 90.80	3.48 187.78	0.78 184.66	1.85 136.85	1.03 154.13	0.19 52.29	Mag Phase
262	-3.77	26.51	15.09 155.59	0.61 190.95	4.68 214.90	7.03 33.52	8.91 86.58	5.05 156.71	0.48 91.99	2.16 91.48	1.50 175.39	0.07 314.92	Mag Phase
263	-4.84	33.21	19.19 158.82	4.63 201.56	4.69 201.66	8.39 31.11	6.69 68.63	7.22 135.72	2.57 197.84	3.85 110.96	1.54 176.80	0.16 56.00	Mag Phase
264	-6.03	40.89	24.93 178.43	4.54 293.68	5.48 183.82	8.45 331.67	5.62 60.01	9.68 132.30	4.87 194.58	7.31 135.49	1.53 178.57	0.77 305.50	Mag Phase
265	-6.47	48.47	25.74 176.00	5.82 322.31	8.82 182.04	11.57 324.89	6.96 354.05	9.19 118.51	6.70 184.56	8.51 119.56	1.13 122.53	1.03 275.11	Mag Phase
266	-6.87	58.33	29.49 176.39	5.32 346.59	12.11 184.37	7.97 355.29	14.73 333.99	9.86 105.31	9.89 181.75	10.30 129.92	1.95 122.75	2.02 304.50	Mag Phase

Table V. - Continued

(q) Continued

Run 9

 $\mu_{\text{Nom.}} = 0.30$ 

POINT	MEAN	1/2P-P	1P	2P	3P	4P	5P	6P	7P	8P	9P	10P	
267	-4.93	32.35	19.08 161.35	3.90 211.92	4.69 203.47	7.64 23.79	4.87 88.69	6.51 141.86	3.34 195.95	4.49 108.53	1.33 180.13	0.57 356.44	Mag Phase
268	-2.68	26.73	9.47 136.98	2.84 267.87	0.80 345.29	13.15 64.29	7.77 80.90	3.84 181.12	0.87 9.45	1.41 139.57	1.12 150.03	0.30 51.88	Mag Phase

 $\mu_{\text{Nom.}} = 0.35$ 

POINT	MEAN	1/2P-P	1P	2P	3P	4P	5P	6P	7P	8P	9P	10P	
269	-1.00	32.32	7.57 158.35	1.63 300.59	5.95 289.55	17.17 75.83	12.22 20.65	1.26 44.33	2.15 20.55	2.89 55.72	1.41 78.63	0.59 79.46	Mag Phase
270	-2.47	41.82	21.49 165.62	2.81 200.05	5.17 227.73	10.77 75.48	15.10 43.91	7.12 97.75	4.19 134.70	6.43 76.53	1.55 109.58	0.21 159.91	Mag Phase
271	-3.34	39.11	21.40 167.90	2.97 292.88	4.06 179.64	10.39 47.47	13.21 44.10	9.99 109.73	8.03 148.34	8.76 82.26	2.18 103.03	1.11 175.76	Mag Phase
272	-2.74	42.39	21.20 159.74	2.01 172.57	6.52 219.88	11.55 75.05	14.32 38.47	6.03 112.03	4.43 140.65	7.66 82.69	1.85 127.77	0.35 153.42	Mag Phase
273	-0.98	32.31	9.85 149.97	0.64 118.28	5.81 281.07	17.11 72.07	9.86 12.65	0.49 10.79	1.61 22.41	3.16 67.53	1.28 77.52	0.92 69.52	Mag Phase
274	-1.59	34.21	11.32 165.39	0.32 65.13	5.77 246.01	13.50 71.57	14.00 41.72	2.56 87.25	1.61 13.39	4.85 33.92	1.47 106.71	1.05 91.20	Mag Phase
275	-2.18	39.51	19.35 160.84	2.80 204.79	6.46 217.10	11.67 89.22	13.32 32.21	6.30 88.36	3.06 77.76	6.95 43.82	1.74 85.40	0.18 55.60	Mag Phase

Table V. - Continued

(q) Concluded

Run 9

$\mu_{Nom.} = 0.35$

POINT	MEAN	1/2P-P	1P	2P	3P	4P	5P	6P	7P	8P	9P	10P	
276	-2.44	45.04	22.96 164.02	3.57 218.23	6.18 212.52	9.66 112.52	16.74 37.46	7.47 112.46	4.33 122.28	7.47 67.42	1.47 116.40	0.39 226.87	Mag Phase
277	-3.13	51.15	24.20 156.75	2.74 236.45	3.51 178.23	13.82 93.04	17.22 26.47	7.69 96.98	6.23 108.30	7.03 37.43	1.25 85.50	0.69 181.25	Mag Phase
278	-0.82	34.88	12.29 161.13	0.50 186.71	6.02 261.61	15.84 84.26	11.56 36.71	2.94 97.98	2.29 5.70	4.26 49.28	1.38 100.27	1.03 86.29	Mag Phase

Table V. - Continued

(r) Pitch link load, blade 1, lbs

Run 9

$\mu_{Nom.} = 0.30$

POINT	MEAN	1/2P-P	1P	2P	3P	4P	5P	6P	7P	8P	9P	10P	
247	4.79	7.75	5.03 28.90	1.64 2.89	2.68 248.48	1.89 123.00	1.08 240.51	0.92 176.51	0.22 137.77	0.13 81.28	0.15 258.99	0.06 236.91	Mag Phase
248	6.78	9.97	6.21 27.76	3.36 59.90	3.50 296.57	3.08 162.22	0.78 309.86	0.74 173.13	0.22 226.80	0.40 68.94	0.12 287.74	0.08 197.16	Mag Phase
249	7.64	16.36	7.40 27.98	6.02 48.88	6.61 294.72	5.64 174.73	1.59 350.72	1.53 172.46	1.00 257.98	0.41 6.31	0.27 313.94	0.14 146.09	Mag Phase
250	7.78	21.20	8.23 28.50	7.65 39.83	8.32 292.53	7.38 179.64	2.42 356.55	2.54 190.00	1.77 273.71	0.53 329.99	0.54 331.14	0.11 153.22	Mag Phase
251	7.37	24.12	9.34 29.43	8.77 36.41	9.07 296.44	8.48 193.83	3.72 7.18	3.85 206.34	2.99 302.61	0.83 335.37	0.95 341.03	0.08 147.24	Mag Phase
252	6.80	9.93	6.25 27.05	3.27 58.66	3.40 294.34	3.07 156.14	0.85 305.34	0.72 163.17	0.14 219.45	0.39 67.22	0.11 274.88	0.07 194.26	Mag Phase
253	3.68	8.49	4.98 29.11	2.01 354.73	3.49 249.01	2.52 128.27	1.17 278.51	0.62 147.73	0.23 164.26	0.15 109.69	0.10 235.33	0.08 196.45	Mag Phase
254	5.54	9.43	5.94 26.27	2.65 44.36	3.40 285.49	3.06 139.63	1.32 314.15	0.68 158.82	0.15 226.07	0.35 54.23	0.15 277.89	0.10 200.58	Mag Phase
255	6.59	11.44	6.40 24.81	4.24 48.99	4.92 287.20	4.33 148.09	2.00 309.77	0.83 164.02	0.50 242.53	0.30 47.37	0.16 286.95	0.06 204.93	Mag Phase
256	7.49	19.18	7.71 26.78	7.04 35.55	8.40 289.04	6.57 170.62	2.41 317.08	2.01 187.15	1.76 259.94	0.44 275.92	0.46 300.35	0.07 327.19	Mag Phase

Table V. - Continued

(r) Continued

Run 9

 $\mu_{\text{Nom.}} = 0.30$ 

POINT	MEAN	1/2P-P	1P	2P	3P	4P	5P	6P	7P	8P	9P	10P	
257	7.53	23.65	8.62 28.73	8.44 27.48	9.76 288.80	8.41 180.42	2.81 330.98	3.97 194.37	3.07 273.71	0.71 263.28	0.79 302.71	0.03 202.41	Mag Phase
258	6.89	27.74	9.95 32.19	9.07 24.03	10.43 287.53	9.90 191.57	3.12 26.27	8.35 198.55	5.00 279.95	1.71 256.41	1.35 313.26	0.38 190.35	Mag Phase
259	7.54	18.96	7.78 28.83	6.92 38.62	8.39 293.33	6.41 174.17	2.84 317.69	1.78 196.59	1.75 273.43	0.45 311.03	0.56 316.12	0.09 337.47	Mag Phase
260	5.53	9.19	5.94 25.43	2.59 42.39	3.27 280.67	3.00 134.40	1.24 305.55	0.64 163.98	0.20 217.40	0.41 46.94	0.17 263.21	0.11 177.83	Mag Phase
261	4.40	8.76	5.76 27.55	2.04 50.83	2.88 277.07	2.32 129.77	1.28 293.58	0.47 139.20	0.16 150.85	0.28 43.74	0.13 261.14	0.13 170.98	Mag Phase
262	5.54	10.01	6.26 24.60	3.24 56.17	3.76 291.46	3.11 141.47	1.79 300.86	0.63 174.85	0.34 262.37	0.35 22.37	0.25 284.69	0.10 179.09	Mag Phase
263	6.82	13.43	6.97 25.67	5.25 48.37	6.18 290.65	4.68 160.92	2.69 305.13	0.86 193.01	0.87 266.06	0.19 340.69	0.27 282.24	0.09 242.45	Mag Phase
264	7.47	21.39	8.03 27.66	7.69 30.83	9.71 290.31	7.28 177.91	3.53 311.85	2.72 196.32	2.25 275.45	0.55 252.14	0.58 301.43	0.09 121.25	Mag Phase
265	7.33	24.43	8.96 27.33	8.75 18.84	10.63 284.42	8.44 179.58	4.15 304.82	4.53 194.71	3.71 273.53	0.85 242.47	1.01 290.90	0.27 112.07	Mag Phase
266	6.85	24.38	10.10 26.71	9.28 16.69	10.24 283.33	7.80 180.28	5.68 313.71	4.41 189.36	4.53 276.53	0.98 275.58	1.49 294.32	0.43 88.43	Mag Phase

Table V. - Continued

(r) Continued

Run 9

$\mu_{Nom.} = 0.30$

POINT	MEAN	1/2P-P	1P	2P	3P	4P	5P	6P	7P	8P	9P	10P	
267	6.89	13.72	6.86 27.62	5.33 50.94	6.23 294.26	4.87 167.16	2.53 307.30	1.00 200.18	0.92 271.80	0.17 342.20	0.26 295.60	0.08 251.05	Mag Phase
268	4.58	8.78	5.66 27.03	2.05 48.97	2.94 275.03	2.47 129.19	1.35 293.76	0.46 125.59	0.21 137.75	0.30 48.17	0.13 264.65	0.14 156.39	Mag Phase

$\mu_{Nom.} = 0.35$

POINT	MEAN	1/2P-P	1P	2P	3P	4P	5P	6P	7P	8P	9P	10P	
269	3.94	12.94	5.49 36.25	3.62 12.12	5.37 261.31	4.35 127.68	1.79 269.16	1.05 130.72	0.29 184.09	0.31 171.86	0.16 199.93	0.05 102.33	Mag Phase
270	6.01	17.95	6.76 30.78	6.41 29.93	7.73 277.04	6.58 143.04	2.47 290.21	1.91 136.18	0.91 243.64	0.25 218.59	0.15 231.61	0.06 85.87	Mag Phase
271	6.69	21.84	7.77 34.81	7.64 25.15	9.28 279.53	8.17 151.43	3.62 303.39	3.47 145.75	2.26 252.25	0.37 189.58	0.44 262.89	0.18 90.57	Mag Phase
272	6.07	17.95	6.75 32.72	6.32 31.33	7.75 278.52	6.60 145.74	2.69 292.56	1.83 140.01	0.94 250.22	0.22 226.44	0.20 223.38	0.05 116.59	Mag Phase
273	4.02	13.35	5.45 36.85	3.68 10.35	5.49 258.76	4.57 125.87	1.88 267.94	1.05 122.46	0.30 170.87	0.34 169.12	0.16 186.52	0.07 81.24	Mag Phase
274	5.22	16.26	5.91 36.41	5.14 16.89	6.53 264.69	5.65 135.31	1.21 270.60	1.61 127.48	0.52 230.64	0.38 186.79	0.16 164.91	0.07 23.99	Mag Phase
275	5.95	18.57	6.67 33.40	6.22 21.65	7.75 268.78	6.84 136.46	1.93 281.08	2.04 113.61	0.83 226.16	0.34 178.56	0.20 155.93	0.05 356.49	Mag Phase



Table V. - Continued

(r) Concluded

Run 9

$\mu_{Nom.} = 0.35$

POINT	MEAN	1/2P-P	1P	2P	3P	4P	5P	6P	7P	8P	9P	10P	
276	6.36	20.05	7.16 36.04	6.77 26.75	8.42 278.13	7.71 147.45	2.54 298.78	2.62 127.60	1.27 246.25	0.43 190.57	0.17 203.82	0.09 86.77	Mag Phase
277	6.60	21.89	7.69 35.75	7.18 19.79	9.03 272.26	8.48 143.05	3.05 302.25	3.80 121.66	2.05 229.85	0.50 162.36	0.31 232.71	0.15 73.40	Mag Phase
278	5.24	15.51	5.85 37.30	4.84 11.39	6.23 257.73	5.40 124.29	1.55 246.05	1.42 124.88	0.48 214.34	0.34 164.28	0.11 180.48	0.04 279.49	Mag Phase

Table V. - Continued

(s) Pitch link load, blade 2, lbs

Run 9

$\mu_{Nom.} = 0.30$

POINT	MEAN	1/2P-P	1P	2P	3P	4P	5P	6P	7P	8P	9P	10P	
247	-0.08	18.00	10.02 294.81	4.75 218.85	5.91 350.56	7.29 151.56	3.27 222.22	2.15 288.24	0.36 325.61	0.37 185.01	0.07 334.95	0.36 155.23	Mag Phase
248	1.72	20.90	12.08 295.39	4.29 238.65	5.15 17.23	7.32 160.99	5.07 247.63	3.27 309.52	1.05 0.69	0.07 353.98	0.14 209.22	0.14 153.49	Mag Phase
249	2.47	22.02	14.01 294.35	3.83 236.63	3.57 7.72	5.98 148.75	6.66 230.25	4.18 294.01	1.19 355.73	0.44 11.83	0.46 164.18	0.08 309.61	Mag Phase
250	2.28	22.93	15.05 294.94	3.83 231.46	3.37 3.51	4.85 150.53	7.69 225.19	4.69 291.60	1.33 8.32	0.62 358.91	0.57 180.14	0.27 290.15	Mag Phase
251	1.90	24.95	15.89 293.59	3.59 233.08	3.40 359.14	3.82 144.07	9.47 236.56	6.95 278.62	0.65 332.20	0.78 31.63	0.31 171.44	0.64 275.67	Mag Phase
252	1.36	20.24	11.96 294.76	4.48 239.59	5.03 15.64	7.03 156.85	4.76 241.65	3.15 303.36	0.93 357.56	0.09 303.16	0.11 204.07	0.14 128.47	Mag Phase
253	-1.36	16.19	10.01 290.87	3.59 208.69	5.17 334.68	5.72 131.83	3.10 197.45	1.54 271.10	0.21 294.98	0.24 167.55	0.11 341.31	0.17 117.07	Mag Phase
254	0.33	18.23	11.40 293.58	4.79 238.59	5.54 7.60	6.46 151.40	3.86 232.01	2.27 304.57	0.77 341.80	0.33 280.34	0.23 253.63	0.21 169.24	Mag Phase
255	0.51	21.08	12.12 295.39	5.04 225.07	5.63 12.19	7.09 152.43	5.09 239.44	3.91 308.62	1.39 349.97	0.22 199.25	0.28 167.57	0.08 140.99	Mag Phase
256	0.64	26.70	13.87 299.98	4.53 200.56	5.01 356.05	7.79 150.40	7.10 242.14	7.05 311.90	3.04 346.10	0.27 148.62	0.65 169.08	0.40 300.12	Mag Phase

Table V. - Continued

(s) Continued

Run 9

 $\mu_{\text{Nom.}} = 0.30$ 

POINT	MEAN	1/2P-P	1P	2P	3P	4P	5P	6P	7P	8P	9P	10P	
257	0.68	27.29	14.98 298.66	4.10 195.41	4.83 343.25	6.50 138.90	8.34 239.60	8.32 300.67	2.87 331.57	0.11 19.27	0.82 159.33	0.79 297.48	Mag Phase
258	0.22	33.89	16.81 298.50	3.06 161.09	5.82 320.90	7.66 127.14	10.01 256.14	13.82 296.10	4.61 300.83	0.77 93.50	0.91 101.62	1.78 302.05	Mag Phase
259	0.72	25.93	13.29 300.82	4.52 205.77	5.07 1.76	7.89 155.90	6.99 249.07	6.77 321.05	2.95 358.56	0.33 158.87	0.62 178.77	0.33 317.95	Mag Phase
260	0.12	17.12	10.63 293.31	4.73 236.96	5.31 5.13	6.06 145.80	3.84 227.52	2.27 297.28	0.67 333.50	0.37 264.27	0.18 238.93	0.21 160.09	Mag Phase
261	-1.62	16.49	9.87 296.93	5.52 240.85	5.68 4.31	6.11 146.59	3.73 234.10	2.11 297.28	0.34 305.40	0.46 268.83	0.09 269.88	0.24 191.80	Mag Phase
262	-0.40	19.67	10.98 297.18	5.72 237.86	6.22 16.91	6.80 155.07	4.66 244.20	3.00 318.77	0.96 359.02	0.43 270.47	0.25 214.55	0.14 207.34	Mag Phase
263	0.26	23.61	12.24 299.05	4.89 222.34	5.90 17.91	7.54 158.45	6.03 252.10	5.01 327.09	2.04 4.18	0.32 179.47	0.50 185.90	0.16 297.30	Mag Phase
264	0.13	29.12	13.81 304.46	5.04 190.18	6.16 356.67	7.84 157.80	7.53 264.23	9.44 333.05	4.16 359.11	0.76 157.08	0.93 188.42	0.94 331.54	Mag Phase
265	-0.12	34.23	15.28 305.25	5.32 170.01	7.34 336.16	8.78 142.38	8.33 268.43	13.13 322.36	5.92 337.45	1.03 136.20	1.01 157.10	1.40 320.57	Mag Phase
266	-0.06	41.43	17.26 307.02	7.65 159.21	10.06 330.61	11.25 138.29	8.47 283.93	17.94 326.55	8.56 333.13	1.04 148.75	1.34 148.93	1.53 328.18	Mag Phase

Table V. - Continued

(s) Continued

Run 9

 $\mu_{\text{Nom.}} = 0.30$ 

POINT	MEAN	1/2P-P	1P	2P	3P	4P	5P	6P	7P	8P	9P	10P	
267	0.56	24.59	12.74 301.76	5.56 218.20	6.06 15.67	7.64 160.73	6.52 254.53	5.68 331.93	2.37 9.56	0.37 161.15	0.59 204.83	0.18 311.10	Mag Phase
268	-0.32	17.20	11.14 297.73	5.99 232.49	5.62 355.72	6.31 138.70	3.96 223.51	1.98 298.10	0.39 301.41	0.52 269.75	0.19 268.13	0.27 210.43	Mag Phase

 $\mu_{\text{Nom.}} = 0.35$ 

POINT	MEAN	1/2P-P	1P	2P	3P	4P	5P	6P	7P	8P	9P	10P	
269	-2.11	28.86	11.84 310.08	7.03 186.34	10.10 338.69	9.65 118.02	8.42 211.29	5.89 257.12	1.47 292.36	0.35 188.83	0.41 77.65	0.25 130.47	Mag Phase
270	-1.60	35.04	13.35 309.50	5.69 173.05	7.00 340.46	10.73 130.07	11.47 235.97	10.31 288.16	4.19 323.84	0.85 84.74	0.98 130.92	0.17 233.28	Mag Phase
271	-1.31	38.97	14.83 314.47	5.57 163.30	6.15 335.92	10.39 130.58	12.62 253.65	13.76 302.97	5.94 335.00	1.43 100.65	1.16 161.35	0.61 293.92	Mag Phase
272	-1.82	34.58	13.54 310.77	5.93 174.76	7.36 339.79	10.78 132.74	11.26 238.57	10.20 292.58	4.00 330.12	0.86 98.91	1.02 139.97	0.19 258.90	Mag Phase
273	-2.90	28.20	11.01 308.63	6.61 181.21	9.79 335.94	9.60 117.34	8.37 207.66	5.80 253.28	1.43 283.79	0.42 198.24	0.48 73.61	0.29 129.29	Mag Phase
274	-1.98	31.85	12.42 311.62	6.62 174.38	8.79 339.10	10.43 123.86	10.17 220.78	8.65 268.05	2.61 301.86	0.16 31.47	0.85 99.86	0.30 142.89	Mag Phase
275	-1.32	35.19	13.82 308.55	5.99 162.53	7.27 331.26	10.72 120.23	11.66 223.22	10.88 271.15	3.78 302.15	0.67 53.25	1.05 107.84	0.09 187.65	Mag Phase

Table V. - Continued

(s) Concluded

Run 9

$\mu_{Nom.} = 0.35$

POINT	MEAN	1/2P-P	1P	2P	3P	4P	5P	6P	7P	8P	9P	10P	
276	-0.88	37.02	14.51 310.41	5.81 162.90	6.55 334.06	10.41 126.35	12.38 240.18	12.61 289.86	4.78 317.16	0.94 86.70	1.17 143.88	0.34 283.84	Mag Phase
277	-0.75	37.14	15.30 308.30	5.05 161.40	5.50 325.35	9.49 115.95	12.82 236.40	13.62 281.31	4.84 303.83	1.04 86.16	1.21 133.33	0.52 269.29	Mag Phase
278	-1.83	32.34	12.53 313.39	7.06 174.64	9.28 338.05	10.49 122.43	10.15 220.57	8.98 264.56	2.72 299.72	0.18 87.05	0.80 96.24	0.24 148.80	Mag Phase

Table V. - Continued

(t) Pitch link load, blade 3, lbs

Run 9

$\mu_{Nom.} = 0.30$

POINT	MEAN	1/2P-P	1P	2P	3P	4P	5P	6P	7P	8P	9P	10P	
247	8.35	10.66	6.61 191.97	2.58 17.63	2.86 60.78	2.18 103.23	2.43 28.08	1.09 186.45	0.30 284.16	0.35 101.34	0.20 125.70	0.21 198.56	Mag Phase
248	10.42	12.32	7.79 193.32	3.60 64.13	3.61 92.30	2.96 132.68	1.97 46.96	0.62 143.80	0.16 323.49	0.11 39.11	0.17 112.77	0.12 197.62	Mag Phase
249	11.17	16.54	8.45 195.26	5.76 50.01	6.97 103.22	5.53 178.22	0.15 324.03	2.39 206.37	1.48 88.84	0.70 281.86	0.62 79.56	0.38 220.59	Mag Phase
250	11.19	20.43	9.01 198.50	6.69 40.62	8.18 106.22	7.74 185.82	1.46 205.17	4.19 214.40	2.73 93.64	1.13 271.53	0.74 88.28	0.52 239.72	Mag Phase
251	11.13	22.39	9.63 198.86	7.64 39.00	8.77 115.84	8.75 205.99	1.90 218.32	6.71 236.97	4.20 108.35	1.75 279.89	1.11 107.93	0.82 247.56	Mag Phase
252	10.63	11.79	8.29 192.16	2.81 71.48	2.96 85.83	3.06 126.39	1.60 49.80	0.41 148.70	0.17 314.89	0.17 41.81	0.16 102.53	0.14 184.20	Mag Phase
253	7.38	10.26	6.36 193.22	2.81 20.64	3.46 74.17	2.34 128.06	1.35 15.56	0.89 166.74	0.16 353.99	0.22 114.54	0.07 19.22	0.10 165.44	Mag Phase
254	9.66	11.92	7.57 189.75	3.27 47.52	4.48 87.14	3.34 131.85	1.53 59.71	0.79 176.29	0.12 81.48	0.18 30.24	0.16 121.95	0.14 175.43	Mag Phase
255	10.93	12.76	8.18 190.72	3.66 55.06	4.76 88.34	3.67 125.85	1.45 72.20	0.41 190.55	0.27 95.74	0.27 306.20	0.18 116.24	0.13 162.50	Mag Phase
256	11.52	16.48	9.25 194.36	5.75 41.56	6.80 104.68	4.55 170.28	1.21 46.37	2.45 223.78	1.98 79.44	0.96 275.75	0.75 81.06	0.20 234.19	Mag Phase

Table V. - Continued

(t) Continued

Run 9

 $\mu_{\text{Nom.}} = 0.30$ 

POINT	MEAN	1/2P-P	1P	2P	3P	4P	5P	6P	7P	8P	9P	10P	
257	11.31	20.32	9.55 196.94	7.33 35.08	8.44 109.50	6.66 189.09	0.28 328.13	4.68 228.55	3.37 87.76	1.28 266.78	1.18 88.29	0.53 236.32	Mag Phase
258	10.99	24.26	9.90 195.18	8.21 35.41	8.49 119.26	7.64 211.44	1.72 314.61	7.90 242.51	5.49 99.34	2.58 281.87	1.70 98.39	1.03 253.54	Mag Phase
259	11.43	16.25	9.32 196.26	5.78 46.90	6.73 110.09	4.53 172.27	1.32 69.04	2.24 240.05	1.79 96.15	1.05 292.03	0.73 104.91	0.20 259.93	Mag Phase
260	9.84	12.05	7.85 188.40	2.93 50.18	4.44 85.26	3.28 130.58	1.32 55.80	0.68 183.51	0.19 86.24	0.14 11.03	0.13 118.30	0.18 161.92	Mag Phase
261	8.76	11.48	7.56 189.48	2.34 53.47	4.11 90.78	2.65 130.44	1.47 62.95	0.61 181.44	0.16 86.76	0.21 355.24	0.11 153.76	0.12 196.67	Mag Phase
262	10.31	11.98	8.02 188.65	2.99 57.17	4.23 92.15	3.03 129.40	1.88 63.06	0.78 227.21	0.30 85.98	0.18 314.43	0.09 130.37	0.15 169.77	Mag Phase
263	11.47	13.92	8.73 189.79	5.23 50.27	5.59 103.17	3.38 148.56	1.64 67.35	1.40 248.50	0.43 89.20	0.26 316.12	0.31 125.73	0.05 108.71	Mag Phase
264	11.65	18.10	9.20 190.96	7.82 40.43	8.22 111.69	4.12 182.21	1.41 67.08	3.15 261.01	2.04 104.53	0.94 297.35	0.90 109.26	0.36 289.04	Mag Phase
265	11.54	20.90	9.80 185.66	8.57 34.42	8.04 110.26	3.46 190.54	2.58 29.79	4.43 256.89	3.12 95.78	1.60 277.14	1.28 98.27	0.44 261.37	Mag Phase
266	10.92	28.80	11.20 179.68	8.11 33.94	4.99 104.90	0.74 138.62	5.39 54.71	8.29 297.76	5.46 134.04	2.99 317.12	1.36 130.15	0.47 207.13	Mag Phase

Table V. - Continued

(t) Continued

Run 9

$\mu_{Nom.} = 0.30$

POINT	MEAN	1/2P-P	1P	2P	3P	4P	5P	6P	7P	8P	9P	10P	
267	11.77	14.70	8.12 196.13	6.09 50.18	5.34 107.58	3.39 159.45	1.75 61.71	1.65 246.88	0.56 93.01	0.31 344.82	0.31 126.76	0.07 164.20	Mag Phase
268	9.47	11.48	7.69 198.48	2.67 54.25	3.39 85.10	2.67 126.85	1.75 55.94	0.72 194.68	0.19 76.66	0.39 355.85	0.14 162.74	0.15 133.35	Mag Phase

$\mu_{Nom.} = 0.35$

POINT	MEAN	1/2P-P	1P	2P	3P	4P	5P	6P	7P	8P	9P	10P	
269	8.40	14.02	7.10 209.29	5.16 27.16	5.75 88.60	3.63 138.51	1.71 26.77	1.31 153.32	0.26 113.02	0.29 145.72	0.22 358.28	0.22 166.63	Mag Phase
270	10.38	21.31	7.95 204.32	9.24 41.35	9.05 105.94	6.34 166.97	0.42 50.74	2.22 178.55	1.31 98.05	0.49 104.03	0.12 255.15	0.08 114.85	Mag Phase
271	10.77	25.12	9.02 205.00	10.62 36.70	10.43 107.79	8.03 173.84	0.76 195.91	3.95 187.16	3.16 102.97	0.35 111.95	0.24 76.94	0.04 42.18	Mag Phase
272	11.12	20.78	7.72 207.87	9.34 41.57	8.44 107.48	6.19 167.87	0.43 26.79	1.93 179.55	1.22 104.59	0.46 103.32	0.23 282.05	0.19 122.39	Mag Phase
273	8.82	14.54	7.36 205.51	4.83 22.10	6.10 87.09	3.95 135.61	1.55 12.76	1.50 152.33	0.22 106.46	0.27 164.11	0.28 4.45	0.16 159.23	Mag Phase
274	9.57	17.95	7.61 205.57	6.72 27.84	7.59 91.59	4.68 149.96	2.02 19.60	2.18 152.40	0.52 112.13	0.31 142.44	0.31 21.27	0.36 170.41	Mag Phase
275	10.48	20.65	8.09 206.48	7.59 32.45	8.94 85.52	6.26 156.63	1.14 10.56	2.34 146.00	1.00 93.32	0.37 106.60	0.22 343.70	0.24 138.36	Mag Phase



Table V. - Continued

(t) Concluded

Run 9

$\mu_{Nom.} = 0.35$

POINT	MEAN	1/2P-P	1P	2P	3P	4P	5P	6P	7P	8P	9P	10P	
276	10.72	22.89	8.53 210.04	8.35 36.68	9.52 105.40	7.57 169.29	0.24 347.08	3.10 161.87	1.89 107.40	0.39 101.84	0.21 12.12	0.15 152.57	Mag Phase
277	11.17	25.36	9.25 210.34	9.36 29.22	9.69 100.86	9.16 166.36	1.36 216.79	4.32 163.27	3.07 90.02	0.53 86.60	0.08 347.71	0.26 98.22	Mag Phase
278	9.62	18.09	8.16 207.80	6.40 21.53	7.11 83.48	4.52 134.88	2.42 22.18	2.33 147.05	0.29 93.90	0.16 142.41	0.38 33.31	0.48 161.78	Mag Phase

Table V. - Continued

(u) Pitch link load, blade 4, lbs.

Run 9

$\mu_{Nom.} = 0.30$

POINT	MEAN	1/2P-P	1P	2P	3P	4P	5P	6P	7P	8P	9P	10P	
247	-4.70	14.81	4.65 223.14	4.96 237.61	4.95 191.79	4.09 173.88	1.82 101.26	1.85 42.87	0.19 126.04	0.33 130.31	0.09 337.22	0.15 74.08	Mag Phase
248	-2.25	17.21	3.12 215.60	6.63 258.41	6.01 221.53	4.76 192.03	2.04 143.59	1.44 37.91	0.28 128.12	0.37 51.36	0.22 13.31	0.20 54.98	Mag Phase
249	-0.29	16.62	3.56 201.93	6.84 252.32	4.72 201.39	5.46 152.03	1.32 55.05	1.17 2.92	0.37 11.49	0.68 38.19	0.18 359.06	0.28 3.59	Mag Phase
250	0.45	17.80	3.59 191.91	8.43 245.64	4.38 193.72	6.11 140.47	1.92 19.48	0.91 336.35	0.87 351.13	0.73 13.74	0.27 326.72	0.29 22.60	Mag Phase
251	0.88	22.24	3.02 181.24	11.57 240.82	5.87 194.78	6.16 142.31	3.36 20.35	1.32 325.83	0.68 5.27	0.86 350.40	0.39 3.09	0.28 74.88	Mag Phase
252	-2.05	14.96	3.96 213.10	5.90 260.76	4.81 220.88	4.31 188.41	1.92 139.28	1.20 37.40	0.31 160.31	0.37 64.63	0.17 355.91	0.18 38.35	Mag Phase
253	-6.13	14.19	5.09 224.93	5.70 242.88	5.12 197.12	3.39 178.10	1.22 60.35	1.57 28.84	0.11 338.72	0.20 85.87	0.11 289.00	0.20 16.83	Mag Phase
254	-3.25	15.90	3.57 223.05	5.97 257.51	5.96 217.47	4.63 190.47	1.62 148.62	0.92 12.77	0.17 143.42	0.20 77.55	0.19 297.06	0.11 353.33	Mag Phase
255	-1.77	18.78	3.97 214.38	7.23 257.52	6.71 220.46	5.82 186.74	2.04 142.57	0.75 5.58	0.30 161.91	0.32 26.27	0.24 313.49	0.26 359.16	Mag Phase
256	-0.47	21.75	3.22 193.10	10.05 241.84	6.84 204.65	6.44 163.07	2.10 81.89	1.23 347.65	0.17 4.17	0.58 356.62	0.43 298.36	0.28 328.63	Mag Phase

Table V. - Continued

(u) Continued

Run 9

 $\mu_{\text{Nom.}} = 0.30$ 

POINT	MEAN	1/2P-P	1P	2P	3P	4P	5P	6P	7P	8P	9P	10P	
257	-0.35	25.48	3.23 189.02	12.96 237.44	8.57 195.64	5.48 145.09	3.22 13.85	1.66 349.18	0.78 77.03	0.45 21.23	0.20 332.77	0.14 325.97	Mag Phase
258	0.15	28.13	3.01 175.47	13.34 237.16	9.12 196.90	6.83 148.88	4.06 26.57	2.52 339.11	0.51 89.65	0.78 354.13	0.40 12.72	0.03 186.05	Mag Phase
259	-0.80	24.12	3.71 203.66	12.13 241.21	8.11 209.72	5.82 167.96	2.24 71.41	1.47 347.31	0.34 56.66	0.48 21.95	0.27 328.53	0.13 325.35	Mag Phase
260	-2.81	17.77	4.05 191.06	7.54 250.14	6.50 208.08	5.60 184.17	1.73 130.97	0.87 34.12	0.04 37.94	0.50 26.24	0.23 288.68	0.31 330.55	Mag Phase
261	-3.85	18.58	3.48 202.21	6.46 250.18	6.94 208.81	5.85 186.35	2.03 125.50	1.12 45.60	0.18 51.87	0.51 59.25	0.11 274.64	0.22 338.01	Mag Phase
262	-3.44	20.41	2.78 194.47	8.49 252.70	7.61 218.08	5.65 193.16	2.39 134.16	0.64 40.08	0.22 177.52	0.46 41.86	0.15 337.87	0.23 6.54	Mag Phase
263	-2.41	23.19	2.93 194.56	11.69 245.41	8.39 221.82	5.51 187.83	2.37 104.39	0.77 25.27	0.14 166.97	0.49 39.44	0.17 319.25	0.22 343.95	Mag Phase
264	-1.48	24.81	3.42 179.44	12.35 243.11	8.72 213.25	6.36 174.13	2.13 73.73	1.55 16.10	0.60 136.48	0.47 39.35	0.21 342.69	0.19 307.53	Mag Phase
265	-1.26	28.83	3.54 167.42	13.59 236.14	10.60 201.91	7.50 166.78	2.85 54.47	2.13 7.27	0.52 121.24	0.60 10.64	0.19 330.92	0.25 271.43	Mag Phase
266	-1.19	32.79	3.87 162.01	14.70 231.96	12.38 200.98	9.14 170.42	3.20 61.83	2.85 354.43	0.78 98.89	0.75 29.23	0.04 9.55	0.37 275.33	Mag Phase

Table V. - Continued

(u) Continued

Run 9

 $\mu_{\text{Nom.}} = 0.30$ 

POINT	MEAN	1/2P-P	1P	2P	3P	4P	5P	6P	7P	8P	9P	10P	
267	-1.78	23.73	2.79 200.47	11.91 247.55	8.83 218.78	5.09 186.55	2.07 90.21	0.96 33.43	0.36 159.24	0.38 67.44	0.20 320.71	0.21 353.93	Mag Phase
268	-3.50	19.36	5.15 215.85	7.25 250.95	7.06 208.76	5.87 184.77	1.82 116.64	1.07 38.58	0.13 22.20	0.50 49.74	0.13 257.08	0.21 328.19	Mag Phase

 $\mu_{\text{Nom.}} = 0.35$ 

POINT	MEAN	1/2P-P	1P	2P	3P	4P	5P	6P	7P	8P	9P	10P	
269	-5.73	24.89	6.45 217.73	7.87 221.90	9.92 186.16	7.32 165.36	3.03 74.93	1.84 1.37	0.22 159.97	0.20 71.64	0.30 303.30	0.17 305.13	Mag Phase
270	-4.68	31.61	5.40 208.20	11.79 230.15	10.63 189.15	8.68 149.36	4.61 57.50	2.15 326.59	0.41 73.18	0.44 23.99	0.31 310.01	0.19 297.62	Mag Phase
271	-4.78	36.45	5.33 196.09	13.69 231.50	12.57 192.08	9.37 149.27	5.97 53.05	2.88 326.06	0.38 96.83	0.71 21.01	0.33 325.30	0.20 300.68	Mag Phase
272	-4.70	33.05	5.22 213.09	13.21 233.09	11.29 193.92	8.17 151.36	4.88 59.00	2.26 333.65	0.43 90.28	0.38 68.89	0.14 245.58	0.06 296.21	Mag Phase
273	-5.60	24.85	6.39 211.02	8.72 222.41	9.83 186.01	7.07 159.61	2.74 67.18	1.85 345.61	0.31 165.19	0.26 120.40	0.23 287.88	0.15 338.48	Mag Phase
274	-5.31	24.32	5.64 212.23	8.28 223.00	8.50 176.08	6.59 144.18	3.83 52.80	2.08 343.52	0.61 130.04	0.59 131.04	0.12 225.18	0.02 136.28	Mag Phase
275	-4.88	28.94	5.67 203.08	10.37 224.80	10.13 180.13	7.76 141.87	4.57 44.34	2.08 323.27	0.47 82.55	0.38 66.09	0.23 273.08	0.12 280.50	Mag Phase

Table V. - Concluded

(u) Concluded

Run 9

$\mu_{Nom.} = 0.35$

POINT	MEAN	1/2P-P	1P	2P	3P	4P	5P	6P	7P	8P	9P	10P	
276	-3.68	33.01	6.19 216.75	12.78 229.91	10.72 188.22	8.34 146.95	5.35 47.84	2.71 332.09	0.68 65.27	0.38 61.48	0.23 258.61	0.11 181.74	Mag Phase
277	-4.04	34.04	6.16 206.02	13.20 226.85	10.98 183.52	8.49 137.18	5.91 36.51	2.87 313.76	0.60 53.95	0.50 25.47	0.26 274.10	0.07 257.65	Mag Phase
278	-4.75	27.93	6.49 207.18	9.56 218.61	10.76 180.89	7.62 152.42	4.06 58.42	2.53 343.30	0.47 78.87	0.32 124.75	0.35 273.43	0.15 162.54	Mag Phase

Table VI. – Rotor Performance, Control Positions, Blade Loads, Fixed System Loads, and Pitch Link Loads at  $\mu = 0.08, 0.11, 0.13, 0.16, 0.20, 0.225, 0.25, 0.275, 0.30,$  and  $0.325$  for constant nominal rotor lift and non-trim rotor first harmonic flapping

(a) Rotor performance and control positions

Run 10

$\mu_{Nom} = 0.08$											
POINT	$\alpha_S$	$B_1$	$a_{1s}$	$A_1$	$b_{1s}$	$\theta$	$\mu$	$C_L$	$L_{Nom.}$	$C_D$	$C_Q$
281	-0.3	2.6	0.0	-0.5	0.0	6.1	0.075	0.00461	200.0	0.00007	0.00028
282	-0.3	2.4	0.0	-0.5	0.0	5.3	0.079	0.00411	180.0	0.00007	0.00024
283	-0.3	2.2	0.0	-0.5	0.0	4.6	0.081	0.00366	160.0	0.00006	0.00020
$\mu_{Nom} = 0.11$											
POINT	$\alpha_S$	$B_1$	$a_{1s}$	$A_1$	$b_{1s}$	$\theta$	$\mu$	$C_L$	$L_{Nom.}$	$C_D$	$C_Q$
284	-0.3	2.2	0.0	-0.1	0.0	4.0	0.113	0.00365	160.0	0.00005	0.00018
285	-0.3	2.5	0.0	-0.1	0.0	4.6	0.112	0.00409	180.0	0.00005	0.00021
286	-0.3	2.7	0.0	-0.1	0.0	5.3	0.110	0.00458	200.0	0.00006	0.00024
$\mu_{Nom} = 0.13$											
POINT	$\alpha_S$	$B_1$	$a_{1s}$	$A_1$	$b_{1s}$	$\theta$	$\mu$	$C_L$	$L_{Nom.}$	$C_D$	$C_Q$
287	-0.3	2.8	0.0	0.2	0.0	5.0	0.134	0.00457	200.0	0.00005	0.00022
288	-0.3	2.5	0.0	0.2	0.0	4.4	0.135	0.00413	180.0	0.00005	0.00020
289	-0.3	2.3	0.0	0.2	0.0	3.7	0.137	0.00359	160.0	0.00004	0.00017
$\mu_{Nom} = 0.16$											
POINT	$\alpha_S$	$B_1$	$a_{1s}$	$A_1$	$b_{1s}$	$\theta$	$\mu$	$C_L$	$L_{Nom.}$	$C_D$	$C_Q$
290	-1.3	2.6	0.0	0.6	0.0	4.0	0.160	0.00369	160.0	-0.00002	0.00019
291	-1.3	2.8	0.0	0.6	0.0	4.5	0.160	0.00408	180.0	-0.00004	0.00021
292	-1.3	1.6	1.0	0.1	0.0	4.5	0.160	0.00437	191.7	0.00006	0.00020
293	-1.3	4.0	-1.0	1.2	0.0	4.5	0.161	0.00381	167.0	-0.00011	0.00021
294	-1.3	2.8	0.0	0.6	0.0	4.5	0.160	0.00408	180.0	-0.00004	0.00021
295	-1.3	1.5	0.0	1.5	1.0	4.5	0.161	0.00417	183.2	0.00000	0.00020
296	-1.3	4.0	0.0	-0.3	-1.0	4.5	0.160	0.00399	174.6	-0.00007	0.00021
297	-1.3	2.8	0.0	0.6	0.0	4.5	0.161	0.00408	180.0	-0.00004	0.00021
298	-1.3	3.1	0.0	0.7	0.0	5.1	0.160	0.00454	200.0	-0.00005	0.00023
$\mu_{Nom} = 0.20$											
POINT	$\alpha_S$	$B_1$	$a_{1s}$	$A_1$	$b_{1s}$	$\theta$	$\mu$	$C_L$	$L_{Nom.}$	$C_D$	$C_Q$
299	-2.3	3.7	0.0	1.3	0.0	5.5	0.199	0.00456	200.0	-0.00014	0.00026
300	-2.3	3.3	0.0	1.2	0.0	4.9	0.198	0.00409	180.0	-0.00011	0.00023
301	-2.3	2.2	1.0	0.6	0.0	4.9	0.198	0.00447	196.6	-0.00003	0.00022
302	-2.3	4.5	-1.0	1.8	0.0	4.9	0.198	0.00376	165.5	-0.00019	0.00023
303	-2.3	3.4	0.0	1.2	0.0	4.9	0.199	0.00409	180.0	-0.00012	0.00023
304	-2.3	2.1	0.0	2.1	1.0	4.9	0.199	0.00422	185.5	-0.00008	0.00023
305	-2.3	4.6	0.0	0.3	-1.0	4.9	0.199	0.00397	174.4	-0.00015	0.00023

Table VI. – Continued

(a) Continued

$\mu_{Nom} = 0.20$

POINT	$\alpha_S$	$B_1$	$a_{1s}$	$A_1$	$b_{1s}$	$\theta$	$\mu$	$C_L$	$L_{Nom.}$	$C_D$	$C_Q$
306	-2.3	3.4	0.0	1.2	0.0	4.9	0.199	0.00410	180.0	-0.00012	0.00023
307	-2.3	3.1	0.0	1.1	0.0	4.3	0.199	0.00362	160.0	-0.00009	0.00020

$\mu_{Nom} = 0.25$

POINT	$\alpha_S$	$B_1$	$a_{1s}$	$A_1$	$b_{1s}$	$\theta$	$\mu$	$C_L$	$L_{Nom.}$	$C_D$	$C_Q$
308	-3.5	3.8	0.0	2.0	0.0	5.2	0.251	0.00363	160.0	-0.00019	0.00024
309	-3.5	4.2	0.0	2.1	0.0	5.8	0.251	0.00409	180.0	-0.00023	0.00027
310	-3.5	3.1	1.0	1.5	0.0	5.8	0.251	0.00448	196.0	-0.00015	0.00027
311	-3.5	5.2	-1.0	2.7	0.0	5.8	0.251	0.00370	161.7	-0.00028	0.00028
312	-3.5	4.1	0.0	2.1	0.0	5.8	0.251	0.00406	180.0	-0.00023	0.00027
313	-3.5	2.9	0.0	3.0	1.0	5.8	0.250	0.00423	185.2	-0.00020	0.00027
314	-3.5	5.3	0.0	1.2	-1.0	5.8	0.251	0.00393	172.4	-0.00026	0.00027
315	-3.5	4.1	0.0	2.1	0.0	5.8	0.251	0.00406	180.0	-0.00023	0.00027
316	-3.5	4.5	0.0	2.2	0.0	6.4	0.251	0.00457	200.0	-0.00027	0.00031

$\mu_{Nom} = 0.30$

POINT	$\alpha_S$	$B_1$	$a_{1s}$	$A_1$	$b_{1s}$	$\theta$	$\mu$	$C_L$	$L_{Nom.}$	$C_D$	$C_Q$
317	-5.1	5.6	0.0	3.4	0.0	8.2	0.301	0.00461	200.0	-0.00042	0.00046
318	-5.1	5.2	0.0	3.2	0.0	7.5	0.300	0.00417	180.0	-0.00037	0.00039
319	-5.1	4.2	1.0	2.6	0.0	7.5	0.300	0.00457	199.4	-0.00032	0.00040
320	-5.1	6.2	-1.0	3.6	0.0	7.5	0.299	0.00376	164.9	-0.00041	0.00038
321	-5.1	5.2	0.0	3.1	0.0	7.5	0.299	0.00416	180.0	-0.00037	0.00039
322	-5.1	4.0	0.0	4.1	1.0	7.5	0.300	0.00430	187.9	-0.00034	0.00039
323	-5.1	6.4	0.0	2.2	-1.0	7.5	0.299	0.00402	175.9	-0.00039	0.00039
324	-5.1	5.3	0.0	3.1	0.0	7.5	0.299	0.00414	180.0	-0.00037	0.00039
325	-5.1	4.8	0.0	2.9	0.0	6.8	0.300	0.00367	160.0	-0.00031	0.00034

$\mu_{Nom} = 0.325$

POINT	$\alpha_S$	$B_1$	$a_{1s}$	$A_1$	$b_{1s}$	$\theta$	$\mu$	$C_L$	$L_{Nom.}$	$C_D$	$C_Q$
326	-6.1	5.4	0.0	3.5	0.0	7.8	0.325	0.00362	160.0	-0.00038	0.00041
327	-6.1	5.8	0.0	3.7	0.0	8.6	0.325	0.00413	180.0	-0.00045	0.00048
328	-6.1	6.2	0.0	4.2	0.0	9.5	0.325	0.00455	200.0	-0.00052	0.00058

$\mu_{Nom} = 0.275$

POINT	$\alpha_S$	$B_1$	$a_{1s}$	$A_1$	$b_{1s}$	$\theta$	$\mu$	$C_L$	$L_{Nom.}$	$C_D$	$C_Q$
329	-4.2	5.1	0.0	2.8	0.0	7.2	0.275	0.00458	200.0	-0.00034	0.00037
330	-4.2	4.7	0.0	2.6	0.0	6.5	0.275	0.00409	180.0	-0.00029	0.00032
331	-4.2	3.6	1.0	2.1	0.0	6.5	0.275	0.00451	197.3	-0.00023	0.00032
332	-4.2	5.7	-1.0	3.2	0.0	6.5	0.274	0.00367	160.9	-0.00034	0.00032
333	-4.2	4.6	0.0	2.6	0.0	6.5	0.274	0.00410	180.0	-0.00029	0.00032

Table VI. – Continued

(a) Concluded

$\mu_{Nom} = 0.275$

POINT	$\alpha_S$	$B_1$	$a_{1s}$	$A_1$	$b_{1s}$	$\theta$	$\mu$	$C_L$	$L_{Nom.}$	$C_D$	$C_Q$
334	-4.2	3.4	0.0	3.5	1.0	6.5	0.275	0.00425	185.8	-0.00026	0.00032
335	-4.2	6.0	0.0	1.7	-1.0	6.5	0.274	0.00392	172.0	-0.00033	0.00032
336	-4.2	4.7	0.0	2.6	0.0	6.5	0.274	0.00410	180.0	-0.00030	0.00031
337	-4.2	4.3	0.0	2.5	0.0	5.9	0.275	0.00362	160.0	-0.00025	0.00028

$\mu_{Nom} = 0.225$

POINT	$\alpha_S$	$B_1$	$a_{1s}$	$A_1$	$b_{1s}$	$\theta$	$\mu$	$C_L$	$L_{Nom.}$	$C_D$	$C_Q$
338	-2.8	4.1	0.0	1.8	0.0	5.9	0.225	0.00457	200.0	-0.00021	0.00027
339	-2.8	3.8	0.0	1.7	0.0	5.3	0.224	0.00409	180.0	-0.00018	0.00024
340	-2.8	2.7	1.0	1.1	0.0	5.3	0.225	0.00451	197.7	-0.00011	0.00024
341	-2.8	4.8	-1.0	2.3	0.0	5.3	0.225	0.00373	163.5	-0.00026	0.00024
342	-2.8	3.8	0.0	1.7	0.0	5.3	0.224	0.00409	180.0	-0.00019	0.00024
343	-2.8	2.5	0.0	2.6	1.0	5.3	0.225	0.00423	185.5	-0.00015	0.00024
344	-2.8	5.1	0.0	0.8	-1.0	5.3	0.225	0.00396	173.3	-0.00023	0.00024
345	-2.8	3.8	0.0	1.7	0.0	5.3	0.225	0.00409	180.0	-0.00020	0.00024
346	-2.8	3.5	0.0	1.6	0.0	4.7	0.224	0.00363	160.0	-0.00016	0.00021



Table VI. - Continued

(b) Blade flapwise bending moment, in-lbs, 23.00 percent radius

Run 10

$\mu_{Nom.} = 0.08$

POINT	MEAN	1/2P-P	1P	2P	3P	4P	5P	6P	7P	8P	9P	10P	
281	53.58	17.73	2.47 282.63	2.46 113.73	7.20 286.97	2.67 227.30	4.97 347.47	2.31 262.35	0.33 290.76	2.68 291.99	0.46 283.83	0.11 62.33	Mag Phase
282	52.46	17.40	2.28 283.92	2.58 121.48	6.91 286.11	2.43 225.93	5.68 345.74	2.10 265.07	0.28 159.41	2.83 304.54	0.31 265.31	0.16 57.98	Mag Phase
283	51.48	15.83	2.04 287.96	2.30 129.27	6.31 287.02	2.15 224.05	5.33 350.65	1.86 274.61	0.28 148.20	3.00 329.87	0.25 282.66	0.24 95.75	Mag Phase

$\mu_{Nom.} = 0.11$

POINT	MEAN	1/2P-P	1P	2P	3P	4P	5P	6P	7P	8P	9P	10P	
284	51.65	15.30	1.44 291.57	2.47 152.96	5.05 285.59	2.46 201.63	5.09 350.42	1.95 262.64	0.40 155.82	3.73 303.70	0.38 234.52	0.34 84.57	Mag Phase
285	52.60	17.57	1.59 287.82	2.71 147.43	5.80 283.29	2.95 201.17	5.66 347.18	2.17 258.87	0.40 142.15	4.40 292.29	0.45 226.48	0.35 71.59	Mag Phase
286	53.65	20.24	2.02 288.02	3.00 149.72	6.63 292.62	3.58 214.49	6.51 359.07	2.53 276.64	0.31 172.94	4.65 313.02	0.47 244.07	0.34 106.89	Mag Phase

$\mu_{Nom.} = 0.13$

POINT	MEAN	1/2P-P	1P	2P	3P	4P	5P	6P	7P	8P	9P	10P	
287	53.89	17.02	1.18 295.63	3.48 154.99	5.63 292.98	3.57 200.92	5.50 8.59	1.98 260.73	1.02 180.55	2.56 314.25	0.40 230.28	0.38 82.21	Mag Phase
288	52.96	15.13	0.99 298.18	3.24 164.64	4.95 303.74	2.96 213.34	4.96 26.30	1.79 282.12	1.00 207.55	2.28 352.50	0.38 268.95	0.31 121.68	Mag Phase

Table VI. - Continued

(b) Continued

Run 10

$\mu_{Nom.} = 0.13$

POINT	MEAN	1/2P-P	1P	2P	3P	4P	5P	6P	7P	8P	9P	10P	
289	51.80	12.44	0.70 302.25	2.79 162.31	4.17 297.14	2.31 202.35	4.06 14.61	1.43 269.55	0.75 188.85	2.02 337.38	0.36 252.87	0.24 109.09	Mag Phase

$\mu_{Nom.} = 0.16$

POINT	MEAN	1/2P-P	1P	2P	3P	4P	5P	6P	7P	8P	9P	10P	
290	52.42	12.05	0.43 347.70	3.12 162.88	4.27 306.58	2.02 203.29	4.02 24.07	1.18 291.07	0.09 174.99	2.63 322.40	0.30 265.10	0.24 88.91	Mag Phase
291	53.29	13.79	0.56 338.39	3.45 157.63	4.90 301.58	2.45 199.54	4.57 15.27	1.26 279.52	0.14 106.77	2.90 310.46	0.26 253.56	0.27 77.92	Mag Phase
292	53.66	13.70	2.07 282.73	3.53 158.77	4.98 303.46	2.44 204.64	5.23 13.58	1.30 278.15	0.17 210.87	1.20 323.81	0.14 308.53	0.24 47.98	Mag Phase
293	53.13	12.73	1.51 74.27	3.40 153.12	4.54 304.39	2.53 198.91	4.01 1.83	1.18 284.99	0.37 79.53	2.97 312.17	0.22 239.01	0.32 81.77	Mag Phase
294	53.25	13.55	0.52 332.38	3.45 159.39	4.85 303.30	2.50 203.66	4.53 18.93	1.26 286.29	0.04 66.02	2.92 312.03	0.30 257.30	0.26 86.58	Mag Phase
295	53.16	12.95	1.76 228.98	3.09 157.61	4.65 302.55	2.45 199.96	4.34 13.05	1.25 281.27	0.09 256.36	2.19 300.64	0.18 305.26	0.28 59.03	Mag Phase
296	53.07	13.75	2.17 14.37	3.71 158.85	4.89 299.80	2.56 195.94	4.69 5.40	1.31 276.43	0.31 94.43	2.92 303.13	0.30 242.13	0.26 72.95	Mag Phase
297	53.25	13.45	0.51 334.64	3.50 159.13	4.90 303.26	2.49 201.05	4.39 17.58	1.24 282.84	0.10 122.98	2.73 313.32	0.22 258.33	0.31 80.90	Mag Phase

Table VI. - Continued

Run 10													
(b) Continued													
$\mu_{Nom.} = 0.16$													
POINT	MEAN	1/2P-P	1P	2P	3P	4P	5P	6P	7P	8P	9P	10P	
298	54.28	15.38	0.68 323.87	3.81 158.79	5.51 305.60	3.01 206.61	5.08 21.72	1.33 290.35	0.22 61.50	3.18 318.04	0.24 267.51	0.35 95.68	Mag Phase
$\mu_{Nom.} = 0.20$													
POINT	MEAN	1/2P-P	1P	2P	3P	4P	5P	6P	7P	8P	9P	10P	
299	55.16	14.43	1.15 18.11	3.69 154.71	5.62 308.26	2.53 198.51	4.51 8.63	1.13 296.39	0.33 104.27	3.25 358.34	0.16 293.93	0.43 135.11	Mag Phase
300	54.10	12.61	1.05 22.50	3.33 157.38	5.11 306.91	2.20 192.15	3.69 6.73	1.08 295.23	0.29 94.00	2.88 350.72	0.20 282.79	0.35 127.33	Mag Phase
301	54.54	13.72	1.50 308.88	3.89 166.88	5.63 318.83	2.22 213.16	3.94 26.70	1.03 320.81	0.45 120.31	3.01 22.33	0.20 309.24	0.44 183.51	Mag Phase
302	53.92	11.06	2.39 65.18	3.15 155.57	4.39 312.09	1.85 200.11	2.67 10.33	0.82 298.56	0.42 146.71	2.36 348.66	0.10 290.70	0.22 112.06	Mag Phase
303	54.12	12.33	1.05 30.29	3.36 165.51	5.12 320.10	2.14 211.60	3.61 27.79	1.04 322.25	0.23 140.00	2.72 20.40	0.15 301.29	0.39 174.47	Mag Phase
304	53.97	13.54	0.92 221.45	3.31 162.47	5.12 316.10	2.24 210.75	3.83 25.37	1.09 320.68	0.38 143.35	3.12 19.68	0.25 334.31	0.42 174.97	Mag Phase
305	53.90	13.28	2.99 32.78	3.65 168.10	5.07 321.31	2.06 214.67	3.47 26.02	1.01 319.45	0.30 136.70	2.56 19.63	0.13 309.74	0.32 165.64	Mag Phase
306	54.13	12.44	1.09 26.30	3.37 159.53	5.13 310.87	2.18 195.65	3.53 13.01	1.04 300.12	0.30 122.36	2.82 357.85	0.19 295.31	0.37 140.29	Mag Phase

Table VI. - Continued

Run 10													
(b) Continued													
$\mu_{Nom.} = 0.20$													
POINT	MEAN	1/2P-P	1P	2P	3P	4P	5P	6P	7P	8P	9P	10P	
307	53.05	10.56	1.11 32.75	2.84 160.76	4.46 309.01	1.66 187.94	2.90 9.25	0.92 294.18	0.20 156.13	2.42 355.86	0.16 300.49	0.32 125.72	Mag Phase
$\mu_{Nom.} = 0.25$													
POINT	MEAN	1/2P-P	1P	2P	3P	4P	5P	6P	7P	8P	9P	10P	
308	54.41	8.17	2.32 32.76	1.64 168.06	4.49 317.72	0.90 230.95	0.79 333.50	1.13 314.10	0.71 271.05	1.59 353.41	0.44 280.28	0.11 182.94	Mag Phase
309	55.53	9.46	2.39 30.50	1.88 161.79	4.99 322.84	1.42 234.77	1.05 352.76	1.16 327.47	0.65 284.77	2.06 13.24	0.52 301.89	0.11 196.66	Mag Phase
310	55.76	12.36	2.29 343.42	2.88 164.49	5.71 322.23	2.02 240.18	2.21 34.82	1.53 345.37	0.88 322.75	2.15 2.49	0.44 311.20	0.21 142.71	Mag Phase
311	55.12	8.56	3.79 53.05	1.69 153.81	4.43 315.39	0.93 217.11	0.84 307.12	0.81 313.70	0.66 277.06	1.35 7.47	0.41 287.34	0.11 217.61	Mag Phase
312	55.43	9.95	2.40 28.80	2.01 157.11	5.08 317.07	1.58 219.49	1.41 345.42	1.20 313.23	0.60 263.47	1.99 351.74	0.41 287.75	0.08 165.51	Mag Phase
313	55.28	9.51	0.56 10.75	2.15 150.66	4.97 321.35	1.62 230.27	1.57 7.14	1.33 334.37	0.64 297.26	2.27 358.06	0.65 299.96	0.15 152.36	Mag Phase
314	55.08	10.37	4.48 29.23	2.19 160.87	4.99 321.41	1.49 235.83	1.26 334.07	1.06 309.83	0.52 267.36	1.59 9.07	0.41 298.60	0.10 199.16	Mag Phase
315	55.36	9.58	2.38 30.79	1.90 161.33	5.02 321.61	1.52 230.54	1.33 1.88	1.14 323.73	0.60 280.41	1.97 6.64	0.51 298.57	0.09 187.05	Mag Phase

Table VI. - Continued

Run 10													
(b) Continued													
$\mu_{Nom.} = 0.25$													
POINT	MEAN	1/2P-P	1P	2P	3P	4P	5P	6P	7P	8P	9P	10P	
316	56.63	10.85	2.67 24.85	2.10 143.42	5.33 319.50	2.10 222.67	2.23 8.28	1.40 327.20	0.69 291.85	2.41 8.09	0.52 305.78	0.08 182.40	Mag Phase
$\mu_{Nom.} = 0.30$													
POINT	MEAN	1/2P-P	1P	2P	3P	4P	5P	6P	7P	8P	9P	10P	
317	58.95	10.74	4.26 18.68	2.61 25.72	4.12 270.13	3.07 154.13	2.69 254.65	1.59 14.97	2.21 249.16	1.17 54.85	0.61 325.20	0.54 228.81	Mag Phase
318	57.64	9.03	3.95 20.09	1.16 51.65	3.60 287.65	1.77 154.95	1.74 255.25	1.07 14.88	1.86 260.80	1.35 69.80	0.54 313.33	0.45 241.08	Mag Phase
319	58.07	9.65	4.00 353.64	1.50 55.80	4.05 283.87	2.45 180.98	0.80 281.30	1.48 17.09	2.35 259.82	2.27 48.82	0.78 319.04	0.62 235.55	Mag Phase
320	57.27	10.03	4.96 39.36	1.25 66.80	3.59 279.08	1.89 121.58	2.43 239.04	0.65 8.49	1.70 254.08	0.97 53.16	0.37 300.13	0.27 220.06	Mag Phase
321	57.67	8.57	4.09 22.39	1.18 56.15	3.54 289.16	1.70 154.85	1.59 254.69	1.03 15.12	1.68 259.85	1.18 81.65	0.47 320.78	0.41 238.72	Mag Phase
322	57.73	9.19	2.21 10.45	1.67 49.72	3.53 278.34	2.07 162.10	1.45 247.61	1.28 4.75	2.02 253.07	1.89 51.31	0.55 296.89	0.49 220.21	Mag Phase
323	57.41	9.99	6.07 25.71	1.02 70.83	3.64 290.17	1.41 143.25	1.79 246.40	0.82 6.96	1.38 261.89	0.92 102.74	0.35 293.28	0.37 231.09	Mag Phase
324	57.63	8.84	4.05 23.30	0.98 53.04	3.55 291.44	1.82 160.89	1.75 269.08	0.99 17.72	1.68 266.39	1.29 82.62	0.45 321.46	0.40 246.71	Mag Phase

Table VI. - Continued

(b) Continued													
$\mu_{Nom.} = 0.30$													
POINT	MEAN	1/2P-P	1P	2P	3P	4P	5P	6P	7P	8P	9P	10P	
325	56.13	7.98	3.78 24.98	0.14 121.46	3.10 304.26	0.85 136.91	1.37 245.18	0.84 14.16	1.18 268.47	1.37 74.78	0.53 318.56	0.34 243.16	Mag Phase
$\mu_{Nom.} = 0.325$													
326	57.37	10.30	4.39 22.35	1.63 13.62	3.49 272.20	2.42 127.05	3.67 247.19	1.14 37.98	1.63 276.05	1.41 110.07	0.64 19.22	0.36 263.88	Mag Phase
327	58.99	12.72	4.82 20.08	2.91 12.12	4.08 263.10	3.68 131.49	4.96 246.55	1.74 27.59	2.06 262.70	1.44 148.27	0.73 11.09	0.38 253.47	Mag Phase
328	59.98	17.60	5.17 23.10	4.40 1.33	5.01 267.55	5.84 141.74	7.66 240.07	3.19 21.92	3.02 262.85	0.82 157.81	1.22 1.13	0.63 249.22	Mag Phase
$\mu_{Nom.} = 0.275$													
POINT	MEAN	1/2P-P	1P	2P	3P	4P	5P	6P	7P	8P	9P	10P	
329	57.96	8.49	3.48 20.20	1.05 101.31	4.19 297.32	2.22 192.85	0.81 311.87	0.98 313.30	1.54 238.16	1.51 21.38	0.62 287.83	0.21 236.66	Mag Phase
330	56.38	8.65	3.31 24.98	1.16 149.44	4.07 312.08	1.43 203.10	0.42 263.82	0.86 318.17	1.17 248.20	1.89 32.79	0.50 289.00	0.18 247.02	Mag Phase
331	56.99	9.94	2.97 334.21	1.04 149.48	4.32 306.60	2.44 228.52	0.27 17.50	1.07 320.29	1.74 257.11	2.26 41.36	0.76 278.37	0.36 220.52	Mag Phase
332	55.87	9.34	4.60 54.78	0.88 162.95	3.70 313.41	0.48 171.50	1.25 231.66	0.64 337.94	0.90 280.16	0.99 39.88	0.55 308.88	0.26 250.33	Mag Phase

Table VI. - Continued

Run 10													
(b) Continued													
$\mu_{Nom.} = 0.275$													
POINT	MEAN	1/2P-P	1P	2P	3P	4P	5P	6P	7P	8P	9P	10P	
333	56.44	8.51	3.14 29.03	1.15 148.27	4.06 313.29	1.51 211.14	0.33 289.97	0.88 322.47	1.10 243.51	1.86 24.99	0.56 292.81	0.16 252.08	Mag Phase
334	56.49	7.23	0.76 348.08	1.32 143.79	3.96 306.89	1.66 206.76	0.41 227.33	0.86 317.19	1.50 248.49	1.73 17.52	0.88 271.88	0.20 236.52	Mag Phase
335	56.05	10.52	6.12 30.51	1.24 169.78	3.89 322.12	1.17 238.83	1.03 277.47	0.77 324.67	0.83 274.84	0.98 61.91	0.44 315.32	0.24 258.28	Mag Phase
336	56.44	8.69	3.25 27.30	0.96 155.93	3.92 318.00	1.46 209.93	0.46 287.99	0.84 330.66	1.09 258.97	2.00 42.23	0.46 312.39	0.14 277.55	Mag Phase
337	55.13	7.67	3.08 31.18	0.93 189.52	3.49 318.19	0.40 204.05	0.82 194.60	0.75 328.26	1.00 261.47	1.69 41.80	0.51 299.99	0.18 246.05	Mag Phase
$\mu_{Nom.} = 0.225$													
POINT	MEAN	1/2P-P	1P	2P	3P	4P	5P	6P	7P	8P	9P	10P	
338	56.15	11.27	1.70 22.80	2.56 156.58	5.03 323.71	2.12 211.94	2.41 38.73	1.14 313.45	1.02 273.99	2.32 2.13	0.48 307.20	0.15 40.99	Mag Phase
339	54.87	9.62	1.80 36.76	2.29 160.95	4.66 325.66	1.42 219.74	2.02 59.55	1.07 324.67	0.93 284.56	2.14 3.13	0.54 309.07	0.08 84.61	Mag Phase
340	55.19	12.22	2.53 308.02	2.77 165.21	5.55 318.57	2.20 218.16	3.44 42.98	0.95 307.45	0.56 239.25	1.45 58.54	0.53 353.48	0.21 357.94	Mag Phase
341	54.45	9.38	3.63 66.88	2.13 159.90	4.49 321.38	1.26 202.46	1.06 6.09	0.80 299.45	0.32 271.94	2.20 334.25	0.57 288.63	0.06 307.03	Mag Phase

Table VI. - Continued

Run 10													
(b) Concluded													
$\mu_{Nom.} = 0.225$													
POINT	MEAN	1/2P-P	1P	2P	3P	4P	5P	6P	7P	8P	9P	10P	
342	54.90	10.35	1.81 39.38	2.51 160.00	4.78 321.88	1.44 212.82	2.24 41.32	1.05 309.62	0.89 269.05	2.40 347.29	0.49 300.47	0.09 47.04	Mag Phase
343	54.58	10.28	1.16 213.30	2.64 156.82	4.74 320.12	1.64 201.42	2.38 39.10	1.06 306.78	0.75 271.46	1.52 355.46	0.64 318.16	0.22 21.66	Mag Phase
344	54.38	11.57	4.92 28.31	2.47 161.42	4.48 322.36	1.55 218.68	1.92 26.47	0.95 305.94	0.46 256.91	2.08 333.51	0.38 281.49	0.10 348.90	Mag Phase
345	54.95	9.88	1.78 32.66	2.35 161.06	4.84 321.50	1.53 211.38	2.22 43.11	1.09 308.98	0.94 269.41	1.90 353.74	0.53 304.14	0.07 37.80	Mag Phase
346	53.69	8.38	1.85 38.80	1.86 167.01	4.20 321.62	0.90 199.94	1.66 47.47	0.98 309.30	0.69 276.65	1.96 358.38	0.58 306.04	0.04 42.07	Mag Phase



Table VI. - Continued

(c) Blade chordwise bending moment, in-lbs, 30.00 percent radius

Run 10

$\mu_{Nom.} = 0.08$

POINT	MEAN	1/2P-P	1P	2P	3P	4P	5P	6P	7P	8P	9P	10P	
281	-26.09	15.24	6.83 334.03	3.50 57.87	6.67 148.08	1.27 247.31	1.31 303.36	2.88 17.59	0.19 167.35	0.55 104.88	0.27 105.81	0.03 112.79	Mag Phase
282	-27.61	13.17	4.64 326.06	3.19 64.23	5.11 145.91	1.49 261.14	0.82 303.48	3.34 9.93	0.31 117.91	0.78 138.33	0.27 127.46	0.11 149.26	Mag Phase
283	-28.55	10.83	3.17 318.45	2.88 74.25	3.83 153.94	1.47 290.67	1.46 11.33	3.64 357.57	0.20 173.39	0.52 90.53	0.20 137.04	0.08 186.27	Mag Phase

$\mu_{Nom.} = 0.11$

POINT	MEAN	1/2P-P	1P	2P	3P	4P	5P	6P	7P	8P	9P	10P	
284	-29.25	9.24	3.39 308.56	3.32 85.64	2.80 161.15	1.48 298.64	2.64 23.36	1.45 358.65	0.20 77.79	0.60 120.24	0.21 116.75	0.09 183.42	Mag Phase
285	-28.57	11.38	5.03 317.79	4.03 79.69	3.77 146.90	1.46 292.30	1.99 18.15	1.88 356.69	0.26 31.93	0.85 112.99	0.25 102.65	0.10 173.35	Mag Phase
286	-27.66	15.04	7.46 331.12	4.71 80.10	5.53 153.11	1.66 272.08	1.66 337.65	2.17 12.60	0.42 67.64	0.69 119.93	0.33 103.89	0.07 220.94	Mag Phase

$\mu_{Nom.} = 0.13$

POINT	MEAN	1/2P-P	1P	2P	3P	4P	5P	6P	7P	8P	9P	10P	
287	-28.16	15.83	8.32 323.20	5.33 80.98	4.92 147.43	1.70 292.94	2.45 335.88	1.69 68.12	0.59 69.75	0.81 126.37	0.31 116.97	0.12 193.86	Mag Phase
288	-29.41	12.22	5.92 317.49	4.85 90.02	3.57 164.70	1.94 322.22	2.68 25.22	1.32 79.54	0.31 108.88	0.59 122.48	0.27 156.93	0.12 252.25	Mag Phase

Table VI. - Continued

(c) Continued

Run 10

$\mu_{Nom.} = 0.13$

POINT	MEAN	1/2P-P	1P	2P	3P	4P	5P	6P	7P	8P	9P	10P	
289	-30.22	10.34	4.31 305.57	3.58 89.13	2.59 170.70	1.79 323.37	3.28 6.74	1.07 86.31	0.36 88.66	0.69 161.53	0.23 142.11	0.10 208.22	Mag Phase

$\mu_{Nom.} = 0.16$

POINT	MEAN	1/2P-P	1P	2P	3P	4P	5P	6P	7P	8P	9P	10P	
290	-30.18	12.51	5.75 312.33	3.58 79.61	2.88 170.65	1.92 328.72	3.88 19.00	2.14 108.29	0.54 87.53	0.27 187.54	0.17 151.32	0.10 188.61	Mag Phase
291	-29.58	14.69	7.67 317.22	4.39 76.93	3.66 156.19	2.01 315.67	3.61 8.00	2.57 102.91	0.59 79.02	0.51 127.77	0.17 138.23	0.07 188.86	Mag Phase
292	-29.59	16.56	8.29 332.80	4.05 88.21	4.59 159.70	2.29 298.49	2.87 11.37	2.40 136.40	0.57 85.37	0.35 190.39	0.26 121.43	0.09 205.28	Mag Phase
293	-29.90	15.27	7.48 303.92	4.06 50.85	2.63 188.33	1.55 287.26	6.11 43.02	2.72 74.45	0.82 71.25	0.51 110.43	0.10 90.62	0.03 156.28	Mag Phase
294	-29.66	15.02	7.91 319.24	4.30 77.48	3.71 156.48	1.94 320.44	3.79 9.34	2.58 105.39	0.51 84.31	0.68 145.33	0.20 140.74	0.08 192.28	Mag Phase
295	-29.75	19.80	10.35 329.90	4.35 72.93	5.05 156.56	2.19 302.49	4.52 335.34	1.63 100.34	0.58 102.41	0.67 146.95	0.17 125.07	0.09 185.90	Mag Phase
296	-29.79	13.72	5.17 303.77	3.51 76.93	3.17 173.99	1.37 315.83	5.87 7.02	2.20 84.83	0.74 57.94	0.24 90.29	0.14 103.19	0.06 146.02	Mag Phase
297	-29.78	14.89	7.66 318.70	4.18 77.10	3.83 156.29	1.87 319.39	4.26 6.02	2.33 100.11	0.63 94.63	0.23 147.45	0.17 151.25	0.11 196.23	Mag Phase

Table VI. - Continued

(c) Continued

Run 10

$\mu_{Nom.} = 0.16$

POINT	MEAN	1/2P-P	1P	2P	3P	4P	5P	6P	7P	8P	9P	10P	
298	-28.86	20.21	10.25 328.53	4.89 76.70	5.40 158.06	1.78 297.42	4.14 352.20	2.91 123.09	1.04 100.15	0.52 163.39	0.14 143.05	0.09 225.63	Mag Phase

$\mu_{Nom.} = 0.20$

POINT	MEAN	1/2P-P	1P	2P	3P	4P	5P	6P	7P	8P	9P	10P	
299	-28.55	23.58	13.63 330.20	4.93 60.60	5.82 159.60	2.27 260.72	4.74 348.98	2.83 117.62	0.50 91.21	0.32 166.10	0.19 91.30	0.04 82.27	Mag Phase
300	-29.77	18.39	10.43 321.07	4.26 65.88	4.21 152.25	1.83 300.38	4.66 351.40	2.34 112.24	0.57 75.44	0.22 193.69	0.16 108.82	0.02 113.50	Mag Phase
301	-29.66	23.45	12.70 343.06	4.33 84.62	6.17 181.21	3.64 292.98	4.84 15.34	2.26 175.04	0.14 285.85	0.35 205.91	0.33 146.04	0.05 76.65	Mag Phase
302	-29.92	15.70	9.33 306.30	4.09 45.92	2.22 179.61	1.95 280.21	5.44 39.30	2.08 73.13	0.76 81.01	0.41 198.25	0.10 109.08	0.06 157.20	Mag Phase
303	-30.06	18.00	10.57 324.61	4.18 77.05	4.19 163.93	2.07 316.77	4.30 17.49	2.60 138.22	0.49 93.35	0.60 187.60	0.13 143.32	0.04 100.74	Mag Phase
304	-29.94	24.70	13.78 337.08	4.69 67.89	6.14 168.89	2.11 290.55	5.43 358.16	1.84 152.49	0.10 174.45	0.37 230.93	0.16 143.01	0.04 249.47	Mag Phase
305	-29.77	16.56	7.29 312.15	3.78 82.08	3.22 186.65	1.33 327.30	7.08 43.49	2.34 124.70	0.58 79.69	0.19 161.74	0.14 146.77	0.00 309.63	Mag Phase
306	-29.91	18.43	10.42 322.49	4.33 69.10	4.24 154.07	1.88 304.73	5.08 1.38	2.31 126.80	0.50 85.55	0.34 176.37	0.15 126.25	0.03 87.26	Mag Phase

Table VI. - Continued

(c) Continued

Run 10

$\mu_{Nom.} = 0.20$

POINT	MEAN	1/2P-P	1P	2P	3P	4P	5P	6P	7P	8P	9P	10P	
307	-30.67	14.67	7.69 311.33	3.38 71.17	2.66 164.56	2.16 316.34	4.89 14.40	2.34 108.82	0.26 47.11	0.49 156.33	0.18 117.49	0.04 136.28	Mag Phase

$\mu_{Nom.} = 0.25$

POINT	MEAN	1/2P-P	1P	2P	3P	4P	5P	6P	7P	8P	9P	10P	
308	-29.74	16.52	10.56 317.97	2.98 62.30	2.92 155.60	1.43 306.64	6.10 3.29	0.96 51.10	0.50 25.90	0.19 99.89	0.21 96.62	0.06 135.71	Mag Phase
309	-28.82	24.08	14.11 328.89	3.97 60.05	4.49 158.45	1.72 264.85	7.88 10.10	0.78 26.90	0.20 81.36	0.14 79.12	0.22 105.61	0.04 256.07	Mag Phase
310	-28.90	31.21	18.15 344.36	6.21 85.92	7.35 177.40	5.72 281.85	5.66 0.31	3.20 97.76	0.56 266.86	0.67 127.70	0.24 115.01	0.09 47.60	Mag Phase
311	-28.92	17.34	12.58 309.94	4.48 39.54	2.12 152.01	2.48 275.06	4.45 7.99	2.78 22.64	0.41 54.22	0.46 178.74	0.15 95.35	0.02 99.11	Mag Phase
312	-28.87	25.50	14.35 328.47	4.11 50.69	5.03 154.40	1.33 234.02	8.05 354.23	0.71 67.11	0.11 135.15	0.30 184.30	0.22 91.55	0.13 200.97	Mag Phase
313	-28.86	31.19	18.17 337.09	4.82 65.13	7.00 160.11	3.29 254.13	7.19 348.45	1.57 25.07	0.50 279.26	0.66 151.20	0.34 114.45	0.09 244.04	Mag Phase
314	-28.53	18.16	10.23 313.02	3.93 64.67	3.18 170.88	1.27 304.05	6.98 22.44	1.55 75.13	0.74 42.43	0.51 183.98	0.21 94.79	0.03 147.38	Mag Phase
315	-28.79	24.78	14.23 328.06	3.56 53.21	4.79 160.19	1.36 252.18	7.79 356.30	1.06 86.97	0.12 135.19	0.47 151.33	0.27 106.64	0.06 173.14	Mag Phase

Table VI. - Continued

(c) Continued

Run 10

$\mu_{Nom.} = 0.25$

POINT	MEAN	1/2P-P	1P	2P	3P	4P	5P	6P	7P	8P	9P	10P	
316	-27.40	32.68	18.57 334.27	4.78 51.74	7.36 162.91	3.08 235.87	8.73 356.35	2.23 76.31	0.38 302.35	0.36 138.73	0.39 121.31	0.08 235.39	Mag Phase

$\mu_{Nom.} = 0.30$

POINT	MEAN	1/2P-P	1P	2P	3P	4P	5P	6P	7P	8P	9P	10P	
317	-20.87	50.55	23.75 337.42	10.90 336.15	4.63 141.20	7.10 132.38	5.99 318.52	15.74 10.04	3.33 45.05	0.43 240.18	0.68 93.83	0.29 160.06	Mag Phase
318	-24.31	39.97	20.31 332.33	7.71 348.47	5.24 140.79	4.96 144.67	6.90 342.75	10.60 24.30	1.17 57.82	0.86 221.89	0.48 99.32	0.13 136.29	Mag Phase
319	-23.28	47.05	24.48 347.43	7.56 6.61	6.94 169.62	4.17 155.09	4.17 347.59	11.58 27.50	1.99 62.00	0.70 293.01	0.63 131.43	0.02 84.83	Mag Phase
320	-25.06	30.14	17.99 312.12	7.18 345.09	3.55 114.77	2.16 151.39	7.29 335.38	8.17 0.63	1.61 66.81	0.68 164.00	0.38 54.09	0.22 97.41	Mag Phase
321	-24.41	38.99	19.99 330.91	7.79 349.04	4.99 143.62	5.08 145.92	6.38 344.60	10.45 21.53	1.22 69.24	0.23 255.30	0.46 90.83	0.14 103.20	Mag Phase
322	-24.10	45.97	24.39 340.05	8.18 353.12	6.07 145.22	4.20 137.55	5.82 335.78	11.69 12.33	1.83 38.49	0.89 257.60	0.54 114.96	0.11 183.52	Mag Phase
323	-24.57	30.05	15.85 315.78	7.12 345.13	3.49 144.25	3.59 135.13	8.61 350.76	6.61 356.41	1.40 97.33	0.29 41.90	0.36 78.12	0.10 107.95	Mag Phase
324	-24.31	39.33	19.96 331.64	7.92 349.97	4.99 147.81	5.31 148.08	6.18 353.93	10.80 28.07	1.22 68.51	0.18 230.15	0.47 91.32	0.11 126.97	Mag Phase

Table VI. - Continued

(c) Continued

Run 10

 $\mu_{\text{Nom.}} = 0.30$ 

POINT	MEAN	1/2P-P	1P	2P	3P	4P	5P	6P	7P	8P	9P	10P	
325	-26.86	28.11	15.14	5.19	3.84	3.11	7.13	5.32	0.37	0.73	0.21	0.15	Mag
			325.74	0.14	145.58	134.31	346.83	358.66	75.30	240.06	94.44	147.43	Phase

 $\mu_{\text{Nom.}} = 0.325$ 

POINT	MEAN	1/2P-P	1P	2P	3P	4P	5P	6P	7P	8P	9P	10P	
326	-23.59	38.62	17.75	9.57	4.40	5.58	8.60	11.52	2.33	0.40	0.42	0.28	Mag
			324.52	325.92	138.49	122.32	337.76	2.45	58.35	190.28	28.56	110.40	Phase
327	-20.29	48.57	21.66	12.10	4.76	7.14	9.55	16.99	4.28	0.44	0.71	0.55	Mag
			330.68	323.29	137.66	123.02	317.42	10.30	56.39	211.70	44.74	123.65	Phase
328	-14.77	74.43	23.06	13.35	6.33	7.05	20.46	38.14	8.02	1.38	1.58	1.25	Mag
			344.23	313.56	150.38	127.38	318.22	12.94	60.14	300.14	68.15	185.46	Phase

 $\mu_{\text{Nom.}} = 0.275$ 

POINT	MEAN	1/2P-P	1P	2P	3P	4P	5P	6P	7P	8P	9P	10P	
329	-25.35	41.50	21.20	6.40	6.38	4.19	9.46	7.18	0.63	0.57	0.53	0.06	Mag
			335.87	11.60	155.44	172.55	337.07	7.44	26.89	187.83	102.60	223.43	Phase
330	-27.55	30.63	16.75	4.60	5.62	1.80	9.24	2.53	0.17	0.19	0.33	0.04	Mag
			328.57	37.65	153.95	186.74	339.81	2.12	210.86	51.94	96.39	152.48	Phase
331	-27.09	38.56	21.76	4.97	7.65	4.08	7.17	4.50	0.61	0.40	0.39	0.23	Mag
			346.12	55.56	178.33	251.65	353.18	26.50	231.97	120.15	121.68	8.64	Phase
332	-28.10	21.03	14.51	6.07	2.54	1.85	6.14	3.16	0.43	0.52	0.24	0.10	Mag
			311.67	26.72	147.47	253.48	345.71	6.12	136.00	212.32	89.92	57.07	Phase

Table VI. - Continued

(c) Continued

Run 10

$\mu_{\text{Nom.}} = 0.275$

POINT	MEAN	1/2P-P	1P	2P	3P	4P	5P	6P	7P	8P	9P	10P	
333	-27.75	30.03	16.93 329.75	4.61 40.21	5.64 154.60	1.96 181.09	8.53 344.16	2.08 1.12	0.10 237.95	0.17 243.65	0.33 98.19	0.04 164.12	Mag Phase
334	-27.52	38.75	21.43 339.26	5.09 46.41	7.36 157.42	3.59 224.94	8.58 327.55	4.38 4.22	0.38 205.24	0.69 126.79	0.31 92.93	0.09 351.88	Mag Phase
335	-27.68	19.74	11.78 317.40	5.31 34.91	3.05 179.78	1.23 185.16	7.63 19.90	0.42 226.07	0.47 144.21	0.37 188.65	0.33 102.78	0.04 35.76	Mag Phase
336	-27.77	30.34	16.63 331.89	4.92 40.79	5.66 160.97	2.13 186.33	9.27 352.53	1.57 30.66	0.28 200.47	0.42 318.03	0.30 118.84	0.07 248.52	Mag Phase
337	-29.30	22.37	12.53 324.99	4.08 35.14	3.62 158.58	0.67 190.74	7.69 340.98	0.86 9.75	0.07 243.04	0.43 172.81	0.25 89.83	0.10 73.77	Mag Phase

$\mu_{\text{Nom.}} = 0.225$

POINT	MEAN	1/2P-P	1P	2P	3P	4P	5P	6P	7P	8P	9P	10P	
338	-29.24	27.64	16.14 334.40	5.14 59.23	6.09 167.24	1.87 246.35	6.66 359.64	2.08 111.65	0.58 131.37	0.38 143.97	0.28 157.67	0.16 275.59	Mag Phase
339	-30.49	19.61	12.09 324.88	4.53 66.73	3.80 161.75	1.32 300.64	5.52 2.88	1.55 166.13	0.71 107.97	0.42 143.97	0.24 159.60	0.07 307.87	Mag Phase
340	-30.09	28.15	15.63 342.00	6.47 90.32	6.58 174.50	5.48 285.48	3.50 352.73	2.76 149.83	0.39 140.06	0.15 338.49	0.31 158.16	0.06 306.67	Mag Phase
341	-30.38	16.90	10.25 304.14	4.37 49.31	2.25 193.99	2.37 285.71	6.26 29.88	3.09 60.31	0.64 71.79	0.11 139.99	0.17 105.66	0.03 207.64	Mag Phase

Table VI. - Continued

(c) Concluded

Run 10

 $\mu_{\text{Nom.}} = 0.225$ 

POINT	MEAN	1/2P-P	1P	2P	3P	4P	5P	6P	7P	8P	9P	10P	
342	-30.26	20.28	11.82 321.05	4.77 66.68	3.78 162.29	1.10 307.19	5.64 4.29	2.88 125.74	0.71 106.72	0.57 117.69	0.27 139.08	0.06 282.32	Mag Phase
343	-30.23	28.25	16.37 334.13	5.09 73.58	6.30 160.33	2.37 275.14	6.54 333.71	0.45 161.18	0.26 162.29	0.42 95.79	0.26 143.94	0.15 275.99	Mag Phase
344	-30.09	17.08	7.56 304.45	3.56 71.06	2.87 191.84	1.77 329.53	8.36 30.00	2.30 97.69	0.74 67.64	0.07 55.55	0.10 141.32	0.05 231.99	Mag Phase
345	-30.36	19.31	11.64 322.55	4.59 67.23	3.74 158.92	1.25 302.12	5.18 354.72	1.80 138.78	0.79 103.95	0.12 158.52	0.25 132.14	0.08 281.37	Mag Phase
346	-31.24	15.17	8.15 311.77	3.68 71.55	2.28 173.92	1.73 331.82	5.15 18.30	2.03 109.54	0.49 79.52	0.43 183.26	0.19 137.59	0.04 257.12	Mag Phase



Table VI. - Continued

(d) Blade torsional moment, in-lbs, 35.00 percent radius

Run 10

$\mu_{Nom.} = 0.08$

POINT	MEAN	1/2P-P	1P	2P	3P	4P	5P	6P	7P	8P	9P	10P	
281	6.05	6.21	2.05 24.09	3.14 90.38	0.61 168.94	1.21 169.87	1.63 211.51	0.80 169.83	0.27 301.20	0.13 315.50	0.13 347.12	0.03 90.04	Mag Phase
282	5.40	5.83	1.77 23.46	2.92 98.82	0.55 153.45	1.16 182.10	1.73 217.94	0.86 159.97	0.29 315.53	0.11 296.27	0.07 333.58	0.09 114.27	Mag Phase
283	4.77	4.94	1.61 22.84	2.46 104.90	0.52 155.84	0.95 187.47	1.57 226.68	0.86 160.40	0.28 338.34	0.18 258.35	0.05 328.12	0.09 110.98	Mag Phase

$\mu_{Nom.} = 0.11$

POINT	MEAN	1/2P-P	1P	2P	3P	4P	5P	6P	7P	8P	9P	10P	
284	4.98	4.39	1.80 16.84	2.26 122.83	0.53 89.46	1.09 174.53	1.30 225.46	0.58 145.12	0.22 331.76	0.07 110.79	0.04 50.00	0.12 106.50	Mag Phase
285	5.67	5.14	1.92 17.26	2.67 115.71	0.58 82.33	1.29 174.64	1.45 220.38	0.61 141.65	0.26 305.78	0.07 102.06	0.05 18.32	0.12 98.15	Mag Phase
286	6.44	6.20	2.08 21.61	3.23 116.34	0.63 83.95	1.56 187.66	1.76 232.16	0.54 158.59	0.31 335.62	0.07 107.76	0.07 14.40	0.10 126.90	Mag Phase

$\mu_{Nom.} = 0.13$

POINT	MEAN	1/2P-P	1P	2P	3P	4P	5P	6P	7P	8P	9P	10P	
287	6.57	5.40	2.19 16.83	3.13 123.28	1.00 64.26	1.48 172.77	1.28 213.52	0.46 132.60	0.31 305.15	0.09 327.10	0.14 10.86	0.13 99.30	Mag Phase
288	5.93	4.51	2.06 18.92	2.70 135.11	0.87 79.55	1.24 182.62	1.00 228.71	0.59 155.66	0.24 342.73	0.06 317.71	0.11 56.36	0.13 131.54	Mag Phase

Table VI. - Continued

(d) Continued

Run 10

$\mu_{Nom.} = 0.13$

POINT	MEAN	1/2P-P	1P	2P	3P	4P	5P	6P	7P	8P	9P	10P	
289	5.14	3.86	1.93 15.91	2.19 135.82	0.73 79.97	1.03 167.09	0.74 220.37	0.57 135.86	0.17 317.36	0.03 328.22	0.11 50.40	0.13 109.94	Mag Phase

$\mu_{Nom.} = 0.16$

POINT	MEAN	1/2P-P	1P	2P	3P	4P	5P	6P	7P	8P	9P	10P	
290	5.47	4.13	2.16 16.58	2.47 139.51	0.79 66.33	1.06 173.05	0.58 209.75	0.51 140.76	0.22 299.00	0.17 134.77	0.14 70.51	0.11 94.60	Mag Phase
291	6.07	4.45	2.27 15.76	2.86 130.96	0.96 47.92	1.15 173.25	0.82 209.84	0.37 137.63	0.29 289.23	0.12 119.41	0.13 45.28	0.10 75.57	Mag Phase
292	6.43	4.63	2.18 10.58	3.04 134.62	1.26 56.92	1.01 158.63	0.85 200.99	0.41 116.26	0.13 329.09	0.01 253.12	0.12 3.24	0.09 62.68	Mag Phase
293	5.78	4.23	2.40 21.35	2.55 125.70	0.72 29.51	1.34 176.45	0.59 214.03	0.31 141.86	0.29 314.97	0.10 130.19	0.09 88.75	0.08 113.19	Mag Phase
294	6.08	4.43	2.27 15.93	2.84 132.32	0.94 52.14	1.12 175.32	0.82 213.21	0.38 142.95	0.26 289.78	0.14 127.73	0.11 52.24	0.10 82.58	Mag Phase
295	6.23	4.52	2.06 16.06	2.81 126.98	0.98 58.67	1.17 167.52	0.91 203.50	0.39 142.05	0.29 308.07	0.09 111.90	0.09 46.75	0.09 57.22	Mag Phase
296	5.97	4.62	2.47 14.18	2.75 134.49	0.76 49.77	1.26 167.87	0.71 216.72	0.44 121.96	0.23 281.65	0.11 104.67	0.16 62.13	0.09 88.94	Mag Phase
297	6.11	4.44	2.26 16.24	2.88 132.52	0.94 54.86	1.13 172.55	0.77 215.09	0.37 142.44	0.30 296.89	0.14 130.36	0.12 51.24	0.09 82.80	Mag Phase

Table VI. - Continued

(d) Continued

Run 10

$\mu_{Nom.} = 0.16$

POINT	MEAN	1/2P-P	1P	2P	3P	4P	5P	6P	7P	8P	9P	10P	
298	6.85	4.88	2.42 17.11	3.26 129.34	1.10 47.71	1.22 181.53	1.10 228.95	0.16 136.47	0.42 301.81	0.12 113.94	0.14 50.41	0.10 93.49	Mag Phase

$\mu_{Nom.} = 0.20$

POINT	MEAN	1/2P-P	1P	2P	3P	4P	5P	6P	7P	8P	9P	10P	
299	7.15	5.56	3.10 12.39	3.09 118.24	1.63 1.90	1.14 191.33	1.09 235.29	0.04 84.76	0.34 317.10	0.19 199.08	0.11 46.15	0.05 64.27	Mag Phase
300	6.47	4.90	2.86 12.42	2.61 122.30	1.23 1.15	1.01 173.51	0.81 222.84	0.29 150.24	0.29 290.90	0.20 187.46	0.12 39.40	0.06 63.91	Mag Phase
301	6.94	5.28	2.77 11.14	3.13 136.68	1.53 31.56	0.90 186.82	0.84 220.74	0.33 132.24	0.25 345.97	0.18 246.74	0.12 47.78	0.11 92.36	Mag Phase
302	6.11	4.54	3.00 20.12	2.25 119.53	1.08 357.83	0.96 165.69	0.26 258.83	0.38 144.70	0.28 324.96	0.06 200.45	0.08 68.04	0.05 97.56	Mag Phase
303	6.49	4.88	2.88 16.90	2.64 131.27	1.26 14.79	1.03 192.82	0.79 245.44	0.28 172.02	0.28 325.44	0.14 213.61	0.11 76.74	0.07 103.35	Mag Phase
304	6.63	4.83	2.67 15.84	2.79 125.30	1.27 14.17	1.14 194.97	0.90 237.69	0.35 168.83	0.39 339.10	0.20 224.05	0.13 94.83	0.08 90.80	Mag Phase
305	6.41	5.00	3.14 17.58	2.44 137.79	1.07 13.61	0.97 183.85	0.50 264.91	0.42 165.59	0.23 324.11	0.12 215.26	0.14 109.07	0.08 130.38	Mag Phase
306	6.55	5.00	2.91 13.34	2.66 124.87	1.30 5.63	0.98 177.21	0.78 233.18	0.30 148.38	0.27 302.11	0.19 197.95	0.10 58.07	0.06 78.77	Mag Phase

Table VI. - Continued

(d) Continued

Run 10

$\mu_{Nom.} = 0.20$

POINT	MEAN	1/2P-P	1P	2P	3P	4P	5P	6P	7P	8P	9P	10P	
307	5.80	4.31	2.70 13.97	2.17 127.99	0.86 3.15	0.92 156.74	0.40 213.09	0.47 128.55	0.12 294.33	0.18 184.51	0.11 49.46	0.07 67.62	Mag Phase

$\mu_{Nom.} = 0.25$

POINT	MEAN	1/2P-P	1P	2P	3P	4P	5P	6P	7P	8P	9P	10P	
308	6.33	5.82	3.71 15.13	2.00 96.65	1.75 315.31	1.46 149.06	0.46 333.96	0.67 141.90	0.08 108.31	0.07 203.57	0.04 39.17	0.05 88.87	Mag Phase
309	6.98	6.75	4.00 15.92	2.70 94.87	2.48 329.01	1.57 178.12	0.64 335.23	0.52 173.42	0.07 15.73	0.14 250.46	0.03 328.38	0.01 22.28	Mag Phase
310	7.58	7.02	3.99 11.26	3.26 106.93	2.87 342.29	1.50 219.29	0.67 312.06	0.37 198.32	0.16 9.56	0.06 277.55	0.02 20.16	0.01 89.49	Mag Phase
311	6.47	5.93	4.05 18.08	2.28 81.01	2.29 314.27	1.47 158.92	0.39 341.14	0.49 151.89	0.05 66.22	0.06 336.71	0.06 50.03	0.03 134.30	Mag Phase
312	6.98	7.04	4.00 13.17	2.74 91.81	2.57 321.17	1.71 169.99	0.71 321.66	0.52 155.51	0.07 8.70	0.11 215.67	0.02 280.29	0.01 135.95	Mag Phase
313	7.14	6.96	3.77 14.64	3.06 90.84	2.71 326.40	1.84 190.22	0.73 320.28	0.58 174.81	0.13 322.17	0.07 280.05	0.09 73.87	0.02 92.64	Mag Phase
314	6.84	6.58	4.22 14.86	2.27 96.19	2.24 324.22	1.43 160.30	0.74 351.07	0.49 144.17	0.10 61.36	0.04 251.69	0.03 170.90	0.04 142.55	Mag Phase
315	6.97	6.91	4.01 14.98	2.71 94.25	2.50 326.20	1.66 175.45	0.69 332.02	0.54 164.64	0.08 20.53	0.11 232.93	0.02 357.31	0.01 121.08	Mag Phase

Table VI. - Continued

(d) Continued

Run 10

$\mu_{Nom.} = 0.25$

POINT	MEAN	1/2P-P	1P	2P	3P	4P	5P	6P	7P	8P	9P	10P	
316	7.90	8.33	4.31 15.32	3.67 86.75	3.60 324.48	2.25 193.11	1.01 322.54	0.57 179.62	0.03 296.90	0.23 240.14	0.05 252.61	0.03 213.98	Mag Phase

$\mu_{Nom.} = 0.30$

POINT	MEAN	1/2P-P	1P	2P	3P	4P	5P	6P	7P	8P	9P	10P	
317	8.71	18.62	5.71 15.94	7.10 37.08	8.68 288.60	5.87 168.16	2.94 319.78	2.06 173.16	1.26 254.61	0.52 237.69	0.31 294.39	0.10 157.63	Mag Phase
318	8.01	14.19	5.19 14.07	5.53 51.17	6.54 294.74	4.41 165.93	2.21 324.55	1.24 174.51	0.59 251.03	0.22 250.29	0.11 310.31	0.07 184.46	Mag Phase
319	8.58	15.92	5.24 13.45	6.08 54.08	7.28 300.96	5.00 178.42	2.45 336.59	1.59 180.75	0.85 272.34	0.43 245.48	0.15 329.36	0.10 150.94	Mag Phase
320	7.28	12.23	5.12 14.27	5.09 45.80	5.73 285.71	3.88 146.90	1.73 309.58	0.92 143.90	0.46 221.32	0.23 266.86	0.07 273.42	0.09 190.00	Mag Phase
321	7.98	13.87	5.15 13.80	5.43 52.06	6.39 294.67	4.33 164.62	2.15 323.35	1.14 173.33	0.56 248.08	0.23 253.29	0.11 279.49	0.09 185.18	Mag Phase
322	8.22	15.50	5.00 13.75	5.99 47.10	7.03 291.28	4.78 164.10	2.35 323.54	1.45 166.82	0.77 250.09	0.41 228.32	0.15 295.64	0.09 155.52	Mag Phase
323	7.73	11.89	5.33 13.08	4.80 50.85	5.59 291.26	3.73 153.89	1.86 316.27	1.02 155.07	0.41 233.42	0.20 278.99	0.09 295.19	0.10 194.24	Mag Phase
324	8.00	14.13	5.21 14.96	5.47 53.10	6.48 297.26	4.42 168.20	2.20 328.54	1.27 177.48	0.58 253.68	0.23 259.71	0.10 315.90	0.07 188.75	Mag Phase

Table VI. - Continued

(d) Continued

Run 10

$\mu_{Nom.} = 0.30$

POINT	MEAN	1/2P-P	1P	2P	3P	4P	5P	6P	7P	8P	9P	10P	
325	7.00	9.98	4.83 13.49	3.84 57.64	4.38 296.35	3.29 151.66	1.73 321.70	0.85 154.23	0.29 231.50	0.10 312.92	0.02 15.08	0.05 230.50	Mag Phase

$\mu_{Nom.} = 0.325$

POINT	MEAN	1/2P-P	1P	2P	3P	4P	5P	6P	7P	8P	9P	10P	
326	7.38	16.47	5.40 14.71	6.29 44.11	7.37 286.71	5.29 152.80	2.40 317.37	1.48 150.55	0.62 234.93	0.33 258.70	0.17 254.38	0.09 183.31	Mag Phase
327	8.11	20.53	5.99 17.19	7.60 34.28	9.26 284.84	6.35 159.02	3.45 318.12	2.28 159.52	1.31 252.00	0.37 243.18	0.36 275.73	0.09 156.18	Mag Phase
328	7.73	25.15	7.40 27.21	8.45 20.08	9.97 285.65	8.67 175.48	4.73 346.06	7.60 169.28	4.09 260.60	0.78 208.71	1.06 284.10	0.37 119.35	Mag Phase

$\mu_{Nom.} = 0.275$

POINT	MEAN	1/2P-P	1P	2P	3P	4P	5P	6P	7P	8P	9P	10P	
329	8.59	11.57	4.97 13.67	4.88 61.32	5.49 301.99	3.69 174.56	1.76 324.27	1.04 171.78	0.42 252.06	0.28 254.49	0.02 343.46	0.09 166.89	Mag Phase
330	7.56	8.85	4.65 12.14	3.48 71.56	3.61 307.32	2.49 159.70	1.33 321.98	0.60 147.55	0.03 236.81	0.12 261.13	0.06 355.20	0.03 149.74	Mag Phase
331	8.40	9.96	4.57 11.78	4.28 80.54	4.41 318.65	2.88 188.33	1.16 350.55	0.83 172.73	0.08 272.60	0.23 260.57	0.05 39.21	0.06 178.57	Mag Phase
332	6.90	7.36	4.69 16.74	2.88 64.24	2.98 304.68	1.89 146.08	0.91 313.10	0.44 135.77	0.03 191.08	0.15 349.04	0.06 53.28	0.05 167.67	Mag Phase

Table VI. - Continued

(d) Continued

Run 10

$\mu_{Nom.} = 0.275$

POINT	MEAN	1/2P-P	1P	2P	3P	4P	5P	6P	7P	8P	9P	10P	
333	7.59	8.84	4.66 12.44	3.48 73.65	3.60 310.55	2.45 163.51	1.29 327.58	0.67 152.05	0.07 253.75	0.10 244.02	0.07 351.15	0.03 193.93	Mag Phase
334	7.88	8.95	4.43 12.35	4.13 73.42	4.03 312.64	2.54 174.86	1.20 321.57	0.60 175.65	0.18 284.21	0.17 308.02	0.17 27.34	0.04 137.12	Mag Phase
335	7.37	7.83	4.96 15.00	2.72 75.03	3.10 314.93	1.97 158.79	1.09 340.92	0.56 132.70	0.11 118.38	0.09 2.22	0.01 290.08	0.04 156.49	Mag Phase
336	7.62	8.83	4.69 14.09	3.41 75.37	3.57 312.97	2.47 166.86	1.42 335.10	0.60 158.12	0.02 300.06	0.11 245.04	0.07 350.90	0.02 171.51	Mag Phase
337	6.80	6.96	4.45 12.75	2.25 74.28	2.34 305.49	1.84 140.94	0.99 321.62	0.62 131.44	0.14 121.62	0.03 328.69	0.03 25.99	0.05 144.77	Mag Phase

$\mu_{Nom.} = 0.225$

POINT	MEAN	1/2P-P	1P	2P	3P	4P	5P	6P	7P	8P	9P	10P	
338	7.81	6.87	3.90 12.97	3.11 107.63	2.39 349.29	1.26 181.97	0.55 320.26	0.54 143.71	0.16 11.25	0.18 237.78	0.03 2.12	0.05 97.60	Mag Phase
339	7.04	5.74	3.59 13.90	2.35 115.31	1.71 353.29	0.94 159.85	0.43 341.28	0.70 141.81	0.15 16.65	0.13 233.14	0.04 48.95	0.06 89.76	Mag Phase
340	7.59	5.87	3.58 7.15	3.06 120.35	2.03 7.43	0.60 201.59	0.18 248.75	0.61 108.94	0.18 42.98	0.18 252.87	0.04 157.54	0.05 108.11	Mag Phase
341	6.63	5.52	3.64 18.37	2.08 100.62	1.78 329.77	1.17 151.94	0.41 354.08	0.60 137.52	0.11 331.47	0.08 183.19	0.08 63.80	0.09 108.13	Mag Phase

Table VI. - Continued

(d) Concluded

Run 10

$\mu_{Nom.} = 0.225$

POINT	MEAN	1/2P-P	1P	2P	3P	4P	5P	6P	7P	8P	9P	10P	
342	7.08	6.08	3.60 12.26	2.47 112.67	1.87 346.70	1.03 160.53	0.54 342.17	0.69 130.37	0.17 11.30	0.14 205.35	0.02 71.42	0.06 80.98	Mag Phase
343	7.26	6.30	3.41 10.68	2.92 108.50	2.03 350.53	1.11 169.09	0.41 317.79	0.68 125.87	0.14 4.76	0.09 241.61	0.11 93.88	0.06 99.54	Mag Phase
344	6.89	5.74	3.84 12.97	2.02 118.69	1.60 343.35	0.82 144.84	0.64 337.28	0.65 129.34	0.15 358.59	0.08 191.62	0.06 82.30	0.08 104.18	Mag Phase
345	7.14	6.12	3.63 11.93	2.44 111.77	1.86 346.62	1.02 155.31	0.53 330.32	0.69 125.80	0.15 12.72	0.14 220.70	0.02 75.22	0.05 85.55	Mag Phase
346	6.39	5.12	3.32 13.63	1.89 120.09	1.19 343.22	1.02 135.91	0.39 358.92	0.80 128.99	0.11 88.74	0.16 196.81	0.06 118.06	0.05 80.30	Mag Phase



Table VI. - Continued

(e) Blade flapwise bending moment, in-lbs, 37.00 percent radius

Run 10

$\mu_{Nom.} = 0.08$

POINT	MEAN	1/2P-P	1P	2P	3P	4P	5P	6P	7P	8P	9P	10P	
281	-0.31	0.54	0.30 227.25	0.24 117.74	0.14 269.88	0.10 177.87	0.02 243.00	0.04 74.77	0.03 115.69	0.01 75.42	0.04 87.87	0.02 166.95	Mag Phase
282	-0.33	0.44	0.32 211.52	0.20 116.65	0.03 159.62	0.11 173.35	0.04 9.42	0.08 100.62	0.04 156.44	0.03 243.06	0.02 137.69	0.02 7.82	Mag Phase
283	-0.20	0.46	0.31 208.26	0.18 101.69	0.02 13.08	0.08 154.45	0.02 25.88	0.07 109.07	0.02 172.42	0.04 290.69	0.02 149.13	0.03 31.81	Mag Phase

$\mu_{Nom.} = 0.11$

POINT	MEAN	1/2P-P	1P	2P	3P	4P	5P	6P	7P	8P	9P	10P	
284	-0.04	0.31	0.14 178.21	0.10 43.21	0.04 31.07	0.01 152.97	0.07 126.58	0.07 47.21	0.04 68.56	0.05 281.96	0.01 257.91	0.02 184.48	Mag Phase
285	-0.19	0.28	0.02 145.88	0.17 50.81	0.08 3.89	0.09 141.52	0.02 119.22	0.04 46.42	0.06 58.48	0.05 267.89	0.03 240.81	0.03 253.40	Mag Phase
286	-0.10	0.39	0.03 323.04	0.16 59.72	0.09 347.58	0.05 164.61	0.09 343.98	0.11 123.87	0.03 79.62	0.02 289.61	0.11 179.75	0.07 285.24	Mag Phase

$\mu_{Nom.} = 0.13$

POINT	MEAN	1/2P-P	1P	2P	3P	4P	5P	6P	7P	8P	9P	10P	
287	-0.04	0.32	0.09 306.09	0.19 51.28	0.08 328.21	0.09 182.83	0.02 21.86	0.08 95.55	0.05 99.26	0.02 353.48	0.05 131.78	0.01 176.37	Mag Phase
288	-0.05	0.35	0.14 302.08	0.14 67.14	0.09 9.82	0.08 171.08	0.07 318.80	0.07 55.50	0.03 217.50	0.06 292.65	0.05 114.67	0.04 179.86	Mag Phase

Table VI. - Continued

(e) Continued

Run 10

 $\mu_{\text{Nom.}} = 0.13$ 

POINT	MEAN	1/2P-P	1P	2P	3P	4P	5P	6P	7P	8P	9P	10P	
289	0.06	0.43	0.17 286.20	0.17 78.36	0.07 326.20	0.09 165.01	0.06 30.83	0.05 43.67	0.01 65.80	0.05 306.57	0.04 91.28	0.06 263.42	Mag Phase

 $\mu_{\text{Nom.}} = 0.16$ 

POINT	MEAN	1/2P-P	1P	2P	3P	4P	5P	6P	7P	8P	9P	10P	
290	-0.08	0.58	0.25 278.17	0.27 67.38	0.08 279.68	0.07 210.63	0.11 23.16	0.01 313.89	0.02 321.45	0.06 249.11	0.03 53.57	0.02 193.12	Mag Phase
291	-0.29	0.52	0.32 262.71	0.24 46.26	0.11 305.30	0.05 220.16	0.03 54.58	0.06 353.33	0.03 54.78	0.05 252.46	0.05 341.23	0.05 26.73	Mag Phase
292	-0.14	0.50	0.36 252.96	0.19 38.18	0.03 302.34	0.05 134.45	0.07 341.78	0.03 123.14	0.02 206.67	0.04 267.25	0.02 193.90	0.05 201.21	Mag Phase
293	-0.20	0.57	0.36 264.34	0.22 60.67	0.07 166.24	0.03 155.76	0.13 61.51	0.03 255.92	0.04 247.47	0.05 262.41	0.03 322.62	0.03 322.97	Mag Phase
294	-0.14	0.53	0.42 249.21	0.13 17.62	0.02 210.26	0.02 203.85	0.04 336.12	0.04 155.97	0.03 49.08	0.08 264.65	0.03 82.09	0.07 142.80	Mag Phase
295	-0.28	0.61	0.45 247.18	0.16 47.14	0.04 264.54	0.07 161.08	0.08 7.44	0.07 219.06	0.08 328.20	0.05 208.15	0.04 119.61	0.04 255.98	Mag Phase
296	-0.15	0.50	0.40 254.22	0.14 32.44	0.05 150.38	0.07 188.95	0.03 219.14	0.03 109.35	0.01 103.26	0.03 251.10	0.02 149.88	0.05 200.88	Mag Phase
297	-0.04	0.63	0.36 249.80	0.24 22.82	0.10 272.59	0.13 156.77	0.07 286.09	0.03 88.23	0.04 338.67	0.08 265.04	0.06 55.31	0.11 155.98	Mag Phase

Table VI. - Continued

(e) Continued

Run 10

$\mu_{\text{Nom.}} = 0.16$

POINT	MEAN	1/2P-P	1P	2P	3P	4P	5P	6P	7P	8P	9P	10P	
298	-0.08	0.60	0.40 246.10	0.18 42.37	0.06 317.43	0.09 133.06	0.13 69.37	0.02 295.62	0.01 48.83	0.07 273.26	0.04 268.90	0.05 165.82	Mag Phase

$\mu_{\text{Nom.}} = 0.20$

POINT	MEAN	1/2P-P	1P	2P	3P	4P	5P	6P	7P	8P	9P	10P	
299	-0.24	0.51	0.34 217.38	0.10 24.79	0.15 313.85	0.09 283.26	0.08 347.93	0.02 69.50	0.07 137.86	0.08 259.66	0.05 92.80	0.02 240.91	Mag Phase
300	-0.19	0.45	0.25 223.93	0.22 37.98	0.07 344.98	0.11 119.25	0.08 37.47	0.04 226.92	0.02 1.58	0.07 268.13	0.04 10.75	0.03 50.19	Mag Phase
301	-0.29	0.38	0.25 218.38	0.06 345.32	0.05 347.97	0.05 61.29	0.10 164.70	0.06 84.32	0.05 335.88	0.03 32.00	0.05 54.74	0.02 185.52	Mag Phase
302	-0.21	0.39	0.17 225.69	0.19 18.29	0.12 357.92	0.03 69.48	0.03 25.81	0.06 327.90	0.01 169.77	0.06 188.05	0.03 291.08	0.05 227.30	Mag Phase
303	-0.29	0.54	0.16 218.54	0.29 42.14	0.05 15.40	0.08 101.31	0.16 61.58	0.05 285.46	0.02 342.18	0.11 285.56	0.01 335.68	0.04 220.12	Mag Phase
304	-0.17	0.46	0.16 212.86	0.17 39.31	0.09 41.18	0.08 165.38	0.13 150.76	0.05 290.17	0.06 233.91	0.11 279.95	0.02 10.23	0.02 164.77	Mag Phase
305	-0.20	0.51	0.18 226.44	0.20 8.21	0.08 31.61	0.09 318.58	0.04 292.34	0.04 123.87	0.04 338.59	0.07 8.66	0.10 59.34	0.06 345.17	Mag Phase
306	-0.05	0.45	0.12 286.74	0.19 7.27	0.10 5.01	0.04 89.26	0.12 58.10	0.06 198.01	0.06 71.64	0.05 256.13	0.03 342.58	0.02 20.76	Mag Phase

Table VI. - Continued

(e) Continued

Run 10

$\mu_{\text{Nom.}} = 0.20$

POINT	MEAN	1/2P-P	1P	2P	3P	4P	5P	6P	7P	8P	9P	10P	
307	-0.17	0.43	0.11 279.63	0.20 347.22	0.04 13.93	0.03 129.73	0.07 33.65	0.09 198.43	0.04 25.31	0.08 275.09	0.02 322.47	0.04 353.87	Mag Phase

$\mu_{\text{Nom.}} = 0.25$

POINT	MEAN	1/2P-P	1P	2P	3P	4P	5P	6P	7P	8P	9P	10P	
308	-0.32	0.52	0.21 298.89	0.10 338.52	0.15 339.17	0.04 48.31	0.09 9.73	0.02 67.18	0.06 110.77	0.01 207.16	0.02 172.73	0.03 84.61	Mag Phase
309	-0.22	0.47	0.28 282.82	0.08 358.95	0.08 326.39	0.01 39.13	0.05 11.38	0.05 357.31	0.03 80.90	0.06 164.68	0.01 207.20	0.04 272.97	Mag Phase
310	-0.34	0.72	0.49 276.22	0.14 331.09	0.19 299.45	0.03 241.25	0.01 271.86	0.07 26.55	0.04 290.76	0.03 266.11	0.02 169.45	0.03 171.37	Mag Phase
311	-0.27	0.67	0.41 280.43	0.19 11.14	0.11 316.67	0.03 259.44	0.15 22.87	0.05 43.95	0.02 134.35	0.07 233.35	0.03 21.98	0.03 43.85	Mag Phase
312	-0.19	0.65	0.36 272.62	0.17 353.35	0.12 283.09	0.08 277.97	0.09 350.23	0.06 53.48	0.07 42.35	0.02 113.05	0.04 9.70	0.02 299.34	Mag Phase
313	-0.24	0.62	0.44 272.25	0.19 27.79	0.07 314.32	0.01 47.45	0.02 340.96	0.08 60.95	0.00 273.86	0.06 235.78	0.04 18.26	0.03 85.43	Mag Phase
314	0.01	0.68	0.50 276.45	0.12 24.87	0.08 277.59	0.04 317.43	0.07 90.87	0.06 301.67	0.04 51.35	0.06 218.65	0.00 250.29	0.02 356.47	Mag Phase
315	0.17	0.67	0.49 273.97	0.14 2.44	0.06 304.56	0.01 36.52	0.06 23.24	0.04 275.53	0.03 114.29	0.09 163.14	0.04 276.38	0.01 267.29	Mag Phase

Table VI. - Continued

(e) Continued

Run 10

$\mu_{\text{Nom.}} = 0.25$

POINT	MEAN	1/2P-P	1P	2P	3P	4P	5P	6P	7P	8P	9P	10P	
316	-0.13	0.73	0.43 255.62	0.22 9.05	0.08 319.92	0.02 292.27	0.16 40.20	0.07 44.44	0.04 4.30	0.02 306.78	0.03 27.81	0.04 173.17	Mag Phase

$\mu_{\text{Nom.}} = 0.30$

POINT	MEAN	1/2P-P	1P	2P	3P	4P	5P	6P	7P	8P	9P	10P	
317	-0.06	0.48	0.39 229.24	0.11 356.87	0.12 300.42	0.09 118.52	0.11 27.62	0.05 301.53	0.03 67.86	0.04 308.85	0.02 207.34	0.02 254.85	Mag Phase
318	-0.17	0.59	0.44 235.20	0.21 29.38	0.06 230.23	0.08 166.79	0.14 334.20	0.07 80.08	0.04 67.00	0.02 261.01	0.04 87.63	0.01 115.36	Mag Phase
319	-0.01	0.51	0.37 218.15	0.19 28.43	0.05 274.59	0.04 286.14	0.14 358.94	0.01 349.22	0.01 154.90	0.04 248.03	0.06 59.79	0.03 104.35	Mag Phase
320	-0.19	0.47	0.29 217.66	0.10 59.75	0.06 282.73	0.02 158.68	0.08 16.59	0.08 306.02	0.07 93.36	0.05 319.54	0.06 92.66	0.04 80.23	Mag Phase
321	-0.29	0.76	0.36 224.35	0.23 24.66	0.04 323.64	0.01 184.18	0.22 26.92	0.03 256.07	0.05 350.91	0.03 131.94	0.07 251.30	0.01 25.85	Mag Phase
322	-0.22	0.57	0.24 215.11	0.23 23.28	0.04 262.39	0.03 131.56	0.16 1.76	0.05 207.69	0.07 57.65	0.08 198.07	0.00 35.25	0.02 317.88	Mag Phase
323	-0.30	0.49	0.23 233.01	0.19 30.30	0.03 347.43	0.03 263.90	0.14 339.70	0.05 98.91	0.01 336.52	0.06 5.45	0.02 50.69	0.04 124.04	Mag Phase
324	0.11	0.62	0.27 210.37	0.22 24.51	0.10 10.55	0.07 156.05	0.13 12.14	0.05 266.64	0.07 135.22	0.04 251.22	0.01 228.60	0.04 144.93	Mag Phase

Table VI. - Continued

(e) Continued

Run 10

$\mu_{Nom.} = 0.30$

POINT	MEAN	1/2P-P	1P	2P	3P	4P	5P	6P	7P	8P	9P	10P	
325	0.14	0.50	0.19 225.03	0.18 0.32	0.04 25.83	0.02 160.48	0.08 323.36	0.05 56.97	0.05 41.50	0.04 42.78	0.08 151.95	0.04 195.20	Mag Phase

$\mu_{Nom.} = 0.325$

POINT	MEAN	1/2P-P	1P	2P	3P	4P	5P	6P	7P	8P	9P	10P	
326	0.12	0.40	0.01 335.35	0.03 304.55	0.11 347.27	0.15 137.99	0.13 355.11	0.05 221.08	0.07 131.45	0.06 234.11	0.01 357.61	0.06 151.13	Mag Phase
327	0.09	0.35	0.05 342.47	0.06 325.32	0.08 321.18	0.15 156.80	0.15 0.52	0.04 127.10	0.04 248.56	0.05 290.41	0.03 74.79	0.02 83.99	Mag Phase
328	0.32	0.44	0.12 288.46	0.13 24.00	0.14 329.40	0.15 127.62	0.11 3.09	0.03 329.26	0.03 209.47	0.05 240.49	0.05 358.56	0.03 38.78	Mag Phase

$\mu_{Nom.} = 0.275$

POINT	MEAN	1/2P-P	1P	2P	3P	4P	5P	6P	7P	8P	9P	10P	
329	-0.24	0.57	0.38 263.24	0.26 24.26	0.06 325.75	0.05 178.63	0.16 8.24	0.08 222.90	0.02 215.80	0.01 296.72	0.02 56.14	0.01 3.81	Mag Phase
330	-0.04	0.73	0.43 266.08	0.24 18.68	0.05 14.75	0.06 240.67	0.13 31.98	0.05 20.81	0.00 203.73	0.05 181.74	0.02 42.05	0.06 134.52	Mag Phase
331	-0.18	0.87	0.58 264.99	0.26 13.66	0.08 315.03	0.05 233.01	0.18 345.01	0.07 355.79	0.04 78.64	0.02 298.40	0.04 42.55	0.05 358.71	Mag Phase
332	-0.18	0.66	0.45 259.23	0.21 18.57	0.06 24.16	0.08 257.11	0.08 1.62	0.05 148.27	0.03 66.70	0.03 274.81	0.04 55.11	0.07 166.05	Mag Phase

Table VI. - Continued

(e) Continued

Run 10

$\mu_{Nom.} = 0.275$

POINT	MEAN	1/2P-P	1P	2P	3P	4P	5P	6P	7P	8P	9P	10P	
333	-0.28	0.64	0.48 257.34	0.18 6.87	0.03 325.45	0.07 187.28	0.12 1.26	0.02 38.11	0.02 91.01	0.01 180.49	0.02 114.98	0.01 139.13	Mag Phase
334	-0.23	0.64	0.46 242.80	0.25 14.93	0.10 347.08	0.07 160.47	0.08 61.65	0.02 123.54	0.03 36.21	0.06 250.92	0.03 296.76	0.01 352.80	Mag Phase
335	-0.09	0.61	0.42 259.55	0.15 8.70	0.04 9.46	0.10 238.42	0.04 8.13	0.04 54.09	0.05 64.92	0.01 45.49	0.02 351.12	0.05 84.42	Mag Phase
336	-0.09	0.73	0.51 254.22	0.24 3.96	0.07 348.40	0.06 185.50	0.08 10.64	0.06 9.78	0.02 94.89	0.01 278.86	0.03 48.08	0.03 198.33	Mag Phase
337	-0.12	0.78	0.48 244.83	0.32 355.60	0.03 135.40	0.10 203.46	0.11 358.73	0.03 158.65	0.03 190.79	0.07 218.24	0.06 75.57	0.03 158.37	Mag Phase

$\mu_{Nom.} = 0.225$

POINT	MEAN	1/2P-P	1P	2P	3P	4P	5P	6P	7P	8P	9P	10P	
338	-0.05	0.61	0.37 233.00	0.23 19.62	0.10 22.03	0.13 158.35	0.12 41.42	0.02 168.65	0.03 174.05	0.01 269.34	0.02 338.36	0.01 358.54	Mag Phase
339	0.14	0.58	0.40 226.35	0.16 16.26	0.05 21.04	0.11 165.29	0.05 323.68	0.04 83.92	0.06 47.61	0.06 343.76	0.04 53.19	0.04 147.12	Mag Phase
340	0.08	0.54	0.33 223.88	0.23 40.66	0.04 31.84	0.09 122.39	0.05 28.51	0.04 253.86	0.02 99.79	0.05 301.21	0.03 313.05	0.05 155.95	Mag Phase
341	0.05	0.64	0.26 213.64	0.33 23.00	0.04 65.18	0.06 172.31	0.07 64.07	0.06 307.89	0.03 40.58	0.03 218.35	0.03 339.50	0.01 201.62	Mag Phase

Table VI. - Continued

(e) Concluded

Run 10

 $\mu_{\text{Nom.}} = 0.225$ 

POINT	MEAN	1/2P-P	1P	2P	3P	4P	5P	6P	7P	8P	9P	10P	
342	0.00	0.56	0.30 210.72	0.22 27.26	0.12 20.78	0.06 160.45	0.06 344.54	0.09 178.83	0.04 211.90	0.05 285.77	0.03 168.12	0.02 215.50	Mag Phase
343	-0.12	0.59	0.30 212.65	0.31 30.47	0.04 336.56	0.10 157.06	0.07 47.08	0.04 131.00	0.06 26.40	0.06 292.63	0.02 11.17	0.04 78.29	Mag Phase
344	-0.12	0.65	0.27 222.00	0.25 24.08	0.14 31.02	0.03 118.46	0.06 40.15	0.13 139.80	0.06 162.32	0.07 259.53	0.01 125.37	0.03 189.24	Mag Phase
345	-0.15	0.47	0.20 228.59	0.26 14.48	0.09 29.43	0.06 188.53	0.09 14.10	0.02 203.10	0.02 131.07	0.05 259.06	0.01 345.93	0.01 78.57	Mag Phase
346	0.01	0.48	0.23 226.80	0.31 19.74	0.06 17.72	0.01 87.30	0.11 359.92	0.02 111.65	0.04 357.88	0.05 272.49	0.04 15.47	0.03 151.94	Mag Phase



Table VI. - Continued

(f) Blade chordwise bending moment, in-lbs, 45.00 percent radius

Run 10

$\mu_{Nom.} = 0.08$

POINT	MEAN	1/2P-P	1P	2P	3P	4P	5P	6P	7P	8P	9P	10P	
281	-38.89	16.57	3.80 16.12	2.93 52.90	7.86 164.21	2.45 279.04	2.64 340.06	5.05 26.23	0.65 167.80	0.35 109.91	0.67 117.06	0.09 268.99	Mag Phase
282	-39.69	16.26	2.21 19.84	2.71 55.33	6.27 161.68	2.70 281.81	2.21 349.83	5.66 17.09	0.88 131.78	1.40 170.25	0.51 135.97	0.03 260.91	Mag Phase
283	-40.08	13.36	1.22 30.49	2.47 65.85	5.02 166.71	2.61 298.88	3.28 16.34	5.91 2.48	0.66 166.76	1.21 30.76	0.41 174.73	0.05 61.48	Mag Phase

$\mu_{Nom.} = 0.11$

POINT	MEAN	1/2P-P	1P	2P	3P	4P	5P	6P	7P	8P	9P	10P	
284	-40.46	11.85	1.19 325.38	3.22 78.86	4.18 173.90	2.72 303.74	4.81 23.37	2.30 2.42	0.46 127.24	0.30 178.20	0.41 158.38	0.07 155.23	Mag Phase
285	-40.24	13.68	2.17 338.47	4.01 74.74	5.19 164.08	2.88 298.78	4.24 19.30	2.98 4.68	0.40 96.72	0.71 147.26	0.46 135.00	0.11 138.07	Mag Phase
286	-39.63	16.50	3.75 352.71	4.64 77.63	7.07 171.19	3.25 291.74	3.62 6.32	3.32 20.33	0.70 112.91	0.24 28.52	0.77 126.70	0.11 103.35	Mag Phase

$\mu_{Nom.} = 0.13$

POINT	MEAN	1/2P-P	1P	2P	3P	4P	5P	6P	7P	8P	9P	10P	
287	-40.26	17.98	4.59 332.90	5.49 76.13	6.47 166.77	3.48 301.91	4.47 352.47	2.75 73.35	0.62 92.58	1.09 139.64	0.46 146.04	0.03 121.85	Mag Phase
288	-41.10	16.26	3.06 324.39	5.01 83.67	5.16 181.58	3.56 324.93	4.90 30.34	2.08 85.05	0.47 175.28	0.91 78.03	0.46 199.41	0.13 153.19	Mag Phase

Table VI. - Continued

(f) Continued

Run 10

$\mu_{\text{Nom.}} = 0.13$

POINT	MEAN	1/2P-P	1P	2P	3P	4P	5P	6P	7P	8P	9P	10P	
289	-41.45	13.93	2.21 305.50	3.75 80.06	3.98 181.92	3.11 323.70	5.41 10.93	1.68 88.87	0.47 116.54	1.33 190.00	0.52 213.56	0.18 238.38	Mag Phase

$\mu_{\text{Nom.}} = 0.16$

POINT	MEAN	1/2P-P	1P	2P	3P	4P	5P	6P	7P	8P	9P	10P	
290	-41.74	17.13	3.74 311.20	3.88 69.75	4.30 185.13	3.40 330.79	6.36 22.18	3.52 108.04	0.85 90.25	1.34 275.46	0.22 218.74	0.15 5.82	Mag Phase
291	-41.61	19.56	4.97 318.71	4.57 69.14	5.16 175.38	3.72 319.65	6.23 13.33	4.17 104.48	0.82 82.12	0.28 220.25	0.22 197.80	0.06 82.80	Mag Phase
292	-41.51	20.17	5.20 339.22	4.33 77.55	6.02 177.12	3.91 308.23	5.22 19.15	3.93 139.12	0.70 96.22	1.51 234.51	0.44 129.34	0.23 93.30	Mag Phase
293	-41.57	20.06	5.25 303.70	4.24 45.06	4.33 195.64	2.81 301.01	9.43 41.09	4.50 74.75	1.58 77.64	0.28 51.22	0.27 328.83	0.24 351.55	Mag Phase
294	-41.52	19.74	5.29 321.60	4.51 69.18	5.14 176.03	3.68 323.24	6.48 14.81	4.25 106.70	0.63 87.49	0.95 194.28	0.16 168.06	0.02 153.30	Mag Phase
295	-41.76	21.05	7.02 334.86	4.43 67.04	6.23 173.42	3.91 311.77	7.03 345.40	2.71 104.16	0.85 114.68	1.30 187.32	0.14 46.56	0.28 41.44	Mag Phase
296	-41.57	19.43	3.36 301.93	3.89 66.02	4.95 185.93	2.86 317.55	9.10 10.02	3.63 85.42	1.25 62.78	0.74 295.91	0.32 239.88	0.09 338.00	Mag Phase
297	-41.49	19.81	5.07 321.81	4.46 68.52	5.24 175.44	3.54 322.83	7.07 11.32	3.85 101.41	0.99 102.32	1.04 283.83	0.31 205.71	0.08 58.14	Mag Phase

Table VI. - Continued

(f) Continued

Run 10

$\mu_{\text{Nom.}} = 0.16$

POINT	MEAN	1/2P-P	1P	2P	3P	4P	5P	6P	7P	8P	9P	10P	
298	-40.93	22.82	6.78 333.26	5.22 70.85	6.91 176.64	3.63 313.07	6.83 3.28	4.89 124.24	1.63 100.30	0.92 241.79	0.05 82.82	0.02 56.88	Mag Phase

$\mu_{\text{Nom.}} = 0.20$

POINT	MEAN	1/2P-P	1P	2P	3P	4P	5P	6P	7P	8P	9P	10P	
299	-41.15	26.65	10.18 326.78	5.48 57.55	7.65 177.17	3.76 284.35	7.80 355.34	4.86 119.14	1.05 93.57	0.62 65.89	0.52 113.62	0.14 167.28	Mag Phase
300	-42.06	22.32	8.10 316.11	4.68 59.65	5.70 172.80	3.49 308.14	7.57 355.73	3.93 112.47	1.19 76.16	0.58 315.32	0.40 127.98	0.11 111.35	Mag Phase
301	-42.17	27.27	9.11 339.64	5.07 76.47	8.11 194.41	5.28 306.48	7.97 19.81	3.87 174.40	0.30 254.25	0.38 308.78	1.26 158.21	0.36 192.21	Mag Phase
302	-42.05	20.58	7.93 301.46	4.46 42.08	3.94 192.89	3.14 292.59	8.30 36.50	3.70 71.71	1.75 88.83	0.89 244.57	0.65 13.71	0.25 330.70	Mag Phase
303	-42.27	22.52	8.15 319.45	4.67 69.66	5.68 184.57	3.80 324.46	7.12 21.25	4.39 137.98	1.01 91.78	0.94 176.49	0.39 165.48	0.10 240.82	Mag Phase
304	-42.21	26.76	10.18 333.82	5.01 64.47	7.56 183.76	3.64 310.20	8.48 4.07	3.22 153.37	0.35 155.63	0.60 311.83	0.30 128.01	0.33 140.81	Mag Phase
305	-42.16	23.05	6.16 303.89	4.17 72.93	5.17 199.83	2.72 330.71	10.72 42.98	3.98 123.00	1.32 88.86	0.35 53.08	0.19 244.17	0.08 201.44	Mag Phase
306	-42.16	23.28	8.06 316.64	4.80 62.63	5.76 174.75	3.56 311.96	8.20 4.72	3.91 127.00	1.03 83.50	0.05 3.98	0.35 111.41	0.09 189.17	Mag Phase

Table VI. - Continued

(f) Continued

Run 10

$\mu_{\text{Nom.}} = 0.20$

POINT	MEAN	1/2P-P	1P	2P	3P	4P	5P	6P	7P	8P	9P	10P	
307	-42.49	20.24	6.35 303.65	3.81 60.67	4.17 181.89	3.62 317.26	7.74 14.00	3.88 107.19	0.58 49.03	0.59 150.21	0.21 172.10	0.10 182.82	Mag Phase

$\mu_{\text{Nom.}} = 0.25$

POINT	MEAN	1/2P-P	1P	2P	3P	4P	5P	6P	7P	8P	9P	10P	
308	-42.28	18.86	9.08 308.54	3.27 65.61	3.99 175.10	3.00 312.56	9.17 4.27	1.62 48.08	1.05 25.78	0.59 19.74	0.62 47.00	0.21 259.95	Mag Phase
309	-41.86	26.34	11.49 320.49	4.16 66.47	5.69 175.37	3.06 294.65	11.69 11.50	1.19 28.42	0.52 102.62	1.06 34.32	0.83 74.71	0.12 331.06	Mag Phase
310	-41.93	32.80	13.81 336.99	6.70 87.00	9.17 185.99	7.75 294.94	8.71 4.50	5.36 99.44	1.30 247.12	1.30 133.78	0.76 122.07	0.51 268.43	Mag Phase
311	-42.00	20.16	10.96 303.85	4.36 42.73	3.19 174.76	3.92 288.74	6.99 7.96	4.85 24.10	0.89 50.58	0.78 193.66	0.96 22.48	0.09 243.64	Mag Phase
312	-41.66	27.86	11.67 320.39	4.18 57.90	6.25 169.23	2.29 280.80	11.94 356.64	1.13 69.90	0.48 125.03	0.38 202.27	0.86 65.71	0.17 358.19	Mag Phase
313	-41.72	31.69	14.11 330.61	4.76 73.63	8.07 171.16	4.42 277.64	10.53 351.92	2.56 25.30	0.98 261.20	1.61 157.11	0.92 96.47	0.28 80.57	Mag Phase
314	-41.58	22.50	9.12 304.57	4.13 68.10	4.74 186.38	2.90 313.49	10.47 22.60	2.65 76.04	1.60 50.47	1.18 200.24	0.79 36.11	0.10 289.41	Mag Phase
315	-41.72	26.87	11.65 320.17	3.63 61.31	6.01 175.90	2.55 290.83	11.45 358.85	1.74 90.72	0.42 142.58	1.02 133.36	0.91 83.95	0.20 339.09	Mag Phase

Table VI. - Continued

(f) Continued

Run 10

$\mu_{Nom.} = 0.25$

POINT	MEAN	1/2P-P	1P	2P	3P	4P	5P	6P	7P	8P	9P	10P	
316	-40.76	33.16	14.57 327.29	4.61 63.81	8.85 173.35	4.00 265.84	12.78 358.93	3.49 77.90	0.70 293.51	0.79 105.71	1.08 122.05	0.26 102.38	Mag Phase

$\mu_{Nom.} = 0.30$

POINT	MEAN	1/2P-P	1P	2P	3P	4P	5P	6P	7P	8P	9P	10P	
317	-35.44	57.04	18.76 329.45	7.27 332.53	6.79 131.57	6.43 146.98	8.09 314.06	26.48 10.21	6.02 36.96	1.20 171.30	2.60 100.60	0.62 83.40	Mag Phase
318	-38.66	44.23	16.80 322.24	5.44 351.91	6.93 141.59	4.00 157.32	9.61 340.36	17.72 24.27	2.05 47.32	2.35 199.28	2.03 78.76	0.38 74.03	Mag Phase
319	-37.78	48.43	18.80 337.85	4.94 15.39	8.68 162.26	3.34 178.73	5.62 342.82	19.31 27.46	3.47 50.31	1.42 295.99	1.63 139.44	0.64 157.66	Mag Phase
320	-39.27	35.28	16.02 304.26	5.36 348.80	4.83 123.54	1.70 194.39	10.35 333.46	13.95 1.10	3.22 64.25	1.89 144.39	3.22 23.48	0.31 328.44	Mag Phase
321	-38.86	41.87	16.64 320.82	5.56 352.48	6.61 143.95	4.20 158.81	8.99 342.16	17.46 21.46	2.13 63.22	0.51 137.08	2.08 67.98	0.18 88.70	Mag Phase
322	-38.44	48.66	19.19 330.97	5.34 356.06	7.70 142.15	3.02 152.70	7.99 332.60	19.46 11.92	3.38 27.07	1.88 238.99	1.65 124.73	0.76 100.16	Mag Phase
323	-39.14	34.70	14.14 305.48	5.36 349.16	4.95 146.59	2.49 150.13	12.09 348.49	11.14 356.66	2.72 95.46	1.56 48.13	2.51 46.15	0.18 142.98	Mag Phase
324	-38.67	42.10	16.68 321.06	5.60 353.51	6.60 147.69	4.32 159.86	8.59 351.52	17.95 27.88	2.19 63.96	0.98 128.51	2.24 68.43	0.14 71.74	Mag Phase

Table VI. - Continued

(f) Continued

Run 10

$\mu_{Nom.} = 0.30$

POINT	MEAN	1/2P-P	1P	2P	3P	4P	5P	6P	7P	8P	9P	10P	
325	-40.88	31.06	13.40	4.12	4.79	2.08	10.15	8.85	0.86	1.52	2.16	0.42	Mag
			314.35	8.72	152.83	134.64	346.81	358.44	63.88	227.32	48.07	2.06	Phase

$\mu_{Nom.} = 0.325$

POINT	MEAN	1/2P-P	1P	2P	3P	4P	5P	6P	7P	8P	9P	10P	
326	-38.15	43.96	15.65	7.05	6.10	4.62	11.85	19.43	4.62	1.41	3.39	0.46	Mag
			312.79	321.18	132.42	130.33	335.59	2.99	56.45	151.40	17.58	44.67	Phase
327	-34.95	59.15	17.88	8.50	6.96	6.61	13.12	28.61	7.76	2.40	3.77	1.05	Mag
			320.96	315.22	125.01	138.79	314.49	10.74	54.38	180.44	52.43	72.57	Phase
328	-28.92	109.65	17.72	9.28	8.38	6.59	27.92	64.31	14.44	2.89	3.21	0.99	Mag
			333.54	302.00	130.52	150.35	316.10	13.80	58.43	244.72	94.15	107.42	Phase

$\mu_{Nom.} = 0.275$

POINT	MEAN	1/2P-P	1P	2P	3P	4P	5P	6P	7P	8P	9P	10P	
329	-39.43	44.32	16.53	4.74	8.23	3.67	13.35	11.84	1.17	1.99	1.61	0.39	Mag
			327.07	23.23	158.69	196.33	337.17	6.85	8.76	169.59	103.76	31.42	Phase
330	-41.21	31.75	13.73	4.29	6.96	1.60	13.26	4.15	0.43	1.52	1.32	0.25	Mag
			318.83	49.93	164.45	240.56	341.05	359.67	227.68	55.79	87.02	352.94	Phase
331	-40.77	37.69	16.56	4.78	9.41	5.63	10.31	7.51	1.44	1.89	1.15	0.35	Mag
			337.07	70.17	179.59	272.18	353.77	25.94	237.71	106.25	122.59	213.05	Phase
332	-41.57	23.87	12.72	5.60	3.56	2.98	9.10	5.45	0.74	1.25	1.64	0.13	Mag
			304.76	32.62	166.33	276.84	346.54	8.37	121.34	219.50	46.27	282.95	Phase

Table VI. - Continued

(f) Continued

Run 10

$\mu_{Nom.} = 0.275$

POINT	MEAN	1/2P-P	1P	2P	3P	4P	5P	6P	7P	8P	9P	10P	
333	-41.24	30.99	13.79 320.77	4.36 53.28	7.03 164.75	1.45 228.83	12.22 345.54	3.37 358.62	0.25 231.94	0.24 36.52	1.46 89.88	0.41 355.62	Mag Phase
334	-41.14	40.04	16.64 331.23	4.55 61.43	8.82 163.64	4.30 249.74	12.25 328.54	7.23 3.10	0.79 208.28	2.52 113.58	0.35 77.28	0.25 334.04	Mag Phase
335	-41.50	23.79	10.69 307.44	5.18 41.71	4.55 189.59	0.99 257.83	11.21 19.86	0.61 217.82	1.10 133.36	1.08 173.32	1.79 65.40	0.06 233.62	Mag Phase
336	-41.36	31.25	13.67 322.46	4.70 52.65	6.99 170.67	1.57 227.25	13.27 353.99	2.48 29.12	0.59 194.71	1.43 355.77	1.51 108.23	0.13 21.96	Mag Phase
337	-42.59	24.51	10.82 314.44	4.17 44.07	4.64 172.57	0.98 286.11	11.04 342.58	1.33 7.81	0.16 286.09	1.26 140.07	1.36 54.15	0.37 306.80	Mag Phase

$\mu_{Nom.} = 0.225$

POINT	MEAN	1/2P-P	1P	2P	3P	4P	5P	6P	7P	8P	9P	10P	
338	-42.05	28.62	12.57 328.51	5.55 59.78	7.59 181.73	2.64 286.94	9.95 4.08	3.24 121.62	0.79 149.85	0.39 80.23	0.69 121.50	0.05 355.69	Mag Phase
339	-42.72	21.55	9.79 317.58	4.94 64.39	4.94 183.14	2.73 319.91	8.18 7.16	2.86 172.54	0.99 104.25	0.44 85.35	0.77 99.33	0.22 294.58	Mag Phase
340	-42.64	29.44	11.65 335.78	6.96 84.17	8.30 186.76	7.39 297.23	5.60 0.40	4.80 155.35	0.95 178.99	0.90 331.14	1.11 120.74	0.36 273.93	Mag Phase
341	-42.73	21.63	9.12 298.30	4.43 48.59	3.67 200.94	3.60 297.35	9.43 29.39	5.07 60.87	1.26 73.03	0.99 315.26	0.74 21.07	0.36 7.23	Mag Phase

Table VI. - Continued

(f) Concluded

Run 10

$\mu_{Nom.} = 0.225$

POINT	MEAN	1/2P-P	1P	2P	3P	4P	5P	6P	7P	8P	9P	10P	
342	-42.74	23.54	9.65 313.80	5.09 63.98	5.06 181.96	2.56 321.76	8.47 8.41	4.82 130.41	1.03 112.78	0.95 71.10	0.59 81.54	0.20 268.19	Mag Phase
343	-42.74	28.16	12.61 328.22	5.22 72.40	7.46 174.92	3.68 297.51	9.44 339.09	1.25 193.61	0.62 201.37	1.04 64.73	0.78 90.61	0.43 28.58	Mag Phase
344	-42.64	23.75	7.11 296.26	4.04 65.96	4.59 200.73	3.17 330.71	12.26 30.82	3.79 101.23	1.40 73.89	1.06 321.41	0.46 301.16	0.31 350.32	Mag Phase
345	-43.06	22.17	9.57 314.85	4.96 64.78	5.03 180.32	2.72 316.87	7.77 359.63	3.17 146.37	1.27 105.40	0.70 313.05	0.84 89.24	0.22 298.67	Mag Phase
346	-43.30	18.68	7.22 302.86	3.98 66.58	3.60 191.71	3.02 332.82	7.77 19.58	3.34 112.53	0.80 72.19	0.89 232.07	0.40 45.37	0.23 310.90	Mag Phase



Table VI. - Continued

(g) Blade flapwise bending moment, in-lbs, 51.00 percent radius

Run 10

$\mu_{Nom.} = 0.08$

POINT	MEAN	1/2P-P	1P	2P	3P	4P	5P	6P	7P	8P	9P	10P	
281	18.52	125.74	22.98 205.86	24.32 92.90	27.12 333.60	21.40 261.60	20.90 165.93	21.12 75.85	18.93 344.01	16.83 245.39	18.18 157.71	17.28 65.95	Mag Phase
282	-21.89	460.74	91.78 178.65	96.91 81.12	98.19 334.60	84.56 245.02	84.83 146.82	74.50 48.66	68.98 314.38	63.47 210.07	52.49 116.37	49.93 17.79	Mag Phase
283	-14.57	330.65	45.36 168.83	71.28 94.21	77.92 320.81	43.00 252.41	74.63 146.33	44.87 29.03	52.80 327.16	60.36 195.67	27.54 118.26	53.09 21.20	Mag Phase

$\mu_{Nom.} = 0.11$

POINT	MEAN	1/2P-P	1P	2P	3P	4P	5P	6P	7P	8P	9P	10P	
284	13.90	107.06	11.51 10.03	25.78 151.18	23.32 291.29	17.82 21.12	19.27 172.68	12.96 267.95	19.83 50.67	13.87 152.73	18.92 286.60	10.56 61.23	Mag Phase
285	-5.78	310.34	60.53 194.62	64.31 112.16	58.36 14.90	57.44 303.97	55.43 218.45	50.57 138.29	49.53 55.87	40.11 336.70	41.38 252.20	36.56 165.17	Mag Phase
286	-12.37	389.59	79.11 198.53	80.37 118.66	73.86 29.97	72.85 319.20	68.52 240.65	65.08 162.45	60.12 85.25	52.83 10.63	50.05 288.03	45.35 208.68	Mag Phase

$\mu_{Nom.} = 0.13$

POINT	MEAN	1/2P-P	1P	2P	3P	4P	5P	6P	7P	8P	9P	10P	
287	-39.90	531.20	133.33 204.39	132.57 135.41	114.88 61.45	112.09 355.71	100.59 286.77	88.12 217.24	75.71 147.35	65.16 78.64	51.77 4.99	40.09 290.56	Mag Phase
288	-5.50	313.16	61.68 211.16	66.23 146.95	52.90 71.33	57.60 15.12	53.96 309.01	50.45 247.25	48.27 180.58	45.53 120.74	42.72 52.24	36.65 347.24	Mag Phase

Table VI. - Continued

(g) Continued

Run 10

 $\mu_{\text{Nom.}} = 0.13$ 

POINT	MEAN	1/2P-P	1P	2P	3P	4P	5P	6P	7P	8P	9P	10P	
289	25.12	13.52	4.88 287.23	5.62 187.15	7.22 296.80	0.61 267.03	0.63 146.67	0.92 74.74	0.69 3.13	1.92 157.35	0.34 60.63	0.22 282.26	Mag Phase

 $\mu_{\text{Nom.}} = 0.16$ 

POINT	MEAN	1/2P-P	1P	2P	3P	4P	5P	6P	7P	8P	9P	10P	
290	-5.45	308.83	61.95 218.09	66.71 162.93	51.97 101.95	56.48 49.80	53.38 354.36	50.35 299.93	47.36 243.00	45.10 185.89	39.93 130.74	34.99 74.61	Mag Phase
291	-33.36	516.43	119.21 212.52	121.33 153.06	103.09 89.75	103.00 31.90	94.49 332.26	85.24 272.10	75.96 211.32	68.19 149.40	55.65 87.97	45.73 24.44	Mag Phase
292	20.83	56.03	8.49 212.24	13.80 135.68	14.69 334.74	9.95 296.44	10.27 194.76	8.10 124.35	9.62 32.83	5.15 306.32	8.47 228.06	5.71 129.54	Mag Phase
293	-10.40	365.95	74.83 233.49	78.64 191.15	64.32 156.54	67.17 114.19	64.67 75.33	60.88 35.69	56.12 355.34	48.83 315.81	46.62 275.43	41.98 234.89	Mag Phase
294	-31.59	498.59	115.97 215.47	118.26 158.75	99.47 99.02	99.90 43.67	91.70 347.05	82.72 289.87	73.58 231.95	65.68 172.30	53.86 114.69	44.19 54.52	Mag Phase
295	21.81	32.45	5.92 37.19	10.64 200.02	6.84 306.22	5.66 294.41	8.34 98.80	7.84 244.14	6.71 41.38	4.32 177.25	2.26 84.68	4.70 267.15	Mag Phase
296	2.20	251.79	49.43 226.72	54.93 174.86	38.92 127.22	44.60 77.38	43.11 29.94	41.24 341.41	39.11 291.80	35.12 239.31	33.45 193.89	30.53 145.11	Mag Phase
297	-27.36	461.46	107.86 217.94	110.43 163.25	91.29 106.44	92.39 53.00	84.82 358.76	76.40 303.92	67.81 248.17	59.90 190.18	49.44 135.27	40.49 77.26	Mag Phase

Table VI. - Continued

(g) Continued

Run 10

 $\mu_{\text{Nom.}} = 0.16$ 

POINT	MEAN	1/2P-P	1P	2P	3P	4P	5P	6P	7P	8P	9P	10P	
298	0.12	266.07	56.02 223.88	60.77 171.07	42.93 117.62	49.18 67.59	46.62 17.63	43.78 326.77	40.92 274.70	37.75 219.20	33.61 171.78	29.55 119.90	Mag Phase

 $\mu_{\text{Nom.}} = 0.20$ 

POINT	MEAN	1/2P-P	1P	2P	3P	4P	5P	6P	7P	8P	9P	10P	
299	17.52	126.55	22.66 236.29	30.23 187.26	14.93 161.80	20.70 104.44	21.15 66.11	20.68 24.30	19.93 338.86	17.55 290.45	17.97 258.42	17.38 217.59	Mag Phase
300	8.56	205.05	38.09 228.59	45.27 180.55	29.83 137.96	35.34 87.77	34.76 44.11	33.37 358.43	32.11 310.65	29.74 260.26	27.57 219.70	25.64 174.18	Mag Phase
301	6.09	226.36	43.12 218.24	49.33 164.31	34.05 95.67	40.04 45.55	38.16 350.93	36.42 294.88	35.41 239.70	35.36 184.04	30.24 125.29	27.51 67.98	Mag Phase
302	6.01	238.67	43.15 243.08	49.46 206.64	39.41 187.29	40.52 149.83	40.70 119.48	39.23 88.35	36.59 56.87	33.12 29.53	32.92 356.52	30.74 324.88	Mag Phase
303	16.25	129.78	22.78 232.94	30.20 185.89	14.98 143.88	21.53 94.39	21.39 54.09	20.75 10.33	20.65 324.08	19.94 273.45	18.11 237.05	17.15 194.07	Mag Phase
304	27.90	15.32	2.12 315.14	6.98 195.34	8.03 309.34	0.98 311.35	0.76 171.70	0.61 122.07	0.67 290.21	3.08 200.17	0.20 97.50	0.35 327.62	Mag Phase
305	10.66	191.41	33.92 242.75	41.44 203.29	28.24 181.94	31.92 140.17	32.39 108.55	31.46 75.25	29.67 40.56	26.00 7.80	27.03 336.47	25.83 303.05	Mag Phase
306	16.75	125.39	21.88 233.41	29.43 184.54	14.48 149.27	20.42 94.81	20.71 54.18	20.25 10.40	19.95 323.41	18.39 272.51	17.74 237.30	17.02 194.60	Mag Phase

Table VI. - Continued

(g) Continued

Run 10

 $\mu_{\text{Nom.}} = 0.20$ 

POINT	MEAN	1/2P-P	1P	2P	3P	4P	5P	6P	7P	8P	9P	10P	
307	7.47	207.72	38.09 226.85	44.88 178.72	30.78 132.68	35.73 83.15	35.14 38.23	33.83 351.51	32.52 303.49	30.81 252.49	28.11 209.75	26.07 163.12	Mag Phase

 $\mu_{\text{Nom.}} = 0.25$ 

POINT	MEAN	1/2P-P	1P	2P	3P	4P	5P	6P	7P	8P	9P	10P	
308	28.85	12.05	3.37 19.92	5.42 203.17	5.59 305.62	0.73 340.81	0.22 4.77	0.31 111.81	0.77 30.45	1.45 209.35	0.46 194.10	0.37 185.32	Mag Phase
309	30.10	13.29	3.84 23.81	5.32 206.37	6.55 308.15	0.90 331.68	0.41 268.22	0.70 165.55	0.72 78.60	1.71 205.27	0.37 147.17	0.18 52.27	Mag Phase
310	30.12	14.74	3.25 7.61	6.78 204.67	7.47 305.09	0.58 328.24	0.56 269.02	0.88 171.76	0.76 107.61	1.65 194.35	0.47 163.96	0.19 75.73	Mag Phase
311	29.98	11.97	4.21 26.80	4.73 199.17	5.55 300.57	0.88 317.58	0.30 249.74	0.56 160.42	0.78 76.42	1.16 199.26	0.28 101.74	0.23 11.41	Mag Phase
312	30.03	13.35	3.87 22.15	5.52 201.92	6.54 301.93	0.93 322.59	0.47 245.30	0.70 151.62	0.69 55.16	1.64 184.86	0.32 143.82	0.10 25.79	Mag Phase
313	30.00	12.44	3.14 25.83	5.02 207.15	6.27 306.41	0.85 335.81	0.51 255.25	0.79 171.74	0.72 82.42	1.77 186.51	0.58 135.90	0.18 43.49	Mag Phase
314	30.02	13.07	4.43 20.59	5.53 202.23	6.52 306.86	0.91 320.42	0.44 247.67	0.63 160.32	0.59 63.84	1.41 205.20	0.34 152.09	0.12 38.42	Mag Phase
315	30.00	13.09	3.83 23.81	5.38 206.29	6.47 307.07	0.92 326.32	0.49 256.68	0.69 160.68	0.64 74.44	1.63 200.61	0.38 142.89	0.11 42.65	Mag Phase

Table VI. - Continued

(g) Continued

Run 10

$\mu_{\text{Nom.}} = 0.25$

POINT	MEAN	1/2P-P	1P	2P	3P	4P	5P	6P	7P	8P	9P	10P	
316	31.19	13.85	3.85 20.96	5.30 200.39	6.53 299.39	0.81 346.32	0.59 247.21	0.87 160.71	0.74 80.83	2.00 198.90	0.46 153.11	0.16 62.57	Mag Phase

$\mu_{\text{Nom.}} = 0.30$

POINT	MEAN	1/2P-P	1P	2P	3P	4P	5P	6P	7P	8P	9P	10P	
317	35.22	11.79	6.97 28.11	1.31 222.85	4.22 218.53	0.92 344.94	0.31 20.37	1.12 236.22	1.88 75.32	0.97 245.15	0.46 180.40	0.31 61.22	Mag Phase
318	33.83	11.57	7.03 33.89	2.65 203.14	3.73 255.75	0.97 328.57	0.34 354.71	0.89 244.28	1.60 88.78	1.11 261.08	0.28 174.00	0.26 87.77	Mag Phase
319	33.88	12.51	6.54 29.35	3.03 215.30	4.12 249.30	0.63 347.14	0.36 319.10	1.16 242.04	2.05 92.36	1.82 233.59	0.46 185.97	0.39 97.17	Mag Phase
320	33.69	10.98	7.58 32.40	2.71 185.77	3.12 255.20	1.20 311.88	0.34 357.34	0.73 241.02	1.09 83.26	0.86 243.37	0.22 149.59	0.12 66.18	Mag Phase
321	33.76	11.52	6.99 33.50	2.80 202.78	3.77 259.56	0.98 327.00	0.35 341.90	0.84 244.89	1.44 88.25	1.06 275.24	0.25 189.52	0.24 90.52	Mag Phase
322	33.88	11.03	6.48 35.18	2.24 214.21	3.37 245.22	0.84 336.89	0.31 338.10	1.03 232.48	1.76 83.04	1.59 238.61	0.23 169.93	0.29 77.10	Mag Phase
323	33.75	11.56	7.55 30.03	3.23 195.42	3.68 265.52	1.00 313.14	0.39 352.60	0.77 233.67	1.16 91.71	0.91 298.49	0.13 150.57	0.20 68.35	Mag Phase
324	33.82	11.69	7.10 34.18	2.82 206.11	3.67 262.91	1.01 331.94	0.26 352.52	0.85 251.34	1.44 95.54	1.12 274.87	0.22 198.25	0.23 102.14	Mag Phase

Table VI. - Continued

(g) Continued

Run 10

$\mu_{Nom.} = 0.30$

POINT	MEAN	1/2P-P	1P	2P	3P	4P	5P	6P	7P	8P	9P	10P	
325	32.45	11.22	6.95	3.48	3.82	1.08	0.49	0.82	0.98	1.19	0.32	0.21	Mag Phase
			35.50	212.41	296.05	315.54	336.98	245.74	100.92	265.07	176.58	104.38	

$\mu_{Nom.} = 0.325$

POINT	MEAN	1/2P-P	1P	2P	3P	4P	5P	6P	7P	8P	9P	10P	
326	34.52	11.60	8.74	1.22	2.72	1.39	0.61	0.82	1.27	1.27	0.46	0.21	Mag Phase
			32.75	204.91	225.05	333.87	57.14	266.90	98.47	292.89	215.93	95.66	
327	35.96	13.36	8.73	0.65	4.03	1.39	0.85	0.96	1.71	1.41	0.49	0.21	Mag Phase
			29.61	272.12	198.75	339.21	66.86	254.60	81.08	332.94	208.24	74.96	
328	36.99	14.37	8.90	2.52	4.92	1.44	1.00	1.18	2.64	0.96	0.95	0.34	Mag Phase
			26.00	316.45	197.09	0.96	66.14	246.98	83.84	338.21	191.01	67.40	

$\mu_{Nom.} = 0.275$

POINT	MEAN	1/2P-P	1P	2P	3P	4P	5P	6P	7P	8P	9P	10P	
329	32.72	12.00	5.11	4.02	5.44	0.98	0.47	0.39	1.60	1.15	0.45	0.32	Mag Phase
			23.13	209.22	273.85	333.23	300.92	195.19	62.40	218.54	141.62	78.16	
330	31.47	12.90	5.25	4.95	5.72	1.02	0.58	0.47	1.21	1.58	0.29	0.27	Mag Phase
			26.89	211.78	297.48	316.84	313.34	201.96	72.44	227.31	150.89	91.94	
331	31.45	13.76	4.37	5.18	6.26	0.75	0.79	0.46	1.74	1.83	0.33	0.37	Mag Phase
			19.72	218.06	290.15	339.39	313.92	199.49	81.78	232.72	133.00	84.35	
332	30.61	15.51	4.41	5.99	5.49	1.60	1.43	2.17	2.57	1.53	2.04	1.97	Mag Phase
			18.34	213.49	281.37	226.59	181.85	169.25	122.10	144.24	103.32	75.16	

Table VI. - Continued

(g) Continued

Run 10

$\mu_{Nom.} = 0.275$

POINT	MEAN	1/2P-P	1P	2P	3P	4P	5P	6P	7P	8P	9P	10P	
333	31.39	12.70	5.16 27.16	4.92 213.50	5.79 297.58	0.94 322.28	0.58 314.71	0.52 209.65	1.17 67.15	1.45 217.82	0.33 150.33	0.24 91.97	Mag Phase
334	31.36	12.53	4.38 29.94	4.65 215.39	5.73 291.89	0.94 323.04	0.63 315.60	0.42 201.05	1.59 72.02	1.27 210.10	0.49 104.17	0.33 86.35	Mag Phase
335	31.54	12.22	5.83 27.61	5.11 213.31	5.76 309.43	0.87 324.24	0.40 311.93	0.51 212.04	0.88 99.70	0.89 265.08	0.29 165.25	0.27 86.43	Mag Phase
336	31.44	12.90	5.17 29.01	4.90 218.11	5.82 304.69	1.08 326.05	0.53 324.77	0.45 219.98	1.16 80.98	1.61 234.00	0.27 184.42	0.23 107.92	Mag Phase
337	30.44	12.20	5.22 28.55	4.98 218.95	5.73 310.28	1.20 310.04	0.72 321.91	0.58 217.11	1.01 82.94	1.52 235.69	0.31 152.70	0.17 89.30	Mag Phase

$\mu_{Nom.} = 0.225$

POINT	MEAN	1/2P-P	1P	2P	3P	4P	5P	6P	7P	8P	9P	10P	
338	30.16	15.82	2.73 359.05	7.18 194.99	7.53 308.67	1.06 319.01	0.64 235.43	0.85 111.90	0.83 70.69	2.42 193.03	0.50 135.66	0.20 308.09	Mag Phase
339	29.12	14.15	2.75 5.93	6.48 198.41	6.95 314.46	1.10 313.90	0.53 242.28	0.66 127.96	0.68 81.48	2.25 194.57	0.57 139.65	0.24 307.98	Mag Phase
340	29.05	15.64	2.38 341.18	7.67 194.50	8.26 305.57	0.90 295.49	0.50 244.90	0.76 101.34	0.67 30.87	1.76 238.58	0.58 166.08	0.17 355.61	Mag Phase
341	29.07	12.74	3.34 21.71	5.73 192.93	6.05 307.23	1.22 310.22	0.62 219.33	0.44 116.78	0.22 19.58	2.14 163.67	0.55 117.62	0.03 174.60	Mag Phase

Table VI. - Continued

(g) Concluded

Run 10

 $\mu_{\text{Nom.}} = 0.225$ 

POINT	MEAN	1/2P-P	1P	2P	3P	4P	5P	6P	7P	8P	9P	10P	
342	29.04	14.44	2.84 5.37	6.70 196.67	6.94 309.47	1.08 305.57	0.55 232.01	0.68 114.63	0.68 63.45	2.43 177.44	0.53 130.87	0.24 304.34	Mag Phase
343	29.04	14.04	1.90 3.41	6.66 195.72	7.16 308.71	1.18 305.30	0.52 231.05	0.77 102.96	0.58 59.42	1.69 189.67	0.72 139.23	0.17 276.25	Mag Phase
344	28.96	13.29	3.53 7.89	6.52 195.41	6.82 311.87	1.03 306.74	0.66 225.87	0.66 117.73	0.43 26.48	2.02 165.86	0.36 118.60	0.11 290.32	Mag Phase
345	29.14	14.37	2.86 5.65	6.71 196.13	7.04 309.22	1.11 307.26	0.54 230.67	0.75 110.19	0.71 63.01	2.04 185.74	0.58 134.14	0.23 294.99	Mag Phase
346	28.10	13.03	2.85 11.87	6.01 198.19	6.49 313.50	1.20 305.06	0.44 241.20	0.60 110.79	0.41 59.41	2.07 189.11	0.61 135.15	0.26 295.55	Mag Phase



Table VI. - Continued

(h) Blade torsional moment, in-lbs, 60.00 percent radius

Run 10

$\mu_{Nom.} = 0.08$

POINT	MEAN	1/2P-P	1P	2P	3P	4P	5P	6P	7P	8P	9P	10P	
281	7.53	5.92	1.71 15.37	2.92 89.74	0.88 141.15	1.06 163.92	1.41 215.78	0.67 176.60	0.21 322.01	0.15 344.02	0.14 344.49	0.02 30.07	Mag Phase
282	6.83	5.41	1.49 11.53	2.70 97.25	0.79 130.63	0.97 176.65	1.49 222.55	0.71 163.57	0.25 335.76	0.13 350.24	0.10 345.69	0.04 91.80	Mag Phase
283	6.20	4.58	1.39 9.37	2.27 103.14	0.73 132.50	0.78 182.40	1.36 232.02	0.71 163.25	0.26 355.59	0.06 308.46	0.08 359.41	0.05 118.36	Mag Phase

$\mu_{Nom.} = 0.11$

POINT	MEAN	1/2P-P	1P	2P	3P	4P	5P	6P	7P	8P	9P	10P	
284	6.35	4.14	1.66 5.19	2.03 121.06	0.86 94.10	0.86 173.50	1.21 227.69	0.41 144.24	0.19 348.02	0.13 63.53	0.08 15.96	0.07 107.71	Mag Phase
285	7.00	4.81	1.74 5.16	2.41 114.44	0.96 88.13	1.02 174.58	1.35 222.62	0.44 142.14	0.19 322.84	0.14 39.75	0.11 346.94	0.07 97.71	Mag Phase
286	7.77	5.72	1.85 9.34	2.92 115.68	1.05 92.28	1.24 188.29	1.58 234.08	0.38 158.75	0.22 351.51	0.15 57.00	0.14 1.26	0.07 132.67	Mag Phase

$\mu_{Nom.} = 0.13$

POINT	MEAN	1/2P-P	1P	2P	3P	4P	5P	6P	7P	8P	9P	10P	
287	7.87	5.11	2.00 7.66	2.82 122.65	1.32 77.55	1.15 171.79	1.18 218.53	0.38 138.53	0.24 336.36	0.14 1.30	0.09 24.68	0.06 53.95	Mag Phase
288	7.25	4.35	1.92 10.78	2.42 134.37	1.17 92.03	0.97 180.99	0.94 234.89	0.48 158.73	0.24 16.84	0.08 35.12	0.09 80.40	0.08 101.52	Mag Phase

Table VI. - Continued

(h) Continued

Run 10

$\mu_{\text{Nom.}} = 0.13$

POINT	MEAN	1/2P-P	1P	2P	3P	4P	5P	6P	7P	8P	9P	10P	
289	6.47	3.59	1.83 8.66	1.95 135.24	1.00 90.41	0.83 165.35	0.71 225.31	0.45 137.78	0.17 358.74	0.11 26.14	0.08 76.24	0.09 93.75	Mag Phase

$\mu_{\text{Nom.}} = 0.16$

POINT	MEAN	1/2P-P	1P	2P	3P	4P	5P	6P	7P	8P	9P	10P	
290	6.85	3.76	2.10 13.01	2.21 140.10	1.07 85.67	0.86 169.91	0.61 216.26	0.38 145.55	0.10 290.39	0.16 100.62	0.10 39.53	0.12 102.46	Mag Phase
291	7.43	4.16	2.19 12.04	2.55 131.63	1.18 70.56	0.92 170.62	0.81 214.56	0.28 145.61	0.12 282.81	0.13 74.44	0.11 16.43	0.13 75.45	Mag Phase
292	7.75	4.25	2.13 6.96	2.70 135.16	1.45 74.00	0.83 153.67	0.84 206.62	0.31 121.17	0.11 45.94	0.10 46.32	0.12 339.50	0.10 83.14	Mag Phase
293	7.16	4.10	2.32 18.40	2.29 126.80	0.84 65.33	1.09 174.47	0.62 217.56	0.22 141.60	0.17 325.28	0.08 81.74	0.03 66.78	0.09 112.53	Mag Phase
294	7.44	4.20	2.20 12.59	2.55 132.79	1.18 74.43	0.90 172.06	0.82 217.55	0.28 151.19	0.10 283.64	0.13 82.21	0.09 13.39	0.12 79.74	Mag Phase
295	7.57	4.45	2.02 12.61	2.49 128.02	1.22 76.72	0.97 164.18	0.88 206.50	0.31 147.20	0.14 327.29	0.12 69.46	0.07 11.29	0.11 66.61	Mag Phase
296	7.34	4.09	2.41 10.70	2.46 134.23	1.05 74.50	1.01 165.76	0.74 217.45	0.32 124.30	0.10 270.18	0.13 59.09	0.12 34.19	0.12 79.95	Mag Phase
297	7.44	4.22	2.21 12.47	2.58 133.06	1.19 75.97	0.91 169.27	0.78 218.87	0.28 149.85	0.14 296.19	0.14 88.48	0.10 18.89	0.12 85.15	Mag Phase

Table VI. - Continued

(h) Continued

Run 10

$\mu_{\text{Nom.}} = 0.16$

POINT	MEAN	1/2P-P	1P	2P	3P	4P	5P	6P	7P	8P	9P	10P	
298	8.15	4.72	2.35 13.12	2.89 129.95	1.31 70.70	0.97 179.12	1.05 229.15	0.10 149.70	0.21 293.74	0.15 75.23	0.11 22.63	0.14 94.41	Mag Phase

$\mu_{\text{Nom.}} = 0.20$

POINT	MEAN	1/2P-P	1P	2P	3P	4P	5P	6P	7P	8P	9P	10P	
299	8.51	4.73	3.12 12.37	2.69 120.76	1.33 24.41	0.74 188.91	0.96 229.04	0.04 156.91	0.27 315.07	0.07 187.54	0.09 36.37	0.04 79.40	Mag Phase
300	7.85	4.19	2.91 12.36	2.30 125.41	1.00 29.60	0.71 166.63	0.74 217.33	0.24 156.89	0.24 294.47	0.07 152.02	0.10 24.87	0.05 74.95	Mag Phase
301	8.24	4.91	2.80 10.74	2.75 138.22	1.41 54.38	0.61 175.50	0.80 219.98	0.26 142.40	0.20 345.70	0.06 258.72	0.08 22.52	0.08 135.47	Mag Phase
302	7.57	3.83	3.06 20.31	2.01 124.41	0.78 29.66	0.73 157.36	0.29 238.58	0.29 150.39	0.25 321.55	0.05 67.75	0.10 57.50	0.04 104.63	Mag Phase
303	7.88	4.17	2.93 16.71	2.32 134.19	1.02 42.62	0.73 186.00	0.72 239.80	0.23 180.17	0.23 329.20	0.04 146.29	0.09 68.37	0.06 116.62	Mag Phase
304	7.99	4.01	2.72 15.85	2.44 128.11	1.06 40.74	0.81 189.34	0.82 232.47	0.29 173.68	0.31 339.75	0.06 208.94	0.09 89.07	0.05 123.86	Mag Phase
305	7.78	4.20	3.16 17.19	2.18 140.87	0.85 47.84	0.70 176.30	0.50 254.88	0.33 171.13	0.19 325.34	0.06 137.75	0.15 97.39	0.06 122.51	Mag Phase
306	7.92	4.25	2.95 13.16	2.34 127.98	1.06 32.88	0.67 169.94	0.72 226.76	0.23 154.20	0.23 304.87	0.06 159.01	0.08 41.52	0.05 88.58	Mag Phase

Table VI. - Continued

(h) Continued

Run 10

$\mu_{\text{Nom.}} = 0.20$

POINT	MEAN	1/2P-P	1P	2P	3P	4P	5P	6P	7P	8P	9P	10P	
307	7.18	3.70	2.76 13.61	1.93 131.00	0.73 42.64	0.73 146.99	0.43 206.42	0.36 135.48	0.12 303.42	0.06 144.40	0.10 32.16	0.06 73.13	Mag Phase

$\mu_{\text{Nom.}} = 0.25$

POINT	MEAN	1/2P-P	1P	2P	3P	4P	5P	6P	7P	8P	9P	10P	
308	7.89	4.71	3.89 16.40	1.58 101.09	0.98 322.07	1.23 139.90	0.29 325.60	0.61 138.51	0.09 66.40	0.02 162.66	0.06 49.94	0.10 63.97	Mag Phase
309	8.53	5.48	4.16 16.90	2.14 96.70	1.65 337.31	1.19 168.99	0.44 324.21	0.50 164.41	0.11 25.36	0.07 254.42	0.02 61.61	0.08 77.48	Mag Phase
310	9.01	5.80	4.08 12.14	2.62 108.13	2.08 353.22	1.00 215.13	0.57 296.01	0.45 195.85	0.16 16.70	0.10 331.88	0.05 96.25	0.12 94.84	Mag Phase
311	8.15	5.36	4.23 20.03	1.79 84.54	1.44 317.73	1.25 150.18	0.25 338.98	0.46 149.45	0.09 52.49	0.09 358.80	0.08 60.75	0.07 80.45	Mag Phase
312	8.53	5.69	4.16 14.42	2.17 93.77	1.71 329.06	1.31 162.08	0.49 310.15	0.49 147.42	0.12 10.30	0.04 227.49	0.02 33.61	0.08 64.64	Mag Phase
313	8.63	5.70	3.94 16.21	2.43 91.89	1.89 333.84	1.37 183.11	0.52 307.20	0.58 168.72	0.13 343.57	0.10 326.80	0.12 73.58	0.10 76.70	Mag Phase
314	8.44	5.33	4.39 16.26	1.81 99.39	1.37 332.13	1.16 150.52	0.52 344.39	0.44 141.39	0.13 44.68	0.04 17.06	0.05 117.92	0.10 88.18	Mag Phase
315	8.52	5.59	4.18 16.17	2.15 96.31	1.66 334.17	1.26 167.17	0.47 324.02	0.49 158.18	0.11 23.44	0.04 266.82	0.02 68.90	0.09 80.39	Mag Phase

Table VI. - Continued

(h) Continued

Run 10

 $\mu_{\text{Nom.}} = 0.25$ 

POINT	MEAN	1/2P-P	1P	2P	3P	4P	5P	6P	7P	8P	9P	10P	
316	9.41	6.77	4.46 16.61	2.96 87.16	2.63 330.85	1.64 189.47	0.75 313.38	0.53 172.01	0.05 7.88	0.12 256.26	0.01 212.25	0.08 90.49	Mag Phase

 $\mu_{\text{Nom.}} = 0.30$ 

POINT	MEAN	1/2P-P	1P	2P	3P	4P	5P	6P	7P	8P	9P	10P	
317	10.42	15.43	6.16 18.72	5.78 36.53	7.19 291.82	4.69 169.60	2.24 321.70	1.89 175.10	0.75 243.92	0.33 265.51	0.21 282.60	0.05 108.14	Mag Phase
318	9.74	10.88	5.63 18.05	4.36 52.08	5.21 297.67	3.60 165.05	1.70 328.18	1.17 175.82	0.33 240.05	0.19 301.85	0.09 291.81	0.08 134.27	Mag Phase
319	10.21	12.37	5.61 16.94	4.88 54.82	5.93 304.81	4.00 177.85	1.96 337.26	1.49 181.18	0.44 266.71	0.23 276.21	0.13 305.40	0.10 144.02	Mag Phase
320	9.18	9.79	5.62 17.75	4.03 45.77	4.51 288.03	3.26 146.58	1.23 314.04	0.89 144.65	0.28 208.54	0.20 289.68	0.04 253.93	0.06 118.37	Mag Phase
321	9.75	10.69	5.64 17.79	4.33 52.67	5.15 297.76	3.53 164.39	1.67 325.01	1.17 174.69	0.30 231.70	0.16 286.28	0.06 308.66	0.06 135.66	Mag Phase
322	9.89	11.99	5.44 17.85	4.77 47.70	5.70 294.37	3.87 163.80	1.84 325.45	1.39 168.87	0.44 233.58	0.19 257.14	0.11 290.66	0.06 113.36	Mag Phase
323	9.54	9.69	5.79 16.75	3.77 51.23	4.36 293.89	3.06 153.51	1.36 318.36	0.96 153.11	0.21 225.27	0.19 296.36	0.06 283.13	0.07 134.76	Mag Phase
324	9.75	10.80	5.66 18.96	4.33 53.81	5.17 300.13	3.59 167.55	1.71 331.27	1.21 179.84	0.34 240.83	0.20 293.83	0.06 286.74	0.10 129.41	Mag Phase

Table VI. - Continued

(h) Continued

Run 10

$\mu_{Nom.} = 0.30$

POINT	MEAN	1/2P-P	1P	2P	3P	4P	5P	6P	7P	8P	9P	10P	
325	8.82	8.34	5.27 17.41	2.96 58.74	3.30 297.71	2.76 149.52	1.25 326.29	0.80 152.08	0.14 202.01	0.12 351.90	0.01 81.88	0.05 134.43	Mag Phase

$\mu_{Nom.} = 0.325$

POINT	MEAN	1/2P-P	1P	2P	3P	4P	5P	6P	7P	8P	9P	10P	
326	9.36	13.04	6.00 18.62	5.06 44.12	6.05 289.56	4.44 154.16	1.72 321.35	1.41 150.65	0.37 219.54	0.19 275.42	0.11 261.80	0.09 145.17	Mag Phase
327	10.06	16.68	6.56 20.08	6.20 33.19	7.70 287.58	5.14 161.19	2.47 321.82	1.99 162.22	0.86 238.51	0.27 270.13	0.16 261.06	0.05 65.90	Mag Phase
328	9.62	21.57	7.96 27.06	6.98 18.30	8.23 289.08	7.01 179.09	3.33 350.72	6.51 172.02	2.77 253.52	0.32 225.88	0.53 286.49	0.18 51.73	Mag Phase

$\mu_{Nom.} = 0.275$

POINT	MEAN	1/2P-P	1P	2P	3P	4P	5P	6P	7P	8P	9P	10P	
329	10.19	9.30	5.25 16.75	3.93 62.30	4.31 306.00	2.89 172.49	1.36 323.81	1.06 167.49	0.18 256.42	0.27 278.78	0.04 61.57	0.07 109.17	Mag Phase
330	9.21	7.35	4.92 15.75	2.73 73.18	2.58 310.66	2.04 153.90	0.97 322.30	0.63 145.28	0.06 58.04	0.10 282.06	0.02 358.57	0.07 94.20	Mag Phase
331	9.88	8.36	4.80 15.17	3.41 82.55	3.39 324.51	2.19 184.18	0.93 348.17	0.84 168.74	0.09 35.40	0.21 285.73	0.04 51.44	0.11 98.81	Mag Phase
332	8.68	6.79	4.99 19.49	2.21 65.75	2.05 305.77	1.69 140.12	0.64 317.51	0.44 138.23	0.06 81.33	0.16 358.55	0.05 60.56	0.07 109.45	Mag Phase

Table VI. - Continued

(h) Continued

Run 10

 $\mu_{\text{Nom.}} = 0.275$ 

POINT	MEAN	1/2P-P	1P	2P	3P	4P	5P	6P	7P	8P	9P	10P	
333	9.24	7.35	4.93 16.08	2.73 75.37	2.59 314.45	1.98 157.67	0.96 327.39	0.67 148.92	0.04 47.72	0.07 283.69	0.03 337.37	0.06 100.55	Mag Phase
334	9.46	7.58	4.70 16.28	3.28 75.00	3.03 317.54	1.98 168.73	0.90 322.50	0.66 167.42	0.11 323.71	0.23 316.52	0.15 29.29	0.08 82.27	Mag Phase
335	9.05	6.79	5.22 17.85	2.09 77.25	2.10 317.19	1.67 152.10	0.82 340.84	0.51 133.66	0.15 85.14	0.10 4.47	0.03 218.75	0.10 119.71	Mag Phase
336	9.24	7.34	4.97 17.67	2.67 77.09	2.55 316.29	2.02 160.77	1.05 335.40	0.60 156.15	0.07 62.59	0.06 261.88	0.03 350.34	0.06 107.05	Mag Phase
337	8.46	5.90	4.74 15.83	1.69 78.00	1.49 306.17	1.65 133.72	0.72 323.83	0.59 131.06	0.15 86.54	0.06 340.51	0.01 320.95	0.07 93.29	Mag Phase

 $\mu_{\text{Nom.}} = 0.225$ 

POINT	MEAN	1/2P-P	1P	2P	3P	4P	5P	6P	7P	8P	9P	10P	
338	9.26	5.48	3.95 15.27	2.71 110.58	1.64 5.72	0.90 175.79	0.38 295.13	0.51 141.55	0.11 5.33	0.16 236.74	0.03 357.71	0.11 57.87	Mag Phase
339	8.48	4.56	3.69 15.82	2.05 119.83	1.07 15.67	0.75 151.50	0.27 314.67	0.60 136.21	0.13 18.23	0.09 217.50	0.03 359.61	0.09 53.09	Mag Phase
340	8.93	4.83	3.60 8.93	2.68 122.46	1.56 28.82	0.36 187.07	0.25 224.71	0.53 108.97	0.16 48.05	0.09 249.95	0.04 357.31	0.07 59.38	Mag Phase
341	8.14	4.48	3.78 19.23	1.75 105.92	1.02 342.51	0.96 144.60	0.24 335.39	0.49 137.49	0.10 341.29	0.05 151.29	0.07 65.22	0.07 72.15	Mag Phase

Table VI. - Continued

(h) Concluded

Run 10

$\mu_{Nom.} = 0.225$

POINT	MEAN	1/2P-P	1P	2P	3P	4P	5P	6P	7P	8P	9P	10P	
342	8.51	4.85	3.71 14.08	2.14 116.81	1.18 6.97	0.81 153.06	0.33 322.17	0.57 125.88	0.15 11.73	0.11 193.36	0.00 188.78	0.09 40.81	Mag Phase
343	8.66	5.05	3.49 13.29	2.52 112.35	1.37 9.04	0.86 160.34	0.27 289.44	0.62 124.74	0.11 20.39	0.07 243.53	0.09 70.76	0.10 50.41	Mag Phase
344	8.33	4.57	3.93 13.89	1.77 123.18	0.93 6.31	0.66 135.21	0.46 316.76	0.50 127.75	0.14 357.47	0.08 154.55	0.06 93.16	0.08 67.68	Mag Phase
345	8.56	4.85	3.73 13.60	2.12 115.99	1.17 7.12	0.81 147.14	0.35 310.48	0.59 120.98	0.13 13.43	0.10 197.84	0.01 25.10	0.09 41.19	Mag Phase
346	7.80	4.21	3.44 14.90	1.65 125.51	0.63 14.49	0.88 129.11	0.21 342.13	0.65 125.12	0.12 71.44	0.11 165.59	0.04 107.98	0.07 38.30	Mag Phase



Table VI. - Continued

(i) Blade flapwise bending moment, in-lbs, 63.00 percent radius

Run 10

$\mu_{Nom.} = 0.08$

POINT	MEAN	1/2P-P	1P	2P	3P	4P	5P	6P	7P	8P	9P	10P	
281	23.32	22.54	15.48 272.20	3.81 156.44	8.53 298.96	1.69 15.63	4.86 157.07	2.05 87.46	0.16 240.83	0.22 222.97	0.37 300.29	0.09 70.56	Mag Phase
282	21.41	21.62	13.84 274.12	4.57 156.96	8.06 296.50	1.48 20.85	5.67 157.56	1.98 91.25	0.38 281.81	0.24 228.82	0.17 281.18	0.18 73.63	Mag Phase
283	19.94	19.71	12.24 276.24	4.52 162.12	7.48 298.39	1.24 25.73	5.33 163.37	1.75 98.18	0.38 289.72	0.38 233.19	0.17 283.99	0.27 91.70	Mag Phase

$\mu_{Nom.} = 0.11$

POINT	MEAN	1/2P-P	1P	2P	3P	4P	5P	6P	7P	8P	9P	10P	
284	17.71	16.40	8.55 281.30	5.67 195.54	6.97 288.92	1.95 9.42	4.84 164.48	1.54 98.39	0.30 295.45	0.43 195.41	0.27 198.39	0.41 85.57	Mag Phase
285	18.58	18.28	9.57 279.17	6.11 191.76	7.70 285.49	2.40 9.03	5.34 160.00	1.80 91.65	0.33 297.19	0.44 189.71	0.25 211.18	0.45 66.35	Mag Phase
286	19.57	20.36	10.84 281.26	6.70 195.32	8.62 294.67	2.86 22.53	6.21 172.85	2.08 107.77	0.34 324.61	0.45 223.76	0.32 261.59	0.40 81.88	Mag Phase

$\mu_{Nom.} = 0.13$

POINT	MEAN	1/2P-P	1P	2P	3P	4P	5P	6P	7P	8P	9P	10P	
287	18.53	18.65	8.60 282.72	7.77 199.13	8.91 287.58	2.76 9.80	4.94 180.98	1.45 82.27	0.46 315.67	0.45 244.88	0.25 248.76	0.60 108.36	Mag Phase
288	17.82	16.85	7.68 286.94	7.18 207.37	8.25 299.21	2.27 22.03	4.43 199.29	1.27 103.35	0.45 347.30	0.46 266.70	0.26 282.51	0.51 143.91	Mag Phase

Table VI. - Continued

(i) Continued

Run 10

 $\mu_{\text{Nom.}} = 0.13$ 

POINT	MEAN	1/2P-P	1P	2P	3P	4P	5P	6P	7P	8P	9P	10P	
289	17.02	14.54	6.60 286.87	6.46 204.62	7.30 293.50	1.74 6.98	3.55 187.77	1.04 91.39	0.41 317.58	0.40 242.19	0.19 242.14	0.47 126.10	Mag Phase

 $\mu_{\text{Nom.}} = 0.16$ 

POINT	MEAN	1/2P-P	1P	2P	3P	4P	5P	6P	7P	8P	9P	10P	
290	17.49	13.75	4.80 294.95	6.92 204.86	7.79 299.62	1.82 358.70	3.64 196.55	0.93 106.18	0.53 339.73	0.26 190.68	0.15 234.73	0.14 97.44	Mag Phase
291	18.14	15.24	5.47 291.88	7.40 200.25	8.55 292.98	2.03 1.19	4.16 186.70	0.97 95.78	0.59 322.97	0.32 191.88	0.23 223.60	0.16 81.94	Mag Phase
292	18.03	15.57	6.13 285.54	7.38 200.92	8.97 295.09	1.86 359.49	4.61 186.22	0.95 100.31	0.49 342.68	0.30 254.35	0.30 269.67	0.06 356.19	Mag Phase
293	18.24	14.47	4.82 297.80	6.72 196.86	7.49 295.09	2.42 0.91	3.77 176.32	0.98 100.75	0.56 317.37	0.30 177.76	0.18 182.52	0.15 69.41	Mag Phase
294	18.11	15.22	5.41 293.06	7.42 201.38	8.58 294.54	2.04 3.45	4.09 190.99	0.99 99.06	0.58 325.00	0.30 192.99	0.21 217.86	0.19 86.04	Mag Phase
295	18.02	14.78	5.19 284.55	6.97 203.45	8.55 294.76	2.13 1.67	3.78 185.64	1.00 99.81	0.48 333.08	0.12 211.64	0.27 238.52	0.10 10.72	Mag Phase
296	18.04	16.05	5.59 298.43	7.70 197.39	8.13 291.18	2.19 355.05	4.36 178.76	1.07 88.91	0.60 315.48	0.31 187.91	0.19 206.74	0.15 70.42	Mag Phase
297	18.05	15.20	5.17 293.57	7.40 200.10	8.48 294.92	2.08 2.28	4.00 189.68	0.96 96.35	0.61 332.65	0.28 190.73	0.24 231.10	0.14 82.27	Mag Phase

Table VI. - Continued

(i) Continued

Run 10

$\mu_{\text{Nom.}} = 0.16$

POINT	MEAN	1/2P-P	1P	2P	3P	4P	5P	6P	7P	8P	9P	10P	
298	18.78	16.98	6.04 292.82	8.04 201.70	9.28 296.81	2.42 11.37	4.67 194.48	1.06 104.15	0.65 336.56	0.28 202.20	0.27 244.35	0.21 89.92	Mag Phase

$\mu_{\text{Nom.}} = 0.20$

POINT	MEAN	1/2P-P	1P	2P	3P	4P	5P	6P	7P	8P	9P	10P	
299	19.53	17.88	3.98 313.13	8.54 200.63	8.73 290.52	1.97 354.42	3.85 188.73	1.04 129.08	0.01 4.31	0.67 235.81	0.14 186.25	0.66 101.37	Mag Phase
300	18.79	16.15	3.33 319.63	7.89 200.05	7.99 290.33	1.87 339.26	3.12 189.53	0.97 123.97	0.04 354.37	0.56 224.15	0.14 164.64	0.62 93.68	Mag Phase
301	18.61	17.99	3.81 311.29	8.94 209.02	9.17 303.99	1.58 356.99	3.33 204.59	0.91 149.90	0.03 297.01	0.51 252.09	0.04 60.21	0.57 131.21	Mag Phase
302	18.82	13.78	2.94 334.03	6.80 199.13	6.77 293.71	1.70 344.60	2.20 195.84	0.88 123.10	0.13 17.31	0.39 238.99	0.17 196.67	0.43 100.50	Mag Phase
303	18.79	16.15	3.32 322.90	7.91 208.76	8.09 303.06	1.79 357.93	3.08 210.77	0.92 150.36	0.08 40.11	0.49 259.57	0.15 208.62	0.60 136.36	Mag Phase
304	18.69	16.32	2.89 311.34	7.81 209.63	8.13 302.06	1.81 0.10	3.17 207.15	1.04 151.86	0.05 282.44	0.54 253.93	0.14 197.06	0.60 132.34	Mag Phase
305	18.83	15.58	3.84 330.63	7.77 208.56	7.63 305.24	1.81 0.26	2.87 207.31	0.94 140.55	0.10 33.29	0.51 261.11	0.20 202.34	0.60 143.07	Mag Phase
306	18.82	16.26	3.36 322.26	7.97 201.91	8.08 292.68	1.81 342.95	3.05 195.60	0.94 132.67	0.06 358.74	0.53 237.41	0.14 176.80	0.65 104.41	Mag Phase

Table VI. - Continued

(i) Continued

Run 10

 $\mu_{\text{Nom.}} = 0.20$ 

POINT	MEAN	1/2P-P	1P	2P	3P	4P	5P	6P	7P	8P	9P	10P	
307	18.12	14.40	2.77 329.45	7.09 200.33	7.30 292.62	1.74 327.36	2.56 194.51	0.74 117.40	0.07 15.77	0.50 224.15	0.23 130.68	0.54 88.74	Mag Phase

 $\mu_{\text{Nom.}} = 0.25$ 

POINT	MEAN	1/2P-P	1P	2P	3P	4P	5P	6P	7P	8P	9P	10P	
308	19.35	13.30	3.90 34.68	6.42 213.62	6.24 299.49	1.06 309.65	0.67 163.57	0.54 170.28	0.57 132.95	0.09 119.82	0.53 269.01	0.42 199.17	Mag Phase
309	20.07	14.84	3.90 35.86	7.04 215.98	6.69 299.08	1.03 338.57	0.83 173.19	0.57 186.64	0.67 158.35	0.11 175.54	0.61 293.41	0.49 215.76	Mag Phase
310	20.00	17.30	3.40 28.34	8.46 214.67	7.80 294.86	1.01 31.54	1.63 208.30	0.82 190.67	0.91 161.90	0.15 160.63	0.63 293.50	0.49 206.66	Mag Phase
311	20.10	12.68	4.17 34.48	5.89 210.29	5.69 293.95	1.18 317.29	0.59 131.80	0.58 167.20	0.49 139.10	0.07 202.40	0.36 277.39	0.30 204.25	Mag Phase
312	20.05	15.09	3.94 33.72	7.19 211.07	6.68 292.37	1.19 337.30	1.11 164.59	0.57 176.96	0.57 148.34	0.09 143.61	0.65 273.57	0.48 194.77	Mag Phase
313	19.94	14.64	3.46 43.86	6.87 217.44	6.37 296.47	1.07 359.73	1.15 181.02	0.68 186.06	0.73 157.34	0.13 112.39	0.54 297.73	0.46 210.42	Mag Phase
314	20.05	14.63	4.32 29.33	6.98 211.99	6.66 298.75	0.98 334.96	0.99 152.51	0.44 171.34	0.53 148.76	0.08 191.26	0.48 278.17	0.39 204.75	Mag Phase
315	20.04	14.81	3.99 35.89	7.05 215.55	6.63 297.73	1.08 342.37	1.07 182.81	0.54 184.30	0.61 152.76	0.09 170.63	0.58 286.37	0.48 210.86	Mag Phase

Table VI. - Continued

(i) Continued

Run 10

$\mu_{\text{Nom.}} = 0.25$

POINT	MEAN	1/2P-P	1P	2P	3P	4P	5P	6P	7P	8P	9P	10P	
316	20.85	15.77	3.82 32.39	7.36 213.99	6.73 288.31	1.44 4.67	1.81 184.85	0.65 185.01	0.73 153.66	0.15 184.32	0.66 285.91	0.52 209.30	Mag Phase

$\mu_{\text{Nom.}} = 0.30$

POINT	MEAN	1/2P-P	1P	2P	3P	4P	5P	6P	7P	8P	9P	10P	
317	24.11	14.55	5.84 31.46	3.80 239.97	5.39 193.59	4.54 337.11	2.52 98.64	0.80 202.02	0.59 130.99	0.17 115.74	0.21 323.18	0.50 246.67	Mag Phase
318	23.06	11.98	6.17 39.87	4.29 226.51	4.07 232.94	3.33 327.80	1.56 107.74	0.50 217.64	0.48 146.11	0.19 116.05	0.25 336.26	0.50 247.86	Mag Phase
319	22.79	13.34	5.63 34.21	5.31 235.89	4.91 226.65	3.61 342.41	1.50 141.59	0.63 226.47	0.48 149.27	0.38 139.49	0.35 333.76	0.66 244.93	Mag Phase
320	23.27	11.73	6.60 37.29	3.86 210.80	3.10 229.10	3.36 310.01	1.78 74.03	0.48 196.64	0.38 141.44	0.18 120.87	0.11 310.24	0.30 235.05	Mag Phase
321	23.05	11.77	6.14 39.31	4.35 225.43	4.04 236.26	3.31 327.72	1.41 109.42	0.48 218.13	0.55 146.91	0.20 107.60	0.20 336.01	0.43 242.39	Mag Phase
322	22.89	11.48	5.59 41.35	4.37 234.33	3.82 220.10	3.52 330.63	1.42 106.45	0.53 205.01	0.56 125.19	0.25 124.06	0.31 335.22	0.53 237.33	Mag Phase
323	23.08	11.73	6.49 35.29	4.54 215.86	3.79 244.97	2.98 316.91	1.38 96.63	0.29 219.29	0.43 153.99	0.18 68.96	0.21 335.88	0.35 242.68	Mag Phase
324	23.07	11.78	6.13 39.28	4.53 228.06	3.92 239.58	3.38 331.62	1.63 121.50	0.46 225.15	0.49 154.56	0.14 117.82	0.19 335.25	0.48 257.71	Mag Phase

Table VI. - Continued

(i) Continued

Run 10

$\mu_{Nom.} = 0.30$

POINT	MEAN	1/2P-P	1P	2P	3P	4P	5P	6P	7P	8P	9P	10P	
325	22.13	10.84	6.27 42.01	4.73 227.73	3.79 281.07	2.71 312.71	1.01 105.62	0.44 217.24	0.53 164.68	0.25 123.11	0.22 331.75	0.44 249.68	Mag Phase

$\mu_{Nom.} = 0.325$

POINT	MEAN	1/2P-P	1P	2P	3P	4P	5P	6P	7P	8P	9P	10P	
326	24.18	13.24	7.35 40.35	2.68 233.02	3.84 196.46	4.05 324.67	2.42 82.35	0.70 217.68	0.37 146.54	0.08 22.29	0.15 356.80	0.25 276.78	Mag Phase
327	25.24	16.18	6.92 35.92	2.51 254.00	6.13 178.65	5.14 331.81	3.69 79.97	1.01 206.82	0.45 121.21	0.24 6.84	0.26 355.49	0.30 275.75	Mag Phase
328	26.12	20.82	6.47 28.61	3.78 287.21	7.92 175.99	7.16 344.52	6.01 71.81	2.10 196.66	0.69 124.49	0.02 345.42	0.37 328.77	0.47 254.44	Mag Phase

$\mu_{Nom.} = 0.275$

POINT	MEAN	1/2P-P	1P	2P	3P	4P	5P	6P	7P	8P	9P	10P	
329	21.80	13.39	4.73 30.93	6.19 221.76	5.38 260.23	2.43 344.49	1.18 132.21	0.32 166.09	0.62 125.77	0.27 116.11	0.40 293.19	0.44 213.27	Mag Phase
330	21.03	13.71	5.08 33.32	6.56 222.47	5.80 288.03	2.04 325.55	0.60 118.86	0.13 183.86	0.57 140.53	0.26 123.73	0.48 300.90	0.39 227.47	Mag Phase
331	20.75	15.06	4.35 32.57	7.29 227.84	6.35 279.83	1.87 7.97	0.79 149.14	0.12 152.21	0.86 130.57	0.38 134.03	0.61 298.58	0.55 245.42	Mag Phase
332	21.28	11.93	5.33 38.91	5.46 218.05	5.20 293.03	1.94 303.96	0.86 67.29	0.30 184.50	0.48 153.32	0.15 125.29	0.24 307.63	0.33 243.34	Mag Phase

Table VI. - Continued

(i) Continued

Run 10

 $\mu_{\text{Nom.}} = 0.275$ 

POINT	MEAN	1/2P-P	1P	2P	3P	4P	5P	6P	7P	8P	9P	10P	
333	20.99	13.65	4.98 34.92	6.56 223.87	5.80 287.98	1.86 331.77	0.67 129.25	0.15 173.72	0.56 146.33	0.32 120.22	0.46 307.22	0.40 231.77	Mag Phase
334	20.84	13.57	4.45 40.32	6.56 225.18	5.75 281.74	1.85 335.68	0.60 92.99	0.24 191.19	0.61 128.23	0.34 100.38	0.51 319.37	0.43 226.77	Mag Phase
335	21.04	13.44	5.33 33.76	6.55 224.13	5.90 301.30	1.55 326.74	1.08 112.57	0.08 206.19	0.48 153.83	0.14 100.54	0.35 320.62	0.29 259.00	Mag Phase
336	20.98	13.72	4.95 36.29	6.55 227.80	5.86 296.26	2.06 334.00	0.70 132.19	0.21 193.21	0.58 154.69	0.31 147.24	0.45 319.50	0.39 252.85	Mag Phase
337	20.32	12.58	4.98 36.21	6.31 226.38	6.01 303.32	1.95 297.31	0.34 37.27	0.17 206.33	0.48 134.63	0.19 111.43	0.44 312.88	0.44 235.21	Mag Phase

 $\mu_{\text{Nom.}} = 0.225$ 

POINT	MEAN	1/2P-P	1P	2P	3P	4P	5P	6P	7P	8P	9P	10P	
338	20.02	17.08	2.86 354.64	8.16 210.58	8.41 302.42	2.00 11.63	1.83 227.99	0.77 163.07	0.44 93.36	0.32 295.34	0.62 270.35	0.46 155.44	Mag Phase
339	19.22	14.99	2.84 1.51	7.42 213.61	7.85 308.59	1.48 357.92	1.71 251.71	0.71 165.46	0.35 92.73	0.27 301.20	0.51 265.14	0.43 168.68	Mag Phase
340	19.05	18.11	2.80 340.76	8.83 209.41	9.07 298.84	1.59 10.69	2.87 225.42	0.59 165.37	0.32 109.59	0.70 288.36	0.52 254.58	0.40 129.83	Mag Phase
341	19.35	13.85	3.18 15.74	6.74 207.11	6.59 299.79	1.54 344.12	0.64 198.90	0.76 145.11	0.34 104.78	0.03 227.59	0.25 235.12	0.38 131.92	Mag Phase

Table VI. - Continued

(i) Concluded

Run 10

$\mu_{Nom.} = 0.225$

POINT	MEAN	1/2P-P	1P	2P	3P	4P	5P	6P	7P	8P	9P	10P	
342	19.19	15.16	2.93 359.76	7.69 211.41	7.70 302.49	1.51 353.73	1.95 231.60	0.71 145.92	0.37 79.94	0.19 298.87	0.49 254.35	0.35 152.07	Mag Phase
343	19.10	15.83	2.09 0.70	7.61 211.51	7.97 302.08	1.79 354.31	1.93 227.36	0.77 154.63	0.46 87.60	0.35 303.27	0.39 246.63	0.39 142.22	Mag Phase
344	19.17	15.00	3.47 2.31	7.39 209.35	7.58 304.96	1.38 354.32	1.61 212.96	0.54 144.34	0.25 93.82	0.15 315.53	0.39 253.85	0.35 128.79	Mag Phase
345	19.25	15.37	2.91 1.01	7.67 210.57	7.83 301.93	1.57 352.61	1.97 233.25	0.73 149.90	0.42 80.88	0.27 305.06	0.48 248.43	0.42 148.52	Mag Phase
346	18.50	13.66	2.91 8.43	6.89 211.98	7.21 306.36	1.44 330.79	1.59 240.27	0.65 155.64	0.39 86.29	0.22 284.20	0.42 239.59	0.32 162.35	Mag Phase



Table VI. - Continued

(j) Blade flapwise bending moment, in-lbs, 74.00 percent radius

Run 10

$\mu_{Nom.} = 0.08$

POINT	MEAN	1/2P-P	1P	2P	3P	4P	5P	6P	7P	8P	9P	10P	
281	13.93	20.41	13.94 274.63	5.24 231.85	5.15 308.91	4.73 47.56	6.48 168.79	1.16 123.13	0.33 292.50	3.31 286.87	0.55 288.03	0.22 47.71	Mag Phase
282	12.58	20.23	12.69 275.41	4.44 220.98	4.77 302.19	4.42 51.17	7.36 167.76	1.10 132.62	0.10 27.85	3.50 298.91	0.33 268.34	0.31 59.57	Mag Phase
283	11.50	18.40	11.36 276.99	4.05 216.14	4.53 302.52	3.82 54.53	6.98 173.17	1.02 150.96	0.17 52.72	3.55 322.02	0.36 264.79	0.35 87.14	Mag Phase

$\mu_{Nom.} = 0.11$

POINT	MEAN	1/2P-P	1P	2P	3P	4P	5P	6P	7P	8P	9P	10P	
284	9.00	17.48	8.11 282.22	5.77 222.11	5.28 286.25	3.67 26.63	6.15 168.19	0.62 159.79	0.47 208.15	4.12 301.30	0.35 274.72	0.29 71.41	Mag Phase
285	9.55	19.36	9.02 280.59	6.32 219.64	5.65 282.41	4.49 27.19	6.78 163.73	0.73 145.32	0.52 200.52	4.89 289.84	0.48 262.12	0.29 67.02	Mag Phase
286	10.13	21.47	10.32 282.62	6.99 224.45	6.29 291.52	5.32 40.93	7.71 174.71	0.83 172.37	0.52 210.35	5.30 312.87	0.53 281.20	0.46 103.97	Mag Phase

$\mu_{Nom.} = 0.13$

POINT	MEAN	1/2P-P	1P	2P	3P	4P	5P	6P	7P	8P	9P	10P	
287	8.85	20.02	8.23 283.91	7.71 221.29	6.96 283.50	4.88 25.80	6.27 182.66	0.65 150.08	0.83 205.39	2.93 306.30	0.61 228.39	0.30 83.75	Mag Phase
288	8.43	18.21	7.31 288.11	7.05 228.55	6.63 295.64	3.98 38.01	5.68 200.50	0.55 172.17	0.83 229.93	2.49 343.56	0.51 256.48	0.28 120.74	Mag Phase

Table VI. - Continued

(j) Continued

Run 10

$\mu_{\text{Nom.}} = 0.13$

POINT	MEAN	1/2P-P	1P	2P	3P	4P	5P	6P	7P	8P	9P	10P	
289	8.06	15.75	6.18 287.62	6.27 224.34	5.96 291.54	3.11 25.90	4.64 188.31	0.42 152.40	0.65 219.64	2.14 329.19	0.42 238.08	0.22 94.84	Mag Phase

$\mu_{\text{Nom.}} = 0.16$

POINT	MEAN	1/2P-P	1P	2P	3P	4P	5P	6P	7P	8P	9P	10P	
290	7.93	17.05	4.49 296.46	6.89 227.11	6.58 297.83	2.89 14.89	4.46 199.54	0.52 144.66	0.42 276.48	2.97 320.55	0.26 259.52	0.28 122.77	Mag Phase
291	8.15	18.33	5.23 293.77	7.42 223.39	6.99 290.64	3.34 15.42	5.13 190.53	0.53 136.52	0.35 273.29	3.31 309.34	0.21 243.88	0.36 112.42	Mag Phase
292	7.85	18.23	5.46 289.21	7.44 224.50	7.62 293.52	3.16 13.97	5.87 186.77	0.57 134.54	0.38 282.44	1.68 312.37	0.19 257.83	0.32 112.18	Mag Phase
293	8.35	16.20	4.90 296.28	6.48 220.57	5.99 292.26	3.52 12.84	4.34 178.48	0.53 144.95	0.10 254.73	3.42 310.08	0.18 231.58	0.44 106.97	Mag Phase
294	8.10	18.42	5.14 293.49	7.36 224.21	7.02 292.72	3.34 17.50	4.98 194.29	0.53 140.16	0.43 277.69	3.32 310.36	0.22 253.06	0.35 116.05	Mag Phase
295	7.96	18.49	4.87 286.16	7.12 227.21	7.26 294.15	3.33 13.71	4.67 187.34	0.65 126.32	0.57 286.66	2.71 299.16	0.15 285.43	0.33 106.66	Mag Phase
296	8.26	17.56	5.53 296.94	7.50 220.20	6.49 288.06	3.53 10.59	5.23 182.35	0.56 127.28	0.19 224.67	3.28 301.68	0.23 233.83	0.40 106.35	Mag Phase
297	8.12	18.24	5.16 294.14	7.36 224.05	6.98 292.31	3.39 15.48	4.89 193.53	0.53 142.63	0.42 272.97	3.15 311.31	0.19 252.11	0.36 110.95	Mag Phase

Table VI. - Continued

(j) Continued

Run 10

 $\mu_{\text{Nom.}} = 0.16$ 

POINT	MEAN	1/2P-P	1P	2P	3P	4P	5P	6P	7P	8P	9P	10P	
298	8.41	20.16	6.01 294.05	8.08 226.16	7.52 294.33	4.03 24.13	5.58 196.48	0.48 153.29	0.41 290.73	3.62 317.19	0.18 274.01	0.42 130.09	Mag Phase

 $\mu_{\text{Nom.}} = 0.20$ 

POINT	MEAN	1/2P-P	1P	2P	3P	4P	5P	6P	7P	8P	9P	10P	
299	7.86	18.37	3.35 313.95	8.72 223.82	7.70 285.27	3.04 11.32	5.27 190.15	0.45 30.66	0.32 69.29	3.16 358.68	0.35 286.59	0.25 162.01	Mag Phase
300	7.77	16.41	2.78 320.08	7.94 222.52	7.11 286.00	2.77 359.78	4.34 190.23	0.38 32.77	0.34 64.89	2.86 352.35	0.34 268.90	0.24 166.46	Mag Phase
301	7.46	18.18	3.38 317.39	8.89 230.78	8.12 298.51	2.88 19.92	4.47 209.63	0.22 84.57	0.52 103.36	3.05 21.60	0.46 308.39	0.28 217.81	Mag Phase
302	7.90	14.04	2.18 330.85	6.77 222.21	5.97 288.41	2.18 357.83	3.02 190.69	0.38 61.71	0.51 149.19	2.30 351.17	0.21 311.91	0.14 106.71	Mag Phase
303	7.71	16.44	2.83 324.36	7.88 231.29	7.18 298.31	2.68 17.05	4.25 211.16	0.47 61.18	0.23 90.58	2.73 20.66	0.36 308.26	0.27 206.40	Mag Phase
304	7.56	17.11	2.56 314.86	8.08 232.44	7.21 297.71	2.85 19.63	4.43 208.73	0.31 79.31	0.37 110.33	3.11 20.76	0.40 316.81	0.28 199.48	Mag Phase
305	7.85	15.70	2.96 330.04	7.66 229.61	6.64 299.64	2.52 17.89	3.98 208.65	0.70 74.61	0.31 109.61	2.52 20.70	0.25 325.92	0.15 180.49	Mag Phase
306	7.75	16.29	2.80 322.51	7.89 224.10	7.23 288.03	2.67 2.19	4.11 196.33	0.44 37.86	0.29 86.94	2.83 358.48	0.39 294.17	0.21 170.05	Mag Phase

Table VI. - Continued

(j) Continued

Run 10

$\mu_{\text{Nom.}} = 0.20$

POINT	MEAN	1/2P-P	1P	2P	3P	4P	5P	6P	7P	8P	9P	10P	
307	7.65	14.30	2.23 331.08	6.95 221.09	6.46 288.92	2.31 347.20	3.52 194.45	0.33 57.67	0.14 97.71	2.48 357.47	0.27 288.34	0.22 142.80	Mag Phase

$\mu_{\text{Nom.}} = 0.25$

POINT	MEAN	1/2P-P	1P	2P	3P	4P	5P	6P	7P	8P	9P	10P	
308	8.26	11.99	2.03 34.56	5.89 229.98	5.79 286.58	1.88 336.95	1.08 159.46	0.63 100.33	0.60 256.34	1.28 357.75	0.20 320.34	0.13 336.37	Mag Phase
309	8.40	13.35	1.93 35.27	6.54 233.73	6.28 285.02	2.20 6.76	1.42 166.16	0.63 116.02	0.61 267.39	1.67 14.05	0.23 330.07	0.16 351.36	Mag Phase
310	8.10	16.66	1.76 29.33	7.65 233.42	7.66 279.62	2.95 35.48	2.49 199.43	0.85 136.18	0.84 289.68	1.66 354.68	0.37 345.20	0.27 346.63	Mag Phase
311	8.73	10.85	2.01 34.37	5.44 228.38	5.19 280.64	1.91 341.87	1.09 129.46	0.81 104.31	0.50 273.64	1.21 15.02	0.21 307.85	0.09 331.87	Mag Phase
312	8.42	13.88	2.03 30.07	6.70 229.38	6.27 278.68	2.51 358.89	1.71 157.52	0.60 106.71	0.61 242.29	1.60 353.10	0.19 340.10	0.19 348.89	Mag Phase
313	8.24	14.25	1.76 45.31	6.62 236.47	6.02 281.88	2.73 16.75	1.85 172.02	0.87 117.78	0.71 268.45	1.84 352.76	0.44 314.68	0.18 351.11	Mag Phase
314	8.54	12.91	2.19 25.15	6.28 229.08	6.15 285.70	2.00 0.68	1.61 151.35	0.61 88.86	0.44 262.02	1.32 13.87	0.22 350.89	0.13 352.14	Mag Phase
315	8.43	13.47	2.02 33.94	6.60 233.40	6.21 283.45	2.31 6.38	1.66 175.76	0.59 116.19	0.57 261.28	1.56 8.61	0.23 332.52	0.16 356.57	Mag Phase

Table VI. - Continued

(j) Continued

Run 10

 $\mu_{\text{Nom.}} = 0.25$ 

POINT	MEAN	1/2P-P	1P	2P	3P	4P	5P	6P	7P	8P	9P	10P	
316	8.61	14.95	1.83 25.62	7.17 233.90	6.50 272.23	3.28 18.91	2.79 177.09	0.67 123.11	0.70 266.04	1.93 6.44	0.28 340.49	0.22 347.97	Mag Phase

 $\mu_{\text{Nom.}} = 0.30$ 

POINT	MEAN	1/2P-P	1P	2P	3P	4P	5P	6P	7P	8P	9P	10P	
317	11.03	15.08	1.81 10.23	4.98 248.80	6.65 181.00	6.93 348.09	2.74 100.97	1.58 117.42	1.47 248.49	1.09 58.94	0.33 350.36	0.18 233.88	Mag Phase
318	10.64	11.71	2.36 37.34	4.79 242.95	4.74 212.91	4.68 341.44	1.61 116.33	1.23 124.22	1.16 265.40	1.29 70.93	0.19 323.14	0.12 261.64	Mag Phase
319	10.21	14.31	2.02 23.44	6.00 249.68	5.96 210.57	5.52 356.49	1.59 158.91	1.59 119.42	1.56 277.45	1.98 46.62	0.31 341.16	0.13 294.40	Mag Phase
320	11.19	11.59	2.88 37.90	4.15 228.70	3.54 204.96	4.49 321.94	1.96 74.47	1.09 110.27	0.82 259.89	0.99 55.63	0.16 304.93	0.12 231.13	Mag Phase
321	10.64	11.57	2.39 37.78	4.82 241.93	4.60 216.44	4.67 340.23	1.47 119.01	1.14 123.96	1.00 261.51	1.09 87.17	0.11 332.33	0.10 259.69	Mag Phase
322	10.45	12.41	2.03 39.01	5.10 248.02	4.71 201.75	5.22 342.44	1.32 120.62	1.42 110.52	1.25 259.98	1.78 54.06	0.12 303.77	0.12 241.64	Mag Phase
323	10.85	11.29	2.69 33.74	4.55 232.78	3.99 223.43	4.06 330.13	1.47 102.60	0.98 109.15	0.83 271.07	0.89 107.05	0.11 251.87	0.12 240.70	Mag Phase
324	10.74	11.92	2.45 36.83	5.00 243.57	4.51 218.42	4.86 344.16	1.83 128.55	1.26 127.59	1.03 269.00	1.18 89.06	0.11 331.51	0.10 287.53	Mag Phase

Table VI. - Continued

(j) Continued

Run 10

$\mu_{Nom.} = 0.30$

POINT	MEAN	1/2P-P	1P	2P	3P	4P	5P	6P	7P	8P	9P	10P	
325	10.45	10.07	2.84 44.40	4.71 242.89	3.50 260.80	3.57 323.69	1.10 122.67	1.18 122.49	0.51 276.58	1.32 78.43	0.23 335.04	0.13 291.83	Mag Phase

$\mu_{Nom.} = 0.325$

POINT	MEAN	1/2P-P	1P	2P	3P	4P	5P	6P	7P	8P	9P	10P	
326	12.24	12.28	3.17 43.18	3.37 242.25	4.86 181.20	5.43 334.32	2.63 78.99	1.33 153.87	0.84 264.13	1.40 104.85	0.36 32.97	0.12 246.40	Mag Phase
327	12.54	15.48	2.23 32.94	3.50 251.02	7.40 169.13	7.18 341.19	4.20 75.37	1.64 148.21	1.33 246.44	1.49 144.69	0.35 31.88	0.18 228.07	Mag Phase
328	12.95	22.84	1.44 346.82	4.39 270.77	9.55 166.08	10.75 353.17	7.39 67.82	2.32 154.07	2.23 256.12	1.14 145.14	0.82 9.20	0.25 224.57	Mag Phase

$\mu_{Nom.} = 0.275$

POINT	MEAN	1/2P-P	1P	2P	3P	4P	5P	6P	7P	8P	9P	10P	
329	9.58	12.92	1.84 33.09	6.30 235.11	5.61 234.98	3.80 359.83	1.88 149.44	1.21 116.75	1.43 238.08	1.01 27.92	0.26 282.83	0.19 278.51	Mag Phase
330	9.43	11.57	2.34 37.61	6.11 234.00	5.18 267.32	2.63 341.49	1.16 149.85	0.95 107.94	0.97 243.86	1.48 40.74	0.12 271.37	0.17 289.02	Mag Phase
331	8.96	12.96	1.95 50.76	6.83 237.94	6.18 254.26	2.99 22.77	1.68 174.10	1.33 116.24	1.36 261.79	1.63 44.75	0.30 240.94	0.17 277.92	Mag Phase
332	9.74	10.27	2.38 40.62	5.08 233.48	4.64 277.75	2.46 318.18	1.01 80.39	1.08 100.47	0.53 284.74	0.94 50.19	0.32 318.78	0.10 297.73	Mag Phase

Table VI. - Continued

(j) Continued

Run 10

$\mu_{Nom.} = 0.275$

POINT	MEAN	1/2P-P	1P	2P	3P	4P	5P	6P	7P	8P	9P	10P	
333	9.42	11.49	2.28 40.94	6.15 235.24	5.22 267.12	2.54 348.41	1.28 156.60	1.06 105.95	0.96 234.98	1.37 30.39	0.20 278.51	0.18 295.70	Mag Phase
334	9.22	12.23	2.04 53.93	6.24 236.69	5.36 258.26	2.54 355.29	1.04 135.72	1.05 122.03	1.36 249.31	1.17 17.15	0.50 249.18	0.21 284.55	Mag Phase
335	9.52	11.24	2.44 34.68	5.85 236.56	5.19 284.58	2.05 345.62	1.47 127.68	0.81 103.74	0.52 287.28	0.78 77.79	0.16 312.17	0.13 279.95	Mag Phase
336	9.42	11.68	2.24 41.03	6.10 239.01	5.15 276.13	2.67 349.67	1.31 160.56	0.96 127.10	0.93 251.95	1.52 48.89	0.07 295.45	0.12 323.90	Mag Phase
337	9.21	10.44	2.30 42.91	5.61 236.90	5.24 289.37	2.15 306.32	0.38 144.11	0.96 107.00	0.67 263.24	1.46 49.73	0.19 315.36	0.09 321.81	Mag Phase

$\mu_{Nom.} = 0.225$

POINT	MEAN	1/2P-P	1P	2P	3P	4P	5P	6P	7P	8P	9P	10P	
338	7.92	17.99	1.89 350.21	8.06 231.36	7.51 292.46	3.37 28.01	3.23 205.47	0.47 174.52	1.23 271.75	2.21 6.04	0.51 344.18	0.06 17.04	Mag Phase
339	7.70	15.89	1.89 357.43	7.15 233.26	7.05 300.53	2.40 17.92	2.69 230.33	0.35 153.00	1.09 286.44	2.09 8.28	0.56 341.03	0.04 91.93	Mag Phase
340	7.37	18.09	2.09 340.43	8.31 229.65	8.24 288.24	3.29 31.34	4.50 212.65	0.57 194.19	0.87 243.04	1.48 62.61	0.73 3.92	0.06 252.12	Mag Phase
341	8.13	13.78	1.97 7.18	6.45 226.44	5.82 291.65	2.35 0.34	1.27 174.19	0.55 118.58	0.31 269.15	2.08 336.74	0.56 310.71	0.16 301.12	Mag Phase

Table VI. - Continued

(j) Concluded

Run 10

$\mu_{Nom.} = 0.225$

POINT	MEAN	1/2P-P	1P	2P	3P	4P	5P	6P	7P	8P	9P	10P	
342	7.74	16.33	2.02 354.84	7.42 230.33	6.90 293.70	2.44 13.71	3.11 213.64	0.37 133.67	1.09 270.83	2.31 351.25	0.53 332.78	0.03 131.83	Mag Phase
343	7.55	16.52	1.51 359.30	7.47 232.49	7.31 293.29	2.98 14.73	3.26 211.25	0.58 180.26	0.87 265.39	1.50 2.33	0.75 336.50	0.07 36.53	Mag Phase
344	7.83	15.76	2.24 355.67	7.01 227.98	6.80 297.03	2.29 10.78	2.59 197.62	0.25 116.41	0.57 247.89	1.91 337.28	0.33 324.52	0.08 313.86	Mag Phase
345	7.78	15.98	2.00 356.22	7.44 230.17	7.13 293.12	2.55 11.40	3.03 215.15	0.37 154.08	1.07 267.64	1.85 0.11	0.61 334.22	0.05 46.05	Mag Phase
346	7.67	14.33	1.85 4.81	6.57 229.78	6.64 299.04	2.02 348.23	2.50 221.31	0.33 154.11	0.66 275.89	1.98 5.36	0.62 332.55	0.07 113.07	Mag Phase



Table VI. - Continued

(k) Blade chordwise bending moment, in-lbs, 77.23 percent radius

Run 10

$\mu_{Nom.} = 0.08$

POINT	MEAN	1/2P-P	1P	2P	3P	4P	5P	6P	7P	8P	9P	10P	
281	-29.03	9.06	2.70 296.94	1.19 126.62	3.42 224.23	1.53 355.92	1.00 140.77	2.37 45.10	0.53 181.89	1.10 278.69	0.18 130.20	0.13 314.46	Mag Phase
282	-29.28	8.06	2.63 289.35	1.29 131.42	2.85 227.62	1.37 349.26	1.36 143.42	2.36 33.39	0.58 144.61	1.21 251.57	0.12 156.83	0.20 350.10	Mag Phase
283	-29.37	8.22	2.53 286.09	1.32 135.27	2.43 234.50	1.37 353.77	1.22 123.73	2.12 12.05	0.50 165.08	1.71 339.33	0.19 223.52	0.18 33.88	Mag Phase

$\mu_{Nom.} = 0.11$

POINT	MEAN	1/2P-P	1P	2P	3P	4P	5P	6P	7P	8P	9P	10P	
284	-29.47	6.93	2.31 295.12	1.72 158.97	2.45 238.46	1.72 335.49	1.55 85.68	0.82 24.33	0.51 173.84	1.46 285.91	0.11 229.10	0.21 14.63	Mag Phase
285	-29.14	8.17	2.59 298.05	1.98 148.06	2.79 230.17	1.92 334.27	1.61 94.81	1.19 25.91	0.54 171.55	1.63 268.10	0.10 245.43	0.16 6.43	Mag Phase
286	-28.59	10.02	2.80 307.07	2.34 148.08	3.34 233.82	1.89 339.41	1.24 123.25	1.33 47.82	0.67 181.67	2.04 305.93	0.20 98.88	0.28 49.08	Mag Phase

$\mu_{Nom.} = 0.13$

POINT	MEAN	1/2P-P	1P	2P	3P	4P	5P	6P	7P	8P	9P	10P	
287	-29.15	8.68	3.03 307.42	2.61 146.76	3.23 232.63	2.28 335.12	0.04 105.89	1.54 80.74	0.49 190.43	0.59 263.65	0.21 238.07	0.36 14.79	Mag Phase
288	-29.81	8.71	2.76 306.00	2.33 156.78	2.90 249.17	2.17 350.96	0.69 87.94	1.14 99.42	0.71 224.74	1.01 5.51	0.23 256.06	0.34 75.28	Mag Phase

Table VI. - Continued

(k) Continued

Run 10

$\mu_{Nom.} = 0.13$

POINT	MEAN	1/2P-P	1P	2P	3P	4P	5P	6P	7P	8P	9P	10P	
289	-30.15	6.66	2.55 300.47	1.89 161.31	2.51 249.02	1.94 344.05	0.87 30.26	1.01 97.97	0.42 197.61	0.80 252.28	0.44 251.42	0.13 355.45	Mag Phase

$\mu_{Nom.} = 0.16$

POINT	MEAN	1/2P-P	1P	2P	3P	4P	5P	6P	7P	8P	9P	10P	
290	-30.08	8.98	2.86 306.13	1.93 166.21	2.72 255.09	2.08 344.35	1.28 33.29	1.96 116.02	0.06 155.86	1.94 291.49	0.18 289.93	0.34 25.65	Mag Phase
291	-30.04	9.18	3.22 305.74	2.15 155.99	3.02 245.12	2.22 336.78	1.06 30.96	2.28 110.67	0.11 209.95	1.28 285.78	0.19 301.16	0.29 44.00	Mag Phase
292	-29.87	9.27	3.02 305.59	2.43 154.57	3.22 245.70	2.29 331.03	0.89 82.58	2.25 139.16	0.19 195.39	1.53 255.49	0.16 122.32	0.44 73.50	Mag Phase
293	-30.00	9.52	3.03 300.89	1.39 152.07	3.01 250.86	1.75 328.85	3.22 61.30	2.17 84.62	0.57 90.42	1.20 300.50	0.41 324.67	0.34 19.08	Mag Phase
294	-29.96	9.31	3.16 305.58	2.14 157.20	2.94 246.26	2.29 339.58	1.19 29.33	2.33 114.06	0.13 242.75	1.31 265.18	0.17 324.74	0.24 40.69	Mag Phase
295	-30.06	8.86	3.02 308.69	1.92 155.03	3.04 239.67	2.40 332.49	1.41 335.26	1.68 114.74	0.26 182.04	1.36 241.61	0.30 353.83	0.53 41.39	Mag Phase
296	-30.09	9.81	2.84 296.74	2.21 159.94	3.04 243.17	2.00 337.73	2.21 24.43	2.03 93.61	0.26 73.88	1.69 286.46	0.35 278.28	0.29 6.03	Mag Phase
297	-30.27	9.78	2.81 301.20	2.16 155.25	2.98 242.56	2.24 340.13	1.42 21.11	2.12 108.76	0.27 158.43	1.83 290.14	0.16 295.80	0.38 34.37	Mag Phase

Table VI. - Continued

(k) Continued

Run 10

 $\mu_{\text{Nom.}} = 0.16$ 

POINT	MEAN	1/2P-P	1P	2P	3P	4P	5P	6P	7P	8P	9P	10P	
298	-29.70	10.39	3.18 307.14	2.43 152.07	3.48 240.07	2.34 339.63	1.09 3.47	2.65 128.24	0.44 117.12	1.71 281.81	0.31 2.58	0.33 48.25	Mag Phase

 $\mu_{\text{Nom.}} = 0.20$ 

POINT	MEAN	1/2P-P	1P	2P	3P	4P	5P	6P	7P	8P	9P	10P	
299	-30.21	10.59	3.97 312.35	2.15 147.51	3.77 236.84	2.06 314.80	1.66 352.84	2.48 122.09	0.46 82.05	1.40 12.87	0.45 116.18	0.08 198.08	Mag Phase
300	-31.01	9.23	3.44 307.74	1.98 153.19	3.11 240.64	2.15 322.67	1.90 353.03	2.09 116.33	0.60 65.72	1.39 337.14	0.29 137.40	0.05 102.15	Mag Phase
301	-30.96	11.31	3.40 318.61	2.58 162.38	3.95 251.15	2.67 328.56	2.05 23.52	2.10 172.84	0.14 277.87	1.34 1.22	0.86 169.88	0.30 215.22	Mag Phase
302	-31.24	8.55	3.23 306.16	1.38 153.54	2.79 252.14	1.65 310.22	2.71 46.26	1.78 78.01	0.91 95.39	0.92 305.68	0.61 17.26	0.31 347.63	Mag Phase
303	-31.00	9.08	3.39 313.30	2.08 161.82	3.11 253.63	2.22 338.81	1.74 22.31	2.31 141.31	0.49 79.81	0.48 43.11	0.25 166.69	0.11 280.02	Mag Phase
304	-30.87	10.30	3.48 318.16	1.97 159.11	3.39 244.58	2.16 334.94	2.26 358.66	1.86 157.33	0.13 138.15	1.40 2.81	0.17 122.87	0.27 131.76	Mag Phase
305	-31.15	9.74	3.18 310.87	2.10 165.96	3.13 258.93	1.69 344.45	3.34 51.16	2.12 125.55	0.68 83.43	1.08 19.62	0.17 276.93	0.06 66.65	Mag Phase
306	-30.88	9.43	3.47 311.72	2.01 154.53	3.13 243.26	2.12 325.22	2.20 2.49	2.05 129.91	0.48 71.60	1.06 354.68	0.22 104.05	0.08 223.56	Mag Phase

Table VI. - Continued

(k) Continued

Run 10

$\mu_{\text{Nom.}} = 0.20$

POINT	MEAN	1/2P-P	1P	2P	3P	4P	5P	6P	7P	8P	9P	10P	
307	-31.37	8.54	2.96 306.75	1.77 161.67	2.78 250.38	2.08 323.52	2.21 16.18	2.08 110.21	0.25 35.43	0.54 0.68	0.10 235.07	0.03 270.03	Mag Phase

$\mu_{\text{Nom.}} = 0.25$

POINT	MEAN	1/2P-P	1P	2P	3P	4P	5P	6P	7P	8P	9P	10P	
308	-31.95	9.51	3.94 309.63	1.26 159.51	2.58 256.28	1.50 318.57	3.84 4.98	1.11 85.20	0.45 20.69	0.78 350.42	0.54 33.72	0.20 329.53	Mag Phase
309	-31.61	11.46	4.59 315.14	1.48 146.48	2.95 251.33	1.45 316.36	4.83 13.52	0.63 91.83	0.25 134.71	1.19 9.72	0.60 60.37	0.29 30.31	Mag Phase
310	-31.16	13.89	4.90 320.15	2.45 143.92	4.18 240.42	3.08 312.39	3.25 2.48	3.04 111.18	0.99 245.33	0.06 68.10	0.45 90.76	0.20 317.73	Mag Phase
311	-31.78	9.31	4.43 308.20	0.95 122.58	2.52 256.31	1.77 299.61	3.07 10.72	2.20 39.90	0.41 39.28	0.17 276.60	0.85 14.56	0.07 62.49	Mag Phase
312	-31.56	12.04	4.69 313.65	1.46 143.09	3.03 241.87	1.23 311.79	4.83 359.06	1.01 103.90	0.37 151.77	0.51 303.00	0.68 53.41	0.51 22.64	Mag Phase
313	-31.60	11.32	4.86 316.94	1.57 142.23	3.12 235.18	1.80 303.70	4.17 353.23	1.12 64.10	0.71 251.59	0.34 189.27	0.54 67.75	0.62 61.66	Mag Phase
314	-31.76	11.19	4.27 307.93	1.58 147.07	3.10 255.39	1.46 326.89	4.42 26.46	1.60 92.47	0.81 54.59	0.53 239.40	0.70 22.30	0.20 8.00	Mag Phase
315	-31.62	11.29	4.65 313.20	1.41 152.05	3.05 247.73	1.30 318.13	4.59 0.15	1.28 114.56	0.32 165.18	0.29 74.70	0.66 69.85	0.42 23.17	Mag Phase

Table VI. - Continued

(k) Continued

Run 10

$\mu_{Nom.} = 0.25$

POINT	MEAN	1/2P-P	1P	2P	3P	4P	5P	6P	7P	8P	9P	10P	
316	-31.07	13.08	5.19 314.54	1.67 135.71	3.76 232.22	1.66 298.09	4.84 0.61	1.96 99.28	0.49 260.74	0.53 20.86	0.62 108.09	0.60 65.69	Mag Phase

$\mu_{Nom.} = 0.30$

POINT	MEAN	1/2P-P	1P	2P	3P	4P	5P	6P	7P	8P	9P	10P	
317	-29.41	21.77	6.09 317.12	1.05 3.85	3.34 172.80	1.95 180.64	3.34 325.00	11.16 13.42	2.16 34.13	0.56 128.60	1.57 108.86	0.63 48.92	Mag Phase
318	-31.15	17.13	5.94 312.88	0.79 64.47	2.84 195.54	1.17 190.77	4.25 341.30	7.61 29.21	0.51 27.33	1.11 184.80	1.22 78.59	0.50 60.14	Mag Phase
319	-30.44	17.15	5.98 321.89	1.08 89.24	4.00 195.26	1.31 217.62	2.38 340.00	8.35 32.31	1.10 38.99	0.99 341.73	0.96 158.60	0.55 133.22	Mag Phase
320	-31.72	14.87	6.08 305.06	0.93 60.46	1.85 197.98	0.95 243.84	4.91 336.12	6.01 6.35	1.37 65.29	0.99 122.08	2.41 20.00	0.40 325.31	Mag Phase
321	-31.27	15.53	5.92 312.59	0.77 66.71	2.75 199.87	1.18 189.47	4.03 342.68	7.43 25.83	0.54 68.54	0.61 98.37	1.27 67.70	0.26 67.62	Mag Phase
322	-31.03	17.57	5.97 318.31	0.82 55.92	3.03 185.50	0.85 197.91	3.61 332.45	8.34 16.51	1.16 12.97	0.52 258.23	1.11 139.82	0.77 82.73	Mag Phase
323	-31.64	14.83	5.79 305.89	0.75 68.69	2.44 213.27	0.67 201.81	5.41 348.04	4.57 2.11	1.19 104.28	1.27 52.07	1.69 43.40	0.13 119.43	Mag Phase
324	-31.29	15.64	5.97 314.66	0.67 67.11	2.73 203.86	1.21 189.29	3.79 352.37	7.71 32.35	0.57 60.96	1.00 98.77	1.41 65.85	0.29 65.05	Mag Phase

Table VI. - Continued

(k) Continued

Run 10

$\mu_{Nom.} = 0.30$

POINT	MEAN	1/2P-P	1P	2P	3P	4P	5P	6P	7P	8P	9P	10P	
325	-32.50	12.71	5.31 312.83	0.59 94.62	1.93 232.41	0.29 174.50	4.62 345.78	3.45 4.49	0.36 55.11	0.40 209.63	1.68 43.59	0.54 8.93	Mag Phase

$\mu_{Nom.} = 0.325$

POINT	MEAN	1/2P-P	1P	2P	3P	4P	5P	6P	7P	8P	9P	10P	
326	-31.63	18.98	6.66 314.07	0.84 354.09	2.51 181.11	1.14 152.53	5.49 341.95	7.99 6.72	1.92 59.95	1.14 124.36	2.41 17.72	0.40 26.92	Mag Phase
327	-30.04	24.36	6.77 317.93	1.31 338.43	3.40 163.28	2.02 173.11	5.68 328.15	11.69 14.49	3.04 60.08	1.83 172.82	2.39 59.29	0.64 45.12	Mag Phase
328	-28.29	45.28	6.64 333.63	2.46 310.44	4.75 151.23	2.97 213.09	11.87 334.60	26.09 17.13	5.55 57.20	2.12 222.90	1.75 127.26	1.51 45.52	Mag Phase

$\mu_{Nom.} = 0.275$

POINT	MEAN	1/2P-P	1P	2P	3P	4P	5P	6P	7P	8P	9P	10P	
329	-31.18	16.21	5.81 314.90	1.14 104.67	3.78 211.68	1.16 224.42	5.59 337.13	4.93 13.36	0.42 296.67	1.03 168.91	0.87 111.37	0.60 31.56	Mag Phase
330	-32.47	11.70	5.37 312.73	1.35 127.98	3.05 232.09	0.83 279.09	5.72 340.80	1.57 13.81	0.44 222.80	1.44 45.72	0.86 90.68	0.33 16.39	Mag Phase
331	-31.83	13.22	5.54 319.96	1.87 134.38	4.32 226.19	2.18 284.25	4.36 352.56	3.40 37.87	1.14 239.30	1.34 89.05	0.68 138.69	0.24 176.85	Mag Phase
332	-32.64	11.52	5.14 308.41	1.03 89.05	2.49 253.51	1.57 286.60	4.30 347.25	2.40 22.17	0.28 102.84	0.40 228.71	1.29 37.56	0.05 318.78	Mag Phase

Table VI. - Continued

(k) Continued

Run 10

$\mu_{\text{Nom.}} = 0.275$

POINT	MEAN	1/2P-P	1P	2P	3P	4P	5P	6P	7P	8P	9P	10P	
333	-32.38	11.23	5.34 313.40	1.38 128.90	3.04 231.92	0.66 276.70	5.22 345.26	1.24 19.89	0.38 214.72	0.59 20.48	0.97 92.71	0.50 12.40	Mag Phase
334	-32.12	13.46	5.43 317.48	1.58 127.44	3.50 220.92	1.74 267.16	5.40 329.94	3.00 11.57	0.77 223.51	1.45 101.42	0.12 195.72	0.30 2.16	Mag Phase
335	-32.32	12.35	4.92 310.30	1.05 115.75	3.12 258.60	0.60 297.70	4.94 21.21	0.58 158.02	0.59 125.04	0.63 163.61	1.25 57.49	0.07 128.36	Mag Phase
336	-32.05	12.23	5.32 314.28	1.31 126.16	3.04 238.98	0.64 279.74	5.64 354.30	1.01 59.51	0.46 201.12	1.35 10.02	1.02 108.95	0.32 51.76	Mag Phase
337	-32.91	11.56	4.56 310.25	0.83 136.10	2.60 254.22	0.84 292.37	4.97 341.86	0.65 68.81	0.14 333.08	0.88 106.52	0.97 50.70	0.29 322.09	Mag Phase

$\mu_{\text{Nom.}} = 0.225$

POINT	MEAN	1/2P-P	1P	2P	3P	4P	5P	6P	7P	8P	9P	10P	
338	-31.55	12.21	4.42 316.04	2.01 144.43	3.66 245.84	1.61 331.50	3.42 1.14	2.04 135.67	0.57 233.20	1.01 355.09	0.61 74.47	0.46 72.47	Mag Phase
339	-32.16	10.51	3.83 311.74	1.65 151.58	2.88 261.16	1.70 341.43	3.00 358.19	1.90 167.87	0.05 274.62	0.89 0.02	0.75 65.17	0.19 47.15	Mag Phase
340	-31.85	12.45	4.18 317.00	2.85 143.80	4.03 243.39	3.24 318.19	1.42 340.19	2.83 158.22	0.94 216.26	0.96 356.43	1.00 85.83	0.02 72.09	Mag Phase
341	-32.31	10.50	3.61 305.84	1.28 148.49	2.94 261.81	1.83 316.58	3.77 30.76	2.51 74.04	0.44 68.01	1.55 314.89	0.84 0.15	0.49 3.71	Mag Phase

Table VI. - Continued

(k) Concluded

Run 10

$\mu_{Nom.} = 0.225$

POINT	MEAN	1/2P-P	1P	2P	3P	4P	5P	6P	7P	8P	9P	10P	
342	-32.01	11.23	3.82 311.09	1.82 152.03	2.98 255.65	1.67 337.85	2.88 1.52	2.80 134.50	0.23 198.48	1.06 0.20	0.67 37.28	0.18 38.30	Mag Phase
343	-32.05	10.53	4.18 316.90	2.01 147.99	3.15 242.71	2.07 323.76	3.46 329.74	1.18 175.86	0.78 240.13	0.98 18.92	0.84 49.06	0.75 49.75	Mag Phase
344	-32.15	11.46	3.40 306.97	1.79 156.88	3.17 262.19	1.81 341.11	4.43 32.25	2.14 110.49	0.47 79.42	1.49 314.94	0.50 320.95	0.45 16.60	Mag Phase
345	-32.28	10.57	3.83 312.32	1.80 153.89	3.02 256.29	1.75 335.63	2.69 349.98	2.06 148.10	0.20 160.58	1.22 325.05	0.74 54.14	0.30 29.68	Mag Phase
346	-32.80	9.20	3.27 308.71	1.53 160.95	2.69 266.57	1.80 335.19	2.69 12.35	2.01 120.82	0.18 26.91	0.80 296.76	0.64 9.03	0.28 14.41	Mag Phase



Table VI. - Continued

(l) Blade torsional moment, in-lbs, 85.00 percent radius

Run 10

$\mu_{Nom.} = 0.08$

POINT	MEAN	1/2P-P	1P	2P	3P	4P	5P	6P	7P	8P	9P	10P	
281	2.09	8.76	1.27 104.40	1.48 325.21	2.63 123.34	1.15 325.55	1.80 189.38	1.24 3.09	1.23 203.71	1.40 43.77	1.23 238.06	1.03 67.82	Mag Phase
282	2.59	2.14	0.52 284.39	0.65 84.23	0.93 92.87	0.48 172.87	0.68 252.28	0.23 162.29	0.14 43.39	0.15 75.29	0.14 229.71	0.14 327.93	Mag Phase
283	2.28	1.97	0.45 294.31	0.55 99.23	0.81 93.68	0.41 173.77	0.68 254.83	0.16 161.78	0.17 60.10	0.09 109.36	0.05 208.09	0.11 296.25	Mag Phase

$\mu_{Nom.} = 0.11$

POINT	MEAN	1/2P-P	1P	2P	3P	4P	5P	6P	7P	8P	9P	10P	
284	2.22	1.89	0.42 329.23	0.47 136.46	0.86 81.67	0.41 164.34	0.60 250.71	0.08 212.16	0.14 37.63	0.18 71.32	0.08 355.61	0.08 211.52	Mag Phase
285	2.52	2.01	0.41 318.08	0.51 124.18	0.97 78.17	0.46 167.79	0.60 246.04	0.15 174.30	0.12 25.57	0.22 60.75	0.03 265.40	0.10 245.40	Mag Phase
286	2.57	3.98	0.18 97.41	0.37 24.81	1.39 116.70	0.17 19.83	1.12 239.76	0.52 87.75	0.48 296.20	0.84 116.95	0.60 311.77	0.43 185.49	Mag Phase

$\mu_{Nom.} = 0.13$

POINT	MEAN	1/2P-P	1P	2P	3P	4P	5P	6P	7P	8P	9P	10P	
287	2.80	2.22	0.33 322.00	0.41 129.96	1.13 85.44	0.30 183.25	0.42 233.28	0.11 183.25	0.16 23.65	0.18 89.86	0.02 39.84	0.27 206.51	Mag Phase
288	2.47	1.98	0.42 330.43	0.37 158.81	1.03 91.07	0.38 182.07	0.34 258.40	0.17 185.77	0.13 46.59	0.13 106.25	0.05 195.60	0.23 265.65	Mag Phase

Table VI. - Continued

(l) Continued

Run 10

$\mu_{Nom.} = 0.13$

POINT	MEAN	1/2P-P	1P	2P	3P	4P	5P	6P	7P	8P	9P	10P	
289	2.18	1.58	0.38 339.73	0.32 168.89	0.88 84.41	0.34 156.76	0.28 250.05	0.18 159.83	0.08 53.64	0.13 72.84	0.11 204.83	0.06 289.70	Mag Phase

$\mu_{Nom.} = 0.16$

POINT	MEAN	1/2P-P	1P	2P	3P	4P	5P	6P	7P	8P	9P	10P	
290	2.27	1.52	0.42 6.35	0.37 171.61	0.89 89.38	0.32 162.39	0.23 231.80	0.15 182.07	0.07 7.74	0.19 99.16	0.07 284.82	0.04 288.27	Mag Phase
291	2.55	1.71	0.38 358.91	0.42 150.96	0.94 84.20	0.27 171.42	0.29 224.76	0.13 218.82	0.10 38.12	0.16 92.75	0.09 310.59	0.11 264.29	Mag Phase
292	2.64	1.89	0.43 351.06	0.49 168.13	1.08 80.69	0.33 147.84	0.33 236.57	0.09 192.76	0.10 32.51	0.17 72.77	0.07 314.68	0.13 252.75	Mag Phase
293	2.93	2.73	1.22 320.28	0.96 158.41	0.98 71.21	0.22 179.26	0.43 233.00	0.17 155.83	0.18 8.84	0.10 93.82	0.06 268.27	0.08 247.96	Mag Phase
294	2.59	1.62	0.31 327.64	0.41 142.11	0.78 89.31	0.20 144.55	0.34 224.78	0.07 186.29	0.08 78.70	0.17 93.02	0.03 108.25	0.17 214.92	Mag Phase
295	2.98	2.30	0.86 298.49	0.82 143.80	0.68 57.16	0.48 169.48	0.14 184.60	0.05 272.43	0.09 121.33	0.25 72.33	0.14 292.90	0.14 181.03	Mag Phase
296	3.44	2.58	1.65 334.20	0.86 189.58	0.66 78.89	0.30 179.31	0.40 221.47	0.32 144.11	0.16 121.40	0.22 89.03	0.16 347.39	0.08 331.25	Mag Phase
297	3.64	2.70	1.47 338.88	0.84 186.31	0.60 70.94	0.28 253.25	0.50 261.21	0.10 159.58	0.17 90.01	0.32 106.70	0.02 356.31	0.07 209.78	Mag Phase

Table VI. - Continued

(l) Continued

Run 10

$\mu_{\text{Nom.}} = 0.16$

POINT	MEAN	1/2P-P	1P	2P	3P	4P	5P	6P	7P	8P	9P	10P	
298	4.13	3.24	1.53 343.27	0.88 177.51	0.68 65.91	0.43 268.90	0.73 271.76	0.11 315.32	0.11 75.25	0.34 114.67	0.06 212.56	0.21 217.54	Mag Phase

$\mu_{\text{Nom.}} = 0.20$

POINT	MEAN	1/2P-P	1P	2P	3P	4P	5P	6P	7P	8P	9P	10P	
299	4.70	2.92	1.83 23.57	1.15 150.51	0.62 82.03	0.50 207.12	0.74 231.72	0.34 204.20	0.16 187.42	0.36 172.82	0.13 177.78	0.14 172.69	Mag Phase
300	4.06	2.40	1.66 2.57	0.81 188.84	0.21 24.83	0.44 248.41	0.66 256.41	0.21 248.01	0.09 331.97	0.17 127.09	0.11 75.47	0.16 112.16	Mag Phase
301	4.00	2.83	1.70 347.62	1.07 202.45	0.47 68.72	0.18 261.32	0.41 246.22	0.19 132.83	0.23 89.10	0.21 151.56	0.10 28.21	0.10 334.44	Mag Phase
302	4.17	2.56	1.75 24.44	0.80 166.60	0.24 111.38	0.44 201.79	0.55 250.77	0.42 225.03	0.27 259.17	0.26 220.90	0.20 244.52	0.21 236.19	Mag Phase
303	4.10	2.35	1.73 8.71	0.68 193.98	0.40 36.76	0.35 284.83	0.57 289.46	0.15 293.31	0.09 14.80	0.17 176.18	0.06 218.53	0.14 224.97	Mag Phase
304	4.08	2.45	1.69 4.16	0.53 190.86	0.57 29.00	0.35 294.08	0.52 286.54	0.06 296.56	0.12 23.46	0.22 190.26	0.10 240.33	0.17 255.72	Mag Phase
305	4.38	2.75	1.85 28.46	1.09 169.51	0.65 120.68	0.48 183.41	0.43 241.95	0.39 193.95	0.17 169.75	0.28 167.08	0.16 135.98	0.11 134.24	Mag Phase
306	4.34	2.51	1.76 18.49	0.86 164.95	0.41 62.76	0.31 249.04	0.68 266.62	0.32 275.74	0.33 313.35	0.15 298.91	0.29 324.11	0.23 326.19	Mag Phase

Table VI. - Continued

(l) Continued

Run 10

$\mu_{\text{Nom.}} = 0.20$

POINT	MEAN	1/2P-P	1P	2P	3P	4P	5P	6P	7P	8P	9P	10P	
307	3.81	2.16	1.68 8.60	0.56 185.59	0.36 44.37	0.06 324.75	0.31 288.96	0.04 46.79	0.16 25.86	0.11 101.21	0.09 26.99	0.05 70.45	Mag Phase

$\mu_{\text{Nom.}} = 0.25$

POINT	MEAN	1/2P-P	1P	2P	3P	4P	5P	6P	7P	8P	9P	10P	
308	4.45	2.85	2.54 32.15	0.37 130.91	0.17 272.28	0.54 148.31	0.25 187.16	0.21 199.26	0.09 250.77	0.09 231.18	0.13 290.66	0.16 274.34	Mag Phase
309	4.90	3.25	2.86 37.31	0.73 102.45	0.35 8.62	0.56 162.04	0.17 303.22	0.21 188.65	0.04 121.56	0.11 174.31	0.03 26.18	0.06 307.47	Mag Phase
310	5.00	3.56	2.66 32.27	0.84 123.26	0.57 18.75	0.53 220.92	0.42 264.35	0.44 224.71	0.17 206.01	0.21 187.32	0.12 200.20	0.15 225.51	Mag Phase
311	4.76	3.28	2.88 37.93	0.57 85.33	0.28 315.60	0.64 148.45	0.07 330.47	0.16 173.24	0.04 118.72	0.04 105.48	0.05 40.45	0.03 306.34	Mag Phase
312	4.93	3.26	2.85 34.75	0.74 100.28	0.35 355.16	0.61 156.95	0.20 292.02	0.19 173.10	0.04 79.84	0.10 148.71	0.03 330.83	0.05 272.46	Mag Phase
313	4.84	3.53	2.65 33.68	0.61 91.70	0.62 336.39	0.52 201.28	0.46 299.75	0.21 246.02	0.18 333.46	0.12 353.14	0.23 7.92	0.21 348.58	Mag Phase
314	4.91	3.07	2.93 35.11	0.57 108.36	0.20 9.16	0.57 144.88	0.21 337.31	0.14 174.78	0.05 95.19	0.07 143.60	0.02 73.31	0.02 313.73	Mag Phase
315	4.91	3.20	2.81 35.66	0.68 104.41	0.32 352.83	0.62 165.82	0.20 296.51	0.23 193.32	0.04 175.78	0.12 184.36	0.02 250.04	0.07 260.98	Mag Phase

Table VI. - Continued

(l) Continued

Run 10

 $\mu_{\text{Nom.}} = 0.25$ 

POINT	MEAN	1/2P-P	1P	2P	3P	4P	5P	6P	7P	8P	9P	10P	
316	5.38	4.14	3.14 37.59	1.08 85.01	0.80 350.76	0.70 188.40	0.30 308.12	0.24 192.67	0.09 147.21	0.14 176.14	0.01 41.08	0.04 275.76	Mag Phase

 $\mu_{\text{Nom.}} = 0.30$ 

POINT	MEAN	1/2P-P	1P	2P	3P	4P	5P	6P	7P	8P	9P	10P	
317	5.87	8.31	4.40 34.53	2.83 24.73	3.51 298.87	2.04 175.87	0.92 322.78	0.66 166.92	0.27 251.08	0.07 244.99	0.05 337.24	0.10 94.42	Mag Phase
318	5.59	6.55	4.05 37.45	2.00 38.73	2.30 303.71	1.59 170.96	0.57 330.83	0.43 170.81	0.13 216.86	0.07 284.36	0.05 71.03	0.04 94.77	Mag Phase
319	5.72	6.97	4.06 35.94	2.21 40.57	2.74 312.51	1.64 184.30	0.79 342.56	0.52 178.47	0.12 264.51	0.06 234.97	0.09 35.05	0.02 128.56	Mag Phase
320	5.39	6.22	4.03 36.49	1.85 33.39	1.93 292.55	1.53 153.21	0.28 309.07	0.36 137.50	0.15 188.41	0.13 253.30	0.08 121.28	0.04 77.77	Mag Phase
321	5.59	6.48	4.04 37.45	1.95 39.37	2.22 303.39	1.56 170.07	0.53 328.16	0.42 169.47	0.13 211.64	0.09 281.07	0.04 100.39	0.04 73.82	Mag Phase
322	5.61	6.81	4.00 36.72	2.20 34.64	2.61 300.60	1.67 170.19	0.67 330.21	0.49 162.63	0.15 223.05	0.06 221.61	0.09 26.47	0.04 54.40	Mag Phase
323	5.54	6.16	4.09 36.01	1.71 37.29	1.82 298.87	1.38 159.59	0.36 317.58	0.39 142.64	0.11 200.03	0.11 275.37	0.05 116.96	0.04 81.57	Mag Phase
324	5.60	6.51	4.07 38.10	1.96 40.65	2.25 305.57	1.61 172.97	0.58 335.33	0.44 172.88	0.12 223.70	0.12 286.99	0.04 108.16	0.05 94.98	Mag Phase

Table VI. - Continued

(I) Continued

Run 10

$\mu_{Nom.} = 0.30$

POINT	MEAN	1/2P-P	1P	2P	3P	4P	5P	6P	7P	8P	9P	10P	
325	5.15	5.23	3.69 37.51	1.26 44.51	1.29 297.31	1.31 153.15	0.31 331.25	0.30 143.03	0.12 199.54	0.07 262.55	0.08 137.08	0.00 160.22	Mag Phase

$\mu_{Nom.} = 0.325$

POINT	MEAN	1/2P-P	1P	2P	3P	4P	5P	6P	7P	8P	9P	10P	
326	5.43	7.55	4.33 38.41	2.41 32.05	2.78 295.36	1.99 163.83	0.48 314.24	0.57 140.55	0.16 209.13	0.17 271.51	0.06 161.94	0.07 75.69	Mag Phase
327	5.73	9.18	4.67 36.02	3.12 22.02	3.85 294.93	2.25 169.08	0.98 318.68	0.72 147.57	0.33 249.80	0.09 322.89	0.02 292.47	0.16 78.76	Mag Phase
328	5.61	12.34	5.12 33.51	3.73 13.21	4.63 294.72	3.08 178.60	1.37 327.52	2.51 162.04	1.40 257.66	0.28 63.69	0.33 280.59	0.50 78.64	Mag Phase

$\mu_{Nom.} = 0.275$

POINT	MEAN	1/2P-P	1P	2P	3P	4P	5P	6P	7P	8P	9P	10P	
329	5.79	5.77	3.77 35.95	1.65 50.52	1.74 313.92	1.19 176.71	0.50 326.10	0.38 168.14	0.04 146.87	0.06 318.29	0.09 37.46	0.04 57.85	Mag Phase
330	5.33	4.33	3.43 35.43	1.04 63.85	0.80 315.61	0.93 151.55	0.29 324.96	0.22 153.00	0.06 122.40	0.06 210.12	0.05 37.46	0.03 356.63	Mag Phase
331	5.56	4.65	3.36 35.40	1.25 74.66	1.26 333.89	0.87 189.52	0.38 342.49	0.30 192.01	0.04 124.64	0.09 273.55	0.09 11.43	0.07 318.02	Mag Phase
332	5.12	4.16	3.40 37.23	0.85 54.06	0.62 300.74	0.85 141.45	0.14 308.83	0.13 151.68	0.04 178.29	0.03 321.17	0.06 74.82	0.02 31.73	Mag Phase

Table VI. - Continued

(l) Continued

Run 10

$\mu_{Nom.} = 0.275$

POINT	MEAN	1/2P-P	1P	2P	3P	4P	5P	6P	7P	8P	9P	10P	
333	5.29	4.32	3.41 35.94	1.04 66.59	0.80 320.38	0.90 155.86	0.29 329.29	0.24 156.68	0.05 131.03	0.06 184.71	0.05 38.39	0.02 3.90	Mag Phase
334	5.19	4.61	3.19 32.47	1.06 58.70	1.30 318.91	0.70 186.46	0.56 311.10	0.22 248.36	0.21 316.22	0.26 328.12	0.31 356.27	0.22 339.42	Mag Phase
335	5.21	4.14	3.50 36.18	0.75 64.49	0.57 315.93	0.82 150.26	0.25 343.45	0.15 134.56	0.06 123.65	0.01 18.68	0.02 107.78	0.04 49.04	Mag Phase
336	5.27	4.28	3.43 37.51	1.02 67.52	0.78 320.22	0.93 158.61	0.34 338.63	0.19 162.47	0.04 130.46	0.08 194.84	0.05 44.88	0.03 355.25	Mag Phase
337	4.62	3.69	2.96 25.65	0.33 3.93	0.79 291.38	0.47 139.17	0.51 319.95	0.09 335.08	0.13 334.94	0.13 313.87	0.10 342.13	0.08 319.06	Mag Phase

$\mu_{Nom.} = 0.225$

POINT	MEAN	1/2P-P	1P	2P	3P	4P	5P	6P	7P	8P	9P	10P	
338	4.84	3.04	2.43 16.27	0.31 148.11	0.75 356.61	0.34 276.15	0.64 312.47	0.12 318.54	0.14 23.27	0.09 194.16	0.07 273.60	0.12 248.42	Mag Phase
339	4.36	2.44	2.28 12.64	0.28 223.08	0.54 0.51	0.15 348.37	0.45 328.16	0.04 104.06	0.08 39.20	0.11 205.76	0.13 291.44	0.13 296.04	Mag Phase
340	4.53	2.69	2.17 6.75	0.59 183.29	0.63 21.48	0.44 298.38	0.44 292.82	0.04 358.74	0.11 68.01	0.13 190.82	0.17 229.03	0.20 236.85	Mag Phase
341	4.29	2.60	2.40 18.11	0.09 353.19	0.62 345.29	0.20 74.00	0.40 341.36	0.04 98.61	0.12 356.34	0.04 79.62	0.11 342.50	0.09 323.96	Mag Phase

Table VI. - Continued

(I) Concluded

Run 10

$\mu_{Nom.} = 0.225$

POINT	MEAN	1/2P-P	1P	2P	3P	4P	5P	6P	7P	8P	9P	10P	
342	4.46	2.74	2.34 15.07	0.22 182.09	0.64 4.37	0.16 0.28	0.55 336.96	0.15 37.95	0.23 25.51	0.05 93.37	0.14 323.29	0.16 326.35	Mag Phase
343	4.50	2.73	2.17 14.42	0.28 151.50	0.72 359.42	0.19 310.24	0.54 322.85	0.16 28.38	0.19 33.82	0.02 115.96	0.08 278.54	0.18 265.80	Mag Phase
344	4.41	2.72	2.30 14.79	0.52 209.42	0.27 320.37	0.16 262.17	0.61 301.57	0.15 247.49	0.10 308.29	0.14 168.07	0.09 214.00	0.13 214.85	Mag Phase
345	4.53	2.71	2.31 16.43	0.32 183.67	0.53 356.14	0.14 321.56	0.60 323.16	0.16 8.10	0.23 15.76	0.04 69.65	0.11 306.14	0.14 291.50	Mag Phase
346	4.26	2.45	2.15 22.37	0.39 180.93	0.22 29.91	0.23 72.35	0.43 342.93	0.20 52.94	0.29 43.27	0.19 76.71	0.12 44.96	0.05 36.33	Mag Phase



Table VI. - Continued

(m) Fixed-system strain-gage balance normal force, lbs

Run 10

$\mu_{Nom.} = 0.08$

POINT	MEAN	1/2P-P	1P	2P	3P	4P	5P	6P	7P	8P	9P	10P	
281	203.79	71.21	9.39 196.27	2.18 169.43	3.60 147.78	53.71 123.16	1.92 53.67	8.71 186.60	0.79 53.46	20.16 160.66	6.53 206.38	3.63 288.66	Mag Phase
282	183.15	73.57	9.42 186.97	1.42 170.22	3.36 161.74	51.66 118.38	1.62 120.47	9.37 177.79	0.79 30.82	22.37 170.22	5.05 235.48	3.31 298.81	Mag Phase
283	164.10	72.31	10.11 181.02	0.94 161.97	3.40 170.59	46.99 120.07	1.11 128.51	8.84 177.94	1.28 15.00	21.96 182.73	4.91 246.57	3.96 295.66	Mag Phase

$\mu_{Nom.} = 0.11$

POINT	MEAN	1/2P-P	1P	2P	3P	4P	5P	6P	7P	8P	9P	10P	
284	163.93	64.45	13.86 181.01	0.17 193.12	3.12 169.79	39.96 118.20	2.48 42.60	9.13 182.82	0.61 340.70	24.37 159.50	4.12 234.59	3.53 285.18	Mag Phase
285	182.84	71.34	13.26 183.07	0.93 205.57	3.37 167.28	45.21 114.33	2.71 32.00	10.07 175.63	1.34 9.30	29.23 143.49	5.66 197.47	4.63 280.24	Mag Phase
286	205.17	79.08	13.75 187.88	0.78 178.52	3.95 180.45	50.10 126.01	3.20 78.68	10.26 197.89	2.82 23.93	32.09 160.64	6.85 188.51	6.11 309.78	Mag Phase

$\mu_{Nom.} = 0.13$

POINT	MEAN	1/2P-P	1P	2P	3P	4P	5P	6P	7P	8P	9P	10P	
287	204.89	78.39	17.47 186.75	0.47 191.57	3.74 192.75	46.82 117.74	5.91 335.97	8.07 196.54	3.73 351.61	27.24 151.69	4.44 163.85	4.30 300.16	Mag Phase
288	185.82	73.17	17.57 188.68	0.05 139.06	3.35 199.12	44.07 132.12	5.54 358.27	7.69 206.13	2.71 11.75	23.51 186.60	2.94 229.53	4.74 328.55	Mag Phase

Table VI. - Continued

(m) Continued

Run 10

$\mu_{\text{Nom.}} = 0.13$

POINT	MEAN	1/2P-P	1P	2P	3P	4P	5P	6P	7P	8P	9P	10P	
289	161.66	63.17	17.62	0.43	2.75	38.41	3.94	7.65	1.38	17.76	2.50	3.88	Mag Phase
			185.73	336.82	199.61	122.85	342.56	195.09	353.08	173.03	256.40	289.71	

$\mu_{\text{Nom.}} = 0.16$

POINT	MEAN	1/2P-P	1P	2P	3P	4P	5P	6P	7P	8P	9P	10P	
290	166.39	67.27	21.25	1.26	3.37	40.50	9.23	8.03	0.64	15.03	0.76	6.26	Mag Phase
			185.90	353.76	213.93	128.47	355.43	206.86	72.65	166.36	322.15	316.19	
291	183.53	72.50	21.72	0.82	3.56	43.28	10.25	8.03	1.92	18.83	1.81	6.78	Mag Phase
			185.11	351.65	203.29	122.94	346.08	196.73	5.50	153.23	145.70	287.75	
292	196.71	61.83	26.50	2.09	3.06	32.37	10.23	5.71	2.98	13.96	5.92	5.02	Mag Phase
			183.00	64.13	207.19	127.87	21.67	224.65	318.98	194.99	177.17	132.21	
293	171.18	69.17	21.48	1.79	0.54	39.56	7.10	8.56	1.34	19.39	1.47	3.65	Mag Phase
			185.29	316.56	98.75	134.38	357.25	243.90	294.33	159.17	271.90	47.84	
294	183.48	73.05	21.80	0.83	3.31	43.19	10.88	8.42	1.11	19.42	1.53	5.28	Mag Phase
			184.99	337.33	206.31	124.33	343.65	200.67	341.68	160.35	183.95	309.49	
295	188.18	72.01	22.50	0.93	2.97	41.43	7.31	10.73	0.49	15.66	4.26	2.44	Mag Phase
			183.48	44.22	204.61	124.54	310.56	200.58	15.64	168.66	119.69	2.12	
296	178.98	72.32	21.07	1.00	2.72	44.06	12.17	8.61	1.01	19.45	0.25	5.38	Mag Phase
			184.66	340.25	218.89	119.02	342.06	202.88	7.10	142.26	91.05	303.77	
297	183.19	73.39	21.81	0.46	3.48	43.88	10.69	8.95	1.68	18.90	2.06	5.56	Mag Phase
			184.75	309.75	200.97	124.60	345.81	204.37	358.79	155.55	152.57	305.27	

Table VI. - Continued

(m) Continued

Run 10

$\mu_{\text{Nom.}} = 0.16$

POINT	MEAN	1/2P-P	1P	2P	3P	4P	5P	6P	7P	8P	9P	10P	
298	203.72	78.67	22.51 188.20	0.10 171.87	4.47 205.28	45.74 127.38	10.20 347.70	8.18 216.59	3.20 5.75	21.14 164.45	4.57 134.57	6.52 311.59	Mag Phase

$\mu_{\text{Nom.}} = 0.20$

POINT	MEAN	1/2P-P	1P	2P	3P	4P	5P	6P	7P	8P	9P	10P	
299	206.01	79.10	31.37 189.68	2.33 51.10	3.86 198.86	44.02 124.12	10.55 359.08	8.47 195.73	4.63 308.21	21.18 148.37	6.85 113.68	6.85 322.92	Mag Phase
300	185.75	75.20	28.00 188.21	2.18 10.65	3.56 185.38	41.50 121.00	11.29 356.18	9.15 190.63	2.04 313.57	19.59 149.59	4.89 129.92	6.16 306.89	Mag Phase
301	202.49	72.42	35.62 186.24	3.84 76.47	3.48 203.63	39.62 137.93	13.98 40.26	7.36 188.67	6.06 342.48	17.29 188.00	5.36 149.92	2.68 295.19	Mag Phase
302	170.57	65.66	26.07 192.14	3.26 1.72	1.40 100.21	33.33 133.78	7.82 3.29	5.99 241.02	1.08 288.73	17.37 168.98	1.85 245.84	2.28 44.80	Mag Phase
303	186.39	73.57	27.45 192.88	2.16 32.52	3.48 191.78	40.73 137.73	10.36 14.61	9.30 213.17	2.34 321.77	19.48 186.58	4.22 163.20	6.71 345.39	Mag Phase
304	191.82	81.85	31.35 187.62	3.71 47.43	2.58 193.46	42.08 134.55	11.89 358.36	9.37 187.65	1.42 270.26	20.72 191.54	7.14 151.03	6.46 2.47	Mag Phase
305	180.24	74.88	26.77 194.68	2.34 27.60	2.31 240.27	44.44 141.61	14.07 20.79	8.36 227.96	0.75 314.14	18.99 181.81	2.91 172.54	6.44 3.41	Mag Phase
306	185.61	76.01	28.57 189.43	1.94 20.96	3.50 182.45	41.46 124.16	10.63 1.85	9.53 197.81	2.66 314.46	19.51 158.84	5.63 132.29	6.18 320.38	Mag Phase

Table VI. - Continued

(m) Continued

Run 10

$\mu_{\text{Nom.}} = 0.20$

POINT	MEAN	1/2P-P	1P	2P	3P	4P	5P	6P	7P	8P	9P	10P	
307	164.13	70.34	27.13 188.06	2.43 5.12	2.40 190.06	38.13 123.18	11.36 357.76	9.50 193.04	1.05 293.99	15.17 163.05	2.35 165.39	5.99 312.72	Mag Phase

$\mu_{\text{Nom.}} = 0.25$

POINT	MEAN	1/2P-P	1P	2P	3P	4P	5P	6P	7P	8P	9P	10P	
308	166.79	67.42	33.60 192.64	5.92 37.05	2.18 139.59	33.44 119.58	8.87 21.80	9.94 193.15	2.53 326.55	16.47 136.73	6.18 146.86	1.73 331.80	Mag Phase
309	186.28	76.77	38.07 197.18	5.89 59.28	3.09 153.80	35.96 126.32	9.16 33.48	9.69 198.77	5.10 325.80	21.02 146.04	7.10 153.08	1.63 65.20	Mag Phase
310	204.84	85.99	51.26 176.55	10.64 71.38	9.78 207.95	42.11 120.81	11.53 29.56	12.22 152.40	1.55 346.42	18.27 127.76	5.74 24.16	10.59 311.19	Mag Phase
311	169.18	60.75	32.56 195.37	7.41 35.33	4.76 97.05	24.32 123.23	1.62 80.79	4.78 203.87	1.40 295.08	13.06 155.41	3.64 213.20	2.83 21.41	Mag Phase
312	185.88	83.01	41.89 191.27	6.20 73.25	2.95 123.76	40.40 114.04	10.86 17.82	10.19 180.93	3.81 311.60	18.73 126.42	7.56 119.78	5.73 39.51	Mag Phase
313	192.51	88.44	48.64 174.26	11.51 56.50	4.11 217.43	39.31 113.26	7.92 35.63	9.07 159.17	3.33 16.66	16.87 130.96	3.63 339.16	9.67 308.46	Mag Phase
314	179.91	75.71	35.03 196.98	5.45 49.36	1.91 171.42	39.48 128.19	7.76 14.37	10.36 212.87	2.52 303.73	17.35 142.34	7.30 145.52	5.51 30.95	Mag Phase
315	185.35	84.98	42.95 191.71	6.91 74.17	2.26 110.47	39.86 120.23	9.53 20.57	10.24 194.80	4.39 327.89	19.10 138.80	7.21 124.66	6.09 44.66	Mag Phase

Table VI. - Continued

(m) Continued

Run 10

$\mu_{\text{Nom.}} = 0.25$

POINT	MEAN	1/2P-P	1P	2P	3P	4P	5P	6P	7P	8P	9P	10P	
316	208.04	97.20	57.32 183.49	11.38 97.97	1.70 58.38	42.44 115.68	12.33 0.33	6.02 163.98	6.59 323.15	18.66 118.62	7.64 63.06	9.79 338.98	Mag Phase

$\mu_{\text{Nom.}} = 0.30$

POINT	MEAN	1/2P-P	1P	2P	3P	4P	5P	6P	7P	8P	9P	10P	
317	211.89	125.89	85.78 212.82	7.06 181.80	13.14 39.41	26.03 15.13	26.92 270.16	2.46 37.58	3.89 109.95	9.40 179.52	7.01 177.84	12.76 221.77	Mag Phase
318	192.79	116.03	75.13 202.09	8.79 112.79	11.98 50.44	20.41 54.60	20.06 306.20	1.55 77.00	7.70 70.14	8.50 172.50	6.48 125.96	1.14 50.18	Mag Phase
319	210.24	127.21	82.81 209.13	4.84 156.43	9.20 86.11	31.72 47.52	23.12 288.65	6.74 91.76	6.68 98.32	13.44 183.33	9.15 135.25	2.32 227.65	Mag Phase
320	174.75	90.70	59.95 200.13	10.73 92.06	10.76 56.29	16.71 43.17	14.97 256.05	0.36 17.09	5.23 68.88	6.39 178.32	5.72 138.29	2.13 104.84	Mag Phase
321	191.93	110.03	72.65 203.21	9.01 121.80	11.94 51.32	19.03 57.88	17.51 305.22	1.67 80.00	7.12 69.96	8.25 178.83	7.44 128.24	0.25 249.24	Mag Phase
322	198.70	124.80	80.78 202.36	7.19 134.01	10.22 58.62	23.96 40.19	20.52 279.58	5.09 51.31	7.05 84.84	11.47 143.32	6.57 105.94	1.34 132.91	Mag Phase
323	185.44	93.94	64.23 204.53	8.75 101.50	11.70 36.54	17.26 84.49	9.83 286.57	3.40 224.12	4.06 56.74	7.74 210.96	8.63 160.31	3.28 179.14	Mag Phase
324	191.48	113.47	73.38 205.20	7.97 118.99	12.79 55.85	18.47 62.27	20.47 309.46	0.98 68.35	6.52 70.75	10.07 186.05	8.79 149.25	1.83 194.85	Mag Phase

Table VI. - Continued

(m) Continued

Run 10

$\mu_{Nom.} = 0.30$

POINT	MEAN	1/2P-P	1P	2P	3P	4P	5P	6P	7P	8P	9P	10P	
325	170.50	93.98	61.16	10.67	11.01	17.19	12.22	0.87	6.42	6.96	3.39	3.10	Mag Phase
			198.78	89.03	55.98	82.66	325.07	308.19	44.08	172.91	106.37	65.40	

$\mu_{Nom.} = 0.325$

POINT	MEAN	1/2P-P	1P	2P	3P	4P	5P	6P	7P	8P	9P	10P	
326	169.94	118.15	80.50	4.27	15.42	19.06	19.45	3.71	9.08	3.86	6.06	7.12	Mag Phase
			209.76	131.74	33.93	39.93	275.47	306.59	69.07	185.17	150.85	212.86	
327	192.26	138.48	91.48	6.19	14.51	25.70	26.79	1.94	6.31	2.63	5.73	12.37	Mag Phase
			213.85	201.86	22.28	22.99	271.01	300.42	92.45	215.32	194.70	238.87	
328	212.47	179.32	100.61	9.63	15.02	40.42	48.09	6.79	6.14	5.41	7.22	24.24	Mag Phase
			224.53	244.09	21.06	16.85	261.31	112.65	211.58	348.54	53.64	264.83	

$\mu_{Nom.} = 0.275$

POINT	MEAN	1/2P-P	1P	2P	3P	4P	5P	6P	7P	8P	9P	10P	
329	210.46	123.78	69.81	11.75	9.28	33.19	13.03	3.64	4.55	17.85	10.80	10.54	Mag Phase
			194.65	120.02	56.66	82.78	308.93	96.13	16.03	91.37	44.19	343.52	
330	189.33	92.65	58.42	14.53	3.49	34.48	10.00	3.52	4.89	8.58	4.30	8.51	Mag Phase
			185.99	97.54	42.71	96.55	333.78	176.24	323.43	89.85	43.12	329.70	
331	208.26	103.79	72.72	11.64	6.57	32.84	8.46	7.42	3.05	10.71	6.70	6.77	Mag Phase
			191.33	106.11	134.61	87.55	307.68	118.76	344.72	99.43	56.65	306.37	
332	169.99	62.09	38.51	10.00	7.96	20.35	3.18	3.88	0.25	6.28	1.57	5.47	Mag Phase
			200.25	54.45	97.42	109.74	195.79	214.35	204.08	158.90	218.36	325.32	

Table VI. - Continued

(m) Continued

Run 10

 $\mu_{\text{Nom.}} = 0.275$ 

POINT	MEAN	1/2P-P	1P	2P	3P	4P	5P	6P	7P	8P	9P	10P	
333	189.30	92.54	59.18 185.44	15.34 93.93	3.07 47.64	33.98 98.87	10.93 346.20	2.65 181.85	6.16 327.10	10.29 91.36	4.91 52.03	8.23 328.15	Mag Phase
334	195.89	90.39	66.87 181.65	15.62 84.12	2.29 105.31	35.32 84.68	6.12 355.21	4.46 115.32	1.40 330.12	8.60 88.21	2.52 317.17	5.23 276.74	Mag Phase
335	181.92	72.48	43.64 198.55	8.14 81.94	6.23 101.79	32.16 128.44	7.74 78.34	8.18 221.67	3.43 281.49	5.07 167.99	4.38 188.04	4.46 45.97	Mag Phase
336	189.33	93.53	61.01 188.47	15.23 101.74	4.53 67.24	34.06 105.44	11.04 10.07	2.53 181.76	5.91 335.38	10.04 103.16	4.85 73.42	7.19 352.85	Mag Phase
337	168.71	79.51	46.94 191.65	10.93 78.59	6.48 87.81	31.98 106.11	6.93 18.45	8.71 190.73	2.74 321.27	10.16 136.89	5.34 117.77	3.61 39.94	Mag Phase

 $\mu_{\text{Nom.}} = 0.225$ 

POINT	MEAN	1/2P-P	1P	2P	3P	4P	5P	6P	7P	8P	9P	10P	
338	208.18	83.66	43.46 190.01	5.04 103.37	3.95 185.90	42.17 123.37	14.21 7.87	10.30 176.09	4.40 319.38	19.34 146.18	10.00 118.74	4.87 28.59	Mag Phase
339	187.60	71.71	33.40 195.03	3.80 44.06	4.26 190.09	35.92 129.90	11.03 16.79	10.55 193.92	2.06 347.34	19.98 167.22	8.10 162.98	2.74 348.31	Mag Phase
340	205.98	84.12	47.93 172.16	9.78 66.62	14.84 209.42	37.36 125.22	13.41 21.24	11.16 150.98	3.31 348.24	6.28 125.25	0.95 238.14	3.27 279.87	Mag Phase
341	171.83	63.08	31.80 192.96	3.50 36.54	2.74 124.24	30.68 129.06	5.21 14.39	4.74 200.37	1.08 297.43	15.21 156.51	2.24 243.86	1.98 22.78	Mag Phase

Table VI. - Continued

(m) Concluded

Run 10

 $\mu_{\text{Nom.}} = 0.225$ 

POINT	MEAN	1/2P-P	1P	2P	3P	4P	5P	6P	7P	8P	9P	10P	
342	188.07	75.98	37.39 191.41	3.18 65.38	5.04 181.95	40.43 125.36	12.87 1.48	9.16 184.25	2.83 332.09	19.89 142.78	10.10 124.34	2.52 38.09	Mag Phase
343	194.81	84.37	46.96 176.24	8.65 70.42	4.76 233.23	38.12 116.06	9.56 10.93	10.47 160.94	3.80 335.39	15.23 127.00	5.38 77.77	7.84 337.98	Mag Phase
344	180.44	77.65	32.78 196.06	2.94 52.92	2.40 211.68	41.69 130.27	12.11 2.52	8.43 211.86	0.28 295.39	22.04 151.52	4.40 149.38	4.82 8.34	Mag Phase
345	188.87	75.11	37.46 192.62	3.35 65.79	4.56 189.73	39.23 123.12	11.39 7.35	9.53 187.54	2.62 329.29	18.37 142.25	9.20 132.59	2.61 42.97	Mag Phase
346	167.21	70.18	33.18 192.10	3.71 45.08	2.79 188.10	35.51 122.89	12.17 8.87	9.47 191.99	1.63 353.37	16.68 158.99	6.31 155.85	1.98 330.62	Mag Phase



Table VI. - Continued

(n) Fixed-system strain-gage balance axial force, lbs.

Run 10

$\mu_{Nom.} = 0.08$

POINT	MEAN	1/2P-P	1P	2P	3P	4P	5P	6P	7P	8P	9P	10P	
281	0.38	31.70	3.22 210.56	1.67 59.62	9.62 210.94	15.17 141.75	0.79 331.34	10.35 355.58	2.56 126.85	5.23 148.40	3.13 50.95	3.13 71.28	Mag Phase
282	0.60	30.39	2.47 199.00	1.44 51.21	10.27 218.97	14.49 134.36	0.69 298.77	10.53 348.70	2.41 86.17	4.87 165.04	2.57 26.12	1.74 58.38	Mag Phase
283	0.68	30.96	2.18 192.76	1.27 56.18	11.47 220.99	13.40 134.53	0.30 348.82	9.47 346.75	2.99 121.77	5.29 175.44	3.17 9.37	2.12 67.80	Mag Phase

$\mu_{Nom.} = 0.11$

POINT	MEAN	1/2P-P	1P	2P	3P	4P	5P	6P	7P	8P	9P	10P	
284	1.60	28.51	1.96 192.56	1.07 53.99	12.71 220.91	11.76 134.19	0.74 148.85	9.46 350.19	4.22 33.36	4.43 160.84	3.33 15.63	2.44 111.98	Mag Phase
285	1.18	31.87	2.43 203.33	1.19 54.37	12.96 220.34	13.18 132.22	0.40 153.53	11.06 347.09	3.25 51.38	5.47 150.16	3.56 26.08	3.09 86.11	Mag Phase
286	1.35	35.85	3.10 215.20	1.44 65.78	13.98 233.27	14.51 145.62	0.53 294.45	11.31 6.09	2.91 103.63	6.09 162.34	4.98 70.77	4.96 112.39	Mag Phase

$\mu_{Nom.} = 0.13$

POINT	MEAN	1/2P-P	1P	2P	3P	4P	5P	6P	7P	8P	9P	10P	
287	1.81	33.55	3.12 215.56	1.40 61.99	14.39 224.01	13.35 138.77	0.75 161.64	9.78 359.56	4.08 73.65	4.50 160.70	3.99 43.31	4.36 93.92	Mag Phase
288	2.12	30.16	2.56 207.00	1.05 68.08	14.83 229.29	12.46 150.33	1.07 177.52	9.28 5.47	3.53 87.52	4.17 191.24	3.12 33.27	3.70 133.44	Mag Phase

Table VI. - Continued

(n) Continued

Run 10

 $\mu_{\text{Nom.}} = 0.13$ 

POINT	MEAN	1/2P-P	1P	2P	3P	4P	5P	6P	7P	8P	9P	10P	
289	2.23	27.65	1.88 191.83	0.96 57.09	13.32 224.82	11.10 138.23	0.79 157.93	8.48 353.01	2.99 53.71	3.35 185.51	3.29 347.77	2.82 103.14	Mag Phase

 $\mu_{\text{Nom.}} = 0.16$ 

POINT	MEAN	1/2P-P	1P	2P	3P	4P	5P	6P	7P	8P	9P	10P	
290	-1.03	29.92	2.25 192.02	1.26 66.15	9.52 236.02	12.06 143.87	1.68 187.06	11.05 2.37	1.33 17.19	3.15 200.62	1.98 15.11	4.73 112.19	Mag Phase
291	-1.35	33.29	2.80 199.44	1.35 67.17	11.19 230.92	12.81 140.16	1.32 176.64	11.33 352.65	0.85 51.50	4.31 182.12	2.96 27.40	6.09 96.68	Mag Phase
292	3.25	27.00	3.38 200.19	1.81 55.46	14.19 237.91	10.01 144.25	2.63 208.64	7.43 44.62	0.94 52.83	1.87 193.70	0.94 341.49	2.35 22.95	Mag Phase
293	-5.07	25.91	2.47 197.85	0.68 70.12	2.83 120.94	11.56 148.78	0.49 197.54	10.87 38.28	3.26 36.02	3.69 165.24	1.72 36.63	3.76 168.01	Mag Phase
294	-1.17	32.28	2.77 200.72	1.19 58.17	10.83 235.47	12.92 142.76	1.24 160.77	11.66 0.05	2.37 53.11	4.12 179.36	2.33 30.24	5.39 117.95	Mag Phase
295	0.73	33.90	2.78 196.89	1.32 79.84	8.44 235.95	12.50 145.26	1.28 59.49	14.69 359.77	1.85 321.99	1.82 181.42	1.04 128.29	4.87 136.88	Mag Phase
296	-2.86	30.23	2.44 199.38	1.29 47.86	8.44 252.41	13.23 137.44	1.85 157.79	10.92 0.79	4.41 41.56	5.43 148.46	1.41 49.62	4.87 98.38	Mag Phase
297	-1.16	32.91	2.68 201.69	1.10 63.19	9.86 234.68	13.04 142.26	1.31 154.26	12.53 1.82	2.36 36.50	3.48 180.00	2.34 27.48	6.13 112.08	Mag Phase

Table VI. - Continued

(n) Continued

Run 10

 $\mu_{\text{Nom.}} = 0.16$ 

POINT	MEAN	1/2P-P	1P	2P	3P	4P	5P	6P	7P	8P	9P	10P	
298	-1.52	34.41	3.58 211.94	1.49 72.72	12.38 241.13	13.78 147.19	0.73 167.33	10.48 9.14	1.62 116.39	3.82 198.82	3.67 60.94	7.49 112.47	Mag Phase

 $\mu_{\text{Nom.}} = 0.20$ 

POINT	MEAN	1/2P-P	1P	2P	3P	4P	5P	6P	7P	8P	9P	10P	
299	-4.45	30.37	4.95 207.83	1.86 88.58	10.55 252.32	12.85 144.73	0.56 219.36	11.33 1.82	1.88 78.71	4.56 166.48	2.89 33.92	4.37 120.85	Mag Phase
300	-3.59	31.23	3.63 198.65	0.84 48.32	8.72 248.96	12.41 139.83	0.56 199.09	12.21 353.50	0.89 339.65	3.56 161.41	1.78 8.06	5.95 123.70	Mag Phase
301	0.71	30.25	4.94 205.05	3.04 53.64	16.41 253.15	12.00 158.91	1.99 280.50	8.26 12.75	4.76 67.98	4.81 172.20	2.95 39.32	3.16 7.72	Mag Phase
302	-7.60	20.77	3.19 201.87	0.24 332.86	2.37 59.41	9.81 149.05	0.51 280.34	7.57 36.37	3.37 3.70	3.62 160.40	0.90 46.47	3.52 188.23	Mag Phase
303	-3.91	31.97	3.53 204.95	1.16 33.23	9.16 255.28	12.30 156.64	0.18 194.21	12.83 18.26	1.91 28.70	4.17 203.73	1.81 34.92	5.50 167.47	Mag Phase
304	-1.74	33.46	4.05 199.80	2.13 71.08	8.71 258.16	12.10 158.37	0.45 84.53	12.28 3.68	1.98 303.54	3.71 184.76	1.09 34.12	4.16 166.11	Mag Phase
305	-5.61	28.30	3.41 208.93	0.67 38.91	8.12 293.01	13.26 160.61	1.55 191.76	10.57 29.31	3.95 64.16	5.47 185.20	0.88 71.38	5.10 174.23	Mag Phase
306	-3.74	31.29	3.87 203.44	0.88 45.05	8.68 249.78	12.55 142.97	0.57 206.06	12.66 3.38	1.97 339.70	4.07 172.61	2.52 2.44	5.18 137.64	Mag Phase

Table VI. - Continued

(n) Continued

Run 10

 $\mu_{\text{Nom.}} = 0.20$ 

POINT	MEAN	1/2P-P	1P	2P	3P	4P	5P	6P	7P	8P	9P	10P	
307	-3.30	28.62	2.89 191.03	0.74 13.13	6.33 244.32	11.65 138.42	0.96 167.29	12.14 357.76	2.10 321.77	3.92 179.73	2.40 320.66	4.62 133.48	Mag Phase

 $\mu_{\text{Nom.}} = 0.25$ 

POINT	MEAN	1/2P-P	1P	2P	3P	4P	5P	6P	7P	8P	9P	10P	
308	-6.27	25.22	4.85 202.10	1.20 358.68	6.29 254.84	9.73 135.58	2.12 281.82	9.71 351.36	2.15 312.09	3.77 142.35	2.86 351.79	2.81 79.03	Mag Phase
309	-6.75	25.07	6.57 211.70	1.27 82.78	9.05 247.12	10.40 146.48	2.89 303.51	8.64 356.09	2.33 13.85	4.80 137.44	3.61 43.28	3.67 66.93	Mag Phase
310	-2.70	50.89	9.03 193.16	7.92 346.29	32.72 226.43	9.52 148.91	3.44 298.95	7.30 296.57	10.09 25.77	3.84 102.77	2.52 1.78	4.18 194.52	Mag Phase
311	-10.15	20.12	5.40 211.29	1.19 327.74	7.22 132.85	7.17 140.72	3.59 330.24	4.20 353.58	5.33 7.26	3.00 129.05	1.19 49.91	0.89 114.69	Mag Phase
312	-6.80	27.70	7.06 205.45	4.50 59.36	5.61 257.40	11.27 137.50	3.01 291.68	8.63 343.09	1.31 14.45	3.10 117.00	3.42 12.78	1.46 54.44	Mag Phase
313	-5.22	35.96	8.37 193.26	9.28 349.87	15.22 234.22	10.49 145.87	5.08 293.46	5.78 312.07	6.99 17.47	0.88 48.64	2.56 359.72	6.70 169.36	Mag Phase
314	-8.81	24.75	5.76 210.61	1.24 36.19	5.72 243.96	11.45 145.82	1.35 337.54	10.70 15.13	5.19 1.78	3.85 137.75	3.69 39.53	4.53 122.75	Mag Phase
315	-7.07	28.72	7.11 204.49	4.83 56.65	6.95 267.79	10.98 144.28	3.03 301.17	8.75 356.92	2.13 15.69	3.59 135.31	3.15 25.27	0.97 57.72	Mag Phase

Table VI. - Continued

(n) Continued

Run 10

$\mu_{Nom.} = 0.25$

POINT	MEAN	1/2P-P	1P	2P	3P	4P	5P	6P	7P	8P	9P	10P	
316	-8.02	35.42	11.27 204.60	10.59 27.77	13.53 251.64	10.53 145.34	2.49 291.56	2.97 320.72	6.17 80.48	5.04 96.93	5.86 28.48	2.38 309.21	Mag Phase

$\mu_{Nom.} = 0.30$

POINT	MEAN	1/2P-P	1P	2P	3P	4P	5P	6P	7P	8P	9P	10P	
317	-13.14	64.25	21.43 228.26	9.46 127.01	34.51 12.54	8.71 114.44	5.92 35.54	12.19 204.12	9.54 173.71	1.87 154.21	1.42 124.41	5.92 87.86	Mag Phase
318	-11.47	39.31	17.62 218.63	5.25 84.40	18.64 14.82	9.68 116.70	2.92 58.14	5.23 209.54	5.07 115.63	1.55 218.29	1.84 320.29	4.99 33.52	Mag Phase
319	-7.84	47.46	20.38 225.31	5.03 131.97	16.69 7.95	10.63 117.32	6.33 54.44	12.09 229.02	4.31 164.31	2.31 93.84	1.82 53.83	3.50 58.69	Mag Phase
320	-15.01	33.42	13.66 215.77	5.98 76.16	10.57 72.59	5.39 118.21	5.70 353.60	6.13 202.72	4.04 122.50	1.49 243.49	0.64 76.17	4.75 347.38	Mag Phase
321	-11.71	40.30	17.13 219.25	5.89 88.20	18.17 18.56	9.08 114.69	2.44 53.00	5.94 208.61	5.48 125.29	1.17 198.01	2.29 342.40	5.30 40.66	Mag Phase
322	-9.49	46.93	19.26 219.14	5.23 115.78	19.23 356.78	10.42 109.64	5.08 39.43	8.11 202.30	4.43 109.35	1.33 44.33	1.98 47.06	7.27 12.86	Mag Phase
323	-13.23	35.27	14.77 217.02	5.01 92.05	17.03 16.12	8.25 121.48	4.07 343.97	3.29 216.14	3.50 114.18	2.01 239.91	1.17 29.58	3.50 46.42	Mag Phase
324	-11.76	43.04	17.24 220.76	5.78 102.42	19.22 22.38	9.51 121.60	2.36 91.41	6.38 211.72	7.63 115.58	1.80 152.59	1.81 337.60	6.45 59.49	Mag Phase

Table VI. - Continued

(n) Continued

Run 10

$\mu_{Nom.} = 0.30$

POINT	MEAN	1/2P-P	1P	2P	3P	4P	5P	6P	7P	8P	9P	10P	
325	-10.52	31.12	13.25 214.46	4.63 57.84	11.47 44.60	8.57 132.21	2.23 350.15	3.20 195.09	2.60 128.67	1.24 103.32	0.82 221.14	4.81 9.13	Mag Phase

$\mu_{Nom.} = 0.325$

POINT	MEAN	1/2P-P	1P	2P	3P	4P	5P	6P	7P	8P	9P	10P	
326	-13.36	57.04	18.82 220.63	5.85 129.05	26.73 10.58	2.52 114.31	3.55 0.97	8.86 194.00	14.26 134.47	3.67 231.29	4.04 340.28	5.94 57.20	Mag Phase
327	-14.63	70.40	22.84 224.24	9.23 140.92	35.64 3.71	3.40 89.84	4.66 16.49	12.81 204.81	16.18 162.86	3.99 247.24	2.62 333.42	4.73 81.07	Mag Phase
328	-17.13	94.77	26.83 236.81	13.16 154.50	44.87 10.05	3.34 65.75	12.41 30.02	27.13 245.63	11.53 249.50	6.54 216.87	0.40 159.31	3.64 73.37	Mag Phase

$\mu_{Nom.} = 0.275$

POINT	MEAN	1/2P-P	1P	2P	3P	4P	5P	6P	7P	8P	9P	10P	
329	-9.91	35.91	16.72 216.07	7.46 37.70	12.34 342.18	8.93 100.99	2.09 354.85	5.38 241.43	1.98 9.89	4.81 54.75	3.01 343.10	5.16 317.01	Mag Phase
330	-8.46	30.31	12.24 205.19	8.35 10.83	6.35 256.41	8.91 123.29	3.54 311.40	4.87 340.13	3.39 79.28	1.59 71.52	3.66 7.93	2.63 226.47	Mag Phase
331	-4.20	43.72	16.07 212.21	5.57 1.27	19.79 250.77	10.22 104.89	3.55 337.55	8.99 277.38	0.52 294.15	3.93 64.83	0.68 325.35	2.15 323.08	Mag Phase
332	-12.15	29.84	7.90 220.39	0.83 153.55	15.43 108.29	5.30 113.56	4.92 335.24	3.02 322.65	3.59 335.37	0.50 153.95	2.98 45.45	1.59 57.92	Mag Phase

Table VI. - Continued

(n) Continued

Run 10

$\mu_{Nom.} = 0.275$

POINT	MEAN	1/2P-P	1P	2P	3P	4P	5P	6P	7P	8P	9P	10P	
333	-8.42	29.93	12.24 205.23	9.06 14.67	7.05 261.20	8.76 124.76	3.76 304.82	3.23 332.22	4.99 87.10	2.12 63.20	3.27 19.16	2.79 231.67	Mag Phase
334	-6.54	42.28	14.24 204.37	7.80 349.39	17.90 246.55	8.51 105.26	4.43 301.00	7.16 247.42	5.13 80.59	2.04 334.19	3.09 353.00	1.70 220.52	Mag Phase
335	-10.69	29.43	9.19 218.17	3.83 85.04	10.45 81.21	8.01 138.87	4.70 315.94	5.03 355.42	4.61 332.71	0.80 229.57	2.84 22.59	0.64 114.26	Mag Phase
336	-8.58	29.08	12.65 208.28	9.48 16.70	3.11 250.42	9.09 131.03	3.32 298.00	2.99 346.86	4.59 99.55	2.59 58.66	2.35 22.74	2.70 264.53	Mag Phase
337	-7.58	23.94	8.79 205.97	5.62 34.87	4.28 86.66	8.17 123.61	3.95 299.85	6.70 347.94	1.63 341.44	1.43 143.11	2.47 356.43	2.37 339.93	Mag Phase

$\mu_{Nom.} = 0.225$

POINT	MEAN	1/2P-P	1P	2P	3P	4P	5P	6P	7P	8P	9P	10P	
338	-5.39	33.00	8.31 210.06	6.51 61.40	8.55 266.83	11.64 144.70	1.53 280.32	9.29 338.99	1.66 68.79	4.27 156.33	4.45 26.54	3.02 49.63	Mag Phase
339	-4.63	25.42	5.29 210.37	0.30 13.33	6.49 232.25	10.85 147.97	1.96 297.05	10.92 357.89	2.69 348.22	4.69 168.37	2.40 358.76	2.51 148.86	Mag Phase
340	-0.33	49.25	7.65 189.37	8.13 333.16	33.19 220.15	9.95 147.34	3.38 266.05	6.59 324.29	9.53 13.67	0.46 53.58	2.07 351.07	2.27 277.61	Mag Phase
341	-8.81	21.58	4.83 205.28	1.05 335.50	3.46 141.26	9.05 140.86	1.27 322.46	5.23 2.13	4.33 9.59	3.25 153.47	2.19 0.67	1.66 168.09	Mag Phase

Table VI. - Continued

(n) Concluded

Run 10

$\mu_{Nom.} = 0.225$

POINT	MEAN	1/2P-P	1P	2P	3P	4P	5P	6P	7P	8P	9P	10P	
342	-5.26	26.40	5.88 206.48	1.62 73.41	6.52 216.05	11.72 141.49	1.32 289.21	9.99 345.19	2.97 332.17	4.53 155.93	4.21 359.73	2.43 96.22	Mag Phase
343	-2.91	34.61	7.45 190.95	8.23 354.80	16.19 248.10	10.94 142.45	3.69 295.90	9.06 325.29	5.81 10.57	1.19 47.34	4.16 0.35	3.17 189.81	Mag Phase
344	-7.23	26.60	5.09 208.68	0.55 310.09	5.82 269.41	12.36 145.20	0.49 258.87	9.54 12.96	3.99 350.18	5.48 148.35	1.50 33.57	3.64 152.96	Mag Phase
345	-5.13	25.68	6.00 206.91	1.88 89.97	7.16 230.95	11.44 139.06	1.27 289.09	9.99 349.94	3.16 332.84	3.82 151.14	3.60 349.21	1.14 89.04	Mag Phase
346	-4.53	24.30	4.38 199.88	0.37 280.96	5.32 233.79	10.53 137.06	1.35 248.22	10.25 354.97	2.87 306.72	3.63 167.31	3.19 330.36	2.29 131.36	Mag Phase



Table VI. - Continued

(o) Fixed-system strain-gage balance pitching moment, in-lbs

Run 10

$\mu_{Nom.} = 0.08$

POINT	MEAN	1/2P-P	1P	2P	3P	4P	5P	6P	7P	8P	9P	10P	
281	69.39	984.50	184.64	42.11	310.57	719.16	5.51	26.52	9.34	37.09	21.78	12.52	Mag Phase
			221.85	47.82	214.99	141.36	234.65	339.56	142.51	291.49	30.53	82.43	
282	58.81	1004.88	135.30	36.08	321.20	712.89	3.46	21.55	6.43	37.27	22.96	11.05	Mag Phase
			204.21	32.66	223.44	135.41	198.35	334.01	109.70	316.85	50.51	84.63	
283	42.45	1006.21	122.90	32.04	361.12	670.28	4.51	19.53	7.90	29.63	23.58	11.00	Mag Phase
			195.29	29.51	225.27	136.81	227.21	334.83	108.10	327.29	54.00	89.47	

$\mu_{Nom.} = 0.11$

POINT	MEAN	1/2P-P	1P	2P	3P	4P	5P	6P	7P	8P	9P	10P	
284	34.58	991.25	119.37	25.57	404.45	614.28	1.38	19.08	7.24	36.53	21.57	5.57	Mag Phase
			198.44	17.60	225.23	136.01	14.34	335.86	58.35	308.20	49.69	115.45	
285	32.61	1057.31	143.95	27.90	415.03	683.89	2.68	22.35	8.44	49.04	24.27	8.61	Mag Phase
			212.48	30.47	224.77	133.60	99.39	330.67	88.81	292.37	32.05	85.58	
286	52.67	1123.25	187.65	33.54	450.50	730.50	5.69	28.42	12.43	57.98	18.05	13.36	Mag Phase
			227.64	54.75	236.91	146.95	133.19	351.09	131.83	308.21	41.45	97.76	

$\mu_{Nom.} = 0.13$

POINT	MEAN	1/2P-P	1P	2P	3P	4P	5P	6P	7P	8P	9P	10P	
287	44.93	1098.61	191.60	31.37	464.17	695.50	7.30	22.40	14.91	50.64	16.35	11.21	Mag Phase
			223.47	43.45	227.00	138.09	15.60	339.53	114.05	299.32	27.09	104.07	
288	48.16	1090.39	158.44	24.06	480.85	662.73	11.62	19.24	11.74	41.54	22.10	8.93	Mag Phase
			214.05	36.55	232.09	150.83	34.42	354.69	119.98	336.87	65.79	151.21	

Table VI. - Continued

(o) Continued

Run 10

$\mu_{\text{Nom.}} = 0.13$

POINT	MEAN	1/2P-P	1P	2P	3P	4P	5P	6P	7P	8P	9P	10P	
289	40.30	996.73	128.01	27.12	430.56	590.94	6.47	16.45	9.62	29.37	20.23	6.90	Mag Phase
			196.79	11.98	227.53	139.74	17.14	344.07	96.68	319.26	51.85	125.15	

$\mu_{\text{Nom.}} = 0.16$

POINT	MEAN	1/2P-P	1P	2P	3P	4P	5P	6P	7P	8P	9P	10P	
290	16.15	936.05	145.13	28.27	298.59	636.57	17.39	18.84	4.21	29.29	14.37	18.81	Mag Phase
			197.12	40.56	237.71	144.45	31.92	349.37	85.07	318.12	76.18	137.68	
291	14.23	1004.60	176.15	30.45	356.57	668.93	19.24	21.91	6.31	38.58	12.38	15.57	Mag Phase
			207.50	50.37	233.26	140.02	20.23	339.52	105.30	302.40	50.31	120.25	
292	254.40	941.14	265.93	29.95	424.76	498.43	30.08	18.60	13.04	24.99	21.68	4.09	Mag Phase
			200.89	46.93	242.75	147.81	49.30	28.10	113.35	341.16	5.94	254.24	
293	-192.06	833.25	153.36	16.98	96.87	635.84	11.80	18.76	9.88	35.21	9.35	17.74	Mag Phase
			202.07	52.70	124.58	149.74	26.27	29.69	101.23	305.92	80.36	217.28	
294	14.98	1002.54	174.02	26.49	341.22	675.69	20.70	21.90	8.24	38.83	13.78	14.01	Mag Phase
			207.77	38.39	237.89	141.63	15.27	348.38	99.87	308.83	58.42	144.62	
295	106.80	922.51	181.80	32.44	266.72	642.76	17.81	30.54	4.59	26.52	7.29	11.50	Mag Phase
			203.20	85.59	238.35	142.65	329.42	350.51	12.78	315.92	277.75	207.98	
296	-66.91	1007.56	155.93	38.16	264.12	690.81	22.99	17.48	4.95	37.80	11.27	16.82	Mag Phase
			204.39	20.07	255.50	136.60	14.79	353.62	99.50	281.90	72.31	124.04	
297	13.84	984.68	172.18	22.06	312.52	684.56	19.97	22.60	5.71	36.62	10.33	14.48	Mag Phase
			207.71	41.03	236.86	141.42	18.06	348.51	72.26	306.37	49.24	141.94	

Table VI. - Continued

(o) Continued

Run 10

 $\mu_{\text{Nom.}} = 0.16$ 

POINT	MEAN	1/2P-P	1P	2P	3P	4P	5P	6P	7P	8P	9P	10P	
298	15.72	1104.34	223.94	31.80	398.97	699.47	14.86	22.49	10.22	41.22	2.58	17.10	Mag Phase
			221.53	62.80	243.44	146.18	23.54	354.35	134.13	313.68	46.21	133.95	

 $\mu_{\text{Nom.}} = 0.20$ 

POINT	MEAN	1/2P-P	1P	2P	3P	4P	5P	6P	7P	8P	9P	10P	
299	-12.20	1087.89	325.00	29.62	333.58	657.70	15.36	25.74	17.94	44.02	8.15	7.86	Mag Phase
			216.51	105.98	256.60	141.89	38.02	351.69	98.79	289.28	278.41	156.23	
300	-18.35	961.18	222.12	19.39	272.84	631.85	16.32	21.68	9.88	40.38	7.64	10.16	Mag Phase
			209.51	9.91	253.00	137.89	37.47	339.44	75.82	296.58	304.28	165.80	
301	211.91	1153.99	364.43	50.32	487.53	592.05	23.36	21.37	16.44	35.15	10.67	11.37	Mag Phase
			202.26	60.98	260.40	157.71	75.71	6.19	133.39	327.35	29.42	42.63	
302	-236.33	751.23	191.20	14.05	77.78	528.79	12.44	10.53	8.30	31.67	7.56	13.82	Mag Phase
			210.67	303.25	62.46	149.84	52.22	32.14	104.41	313.23	72.23	230.52	
303	-25.03	950.61	213.72	34.12	284.08	627.53	11.81	22.54	9.34	41.32	5.57	9.25	Mag Phase
			212.01	10.77	259.87	154.93	49.75	4.73	97.01	330.50	5.98	200.14	
304	60.39	1003.13	274.38	48.82	262.86	622.68	23.49	25.89	6.07	33.21	15.79	10.26	Mag Phase
			201.72	86.13	264.26	153.36	13.48	356.58	65.23	330.17	299.47	232.89	
305	-122.20	1015.67	195.94	23.11	254.03	681.32	23.06	15.92	7.75	37.80	5.48	15.77	Mag Phase
			214.34	359.77	298.19	158.21	58.33	21.69	102.80	321.82	82.17	193.28	
306	-39.85	958.92	232.52	20.73	271.21	636.25	13.85	21.93	9.88	39.97	7.63	9.44	Mag Phase
			209.27	1.04	253.75	141.11	53.09	350.97	82.57	304.77	321.73	185.81	

Table VI. - Continued

(o) Continued

Run 10

$\mu_{\text{Nom.}} = 0.20$

POINT	MEAN	1/2P-P	1P	2P	3P	4P	5P	6P	7P	8P	9P	10P	
307	-37.42	826.80	181.36	27.03	195.57	594.10	18.00	20.02	7.55	32.96	8.94	11.00	Mag Phase
			197.85	336.81	248.79	138.34	36.54	341.90	58.38	309.20	3.60	166.13	

$\mu_{\text{Nom.}} = 0.25$

POINT	MEAN	1/2P-P	1P	2P	3P	4P	5P	6P	7P	8P	9P	10P	
308	-20.15	767.84	275.68	37.76	192.75	489.54	18.01	16.94	7.05	29.13	14.73	4.52	Mag Phase
			211.32	337.91	261.23	138.09	87.67	336.65	93.65	285.87	310.20	212.05	
309	-10.62	925.57	404.13	1.85	275.04	517.56	16.60	21.75	16.49	36.03	15.54	4.09	Mag Phase
			220.38	134.88	254.43	147.12	99.48	356.63	106.79	286.02	323.31	216.92	
310	214.87	1625.15	613.83	133.62	980.84	491.13	38.01	38.45	15.74	38.30	8.44	17.79	Mag Phase
			186.94	19.37	234.36	144.81	329.04	314.33	50.21	257.07	144.02	86.64	
311	-213.02	788.56	297.50	42.86	215.63	372.68	13.60	9.88	9.86	16.26	7.00	2.80	Mag Phase
			221.46	324.20	133.04	144.81	136.83	350.79	73.03	301.32	22.95	209.98	
312	-0.95	948.07	461.23	72.19	161.72	550.66	18.77	26.90	20.69	30.63	17.14	13.15	Mag Phase
			209.80	84.35	267.74	135.44	53.54	338.29	93.86	258.93	272.39	208.78	
313	102.09	1221.26	542.82	190.56	462.62	497.22	30.81	30.48	9.44	29.11	9.82	15.08	Mag Phase
			185.19	26.26	247.34	139.61	290.62	314.40	94.83	249.62	102.06	107.46	
314	-79.46	860.47	330.57	38.69	185.93	566.84	12.23	19.88	13.46	25.93	9.09	13.50	Mag Phase
			221.35	354.67	253.04	146.27	80.96	4.43	87.69	287.07	303.98	197.34	
315	11.35	988.22	467.06	79.85	203.53	537.10	14.65	27.51	17.19	33.28	15.54	11.36	Mag Phase
			207.83	81.71	279.34	141.44	31.20	346.34	92.55	277.59	289.74	214.06	

Table VI. - Continued

(o) Continued

Run 10

$\mu_{\text{Nom.}} = 0.25$

POINT	MEAN	1/2P-P	1P	2P	3P	4P	5P	6P	7P	8P	9P	10P	
316	7.66	1318.59	757.92 202.23	198.53 85.96	354.36 265.99	523.77 142.73	28.50 355.22	37.27 334.46	34.57 120.52	51.73 251.22	13.97 224.99	17.04 124.47	Mag Phase

$\mu_{\text{Nom.}} = 0.30$

POINT	MEAN	1/2P-P	1P	2P	3P	4P	5P	6P	7P	8P	9P	10P	
317	-12.74	2101.33	1323.05 231.77	397.25 184.89	991.56 19.00	286.93 116.86	90.87 289.15	37.62 197.64	32.27 325.33	16.61 9.94	4.65 304.42	8.57 8.64	Mag Phase
318	0.74	1668.46	1092.93 220.16	274.16 169.30	588.65 25.20	349.77 121.22	63.85 283.38	8.21 54.66	10.83 325.66	23.02 356.73	6.62 252.71	2.23 159.77	Mag Phase
319	215.17	1763.98	1273.06 228.92	294.93 189.94	459.89 17.33	398.86 116.06	95.00 299.72	39.83 219.48	36.13 351.10	15.60 29.93	14.08 252.56	7.69 305.71	Mag Phase
320	-216.06	1306.77	818.30 216.77	291.81 163.86	374.65 73.48	236.87 114.12	55.71 271.69	10.81 81.78	19.17 329.46	14.90 12.50	10.78 274.32	5.81 276.39	Mag Phase
321	-10.82	1628.21	1055.39 221.01	291.40 170.28	573.00 28.58	336.39 122.42	51.55 277.24	7.62 80.68	7.95 355.74	13.16 15.43	8.44 256.61	4.86 199.86	Mag Phase
322	83.87	1718.82	1195.46 221.23	311.20 177.27	561.42 7.89	373.94 111.66	80.74 277.97	19.56 188.07	36.37 313.49	23.56 351.70	7.72 236.53	4.33 85.98	Mag Phase
323	-106.41	1432.68	902.76 220.66	238.83 174.33	557.20 23.65	349.20 130.05	41.61 265.54	26.67 56.44	3.55 3.87	13.65 25.12	17.91 332.06	7.52 293.90	Mag Phase
324	-12.21	1676.35	1068.27 223.11	308.24 177.89	604.54 32.31	338.43 128.02	64.11 273.56	7.04 53.35	3.89 45.41	18.25 341.08	11.47 281.83	1.23 242.03	Mag Phase

Table VI. - Continued

(o) Continued

Run 10

$\mu_{Nom.} = 0.30$

POINT	MEAN	1/2P-P	1P	2P	3P	4P	5P	6P	7P	8P	9P	10P	
325	-2.19	1343.52	816.48	197.30	411.21	336.04	31.98	10.71	8.45	12.85	4.94	1.77	Mag Phase
			215.24	170.23	48.90	135.65	305.90	53.45	45.38	337.15	246.20	184.11	

$\mu_{Nom.} = 0.325$

POINT	MEAN	1/2P-P	1P	2P	3P	4P	5P	6P	7P	8P	9P	10P	
326	-20.94	1803.26	1128.47	349.73	803.27	176.76	53.15	43.08	31.65	43.66	4.90	8.49	Mag Phase
			223.05	182.69	20.18	118.28	280.62	151.33	264.52	24.64	259.69	71.59	
327	-22.40	2137.65	1332.69	402.02	1022.43	204.07	88.36	44.92	33.15	39.95	2.51	8.38	Mag Phase
			227.91	191.87	10.15	106.14	275.73	184.43	290.80	20.22	219.01	59.30	
328	-41.18	2415.44	1549.10	490.10	1276.79	228.66	91.63	90.31	82.92	21.18	24.56	28.97	Mag Phase
			240.58	201.50	13.49	87.78	308.19	235.06	359.84	82.49	220.03	80.35	

$\mu_{Nom.} = 0.275$

POINT	MEAN	1/2P-P	1P	2P	3P	4P	5P	6P	7P	8P	9P	10P	
329	4.56	1467.09	1033.47	223.25	383.58	413.04	18.35	22.40	13.79	31.71	22.13	15.15	Mag Phase
			215.79	139.75	358.16	112.25	317.19	300.09	69.33	232.63	204.55	143.63	
330	21.39	1064.23	755.55	159.26	163.90	433.51	32.50	36.41	22.06	26.85	13.98	10.29	Mag Phase
			202.76	103.86	283.81	125.45	316.59	335.09	102.34	211.84	206.70	104.90	
331	259.41	1426.00	1030.62	134.85	493.35	414.13	31.19	40.53	14.94	22.36	13.15	9.10	Mag Phase
			211.29	125.17	253.42	114.32	288.29	321.54	57.68	206.89	241.65	77.87	
332	-205.20	1009.38	423.63	63.03	452.41	300.69	13.14	4.72	6.83	1.63	4.49	8.10	Mag Phase
			227.04	226.84	112.33	130.89	168.67	18.02	93.10	155.81	182.73	87.09	

Table VI. - Continued

(o) Continued

Run 10

$\mu_{Nom.} = 0.275$

POINT	MEAN	1/2P-P	1P	2P	3P	4P	5P	6P	7P	8P	9P	10P	
333	23.25	1086.00	758.07	166.86	186.24	429.83	35.68	33.14	24.92	26.45	15.05	10.48	Mag
			202.73	98.33	287.10	128.03	329.29	338.52	109.32	208.88	209.65	98.50	Phase
334	126.73	1357.70	896.08	136.80	464.83	398.20	31.40	37.61	11.90	18.37	9.89	12.23	Mag
			201.17	87.76	257.65	108.99	309.89	289.37	56.65	172.47	119.22	80.13	Phase
335	-85.06	1141.54	522.66	78.40	313.48	451.17	18.12	17.86	14.98	3.39	4.85	4.84	Mag
			222.81	185.91	83.92	147.56	112.11	24.15	85.97	203.52	330.06	240.73	Phase
336	24.36	1126.00	794.91	166.11	54.35	438.45	28.96	32.29	25.24	28.16	15.03	9.84	Mag
			206.16	105.28	309.49	134.69	346.68	346.10	111.64	219.71	236.49	139.70	Phase
337	23.19	1005.37	512.45	64.16	164.57	426.99	9.08	21.98	14.43	12.27	11.53	3.93	Mag
			208.55	109.47	84.55	127.43	30.85	345.94	84.59	272.70	258.03	247.13	Phase

$\mu_{Nom.} = 0.225$

POINT	MEAN	1/2P-P	1P	2P	3P	4P	5P	6P	7P	8P	9P	10P	
338	-1.59	1077.14	527.14	81.59	251.20	579.22	15.91	36.98	18.24	33.86	17.60	5.94	Mag
			212.12	115.00	271.18	143.96	9.78	342.18	114.15	287.78	277.57	188.94	Phase
339	-13.90	808.01	302.73	29.17	206.06	527.98	15.95	21.44	9.92	35.54	16.57	5.60	Mag
			218.87	319.11	238.78	148.63	93.19	341.63	115.34	313.25	338.26	249.07	Phase
340	222.23	1608.57	543.17	123.05	1035.06	502.99	19.10	32.35	5.97	24.63	5.49	11.77	Mag
			179.34	22.03	226.28	146.92	309.29	301.93	41.61	242.86	43.93	24.12	Phase
341	-234.82	791.19	279.02	41.73	97.71	467.94	6.44	10.22	10.21	20.27	12.50	7.24	Mag
			211.98	330.28	142.08	144.74	85.42	351.44	81.46	308.24	51.35	210.82	Phase

Table VI. - Continued

(o) Concluded

Run 10

$\mu_{Nom.} = 0.225$

POINT	MEAN	1/2P-P	1P	2P	3P	4P	5P	6P	7P	8P	9P	10P	
342	-27.81	900.92	362.87 210.46	8.03 45.38	210.08 220.90	577.86 142.03	18.62 36.37	22.63 334.08	8.65 100.61	36.01 287.82	17.82 295.62	9.68 229.27	Mag Phase
343	79.54	1282.50	506.93 186.05	148.98 51.05	494.00 258.01	519.47 138.51	27.27 291.91	34.88 311.28	8.03 134.54	29.22 249.45	11.43 201.22	14.34 155.91	Mag Phase
344	-128.71	898.09	288.57 216.39	33.51 314.79	183.13 273.97	613.27 145.74	16.71 44.49	14.87 359.15	8.53 112.88	35.78 301.67	6.77 357.46	14.82 186.73	Mag Phase
345	-24.66	907.02	369.75 213.74	6.96 98.98	234.98 235.72	559.06 140.23	11.51 78.80	22.79 336.11	10.82 94.45	31.12 288.72	16.31 298.39	8.63 228.58	Mag Phase
346	-33.92	755.18	263.59 209.31	36.62 304.78	164.48 239.19	517.13 139.06	19.25 54.95	20.07 340.64	8.68 67.17	29.97 310.87	15.75 329.41	6.48 222.06	Mag Phase



Table VI. - Continued

(p) Fixed-system strain-gage balance rolling moment, in-lbs

Run 10

$\mu_{Nom.} = 0.08$

POINT	MEAN	1/2P-P	1P	2P	3P	4P	5P	6P	7P	8P	9P	10P	
281	-120.09	362.88	154.00	80.47	93.27	202.74	30.88	53.67	4.34	40.93	6.64	4.09	Mag
			142.44	146.59	121.84	35.96	212.79	267.46	243.04	252.48	236.55	349.44	Phase
282	-96.48	334.79	110.30	87.04	83.17	197.08	29.30	60.26	5.14	47.95	3.98	3.90	Mag
			127.80	131.61	132.07	27.05	187.58	258.98	237.89	231.18	234.11	1.08	Phase
283	-88.55	333.59	99.43	73.12	92.79	182.66	25.93	57.58	11.70	37.94	3.53	2.89	Mag
			118.22	135.32	117.54	24.91	200.71	264.04	228.85	218.76	191.41	344.54	Phase

$\mu_{Nom.} = 0.11$

POINT	MEAN	1/2P-P	1P	2P	3P	4P	5P	6P	7P	8P	9P	10P	
284	-67.63	268.95	93.36	45.26	94.47	150.48	25.02	55.20	6.81	39.51	3.50	1.56	Mag
			122.44	146.87	135.73	14.80	213.56	264.66	211.10	205.56	144.82	338.44	Phase
285	-71.22	314.03	119.15	44.54	101.05	174.07	22.52	58.70	5.73	46.25	3.61	2.39	Mag
			135.81	146.59	129.80	14.74	211.59	249.50	161.64	214.09	205.77	322.07	Phase
286	-84.18	364.05	159.03	56.05	106.62	189.69	25.90	58.13	11.98	44.64	3.07	5.93	Mag
			151.23	161.29	153.14	30.97	213.56	277.48	154.15	247.91	250.68	345.61	Phase

$\mu_{Nom.} = 0.13$

POINT	MEAN	1/2P-P	1P	2P	3P	4P	5P	6P	7P	8P	9P	10P	
287	-88.66	357.92	160.89	44.85	110.90	186.60	23.87	50.50	8.17	51.70	3.59	2.24	Mag
			150.01	166.24	121.73	30.47	262.46	248.26	169.57	232.20	210.72	314.25	Phase
288	-64.43	318.96	125.23	36.17	109.99	162.81	19.93	49.58	8.17	43.08	2.01	1.35	Mag
			140.14	170.42	120.40	45.57	276.63	262.27	206.93	253.88	201.93	341.34	Phase

Table VI. - Continued

(p) Continued

Run 10

$\mu_{\text{Nom.}} = 0.13$

POINT	MEAN	1/2P-P	1P	2P	3P	4P	5P	6P	7P	8P	9P	10P	
289	-45.61	284.15	89.27	27.25	114.60	137.84	16.75	48.08	12.77	29.82	1.53	0.76	Mag Phase
			122.23	168.35	106.31	35.42	267.47	247.53	236.20	229.96	137.22	341.71	

$\mu_{\text{Nom.}} = 0.16$

POINT	MEAN	1/2P-P	1P	2P	3P	4P	5P	6P	7P	8P	9P	10P	
290	-58.72	260.93	88.98	7.33	37.38	150.50	20.37	52.94	13.37	22.87	2.06	3.17	Mag Phase
			126.90	64.37	97.56	42.49	359.31	254.74	211.22	258.58	340.24	340.96	
291	-81.81	274.15	120.29	3.92	59.08	162.25	17.43	51.81	6.42	28.15	3.66	5.68	Mag Phase
			137.37	211.53	120.70	38.94	8.70	246.45	207.41	231.56	307.56	295.80	
292	-16.64	340.06	142.16	90.70	53.62	136.67	23.77	66.30	20.08	50.53	2.82	1.64	Mag Phase
			143.34	140.68	146.34	23.86	302.60	308.92	214.50	239.89	76.29	83.77	
293	-107.42	259.28	102.02	88.86	67.80	108.08	34.75	55.35	11.12	41.47	2.18	4.86	Mag Phase
			130.75	305.61	340.90	49.28	18.08	261.49	227.41	192.71	268.54	60.74	
294	-75.51	276.21	118.10	9.33	42.83	159.96	24.52	59.11	8.02	36.28	2.60	4.48	Mag Phase
			138.33	356.70	120.94	41.94	350.42	250.13	181.07	227.53	316.80	319.62	
295	160.65	280.93	120.12	48.85	74.53	156.82	37.38	59.52	12.40	23.48	4.23	5.71	Mag Phase
			142.65	98.89	216.41	33.58	298.76	267.22	140.71	203.72	350.63	329.00	
296	-294.34	300.60	99.44	40.94	97.56	142.62	47.79	26.43	13.90	17.83	1.81	4.00	Mag Phase
			135.48	303.72	145.03	52.62	342.87	244.94	346.43	130.92	89.92	311.27	
297	-73.93	274.23	114.81	16.48	34.11	164.38	22.69	60.90	6.86	31.47	2.07	4.51	Mag Phase
			139.57	58.00	147.00	38.65	344.49	254.92	171.20	233.95	330.54	322.15	

Table VI. - Continued

(p) Continued

Run 10

$\mu_{\text{Nom.}} = 0.16$

POINT	MEAN	1/2P-P	1P	2P	3P	4P	5P	6P	7P	8P	9P	10P	
298	-86.71	327.97	165.73	32.90	70.41	183.14	19.18	54.59	13.67	31.70	3.24	8.61	Mag Phase
			152.73	100.59	152.39	40.98	354.33	263.31	172.36	256.49	306.64	311.71	

$\mu_{\text{Nom.}} = 0.20$

POINT	MEAN	1/2P-P	1P	2P	3P	4P	5P	6P	7P	8P	9P	10P	
299	-83.25	357.69	201.16	38.84	80.71	160.43	27.62	40.06	22.95	19.76	3.32	7.75	Mag Phase
			148.59	343.24	180.87	42.17	46.68	252.57	166.60	174.97	349.23	290.44	
300	-53.59	295.68	135.06	52.78	51.63	155.00	34.00	52.29	15.94	21.62	4.05	5.76	Mag Phase
			140.37	359.26	180.89	43.22	39.61	238.36	169.96	187.83	275.90	290.28	
301	-14.72	316.93	198.00	47.65	125.82	138.17	24.98	46.24	19.91	25.18	1.54	3.88	Mag Phase
			146.40	136.75	191.98	51.40	48.45	325.44	239.92	288.39	175.66	245.99	
302	-66.81	342.08	116.99	113.19	87.04	119.80	33.86	40.98	14.50	38.83	4.35	4.47	Mag Phase
			136.65	321.47	289.01	69.11	49.57	245.88	238.45	194.50	354.01	26.99	
303	-39.13	296.37	130.93	55.50	57.18	148.95	32.25	51.28	8.93	23.85	4.96	6.67	Mag Phase
			143.14	1.51	207.32	58.28	57.35	263.00	190.86	210.03	316.99	331.81	
304	196.04	309.19	149.22	55.15	103.89	142.77	23.95	42.97	24.48	7.69	3.67	7.93	Mag Phase
			147.69	52.91	215.24	53.28	2.95	284.84	216.70	143.68	341.39	321.06	
305	-251.10	388.04	113.24	52.08	130.50	170.06	47.90	27.52	10.71	28.47	1.13	6.30	Mag Phase
			140.36	327.95	194.23	83.37	44.07	253.41	17.28	162.57	53.75	5.00	
306	-28.43	303.73	143.57	58.17	50.59	155.03	36.74	51.43	16.12	26.28	4.17	5.27	Mag Phase
			141.04	3.31	192.70	44.49	45.95	244.22	174.46	179.23	309.48	296.67	

Table VI. - Continued

(p) Continued

Run 10

$\mu_{\text{Nom.}} = 0.20$

POINT	MEAN	1/2P-P	1P	2P	3P	4P	5P	6P	7P	8P	9P	10P	
307	-8.03	247.59	95.14	63.73	27.69	133.22	33.96	57.74	20.63	27.15	3.96	3.51	Mag Phase
			123.35	340.55	210.06	45.19	59.96	240.52	197.22	177.47	292.77	324.18	

$\mu_{\text{Nom.}} = 0.25$

POINT	MEAN	1/2P-P	1P	2P	3P	4P	5P	6P	7P	8P	9P	10P	
308	-16.61	353.21	162.40	104.11	64.07	130.98	39.78	45.78	18.90	16.40	2.89	0.49	Mag Phase
			134.69	357.24	221.40	64.52	90.52	240.14	232.93	196.44	121.36	263.45	
309	-31.50	425.21	255.50	79.75	93.89	132.34	47.25	46.35	20.83	13.81	2.26	2.79	Mag Phase
			149.35	10.10	207.48	73.28	112.02	244.70	222.79	185.75	149.86	269.95	
310	-4.30	631.02	389.66	154.29	169.88	122.80	63.04	51.57	29.75	11.17	13.56	14.17	Mag Phase
			136.67	119.61	140.97	33.27	190.27	239.12	277.14	308.44	279.92	247.29	
311	-48.64	429.36	205.04	134.51	92.81	107.63	31.52	31.28	14.53	20.88	2.04	2.24	Mag Phase
			139.93	348.42	298.89	102.33	89.31	240.33	294.53	234.31	53.02	80.81	
312	-23.94	443.88	280.21	52.89	95.17	131.70	52.22	54.51	25.22	26.12	1.94	2.39	Mag Phase
			144.15	357.50	202.15	62.79	82.39	230.96	187.70	164.83	31.67	269.10	
313	197.94	582.77	362.28	140.01	146.86	95.37	67.91	60.06	20.61	15.66	9.97	8.33	Mag Phase
			135.63	100.31	178.30	51.37	165.96	240.00	264.02	321.41	232.52	271.18	
314	-238.03	410.22	201.56	79.65	63.18	152.69	29.61	40.50	19.47	36.25	9.76	2.28	Mag Phase
			147.40	344.23	211.75	81.39	56.87	246.30	270.90	149.64	93.94	332.34	
315	-21.48	448.68	258.78	61.79	111.74	135.79	36.07	56.22	20.52	24.36	1.99	3.44	Mag Phase
			142.30	342.39	211.45	67.49	88.16	235.90	192.77	172.73	66.38	297.93	

Table VI. - Continued

(p) Continued

Run 10

$\mu_{Nom.} = 0.25$

POINT	MEAN	1/2P-P	1P	2P	3P	4P	5P	6P	7P	8P	9P	10P	
316	-45.36	680.48	505.31 143.28	116.92 172.94	155.89 172.12	123.55 60.75	25.61 127.51	42.64 226.78	25.67 259.53	28.15 207.60	2.82 305.90	10.97 249.00	Mag Phase

$\mu_{Nom.} = 0.30$

POINT	MEAN	1/2P-P	1P	2P	3P	4P	5P	6P	7P	8P	9P	10P	
317	-38.91	947.33	803.71 166.49	86.13 289.97	56.61 147.81	217.89 119.62	29.83 71.86	67.89 133.03	30.90 238.90	89.82 122.70	37.88 60.49	11.04 295.37	Mag Phase
318	-13.41	846.20	669.09 158.13	96.30 216.78	137.45 190.50	211.23 104.78	35.71 78.75	52.95 166.87	28.37 244.41	41.22 147.98	25.56 73.57	1.43 60.72	Mag Phase
319	-18.45	902.93	746.88 167.15	84.43 244.81	144.19 132.50	234.88 117.43	18.30 120.49	72.96 176.04	26.05 287.73	55.72 154.99	22.27 81.85	4.79 249.02	Mag Phase
320	-33.53	634.73	515.72 151.34	39.12 231.04	137.35 170.43	143.35 97.04	34.30 23.01	35.53 130.99	11.71 245.68	33.66 119.12	21.49 53.80	2.21 209.11	Mag Phase
321	-23.08	817.08	648.77 157.39	95.34 220.30	143.29 190.26	199.81 102.37	49.11 76.87	44.11 166.18	20.23 237.28	40.66 145.87	23.09 73.77	2.14 312.08	Mag Phase
322	197.12	938.59	716.21 160.06	72.46 221.60	37.05 120.39	255.89 99.83	12.79 197.16	76.79 162.24	18.32 282.07	34.15 122.63	22.48 50.91	2.16 160.39	Mag Phase
323	-239.98	716.73	530.61 148.96	49.49 229.73	192.74 192.22	165.52 103.47	18.08 13.54	15.46 182.42	23.96 257.97	33.92 157.79	17.86 97.83	5.89 88.22	Mag Phase
324	-25.11	859.64	660.91 159.94	104.38 237.83	144.72 200.93	215.26 108.39	55.02 85.65	40.46 168.42	23.95 249.11	35.97 146.34	25.49 78.07	3.05 243.07	Mag Phase

Table VI. - Continued

(p) Continued

Run 10

$\mu_{Nom.} = 0.25$

POINT	MEAN	1/2P-P	1P	2P	3P	4P	5P	6P	7P	8P	9P	10P	
325	-2.88	589.29	481.34	45.74	134.92	138.30	65.52	22.17	7.38	20.03	16.74	1.96	Mag Phase
			149.73	209.15	176.39	101.61	68.46	189.63	193.67	128.51	59.64	127.70	

$\mu_{Nom.} = 0.325$

POINT	MEAN	1/2P-P	1P	2P	3P	4P	5P	6P	7P	8P	9P	10P	
326	-4.47	881.74	662.49	35.17	175.65	207.85	94.48	58.41	27.28	70.63	31.48	8.93	Mag Phase
			158.33	264.40	226.03	128.23	59.38	145.19	196.18	112.67	57.07	271.97	
327	-25.12	945.03	754.08	70.39	118.39	259.05	81.76	85.30	30.57	100.09	41.12	13.56	Mag Phase
			162.14	330.14	209.91	130.76	57.81	130.06	200.52	115.28	58.24	294.21	
328	-14.97	1170.30	884.28	147.39	247.95	299.13	69.41	123.67	45.43	130.22	60.90	22.05	Mag Phase
			174.94	3.40	164.50	145.91	34.82	138.17	180.42	117.73	58.45	249.92	

$\mu_{Nom.} = 0.275$

POINT	MEAN	1/2P-P	1P	2P	3P	4P	5P	6P	7P	8P	9P	10P	
329	-66.39	798.64	657.30	132.79	127.31	176.84	35.37	43.34	23.40	26.87	11.96	6.63	Mag Phase
			155.52	196.41	166.55	73.31	93.51	181.27	236.53	132.73	32.56	198.03	
330	-44.86	628.76	459.18	91.60	147.98	128.88	35.90	40.18	9.62	29.82	3.06	8.12	Mag Phase
			141.36	166.46	147.87	68.47	111.38	210.32	219.39	154.75	97.49	219.25	
331	-16.37	861.87	642.84	142.33	137.12	224.35	39.17	57.25	17.83	4.40	7.11	14.41	Mag Phase
			152.30	186.10	183.85	66.57	163.44	210.19	277.04	213.41	65.83	201.93	
332	-45.75	519.72	329.47	73.81	136.58	83.03	21.53	27.53	23.87	18.99	9.51	5.11	Mag Phase
			146.97	355.03	345.08	100.29	102.81	214.17	262.33	173.35	79.94	273.27	

Table VI. - Continued

(p) Continued

Run 10

$\mu_{Nom.} = 0.25$

POINT	MEAN	1/2P-P	1P	2P	3P	4P	5P	6P	7P	8P	9P	10P	
333	-22.69	613.93	465.36	77.25	135.12	125.17	43.88	35.98	8.88	27.51	4.08	8.71	Mag
			142.73	170.16	157.62	67.62	98.15	211.26	221.31	171.76	110.11	228.60	Phase
334	197.59	782.24	601.38	137.70	168.19	146.48	37.88	49.12	33.21	18.58	10.83	15.51	Mag
			145.77	139.19	180.84	49.73	162.12	197.20	308.75	275.47	154.06	164.26	Phase
335	-253.07	510.96	344.22	53.38	53.76	117.91	40.56	33.02	24.56	40.58	11.97	5.47	Mag
			152.36	320.78	327.13	92.75	104.72	250.45	284.66	172.81	114.22	310.85	Phase
336	-26.69	615.40	501.00	89.71	113.13	124.59	37.78	38.68	11.94	27.53	6.41	8.07	Mag
			144.57	171.78	147.29	69.08	107.91	224.45	242.16	187.01	118.76	236.33	Phase
337	0.39	469.53	318.63	49.42	63.24	109.93	58.58	31.66	10.46	30.29	6.04	4.27	Mag
			137.47	341.08	285.14	75.57	83.09	238.76	218.11	171.39	98.67	260.12	Phase

$\mu_{Nom.} = 0.225$

POINT	MEAN	1/2P-P	1P	2P	3P	4P	5P	6P	7P	8P	9P	10P	
338	-4.27	489.69	338.89	13.20	122.96	145.57	29.69	50.84	23.81	34.08	3.82	10.79	Mag
			149.25	299.49	174.79	59.88	74.20	234.86	211.83	184.42	87.30	290.04	Phase
339	15.94	355.03	184.10	62.07	34.75	149.72	37.65	51.94	28.36	40.48	4.65	3.20	Mag
			145.08	356.84	191.42	58.64	83.19	238.63	216.31	189.51	127.95	352.65	Phase
340	38.57	503.13	325.12	91.50	153.48	156.07	30.47	22.68	27.82	14.36	4.47	8.03	Mag
			134.94	109.88	113.92	21.56	158.04	246.44	260.20	198.50	281.27	223.39	Phase
341	11.57	355.78	187.08	86.58	41.81	111.30	41.01	31.60	19.65	23.88	3.40	1.83	Mag
			137.23	336.24	320.61	71.54	54.53	245.60	258.31	214.38	39.12	347.60	Phase

Table VI. - Continued

(p) Concluded

Run 10

$\mu_{Nom.} = 0.225$

POINT	MEAN	1/2P-P	1P	2P	3P	4P	5P	6P	7P	8P	9P	10P	
342	23.22	370.78	218.46	50.30	54.20	156.64	41.70	49.17	26.92	41.04	5.87	0.55	Mag
			139.15	346.13	131.97	52.48	62.20	231.80	216.49	166.70	58.66	323.20	Phase
343	260.83	520.25	296.79	66.72	166.82	148.39	18.52	44.28	20.49	5.76	6.34	8.40	Mag
			134.64	101.72	162.53	43.50	175.53	231.84	238.27	252.38	197.96	256.65	Phase
344	-204.05	355.55	173.07	57.33	60.21	164.03	37.14	42.69	25.56	43.65	6.75	5.23	Mag
			137.40	352.40	190.03	71.02	31.86	232.48	239.62	148.38	93.76	1.83	Phase
345	23.37	392.42	224.61	63.95	43.58	162.52	35.62	49.75	31.89	41.12	6.49	1.91	Mag
			141.41	355.14	157.57	48.46	74.71	227.84	198.49	167.97	81.58	344.30	Phase
346	44.62	304.27	145.41	75.06	11.83	149.47	41.34	48.25	33.04	36.62	3.98	2.58	Mag
			134.60	0.03	179.47	47.43	74.32	234.36	203.92	173.60	83.18	10.75	Phase



Table VI. - Continued

(q) Fixed-system strain-gage balance yawing moment, in-lbs

Run 10

$\mu_{Nom.} = 0.08$

POINT	MEAN	1/2P-P	1P	2P	3P	4P	5P	6P	7P	8P	9P	10P	
281	690.87	278.56	59.86	12.67	5.14	195.40	56.80	28.14	5.41	10.85	3.18	1.53	Mag Phase
			311.36	13.75	309.02	27.63	184.92	49.03	321.42	301.33	17.15	345.25	
282	586.51	189.25	43.01	13.91	8.74	118.36	32.28	30.94	8.06	11.48	1.12	2.86	Mag Phase
			303.69	358.14	342.59	40.81	179.84	36.12	327.15	343.29	52.89	333.10	
283	506.85	131.96	38.65	11.48	13.14	66.31	22.85	28.03	4.38	4.63	3.61	2.55	Mag Phase
			296.98	354.16	296.61	56.63	179.58	38.37	337.61	318.50	77.04	340.37	

$\mu_{Nom.} = 0.11$

POINT	MEAN	1/2P-P	1P	2P	3P	4P	5P	6P	7P	8P	9P	10P	
284	459.19	106.57	35.37	9.16	14.48	57.96	13.15	28.67	7.41	9.45	3.46	1.36	Mag Phase
			297.00	3.19	317.27	107.82	175.11	37.61	312.60	325.14	66.32	30.20	
285	519.90	142.08	46.67	8.30	12.88	73.66	27.00	26.46	8.12	11.97	3.61	1.08	Mag Phase
			303.94	6.81	320.66	87.51	164.55	26.69	314.88	322.74	42.45	10.28	
286	592.59	193.38	61.36	13.33	10.72	98.78	45.09	22.14	11.66	10.25	2.89	2.11	Mag Phase
			315.75	17.87	17.62	67.71	182.34	51.43	326.28	321.56	350.35	3.92	

$\mu_{Nom.} = 0.13$

POINT	MEAN	1/2P-P	1P	2P	3P	4P	5P	6P	7P	8P	9P	10P	
287	569.75	167.39	59.59	9.70	10.63	86.82	26.92	28.25	10.41	14.14	1.12	1.82	Mag Phase
			310.04	7.29	295.42	70.38	174.26	35.83	326.27	307.77	5.80	21.94	
288	496.06	131.25	49.13	6.30	16.34	78.87	7.76	25.99	6.42	9.93	3.95	0.93	Mag Phase
			307.69	39.45	288.58	108.54	189.45	45.44	335.32	320.74	78.42	39.69	

Table VI. - Continued

(q) Continued

Run 10

 $\mu_{\text{Nom.}} = 0.13$ 

POINT	MEAN	1/2P-P	1P	2P	3P	4P	5P	6P	7P	8P	9P	10P	
289	439.60	115.03	37.57	7.62	22.56	70.21	2.50	22.23	6.90	9.70	3.60	1.43	Mag Phase
			295.08	28.30	279.43	113.29	322.63	22.58	318.72	339.16	74.86	9.39	

 $\mu_{\text{Nom.}} = 0.16$ 

POINT	MEAN	1/2P-P	1P	2P	3P	4P	5P	6P	7P	8P	9P	10P	
290	470.46	118.11	40.26	4.92	7.66	69.13	18.49	19.41	4.66	2.32	2.79	0.99	Mag Phase
			291.39	33.13	236.04	124.14	52.18	54.92	24.13	1.74	104.68	50.67	
291	520.15	146.21	53.96	4.01	4.31	93.59	23.12	22.02	5.83	8.68	1.52	3.50	Mag Phase
			301.03	1.55	246.39	101.76	81.80	43.42	352.10	312.62	58.81	331.11	
292	507.97	174.28	47.67	16.46	7.38	94.27	33.28	27.27	11.67	10.03	3.80	3.94	Mag Phase
			284.03	29.45	205.87	105.12	149.56	94.61	327.06	355.35	25.97	75.49	
293	530.43	179.87	47.12	10.65	13.80	126.09	22.05	17.69	1.65	8.85	2.10	2.06	Mag Phase
			296.79	122.87	156.28	101.39	64.10	63.09	117.82	308.02	145.90	64.01	
294	522.72	163.96	51.85	4.60	3.94	105.42	17.14	28.00	5.74	11.47	2.85	3.96	Mag Phase
			297.73	19.17	212.80	97.02	73.38	42.71	339.48	320.42	76.19	29.72	
295	518.03	162.94	52.48	7.62	16.63	98.36	12.83	32.11	4.19	10.38	2.72	4.06	Mag Phase
			297.58	16.33	105.11	67.75	105.17	51.82	328.66	319.26	17.97	8.78	
296	532.04	158.79	41.08	6.60	15.77	123.39	25.74	15.25	8.46	9.87	5.14	0.81	Mag Phase
			294.10	90.45	324.97	93.50	43.87	38.07	77.83	265.42	97.10	356.54	
297	525.41	141.35	52.43	4.27	3.98	88.59	14.22	25.70	2.70	5.43	2.35	2.66	Mag Phase
			297.65	8.57	138.71	98.78	75.67	54.96	326.24	300.31	64.69	30.06	

Table VI. - Continued

(q) Continued

Run 10

$\mu_{\text{Nom.}} = 0.16$

POINT	MEAN	1/2P-P	1P	2P	3P	4P	5P	6P	7P	8P	9P	10P	
298	589.51	176.40	68.25	4.74	6.83	104.46	18.86	19.62	6.36	7.89	0.91	2.64	Mag Phase
			310.16	348.23	129.61	88.48	147.10	80.63	18.56	336.46	252.15	352.63	

$\mu_{\text{Nom.}} = 0.20$

POINT	MEAN	1/2P-P	1P	2P	3P	4P	5P	6P	7P	8P	9P	10P	
299	649.53	220.18	73.41	5.19	9.81	132.14	47.08	26.72	12.71	11.67	4.50	3.60	Mag Phase
			305.94	84.89	113.42	64.02	124.76	57.60	18.74	272.40	268.32	275.64	
300	582.07	180.80	64.60	3.10	8.70	123.68	44.74	26.58	10.55	8.63	2.58	1.02	Mag Phase
			299.50	166.96	62.51	80.42	90.29	32.85	339.37	286.52	89.81	221.05	
301	566.40	154.80	42.74	22.96	2.40	86.90	60.04	26.04	19.47	8.81	2.49	7.44	Mag Phase
			298.45	36.03	72.01	83.53	135.05	63.23	17.95	6.44	17.40	207.20	
302	593.45	219.99	60.67	11.64	20.33	165.85	40.08	7.95	4.24	9.55	1.00	2.16	Mag Phase
			294.49	159.45	97.30	85.17	90.25	56.75	45.83	346.20	265.46	20.51	
303	571.91	186.16	59.89	3.49	11.78	115.20	42.46	30.73	9.91	12.95	1.26	2.70	Mag Phase
			301.19	105.03	91.23	100.39	106.12	57.73	15.98	341.50	338.79	308.45	
304	568.64	195.77	52.42	8.98	13.43	122.99	44.31	25.71	13.45	8.88	2.27	2.99	Mag Phase
			291.05	19.63	97.99	64.22	127.45	51.00	18.03	314.86	298.80	295.14	
305	579.43	242.38	52.18	9.36	24.44	165.97	48.68	19.62	8.33	12.20	1.98	1.55	Mag Phase
			301.00	146.95	26.57	84.12	96.63	60.72	93.87	304.29	111.50	354.09	
306	577.81	172.92	60.07	1.24	11.04	110.03	44.66	27.11	9.41	10.60	2.88	2.70	Mag Phase
			299.06	236.93	67.28	80.62	92.46	37.46	349.05	318.13	265.36	245.77	

Table VI. - Continued

(q) Continued

Run 10

$\mu_{Nom.} = 0.20$

POINT	MEAN	1/2P-P	1P	2P	3P	4P	5P	6P	7P	8P	9P	10P	
307	520.91	173.92	49.02 292.43	5.65 166.57	3.66 83.12	102.12 96.04	42.17 78.53	27.09 31.29	6.74 318.77	9.85 317.61	0.77 56.60	1.02 32.74	Mag Phase

$\mu_{Nom.} = 0.25$

POINT	MEAN	1/2P-P	1P	2P	3P	4P	5P	6P	7P	8P	9P	10P	
308	619.69	223.30	63.70 303.97	6.57 183.16	15.17 69.35	152.48 88.11	62.47 100.21	9.40 46.79	9.69 2.50	8.15 308.32	3.33 304.75	1.63 194.21	Mag Phase
309	685.17	253.42	61.24 307.11	5.20 120.77	12.04 82.14	167.06 71.43	82.64 135.04	20.00 52.47	13.76 28.27	8.25 282.43	4.19 299.24	3.85 246.24	Mag Phase
310	689.84	405.38	12.48 21.26	47.93 356.85	24.32 261.14	225.00 40.25	187.38 136.09	57.80 15.81	11.71 343.89	7.47 267.18	2.66 206.51	3.99 247.74	Mag Phase
311	700.89	306.50	71.22 306.92	9.50 171.55	27.07 112.16	238.53 74.71	42.61 116.00	4.96 25.71	1.78 26.27	6.91 354.05	2.75 317.03	0.83 114.03	Mag Phase
312	693.55	275.61	51.21 289.02	6.45 1.62	12.62 58.34	152.08 37.70	112.82 129.60	43.72 18.91	12.76 2.05	4.00 291.72	4.54 283.30	2.47 191.92	Mag Phase
313	686.95	420.34	20.99 9.08	40.84 335.66	9.41 324.29	239.04 32.69	193.08 127.85	62.25 11.05	5.86 106.06	5.83 249.06	3.34 227.11	5.81 276.50	Mag Phase
314	698.18	298.50	73.06 298.93	5.15 140.54	13.32 60.52	202.55 52.50	66.27 120.88	16.99 26.31	2.85 21.20	7.08 312.70	2.83 282.48	0.53 343.86	Mag Phase
315	687.80	286.28	59.75 301.79	5.26 58.40	19.86 57.44	158.69 39.62	103.76 140.07	36.88 29.43	6.38 16.60	9.84 315.88	6.75 266.34	4.24 228.10	Mag Phase

Table VI. - Continued

(q) Continued

Run 10

 $\mu_{\text{Nom.}} = 0.25$ 

POINT	MEAN	1/2P-P	1P	2P	3P	4P	5P	6P	7P	8P	9P	10P	
316	790.46	369.33	27.31 352.76	36.23 8.05	39.12 341.43	205.96 35.99	173.75 143.93	36.55 23.45	13.73 344.32	9.58 273.21	1.99 233.63	9.00 237.35	Mag Phase

 $\mu_{\text{Nom.}} = 0.30$ 

POINT	MEAN	1/2P-P	1P	2P	3P	4P	5P	6P	7P	8P	9P	10P	
317	1142.74	407.91	115.11 345.25	26.60 324.58	39.59 320.67	272.28 321.87	94.28 72.13	51.30 285.67	44.37 339.11	4.24 250.03	8.30 1.13	9.20 266.13	Mag Phase
318	976.64	245.92	58.51 327.33	23.27 5.42	61.82 2.39	140.96 330.18	88.55 97.85	37.82 299.61	34.96 329.96	5.69 24.81	1.43 6.56	1.45 282.19	Mag Phase
319	995.83	417.29	102.98 335.07	40.14 346.25	40.19 344.76	266.06 317.26	139.29 109.54	63.43 323.44	41.04 354.56	6.03 295.26	5.72 18.51	5.90 269.40	Mag Phase
320	965.62	284.14	59.58 337.61	21.35 42.26	50.80 338.26	167.40 30.45	79.39 124.80	26.73 292.13	30.42 304.73	9.44 7.21	0.47 254.88	3.06 241.12	Mag Phase
321	975.97	234.32	60.14 335.52	13.90 21.16	57.04 358.59	125.26 323.00	81.91 102.45	33.48 299.08	29.09 327.40	3.82 283.21	0.71 305.08	2.85 267.10	Mag Phase
322	988.31	346.81	86.98 342.70	27.27 332.30	34.27 349.57	223.96 320.44	94.34 89.32	65.60 301.71	39.34 331.38	0.87 72.53	6.39 328.23	6.45 199.45	Mag Phase
323	972.34	334.93	67.79 342.86	24.43 70.64	55.50 351.03	208.73 340.02	94.40 151.82	19.85 354.29	23.77 342.22	1.46 291.27	2.62 1.51	1.79 225.70	Mag Phase
324	976.76	260.49	56.75 338.07	23.16 14.34	65.73 5.77	156.52 335.22	96.11 113.52	33.78 304.00	29.08 333.72	7.06 315.37	2.06 355.65	3.57 264.47	Mag Phase

Table VI. - Continued

(q) Continued

Run 10

$\mu_{Nom.} = 0.30$

POINT	MEAN	1/2P-P	1P	2P	3P	4P	5P	6P	7P	8P	9P	10P	
325	843.10	262.17	43.29	21.69	54.28	137.97	101.33	21.46	19.92	3.59	1.37	1.65	Mag Phase
			329.88	63.79	337.23	9.71	116.75	297.50	315.11	47.64	13.29	190.03	

$\mu_{Nom.} = 0.325$

POINT	MEAN	1/2P-P	1P	2P	3P	4P	5P	6P	7P	8P	9P	10P	
326	1016.96	373.37	67.91	8.63	60.86	248.36	99.51	36.60	42.09	10.33	2.25	5.39	Mag Phase
			339.88	225.83	4.60	338.51	79.81	297.05	314.41	29.31	150.80	279.46	
327	1194.97	468.31	119.81	14.55	40.18	298.66	110.91	47.10	39.85	3.76	0.82	9.18	Mag Phase
			355.47	271.68	338.51	332.56	58.67	306.89	322.55	24.20	9.54	256.44	
328	1450.49	718.09	163.01	47.55	84.29	453.19	80.65	52.52	29.66	11.78	12.29	19.99	Mag Phase
			5.02	303.54	315.88	330.42	346.76	314.20	14.55	359.44	79.26	244.26	

$\mu_{Nom.} = 0.275$

POINT	MEAN	1/2P-P	1P	2P	3P	4P	5P	6P	7P	8P	9P	10P	
329	928.97	290.46	55.96	31.99	57.94	180.72	93.35	37.95	24.08	1.55	1.37	7.90	Mag Phase
			323.66	7.36	352.31	343.28	129.67	329.54	355.36	313.06	267.69	185.90	
330	805.63	378.31	37.98	30.17	44.15	213.28	165.57	41.71	6.05	6.47	1.89	3.90	Mag Phase
			334.87	7.68	317.76	6.53	124.93	15.20	327.02	217.29	221.47	197.67	
331	813.65	307.40	31.78	36.02	51.18	169.46	130.70	45.69	22.76	0.59	1.27	5.82	Mag Phase
			329.66	13.20	3.62	1.51	122.40	8.23	10.18	105.03	358.64	189.90	
332	805.96	328.05	65.24	14.36	21.43	268.11	58.88	8.98	5.37	11.70	3.46	1.65	Mag Phase
			332.88	159.64	170.19	49.32	115.31	352.37	33.39	65.30	237.50	204.87	

Table VI. - Continued

(q) Continued

Run 10

 $\mu_{\text{Nom.}} = 0.275$ 

POINT	MEAN	1/2P-P	1P	2P	3P	4P	5P	6P	7P	8P	9P	10P	
333	804.67	377.05	40.68 334.25	35.92 17.74	40.13 325.43	231.78 5.18	144.91 129.14	41.33 23.21	11.24 338.80	5.11 163.89	1.08 208.44	6.12 195.87	Mag Phase
334	813.09	447.29	35.36 1.19	33.50 330.92	49.44 334.89	280.63 6.57	170.19 126.56	47.01 345.23	12.18 23.19	6.17 141.24	4.77 102.23	8.24 176.89	Mag Phase
335	804.63	359.37	67.74 304.86	20.75 98.52	10.22 92.50	252.70 25.24	84.87 144.09	27.33 71.56	13.99 52.53	7.35 51.38	2.25 301.55	5.58 310.05	Mag Phase
336	804.30	393.99	30.88 338.37	33.45 39.82	35.74 325.06	223.96 9.32	160.32 137.81	39.58 25.73	7.96 335.13	9.11 188.31	2.76 242.28	6.12 202.92	Mag Phase
337	719.21	277.84	58.98 318.38	6.13 96.95	13.06 57.42	171.97 15.12	101.21 123.10	28.44 29.26	2.81 323.72	8.39 3.43	4.87 229.56	4.48 215.12	Mag Phase

 $\mu_{\text{Nom.}} = 0.225$ 

POINT	MEAN	1/2P-P	1P	2P	3P	4P	5P	6P	7P	8P	9P	10P	
338	711.27	304.01	59.15 311.15	15.15 13.45	8.74 14.57	163.48 7.36	121.18 136.68	51.89 35.08	20.87 23.39	6.13 284.68	4.48 295.02	8.23 268.74	Mag Phase
339	624.02	236.35	76.73 310.57	10.31 268.44	9.52 131.64	142.69 40.95	70.42 118.33	28.57 23.18	9.88 359.98	5.79 321.65	2.94 312.35	0.04 262.85	Mag Phase
340	626.98	343.42	10.19 4.53	40.44 352.89	32.43 237.35	189.35 30.24	151.24 122.27	55.70 8.42	13.91 343.82	2.73 160.03	0.72 300.88	4.86 210.71	Mag Phase
341	635.23	250.32	69.02 299.51	11.60 227.52	10.53 90.36	178.92 59.53	58.09 109.77	7.24 23.12	2.26 30.61	1.49 342.76	1.19 140.78	2.00 316.81	Mag Phase

Table VI. - Continued

(q) Concluded

Run 10

 $\mu_{\text{Nom.}} = 0.225$ 

POINT	MEAN	1/2P-P	1P	2P	3P	4P	5P	6P	7P	8P	9P	10P	
342	632.05	243.47	64.09 306.75	7.23 289.74	4.38 82.88	138.23 29.50	82.87 123.76	29.24 21.38	8.69 328.30	10.28 285.19	3.69 296.86	2.71 189.18	Mag Phase
343	626.78	326.10	25.30 315.71	31.48 335.04	12.93 310.61	170.36 12.92	141.61 120.20	65.81 7.01	4.88 10.15	8.80 242.11	4.16 217.30	3.88 235.94	Mag Phase
344	629.92	277.37	62.21 305.56	4.70 172.17	10.71 36.63	187.72 40.65	66.26 111.66	21.69 19.97	5.18 45.60	6.54 263.92	0.32 157.66	1.31 274.26	Mag Phase
345	628.42	219.69	69.16 305.61	7.99 276.22	5.58 109.48	120.19 16.25	72.71 126.28	30.45 19.80	9.41 341.05	3.77 271.55	3.89 311.76	2.43 200.45	Mag Phase
346	564.75	170.28	63.10 301.60	12.57 233.20	5.84 132.76	92.07 38.08	63.08 105.85	25.33 15.44	5.60 305.08	6.49 353.27	3.08 333.66	1.10 221.89	Mag Phase



Table VI. - Continued

(r) Fixed-system strain-gage balance side force, lbs

Run 10

$\mu_{Nom.} = 0.08$

POINT	MEAN	1/2P-P	1P	2P	3P	4P	5P	6P	7P	8P	9P	10P	
281	-4.70	29.35	3.39 150.46	3.55 131.49	2.69 110.78	22.51 17.22	4.95 195.01	5.84 230.31	0.57 188.65	2.91 219.32	1.47 207.68	0.20 120.00	Mag Phase
282	-3.90	25.21	2.44 133.92	3.76 119.27	2.33 120.26	18.23 14.88	3.45 177.73	5.78 221.13	1.18 182.03	3.39 201.36	1.07 181.95	0.42 152.17	Mag Phase
283	-3.38	22.22	2.18 129.43	3.19 122.90	2.56 105.63	14.77 15.20	2.83 185.12	4.87 227.83	1.29 167.35	4.30 181.08	0.92 180.89	0.35 133.53	Mag Phase

$\mu_{Nom.} = 0.11$

POINT	MEAN	1/2P-P	1P	2P	3P	4P	5P	6P	7P	8P	9P	10P	
284	-3.12	18.98	2.28 131.92	1.90 134.08	2.59 124.02	10.88 11.73	2.25 192.03	4.72 232.34	1.47 138.86	3.65 167.24	0.72 125.20	0.13 353.01	Mag Phase
285	-3.68	20.70	2.61 141.66	2.08 133.52	2.84 117.83	13.37 9.80	2.54 183.44	5.13 215.39	1.47 131.87	3.38 185.03	0.88 162.03	0.18 352.17	Mag Phase
286	-4.52	25.59	3.51 155.27	2.45 146.21	3.12 138.49	16.89 20.90	3.96 189.09	5.15 238.88	2.08 147.62	2.90 222.32	0.69 182.40	0.43 179.42	Mag Phase

$\mu_{Nom.} = 0.13$

POINT	MEAN	1/2P-P	1P	2P	3P	4P	5P	6P	7P	8P	9P	10P	
287	-4.74	25.29	3.73 155.53	2.20 148.71	3.15 110.30	16.03 21.14	2.21 232.98	5.48 219.90	2.11 153.75	3.72 210.15	0.82 170.11	0.25 18.78	Mag Phase
288	-3.89	21.18	2.90 144.27	1.79 151.48	3.14 108.48	12.97 40.30	1.31 269.07	4.93 233.72	1.70 175.90	3.67 218.50	0.58 154.63	0.38 34.39	Mag Phase

Table VI. - Continued

(r) Continued

Run 10

$\mu_{\text{Nom.}} = 0.13$

POINT	MEAN	1/2P-P	1P	2P	3P	4P	5P	6P	7P	8P	9P	10P	
289	-3.19	18.19	2.13 135.37	1.29 148.08	3.16 93.28	10.30 34.55	1.30 270.46	4.69 215.82	1.72 183.45	1.97 182.54	0.91 110.02	0.14 336.02	Mag Phase

$\mu_{\text{Nom.}} = 0.16$

POINT	MEAN	1/2P-P	1P	2P	3P	4P	5P	6P	7P	8P	9P	10P	
290	-3.51	16.77	2.28 148.77	0.57 109.58	1.06 85.20	10.64 38.83	2.31 19.00	4.63 225.07	1.24 178.05	0.93 188.39	0.95 179.14	0.44 322.38	Mag Phase
291	-4.39	19.64	2.79 151.32	0.44 161.70	1.71 111.87	12.80 33.88	2.33 44.65	4.88 215.36	1.06 173.30	1.62 199.81	0.94 178.65	0.24 1.65	Mag Phase
292	-3.20	26.13	4.41 162.10	4.13 128.48	1.61 140.19	11.29 26.04	0.98 226.03	6.77 286.10	2.56 157.50	3.49 206.62	1.09 70.86	0.67 205.11	Mag Phase
293	-4.73	17.70	2.55 141.38	2.96 291.77	1.77 330.66	10.11 49.45	3.92 31.62	5.14 233.31	0.93 189.98	3.10 150.21	0.38 163.28	0.41 277.25	Mag Phase
294	-4.19	20.41	2.95 156.60	0.37 67.75	1.27 111.50	13.27 39.01	2.61 14.69	6.08 224.20	1.25 162.03	2.66 193.51	0.84 195.62	0.36 328.30	Mag Phase
295	0.38	22.99	3.21 161.53	2.60 101.04	2.10 205.23	14.35 28.83	2.60 305.86	6.68 230.83	0.81 102.67	2.01 127.96	0.54 271.65	0.44 85.87	Mag Phase
296	-8.35	20.56	2.47 151.34	1.33 292.57	2.79 133.56	12.10 44.03	4.47 352.69	2.77 217.20	0.69 282.75	2.26 78.55	0.53 129.11	0.49 340.08	Mag Phase
297	-4.25	19.81	2.78 159.03	0.80 84.84	1.02 135.12	13.00 33.97	2.21 5.73	5.98 226.44	0.99 157.62	2.36 181.73	0.87 197.71	0.46 318.72	Mag Phase

Table VI. - Continued

(r) Continued

Run 10

 $\mu_{\text{Nom.}} = 0.16$ 

POINT	MEAN	1/2P-P	1P	2P	3P	4P	5P	6P	7P	8P	9P	10P	
298	-4.92	22.77	3.84 165.21	1.86 110.24	2.15 140.17	15.74 33.65	1.41 37.77	5.25 228.85	1.66 169.66	1.03 265.90	1.10 220.40	0.13 137.00	Mag Phase

 $\mu_{\text{Nom.}} = 0.20$ 

POINT	MEAN	1/2P-P	1P	2P	3P	4P	5P	6P	7P	8P	9P	10P	
299	-5.76	23.69	4.69 160.79	1.05 337.03	2.40 171.31	16.18 28.54	3.52 77.73	4.32 214.58	2.51 153.94	1.44 94.74	0.46 215.65	1.04 24.15	Mag Phase
300	-4.66	20.76	3.19 164.99	1.40 358.30	1.33 171.71	13.87 36.49	4.54 55.94	5.65 208.04	1.86 151.84	2.09 124.27	0.82 189.18	1.06 354.76	Mag Phase
301	-4.36	25.47	6.58 154.92	2.54 109.29	3.64 182.62	13.65 38.99	3.47 98.72	4.28 300.34	3.40 192.70	1.67 283.67	1.20 94.95	1.20 352.92	Mag Phase
302	-4.98	22.48	2.73 165.43	4.17 303.12	2.43 279.99	13.19 58.02	4.71 63.92	3.82 217.29	1.60 216.43	2.89 143.31	0.14 59.89	0.21 242.65	Mag Phase
303	-4.75	19.95	3.17 163.19	1.61 355.08	1.59 194.44	13.05 51.73	4.41 75.19	5.67 235.53	1.49 191.29	1.88 155.86	0.82 217.68	1.04 45.80	Mag Phase
304	-0.09	22.54	4.76 170.14	2.45 52.47	2.79 203.84	15.19 38.83	2.00 47.48	4.20 240.13	2.14 183.06	2.81 93.96	0.08 160.30	1.18 52.97	Mag Phase
305	-8.78	23.11	2.47 161.37	1.55 301.90	3.81 180.03	16.17 64.00	5.22 60.96	3.18 227.07	0.86 279.14	2.79 115.65	0.42 152.25	0.89 49.95	Mag Phase
306	-4.58	21.18	3.62 160.71	1.71 355.52	1.31 182.56	13.66 35.68	4.96 60.61	5.73 215.84	1.85 159.58	2.72 128.07	0.74 190.96	1.11 5.32	Mag Phase

Table VI. - Continued

(r) Continued

Run 10

$\mu_{\text{Nom.}} = 0.20$

POINT	MEAN	1/2P-P	1P	2P	3P	4P	5P	6P	7P	8P	9P	10P	
307	-3.83	18.65	2.26 151.90	1.81 319.18	0.76 199.09	11.14 43.58	5.27 68.09	5.78 212.66	2.32 158.33	2.68 136.50	0.69 140.62	0.95 356.16	Mag Phase

$\mu_{\text{Nom.}} = 0.25$

POINT	MEAN	1/2P-P	1P	2P	3P	4P	5P	6P	7P	8P	9P	10P	
308	-4.37	22.34	3.49 153.28	3.73 335.60	1.85 212.15	12.42 60.28	6.57 85.97	3.83 199.89	2.32 196.08	1.14 122.73	1.01 149.07	0.51 352.01	Mag Phase
309	-5.51	24.54	7.54 163.94	2.77 356.04	2.84 201.82	14.25 52.59	7.31 110.81	4.75 211.21	2.33 197.92	1.48 106.46	1.13 173.82	0.48 33.51	Mag Phase
310	-5.22	40.20	14.87 136.26	5.03 88.11	5.39 131.32	20.16 20.87	12.40 154.96	5.82 182.72	1.85 186.65	2.69 355.46	1.51 118.34	1.75 52.65	Mag Phase
311	-5.58	25.54	4.54 152.74	5.41 327.44	2.85 291.13	14.79 70.96	4.70 82.50	2.69 202.77	1.63 236.57	0.68 206.51	0.64 134.04	0.18 258.26	Mag Phase
312	-5.48	26.85	9.03 158.91	2.62 336.54	2.71 198.90	14.28 29.29	7.82 98.52	6.69 200.59	2.48 161.79	2.54 95.14	0.91 151.91	0.63 350.40	Mag Phase
313	-1.29	38.51	13.42 136.48	3.96 65.48	4.27 171.36	17.66 23.29	12.65 139.07	6.13 191.52	1.16 220.13	3.67 347.77	0.27 163.81	1.46 38.62	Mag Phase
314	-9.54	25.29	4.89 181.44	3.23 321.21	1.71 201.55	16.40 47.73	4.20 84.18	4.06 213.67	2.11 222.90	3.60 96.84	0.50 139.52	0.41 354.26	Mag Phase
315	-5.66	26.32	7.19 157.41	3.45 323.58	2.90 207.25	14.82 33.46	6.09 108.28	6.95 205.85	1.87 171.14	2.16 101.62	1.07 180.32	0.73 20.65	Mag Phase

Table VI. - Continued

(r) Continued

Run 10

$\mu_{Nom.} = 0.25$

POINT	MEAN	1/2P-P	1P	2P	3P	4P	5P	6P	7P	8P	9P	10P	
316	-6.79	38.33	18.07 143.00	3.09 172.06	3.55 168.50	17.44 23.84	8.28 134.10	5.54 193.16	2.16 180.69	0.95 127.70	1.13 159.47	1.22 44.69	Mag Phase

$\mu_{Nom.} = 0.30$

POINT	MEAN	1/2P-P	1P	2P	3P	4P	5P	6P	7P	8P	9P	10P	
317	-6.31	36.11	23.68 169.11	4.39 272.61	2.33 148.41	4.98 33.60	8.39 43.57	8.35 112.88	4.26 151.97	8.34 98.60	1.02 50.21	0.75 85.29	Mag Phase
318	-5.41	31.41	21.42 164.87	4.14 210.78	2.96 186.68	6.41 42.75	6.45 65.92	7.16 132.32	2.45 164.41	4.06 98.15	1.04 136.60	0.31 300.65	Mag Phase
319	-6.04	32.49	21.82 174.37	4.48 250.04	5.09 121.99	4.91 346.90	7.48 95.18	9.40 141.29	2.31 163.19	5.28 121.17	0.28 140.24	0.99 61.31	Mag Phase
320	-5.31	27.26	15.50 158.01	1.62 227.89	3.03 176.77	11.80 49.64	4.16 37.18	5.00 96.70	0.88 87.63	3.77 59.05	0.41 69.26	0.45 69.94	Mag Phase
321	-5.58	29.78	20.51 162.36	4.42 209.04	3.42 191.68	5.70 38.67	7.35 65.76	6.18 131.83	1.66 160.44	4.13 102.74	1.04 131.52	0.34 334.81	Mag Phase
322	-1.29	34.63	21.40 162.60	4.02 225.88	1.48 87.71	7.90 23.29	3.72 69.91	9.49 127.42	2.05 126.50	4.35 95.04	0.48 168.54	0.65 333.13	Mag Phase
323	-9.56	29.41	15.76 150.79	1.86 200.87	5.51 195.72	9.09 10.85	1.82 39.30	3.46 134.72	2.48 202.60	2.54 117.51	1.67 114.03	0.61 327.53	Mag Phase
324	-5.62	31.86	21.54 165.33	4.45 231.31	3.28 206.21	7.02 42.64	8.00 78.81	6.05 128.52	1.57 173.53	4.49 103.39	1.17 131.87	0.45 13.10	Mag Phase

Table VI. - Continued

(r) Continued

Run 10

$\mu_{Nom.} = 0.30$

POINT	MEAN	1/2P-P	1P	2P	3P	4P	5P	6P	7P	8P	9P	10P	
325	-4.88	25.20	15.49 155.10	2.41 197.31	3.05 196.77	9.29 39.24	8.64 76.59	2.95 130.24	1.25 76.51	3.82 66.21	0.83 167.60	0.21 226.22	Mag Phase

$\mu_{Nom.} = 0.325$

POINT	MEAN	1/2P-P	1P	2P	3P	4P	5P	6P	7P	8P	9P	10P	
326	-4.27	38.72	21.68 163.68	3.32 226.16	4.74 231.86	4.65 27.15	11.63 46.39	5.57 123.63	3.85 150.13	6.88 100.55	1.53 114.15	0.15 137.29	Mag Phase
327	-4.87	39.40	22.42 162.53	2.65 275.86	3.39 193.78	2.10 10.00	12.14 33.05	8.95 118.87	5.46 146.58	8.74 94.30	1.44 99.72	0.23 81.01	Mag Phase
328	-4.27	54.54	25.48 173.54	5.88 326.14	8.95 157.75	4.36 294.04	15.76 350.63	9.66 121.97	7.56 165.10	12.62 92.27	2.53 69.29	0.21 349.89	Mag Phase

$\mu_{Nom.} = 0.275$

POINT	MEAN	1/2P-P	1P	2P	3P	4P	5P	6P	7P	8P	9P	10P	
329	-6.33	41.82	21.28 162.04	4.94 193.40	2.72 158.35	13.76 9.76	4.60 89.34	5.90 145.72	3.15 175.30	3.74 52.14	0.96 94.38	0.74 339.04	Mag Phase
330	-5.81	32.99	14.80 145.89	2.72 173.14	3.33 150.36	15.68 12.63	8.32 115.89	6.50 184.64	1.46 162.40	2.75 100.70	0.89 148.46	0.92 355.92	Mag Phase
331	-5.51	46.60	22.28 156.05	5.02 180.60	2.32 170.63	18.29 25.29	6.99 129.77	7.17 170.77	3.04 189.96	1.73 324.75	0.50 60.96	0.76 353.38	Mag Phase
332	-5.16	28.16	9.53 154.04	2.60 309.66	4.55 330.07	15.46 48.27	3.66 80.06	2.99 190.85	1.82 216.09	1.17 113.34	0.90 166.86	0.21 241.91	Mag Phase

Table VI. - Continued

(r) Continued

Run 10

 $\mu_{\text{Nom.}} = 0.275$ 

POINT	MEAN	1/2P-P	1P	2P	3P	4P	5P	6P	7P	8P	9P	10P	
333	-5.38	33.40	14.89 146.99	1.85 170.13	3.00 161.23	16.73 11.17	8.29 109.62	5.94 186.08	1.44 165.36	2.34 106.49	1.14 158.81	0.93 354.15	Mag Phase
334	-1.11	46.25	20.70 146.79	3.58 138.15	3.90 188.45	21.64 10.02	7.80 140.06	6.95 155.64	2.33 241.86	3.79 294.76	1.22 179.38	1.43 339.66	Mag Phase
335	-9.83	31.79	10.24 171.68	2.04 298.94	2.12 320.36	16.33 29.44	5.58 111.72	3.60 217.70	2.26 240.00	2.74 136.09	0.57 110.92	0.82 97.31	Mag Phase
336	-5.61	36.34	17.28 148.46	3.06 158.98	2.06 141.41	16.96 14.80	8.05 121.20	6.22 197.30	1.21 169.84	2.45 132.04	0.95 163.86	0.96 9.57	Mag Phase
337	-4.43	26.91	9.40 145.36	2.79 302.52	2.81 292.36	12.93 22.76	7.42 93.45	4.44 199.07	0.99 167.76	2.39 115.92	0.50 140.87	0.34 9.61	Mag Phase

 $\mu_{\text{Nom.}} = 0.225$ 

POINT	MEAN	1/2P-P	1P	2P	3P	4P	5P	6P	7P	8P	9P	10P	
338	-5.53	31.67	10.23 157.75	1.25 290.18	3.46 166.72	17.08 17.44	6.08 110.59	6.11 202.98	3.01 187.38	1.90 135.94	0.63 153.84	1.24 69.35	Mag Phase
339	-4.58	26.58	4.01 169.19	2.82 316.06	1.08 173.97	16.38 34.97	5.71 93.95	5.55 208.22	2.91 187.64	3.53 151.31	1.08 145.09	0.93 30.14	Mag Phase
340	-4.38	36.99	12.75 138.48	3.02 73.83	5.01 106.35	21.42 13.45	8.74 135.85	3.08 176.36	2.68 189.12	0.56 135.09	1.75 97.34	1.64 37.00	Mag Phase
341	-4.37	24.89	4.52 157.65	3.88 307.16	1.31 324.56	14.28 48.60	5.42 69.92	2.50 207.96	2.06 206.73	1.71 170.24	0.28 94.93	0.29 50.33	Mag Phase

Table VI. - Continued

(r) Continued

Run 10

$\mu_{Nom.} = 0.225$

POINT	MEAN	1/2P-P	1P	2P	3P	4P	5P	6P	7P	8P	9P	10P	
342	-4.32	26.89	5.77 150.15	2.43 310.84	1.78 105.48	16.64 26.94	5.91 86.68	5.24 203.38	2.63 176.96	3.60 134.48	0.79 158.42	1.05 358.57	Mag Phase
343	0.26	32.55	10.41 140.58	1.35 64.10	4.93 154.66	18.42 15.95	6.71 131.44	5.51 176.56	1.35 174.60	1.57 350.90	0.77 137.88	1.69 34.04	Mag Phase
344	-8.44	26.30	3.92 151.71	2.23 315.97	1.69 174.00	17.72 39.99	4.56 64.53	4.40 208.10	2.57 203.64	3.87 112.98	0.54 115.69	0.51 29.15	Mag Phase
345	-4.18	26.71	5.96 154.92	2.71 324.92	1.29 134.81	16.51 20.13	5.26 97.58	5.43 200.35	3.33 170.75	4.12 127.15	0.85 140.53	0.97 6.79	Mag Phase
346	-3.43	24.08	3.52 158.09	2.73 317.35	0.44 160.18	14.00 29.07	6.11 84.58	4.71 201.01	2.89 172.20	3.54 130.32	0.97 130.96	0.84 4.29	Mag Phase



Table VI. - Continued

(s) Pitch link load, blade 1, lbs

Run 10

$\mu_{Nom.} = 0.08$

POINT	MEAN	1/2P-P	1P	2P	3P	4P	5P	6P	7P	8P	9P	10P	
281	7.22	6.28	3.57	3.32	0.89	1.11	1.19	0.97	0.42	0.41	0.07	0.07	Mag
			5.52	88.24	255.29	173.68	231.40	182.47	296.08	281.40	313.36	175.16	Phase
282	6.74	6.31	3.29	3.19	0.80	1.04	1.32	0.98	0.39	0.45	0.03	0.10	Mag
			2.15	94.10	254.84	180.86	242.39	174.36	300.39	289.47	166.28	152.63	Phase
283	6.22	5.84	3.05	2.69	0.72	0.89	1.27	0.88	0.29	0.50	0.03	0.11	Mag
			359.90	98.51	257.06	181.52	253.46	172.24	317.22	298.22	341.82	131.44	Phase

$\mu_{Nom.} = 0.11$

POINT	MEAN	1/2P-P	1P	2P	3P	4P	5P	6P	7P	8P	9P	10P	
284	6.30	5.25	3.45	2.32	0.30	1.15	1.08	0.66	0.34	0.46	0.03	0.12	Mag
			3.14	114.91	329.26	162.69	255.42	160.35	315.09	293.18	0.33	127.28	Phase
285	6.71	5.84	3.70	2.72	0.35	1.37	1.24	0.67	0.37	0.59	0.04	0.13	Mag
			5.13	110.54	333.88	164.47	250.55	158.59	296.53	283.59	36.57	128.87	Phase
286	7.35	6.71	3.92	3.25	0.47	1.73	1.50	0.54	0.41	0.65	0.04	0.12	Mag
			9.05	111.87	342.17	179.09	261.65	179.02	324.53	304.30	27.51	170.89	Phase

$\mu_{Nom.} = 0.13$

POINT	MEAN	1/2P-P	1P	2P	3P	4P	5P	6P	7P	8P	9P	10P	
287	7.33	6.15	4.16	3.08	0.76	1.77	0.80	0.52	0.42	0.44	0.12	0.09	Mag
			11.75	119.99	26.59	163.77	251.98	159.70	285.09	307.35	22.11	102.18	Phase
288	6.75	5.46	3.82	2.62	0.63	1.49	0.53	0.61	0.32	0.38	0.09	0.09	Mag
			13.02	131.15	39.89	171.56	270.54	180.27	313.88	340.90	64.07	135.48	Phase

Table VI. - Continued

(s) Continued

Run 10

$\mu_{\text{Nom.}} = 0.13$

POINT	MEAN	1/2P-P	1P	2P	3P	4P	5P	6P	7P	8P	9P	10P	
289	6.13	4.68	3.57 8.88	2.13 130.59	0.42 42.22	1.23 156.68	0.36 268.19	0.57 156.30	0.24 303.03	0.29 324.51	0.10 34.83	0.11 117.64	Mag Phase

$\mu_{\text{Nom.}} = 0.16$

POINT	MEAN	1/2P-P	1P	2P	3P	4P	5P	6P	7P	8P	9P	10P	
290	6.16	4.97	4.06 15.19	2.29 136.29	0.60 50.77	1.28 166.80	0.18 252.74	0.41 160.74	0.36 313.02	0.30 307.73	0.10 89.56	0.11 112.94	Mag Phase
291	6.63	5.54	4.24 14.51	2.65 128.09	0.78 29.81	1.36 167.42	0.36 250.31	0.30 173.75	0.40 298.60	0.37 300.03	0.09 43.89	0.10 89.93	Mag Phase
292	7.42	6.50	3.71 353.16	3.17 126.47	1.14 12.78	1.23 148.81	0.18 249.99	0.35 141.94	0.11 297.11	0.36 294.73	0.15 77.57	0.15 350.60	Mag Phase
293	6.09	5.61	4.81 26.28	2.32 124.27	0.55 15.82	1.63 177.30	0.39 285.68	0.12 179.17	0.31 328.77	0.41 317.39	0.10 125.02	0.11 115.99	Mag Phase
294	6.53	5.45	4.20 16.03	2.62 129.61	0.76 36.10	1.34 168.42	0.33 249.78	0.30 176.03	0.39 301.45	0.38 302.77	0.08 70.07	0.09 95.30	Mag Phase
295	6.64	5.05	3.45 23.09	2.63 123.63	0.31 40.56	1.51 165.55	0.41 238.67	0.35 191.97	0.32 311.59	0.29 301.43	0.05 25.86	0.11 119.24	Mag Phase
296	6.40	6.45	4.94 10.10	2.63 136.11	0.83 18.67	1.49 168.95	0.35 282.96	0.33 138.82	0.33 284.72	0.30 299.24	0.06 94.35	0.07 115.53	Mag Phase
297	6.53	5.56	4.23 15.91	2.70 129.82	0.77 35.72	1.35 166.00	0.31 255.51	0.31 173.89	0.40 302.31	0.38 306.04	0.10 57.63	0.08 96.57	Mag Phase

Table VI. - Continued

(s) Continued

Run 10

 $\mu_{\text{Nom.}} = 0.16$ 

POINT	MEAN	1/2P-P	1P	2P	3P	4P	5P	6P	7P	8P	9P	10P	
298	7.11	6.18	4.52 17.34	3.03 127.11	0.97 28.27	1.53 176.05	0.69 263.06	0.14 211.85	0.55 308.28	0.47 321.36	0.06 60.79	0.12 102.37	Mag Phase

 $\mu_{\text{Nom.}} = 0.20$ 

POINT	MEAN	1/2P-P	1P	2P	3P	4P	5P	6P	7P	8P	9P	10P	
299	7.12	7.20	5.37 18.03	2.83 119.47	1.60 353.09	1.45 182.52	1.04 274.80	0.17 269.70	0.41 319.39	0.56 344.45	0.02 227.20	0.10 93.59	Mag Phase
300	6.50	6.30	4.98 16.77	2.38 122.56	1.19 350.68	1.25 166.63	0.68 261.58	0.25 201.60	0.34 303.21	0.46 324.61	0.05 68.12	0.11 114.79	Mag Phase
301	7.17	7.25	4.62 8.24	3.09 134.82	1.63 13.29	1.23 171.94	0.55 275.54	0.40 169.46	0.38 351.17	0.45 347.21	0.12 63.69	0.05 42.56	Mag Phase
302	5.96	6.18	5.44 26.60	2.04 121.44	0.96 346.14	1.20 171.30	0.49 325.59	0.19 181.18	0.25 332.53	0.41 344.40	0.05 169.51	0.08 134.80	Mag Phase
303	6.47	6.32	4.94 20.97	2.38 132.50	1.23 5.89	1.27 188.05	0.69 286.35	0.24 224.30	0.33 331.97	0.44 0.89	0.05 115.13	0.13 158.79	Mag Phase
304	6.60	5.89	4.25 25.96	2.57 123.28	1.12 347.48	1.57 190.53	0.71 286.20	0.28 225.10	0.31 344.86	0.48 10.57	0.04 338.44	0.12 177.47	Mag Phase
305	6.34	6.73	5.62 18.41	2.21 143.28	1.25 9.63	1.13 189.48	0.52 324.37	0.36 191.93	0.31 326.26	0.35 1.94	0.03 136.23	0.11 157.92	Mag Phase
306	6.47	6.35	4.90 18.29	2.38 126.17	1.26 356.62	1.22 173.02	0.69 275.30	0.23 201.64	0.32 308.13	0.46 333.52	0.05 59.13	0.11 117.95	Mag Phase

Table VI. - Continued

(s) Continued

Run 10

 $\mu_{\text{Nom.}} = 0.20$ 

POINT	MEAN	1/2P-P	1P	2P	3P	4P	5P	6P	7P	8P	9P	10P	
307	5.80	5.40	4.56 17.02	1.94 128.18	0.83 354.92	1.11 154.09	0.30 280.53	0.32 154.31	0.17 302.08	0.32 330.93	0.09 70.50	0.13 106.31	Mag Phase

 $\mu_{\text{Nom.}} = 0.25$ 

POINT	MEAN	1/2P-P	1P	2P	3P	4P	5P	6P	7P	8P	9P	10P	
308	5.94	7.09	5.69 22.67	1.63 96.13	1.63 311.89	1.46 152.87	0.73 318.83	0.42 157.22	0.14 312.64	0.27 345.57	0.07 258.25	0.13 114.98	Mag Phase
309	6.52	7.93	6.07 24.27	2.29 92.59	2.30 326.78	1.68 180.58	0.95 324.01	0.37 203.04	0.27 329.93	0.39 352.27	0.13 293.74	0.08 131.38	Mag Phase
310	7.05	7.84	5.91 17.52	2.83 104.85	2.72 340.55	1.55 215.11	1.00 319.27	0.33 235.61	0.48 338.01	0.50 342.95	0.08 239.11	0.16 83.21	Mag Phase
311	5.90	8.30	6.36 28.94	1.90 79.93	2.17 308.33	1.49 164.74	0.69 321.88	0.30 173.74	0.15 327.07	0.27 13.16	0.12 256.91	0.10 145.22	Mag Phase
312	6.41	8.07	6.09 22.09	2.37 89.40	2.39 319.83	1.83 172.11	1.06 315.79	0.36 186.84	0.25 315.32	0.35 334.46	0.11 268.29	0.08 117.83	Mag Phase
313	6.58	7.98	5.51 27.87	2.78 86.53	2.65 317.73	2.04 192.44	1.14 324.92	0.36 209.35	0.27 316.37	0.39 359.53	0.16 268.64	0.10 172.43	Mag Phase
314	6.22	8.12	6.67 20.76	1.88 97.46	2.13 327.03	1.38 164.64	0.87 335.35	0.37 156.09	0.19 336.67	0.28 358.25	0.06 287.67	0.06 116.68	Mag Phase
315	6.37	7.95	6.12 24.11	2.31 91.82	2.30 323.40	1.73 178.45	1.01 325.53	0.37 193.97	0.29 330.45	0.33 351.01	0.12 286.02	0.09 134.40	Mag Phase

Table VI. - Continued

(s) Continued

Run 10

$\mu_{\text{Nom.}} = 0.25$

POINT	MEAN	1/2P-P	1P	2P	3P	4P	5P	6P	7P	8P	9P	10P	
316	7.15	9.49	6.59 24.35	3.31 84.04	3.28 322.31	2.45 193.84	1.41 323.80	0.40 213.27	0.31 311.07	0.43 342.34	0.19 270.40	0.10 140.86	Mag Phase

$\mu_{\text{Nom.}} = 0.30$

POINT	MEAN	1/2P-P	1P	2P	3P	4P	5P	6P	7P	8P	9P	10P	
317	7.65	18.22	7.85 25.44	6.77 32.59	8.07 285.89	6.22 165.63	3.13 308.50	1.86 183.82	1.71 262.89	0.37 270.30	0.47 299.11	0.03 130.51	Mag Phase
318	7.05	13.25	7.11 24.51	5.07 47.65	6.04 291.64	4.67 163.52	2.34 314.70	1.07 191.64	0.98 268.45	0.14 347.17	0.27 289.94	0.10 218.40	Mag Phase
319	7.62	14.40	7.18 21.87	5.64 49.33	6.67 298.96	5.22 174.75	2.39 328.96	1.47 189.93	1.26 277.97	0.31 308.30	0.38 315.10	0.04 305.34	Mag Phase
320	6.29	12.68	7.24 26.33	4.48 43.44	5.44 281.92	4.05 146.46	2.09 296.43	0.75 164.01	0.63 246.58	0.22 351.60	0.24 263.88	0.14 214.01	Mag Phase
321	7.01	12.98	7.07 24.33	4.98 48.26	5.96 291.84	4.58 162.89	2.31 312.77	0.99 190.60	0.90 265.73	0.09 344.44	0.26 288.76	0.10 214.75	Mag Phase
322	7.30	14.78	6.49 27.10	5.53 43.17	6.76 287.44	4.97 162.92	2.52 315.77	1.25 181.57	1.08 256.44	0.06 321.27	0.29 280.65	0.17 207.11	Mag Phase
323	6.75	12.35	7.52 20.65	4.23 47.77	5.13 290.57	3.92 151.39	2.02 303.38	0.92 173.88	0.69 257.73	0.13 320.63	0.22 285.09	0.10 243.29	Mag Phase
324	6.95	13.06	7.02 24.89	4.93 49.46	5.96 294.40	4.68 166.16	2.37 318.97	1.08 194.12	0.92 270.89	0.12 358.67	0.27 302.37	0.10 228.63	Mag Phase

Table VI. - Continued

(s) Continued

Run 10

$\mu_{Nom.} = 0.30$

POINT	MEAN	1/2P-P	1P	2P	3P	4P	5P	6P	7P	8P	9P	10P	
325	6.03	10.58	6.52 24.15	3.40 54.29	4.10 293.51	3.48 150.68	1.97 313.17	0.70 179.39	0.42 256.90	0.29 35.37	0.22 285.96	0.14 200.13	Mag Phase

$\mu_{Nom.} = 0.325$

POINT	MEAN	1/2P-P	1P	2P	3P	4P	5P	6P	7P	8P	9P	10P	
326	6.18	15.15	6.96 25.52	5.71 39.45	6.84 284.47	5.57 151.20	2.68 304.35	1.20 162.67	0.91 256.95	0.13 279.74	0.20 285.39	0.05 246.84	Mag Phase
327	6.91	19.12	7.68 26.25	7.15 29.35	8.58 282.46	6.77 156.15	3.78 304.54	1.89 167.97	1.70 262.03	0.33 236.96	0.45 288.01	0.01 62.26	Mag Phase
328	6.73	24.43	9.22 34.21	8.21 14.51	9.61 283.59	9.06 170.94	4.62 328.16	6.62 172.71	4.73 265.39	0.67 218.91	1.33 291.00	0.42 103.27	Mag Phase

$\mu_{Nom.} = 0.275$

POINT	MEAN	1/2P-P	1P	2P	3P	4P	5P	6P	7P	8P	9P	10P	
329	7.38	11.78	6.88 24.19	4.49 57.92	5.05 298.14	3.92 175.05	1.98 315.84	0.92 192.95	0.72 262.84	0.33 328.19	0.22 276.89	0.10 179.57	Mag Phase
330	6.44	9.68	6.47 23.20	3.04 68.23	3.32 303.93	2.62 161.48	1.58 312.32	0.51 174.69	0.23 280.12	0.32 4.86	0.16 274.97	0.12 122.53	Mag Phase
331	7.21	9.91	6.40 21.07	3.80 75.74	4.03 316.01	2.92 187.67	1.27 336.86	0.86 192.46	0.43 284.12	0.38 355.11	0.22 271.33	0.13 136.80	Mag Phase
332	5.70	9.58	6.70 28.99	2.42 62.32	2.88 299.67	1.89 149.43	1.24 302.87	0.31 153.41	0.19 302.88	0.28 26.66	0.15 271.31	0.06 186.01	Mag Phase

Table VI. - Continued

(s) Continued

Run 10

 $\mu_{\text{Nom.}} = 0.275$ 

POINT	MEAN	1/2P-P	1P	2P	3P	4P	5P	6P	7P	8P	9P	10P	
333	6.36	9.58	6.49 23.31	3.09 70.10	3.29 307.40	2.59 165.88	1.55 319.55	0.53 177.10	0.25 281.18	0.34 3.17	0.18 280.31	0.12 122.11	Mag Phase
334	6.61	9.72	5.98 26.67	3.87 69.25	3.91 305.18	2.77 177.19	1.47 315.75	0.46 211.33	0.39 274.34	0.40 16.23	0.20 283.79	0.13 188.24	Mag Phase
335	6.14	9.65	7.09 22.63	2.24 74.19	2.84 316.57	1.94 161.85	1.31 324.44	0.51 151.00	0.18 315.90	0.22 42.79	0.09 295.26	0.05 159.09	Mag Phase
336	6.35	9.67	6.61 24.76	3.03 71.77	3.29 309.85	2.63 169.42	1.72 327.66	0.50 183.75	0.24 303.39	0.34 25.61	0.19 292.15	0.14 138.88	Mag Phase
337	5.62	8.35	6.29 23.54	1.90 69.87	2.11 301.45	1.86 143.01	1.21 310.69	0.44 148.63	0.06 336.35	0.35 33.30	0.11 250.96	0.10 139.33	Mag Phase

 $\mu_{\text{Nom.}} = 0.225$ 

POINT	MEAN	1/2P-P	1P	2P	3P	4P	5P	6P	7P	8P	9P	10P	
338	6.66	7.67	6.01 21.99	2.86 106.59	2.22 348.20	1.57 183.37	0.75 336.22	0.29 182.95	0.34 317.75	0.42 348.84	0.13 318.42	0.09 65.35	Mag Phase
339	5.86	6.52	5.56 22.28	2.14 115.49	1.57 350.98	1.09 165.90	0.56 358.00	0.38 160.72	0.28 326.73	0.39 349.49	0.08 356.16	0.06 112.49	Mag Phase
340	6.51	6.97	5.33 12.57	2.87 119.91	2.04 1.99	0.80 191.57	0.36 349.02	0.35 119.12	0.21 331.13	0.16 3.56	0.04 82.34	0.16 18.49	Mag Phase
341	5.39	7.27	5.86 28.06	1.86 102.87	1.70 322.81	1.24 163.12	0.60 347.47	0.32 150.87	0.18 320.12	0.33 335.80	0.08 265.97	0.05 154.61	Mag Phase

Table VI. - Continued

(s) Concluded

Run 10

$\mu_{Nom.} = 0.225$

POINT	MEAN	1/2P-P	1P	2P	3P	4P	5P	6P	7P	8P	9P	10P	
342	5.87	6.76	5.53 19.66	2.24 113.09	1.74 344.98	1.19 165.93	0.74 352.45	0.39 147.99	0.27 323.84	0.39 337.95	0.10 326.07	0.06 99.31	Mag Phase
343	6.01	6.76	4.92 23.89	2.75 106.49	1.93 338.05	1.45 175.55	0.76 344.68	0.31 134.81	0.16 318.70	0.20 4.42	0.14 304.31	0.05 235.88	Mag Phase
344	5.63	6.93	6.09 16.78	1.85 123.88	1.71 347.22	0.80 153.79	0.72 348.79	0.40 130.80	0.26 315.52	0.36 328.63	0.04 349.02	0.03 3.57	Mag Phase
345	5.87	6.65	5.54 19.53	2.19 111.16	1.72 344.50	1.17 161.12	0.69 345.14	0.38 142.57	0.26 324.98	0.35 338.44	0.11 333.38	0.04 96.21	Mag Phase
346	5.16	5.76	5.15 20.32	1.68 120.97	1.10 340.56	1.08 141.25	0.56 5.81	0.51 139.77	0.09 311.61	0.29 342.33	0.05 311.35	0.05 124.21	Mag Phase



Table VI. - Continued

(t) Pitch link load, blade 2, lbs.

Run 10

$\mu_{Nom.} = 0.08$

POINT	MEAN	1/2P-P	1P	2P	3P	4P	5P	6P	7P	8P	9P	10P	
281	4.12	11.57	7.81 258.21	5.04 266.30	2.11 74.07	0.82 156.30	0.76 68.08	1.12 336.22	0.37 43.01	0.69 284.12	0.41 16.82	0.22 141.68	Mag Phase
282	4.26	12.36	8.83 253.66	5.13 262.89	2.41 68.89	0.31 143.56	0.48 127.70	1.02 315.92	0.45 52.64	0.69 275.42	0.46 359.15	0.45 125.61	Mag Phase
283	4.67	13.38	10.20 250.44	4.79 265.51	2.22 67.85	0.33 126.42	0.80 166.83	1.13 306.84	0.57 63.75	0.70 280.53	0.47 352.15	0.63 122.67	Mag Phase

$\mu_{Nom.} = 0.11$

POINT	MEAN	1/2P-P	1P	2P	3P	4P	5P	6P	7P	8P	9P	10P	
284	6.12	14.11	11.48 250.81	4.72 282.76	2.20 115.58	1.96 97.81	0.25 144.25	1.57 286.85	0.44 58.43	0.11 248.09	0.66 18.02	0.40 148.96	Mag Phase
285	5.73	12.69	10.26 255.22	5.08 282.58	1.86 118.60	1.81 101.68	0.56 83.27	1.50 289.40	0.43 35.88	0.30 257.21	0.50 20.19	0.37 137.42	Mag Phase
286	6.12	13.09	10.23 257.41	5.72 287.68	1.87 122.21	1.80 109.70	1.01 108.46	1.37 304.41	0.61 43.81	0.30 301.52	0.52 47.18	0.42 163.17	Mag Phase

$\mu_{Nom.} = 0.13$

POINT	MEAN	1/2P-P	1P	2P	3P	4P	5P	6P	7P	8P	9P	10P	
287	6.00	15.44	12.98 268.24	4.92 285.77	3.32 144.52	2.40 78.81	1.07 43.87	1.69 296.53	0.38 40.49	0.15 242.25	0.42 60.53	0.27 174.23	Mag Phase
288	6.01	16.17	13.81 268.26	4.62 285.62	3.04 150.01	2.83 85.36	0.96 50.85	2.08 306.32	0.33 66.19	0.16 119.90	0.50 76.62	0.25 223.28	Mag Phase

Table VI. - Continued

(t) Continued

Run 10

$\mu_{\text{Nom.}} = 0.13$

POINT	MEAN	1/2P-P	1P	2P	3P	4P	5P	6P	7P	8P	9P	10P	
289	6.21	17.20	15.27 262.22	3.96 276.90	2.75 131.38	2.96 77.55	0.56 33.78	2.30 281.28	0.25 66.75	0.37 90.10	0.52 38.71	0.36 205.19	Mag Phase

$\mu_{\text{Nom.}} = 0.16$

POINT	MEAN	1/2P-P	1P	2P	3P	4P	5P	6P	7P	8P	9P	10P	
290	4.85	15.17	13.52 277.00	2.88 298.41	3.26 170.02	1.32 97.67	1.62 35.86	1.46 331.65	0.15 247.48	0.63 259.43	0.41 64.64	0.46 165.05	Mag Phase
291	5.16	15.12	13.37 275.64	3.35 298.85	3.28 163.31	1.29 91.48	1.62 35.05	1.29 332.06	0.08 272.40	0.61 262.14	0.37 70.08	0.49 168.43	Mag Phase
292	6.35	15.32	11.54 238.57	5.24 271.22	3.02 84.24	1.26 30.24	1.16 56.65	0.83 199.63	0.65 60.43	0.73 287.56	1.07 320.84	0.62 109.79	Mag Phase
293	4.77	16.68	15.94 285.94	2.42 319.28	1.97 220.53	1.92 142.00	1.67 66.16	1.11 27.52	0.44 38.37	0.97 313.55	0.24 353.20	0.62 213.91	Mag Phase
294	5.20	15.53	13.80 276.92	2.99 300.59	3.27 167.80	1.38 94.69	1.76 39.67	1.27 331.77	0.13 282.26	0.64 262.47	0.31 76.54	0.52 168.06	Mag Phase
295	3.67	13.54	11.67 298.47	3.37 253.90	2.05 183.73	2.71 135.39	1.45 38.90	1.59 40.24	0.84 289.53	0.48 324.21	0.76 210.01	0.07 109.68	Mag Phase
296	5.80	16.08	13.82 261.55	4.35 300.50	3.60 152.20	0.38 128.69	1.53 16.94	0.90 352.48	0.06 231.49	0.15 240.09	0.37 55.16	0.37 143.92	Mag Phase
297	4.67	15.83	12.91 275.81	2.93 305.52	3.75 167.48	1.69 98.21	1.90 43.97	1.41 332.80	0.11 274.10	0.69 264.03	0.35 77.49	0.53 166.95	Mag Phase

Table VI. - Continued

(t) Continued

Run 10

 $\mu_{\text{Nom.}} = 0.16$ 

POINT	MEAN	1/2P-P	1P	2P	3P	4P	5P	6P	7P	8P	9P	10P	
298	4.90	13.72	12.17 279.43	3.89 303.35	3.32 158.90	1.34 110.82	1.55 46.76	0.97 2.87	0.39 332.43	0.72 289.68	0.24 93.56	0.49 198.61	Mag Phase

 $\mu_{\text{Nom.}} = 0.20$ 

POINT	MEAN	1/2P-P	1P	2P	3P	4P	5P	6P	7P	8P	9P	10P	
299	5.11	12.96	12.69 179.92	3.92 308.59	1.93 134.62	1.70 158.51	0.88 72.86	1.06 31.32	0.45 14.18	1.01 282.09	0.24 90.48	0.41 200.46	Mag Phase
300	4.65	12.99	13.37 280.56	3.34 296.23	1.64 154.63	2.12 144.00	1.22 38.38	0.88 6.10	0.35 341.58	0.92 269.54	0.21 106.49	0.42 172.68	Mag Phase
301	5.52	13.84	10.80 266.00	4.59 288.14	3.68 135.63	0.84 105.72	1.37 61.41	0.98 303.05	0.64 25.82	0.32 222.82	0.60 90.42	0.27 209.61	Mag Phase
302	4.02	17.02	15.27 289.52	1.91 297.53	0.87 314.90	2.99 152.71	0.79 76.39	1.04 40.32	0.55 46.64	0.98 316.88	0.22 348.15	0.51 224.53	Mag Phase
303	4.82	13.63	13.97 287.11	3.45 303.86	1.52 164.02	2.07 160.32	1.18 63.65	0.94 31.73	0.30 12.15	0.89 308.88	0.17 138.07	0.48 218.45	Mag Phase
304	3.75	13.66	13.26 306.86	3.55 273.18	0.56 147.07	2.99 181.24	0.96 77.53	1.62 72.87	0.63 352.48	0.77 351.07	0.44 255.01	0.39 296.41	Mag Phase
305	4.72	16.02	14.40 274.75	3.84 316.29	1.72 163.91	0.59 142.27	1.26 52.20	0.98 52.88	0.40 21.00	0.57 272.42	0.13 62.20	0.37 194.82	Mag Phase
306	4.56	12.78	13.21 282.50	3.68 299.41	1.54 145.02	1.94 149.53	1.08 38.46	0.91 17.28	0.29 339.19	0.89 282.44	0.18 100.20	0.45 190.88	Mag Phase

Table VI. - Continued

(t) Continued

Run 10

 $\mu_{\text{Nom.}} = 0.20$ 

POINT	MEAN	1/2P-P	1P	2P	3P	4P	5P	6P	7P	8P	9P	10P	
307	4.38	14.11	13.83 280.39	2.15 291.69	1.41 182.59	1.20 127.36	1.36 37.34	1.01 352.32	0.28 352.33	0.80 255.14	0.17 30.80	0.57 165.36	Mag Phase

 $\mu_{\text{Nom.}} = 0.25$ 

POINT	MEAN	1/2P-P	1P	2P	3P	4P	5P	6P	7P	8P	9P	10P	
308	3.32	15.03	13.23 284.40	4.18 284.74	2.10 28.47	3.92 153.88	0.66 269.98	0.71 7.28	0.25 346.56	0.87 290.61	0.06 300.27	0.40 206.94	Mag Phase
309	3.79	15.97	13.72 289.07	4.52 282.04	2.69 36.05	4.45 167.04	0.89 260.41	0.98 27.13	0.47 354.58	1.07 303.65	0.07 149.91	0.42 228.68	Mag Phase
310	4.38	16.10	12.32 285.03	6.11 276.73	3.35 65.78	3.78 181.27	0.75 273.09	0.98 27.04	0.59 349.98	1.06 290.93	0.38 174.93	0.47 211.73	Mag Phase
311	2.52	17.13	14.29 294.13	4.45 265.86	3.37 11.48	4.49 163.23	1.40 235.81	0.58 48.77	0.33 1.91	0.57 328.10	0.10 2.40	0.28 274.28	Mag Phase
312	3.66	14.36	12.76 287.73	4.00 276.43	2.35 35.97	3.59 161.27	0.77 243.38	0.98 16.45	0.28 325.37	0.90 285.67	0.03 83.70	0.38 208.81	Mag Phase
313	3.31	15.00	11.81 299.04	4.70 267.35	2.74 35.45	4.40 181.50	0.68 262.14	1.14 35.84	0.72 332.12	0.80 327.39	0.20 200.96	0.32 303.51	Mag Phase
314	3.31	16.17	14.58 280.25	4.65 280.78	3.03 48.51	3.51 152.75	0.78 285.95	1.27 17.07	0.71 333.99	0.99 274.78	0.09 205.19	0.43 176.62	Mag Phase
315	3.36	15.84	13.92 290.84	3.86 280.38	2.30 38.43	4.12 165.14	0.80 257.62	1.03 23.69	0.38 347.19	1.04 298.55	0.07 114.12	0.41 217.91	Mag Phase

Table VI. - Continued

(t) Continued

Run 10

$\mu_{Nom.} = 0.25$

POINT	MEAN	1/2P-P	1P	2P	3P	4P	5P	6P	7P	8P	9P	10P	
316	4.28	15.73	13.11 290.31	3.81 267.42	3.41 33.19	4.19 172.22	1.19 246.57	1.39 22.72	0.33 339.34	1.02 288.46	0.24 125.76	0.34 233.53	Mag Phase

$\mu_{Nom.} = 0.30$

POINT	MEAN	1/2P-P	1P	2P	3P	4P	5P	6P	7P	8P	9P	10P	
317	0.90	30.37	14.82 299.56	4.91 189.74	6.03 352.30	8.51 149.88	8.14 248.15	8.30 309.64	3.70 334.91	0.69 139.71	0.83 150.41	0.58 283.88	Mag Phase
318	1.33	25.11	13.73 298.00	4.93 214.42	5.58 9.10	8.23 153.65	6.44 246.37	4.94 315.60	2.25 348.21	0.13 203.80	0.46 162.55	0.24 251.25	Mag Phase
319	1.56	24.53	11.64 296.91	5.50 215.34	5.31 19.00	7.48 164.12	6.41 255.29	6.23 326.45	2.84 356.21	0.43 178.42	0.70 184.25	0.22 340.21	Mag Phase
320	0.35	25.31	14.52 299.80	5.94 214.73	7.05 2.39	7.97 140.70	6.91 229.93	3.81 291.62	1.79 338.69	0.44 42.01	0.27 139.93	0.16 278.02	Mag Phase
321	1.34	24.38	13.48 298.41	5.08 216.80	5.79 11.35	7.89 153.30	6.50 244.41	4.70 315.01	2.13 347.51	0.11 174.80	0.47 158.80	0.23 241.06	Mag Phase
322	1.34	25.44	13.10 307.64	5.04 199.63	5.71 0.94	7.74 152.87	6.50 243.75	5.41 311.42	2.68 329.90	0.50 103.00	0.74 137.19	0.56 305.72	Mag Phase
323	0.95	25.10	14.69 291.94	5.04 224.32	6.34 13.40	8.15 151.09	6.49 246.21	4.35 315.33	2.25 343.13	0.15 200.71	0.25 149.30	0.16 211.19	Mag Phase
324	0.99	24.46	13.17 300.78	5.59 215.21	6.05 14.29	7.83 156.00	6.69 264.41	5.14 319.36	2.17 358.28	0.17 133.81	0.52 184.09	0.15 260.76	Mag Phase

Table VI. - Continued

(t) Continued

Run 10

$\mu_{Nom.} = 0.30$

POINT	MEAN	1/2P-P	1P	2P	3P	4P	5P	6P	7P	8P	9P	10P	
325	0.59	21.30	12.75 298.89	5.84 228.56	6.12 12.84	7.24 151.48	5.28 239.32	3.25 312.09	1.26 350.78	0.23 305.49	0.28 194.71	0.17 204.59	Mag Phase

$\mu_{Nom.} = 0.325$

POINT	MEAN	1/2P-P	1P	2P	3P	4P	5P	6P	7P	8P	9P	10P	
326	-1.11	30.57	13.13 304.68	6.36 200.76	6.84 359.93	9.29 140.13	9.32 238.73	7.67 300.44	3.17 341.96	0.52 90.95	0.66 153.94	0.24 255.77	Mag Phase
327	-0.50	34.00	14.17 305.29	5.06 180.41	5.71 353.04	9.24 140.70	10.19 249.26	10.26 306.81	4.72 339.99	1.06 98.05	0.93 154.36	0.71 281.48	Mag Phase
328	-1.33	42.02	16.29 311.17	6.63 161.63	7.67 331.72	10.67 130.73	12.28 266.34	16.90 308.85	7.66 325.89	1.39 109.96	1.18 138.60	1.61 291.93	Mag Phase

$\mu_{Nom.} = 0.275$

POINT	MEAN	1/2P-P	1P	2P	3P	4P	5P	6P	7P	8P	9P	10P	
329	3.55	19.58	12.62 290.25	4.88 231.53	5.58 18.45	5.75 162.26	4.51 239.41	3.22 315.76	1.28 332.93	0.43 242.74	0.42 158.67	0.03 314.44	Mag Phase
330	3.69	17.77	13.37 289.62	3.96 254.29	4.39 20.22	5.31 158.15	2.83 247.52	1.37 345.59	0.53 347.60	0.87 287.33	0.29 134.25	0.26 239.77	Mag Phase
331	3.99	17.38	11.94 284.88	4.16 255.43	3.71 31.67	5.23 158.48	3.62 250.55	2.81 327.98	1.06 322.66	0.78 252.83	0.49 136.95	0.21 181.80	Mag Phase
332	2.53	21.07	14.45 296.56	4.49 244.15	5.84 11.32	6.57 161.64	3.47 250.77	0.91 324.72	0.52 344.16	0.45 332.28	0.13 136.63	0.20 316.08	Mag Phase

Table VI. - Continued

(t) Continued

Run 10

$\mu_{Nom.} = 0.275$

POINT	MEAN	1/2P-P	1P	2P	3P	4P	5P	6P	7P	8P	9P	10P	
333	3.59	17.20	12.97 289.89	4.23 258.52	4.54 26.33	5.25 165.66	2.98 253.85	1.39 342.02	0.57 334.18	0.64 283.71	0.20 144.09	0.18 251.10	Mag Phase
334	3.25	17.98	11.88 300.45	5.22 243.89	5.12 20.99	5.96 167.07	3.30 253.37	2.21 328.33	1.25 327.02	0.39 286.77	0.22 198.19	0.33 317.72	Mag Phase
335	2.97	18.06	12.69 282.04	5.72 255.74	5.24 36.86	4.76 173.81	2.63 262.46	1.57 353.53	0.73 335.73	0.47 294.31	0.25 208.49	0.20 129.70	Mag Phase
336	3.65	17.93	13.77 293.23	3.65 256.03	4.04 24.34	5.29 169.53	2.75 253.61	1.67 1.64	0.47 351.67	0.78 301.26	0.24 136.53	0.36 254.47	Mag Phase
337	3.18	17.68	13.57 290.21	3.43 260.53	3.98 15.08	5.18 157.52	2.68 245.19	1.12 352.28	0.28 322.68	0.93 300.31	0.17 134.54	0.40 243.31	Mag Phase

$\mu_{Nom.} = 0.225$

POINT	MEAN	1/2P-P	1P	2P	3P	4P	5P	6P	7P	8P	9P	10P	
338	5.50	14.12	12.34 283.82	4.83 288.42	2.01 78.27	3.30 173.19	0.36 357.78	0.82 33.53	0.46 341.07	0.78 299.79	0.11 228.14	0.41 218.02	Mag Phase
339	4.85	13.55	12.90 283.55	3.88 298.55	1.16 75.45	3.25 164.79	0.36 12.21	0.70 22.95	0.29 347.97	0.78 309.96	0.05 279.79	0.49 227.00	Mag Phase
340	5.34	13.14	11.58 279.54	5.12 288.38	2.67 104.98	1.72 172.33	0.78 38.45	0.84 344.02	0.44 8.27	0.76 253.27	0.14 58.14	0.48 197.31	Mag Phase
341	3.98	16.30	14.66 286.88	4.43 287.61	1.14 13.62	4.07 162.92	0.15 13.49	1.00 57.62	0.66 15.33	0.72 327.45	0.30 288.71	0.45 245.84	Mag Phase

Table VI. - Continued

(t) Continued

Run 10

$\mu_{Nom.} = 0.225$

POINT	MEAN	1/2P-P	1P	2P	3P	4P	5P	6P	7P	8P	9P	10P	
342	4.72	14.35	13.98 283.63	4.79 291.97	1.11 118.31	3.25 156.15	0.69 20.30	0.81 21.71	0.38 332.08	0.81 296.19	0.14 211.59	0.51 207.42	Mag Phase
343	4.17	13.72	12.52 299.60	4.70 273.49	1.06 78.22	3.51 170.44	0.64 36.65	1.12 41.12	0.51 324.55	0.73 322.41	0.31 223.61	0.44 265.51	Mag Phase
344	4.73	15.91	14.33 271.75	4.72 292.67	1.44 94.58	2.70 148.01	0.99 6.27	1.08 13.41	0.60 315.23	0.68 273.86	0.15 246.01	0.43 180.93	Mag Phase
345	4.80	13.78	13.40 282.73	4.45 293.69	1.20 105.84	3.18 154.39	0.60 13.27	0.68 7.17	0.38 327.60	0.79 286.56	0.08 198.86	0.46 205.76	Mag Phase
346	4.19	13.60	13.25 284.32	3.75 293.52	0.79 116.02	2.78 153.72	0.67 18.81	0.63 12.15	0.20 335.10	0.70 298.63	0.05 268.59	0.45 209.78	Mag Phase



Table VI. - Continued

(u) Pitch link load, blade 3, lbs

Run 10

$\mu_{Nom.} = 0.08$

POINT	MEAN	1/2P-P	1P	2P	3P	4P	5P	6P	7P	8P	9P	10P	
281	11.46	8.92	5.21 152.57	3.01 67.48	1.53 38.86	0.93 129.41	1.60 75.51	1.30 192.34	0.27 109.40	0.51 322.87	0.12 61.26	0.20 117.79	Mag Phase
282	11.59	8.77	4.96 153.26	2.90 74.16	1.59 35.79	1.02 122.56	1.83 73.35	0.95 169.13	0.27 72.45	0.47 329.76	0.17 98.82	0.20 99.53	Mag Phase
283	11.33	8.69	4.85 154.51	2.59 79.97	1.47 39.25	1.15 125.47	2.01 84.24	0.89 161.97	0.25 93.13	0.34 343.39	0.22 121.18	0.19 112.15	Mag Phase

$\mu_{Nom.} = 0.11$

POINT	MEAN	1/2P-P	1P	2P	3P	4P	5P	6P	7P	8P	9P	10P	
284	10.91	8.74	5.33 165.28	2.90 97.70	0.85 23.59	1.66 116.12	1.75 83.61	0.84 146.05	0.48 128.66	0.43 307.14	0.06 212.35	0.16 114.63	Mag Phase
285	11.48	9.38	5.49 165.00	3.15 94.78	0.99 22.39	1.76 116.67	2.03 73.17	0.86 142.85	0.59 119.14	0.54 299.33	0.03 262.95	0.22 93.22	Mag Phase
286	12.14	10.27	5.67 165.56	3.57 97.59	1.09 36.77	1.94 129.55	2.10 84.28	0.75 161.07	0.69 145.52	0.63 324.66	0.07 322.45	0.24 113.20	Mag Phase

$\mu_{Nom.} = 0.13$

POINT	MEAN	1/2P-P	1P	2P	3P	4P	5P	6P	7P	8P	9P	10P	
287	12.03	8.87	5.82 173.44	3.09 94.46	0.96 35.59	2.03 128.09	1.69 60.44	0.42 123.10	0.44 120.97	0.59 325.09	0.09 225.09	0.20 59.51	Mag Phase
288	11.53	8.07	5.53 178.20	2.51 99.40	0.86 41.30	1.95 142.23	1.64 74.16	0.57 148.71	0.37 143.84	0.48 350.17	0.13 259.12	0.18 91.83	Mag Phase

Table VI. - Continued

(u) Continued

Run 10

$\mu_{\text{Nom.}} = 0.13$

POINT	MEAN	1/2P-P	1P	2P	3P	4P	5P	6P	7P	8P	9P	10P	
289	10.30	6.43	4.88 182.82	2.21 103.45	0.56 30.47	1.66 126.12	1.40 54.37	0.65 136.01	0.31 121.95	0.34 336.75	0.14 246.28	0.16 66.93	Mag Phase

$\mu_{\text{Nom.}} = 0.16$

POINT	MEAN	1/2P-P	1P	2P	3P	4P	5P	6P	7P	8P	9P	10P	
290	10.46	6.69	5.51 186.16	2.03 109.97	0.86 36.19	1.60 131.97	1.68 71.40	0.26 153.72	0.52 128.77	0.41 323.88	0.21 255.99	0.20 71.67	Mag Phase
291	11.17	7.88	5.95 182.02	2.33 94.34	0.91 39.76	1.81 130.72	2.00 66.58	0.07 195.81	0.57 125.51	0.54 310.63	0.24 244.00	0.21 61.51	Mag Phase
292	12.26	9.03	5.60 160.49	2.55 97.79	0.81 61.61	2.18 109.14	1.62 42.30	0.48 83.32	0.38 126.84	0.06 270.93	0.26 215.42	0.07 103.72	Mag Phase
293	10.73	7.78	6.45 194.92	2.45 95.89	1.07 57.26	1.27 157.36	1.92 71.10	0.46 258.60	0.63 139.74	0.45 326.34	0.17 268.65	0.18 99.77	Mag Phase
294	11.52	7.96	6.15 180.77	2.30 95.34	1.03 38.03	1.82 133.40	1.83 66.59	0.12 168.52	0.60 125.35	0.57 317.75	0.20 244.27	0.23 68.01	Mag Phase
295	10.58	7.65	5.14 179.88	2.49 92.60	1.09 55.41	1.87 133.66	1.65 58.18	0.32 226.93	0.63 141.28	0.50 308.15	0.17 252.94	0.19 61.84	Mag Phase
296	11.11	8.20	7.17 181.30	2.15 105.81	1.03 29.07	1.58 136.50	1.72 74.66	0.13 168.12	0.51 102.83	0.46 308.04	0.23 258.11	0.17 41.32	Mag Phase
297	11.35	8.43	6.46 179.33	2.63 104.96	1.08 32.77	1.85 126.60	1.94 68.61	0.13 229.75	0.63 130.12	0.54 317.66	0.23 240.88	0.19 66.20	Mag Phase

Table VI. - Continued

(u) Continued

Run 10

$\mu_{\text{Nom.}} = 0.16$

POINT	MEAN	1/2P-P	1P	2P	3P	4P	5P	6P	7P	8P	9P	10P	
298	11.51	9.15	6.45 177.18	2.95 106.04	1.03 44.56	1.94 132.39	2.05 73.25	0.20 296.05	0.67 138.81	0.59 330.07	0.23 253.84	0.19 82.50	Mag Phase

$\mu_{\text{Nom.}} = 0.20$

POINT	MEAN	1/2P-P	1P	2P	3P	4P	5P	6P	7P	8P	9P	10P	
299	11.39	9.46	7.27 179.09	2.59 96.28	1.60 60.11	2.11 122.82	2.28 84.94	0.25 10.45	0.39 153.24	0.60 328.16	0.18 300.08	0.20 72.33	Mag Phase
300	10.72	8.32	6.82 178.17	1.98 95.19	1.36 52.33	1.78 120.60	1.98 80.20	0.05 116.08	0.44 132.35	0.56 329.12	0.19 269.23	0.15 75.56	Mag Phase
301	11.62	9.29	6.42 170.90	2.24 111.98	1.21 70.94	2.58 125.22	2.06 96.06	0.36 116.51	0.17 142.83	0.45 355.80	0.09 224.13	0.08 78.18	Mag Phase
302	10.58	8.34	7.39 193.72	2.35 95.11	1.68 71.75	1.29 140.48	1.66 85.18	0.28 267.89	0.40 153.21	0.41 346.63	0.16 250.98	0.19 113.25	Mag Phase
303	10.94	8.43	6.88 182.27	2.11 104.21	1.45 66.65	1.81 135.96	1.99 101.88	0.02 240.22	0.40 166.42	0.57 0.20	0.19 314.90	0.18 125.08	Mag Phase
304	10.30	8.71	6.46 182.85	2.34 100.55	1.50 79.37	2.00 135.14	2.08 96.76	0.18 229.68	0.40 180.35	0.56 7.44	0.15 344.57	0.13 144.95	Mag Phase
305	10.94	9.01	8.08 189.60	1.99 107.48	1.53 66.33	1.74 149.82	1.90 111.41	0.18 149.94	0.38 143.36	0.54 350.86	0.20 320.31	0.13 110.43	Mag Phase
306	10.69	8.59	7.00 180.58	2.19 94.74	1.50 50.14	1.86 121.69	2.02 86.61	0.05 203.23	0.43 143.17	0.58 328.45	0.17 287.38	0.17 80.83	Mag Phase

Table VI. - Continued

(u) Continued

Run 10

 $\mu_{\text{Nom.}} = 0.20$ 

POINT	MEAN	1/2P-P	1P	2P	3P	4P	5P	6P	7P	8P	9P	10P	
307	9.94	7.83	6.42 179.30	1.64 95.16	1.10 48.25	1.63 122.52	1.80 82.71	0.25 162.11	0.33 117.36	0.50 329.52	0.16 258.62	0.15 76.65	Mag Phase

 $\mu_{\text{Nom.}} = 0.25$ 

POINT	MEAN	1/2P-P	1P	2P	3P	4P	5P	6P	7P	8P	9P	10P	
308	9.19	9.42	7.87 182.76	2.31 68.51	2.68 81.92	1.86 132.08	1.57 80.16	0.48 186.93	0.27 83.23	0.58 307.35	0.10 179.94	0.12 84.19	Mag Phase
309	9.92	10.15	8.30 185.19	2.52 77.23	2.87 90.03	2.03 143.60	1.91 86.73	0.37 222.70	0.40 106.78	0.70 326.41	0.03 280.21	0.10 138.88	Mag Phase
310	10.60	10.56	7.87 176.70	2.52 83.24	2.81 85.69	2.61 129.55	2.53 97.19	0.26 210.58	0.43 109.05	0.64 320.51	0.08 157.68	0.12 68.24	Mag Phase
311	10.52	11.82	9.21 199.43	2.74 70.11	3.07 84.97	1.88 142.98	1.62 82.49	0.45 248.51	0.31 108.52	0.53 336.59	0.04 224.20	0.14 147.08	Mag Phase
312	9.91	9.99	8.26 182.82	2.60 74.79	2.86 83.99	2.10 131.77	1.96 80.08	0.35 213.80	0.35 88.23	0.66 308.30	0.04 250.10	0.08 107.46	Mag Phase
313	10.11	10.06	7.82 189.20	2.62 73.75	3.07 88.02	2.46 137.89	2.42 94.01	0.49 189.31	0.43 83.74	0.63 319.79	0.10 13.15	0.09 100.08	Mag Phase
314	11.08	11.38	9.52 191.78	2.42 77.49	2.82 81.03	2.04 140.21	1.81 89.79	0.45 202.25	0.36 105.73	0.67 312.87	0.09 322.13	0.11 108.70	Mag Phase
315	9.88	10.15	8.42 184.27	2.49 75.10	2.85 88.95	2.07 139.87	1.86 89.07	0.27 221.06	0.34 97.51	0.66 318.85	0.04 293.74	0.08 117.64	Mag Phase

Table VI. - Continued

(u) Continued

Run 10

$\mu_{\text{Nom.}} = 0.25$

POINT	MEAN	1/2P-P	1P	2P	3P	4P	5P	6P	7P	8P	9P	10P	
316	10.81	10.96	8.95 184.89	2.77 74.77	3.35 90.63	2.04 142.97	2.35 87.72	0.54 260.32	0.57 93.86	0.77 312.65	0.06 129.21	0.05 86.25	Mag Phase

$\mu_{\text{Nom.}} = 0.30$

POINT	MEAN	1/2P-P	1P	2P	3P	4P	5P	6P	7P	8P	9P	10P	
317	10.58	17.56	9.48 188.20	6.53 46.53	7.27 105.58	3.68 185.49	1.33 2.70	3.18 241.25	1.49 89.93	0.50 266.64	0.64 99.32	0.30 230.67	Mag Phase
318	10.23	14.02	9.05 187.47	5.04 56.41	5.48 103.00	3.30 154.72	1.02 40.45	1.57 233.02	0.60 69.95	0.18 319.72	0.22 105.65	0.17 225.60	Mag Phase
319	10.78	14.02	9.37 181.48	5.19 57.44	5.32 108.69	2.65 168.65	1.27 57.92	1.99 256.86	0.90 105.81	0.65 298.77	0.46 118.25	0.11 278.99	Mag Phase
320	10.72	15.50	10.18 201.51	5.19 50.67	5.20 92.40	2.80 150.60	1.19 44.70	1.26 235.16	0.39 65.98	0.39 7.75	0.04 338.87	0.24 157.06	Mag Phase
321	10.78	14.44	9.36 191.38	5.10 54.34	5.21 100.31	3.31 155.39	0.98 30.97	1.78 232.40	0.62 73.27	0.22 283.29	0.28 91.91	0.16 205.11	Mag Phase
322	10.33	14.51	9.07 191.11	5.40 49.87	5.98 99.57	3.51 161.61	0.82 62.36	1.81 231.27	0.95 75.96	0.32 301.87	0.34 74.82	0.32 199.02	Mag Phase
323	11.21	15.56	10.52 195.02	5.43 52.86	4.99 94.07	3.15 141.56	1.13 43.97	1.71 234.82	0.42 86.22	0.37 290.67	0.23 117.17	0.04 352.66	Mag Phase
324	10.99	14.28	9.33 192.85	5.06 56.38	4.99 102.20	3.16 155.81	0.99 36.73	1.62 240.29	0.56 79.43	0.09 315.18	0.26 109.53	0.12 204.86	Mag Phase

Table VI. - Continued

(u) Continued

Run 10

$\mu_{Nom.} = 0.30$

POINT	MEAN	1/2P-P	1P	2P	3P	4P	5P	6P	7P	8P	9P	10P	
325	10.71	12.69	9.23 192.72	3.76 57.90	3.93 93.36	2.88 137.28	1.13 55.22	0.94 232.55	0.31 64.14	0.17 9.47	0.07 66.27	0.17 196.17	Mag Phase

$\mu_{Nom.} = 0.325$

POINT	MEAN	1/2P-P	1P	2P	3P	4P	5P	6P	7P	8P	9P	10P	
326	9.42	16.00	8.70 191.29	6.86 53.18	7.04 109.92	4.26 163.34	0.67 353.97	1.67 218.70	0.56 87.71	0.28 72.78	0.17 162.28	0.13 213.52	Mag Phase
327	9.94	19.72	8.85 193.51	8.39 47.87	9.12 108.24	5.36 175.49	0.51 315.94	2.91 225.36	1.52 98.47	0.12 217.86	0.37 99.83	0.27 239.49	Mag Phase
328	10.28	21.65	8.72 191.25	10.48 38.46	10.01 110.12	4.78 195.72	1.42 344.94	4.84 237.44	3.60 103.96	1.23 250.48	1.24 70.66	0.66 230.96	Mag Phase

$\mu_{Nom.} = 0.275$

POINT	MEAN	1/2P-P	1P	2P	3P	4P	5P	6P	7P	8P	9P	10P	
329	10.36	12.90	8.55 188.61	3.64 58.13	5.02 91.03	2.87 153.07	1.73 50.56	1.59 221.79	0.92 78.65	0.77 274.98	0.22 79.50	0.15 181.75	Mag Phase
330	9.63	11.48	8.39 186.94	2.62 70.61	3.84 86.39	2.74 136.17	1.72 77.56	0.56 225.84	0.40 95.31	0.51 298.43	0.08 45.83	0.08 134.49	Mag Phase
331	9.86	11.20	8.04 181.27	3.36 62.64	3.99 89.12	3.09 146.52	1.68 67.88	1.13 221.57	0.69 85.46	0.69 273.28	0.22 73.70	0.08 204.41	Mag Phase
332	10.31	12.50	8.99 204.33	3.03 69.39	3.72 91.00	2.23 145.25	1.66 75.49	0.96 239.35	0.37 113.47	0.40 351.02	0.09 20.41	0.30 165.48	Mag Phase

Table VI. - Continued

(u) Continued

Run 10

$\mu_{Nom.} = 0.275$

POINT	MEAN	1/2P-P	1P	2P	3P	4P	5P	6P	7P	8P	9P	10P	
333	10.76	12.42	8.84 195.23	2.90 64.93	3.92 79.07	2.98 134.06	2.07 72.45	0.74 217.07	0.39 93.67	0.58 296.10	0.12 43.00	0.10 118.13	Mag Phase
334	9.36	11.45	8.05 190.95	3.16 58.54	4.05 83.67	3.05 132.60	1.87 70.20	0.86 199.44	0.58 66.10	0.52 285.97	0.21 39.71	0.10 153.92	Mag Phase
335	10.86	12.75	9.64 197.29	2.89 74.27	3.64 84.94	3.00 138.61	1.81 75.83	1.09 223.95	0.52 110.40	0.63 318.40	0.08 52.75	0.09 80.17	Mag Phase
336	10.77	12.31	9.01 196.86	2.96 69.35	3.85 85.06	2.99 141.20	2.00 83.74	0.82 224.88	0.50 108.40	0.57 309.33	0.13 45.09	0.09 143.65	Mag Phase
337	9.98	11.93	8.69 193.20	2.65 61.52	3.61 80.05	2.79 131.42	1.85 75.07	0.52 187.93	0.19 90.95	0.52 316.35	0.13 16.84	0.07 120.36	Mag Phase

$\mu_{Nom.} = 0.225$

POINT	MEAN	1/2P-P	1P	2P	3P	4P	5P	6P	7P	8P	9P	10P	
338	11.05	9.42	8.22 188.50	2.76 90.70	2.07 79.27	2.23 122.00	2.04 96.53	0.05 170.95	0.35 130.56	0.70 331.27	0.14 251.06	0.20 57.94	Mag Phase
339	10.32	9.02	8.05 188.38	2.30 98.98	1.67 80.72	2.03 127.92	1.90 102.70	0.25 219.87	0.33 131.94	0.75 342.04	0.16 245.87	0.17 70.74	Mag Phase
340	11.11	9.95	7.66 176.90	2.47 108.28	1.54 61.91	2.99 110.80	2.08 95.78	0.35 117.07	0.28 112.44	0.38 343.09	0.17 213.22	0.22 2.67	Mag Phase
341	9.60	9.70	7.95 194.79	2.50 78.06	2.47 85.44	1.53 137.68	1.67 88.83	0.34 227.73	0.27 116.28	0.46 341.75	0.13 237.32	0.06 118.27	Mag Phase

Table VI. - Continued

(u) Continued

Run 10

 $\mu_{\text{Nom.}} = 0.225$ 

POINT	MEAN	1/2P-P	1P	2P	3P	4P	5P	6P	7P	8P	9P	10P	
342	10.21	8.71	7.78 186.98	2.48 88.37	1.90 77.60	2.03 122.98	1.92 92.75	0.22 191.02	0.33 125.74	0.73 324.73	0.19 243.29	0.20 58.95	Mag Phase
343	9.98	9.17	7.25 187.97	2.64 92.02	2.20 75.57	2.54 122.22	1.95 98.15	0.29 199.73	0.27 146.52	0.59 339.47	0.13 281.34	0.15 86.08	Mag Phase
344	9.99	9.22	8.39 185.93	1.92 90.69	1.97 75.40	1.66 124.92	1.74 98.09	0.25 170.69	0.43 115.88	0.61 318.52	0.12 273.41	0.12 25.78	Mag Phase
345	10.30	8.86	7.96 185.90	2.29 90.39	1.89 73.68	2.12 117.31	1.82 94.33	0.24 179.08	0.34 116.26	0.70 322.35	0.14 243.18	0.16 59.35	Mag Phase
346	9.70	8.61	7.58 186.06	1.82 94.38	1.74 69.13	2.00 117.97	1.72 94.90	0.40 181.28	0.35 109.05	0.64 329.33	0.15 222.14	0.15 49.57	Mag Phase



Table VI. - Continued

(v) Pitch link load, blade 4, lbs

Run 10

$\mu_{Nom.} = 0.08$

POINT	MEAN	1/2P-P	1P	2P	3P	4P	5P	6P	7P	8P	9P	10P	
281	5.57	13.17	9.07 24.31	3.13 263.69	0.91 348.22	0.48 141.94	1.60 32.29	1.45 14.12	0.72 196.29	0.51 332.54	0.24 104.09	0.23 74.73	Mag Phase
282	5.05	11.25	7.37 27.41	2.98 259.73	0.40 263.11	0.24 103.39	1.75 25.23	1.30 349.48	0.79 195.15	0.50 320.49	0.27 122.43	0.25 100.48	Mag Phase
283	2.51	10.06	5.81 37.82	3.57 259.04	0.92 245.07	0.62 42.68	1.91 25.31	0.96 351.20	0.91 221.27	0.31 316.92	0.25 131.81	0.43 120.61	Mag Phase

$\mu_{Nom.} = 0.11$

POINT	MEAN	1/2P-P	1P	2P	3P	4P	5P	6P	7P	8P	9P	10P	
284	2.05	10.14	5.19 54.27	3.56 265.92	0.63 302.44	1.92 80.79	1.72 30.26	1.59 312.05	0.84 240.26	0.17 62.96	0.41 194.58	0.14 169.53	Mag Phase
285	3.46	10.20	5.13 51.27	4.01 275.44	0.53 323.93	1.74 85.06	1.70 23.91	1.83 318.42	0.69 228.95	0.05 354.36	0.33 213.09	0.08 128.71	Mag Phase
286	5.35	11.21	5.94 45.36	4.18 281.13	0.60 330.25	1.62 99.11	1.83 35.90	1.85 342.18	0.69 250.27	0.25 340.17	0.40 254.49	0.10 135.07	Mag Phase

$\mu_{Nom.} = 0.13$

POINT	MEAN	1/2P-P	1P	2P	3P	4P	5P	6P	7P	8P	9P	10P	
287	4.52	10.02	4.85 68.22	4.49 274.35	1.06 354.20	2.20 96.27	1.25 28.65	1.75 327.05	0.55 222.76	0.08 34.26	0.38 296.10	0.27 282.09	Mag Phase
288	2.23	9.82	4.23 73.81	4.38 274.57	1.22 356.02	2.51 108.92	1.23 51.16	1.92 340.94	0.47 254.10	0.20 102.03	0.42 313.54	0.34 322.48	Mag Phase

Table VI. - Continued

(v) Continued

Run 10

 $\mu_{\text{Nom.}} = 0.13$ 

POINT	MEAN	1/2P-P	1P	2P	3P	4P	5P	6P	7P	8P	9P	10P	
289	1.23	9.42	4.27 73.19	3.73 263.94	0.37 352.40	2.60 93.97	1.41 37.04	1.86 318.07	0.48 225.45	0.30 86.62	0.42 280.67	0.41 282.23	Mag Phase

 $\mu_{\text{Nom.}} = 0.16$ 

POINT	MEAN	1/2P-P	1P	2P	3P	4P	5P	6P	7P	8P	9P	10P	
290	0.02	7.29	3.53 117.47	3.38 272.34	1.27 10.67	1.56 128.48	0.59 115.24	1.49 5.88	0.12 156.92	0.39 336.14	0.24 303.27	0.12 275.89	Mag Phase
291	1.16	7.12	3.53 105.63	3.41 278.13	1.55 8.23	1.64 121.52	0.43 87.73	1.55 359.72	0.16 168.28	0.47 320.88	0.25 290.84	0.11 249.47	Mag Phase
292	2.21	10.31	4.63 20.59	4.41 254.77	0.77 224.81	2.28 64.03	1.32 19.50	0.83 330.88	1.01 257.69	0.66 336.60	0.60 168.94	0.26 176.76	Mag Phase
293	-0.72	8.12	5.73 148.46	3.41 274.03	1.11 55.13	1.69 151.68	0.86 359.63	0.74 35.16	0.36 214.74	0.78 355.17	0.11 168.66	0.47 281.54	Mag Phase
294	0.38	7.15	3.41 126.53	3.25 279.76	1.39 7.96	1.56 126.04	0.57 94.21	1.52 3.35	0.21 179.36	0.55 331.62	0.21 306.78	0.15 253.94	Mag Phase
295	0.38	7.17	5.08 155.31	2.73 271.75	1.10 76.73	1.64 154.36	1.13 55.66	1.06 37.39	0.17 220.72	0.87 21.09	0.12 27.18	0.46 339.24	Mag Phase
296	1.08	7.18	3.68 92.77	3.79 285.41	1.42 341.15	1.16 110.33	0.85 101.77	1.14 328.50	0.17 274.21	0.24 301.54	0.40 240.12	0.09 80.14	Mag Phase
297	0.94	7.26	3.70 115.41	3.32 277.78	1.56 8.09	1.59 130.01	0.43 92.65	1.53 2.98	0.17 161.55	0.52 325.43	0.21 305.97	0.17 243.15	Mag Phase

Table VI. - Continued

(v) Continued

Run 10

 $\mu_{\text{Nom.}} = 0.16$ 

POINT	MEAN	1/2P-P	1P	2P	3P	4P	5P	6P	7P	8P	9P	10P	
298	2.27	6.99	3.28 101.35	4.21 289.12	1.71 358.36	1.43 136.96	0.38 82.26	1.23 17.83	0.33 187.95	0.54 346.06	0.13 341.32	0.11 257.44	Mag Phase

 $\mu_{\text{Nom.}} = 0.20$ 

POINT	MEAN	1/2P-P	1P	2P	3P	4P	5P	6P	7P	8P	9P	10P	
299	2.15	7.27	3.14 115.61	4.66 288.22	0.93 292.33	1.66 166.20	0.61 146.52	0.99 69.58	0.54 207.37	0.73 4.90	0.08 133.52	0.32 290.33	Mag Phase
300	0.70	7.62	3.75 139.54	4.23 288.75	0.51 344.12	1.72 162.41	0.61 160.60	1.11 43.06	0.34 190.85	0.73 355.93	0.12 115.60	0.38 274.79	Mag Phase
301	2.91	8.64	1.86 64.85	5.16 284.58	0.93 280.64	1.85 136.68	0.57 100.74	1.16 21.75	1.05 225.01	0.37 33.25	0.22 76.89	0.26 321.74	Mag Phase
302	-0.13	7.50	4.96 155.00	4.16 284.75	0.58 178.39	2.12 174.80	0.21 78.04	0.63 102.17	0.19 220.64	0.56 21.66	0.19 181.27	0.36 302.60	Mag Phase
303	1.85	8.11	3.88 128.69	4.91 291.27	0.41 328.18	1.77 182.15	0.75 171.88	1.07 75.81	0.45 217.17	0.76 30.72	0.15 156.51	0.40 320.17	Mag Phase
304	2.05	7.67	5.59 158.81	3.39 290.10	0.16 260.16	1.77 205.84	0.94 132.27	0.68 92.00	0.41 239.78	0.62 66.62	0.06 239.79	0.33 33.02	Mag Phase
305	1.22	7.00	2.55 99.61	4.59 284.93	0.42 297.68	1.30 153.41	1.14 178.96	0.52 76.39	0.20 221.77	0.34 13.98	0.15 261.07	0.24 270.08	Mag Phase
306	0.55	7.29	3.15 143.39	4.53 296.83	0.70 331.24	1.46 171.32	0.66 159.33	1.00 55.19	0.31 205.84	0.67 12.98	0.16 144.70	0.35 287.48	Mag Phase

Table VI. - Continued

(v) Continued

Run 10

 $\mu_{\text{Nom.}} = 0.20$ 

POINT	MEAN	1/2P-P	1P	2P	3P	4P	5P	6P	7P	8P	9P	10P	
307	-0.17	6.44	2.78 136.83	3.80 285.22	0.38 332.39	1.47 172.25	0.62 154.39	1.02 45.24	0.32 178.24	0.60 358.22	0.16 126.16	0.35 271.85	Mag Phase

 $\mu_{\text{Nom.}} = 0.25$ 

POINT	MEAN	1/2P-P	1P	2P	3P	4P	5P	6P	7P	8P	9P	10P	
308	-0.55	9.03	3.65 163.10	5.06 263.06	2.42 225.15	3.19 190.85	0.85 146.08	1.02 85.34	0.16 198.39	0.49 29.77	0.09 167.59	0.31 318.03	Mag Phase
309	0.12	10.86	1.95 141.07	5.62 268.43	3.39 236.48	3.22 208.89	1.07 145.95	0.93 117.32	0.26 227.88	0.47 32.68	0.02 99.26	0.22 344.03	Mag Phase
310	2.24	10.96	1.98 52.13	5.64 271.19	3.38 241.93	2.58 214.83	1.23 163.70	0.72 67.26	0.67 221.78	0.45 18.83	0.20 120.35	0.20 288.01	Mag Phase
311	-2.12	11.41	4.81 178.16	5.92 262.65	2.70 208.94	3.53 192.80	0.90 110.23	0.83 124.32	0.22 217.33	0.54 39.63	0.12 222.99	0.22 334.25	Mag Phase
312	-0.90	8.43	2.90 160.36	5.00 275.93	2.30 243.54	2.59 197.48	0.83 138.03	0.97 107.06	0.26 197.82	0.44 29.03	0.11 162.19	0.26 321.70	Mag Phase
313	-0.02	10.02	5.14 171.95	4.66 267.57	2.69 235.67	2.71 219.33	1.18 143.88	0.18 115.05	0.24 186.28	0.27 97.88	0.05 29.22	0.28 83.34	Mag Phase
314	-1.27	9.99	1.64 142.12	5.74 272.06	2.83 240.57	2.65 184.39	0.99 130.05	0.98 120.72	0.28 206.25	0.24 357.85	0.07 254.98	0.25 257.42	Mag Phase
315	-0.66	8.98	2.67 160.49	4.96 274.01	2.51 243.09	2.93 205.10	0.83 152.01	0.93 115.45	0.24 219.79	0.42 35.16	0.07 200.20	0.24 330.50	Mag Phase

Table VI. - Continued

(v) Continued

Run 10

$\mu_{\text{Nom.}} = 0.25$

POINT	MEAN	1/2P-P	1P	2P	3P	4P	5P	6P	7P	8P	9P	10P	
316	-0.29	10.33	2.59 140.55	5.84 270.09	3.48 243.49	3.09 212.60	0.95 137.24	0.66 109.73	0.44 200.71	0.44 35.51	0.10 219.79	0.28 332.61	Mag Phase

$\mu_{\text{Nom.}} = 0.30$

POINT	MEAN	1/2P-P	1P	2P	3P	4P	5P	6P	7P	8P	9P	10P	
317	-2.34	25.87	3.22 194.84	12.81 240.95	9.44 205.70	5.64 169.07	2.82 45.60	1.36 356.15	0.52 125.62	0.41 30.63	0.23 328.97	0.21 325.54	Mag Phase
318	-2.83	19.50	3.33 200.95	8.25 251.70	6.66 215.57	6.24 183.66	1.88 110.76	0.48 22.55	0.26 204.09	0.61 18.13	0.28 316.77	0.30 352.08	Mag Phase
319	-1.66	16.71	2.69 209.79	6.59 262.66	5.47 223.35	5.18 177.48	1.85 106.26	1.23 2.64	0.62 173.63	0.39 13.11	0.24 351.81	0.30 343.67	Mag Phase
320	-3.98	20.45	4.95 192.90	9.97 244.72	6.93 203.51	5.93 175.90	2.15 91.04	0.26 58.82	0.12 250.52	0.69 15.18	0.32 283.88	0.31 335.16	Mag Phase
321	-2.61	20.00	3.04 193.62	8.58 250.56	6.83 217.48	6.31 184.29	2.03 116.91	0.45 40.75	0.26 219.77	0.63 20.59	0.27 327.86	0.31 353.16	Mag Phase
322	-1.91	16.16	4.43 200.70	7.07 245.65	5.94 206.39	5.03 181.72	1.19 89.29	0.91 309.81	0.39 151.71	0.24 30.35	0.38 345.72	0.23 26.03	Mag Phase
323	-3.51	21.94	2.32 202.74	10.01 245.52	7.44 212.02	5.75 175.35	2.38 93.04	0.89 43.07	0.47 218.59	0.50 349.78	0.16 326.97	0.21 333.04	Mag Phase
324	-2.68	18.33	3.35 201.83	8.16 254.25	6.23 220.06	5.47 185.89	1.81 116.21	0.41 17.45	0.34 202.46	0.51 37.17	0.25 320.17	0.25 10.57	Mag Phase

Table VI. - Continued

(v) Continued

Run 10

$\mu_{Nom.} = 0.30$

POINT	MEAN	1/2P-P	1P	2P	3P	4P	5P	6P	7P	8P	9P	10P	
325	-3.55	16.54	3.74 207.67	6.49 259.58	5.76 220.95	5.24 189.55	1.79 129.85	0.67 17.33	0.41 189.24	0.46 57.58	0.11 263.38	0.15 4.73	Mag Phase

$\mu_{Nom.} = 0.325$

POINT	MEAN	1/2P-P	1P	2P	3P	4P	5P	6P	7P	8P	9P	10P	
326	-4.39	23.88	4.12 207.62	9.81 243.72	8.10 203.33	6.93 170.49	2.60 85.23	0.81 351.09	0.21 194.34	0.72 30.07	0.41 314.18	0.40 332.17	Mag Phase
327	-4.13	29.96	3.66 194.15	12.87 238.54	11.09 202.43	7.39 163.93	3.68 53.95	2.06 345.16	0.21 152.09	0.45 22.36	0.24 312.37	0.22 341.66	Mag Phase
328	-3.98	33.42	4.47 181.70	14.26 235.58	11.46 197.66	8.51 160.29	4.60 57.66	2.79 350.93	0.60 158.88	0.68 24.62	0.39 336.86	0.27 310.73	Mag Phase

$\mu_{Nom.} = 0.275$

POINT	MEAN	1/2P-P	1P	2P	3P	4P	5P	6P	7P	8P	9P	10P	
329	-1.78	12.70	1.57 165.07	6.36 261.73	4.07 232.75	4.03 185.70	0.90 127.54	0.61 78.43	0.42 182.90	0.35 11.78	0.26 279.63	0.28 328.73	Mag Phase
330	-2.47	13.67	2.39 192.15	5.65 274.82	4.82 228.55	4.26 198.23	1.33 155.59	0.64 68.69	0.33 190.97	0.33 42.85	0.05 284.11	0.13 349.33	Mag Phase
331	-1.64	10.79	0.49 185.42	5.23 284.38	3.66 232.59	2.91 193.40	0.86 151.90	1.03 31.61	0.62 188.90	0.31 338.75	0.10 350.10	0.14 320.07	Mag Phase
332	-3.84	15.75	3.68 196.39	6.30 259.96	5.35 213.66	5.37 189.70	1.50 121.37	0.69 99.42	0.09 149.90	0.49 46.38	0.15 306.39	0.16 14.59	Mag Phase

Table VI. - Continued

(v) Continued

Run 10

$\mu_{Nom.} = 0.275$

POINT	MEAN	1/2P-P	1P	2P	3P	4P	5P	6P	7P	8P	9P	10P	
333	-2.37	13.31	2.82 188.64	5.71 274.27	4.55 224.94	4.35 197.80	1.23 145.93	0.71 79.61	0.30 201.39	0.48 37.31	0.08 334.23	0.23 3.40	Mag Phase
334	-2.22	11.80	3.82 189.79	4.53 265.73	4.94 227.40	3.60 208.61	1.16 138.14	0.33 17.03	0.48 142.61	0.15 112.18	0.17 4.39	0.20 64.38	Mag Phase
335	-2.93	15.77	0.97 209.79	6.72 271.42	5.07 231.05	4.55 185.31	1.49 151.22	0.80 95.18	0.31 226.71	0.34 16.50	0.07 1.81	0.05 292.68	Mag Phase
336	-2.42	13.31	2.27 199.03	5.89 279.55	4.49 237.64	3.94 208.28	1.23 166.56	0.69 90.95	0.39 220.31	0.39 64.99	0.02 197.53	0.13 26.87	Mag Phase
337	-3.70	14.33	2.35 186.78	5.70 272.08	5.18 221.55	4.64 198.24	1.28 159.51	0.89 56.84	0.09 150.40	0.38 45.23	0.08 238.65	0.16 348.14	Mag Phase

$\mu_{Nom.} = 0.225$

POINT	MEAN	1/2P-P	1P	2P	3P	4P	5P	6P	7P	8P	9P	10P	
338	-0.71	10.21	2.25 69.57	5.22 284.40	3.37 233.85	2.43 209.15	1.32 169.20	0.38 87.36	0.26 220.84	0.55 25.84	0.08 81.73	0.11 343.19	Mag Phase
339	-1.33	11.22	2.27 54.15	5.68 268.76	3.76 225.78	2.70 213.05	1.19 185.80	0.57 75.45	0.11 118.14	0.42 33.70	0.06 118.70	0.08 327.21	Mag Phase
340	0.62	8.92	4.14 17.00	4.45 271.01	1.85 256.17	1.59 199.57	1.69 164.43	0.46 29.27	0.47 222.76	0.19 28.27	0.17 76.32	0.11 256.82	Mag Phase
341	-3.87	5.26	2.55 156.51	3.30 303.53	0.90 234.56	1.92 178.81	0.64 138.03	0.43 111.95	0.27 146.61	0.37 46.42	0.06 187.45	0.14 328.24	Mag Phase

Table VI. - Continued

(v) Concluded

Run 10

$\mu_{Nom.} = 0.22$

POINT	MEAN	1/2P-P	1P	2P	3P	4P	5P	6P	7P	8P	9P	10P	
342	-2.20	7.30	1.66 91.01	3.93 290.05	2.00 258.84	1.83 192.60	1.29 164.49	0.60 78.86	0.19 163.26	0.34 20.88	0.08 344.96	0.15 339.22	Mag Phase
343	-3.09	6.55	3.64 185.64	3.17 292.44	1.38 263.67	1.22 199.35	1.29 149.36	0.27 355.60	0.28 184.93	0.09 330.58	0.08 324.51	0.16 102.76	Mag Phase
344	-2.76	7.58	1.84 59.49	4.61 283.70	1.82 251.73	1.56 181.47	1.19 170.70	0.47 68.56	0.13 187.93	0.29 14.94	0.07 41.99	0.17 226.74	Mag Phase
345	-2.42	7.64	1.51 100.22	4.52 285.15	2.08 263.34	1.77 199.31	1.18 169.40	0.62 79.94	0.15 183.59	0.33 19.09	0.04 139.27	0.11 318.42	Mag Phase
346	-2.66	7.85	0.75 74.28	4.16 282.25	1.98 246.56	1.88 201.28	1.22 170.73	0.57 71.66	0.17 155.95	0.29 33.99	0.06 173.39	0.13 324.27	Mag Phas



**REPORT DOCUMENTATION PAGE**

*Form Approved  
OMB No. 0704-0188*

The public reporting burden for this collection of information is estimated to average 1 hour per response, including the time for reviewing instructions, searching existing data sources, gathering and maintaining the data needed, and completing and reviewing the collection of information. Send comments regarding this burden estimate or any other aspect of this collection of information, including suggestions for reducing this burden, to Department of Defense, Washington Headquarters Services, Directorate for Information Operations and Reports (0704-0188), 1215 Jefferson Davis Highway, Suite 1204, Arlington, VA 22202-4302. Respondents should be aware that notwithstanding any other provision of law, no person shall be subject to any penalty for failing to comply with a collection of information if it does not display a currently valid OMB control number.  
**PLEASE DO NOT RETURN YOUR FORM TO THE ABOVE ADDRESS.**

<b>1. REPORT DATE (DD-MM-YYYY)</b> 01- 11 - 2005		<b>2. REPORT TYPE</b> Technical Publication		<b>3. DATES COVERED (From - To)</b>	
<b>4. TITLE AND SUBTITLE</b> Loads and Performance Data from a Wind-Tunnel Test of Generic Model Helicopter Rotor Blades				<b>5a. CONTRACT NUMBER</b>	
				<b>5b. GRANT NUMBER</b>	
				<b>5c. PROGRAM ELEMENT NUMBER</b>	
<b>6. AUTHOR(S)</b> Yeager, William T., Jr.; and Wilbur, Matthew L.				<b>5d. PROJECT NUMBER</b>	
				<b>5e. TASK NUMBER</b>	
				<b>5f. WORK UNIT NUMBER</b> 23-065-40-30	
<b>7. PERFORMING ORGANIZATION NAME(S) AND ADDRESS(ES)</b> NASA Langley Research Center Hampton, VA 23681-2199			<b>8. PERFORMING ORGANIZATION REPORT NUMBER</b>  L-19185		
<b>9. SPONSORING/MONITORING AGENCY NAME(S) AND ADDRESS(ES)</b> National Aeronautics and Space Administration Washington, DC 20546-0001 and U.S. Army Research Laboratory Adelphi, MD 20783-1145				<b>10. SPONSOR/MONITOR'S ACRONYM(S)</b>  NASA	
				<b>11. SPONSOR/MONITOR'S REPORT NUMBER(S)</b> NASA/TM-2005-213937 ARL-TR-3675	
<b>12. DISTRIBUTION/AVAILABILITY STATEMENT</b> Unclassified - Unlimited Subject Category 05 Availability: NASA CASI (301) 621-0390					
<b>13. SUPPLEMENTARY NOTES</b> An electronic version can be found at <a href="http://ntrs.nasa.gov">http://ntrs.nasa.gov</a>					
<b>14. ABSTRACT</b> An investigation was conducted in the NASA Langley Transonic Dynamics Tunnel to acquire data for use in assessing the ability of current and future comprehensive analyses to predict helicopter rotating-system and fixed-system vibratory loads. The investigation was conducted with a generic model helicopter rotor system using blades with rectangular planform, no built-in twist, uniform radial distribution of mass and stiffnesses, and a NACA 0012 airfoil section. Rotor performance data, as well as mean and vibratory components of blade bending and torsion moments, fixed-system forces and moments, and pitch link loads were obtained at advance ratios up to 0.35 for various combinations of rotor shaft angle-of-attack and collective pitch. The data are presented without analysis.					
<b>15. SUBJECT TERMS</b> Rotorcraft; Helicopters; Rotor systems; Loads; Performance; Wind-tunnel; Test data; Model helicopter rotor; Generic rotor model					
<b>16. SECURITY CLASSIFICATION OF:</b>			<b>17. LIMITATION OF ABSTRACT</b>	<b>18. NUMBER OF PAGES</b>	<b>19a. NAME OF RESPONSIBLE PERSON</b>
<b>a. REPORT</b>	<b>b. ABSTRACT</b>	<b>c. THIS PAGE</b>			STI Help Desk (email: <a href="mailto:help@sti.nasa.gov">help@sti.nasa.gov</a> )
U	U	U	UU	553	<b>19b. TELEPHONE NUMBER (Include area code)</b> (301) 621-0390