

## DEVELOPMENT OF HVOF SPRAYED EROSION/OXIDATION RESISTANT COATINGS FOR COMPOSITE STRUCTURAL COMPONENTS IN PROPULSION SYSTEMS

R. Knight, M. Ivosevic, T.E. Twardowski, S.R. Kalidindi, J.K. Sutter\*, D.Y. Kim\*\*

DEPARTMENT OF MATERIALS ENGINEERING, DREXEL UNIVERSITY, PHILADELPHIA, PA

\* *NASA Glenn Research Center at Lewis Field, Cleveland, OH*

\*\* *Visiting Researcher from Hyundai Heavy Industries Co., Ltd. Ulsan, Korea*

Thermally sprayed coatings are being studied and developed as methods of enabling lightweight composites to be used more extensively as structural components in propulsion applications in order to reduce costs and improve efficiency through weight reductions.

The primary goal of this work is the development of functionally graded material [FGM] polymer/metal matrix composite coatings to provide improved erosion/oxidation resistance to polyimide-based polymer matrix composite [PMC] substrates. The goal is to grade the coating composition from pure polyimide, similar to the PMC substrate matrix on one side, to 100 % WC-Co on the other. Both step-wise and continuous gradation of the loading of the WC-Co reinforcing phase are being investigated.

Details of the coating parameter development will be presented, specifically the high velocity oxy-fuel [HVOF] combustion spraying of pure PMR-II matrix material and layers of various composition PMR-II/WC-Co blends onto steel and PMR-15 composite substrates. Results of the HVOF process optimization, microstructural characterization, and analysis will be presented. The sprayed coatings were evaluated using standard metallographic techniques - optical and scanning electron microscopy [SEM]. An SEM + electron dispersive spectroscopy [EDS] technique has also been used to confirm retention of the PMR-II component. Results of peel/butt adhesion testing to determine adhesion will also be presented.

This is a preprint or reprint of a paper intended for presentation at a conference. Because changes may be made before formal publication, this is made available with the understanding that it will not be cited or reproduced without the permission of the author.

# Development of HVOF Sprayed Erosion/Oxidation Resistant Coatings for Composite Structural Components in Propulsion Systems

R. Knight, M. Ivosevic, T. Twardowski, & S. Kalidindi, *Drexel University*

J. Sutter, *NASA Glenn Research Center*

D.Y. Kim, *Visiting Researcher from Hyundai Heavy Industries Co.*



Department of Materials Engineering  
Philadelphia, PA 19104

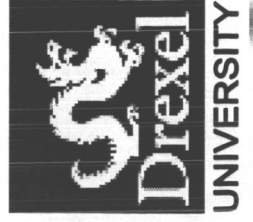



## Acknowledgements

---

### ■ Sponsor:

- The authors gratefully acknowledge financial support from NASA-Glenn Research Center, Cleveland OH.

### ■ Assistance:

- The authors also greatly appreciate the assistance of Mr. Dustin Doss during the HVOF spraying of the coatings, and Mr. David Von Rohr during the microscopy and analysis.

## Research Goals & Objectives

### ■ Primary Goal:

- Development of functionally graded material [FGM] coatings to provide erosion/oxidation resistance to lightweight polyimide-based polymer matrix composite [PMC] substrates for use in turbine engine components.

### ■ Secondary Goals:

- Improved surface finish relative to coatings developed in a previous study
- Some evaluation of the thermo-mechanical fatigue [TMF] properties of the coating/substrate system.

### ■ Objectives:

- Development of thermally sprayed FGM coating structures based on a polyimide matrix filled with varying volume fractions of conventional or nano-sized WC-Co.

# Why Polymer Matrix Composites [PMC's]

## ■ Advantages of PMC's in Aircraft Engines:

- Weight Savings
  - Improved Strength
  - Reduced Part Count
  - Reduced Mfg. Cost
- } More efficient propulsion system

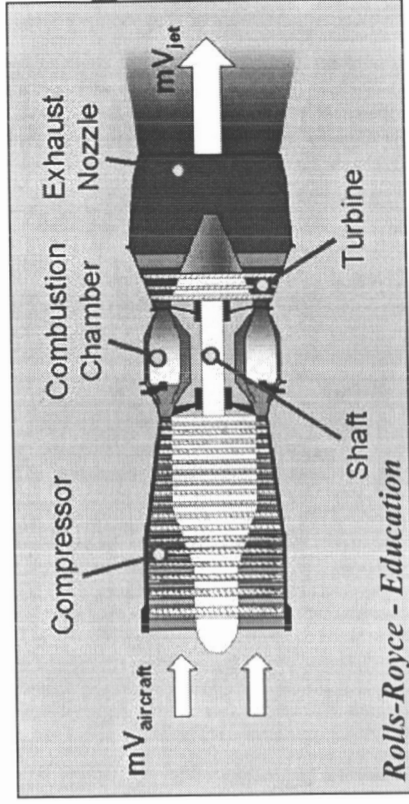

## Polyimide Matrix Based Composites

### ■ PMR-15 [our substrate]

- Outstanding thermal-oxidative stability:

- Short term...up to 550 °C.
- Long term...up to 300 °C.

■ Current applications in turbine engine cold section environment:

- Fan, compressor, inlet housing.
- Oil-exposed helicopter gearboxes.

### ■ New Generation PMC...PMR-II:

*Long Term Operation up to ~370 °C*

+

*Erosion-Oxidative Resistant Coating*

⇓

*Increased # of Potential Applications*



## ■ LOW COST, HIGH TEMPERATURE POLYMER MATRIX COMPOSITE [PMC] COMPONENTS:

- Allison Advanced Development Company, Indianapolis, IN.
- Rolls-Royce Allison, Indianapolis, IN.
- Ohio Aerospace Institute, Cleveland, OH.
- Real World Quality Systems, Rocky River, OH.

1. *Wear characteristics*  
 2. *Thermo-mechanical fatigue behavior*

## ■ Statistical Analysis of Six Different Erosion Resistant Coating Systems:

Top Coat Composition	Bond Coat Type	Substrate
Cr <sub>3</sub> C <sub>2</sub> - NiCr	A	Organic Matrix Composite [OMC]
WC-Co	A	OMC
TiN	A	OMC
Cr <sub>3</sub> C <sub>2</sub> - NiCr	B	OMC
WC-Co	B	OMC
TiN	B	OMC

### Key Conclusions:

- WC-Co [A] – exhibited the best overall performance.
- Provided on average 8.5 times greater improvement in erosion resistance as compared with uncoated PMR-15 [OMC].

## **Program Steps/General Approach**

- **Formulation of coating concept[s].**
- **Development & understanding of the thermal spray processing techniques needed to produce these.**
- **Characterization of thermally sprayed FGM coatings:**
  - **Microstructure.**
  - **Matrix degradation.**
  - **Surface roughness.**
- **Determination of the erosion-resistance, oxidation behavior and thermo-mechanical fatigue [TMF] properties.**

# Functionally Graded Coating Concept[s]

## ■ Matrix: Polyimide PMR-II.

- Improve the TMF properties of the coating/substrate system by helping match differences in thermal expansion coefficient [CTE] between WC-Co and PMC substrate.

## ■ Reinforcement: WC-Co.

- Erosion/oxidation-resistant reinforcing phase and outer layer.

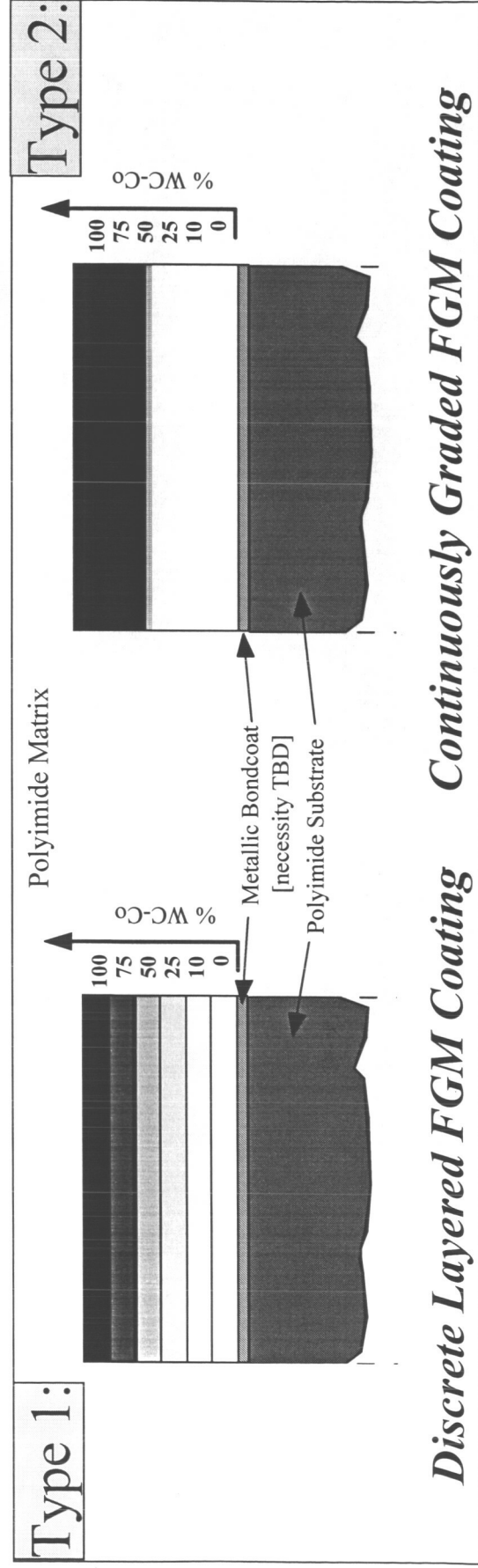



# High Velocity Oxy-Fuel [HVOF] Spray Process [1]

## ■ Process Schematic:

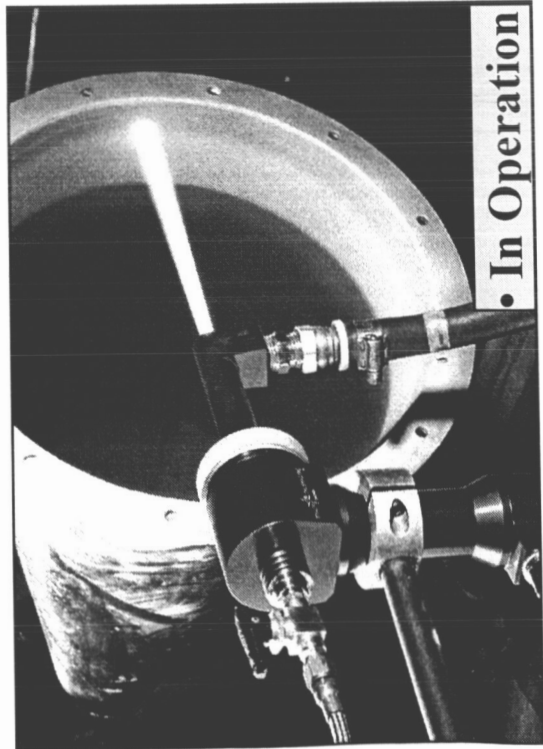
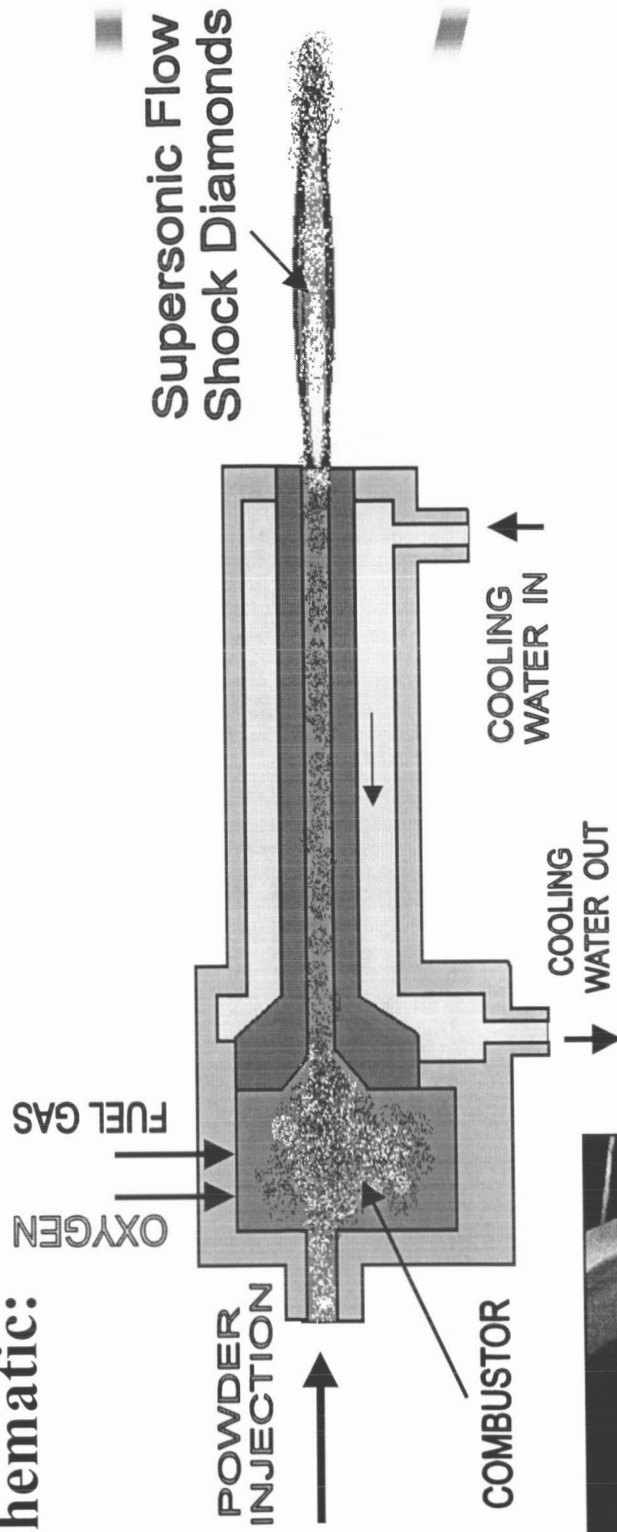

• In Operation

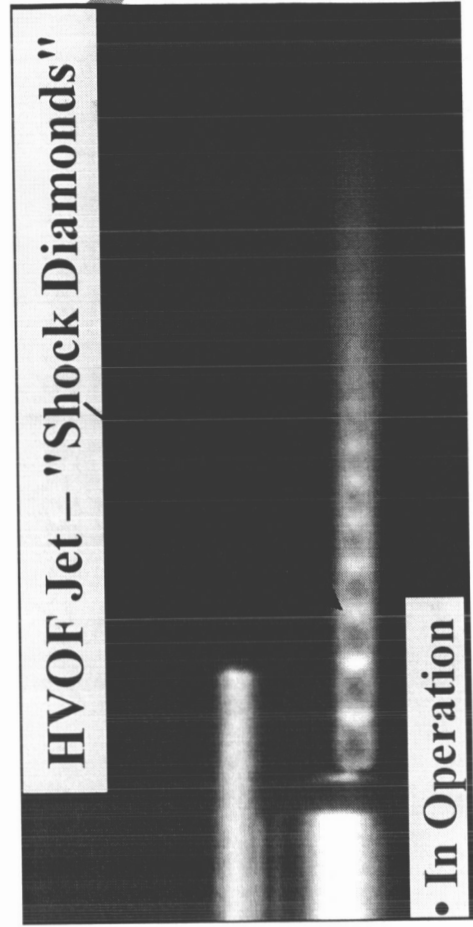

HVOF Jet – "Shock Diamonds"

• In Operation

Photo courtesy of Stellite Coatings, Inc.

## High Velocity Oxy-Fuel [HVOF] Spray Process [2]

### ■ Process History/Characteristics:

- Invented c. 1958 by Union Carbide [now Praxair].
- Introduced commercially in 1974 [J. Browning]; now...5-8 designs [Jet Kote®, Diamond-Jet, HV-2000, JP-5000, OSU, etc.].
- Carbides [WC/Co, Cr<sub>3</sub>C<sub>2</sub>/NiCr], metals [SS]...aircraft engines, industry.
- Pressurized internal combustion + supersonic jet expansion to atmosphere.
- Fuel [H<sub>2</sub>, C<sub>3</sub>H<sub>6</sub>, C<sub>3</sub>H<sub>8</sub>, MAPP, Kerosene] + Oxygen @ high pressure.
- Improved gas heating and acceleration...improved heat/momentum transfer to injected powder particles.
- Powder feedstocks [typ. (-45, +10 μm)].
- **Characteristics:**
  - *Jet Temperature: typ. >3500 °C.*
  - *Jet Speeds: typ. >1200 m/s.*
  - *Gas Flow Rates: 400-1100 slm @ 100-140 psi.*
  - *Particle Speeds: 200-1000 m/s.*
  - *Powder Feed Rates: 15-50 gm/min.*

# Dual Powder Feeder Control System Integration

■ LabView® software controlling 2 powder feeders:

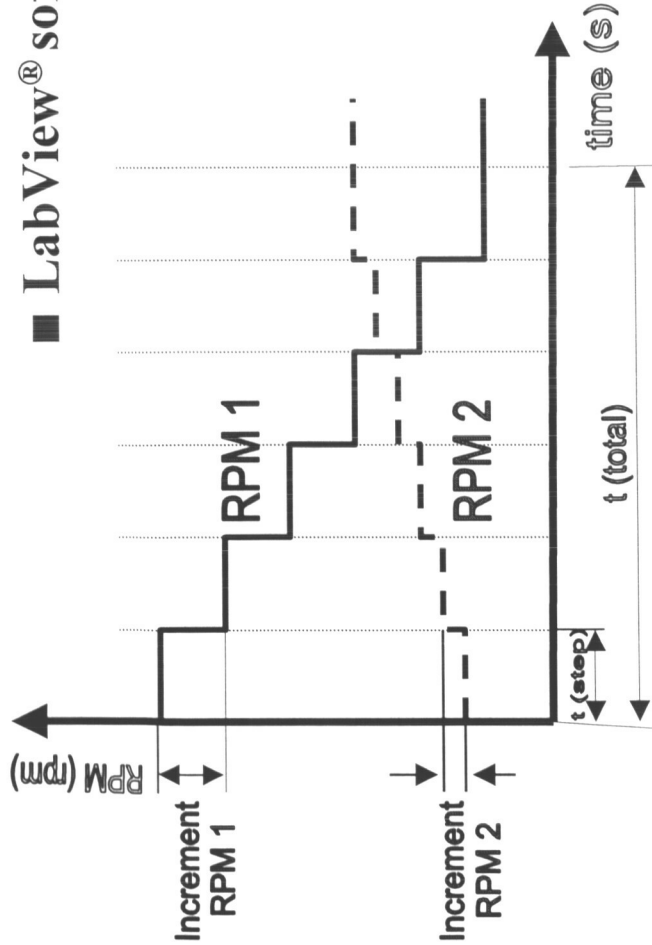

Parameter	Min.	Max.	Increment
RPM-1 [rpm]	0	25.0	0.1
RPM-2 [rpm]	0	25.0	0.1
T <sub>step</sub> [s]	1	600	1
# Step[s]	1	20	1
T <sub>total</sub> [s]	1	5000	N/A

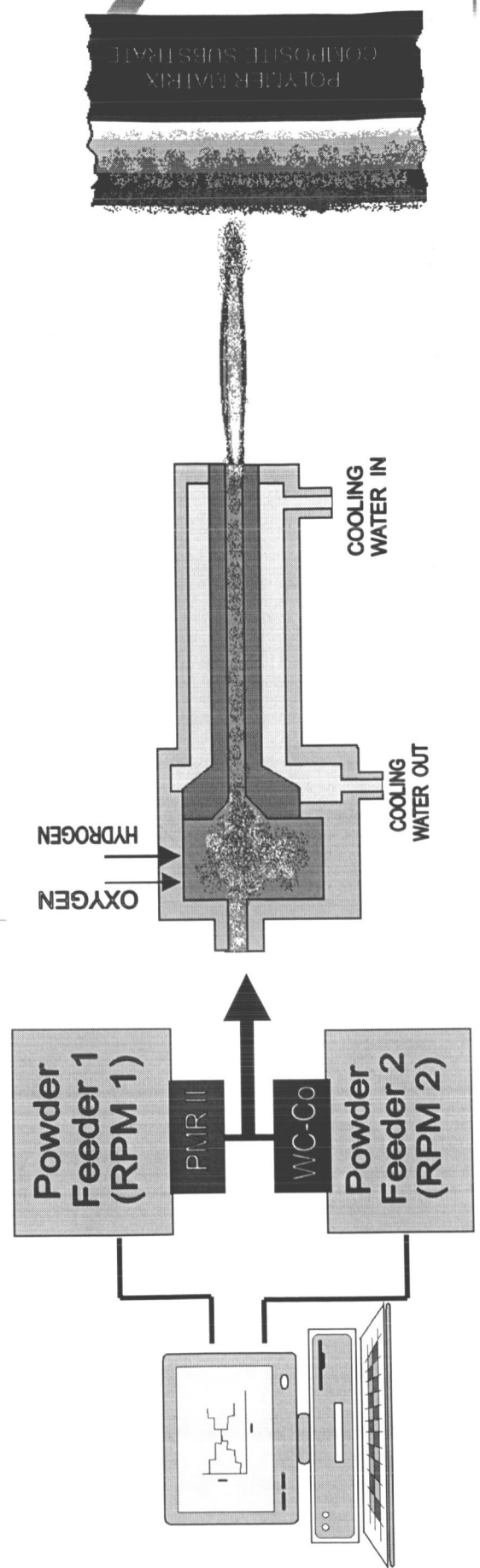



## ■ Feedstock Materials:

- PMR-II [n=2; n=9] [ $\rho = 1.39 \text{ g/cm}^3$ ]
  - Pre-impidized molding powder.
  - Cryo-ground to particle size distribution in range  $\sim [-100, +20 \text{ }\mu\text{m}]$ .
- WC-Co [ $\rho = 12.5 \text{ g/cm}^3$ ]
  - Agglomerated & sintered powder:  $[-44, +10 \text{ }\mu\text{m}]$ .
  - H.C. Starck: *Amperit 518*; *Praxair: WC 106*; *Stellite Coatings, Inc: JK 114*.

## ■ Coating Production:

- Stellite Coatings, Inc. Jet Kote® II-A HVOF combustion spray.
- Praxair model 1270 volumetric powder feeders [2].

## ■ Characterization & Testing:

- Microstructure: Metallography; Optical Microscopy; SEM/EDS.
- Adhesion: Butt adhesion; 180° peel test; dynamic shear tests.
- Stylus-tracing profilometry.
- Matrix Degradation: FTIR; XPS; Dilute-solution viscometry.
- Thermo Mechanical Fatigue [TMF]: MTS high temp. mechanical testing.

# Feedstock Material: PMR-II Polyimide

## Polyimide PMR-II [ $n = 2$ ]: Molecular Structure

NASA-Glenn Research  
Center

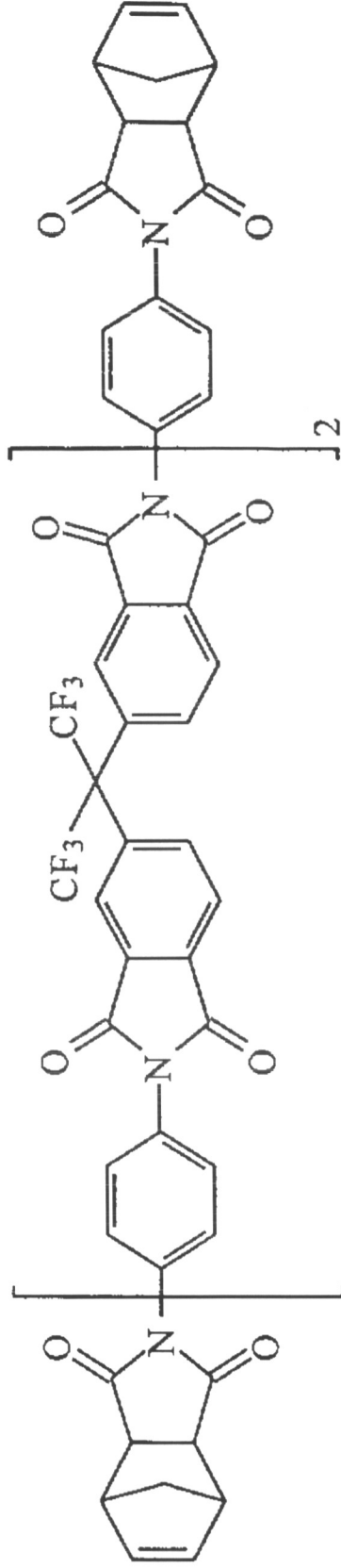

- Thermosetting polyimide [end-capped].
- Oligomer.
- Imidized ~2 hr. @ 400 °F + 1 hr. @ 450 °F.
- Mechanical crushing --> angular/blocky particle morphology.
- Screening --> particle size distribution for spraying.

# PMR-II: Thermal Analysis [1]

## Thermo-Gravimetric Analysis [TGA]:

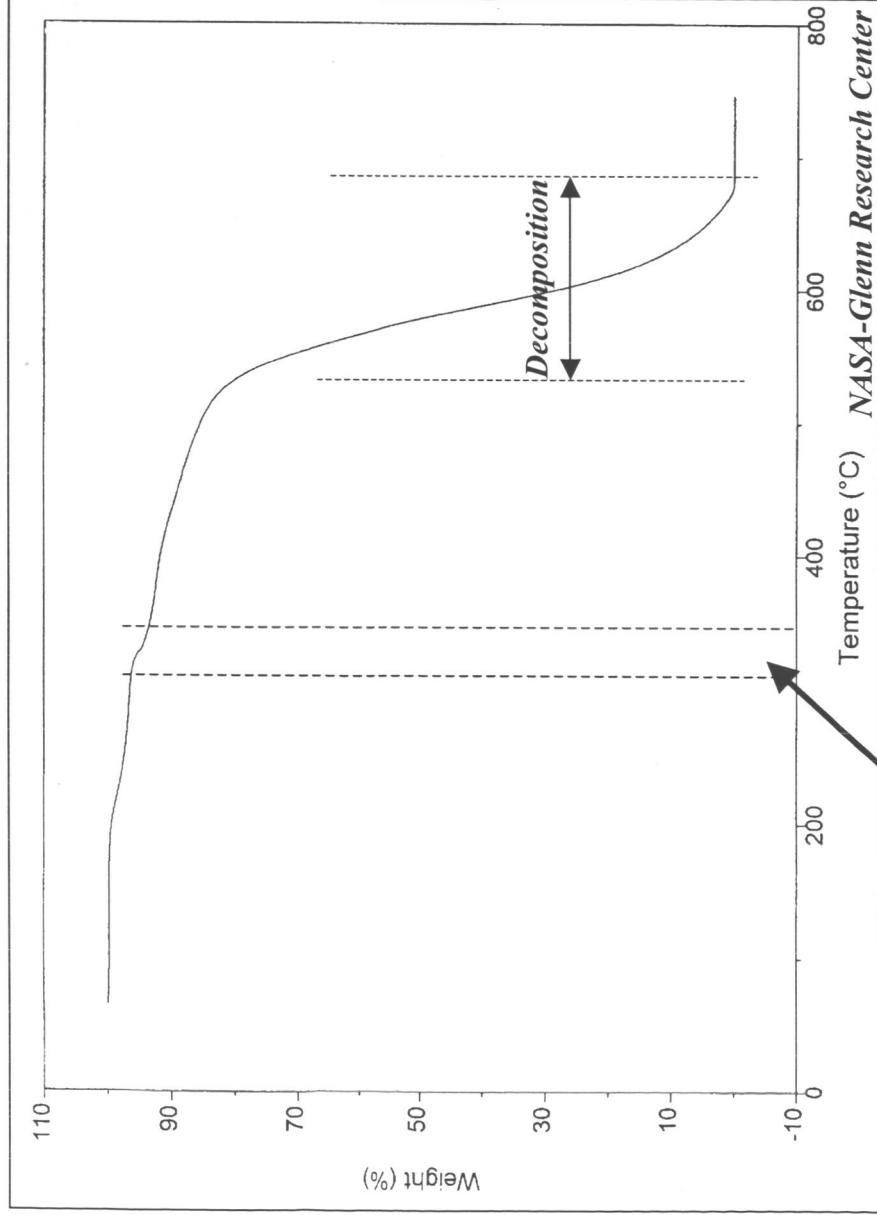

■ **TGA Conditions:**  
PMR-II [n = 2]  
1:1 B1:B2  
8.576 mg  
Run in Air  
Universal V2.5H TA Instruments

- High temp. properties of PMR-II polyimide.
- Degradation begins at ~550 °C.

- Gas evolution [eg. water vapor] during heating resulted in weight loss of ~ 3-5 wt. % at temp. ~ 325 °C. --> porosity in the coating.

# PMR-II: Thermal Analysis [2]

## ■ Differential Scanning Calorimetry [DSC]:

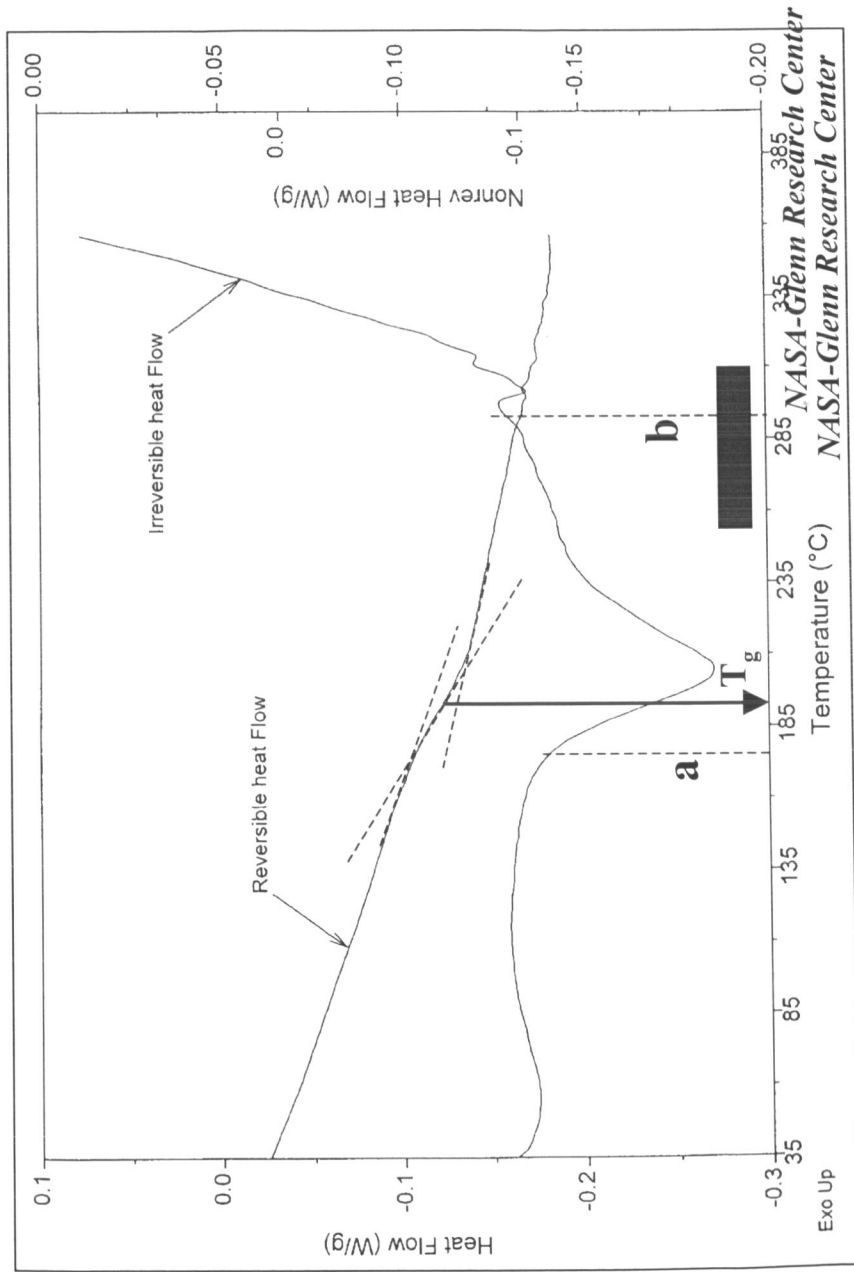

### DSC Conditions:

PMR-II [n = 2]

B1:B2 MP

9.8210 mg

Run in  $\text{N}_2$

Universal V2.5H TA Instruments

- **Reversible Heat Flow:**  
 $T_g \sim 190^\circ\text{C}$  of PMR-II  
*before* end groups are  
 polymerized.

- **Irreversible Heat Flow:** [a] Melting or fusion of oligomer began [ $\sim 170^\circ\text{C}$ ].  
 [b] Onset of polymerization of end-groups [ $\sim 300^\circ\text{C}$ ].  
 ■ ...Substrate pre-heating region.

# Results: FTIR Analysis [PMR-II]

- **FTIR [Fourier Transform Infrared] Spectrometry:**
  - Nicolet Magna-IR560 spectrometer.
  - Changes in molecular structure of PMR-II powders before and after heating.

"As-Received" PMR-II [n = 2] Powder.

Polymerization after heat-treating indicated by disappearance of N-H bond peak characteristic of the powder, and development of C-N bond peaks [with the N bonded to C atoms of aromatic rings] in range 1030 to 1230 cm<sup>-1</sup>.

PMR-II [n = 2] Powder Heated @ 350 °C.

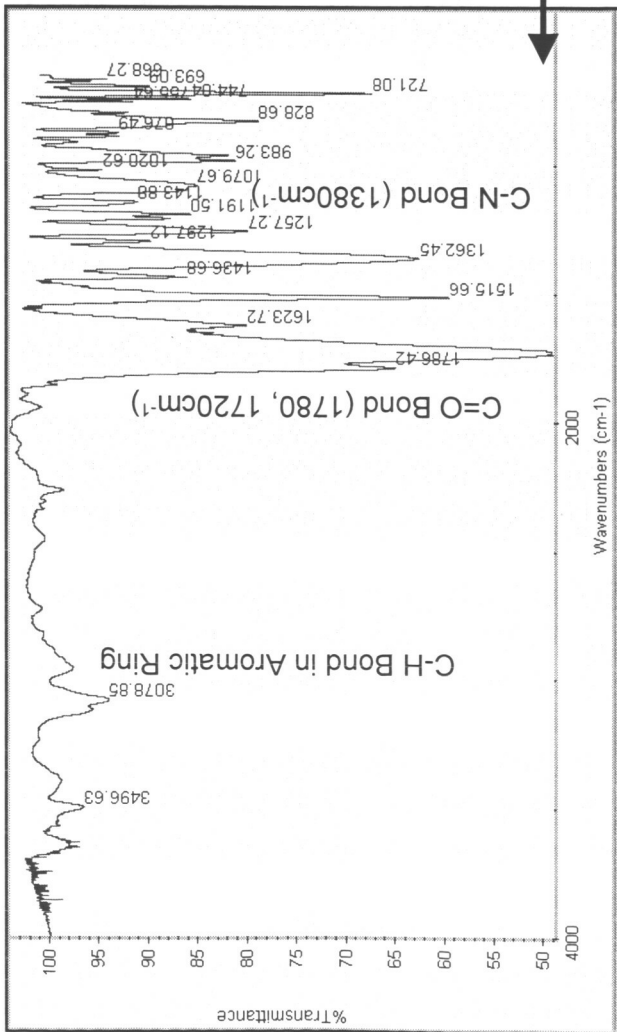
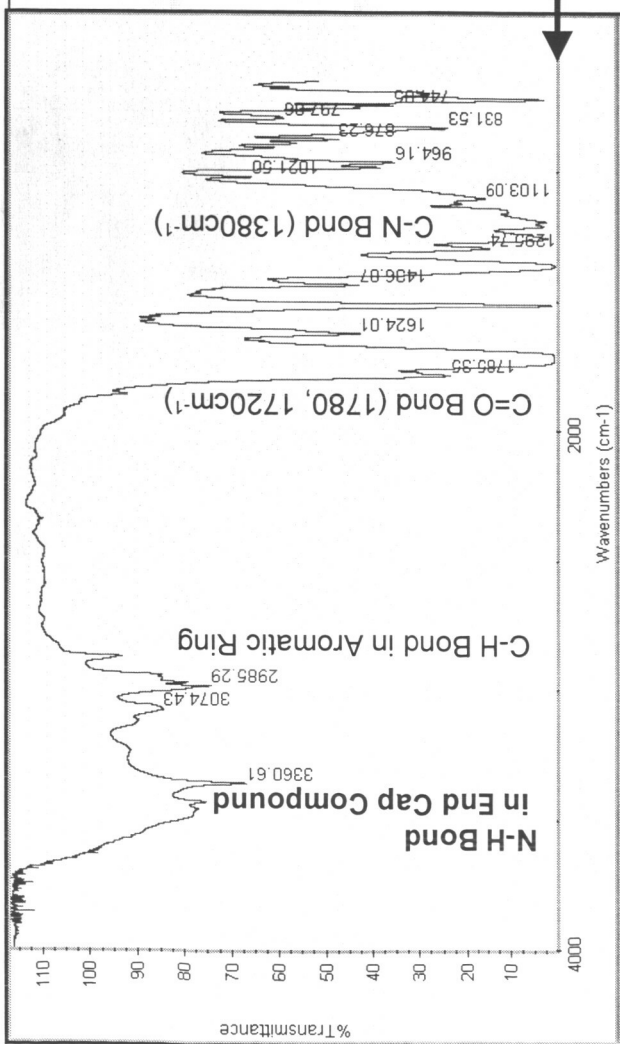



# Substrate Preheating

## ■ Issues:

- Rapid heating & cooling characteristic of HVOF spray process.
- High heat flux from the process/coating into the substrate.
- Insufficient time @ temperature for completion of curing of the thermosetting polymer.
- Initial results indicated  $T_{\text{substrate}}$  to be a **key parameter** influencing deposition & coating build-up.

## ■ Proposed Solution:

- Electrical resistance driven substrate preheating.
- Substrates can be preheated to temperatures in range [280-320 °C].

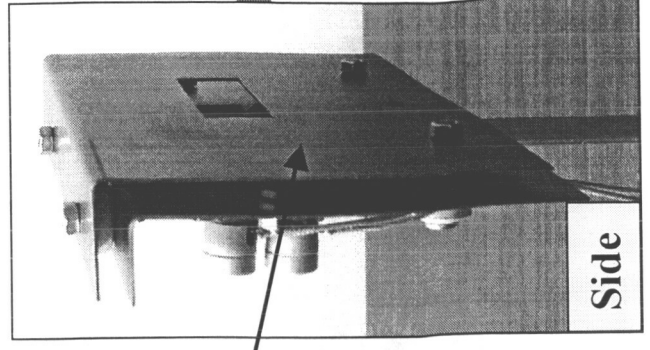
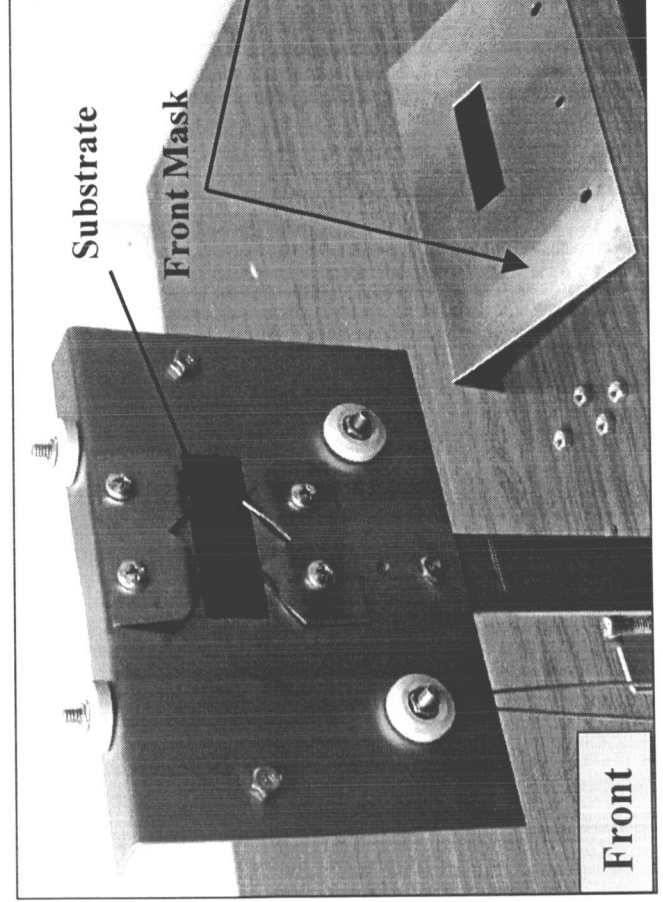
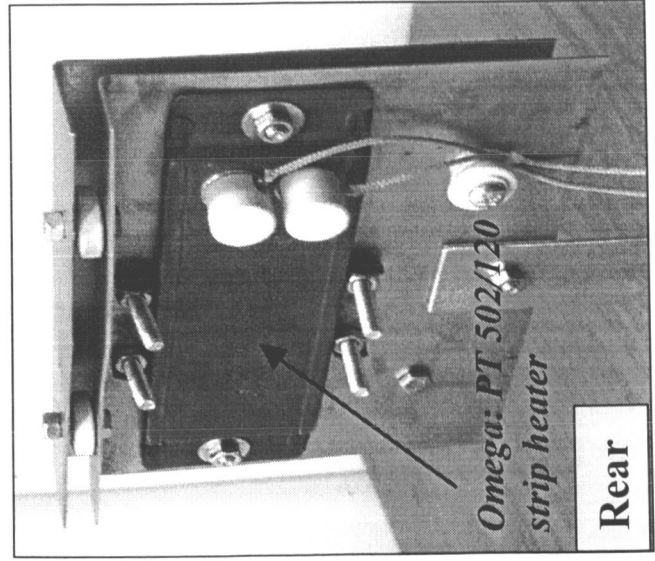

## Results: Feedstock Powder Morphology

### ■ Vee-Blending: [10 min]

*To homogenize the materials and improve effectiveness of subsequent ball-milling.*

- **Ball-Milling: [30 min @ 55 rpm]**  
Equal nominal volumes [ $\sim 450$  ml]  $ZrO_2$  balls + 50/50 Vol. % PMR-II & WC-Co materials were used throughout the ball-milling process.

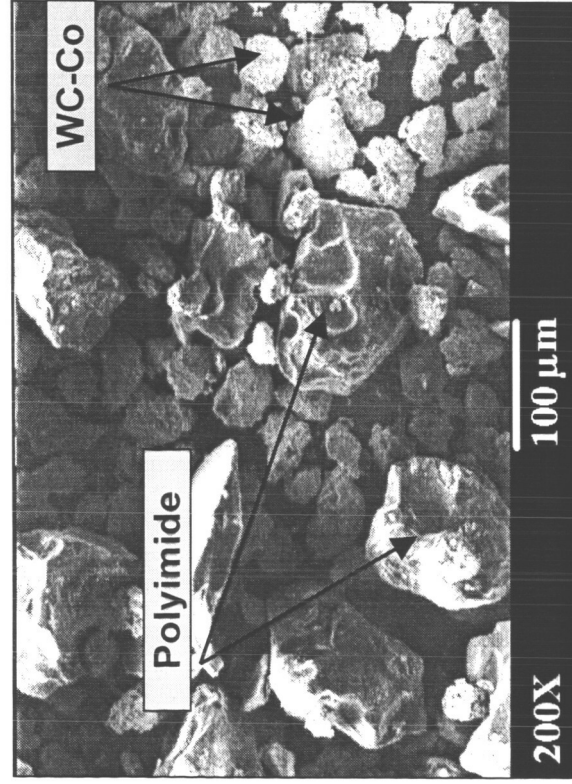

Ball  
Milling  $\rightarrow$

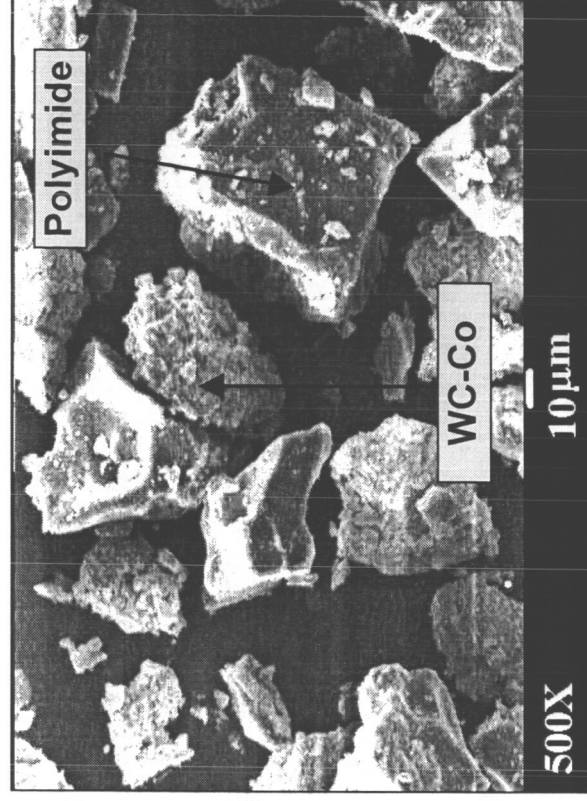

- PMR-II particle size reduced from initial relatively coarse [ $-150, +102 \mu\text{m}$ ] to approx. the same size as the WC-Co [ $\sim 50 \mu\text{m}$ ] during ball-milling.
- Little or no embedding of the hard WC-Co particles into the softer PMR-II particles observed.

# Results: Pure PMR-II Coating [Steel Substrate]

- HVOF sprayed, pure PMR-II coatings on Steel substrates [Run # JK01183].
- Same sample...different location [200X].
  - Relatively dense, adherent coatings.
  - Some porosity...likely due to gas/moisture evolution.

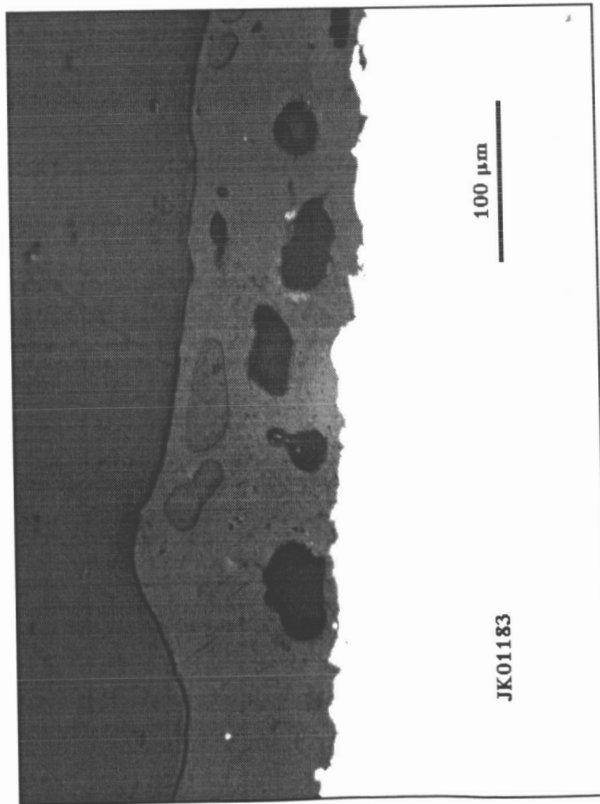
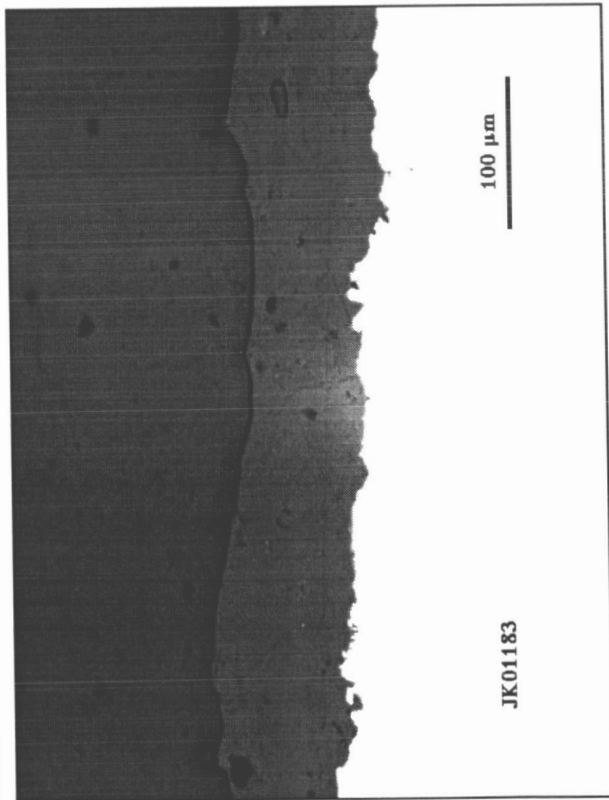

HVOF Process Parameter	Value
Spray Distance [in]	6
Powder Feed Rate [rpm]	1.5
Gas Flow Rates; H <sub>2</sub> :O <sub>2</sub> [SCFH]	800:400
Nozzle	6" L x 0.25" Ø
Surface Speed [in/s]	4.5 [50 %]*
Substrate Temperature [°C]	280-320 [1.7-1.8 A]**

\* Max. horizontal gun [surface] speed = 9 in/s [45 ft./min.].

\*\* 1.7-1.8 A = current [A] corresponding to the indicated substrate temperature.

## Results: SEM/EDS [1]

- SEM/EDS: "dot-mapping" analysis of PMR-II powder.

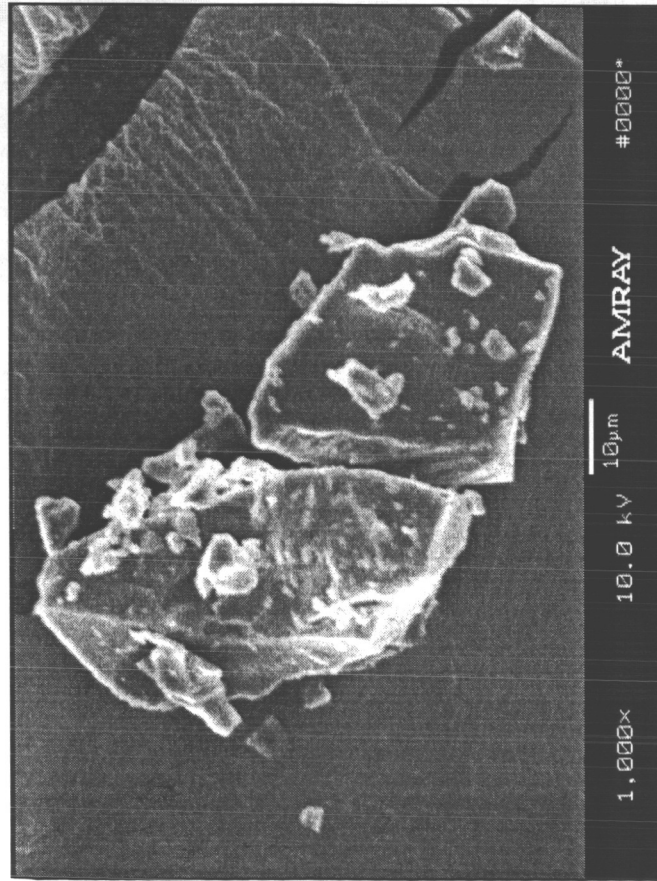

SEM Image [1,000X]



Fluorine "dot-map"

- Fluorine dot-map clearly corresponded to the morphology of the particle[s]  
--> confirmed viability of proposed approach for detecting/confirming the presence of the PMR-II material.



# Results: SEM/EDS [2]

- SEM/EDS dot maps of HVOF sprayed pure PMR-II coating:  
[Run #JK01161c; Al Substrate]



Secondary Electron Image

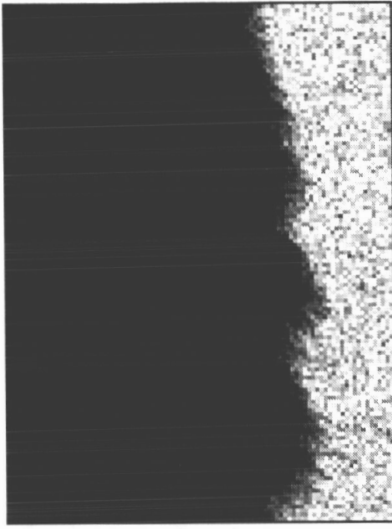

Aluminum

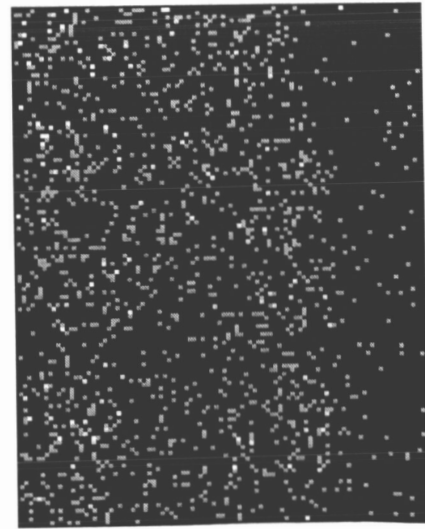

Carbon



Fluorine

- Results confirmed suitability of SEM/EDS technique for characterizing HVOF sprayed PMR-II coatings.



## Results: PMR-II Coating on PMC Substrate

- **Optical Micrograph: HVOF sprayed pure PMR-II coating on PMR-15 PMC substrate [100X].**

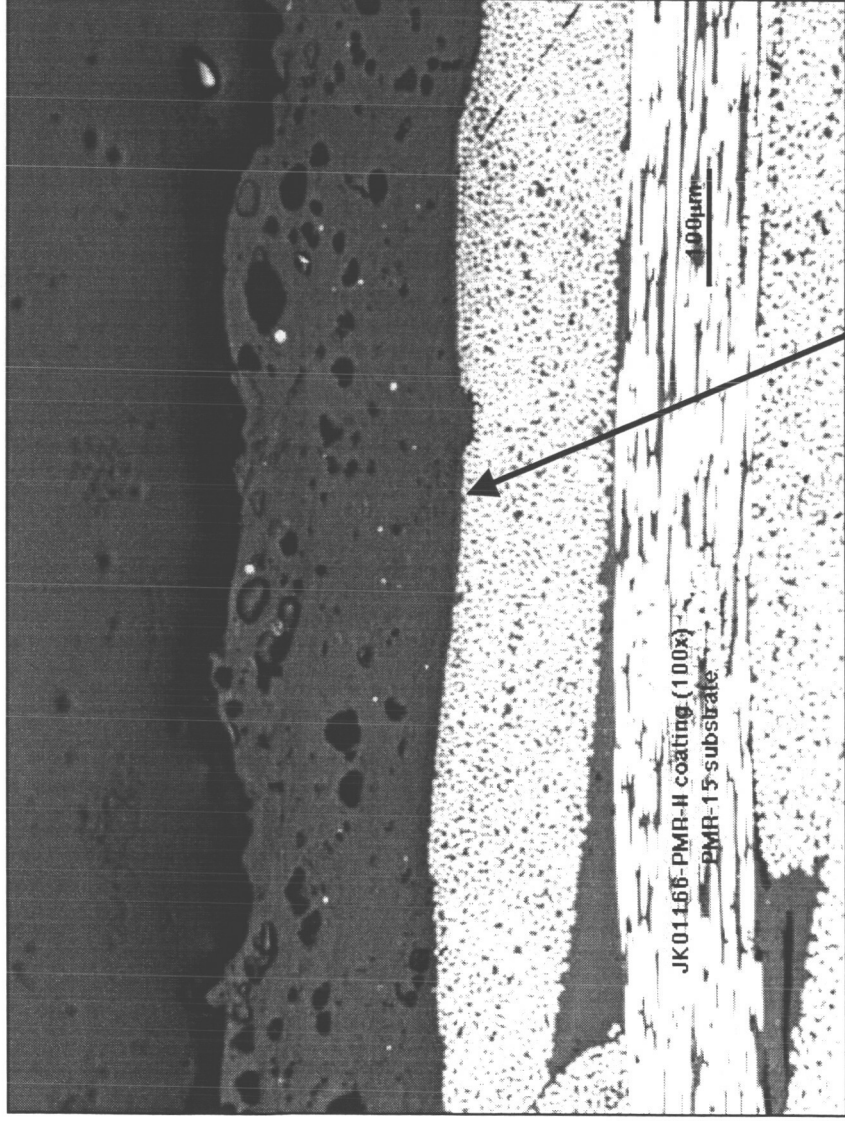

- **Good coating/substrate interface.**
- **Relatively low porosity.**

## Results: 90/10 PMR-II/WC-Co Coatings

- **Optical Micrographs: HVOF sprayed 90 % PMR-II/10 % WC-Co composite coatings:**

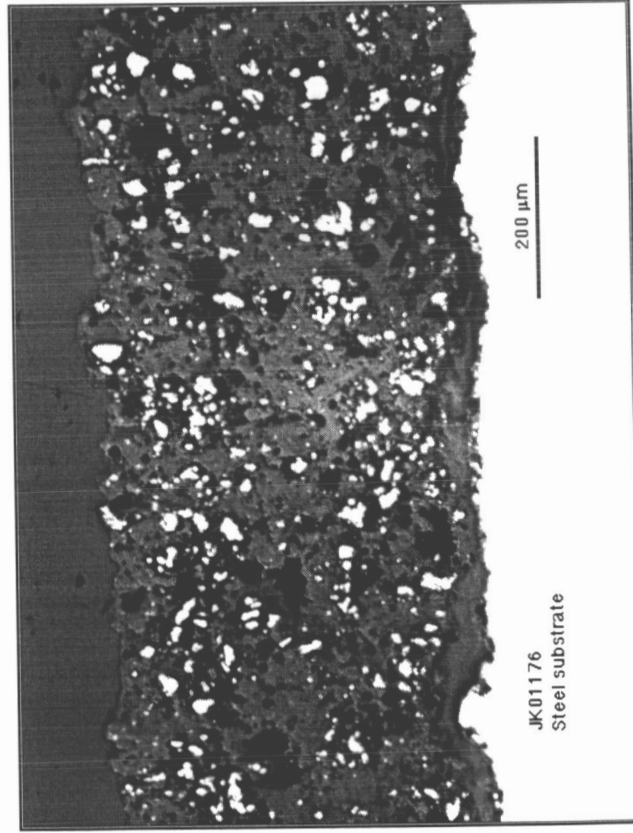

**Steel Substrate [200 X]**

- Good coating/substrate interface.
- Uniform dispersion of WC-Co phase.
- Increased porosity on PMR-15 substrate [likely due to water vapor/gas evolution].

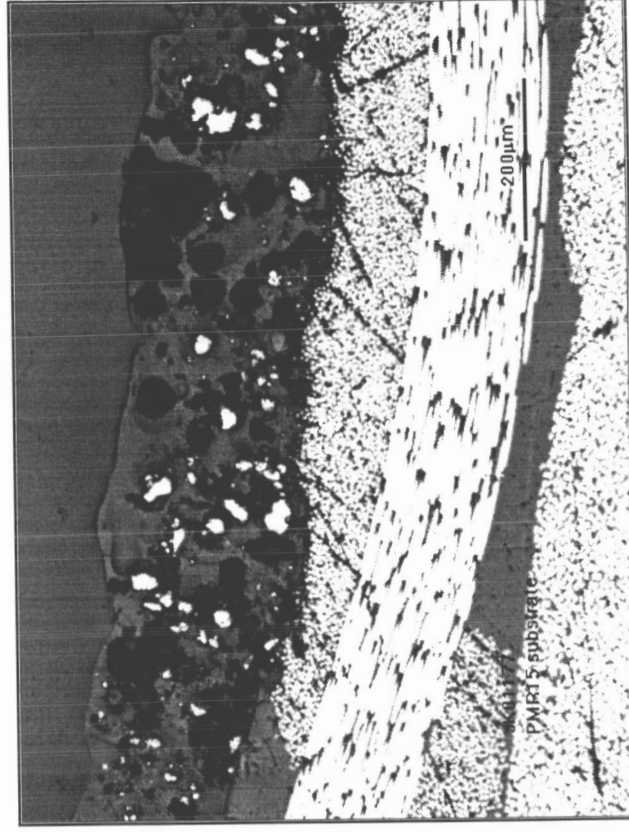

**PMR-15 Substrate [200X]**

## Results: Fractured Coating Cross-Section

- SEM micrograph & corresponding EDS profile of a *fractured cross-section* from a 90 Vol. % PMR-II/10 Vol. % WC-Co coating, removed from substrate.

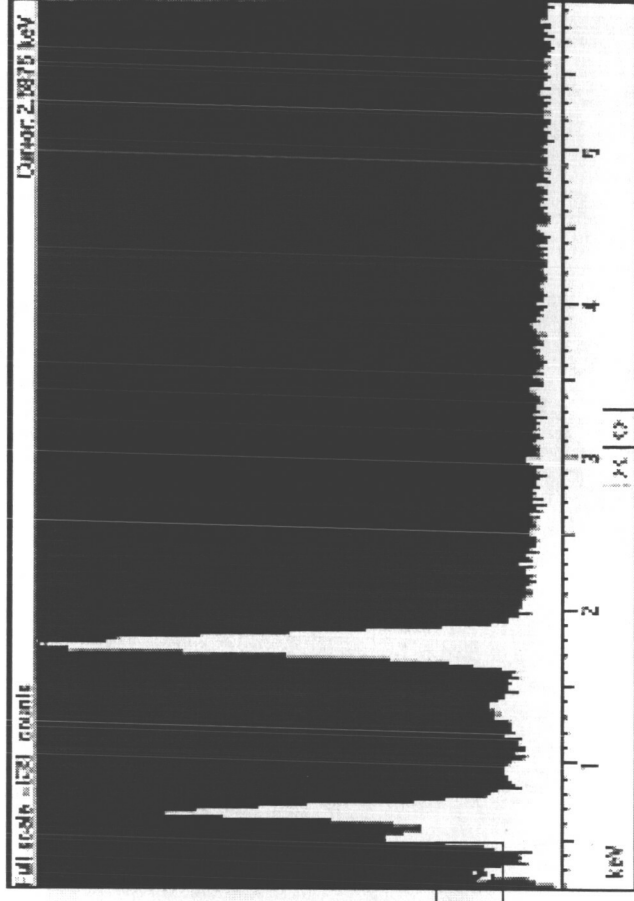

SEM Micrograph [100X]

EDS Spectrum

- Successful deposition & retention of both PMR-II and WC-Co components of Vee-blended feedstock in sprayed deposit.

## Results: Type 1 FGM Composite Coatings

- HVOF Sprayed, 2-layer Coating on Steel Substrate: [200X]:
  - 1<sup>st</sup> layer...pure PMR-II.
  - 2<sup>nd</sup> [top] layer...50:50 Vol. % PMR-II/WC-Co.

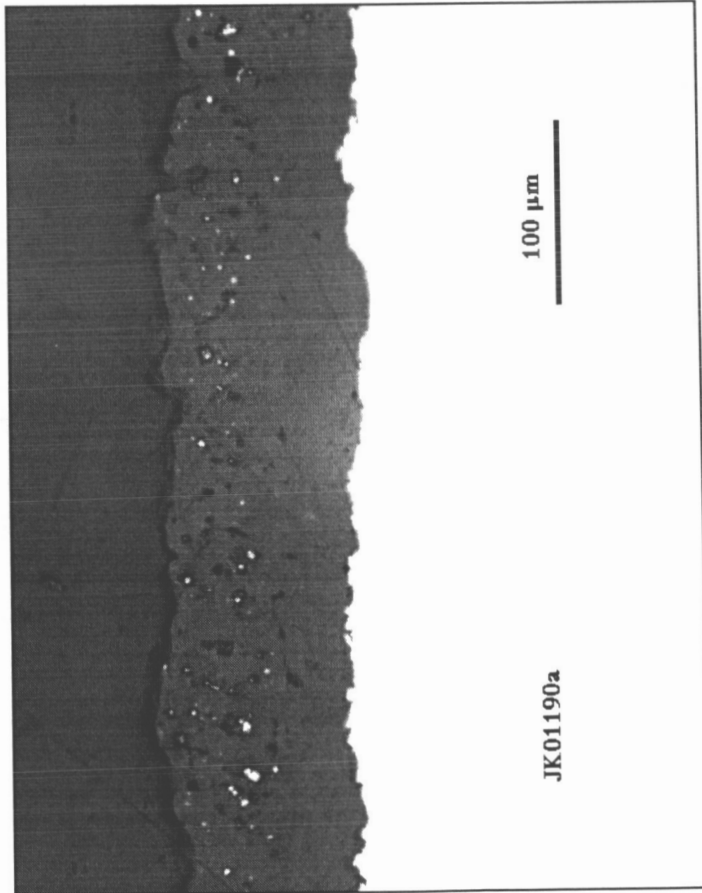

- HVOF Sprayed 90:10 PMR-II/WC-Co Coating on PMR-15 Substrate.

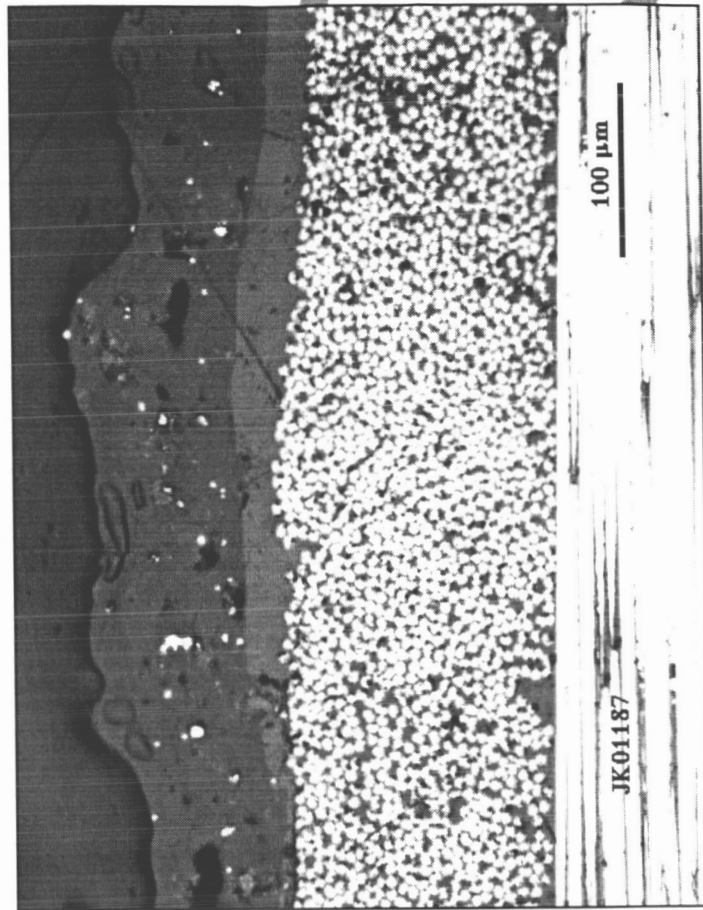

- Good coating/substrate interface.
- Two distinct layers clearly visible.
- WC-Co content does not appear to be 50 %...Ashing in-progress.



- **Previous Study:** New generation PMR polyimides + erosion/oxidation resistant coatings could increase potential applications of PMC's in propulsion structures/ applications.
- **Current Program:**
  - Feasibility of depositing PMR-II and PMR-II + WC/Co demonstrated.
    - *Dense, adherent coatings HVOF sprayed onto steel, Al, PMR-15.*
  - SEM/EDS technique [F] established for confirming retention of PMR-II in HVOF sprayed PMR-II coatings.
  - FTIR spectroscopy found to be suitable for characterizing molecular structure changes during thermal processing of PMR-II polyimide.
  - Dual layer [Type 1] FGM PMR-II/WC-Co coatings successfully sprayed.
  - Initial results indicate that  $T_{\text{substrate}}$  = key parameter influencing deposition & coating build-up, due to rapid heating & cooling characteristic of HVOF spray process.



- **HVOF spraying Type 1 discrete layered & Type 2 continuously graded FGM coatings in a continuous HVOF spraying cycle.**
- **Continued spray parameter optimization and assessment of repeatability.**
- **Measurement of thermoset crosslinking density *via* percent mass swelling.**
- **Measurement of coating adhesion *via* tensile and/or peel type adhesion tests.**
- **Measurement of "as-sprayed" surface roughness [ $R_a$ ] of FGM coatings by stylus-tracing profilometry.**
- **Erosion testing of Type 1 FGM coatings.**
- **Determination of oxidation resistance of polyimide matrix & WC-Co outer layer of FGM coatings by FTIR and EDS, respectively.**
- **Study thermo-mechanical fatigue [TMF] behavior of coating/substrate system using high temperature MTS mechanical testing system.**