

1 GHz, 200 °C, SiC MESFET Clapp Oscillator

Zachary D. Schwartz and George E. Ponchak, *Senior Member, IEEE*

Abstract—A SiC Clapp oscillator fabricated on an alumina substrate with chip capacitors and spiral inductors is designed for high temperature operation at 1 GHz. The oscillator operated from 30 to 200 °C with an output power of 21.8 dBm at 1 GHz and 200 °C. The efficiency at 200 °C is 15 %. The frequency variation over the temperature range is less than 0.5 %.

Index Terms—SiC, oscillator, high temperature.

I. INTRODUCTION

COMMERCIAL, space, and military markets are increasingly relying on sensors to monitor and improve system performance. A growing subset of the sensor market is for systems that must operate at high temperature to improve efficiency, reduce pollution, and/or control operation cost. For example, automobile engine and brake sensors are required to reduce engine pollution and monitor brake wear and slippage, temperature and position sensors on bits for oil drilling and mining are required to monitor the drill wear, aircraft engine sensors are required to increase efficiency and reduce pollution, and spacecraft health monitoring sensors are required to detect spacecraft damage [1]-[3]. In each of these applications, hardwired sensors are currently used, but radio frequency communication with the sensor would reduce the system weight and complexity.

Because of the high temperature requirement, wide bandgap semiconductor devices are ideally suited for this application [4], [5]. A critical component of a wireless sensor system is the local oscillator that generates the RF signal, which will be modulated by the sensor and transmitted to the cooler part of the system. X-Band oscillators based on GaN operating at room temperature with good performance [6]-[8] and an NMOS SiC ring oscillator operating at 625 kHz and 300 °C [9] have been reported. In addition, the authors have reported a SiC MESFET differential oscillator that operated at 515 MHz and 125 °C into a 50 Ω load [10]. Thus, progress towards high temperature, RF oscillators is being made, but further work is required.

In this paper, we report the first oscillator that operates at 1 GHz and 200 °C into a 50 Ω load. The temperature characteristics of the Cree SiC MESFET are measured and used with temperature dependent characteristics of the passive

components to design the oscillator. Measured and simulated results are presented and compared.

II. CIRCUIT DESIGN

A Clapp oscillator, shown in Fig. 1, is chosen because variations in the oscillation frequency due to variations in the transistor capacitances, C_{GS} and C_{DS} , are minimized if $C_1 + C_{DS}$ and $C_2 + C_{GS}$ are large relative to the variation. In addition, the resonant frequency is easily tuned by varying the tank circuit capacitance, C_T , without changing the feedback ratio, which is determined by C_1 and C_2 . Thus, this circuit is ideal for frequency modulation by capacitance varying sensors. Note that the schematic and the simulations include the bias circuit.

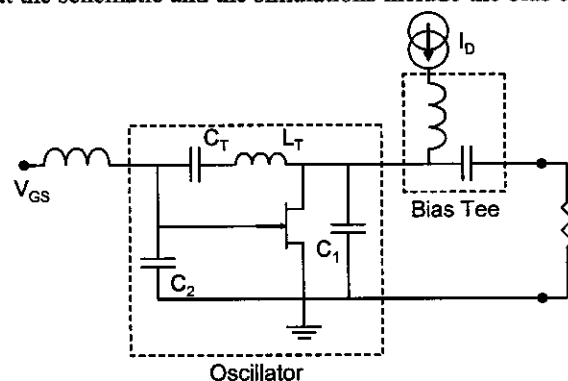

Fig. 1: Clapp oscillator schematic.

The S-parameters of the Cree SiC transistor are measured as a function of temperature, and from that data, f_T and f_{max} for $I_{DS}=100$ mA and $V_{DS}=10$ V are calculated and shown in Fig. 2. It is seen in Fig. 2 that the transistor operates at 1 GHz through 300 °C. Based on the measured S-parameters, a transistor model was generated in Agilent ADS. In addition, a spiral inductor and ceramic chip capacitor were characterized as a function of frequency and temperature, and a temperature dependent equivalent circuit generated. Fig. 3 shows the measured Q factor at 1 GHz of a spiral inductor on an alumina substrate and a ceramic chip capacitor mounted on an alumina substrate. It is noted that the Q factor decreases approximately 60 % and 50 % for the inductor and capacitor respectively when the temperature rises to 200 °C.

Manuscript received March 18, 2005. This work was supported by the NASA Glenn Research Center's Ultra Efficient Engine Technology program.

Z. D. Schwartz was with Analex Corp., NASA Glenn Research Center, Cleveland, OH 44135. He is now with Aeroflex Inc., Powell, OH, 43065.

G. E. Ponchak is with NASA Glenn Research Center, Cleveland, OH 44135, email: george.ponchak@ieee.org, tel 216-433-3504.

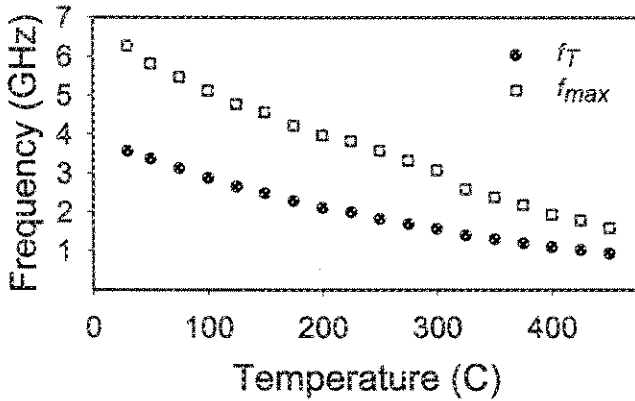

Fig. 2: SiC MESFET f_T and f_{max} measured with $I_{DS}=100$ mA and $V_{DS}=10$ V.

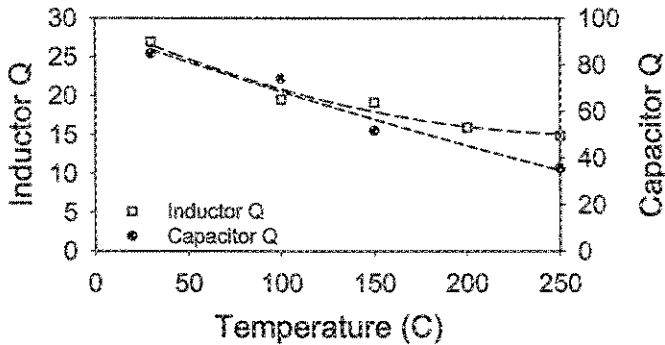

Fig. 3: Measured Q of spiral inductor and ceramic chip capacitor.

Based on the transistor, inductor, and capacitor models, an oscillator circuit was designed to operate at 1 GHz. The circuit was fabricated on a 254 μm thick alumina substrate without backside metallization. The circuit metallization is 2 μm thick plated gold. The capacitors C_1 , C_2 , and C_3 are 4.0, 4.0, and 10.0 pF ceramic chip capacitors respectively and the 8.5 nH inductor, L_T , is plated gold spiral. Gold bond wires are also used to connect the terminals of the transistor to the circuit and to connect to the inner arm of the spiral inductor. A photograph of the oscillator is shown in Fig. 4.

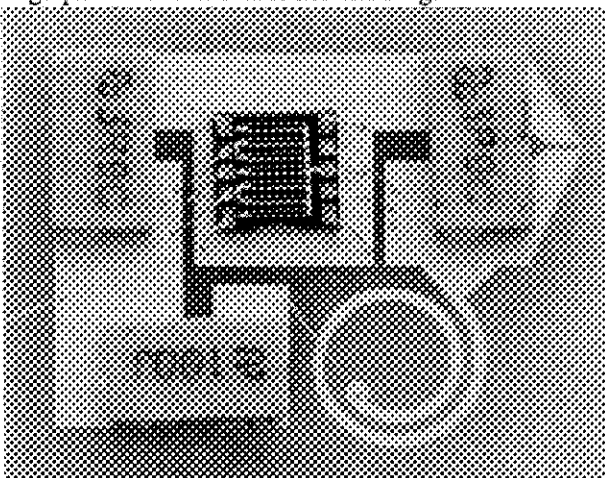

Fig. 4: Photograph of oscillator comprised of SiC MESFET, ceramic chip capacitors, and gold wire bond interconnects.

III. MEASUREMENT TECHNIQUE

A single DC needle probe is used to supply V_{GS} while I_{DS} is supplied through the ground-signal (GS) RF probe that

extracts the RF power; GS probe pads are seen on the right hand side of Fig. 4. The circuit rests directly on a ceramic heater that is computer controlled [11], with the thermocouple measuring the temperature of the ceramic heater. Thus, the reported temperature is the carrier temperature. The frequency spectrum is measured on a spectrum analyzer, which provides a 50 Ω load. Before measurement, the loss of the bias tee, coaxial cable, and RF probe was measured at 30 $^\circ\text{C}$; the reported data is corrected for the measured 0.8 dB loss.

IV. RESULTS

The measured output power, P_{out} and efficiency, η , of the oscillator as a function of I_{DS} and V_{GS} at 30 $^\circ\text{C}$ is shown in Fig. 5. It is seen that a current of 100 mA and a gate voltage in the range of 8 V provides the maximum efficiency at the lowest DC power. The measured power spectrum at 30 $^\circ\text{C}$, $I_{DS}=100\text{mA}$, and $V_{DS}=10\text{V}$ is shown in Fig. 6.

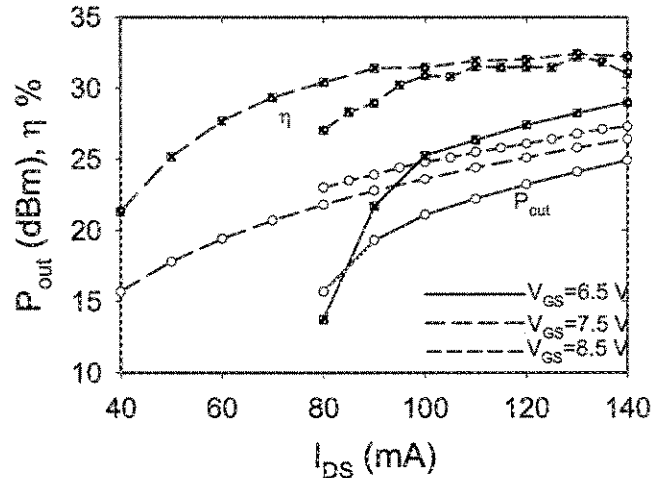

Fig. 5: Measured oscillator output power and efficiency, η , at 30 $^\circ\text{C}$.

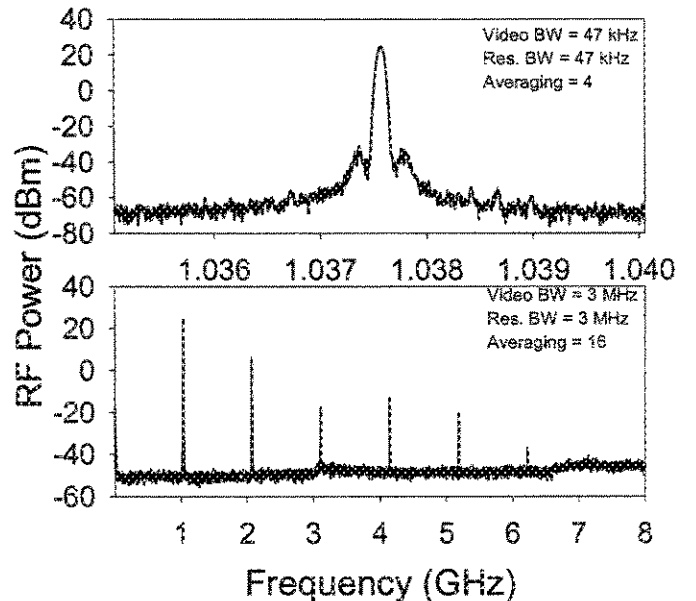

Fig. 6: Measured RF spectrum at 30 $^\circ\text{C}$, $I_{DS}=100$ mA, $V_{DS}=10$ V.

Based on the room temperature results, a current of 100 mA and V_{DS} of 10 V is used for the high temperature circuit characterization. Measured and simulated P_{out} , efficiency, and

V_{GS} as a function of temperature are shown in Fig. 7. The measured oscillator ceased operation at 210 °C, while the circuit stopped operating at 180 °C in simulation. First, it is noted the excellent agreement between the measured and simulated parameters, which validates the transistor and passive component models. Measured P_{out} drops from 25.5 to 21.8 dBm and efficiency drops from 35 to 15 % as the temperature increases from 30 to 200 °C. Over the 170 °C temperature range, the oscillation frequency varied from a minimum of 1.0348 GHz to a maximum of 1.0376 GHz, or the measured frequency of oscillation varied by less than 0.5 % as the temperature increased from 30 to 200 °C.

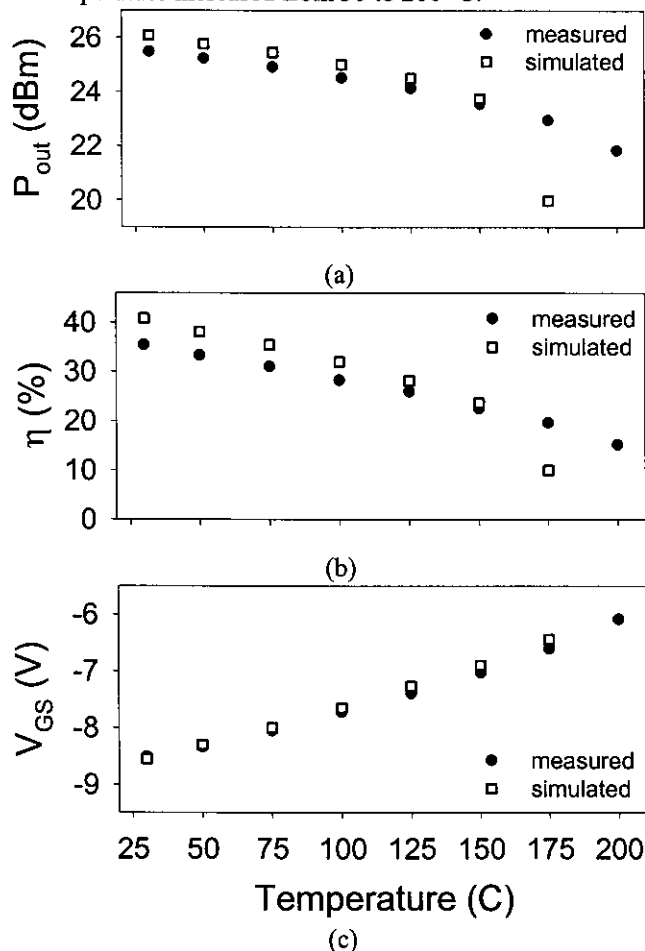

Fig. 7: Measured and simulated P_{out} (a), η (b), and V_{GS} (c) as a function of temperature.

The performance of this oscillator is limited by the increasing losses in the passive components at higher temperature. We believe that using a higher Q tank circuit would allow the temperature limit to be extended even higher than 200 °C. Simulations show that if the loss in the passive components did not increase with temperature (the capacitor and inductor Q of 80 and 27 remain constant), the circuit would operate through 300 °C.

V. CONCLUSION

This paper reports the first design and operation of a microwave frequency oscillator at 200 °C. Furthermore, the results indicate that the circuit may operate through 300 °C if higher Q passive components are used.

REFERENCES

- [1] K. C. Reinhardt and M. A. Marciniak, "Wide-bandgap power electronics for the More Electric Aircraft," *Proc. 1996 Energy Conversion Engineering Conference 31st Intersociety (IECEC 96)*, Aug 11-16, 1996, vol.1, pp. 127-132.
- [2] C. Johnston, A. Crossley, and R. Sharp, "The possibilities for high temperature electronics in combustion monitoring," *Proc. Advanced Sensors and Instrumentation Systems for Combustion Processes*, 2000, pp. 9/1-9/3.
- [3] S. Lande, "Supply and demand for high temperature electronics," *Proc. The Third European Conference on High Temperature Electronics*, 1999 (HITEN 99), pp. 133-135.
- [4] R. J. Trew and M. W. Shin, "Wide bandgap semiconductor MESFETs for high temperature applications," *Third Int. Conf. on Integrated Nonlinear Microwave and Millimeterwave Circuits Dig.*, Oct. 5-7, 1994, pp. 109-123.
- [5] R. C. Clarke, C. D. Brandt, S. Sriram, R. R. Siergiej, A. W. Morse, A. K. Agarwal, L. S. Chen, V. Balakrishna, and A. A. Burk, "Recent Advances in High Temperature, High Frequency SiC Devices," *Proc. 1998 High-Temperature Electronic Materials, Devices, and Sensors Conf.*, Feb. 22-27, 1998, San Diego, CA, pp. 18-28.
- [6] V. S. Kaper, V. Tilak, H. Kim, A. V. Vertiatichikh, R. M. Thompson, T. R. Prunty, L. F. Eastman, and J. R. Shealy, "High-power monolithic AlGaIn/GaN HEMT oscillator," *IEEE Journal of Solid-State Circuits*, Vol. 38, No. 9, Sept. 2003, pp. 1457-1461.
- [7] P. Rice, R. Sloan, M. Moore, A. R. Barnes, M. J. Uren, N. Malbert, and N. Labat, "A 10 GHz dielectric resonator oscillator using GaN technology," *2004 IEEE MTT-S Int. Microwave Symp. Dig.*, Fort Worth, TX, June 6-11, 2004, pp. 1497-1500.
- [8] J. B. Shealy, J. A. Smart, and J. R. Shealy, "Low-phase noise AlGaIn/GaN FET-based voltage controlled oscillators (VCOs)," *IEEE Microwave and Wireless Comp. Lett.*, Vol. 11, No. 6, June 2001, pp. 244-245.
- [9] U. Schmid, S. T. Sheppard, and W. Wondrak, "High temperature performance of NMOS integrated inverters and ring oscillators in 6H-SiC," *IEEE Trans. Electron Dev.*, Vol. 47, No. 4, April 2000, pp. 687-691.
- [10] Z. D. Schwartz and G. E. Ponchak, "High temperature performance of a SiC MESFET based oscillator," accepted for publication in the *2005 IEEE MTT-S Int. Microwave Symp. Dig.*, Long Beach, CA, June 12-17, 2005.
- [11] Z. D. Schwartz, A. N. Downey, S. A. Alterovitz, and G. E. Ponchak, "High-temperature RF probe station for device characterization through 500 °C and 50 GHz," *IEEE Trans. on Instrumentation*, Vol. 54, No. 1, pp. 369-376, Feb. 2005.