

NASA Technical Memorandum 2000-208577



MARS GREENHOUSES: CONCEPTS AND CHALLENGES

Proceedings from a 1999 Workshop

R.M. Wheeler and C. Martin-Brennan, Editors

National Aeronautics and Space Administration
John F. Kennedy Space Center, Kennedy Space Center, FL, USA 32899-0001

August 2000

TABLE OF CONTENTS

	(page)
MARS GREENHOUSE WORKSHOP SUMMARY	1
SCIENCE DISCUSSION.....	1
ENGINEERING DISCUSSION.....	2
LIST OF ATTENDEES.....	5
<i>Contributed Papers</i>	
PLANTS ON MARS: ON THE NEXT MISSION AND IN THE LONG TERM FUTURE <i>Cristopher P. McKay</i>	6
BUBBLES IN THE ROCKS: NATURAL AND ARTIFICIAL CAVES AND CAVITIES AS LIFE SUPPORT STRUCTURES <i>Penelope J. Boston</i>	9
CHALLENGES FOR BIOREGENERATIVE LIFE SUPPORT ON MARS <i>Frank N. Salisbury</i>	18
COST EFFECTIVENESS ISSUES..... <i>Alan Drysdale</i>	27
LOW PRESSURE SYSTEMS FOR PLANT GROWTH	39
<i>Ronald Lacey, Malcolm Drew, and Robert Spanarkel</i>	
PLANT RESPONSES TO RARIFIED ATMOSPHERES..... <i>Kenneth A. Corey, Philip A. Fowler, and Raymond M. Wheeler</i>	48
CAN CO ₂ BE USED AS A PRESSURIZING GAS FOR MARS GREENHOUSES?..... <i>Raymond M. Wheeler</i>	58
INFLATABLE HABITATS TECHNOLOGY DEVELOPMENT..... <i>Kriss J. Kennedy</i>	64
DEVELOPMENT OF AN INFLATABLE GREENHOUSE FOR A MODULAR CROP PRODUCTION SYSTEM <i>J.M. Clawson</i>	77
MARS INFLATABLE GREENHOUSE WORKSHOP..... <i>Charles R. Sandy and Dave Cadogan</i>	90

TABLE OF CONTENTS
(continued)

	<i>(page)</i>
DESIGN NEEDS FOR MARS DEPLOYABLE GREENHOUSE..... <i>Ray A. Bucklin, Phil A. Fowler, and James D. Leary</i>	98
PRELIMINARY ESTIMATES OF THE POSSIBILITIES FOR DEVELOPING A DEPLOYABLE GREENHOUSE FOR A PLANETARY SURFACE MARS <i>V.Ye. Rygalov, R.A.Bucklin, P.A. Fowler, and R.M. Wheeler</i>	105
LOW PRESSURE GREENHOUSE CONCEPTS FOR MARS <i>Philip A. Fowler, Raymond M. Wheeler, Ray A. Bucklin, and Kenneth A. Corey</i>	116
MARS GREENHOUSE STUDY: NATURAL VS. ARTIFICIAL LIGHTING..... <i>Bruce Gertner</i>	124
WIRE CULTURE FOR AN INFLATABLE MARS GREENHOUSE AND OTHER FUTURE INFLATABLE SPACE GROWTH CHAMBERS <i>Philip D. Sadler</i>	127

MARS GREENHOUSE WORKSHOP SUMMARY

On December 9-10, 1999, a workshop was held at NASA's Kennedy Space Center (KSC), FL, USA to discuss issues and challenges related to developing and deploying a greenhouse for growing plants on Mars. The workshop was sponsored by the KSC Center Director Discretionary Fund, in cooperation with the Advanced Life Support (ALS) Project Office at Johnson Space Center (JSC). A primary objective of the workshop was to review current activities in the areas of low-pressure plant research and inflatable structure concepts that might be applied to planetary surface greenhouses. Participants in the workshop included researchers and engineers from universities, private industry, and NASA centers. Presentations covered a range of topics including descriptions of the Martian surface environment, the effects of low atmospheric pressure and high CO₂ on plants, structural concepts for plant enclosures, the use of inflatable materials capable of withstanding the pressure and thermal gradients, approaches for plant lighting, and the economics of using plant systems for life support on Mars.

The first day of the workshop consisted of presentations by speakers covering three general areas: 1) bioregenerative life support and the Mars environment; 2) controlled environment crop production for Mars; and 3) structural and materials issues for Mars greenhouses. Following completion of talks, participants separated into two discussion groups to identify 1) science issues (biological research) for plant production on Mars, and 2) engineering issues for developing and deploying a Mars greenhouse. Discussion groups were also asked to identify terrestrial analogs for ground-based testing and possible space flight tests for near, mid and far-term timeframes. A summary of the discussions follows:

Science Discussion:

The science group agreed that a deployable greenhouse is a worthwhile goal for demonstrating bioregenerative life support capabilities on Mars. Deployment of a greenhouse could follow development of a plant growth chamber (salad machine) that might be used in the transient vehicle or inside human habitats, or could be part of precursor mission prior to human arrival on the surface. A deployable greenhouse could provide expanded growing area with relatively low-cost volume, and depending on the structural design and materials, could utilize incident solar radiation, i.e., be independent or only partially dependent on electric lighting. The group thought it was important for the ALS program to consider strategic planning for deploying a greenhouse for the Mars, and to utilize early Mars missions for achieving this goal.

NASA currently has planetary protection program to control the transfer any terrestrial life forms beyond Earth's orbit. But because of the difficulties and possible undesirable aspects of growing plants aseptically, totally eliminating the risks of microbes escaping a deployable greenhouse (e.g., through atmospheric leakage) may be impractical. Thus a change in current planetary protection policy would be needed to accommodate sending plants and deploying greenhouse structures on the Martian surface.

The following research areas / questions were suggested for preparing to deploy Mars greenhouses:

- What are to lower limits for critical environmental parameters with regard to acceptable production of edible biomass?
 - Pressure (low pressures could reduce structural demands and gas leakage)
 - Light (light transmitted through the structure may be low, particularly during dust storms)
 - Temperature (the external environment is cold and there may be advantages for reducing the thermal gradient between inside and outside the structure)

- What are the upper and lower limits of partial pressure of CO₂, H₂O, O₂ and buffer gases (e.g. N₂, Ar), both from the perspective of plant growth and environmental management?
- What are the mass transfer requirements, especially water flux, for plant growth as a function of total pressure, gas partial pressures, and growing substrate?
- Will 1/3 gravity present any problems? Spaceflight experiments using a centrifuge on ISS could be undertaken to study 1/3 g.
- Can Martian regolith be used as a substrate to grow plants? What are the physical and chemical characteristics of regolith at possible landing sites? Will Mars regolith be toxic to plants? Can organic materials be combined with local regolith to generate soils?
- What are strategies for managing the nitrogen cycle, particularly in oxygen deprived environments where bacterial denitrification may occur?
- How do plant microbial interactions and pathogens respond to low O₂, high CO₂, and anticipated relative humidities?
- What are the psychological benefits to the crew from growing plants in extreme, isolated environments? This is a key question for any bioregenerative system employing plants.
- Can terrestrial analogs be used study plant responses that might occur in a Mars greenhouse, (for example high altitude settings)? Can plants from high altitude settings be used for a Mars greenhouse? The group agreed that testing/deploying a greenhouse set-up in a harsh terrestrial setting would be valuable.
- What experiments can be flown to prepare for a Mars greenhouse? The group felt it was important for the bioregenerative community to use a range of opportunities to test concepts.
 - Mars Lander missions
 - International Space Station (ISS)
 - Other?

The group did not have enough time to suggest time frames for addressing the issues, or assign any priorities to areas for research, and follow-up workshops was suggested to focus on these issues.

Engineering Discussion

The engineering group developed a set of issues and a roadmap outlining a timeframe for characterizing and conceptualizing different systems. These systems were based on development of the technologies, ground and flight experiments, including terrestrial analogs, and mission scenarios and strategic implementation plans. The time frame associates with these issues was: near-term – < 5 years; mid-term – 5 to 15 years; and far-term – 15 to 30 years.

Issues identified for attention:

- Development and testing of environmental monitoring and control systems, especially:
 - Atmospheric constituents
 - Photosynthetically active radiation (PAR)
 - Pressure, including:
 - Structural interactions and implementation issues
 - Plant response and production issues
- Considerations related to the enclosures or structures, including:
 - Materials
 - Transparent or opaque materials
 - Thermal qualities
 - Effects of UV radiation
 - Gas leakage
 - Size and volume
 - Configuration
 - Man-rated requirements
 - Interfaces (mass and power transfer, human-machine interfaces, crew access)
 - Stowage and deployment
- Operations and Maintenance
 - Cultivation systems
 - Automation / mechanization
 - Maintainability
 - Reliability
 - Water / resource recycling
- Use and Availability of *In-Situ* Resources
 - Water
 - CO₂
 - By-products of propellant production (e.g., Ar, N₂)
 - Regolith
- Energy Management
 - Power source
 - Solar radiation
 - Thermal management

Time frame and roadmap considerations:

- NEAR-TERM – Characterizing and Conceptualizing of the Systems
 - Photosynthetically active radiation (PAR)
 - Materials

- Thermal
 - Solar / atmosphere models
 - Mass / volume trade studies (concepts)
 - Applying equivalent system mass (ESM) analysis
 - Environmental tests
 - Database
 - Crop handbook
 - Real-time operational parameters
 - Engineering database
- MID-TERM - Development of the Technologies and Flight Experiments
 - Demonstrate technologies (TRL 5 or higher)
 - e.g., 1/3 g testing on ISS centrifuge
 - Design requirements for components and systems
 - Advocacy (building public support for the program)
 - Terrestrial analog testing
 - FAR-TERM - Mission Scenario Implementation Plans

In developing the issues and timeframes, the engineering group recognized the importance of early characterization of the Martian environment, the responses of plants in anticipated “greenhouse” environments, the requirements for the structure, and the role for Bioregenerative Life Support in the missions as they develop. The group felt that identification of the issues, ground and flight testing, including analogs, and strategic planning based on mission scenarios and economic analyses are critical to providing life support and self-sufficiency for humans to carry out research and exploration on the Martian surface.

**ATTENDEES Mars Greenhouse Workshop
Kennedy Space Center, FL (Dec. 99)**

Mike Alazraki	Dynamac Corp., Kennedy Space Center, FL
Direlle Baird	University of Florida, Gainesville, FL
Charlie Barnes	NASA Headquarters, Washington, DC
Jim Blank	Hitec Corp., Orlando, FL
Penny Boston	Complex Systems Research, Longmont, CO
Chris Brown	Dynamac Corp., Durham, NC
Ray Bucklin	University of Florida, Gainesville, FL
Peter Chetirkin	Dynamac Corp., Kennedy Space Center, FL
Jim Clawson	BioServe Technologies, Univ. of Colorado, Boulder, CO
Ken Corey	University of Massachusetts, Amherst, MA
Mike Dixon	University of Guelph, Ontario, Canada
John Downen	Maderia Beach, FL
Zinaida Downen	Maderia Beach, FL
Alan Drysdale	Boeing Corp., Kennedy Space Center, FL
Rob Ferl	University of Florida, Gainesville, FL
Phil Fowler	Dynamac Corp., Kennedy Space Center, FL
Bruce Gertner	Lockheed Martin Co., Johnson Space Center, Houston, TX
Gene Giacomelli	Rutgers University, New Brunswick, NJ
Greg Goins	Dynamac Corp., Kennedy Space Center, FL
Don Henninger	NASA, Johnson Space Center, Houston, TX
Inka Hublitz	Technical University, Munich, Germany
Kriss Kennedy	NASA, Johnson Space Center, Houston, TX
Ron Lacey	Texas A & M University, College Station, TX
James Leary	University of Florida, Gainesville, FL
Rupert Lee	NASA, Kennedy Space Center, FL
Howard Levine	Dynamac Corp., Kennedy Space Center, FL
Dean Lewis	NASA, Kennedy Space Center, FL
Cindy Martin-Brennan	Bionetics Corp., Kennedy Space Center, FL
Chris McKay	NASA, Ames Research Center, Moffett Field, CA
Dave Mears	Rutgers University, New Brunswick, NJ
Oscar Monje	Dynamac Corp., Kennedy Space Center, FL
Mike O'Neal	NASA, Kennedy Space Center, FL
Jaine Palou	NASA, Kennedy Space Center, FL
Ralph Prince	Cape Canaveral, FL
Jeff Richards	Dynamac Corp., Epcot, FL
Pete Richusio	NASA Kennedy Space Center, FL
Vadim Rygalov	Institute for Biophysics, Krasnoyarsk, Russia
Phil Sadler	Sadler Machine Co., Phoenix, AZ
John Sager	NASA, Kennedy Space Center, FL
Frank Salisbury	Utah State University, Logan, UT
Mary Salisbury	Salt Lake City, UT
Charles Sandy	ILC Dover, Inc. Frederica, DE
Andy Schuerger	Dynamac Corp., Epcot, FL
Guntur Subbarao	US Natl. Res. Council, Kennedy Space Center, FL
Karen Thompson	NASA, Kennedy Space Center, FL
Ray Wheeler	NASA, Kennedy Space Center, FL
Scott Young	Dynamac Corp., Kennedy Space Center, FL
Nancy Zeitlin	NASA, Kennedy Space Center, FL

Plants on Mars: On the Next Mission and in the Long Term Future

Christopher P. McKay
Space Science Division
NASA Ames Research Center
Moffett Field CA 94035
cmckay@mail.arc.nasa.gov

Abstract

Current research on greenhouses for Mars is centered on their use as life support for human missions and should be expanded to include systems for near term landers as well as experiments in the long term establishment of natural ecosystems on Mars. The deployment of a simple plant growth module, containing just one plant, in near term robotic missions to Mars would be an important way to test systems and materials for use in larger greenhouses. In addition, a near term plant growth module would focus interest on biological life support and generate interest in the public and within NASA. In the long term, biological life support must leave the greenhouse and spread over the entire planet. In parallel with the development of crop plants, research into plant growth under martian conditions should begin to look at the creation of natural alpine-like ecosystems on Mars as part of an overall terraforming program.

Introduction

Mars is a target for human exploration because of its interesting past history of water activity and possibly life. All the elements needed to support life are present in the martian environment, albeit at low levels. For example the martian atmosphere contains carbon dioxide, water vapor, and nitrogen. These resources can be used to produce rocket fuel (Ash et al., 1978; Clark, 1979) as well as life support consumables (Clark, 1979; Meyer, 1981; Meyer and McKay, 1989; McKay et al., 1993). Thus, one significant attraction of Mars for human exploration is the prospect that the air and water needed for a human crew can be produced on Mars rather than transported from Earth. This logic can extend to food as well. Considerable thought has gone into designs for food production in greenhouses for martian applications (e.g., Boston, 1981; 1985; Schwartzkopf and Mancinelli, 1991; Andre and Massimino, 1992).

Most of the research focus has, understandably, been on greenhouses containing crop plants to support a near term human base consisting of up to a dozen or so astronauts. The greenhouse would provide food and oxygen for the human habitat as well as providing a waste recycling function (Boston, 1985; MacElroy et al., 1992; McKay et al., 1993).

However it is also important to consider plant growth applications on Mars that are come before and after human-focused greenhouse. This paper considers near term experiments that could be conducted on a Mars lander as well as long term experiments in natural ecosynthesis on Mars.

Plants on the Next Mission to Mars

Logically, the first plant growth module on Mars should not be a full scale greenhouse design to support a human crew. Instead it should be a technology testbed in which one or a few plants are grown in a system that tests possible greenhouse materials and the utilization of martian resources.

A small plant growth module on a near term Mars lander would serve many important functions. By using martian soil as a plant growth medium it would test for toxic components and indicate the level of nutrients that must be added to the soil to optimize plant growth. A plant growth module could demonstrate the use of martian atmospheric gases for a greenhouse working in combination with systems being built to extract carbon dioxide, oxygen and water from the martian atmosphere.

A growth module on Mars could also test materials under consideration for martian greenhouses. One of the important design questions for martian greenhouse is the covering material. Ideally one the greenhouse would be covered with a material that allowed for maximal light transmission for plant growth, protected against ultraviolet light without being destroyed by it, and was strong enough to support

a considerable pressure difference against the low ambient martian pressure (0.6 KPa). Currently such a material does not exist and if one is not developed martian greenhouses may well have to be located underground with the attendant costs of providing for artificial lighting.

As candidate materials are developed it would be important to test them in small scale systems before incorporating them in full greenhouse designs. From a technical point of view this alone would justify a small scale experiment on a near term Mars lander.

Simple plant growth modules on near term landers could provide a basis for designs of larger test systems that could be deployed robotically in advance of human missions. Such large scale systems could be the center piece of what is now called the "robotic outpost" phase of Mars exploration. This phase is imagined to be the segue between the current small lander missions and a human base.

Developing a flight program for plant growth on Mars would have technical as well as programmatic benefits. Programmatically, the development of a plant growth module would motivate an early accommodation between the current planetary protection policy - which prevents sending Earth life to Mars - and the need to grow plants and send humans to Mars. In addition demonstrated growth in martian soil would help alleviate back contamination issues. Perhaps most importantly from a programmatic point of view, a flight program would ensure continuity and visibility for biological based life support systems on Mars.

Plants in the Long Term Future on Mars

The cooperative agreement notice (CAN) that initiated NASA's program of Astrobiology included among its six key questions "What is the potential for survival and biological evolution beyond the planet of origin?" Evolution is a property not of individual organisms or even individual species, but of ecosystems over many generations. In our solar system the only possible candidate for testing biological evolution beyond the planet of origin is Mars. The restoration of Mars to a biological state, known as terraforming, or more appropriately ecosynthesis, is an application of plant based life support to the planet Mars as a whole (Averner and MacElroy, 1976; McKay, 1982; McKay et al., 1991).

The first step in ecosynthesis on Mars is warming the planet and is primarily an engineering problem (McKay et al., 1991). However, as the martian environmental conditions become more clement plants from Earth could be introduced on Mars. The first plants grown naturally on Mars are likely to be hardy polar and alpine varieties. Eventually, as the martian biosphere became more Earth-like other temperate plants would be introduced. The temporal succession of ecosystems on Mars might be similar to the spatial succession observed on the slopes of mountain (Graham, 2000). An important difference between natural ecosystems and greenhouse ecosystems is that in natural ecosystems crop plants are not the focus.

Although the introduction of plants into the natural martian environment is still many years away it would be useful to begin basic research in plant response to martian conditions for two reasons. First, the plants that would be under study - arctic and alpine - are likely to contain genes that assist in their survival at low temperature, low pressure, low water availability and other extremes. These capabilities might be usefully transplanted into crop plants for use in martian greenhouses and may be useful on Earth as well. For example some types of algae can grow under pure carbon dioxide (Seckbach et al., 1970). The second reason to begin testing of alpine and arctic plants is to allow for long term generational studies that would be key to understanding ecosystem evolution on a terraformed Mars.

Conclusion

In parallel with current research on greenhouses designed for human bases on Mars it would be useful to begin work directed toward placing a plant growth module on a near term Mars lander. In addition, studies of the ability of non-crop plants to survive in martian conditions could contribute to the development of hardy strains of crop plants optimized for use on Mars. Studies of plant growth on Mars are a continuum: from near term single plant modules, to greenhouses for human life support, to the synthesis of natural ecosystems on Mars.

References

1. Andre, M. and Massimino, D. 1992. Growth of plants at reduced pressures: Experiments in wheat technological advantages and constraints. *Adv. Space Res.* 12:(5)97-106.
2. Ash, R.L., Dowler, W.L. and Varsi, G. 1978. Feasibility of Rocket Propellant Production On Mars. *Acta Astronautica*, 5:705-724.
3. Averner M.M. and MacElroy, R.D., Eds., 1976. *On the Habitability of Mars*. NASA Spec. Publ., 414 pp. NASA-Ames Research Center, Moffett Field, Ca.
4. Boston, P.J. 1985. Critical life support issues for a Mars base. In *Case for Mars II*, ed. C.P. McKay, American Astronautical Society Science and Technology Series, 62:287-331.
5. Boston, P.J. 1981. Low pressure greenhouses and plants for a manned research station on Mars. *J. Brit. Interplanet. Soc.* 34:189-192.
6. Clark, B.C. 1979. The Viking Results --- The Case for man on Mars, *Adv. Astronaut. Sci.* 38:263-278.
7. Graham, J. M. 2000. Biological aspects of terraforming Mars, preprint.
8. MacElroy, R.D., Kliss, M. and Straight, C. 1992. Life support systems for Mars transit. *Adv. Space Res.* 12:(5)159-166.
9. McKay, C.P. 1982. Terraforming Mars. *J. British Interplanet. Soc.*, 35:427-433
10. McKay, C.P., Meyer, T.R., Boston, P.J., Nelson, M., MacCallum, T. and Gwynne, O. 1993. Utilizing Martian resources for life support. in J. Lewis, M.S. Matthews and M.L. Guerrieri, "Resources of Near-Earth Space", University of Arizona Press, Tucson, pp 819-843.
11. McKay, C.P., Toon, O.B. and Kasting, J.F. 1991. Making Mars Habitable. *Nature*, 352:489-496.
12. Meyer, T.R. 1981. Extraction of martian resources for a manned research station, *J. British Interplanetary Soc.* 34:285-288.
13. Meyer, T.R. and McKay, C.P. 1989. The resources of Mars for human settlement. *J. British Interplanet. Soc.* 42:147-160.
14. Schwartzkopf, S.H. and R.L. Mancinelli 1991. Germination and growth of wheat in simulated Martian atmospheres. *Acta Astron.* 25:245-247.
15. Seckbach, J., Baker, F.A. and Shugarman, P.M. 1970. Algae thrive under pure CO₂. *Nature* 227:744-745.

Bubbles in the Rocks: Natural and Artificial Caves and Cavities As Life Support Structures

Penelope J. Boston
Complex Systems Research, Inc, Boulder, CO and
Dept. of Biology, University of New Mexico, Albuquerque, NM
pboston@complex.org

Abstract

During the coming century, humans will land on and explore other bodies in our solar system. Our work on the potential for subsurface life on Mars has convinced us that the subsurface will be an important target of science and exploration for human missions. Importantly, caves are also a resource and could provide habitations and other life support structures for humans on planets, moons, and asteroids.

Contrary to popular belief, caves are not rare. They are simply cracks and enlargements of cracks in planetary bodies or byproducts of vulcanism. Just as early humans found shelter and security in caves, we may use naturally occurring caves and cavities as components of human life support systems on other planetary bodies.

Inflatable or rigidified inflatable liners for use in caves can provide a significantly easier construction method than many surface techniques while allowing protection from ionizing and ultraviolet radiation. Necessary technological developments to adequately use these potential cave resources include critical logistics of communication, navigation, rapid surveying, deep drilling into and from within caves, and cavity prospecting capabilities.

Planetary subsurfaces appear both in scientific literature and science fiction, but we currently possess neither the technologies nor the knowledge to study or use them well. Even on Earth, we use very crude methods for accessing and studying these environments. In addition to challenges presented by the caves themselves, we will be attempting to use and explore them in environs more hostile than any on Earth while maneuvering in awkward pressurized suits. Clearly, there is need for extensive work on methodologies to use caves as resources and objects of scientific inquiry on other worlds. As we wait for the future to unfold before us, we must actively develop the capabilities to meet that future.

Caves as Human Shelter and Resource

We believe that humans will land on the surfaces of Mars, Earth's Moon, Europa, and possibly asteroids and comets within the next half century. Not only will we land, but we will spend protracted periods of time and conduct detailed study of these objects. One of the most interesting types of scientific targets on these bodies will be the near and deep subsurface. For Mars, we have postulated the possible presence of microbial communities living in a zone of liquid water maintained by heat flow from the planet's still hot interior with the means of obtaining energy to run their metabolism based on reactions of inorganic materials (Boston et al., 1992). To assess the feasibility of this suggestion, we have been studying the exotic biochemistries of unusual microbial communities in several of Earth's most spectacular caves for the past number of years. This work has prompted us to consider caves in a new light. We envision them as not only offering great potential for harboring both extraterrestrial life forms or traces of extinct life forms, but also as an in situ resource available for human exploitation during exploration, colonization, and perhaps eventual terraforming activities on other bodies. These ideas are beginning to make the transition from science fiction (e.g. Nordley, 1994; Robinson, 1994) to the realm of science prediction.

The idea of caves as shelter was invented early on in the history of life presumably by microbes (!) and then by invertebrates. Early human ancestor species used caves and overhangs as shelters from environmental insults (Johansen and Edey, 1974; Wymer, 1982). By 2 million

years BCE, artificial habitats were being constructed by *Homo habilis* (Leakey and Lewin, 1977, 1992). Interestingly, a tent-like hut was built inside a cave (the Grotte du Lazaret near Nice, France) dating from about half a million years ago (Jelinek, 1975). The inhabitants, apparently Neanderthals, built a fireplace and other amenities. So, clearly the notion of construction within a cave is an ancient idea, indeed!

Mining, mineral collection, and other extractive activities in caves are similarly ancient in lineage (Tankersley Et al., 1997; Wright, 1971). The proximity to mineral resources not available on the surface lured even ancient humans armed only with burning torches to collect pigments (Hatt et al., 1953), medicinal clays (Arnold and Bohor, 1975) and tradable minerals (Arnold, 1971; Sieveking, 1979; Watson, 1986; Lourandos, 1987).

In recent times, the use of caves on extraterrestrial bodies for human habitation has been suggested by a number of workers. Lunar lava tube bases have received a good deal of attention (Horz, 1985; Walden, 1988; Kokh, 1996; Taylor, 1998). Mars lava tubes have been considered as habitat and greenhouse structures (Frederick, 1999; Boston, 1996; Walden Et al., 1988).

In our future exploration of the solar system, caves may provide a natural "pressure vessel" for the construction of subsurface habitats. They offer several valuable features: 1) protection from ionizing and ultraviolet radiation, 2) insulation from thermal oscillations, 3) protection from impacting objects, 4) sealability to contain a higher than ambient atmospheric pressure, and 5) access to potentially important subsurface resources, e.g. geothermal energy sources, water, reduced gases, and minerals.

Caves in the Solar System? How Crazy is That?

Using caves is all very well, you may say, but what is the likelihood of finding such structures on Mars and other planets? Where are the carbonates? Figure 1 shows a view of how a Martian dried lakebed or evaporite basin might appear and there is some evidence for these features on Mars (McKay and Nedell, 1988; Nedell et al., 1987). Where is the water to make drippy formations like those we have all seen in tourist caves? Water may be present in the Martian subsurface but is still a subject for contention and speculation (Jakosky Et al., 1997; Carr and Wanke, 1992; Davies, 1981). On Earth, there are many different types of caves and subsurface cavities (Hill and Forti, 1997). Contrary to popular belief, although the preponderance of these are the result of the action of water on limestone and dolomite (karst), there are many other types of caves formed by faulting and other geological processes not involving solutional geology. The most well known type of the latter are lava tubes and bubbles. There are spectacular ice caves and fissures. There are caves formed in deserts by collapse of poorly consolidated materials in response to Earth movements. There are caves in quartzite formed by nonaqueous chemical corrosion of the rock. On bodies with different chemical, geological, and gravitational properties, there may be other ways of forming caves as yet unknown to us. For example, periodic thermal loss of volatiles from comets near perihelion comes to mind.

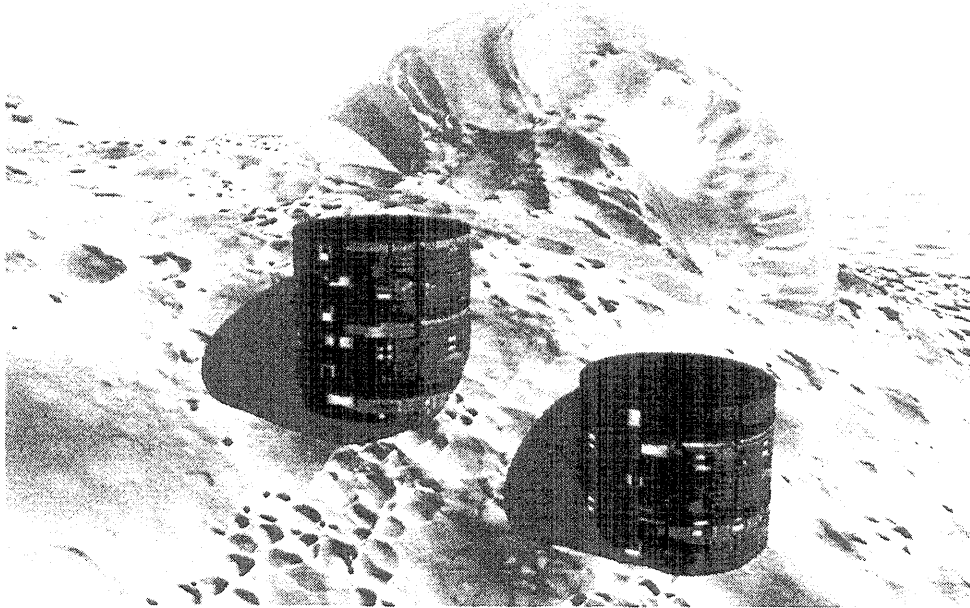

Figure 1. Artist's conception of a skylight dome over a subsurface habitat on the edge of a hypothetical Martian carbonate basin. Whether carbonates do or do not exist on Mars, subsurface cavities can be created in many other geological materials and be available for use as a human resource for habitation. By G. Frederick, 1999.

We assert that on any given body with a surface, there **MUST** be a subsurface. If such bodies are subject to gravitational or tidal effects, tectonic motions, impact from external bodies, vulcanism, or the effects of heat flow from a core, then they will develop cracks. Cracks in rock (and ices) are the foundation for the formation of caves. Because of these circumstances, we believe that the likelihood of subsurface cavities on Mars, the moon, or even icy Europa are quite high (Boston, 2000; Grin et al., 1998, 1999; Walden et al., 1988). Some of these may be accessible to human explorers. Some may be detectable below the surface by geophysical methods and accessible by limited drilling. Even in the absence of natural caves, artificial shafts and cavities could be created in topographic lows to serve some of the same purposes that we suggest below e.g. into the sides of canyons much as Southwestern peoples carved cavelike habitats into rocks and volcanic tuffs (Adler, 1996).

Lack of Current Appropriate Technologies for Use in Caves

The primary impediments to the use and study of caves on various solar system objects is the lack of technological capabilities necessary to make caves a possible component of mission scenarios. These technological deficits include cave location methods, communication, navigation, rapid survey, human mobility in pressurized surface suits, sophisticated and clean drilling technologies, robust yet miniaturized instrumentation for use by human investigators, and long-term remote and in situ unmanned data collection and monitoring. Caving studies on Earth are done with remarkably low-tech equipment. Even though great improvements in vertical ascent gear, lighting and some personal equipment have occurred in the past several decades, caving is still primarily done on shoe-string budgets by a very small minority of people. This is not the type of retail market that promotes the expensive development of specific devices and instrumentation by commercial concerns. However, this lack of technological capability can be addressed now and engineering solutions sought to provide the necessary capability when mission

opportunities arise. Indeed, the very presence of such technologies may stimulate mission designers to seriously consider subsurface mission scenarios.

Cave Habitat Technologies

Two major requirements for use of caves as habitats include 1) ability to seal the entrance with an airlock of some sort, and 2) development of some type of liner to prevent atmospheric escape through cracks or potentially porous parent rock.

A potentially revolutionary idea for cave application is the use of inflatables as chamber liners. The use of inflatables on the surface has been previously suggested as possible habitat and plant growth chambers (e.g. Boston, 1981). These could serve admirably as inflatable cave liners. The beauties of this concept lie in easy deployability, simple repair, and an unparalleled degree of moldability to complex surfaces. In addition, replacement of worn structures would be relatively easy compared to more elaborate repair mechanisms necessary for more permanently attached liners. Drawbacks of inflatables on planetary surfaces, e.g. ultraviolet damage, micrometeorite puncture and thermal instability are not issues in the subsurface. Such shelters could also be used as *temporary* shelters during long-duration subsurface sorties in caves under study (see Nordley, 1994 for a similar suggestion in a science fiction context).

Deployment of a liner into an existing cavity is extremely easy, at least in principle. The simple act of filling an inflatable unit with gas will cause the necessary expansion into the complex three dimensional interior topology of a cave. Envisioning this process seems much simpler than the process of wrestling with an inflatable on the surface, at least in the author's lurid imagination.

Secondary treatments of the liner such as rigidifying foam or coatings that are applied as liquids or gases and then cure to solid form are ways to make the use of cave liners even more practicable. Interior coatings could be chosen to impart numerous different properties to the interior structure, e.g. high reflectivity, fluorescence, antibacterial and antifungal properties, or even dyes or phosphors that indicate such physical parameters as temperature and humidity.

An interesting variation on the inflatable liner theme was put forth by Frederick (1999). When lava tubes form, they sometimes blow out materials from the tops of the tube wall. These holes spatter lava and become little cones (known as *hornitos*) that extend above the level of the rest of the tube. Use of hornitos as natural access points and skylights could be very useful. The author suggests the use of inflatable walls to partition off a section of a lava tube underneath a hornito as habitat (Figure 2). Many lava tubes not possessing hornitos also have skylights. These are usually collapse features that occur long after the tube has cooled either in response to earth movements or because the tube walls may be too thin to withstand the mass load over time. On a planet like Mars with only 0.38g, the longevity of lava structures might be considerably longer than that of Earth tubes. Only future exploration and data analyses of planets in question will provide us with answers to questions of this sort.

Another very important technological innovation that could be applied both to pristine terrestrial caves and extraterrestrial habitat caves is an easily deployable, shape-conforming airlock construction technology. Ideally, astronauts could point their aerosol can of "Airlock-in-a-Drum" at the cave hole and fill in the spaces around a rigidly constructed, conventional airlock door arrangement. Such airlock units could be standardized with the custom fitting provided by the expandable and malleable foam material. Because of the irregular nature of cave interiors, (even relatively "smooth" lava tubes), shape-conformable technologies are the most appropriate. Commercially available foams now exist at any home improvement store for many specific applications including thermal insulation, noise control, fire retardation and prevention of entry by pest species such as mice into buildings. Although more robust material than the commonly used polyurethane will be necessary for extraterrestrial cave applications, the utility of the concept remains the same.

One of the most serious problems for any life support system design is the provision of adequate power. Of course, the availability of natural sunlight on Mars has led to suggestions of transparent surface greenhouse inflatables where the photons are "free" (e.g. Boston, 1981). However, the price to be paid for this "free" energy is high: high ultraviolet radiation, high

ionizing radiation, high susceptibility to mechanical breakage from impacting objects, high degree of heat loss during non-solar hours, and high demands on materials technology to provide stuff that can stand all that abuse. Alas, no materials currently exist that can hope to approach the needs of a surface Martian greenhouse (Charles Sandy, personal communication). Of course, all of the usual suggested alternatives have been considered by numerous people trying to plan for eventual human presence on other bodies. Small nuclear reactors, solar collecting fields, light piping, and others have been suggested. We think that caves might be able to add an additional possibility...that of accessibility to geothermal energy. Areas of heat flow may persist in some places on Mars. It is possible that residual geothermal or fumarolic activity may persist in volcanic areas even though the primary vulcanism may be long past. If so, then tapping into this energy, particularly from a subsurface source may present itself as a valuable opportunity.

Fig. 2. Diagram illustrating the possible use of a naturally occurring volcanic hornito as a skylight and access point into a lava tube. Illustration courtesy of G. Frederick (1999).

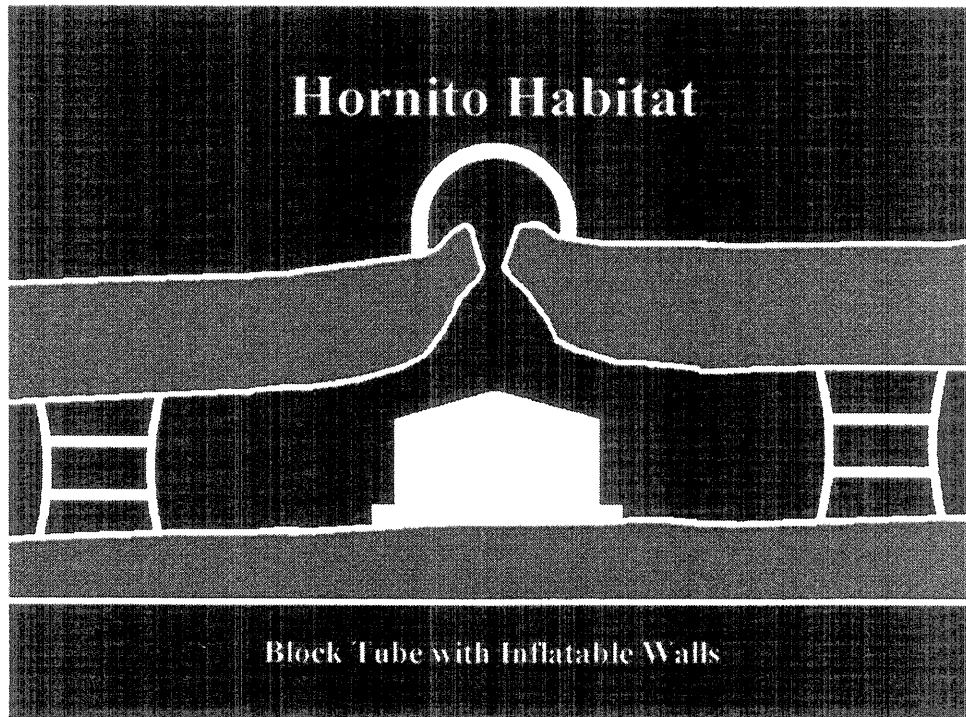

Other Technology Deficits and Solutions for Cave Applications

1. **Prospecting for Subsurface Cavities:** Mapping of features from orbit has been suggested as a first approach to locating lava tube caves on the Moon and Mars (Walden Et al., 1988; Koch, 1996; Taylor and Gibbs, 1998). However, caves associated with non-volcanic processes and features will be difficult or impossible to locate from an orbital platform. Non-invasive methods of exploring the subsurface, e.g. magnetometry, for subsurface water and techniques to locate subsurface cavities (e.g. resistivity, micro-conductivity, ground-penetrating radar, and seismic techniques) will be important for identifying possible subsurface habitats on other planets and for locating caves without natural openings here on Earth. Some or all of these techniques are used in many terrestrial mining applications and could be put to use for subsurface cavity location purposes elsewhere.

2. **Communication (A Reverse War-of-the-Worlds Strategy):** The most difficult current problem in subsurface work is the complete lack of communication both between people in the cave and with the outside. This is a distinct problem on Earth, and will be completely unacceptable for extraterrestrial missions. Possible solutions of a more conventional nature that we have considered include 1) optical fiber deployment 2) ELF (extra low frequency) techniques

similar to those used for submarines, 3) use of caves as microwave guides, and 4) low-frequency acoustical signaling.

However, we prefer a more revolutionary approach using a self-deploying, self-optimizing, cellular network. Specifically, we propose the use of insect robots (currently being developed at places like the MIT Insect Robot Lab and other facilities around the world, e.g. Miura et al., 1997) who will “colonize” a cave and become a *line-of-sight* communication system. Insect robots are capable of remarkably complex joint behavior while the individual units only possess very simple behaviors (Sharkey, 1998). For our purposes, we envision the following steps: 1) units will spread out through the cave, 2) they must stay in touch with a neighbor, 3) they will go to a centralized “feeding station” when “hungry” for power (e.g. radioisotope thermoelectric power stations), 4) they will go to a “bug hospital” when they are sick and need repair or to be removed from service. The beauties of this system include tremendous flexibility both spatially and logistically, a high degree of fault-tolerance, use of cellular technology which is already well in hand, self-deployment, and self-optimizing behavior, and expendability of individual units in a hazardous environment. We view this idea as a War-of-the Worlds strategy in reverse, that is, sending armies of artificial bugs to Mars, not to conquer and destroy but to study and preserve.

3. Rapid Survey Methods and Navigation: Caves are currently mapped using traditional sighting and sketching. It is a very labor-intensive and slow process. We envision our insect robot system as greatly facilitating automatic mapping based on the ability of the robots to perceive their spatial relationships to one another. It should be possible to adapt current 3D laser scanning techniques used for digitizing objects to scan the interiors of caverns and passages to produce highly detailed surveys. Once a cave system has been accurately surveyed, the problem of navigation will be straightforward given the presence of the insect robot communications net.

4. Drilling Technologies: Direct sampling of the deep subsurface environment for scientific purposes is difficult. Most sampling efforts to date have relied on drilling and coring, (Balkwill and Ghiorse, 1985, Beloin et al. 1988, Bone and Balkwill 1988). Such methods have yielded many valuable insights, but they also possess significant drawbacks including possible biological contamination of samples by drilling muds, and exposure of collected material to rapid changes in temperature, pressure, oxygen concentration, light, and moisture. These problems will be further aggravated on planets like Mars where there is little or no atmosphere. Using caves as a deeper access point is very attractive both for science and other purposes. For cave resource extraction, shallower drilling may be all that is needed. Nevertheless, the challenges of planetary protection make any drilling technology problematical. We wish to avoid contamination of the subsurface regions of other planets both for scientific, conservation, and functional reasons. Bacterial contamination of fluids is a major contribution to corrosive processes in industry, mining, and other technologies here on Earth.

We have been impressed with the idea (championed by Geoff Briggs and Rocco Mancinelli at NASA-Ames and Steve Clifford at Lunar and Planetary Institute in Houston, see <http://www.ees4.lanl.gov/mars/mars.html>) to melt a hole into the deep subsurface of Mars, thus forming a re-solidified rock access borehole in its wake. This use of rock-melting temperatures will certainly be adequate to incinerate any contaminating organisms of Earth origin. We believe that applications of this type of technology can be modified for use in drilling into subsurface cavities and drilling from accessible caves into even deeper subsurface regions. In addition to the possibility of lowering instrument packages into the borehole as these investigators have suggested, we are also interested in the extension of our insect robot as sensors and data gatherers that could also be deployed to deep subsurface cavities through such boreholes. The study of both natural caves and direct deep drilling samples are complementary approaches in the search to define subsurface environments.

5. Human Mobility: The very thought of caving in current generation space suits sends shivers through the spines of cavers. Clearly, this is an impossibility. There are several critical needs for suit technology as applied not only to cave work, but also to all rigorous surface activities. First, the need for greater flexibility at joints is critical. The current style of “inflated beach ball” suit gives the wearer all the flexibility and fine control of the Michelin Man icon.

The second major issue is provision of thin, flexible self-healing and thermally-insulating gloves. In caves now, we switch from the heavy gloves that we wear for rappelling, bouldering, and crawling, to surgical gloves (both sterilized and unsterile) for performing scientific, restoration, and conservation work. We envision a similar but more refined “double glove strategy” for cave use.

In any rocky environment with sharp natural objects and equipment parts, the problem of tear-resistance and the necessity for self-healing properties of suit materials is obviously critical. These properties are so essential for the practical use of surface suits on any prolonged human mission to solid bodies that they constitute almost a crisis situation for extraterrestrial exploration.

6. Data Collection and Monitoring: The lack of robust, miniaturized instrumentation for use by human investigators and for long-term, unmanned data collection is an impediment in many environments, but its lack in cave research is a severe drawback. Cave environments on Earth can often be very hard on instrumentation due to high humidity, corrosive gases, and particles of dirt and rock flour. We can only speculate on the chemical properties of hypothetical caves on other bodies, but dirt and abrasive surfaces will certainly be present. In addition, the physical rigors of lugging equipment up and down rock faces and through tiny passages subjects devices to great mechanical stresses. Even on planetary bodies with less than 1g, maneuvering the same mass around is sufficient to do plenty of damage.

While it may be that the lack of research money available for terrestrial cave studies has prohibited the acquisition of suitably robust, environmentally sealed equipment, we do not view that as an insurmountable difficulty. However, the desirability of continuous monitoring by devices unattended by humans over long periods of time is a significant engineering challenge akin to the needs for robust and reliable devices in all of space technology. Here, again, we envision our mobile insect robots as useful for data collecting. These functions could be combined with their communication and mapping duties to produce an integrated and interactive monitoring and communication system throughout a cave. Regular reporting of data through the communication network and transmission to receiving points outside (e.g. a human habitation or an orbiting spacecraft) can ensure that monitoring is proceeding as required. The capability of such a system to sense and replace faulty units will offer a redundancy that no current system of data collection can match.

Conclusions

The use of caves as extraterrestrial habitat is a natural outgrowth of human inventiveness throughout our history. Caves provide many advantages when compared to surface construction including protection and relative ease of construction. Importantly, the access to possibly useful materials through the subsurface access could greatly expand the indigenous “wealth” base of a human facility on another planet.

Useful spin-offs of research into cave use for other planets will include better protection and study methodologies for Earth’s under-appreciated caves, technologies that may have commercial and mining applications (e.g. in-cave communication), and myriad educational and public outreach opportunities.

References

1. Adler, M.A., ed. 1996. *The Prehistoric Pueblo World, A.D. 1150-1350* University of Arizona Press, Tucson, AZ.
2. Arnold, D.E. 1971. Ethnominerology of the Ticul, Yucatan potters: Etics and emics. *Amer. Antiquities* 36:20-40.
3. Arnold, D.E. and Bohor, B.F. 1975. Attapulgitic and maya blue: An ancient mine comes to light. *Archaeology* 28:23-29.
4. Balkwill, D.L. and Ghiorse, W. 1985. Characterization of subsurface bacteria associated with two shallow aquifers in Oklahoma. *Appl. Environ. Microbiol.* 50:580-588.
5. Barr, Nevada. 1998. *Blind Descent*. G.P. Putnam and Sons, NYNY.
6. Beloin, R. M., J. L. Sinclair, and W. C. Ghiorse. 1988. Distribution and activity of microorganisms in subsurface sediments of a pristine study site in Oklahoma. *Microb. Ecol.* 16:85-97.
7. Bone, T. L., and D. L. Balkwill. 1988. Morphological and cultural comparison of microorganisms in surface soil and subsurface sediments at a pristine study site in Oklahoma. *Microb. Ecol.* 16:49-64.
8. Boston, P.J. 1981. Low-pressure greenhouses and plants for a manned research station on Mars. *J. Brit. Interplan. Soc.* 34:189-192. Reprinted in, P.M. Bainum, ed., *Space in the 1980's and Beyond*. Vol. 53, Space and Technology Series. pp. 253-265. Amer. Astronaut. Soc., Washington, D.C.
9. Boston, P.J. 1999. Is It Life Or Is It Memorex? Why Humans Are Essential For Scientific Research On Mars. A theoretical and practical analysis of the risks and benefits of *in situ* human scientists. . In, J.A. Hiscox, Editor. *Life on Mars*. British Interplanetary Society, London, UK. pp. 105-112.
10. Boston, P.J. 2000. Caves on Mars. In preparation for submission to *Icarus*.
11. Boston, P.J., Ivanov, M.V., and McKay, C.P. 1992. On the possibility of chemosynthetic ecosystems in subsurface habitats on Mars. *Icarus* 95:300-308.
12. Carr, M.H. and Wanke, H. 1992. Earth and Mars: Water inventories as clues to accretional histories. *Icarus* 98(1):61-71.
13. Davies, D.W. 1981. The Mars water cycle. *Icarus* 45(2):398-414.
14. Frederick, R.D. 1999. Martian lava tube caves as habitats. Second Annual Mars Society Convention, Boulder, CO, Aug. 12-15, 1999.
15. Grin, E.A., Cabrol, N.A., and McKay, C.P. 1999. The hypothesis of caves on Mars revisited through MGS data; Their potential as targets for the surveyor program. Workshop on Mars 2001: Integrated Science in Preparation for Sample Return and Human Exploration. 2-4 Oct. 1999. Lunar and Planetary Inst., Houston, TX.
16. Grin, E.A., Cabrol, N.A., and McKay, C.P. 1998 Caves in the Martian regolith and their significance for exobiology exploration.. XXIXth Lunar and Planetary Science Conference. Lunar and Planetary Inst., Houston, TX.
17. Hatt, R.T., Fisher, H.I., Langebartel, D.A. and Brainerd, G.W. 1953. Faunal and archaeological researches in Yucatan caves. *Cranbrook Inst. Sci. Bull.* 33:1-119.

18. Hill, Carol and Forti, Paolo. 1997. *Cave Minerals of the World*, Second Edition. National Speleological Society, Huntsville, AL.
19. Horz, F. 1985. Lava tubes: Potential shelters for habitats. In, W. Mendell, ed., *Lunar Bases and Space Activities of the 21st Century*. pp. 405-412. Lunar and Planet. Inst., Houston, TX.
20. Jakosky, B.M., Zent, A.P., and Zurek, R.W. 1997. The Mars water cycle: Determining the role of exchange with the regolith. *Icarus* 130(1):87-95 .
21. Jelinek, J. 1975. *Pictorial Encyclopedia of the Evolution of Man*. Prague, Hamlyn.
22. Johanson, D. and Edey, M. 1974. *Lucy: The Beginnings of Humankind*. New York, Simon and Schuster.
23. Kokh, P. 1996. Searching Mars for lavatubes. *Moon Miners' Manifesto*, #93. Section 6.9.3.2.093, Artemis Data Book
24. Krakauer, Jon. 1995. Descent to Mars. *Air and Space Smithsonian Magazine*, Nov. 1995.
25. Leakey, R. E. and R. Lewin (1977). *Origins*. New York, E. P. Dutton.
26. Leakey, R.E. 1992. *Origins Reconsidered: In Search of What Makes Us Human*. New York, Doubleday.
27. Lourandos, H. 1987. Pleistocene Australia. In, O. Soffer, ed., *The Pleistocene Old World*. Plenum Press, NYNY. Pp. 147-166.
28. McKay, C.P. and Nedell, S.S. 1988. Are there carbonate deposits in the Valles Marineris, Mars? *Icarus* 73(1):142-148.
29. Miura, H., Yasuda, T., and Shimoyama, I. 1997. Insect-model based microrobot. *Robotics and Autonomous Systems* 21(3):317-322.
30. Nedell, S.S., Squyres, S.W., and Andersen, D.W. 1987. Origin and evolution of the layered deposits in the Valles Marineris, Mars. *Icarus* 70(3):409-440.
31. Nordley, G.D. 1994. Into the Miranda Rift. In, Gardner Dozoi, ed. *Year's Best Science Fiction*, 11th Annual Collection, St. Martin's Press, NYNY.
32. Robinson, K.S. 1994. *Green Mars*. Bantam Books, NYNY. 535 pp.
33. Sharkey, N.E. 1998. Learning from innate behaviors: A quantitative evaluation of neural network controllers. *Autonomous Robots* 5(3-4):317-334.
34. Sieveking, A. 1979. *The Cave Artists*. Thames and Hudson, Ltd., London, UK. 221 pp.
35. Tankersley, K.B., Munson, C.A., Munson, P.J., Watson, P.J., Shaffer N.R. and Frushour, S.S. 1997. Archaeology and speleothems. In, C.Hill and P. Forti, eds., *Cave Minerals of the World, Second Edition*. Pp. 266-270. Nat. Speleolog. Soc., Huntsville, AL.
36. Taylor, A.G. and Gibbs, A. 1998. New views of the Moon: Integrated remotely sensed, geophysical, and sample datasets. September 20, 1998 at the Lunar and Planetary Institute in Houston, Texas.
37. Thompson, S.L. and Boston, P.J. 1997. Urine mitigation with concurrent power generation for Lechuguilla Cave. *Carlsbad Caverns National Park*, Carlsbad, New Mexico.
38. Walden, B.E. 1988. Lunar base simulations in lava tubes of the Pacific Northwest. AAAS Pacific Region Meeting, Corvallis, OR. June, 1988.
39. Walden, B.E., Billings, T.L., York, C.L., Gillett, S.L., and Herbert, M.V. 1988. Utility of lava tubes on other worlds. AAAS Pacific Region Meeting, Corvallis, OR. June, 1988.
40. Watson, P.J. 1986. Prehistoric cavers of the eastern woodlands. In, C. Faulkner, ed., *The Prehistoric Native American Art of Mud Glyph Cave*. Pp. 109-116. Univ. Tennessee Press, Knoxville, TN.
41. Werker, J. and Hildreth-Werker, V. 1997. Management Plan For La Cueva De Las Barrancas. United States Department of Agriculture Forest Service, Southwest Region (Region 3), Lincoln National Forest, Guadalupe Ranger District.
42. Wright, R.V. 1971. *The Archaeology of the Gallus Site, Koonalda Cave*. Inst. Aboriginal Stud., Canberra, Australia. 133 pp.
43. Wymer, J. J. 1982. *The Paleolithic Age*. London, Croom Helm.

Challenges for Bioregenerative Life Support on Mars

Frank B. Salisbury
Prof. Emeritus, Utah State University
2250 Bryan Circle
Salt Lake City, UT 84108-2711

One day when we have perfected the means of human travel to Mars, and perfecting such travel is surely the primary challenge for our dreams of manned exploration of that planet, we will want to use green plants to capture sunlight in photosynthesis, purifying the air and providing food for a Mars station or colony. That is, we will want to provide a Bioregenerative Life Support System (BLSS). There are many subchallenges to getting there. Is it worth the effort economically? Just what will we do when we can set up a permanent colony? Assuming that such challenges will be successfully met, we must begin now to devise the technology needed for bioregenerative life support. I see three especially important challenges for a BLSS on Mars: the environment, choosing the plants, and putting it all together. Some aspects of these challenges are common to any BLSS regardless of where it is located; others are more specific to Mars, especially the first one:

Challenge #1: The martian environment

Conditions on Mars are impossibly harsh for humans as well as for all familiar plants. It is an engineering challenge to exclude these conditions from the spaces occupied by humans or plants. Consider the challenges that the engineers will face to make our kind of life possible in those inhabited spaces:

1. Gravity: Gravity is essentially no challenge at all; in fact, the low gravity on Mars simplifies some of the engineering challenges. The pull of gravity on Mars is about $2/5$ of that on earth ($0.38 g_n$), which is about twice that on the Moon and *much* easier to deal with than the microgravity of a free-fall spacecraft. Specifically, Mars's gravity will support convective cooling, draining of fluids (e.g., nutrient solutions through a substrate), easier placement of heavy objects, etc.
2. Topography: The topography of Mars proved to be much more complex than was expected based on telescopic observation from earth, but many planar surfaces are available at all latitudes¹. Most importantly, the topography suggests that Mars once had large quantities of surface water, suggesting that it might be possible to find water now, perhaps as permafrost, especially in the polar regions.
3. Atmosphere: Compared with earth, the atmosphere of Mars is extremely thin. The *Viking* lander reported atmospheric pressure of 0.8 Pa (8 mbar), and the *Pathfinder* reported 0.67 Pa (6.7 mbar). Of course the actual value depends on elevation on the Martian surface, but atmospheric pressure on Mars is less than 0.1 % that of earth. Nevertheless, this is enough to allow parachute landings and to support suitably designed balloons. *Pathfinder* reported a density of ca. 10 g/m^2 near the surface, meaning that it will require a large balloon indeed to carry much of a load.

The big question for discussion at this workshop is whether an inflatable, transparent greenhouse could withstand the pressure differential of pressure inside capable of supporting humans or plants, pushing against the almost zero outside pressure of the Martian atmosphere. If we assume that the human farmers² would require (or desire) about one half of earth's sea-level pressure, the differential would be $5,166 \text{ kg/m}^2$. Can engineers design a transparent, inflatable structure that will withstand such pressure³? There are leaks even in such solid structures as the United States Shuttle or the Russian *Mir*. Will such leaks be even worse for an inflatable greenhouse if such can eventually be built? It seems clear that the low Martian atmospheric pressure will be a serious challenge for the designers of Martian Greenhouses.

There is 25 to 50 times as much carbon dioxide in the Martian atmosphere as in earth's atmosphere, again depending on elevation. (The polar caps are solid CO_2 , dry ice probably with some water ice.) This is a

decided plus for a BLSS on Mars. This means that carbon will not have to be transported from earth, as it apparently will have to be transported to the Moon. On the other hand, there is little nitrogen (2-3 % of the Martian atmosphere), oxygen, or water vapor.

The technology is available to obtain oxygen from silicate rocks, and these are present on Mars. Oxygen can also be obtained from atmospheric CO₂ by both physicochemical and photosynthetic means.

4. Light: Because of Mars's elliptical orbit, irradiance at the Martian surface varies from about 37 to 52 % of the irradiance above Earth's atmosphere. Except for occasional dust storms, the Martian sky is virtually cloud free. Most agriculture areas on Earth are often cloudy so integrated sunlight at the surface of Mars may be more reliable and higher than many productive places on earth. Hence, there should be ample light for efficient photosynthesis which is why it is highly desirable to have greenhouses on Mars.

The Martian day is close to Earth's day: 24.7 h. Hours of sunlight will vary with location (latitude) and season as it does on earth because the Martian equator is tipped 25° to the plane of its orbit, compared with 23.5° for Earth's equator. Thus, plants that are sensitive to day length would respond to the seasons in a Martian greenhouse much as they do on Earth although the seasons on Mars are much longer than on earth; the Martian year is 387 Earth days long. Day length and seasons are much more suitable for crops on Mars than on the Moon, where there are no seasons (equator tipped only 1.5° to the ecliptic) and it is light for half of the Lunar day, which is 29.530589 Earth days long, and dark for the other half (but illuminated at night by a significant earth shine, especially during the full earth; i.e., at the time of the new moon from earth). To summarize, light conditions on Mars are ideal for a BLSS that uses sunlight.

5. Temperature: Along with the thin atmosphere, cold temperatures on Mars pose the most serious engineering challenge for construction of a BLSS inflatable greenhouse. *Pathfinder* reported temperatures of 197 to 263 K (-75 to -10 °C). It is possible that surface temperatures at the equator during Martian summer may reach 20 °C at noon, as estimated from earth-bound telescopes before the space age⁴. Because of the thin Martian atmosphere, there is virtually no atmospheric greenhouse effect as there is on Earth (and to an extreme extent on Venus with its dense atmosphere of CO₂). Hence, radiant cooling is extreme during the night, and at Mars's distance from the sun, insulation during the day is not enough to overcome the night cooling. Conduction/convection from the surface of a greenhouse on Mars to the thin atmosphere would be low, but the surface of the greenhouse would radiate energy to the sky the same as the Martian surface. (Such radiant cooling occurs both day and night, but incoming sunlight more than balances the cooling during the day.) The net loss of heat will have to be made up by energy-requiring heaters inside the greenhouse. Will we ever be able to engineer such an inflatable greenhouse to withstand the pressure differential, insulate sufficiently against heat loss, and at the same time transmit enough light to grow crops in a BLSS? The question is rhetorical. We will have to wait to see.

At least the situation is better than on the Moon, where the lack of atmosphere is combined not only with extreme cold during the long lunar night but extreme heat during the long lunar day. A BLSS on the Moon will almost certainly have to be under ground, supplied with artificial light during lunar night and possibly piped in sunlight during Lunar day. Will we finally decide that such an approach will also have to be taken on Mars?

6. High-Energy Radiation: Plants are sensitive to high-energy photons from cosmic rays to the ultra-violet part of the spectrum, all of which strike the surface of Mars virtually unattenuated. Because of Mars's distance from the sun, high-energy solar storms are somewhat weaker on Mars than on the Moon but much stronger than at the Earth's surface. Cosmic rays strike Mars with almost the same energy as they strike the Moon (slightly less because of the Martian atmosphere). Because there is virtually no ozone in the Martian atmosphere, ultra-violet radiation from the sun penetrates to the Martian surface. These dangers to BLSS crops will require engineering solutions. Because it seems unlikely that the transparent material of an inflatable greenhouse will protect from this radiation, other solutions will have to be found. Protons from solar storms might be the greatest danger to BLSS crops. Could the entire structure be on tracks so that it

could be moved into a hill-side cave during solar storms and perhaps even at night to avoid the cold and the pressure-differential challenge? Or could the greenhouse be built against the side of a hill, with only the plants being wheeled into a cave? Or will a Martian BLSS have to resemble a Lunar BLSS, being underground with light piped in from solar collectors or reflected in through large windows that can be covered during solar storms and at night?

7. Water: We have good reason to believe that water will be available although surely difficult to obtain. There must be water in the polar caps, possibly as permafrost, plus slight amounts in the atmosphere. At least it appears that there will be more available water on Mars than on the Moon.

8. Substrate: The Martian regolith might prove to be suitable, no doubt with some modification, as a substrate for plant growth, but this remains to be determined. Intuitively, it seems like the Martian regolith⁵ might be more easily adapted for plant growth than Lunar regolith, but again this remains to be seen. It seems likely that essential minerals will have to be provided even if the regolith is used. Actually, plants can easily be grown hydroponically (i.e., without a solid substrate), which is probably the preferred approach unless there is some clear advantage to using Martian regolith. In any case, there should be plenty of available iron for plant growth on the rusty Red Planet.

Challenge #2: Choosing plants for the BLSS

The choices of crops for a Martian BLSS will depend on many things and will also determine many things, specifically how the structure is designed and constructed. The first consideration is how much and how often there will be resupply. Compared with the International Space Station or even the Moon, this is where Mars is at a distinct disadvantage. The difficulty of resupply argues for a large BLSS with many crop species, conferring much independence on the Mars colony. But it will also be very costly and difficult to take a large BLSS to Mars. The second consideration is how much the Martian outpost will depend on physicochemical recycling of waste products. Such recycling will surely play an important role, and the extent of it will influence the size and design of the BLSS. The third consideration is the purpose of the BLSS. It is easy to imagine several purposes for a Martian BLSS:

1. To Capture Carbon and Release Oxygen from the Abundant CO₂: If this is a primary purpose of a BLSS on Mars independent of food supply, algal reactors might be used. Research on bioregenerative life support has largely moved away from the use of algae because these organisms cannot easily be used as food. The technology of algal culture was highly developed, however, in Moscow, Krasnoyarsk, Japan, and even in the United States⁶. Luzian Wolf has reviewed some of the earlier work and described results of his more recent studies in a 1997 paper⁷.

2. To Fix Free Nitrogen: Waste processing will convert some fixed nitrogen to the free gaseous form, making it unavailable for ready plant uptake. Such N₂ can be fixed by physicochemical processes or by biological processes. Legumes will be used in a food-producing BLSS, and their substrates will be inoculated with nodule-forming, nitrogen-fixing bacteria. In addition, cultures of cyanobacteria (blue-green algae) can be used for nitrogen fixation⁸.

3. To Provide Variety to a Stored and Resupplied Diet: If the decision is made to depend largely on resupply of food, a small BLSS can nevertheless be used to provide a small selection of such vegetables as lettuce, onions, broccoli, carrots, peas, and tomatoes.

4. To Provide Significant Carbohydrate, Protein, and Fat with Limited Crops: If this is the purpose of a Martian BLSS, it will have to be large enough to grow such crops as wheat, rice, potatoes, sweet potatoes, and chufa nut sedge.

5. To Provide a Complete, Mostly Vegetarian-but-Attractive Diet: A BLSS with this purpose would depend on minimal resupply. Some animal protein might be obtained from animals such as chickens and fish that can be raised on plant waste products that the crew would not eat. Table 1 was developed at a workshop on *Human Nutrition in Controlled Ecological Life-Support Systems*, held at the Johnson Space Center, January 19-21, 1994. The workshop included 26 participants who were professional nutritionists, vegetarians (some also nutritionists), and Advanced Life Support personnel at Johnson Space Center⁹.

Challenge #3: Making it work

There are myriad small and large challenges to putting it all together. Here is a brief list:

1. Determining and then controlling the ideal environment to achieve maximum yields of the crops.
2. Supplying sufficient energy for light, temperature control, and operation of equipment.
3. Maintaining at least a minimal level of stability. The relative stability of earth's ecosystems comes about because of the enormous size of the natural buffers: the atmosphere, the oceans, the lithosphere.
4. Handling waste products, especially the so-called *deadlock substances* that can't be recycled with any kind of practical technology. For example, it may be possible to physicochemically convert the ashes produced by incinerating plant wastes into usable nutrients for plants, but this may require strong acids and equipment that only compounds the problems of designing a workable BLSS.
5. Providing the necessary resupply of materials and equipment that cannot be recycled or repaired.
6. Keeping the equipment functional. Planners must decide on how many spare parts to take along in the initial and resupply voyages. They will also have to plan for some portion of the crews' time in maintenance of equipment.
7. And on and on!

Many of these and other problems have been studied¹⁰. That is, we are not totally lacking in experience. Studies to obtain maximum yields of various crops have been carried out at universities, NASA laboratories, scientific institutes in Russia (and the Soviet Union), Europe, and Japan. Industrial laboratories have participated. There have been some successes, notably with wheat, white and sweet potatoes, lettuce, rice, and soybeans. In our work with wheat, we achieved yields of 60 g/m² d of edible dry wheat, which is about five times the world record yield for wheat. Applying the principles developed in the original study¹¹, Bruce Bugbee and others have duplicated these yields many times.

Table 1. Suggested crops for a bioregenerative life support system

<p>A. Grains</p> <ol style="list-style-type: none"> 1. Wheat* 2. Rice* 3. Oats (difficult to hull) 4. Quinoa (South American grain) 5. Millets 6. Sorghum <p>B. Starchy roots & tubers:</p> <ol style="list-style-type: none"> 1. Sweet potato* 2. White potato 3. Table beet <p>C. Green Vegetables:</p> <ol style="list-style-type: none"> 1. Broccoli* 2. Kale* 3. Swiss chard 4. Snow peas 5. Cabbage 6. Garden peas 7. Lettuce* <p>D. Yellow vegetables:</p> <ol style="list-style-type: none"> 1. Carrots* 2. Butternut squash (seeds) 3. Pumpkin 4. Various squash cultivars. 5. Mushrooms <p>E. Oil seeds (also eaten):</p>	<ol style="list-style-type: none"> 1. Rape seed (canola)* 2. Sunflower 3. Peanut (listed also as legume) 4. Soybean (also as legume) <p>F. Legumes:</p> <ol style="list-style-type: none"> 1. Soybean (also molasses & oil)* 2. Peanut* (listed also as an oil-seed crop) 3. Pinto beans 3. Chickpea* 4. Lentil* 6. Cowpea <p>G. Fruits:</p> <ol style="list-style-type: none"> 1. Strawberries 2. Tomatoes* 3. Melons (e.g., cantaloupe) 4. Tomatillo <p>H. Condiments:</p> <ol style="list-style-type: none"> 1. Onions* 2. Garlic 3. Chilies (spicy pepper)* <ul style="list-style-type: none"> • Others listed: sage, fennel, oregano, ginger, horseradish, thyme, chives, parsley, radish. <p>* All crops in the table were listed by the vegetarians at the workshop; those marked with an asterisk (*) were also listed by the nutritionists</p>
--	---

Studies of waste disposal and recycling have taken two approaches: physicochemical (e.g., wet or dry oxidation) and biological. Both will have a place in any BLSS. Various groups have also studied diets and food production adapted to a BLSS.

There is considerable experience with full-blown closed systems. The system with the most data is the Bios-3 facility in Krasnoyarsk, Siberian Russia¹². The studies began around 1960 with algal cultivators that removed CO₂ and provided oxygen for volunteers who stayed for various periods of time in a living quarters attached. The structure, made of welded plates of stainless steel, is divided into four nearly equal compartments (ca. 7 x 4.5 x 2.5 m), one of which includes laboratory and living quarters for a crew of two or three volunteers. The other three are called *phytotrons*, and they were used for plant culture. (An early version included a large algal cultivator.) A common configuration was to grow wheat, chufa nut sedge (a little known sedge with oil-containing tubers), and a set of vegetable crops. Total growing area is 63 m², which provides ample air-regeneration capacity. Xenon lamps provide irradiances that approximate sunlight in spectrum and intensity. A thermocatalytic filter purifies the air. Three closure experiments were conducted (1972-73, 1976-77, and 1983-84), each lasting four to six months. Each began in winter to exclude plant pathogens. Plants were grown hydroponically and were planted at intervals so that there would be a nearly continuous harvest. Complete stability was not achieved in the Bios experiments although deviations from the norm were relatively minor. Attempts to recycle wastes (e.g., by adding urine to nutrient solutions for the wheat only and by incinerating inedible plant materials) showed the futility of attempting to reach 100 % closure. The investigators developed the concept of *deadlock substances* that either cannot be recycled or that are impractical to recycle.

The Bios-3 crewmembers consumed about 20 % of their calories as meat stored at the beginning of the experiment or passed in through the air locks. The Bios-3 experiments depended to a significant extent on resupply. This can be reduced as crewmembers move in the direction of vegetarianism. To provide the amount of meat that is common in Western diets by growing animals inside the BLSS would greatly increase the size and complexity of the facility. As noted already, it might be possible to include a few fish or chickens to provide animal protein.

A rather large number of researchers supported the Bios-3 experiments including chemists, microbiologists, agronomists, medical personnel, and others. Health of the crew was carefully monitored, as were all aspects of their environment. Many publications, mostly in Russian, describe the experience with the Bios facilities. A book in English is currently in production, authored by Josef I. Gitelson, Genry Lisovesky, and Robert MacElroy¹³.

The designers of the \$150-million Biosphere 2 facility in Oracle, Arizona, often likened it to a BLSS on Mars or the Moon, but with its seven so-called biomes (ocean, fresh and salt marshes, tropical rain forest, savanna, desert, intensive agriculture, and human habitat), stocked with 3800 species of plants and animals, it was much more an experiment in ecology than an attempt to develop a BLSS for space travelers. Nevertheless, there are lessons to be learned from the Biosphere 2 experience¹⁴. For one thing, in spite of the huge number of species, stability was significantly lower than in the Bios-3 experiments. Much technology and much energy (electricity and natural gas) were expended to attempt to maintain stability, but the complexity of the facility seemed to lead to *less* rather than *more* stability. Oxygen dropped during the first two-year study (which included eight crewmembers, four men and four women) to dangerous levels, apparently because CO₂ (produced by decay of excessive organic matter) reacted with the concrete, taking oxygen with it. Nitrous oxides also increased during the two-year closure although they did not reach dangerous levels. There was the expected inverse relationship between light and CO₂; low light during the two winters led to increased CO₂. It became necessary to remove excess CO₂ with scrubbers. Because of the low photosynthetic rates during the two winters, the crew members depended on about 20 % of stored food (resupply) but nevertheless lost much weight until they finally stabilized. After the first trial, artificial lights were installed above the crop areas, and photosynthesis increased enough so that sufficient food calories could have been provided for the eight-crew members. The size of the structure allowed for biological waste management rather than incineration or some other physicochemical means of recycling. Wastes were essentially composted, allowing for natural decay, which was very successful.

Experience with full-scale BLSS facilities will increase considerably over the next few years as such facilities, currently being developed in Japan, Spain, and the Johnson Space Center, become highly functional. Results are already available from some of these installations but will not be reviewed here.

Some Conclusions

The experience briefly summarized above has produced some important conclusions about artificial closed systems. Consider the following, which were modified from an earlier publication⁹:

1. Over relatively short times with the use of advanced technological control of the environment and an outside energy source, it is possible to enclose in a relatively small volume a functional ecosystem that accommodates humans who are dependent on green plants for recycling of the air and for (at least some) food production. The Bios-3, Biosphere 2, and other experiments demonstrate this.
2. A BLSS will require a high input of energy, both to provide light for photosynthesis and to carry out environmental control. This is especially true if artificial light must be provided for the plants, but it was true even for Biosphere 2, where sunlight was used.
3. The challenge of creating and operating a BLSS is that its size leads to a highly limited capacity to buffer against the changes in the environment that occur as crops are grown and as humans interact with the system. Complexity of an ecosystem is no guarantee of ecological balance and stability, even if it is relatively large. This was clear from the Biosphere 2 experience. In a BLSS of conceivable size on Mars (or anywhere), buffering will have to be achieved technologically. Bios-3 came closer to reaching this goal than Biosphere 2 although Biosphere 2 had extensive controls.
4. The time that such a BLSS can be maintained (its potential life even in semi-closed mode) is highly dependent upon the efficiency of waste management. Without resupply and removal of wastes, accumulation of deadlock substances will eventually limit the life of a BLSS.
5. Resupply of critical components will prolong the life of the BLSS. It seems clear that a practical BLSS will not achieve 100 % closure with respect to matter but will depend on some resupply and waste removal.
6. Biological recycling of organic wastes, as in Biosphere 2, is most efficient (i.e., produces products that can be used directly by plants). It is, however, slow, requires relatively large mass and volume, and may harbor plant and animal pathogens. Technological recycling (e.g., incineration, which worked well in Bios-3) will be needed.
7. In a BLSS, it is not the plants that are the weakest link; rather, it is the mechanical equipment that is most likely to break down. Plants can regenerate (reproduce) themselves after a crop failure, but machinery has no such ability; broken machinery must usually be repaired by living organisms: the crewmembers.
8. It is clear that inclusion of animals in a BLSS will greatly increase its complexity and size. The more vegetarian the diet, the simpler and smaller the BLSS although it might be possible, even in a relatively simple system, to include a few fish and perhaps other animals that feed mostly on food that humans cannot consume.
9. The success of a BLSS will be found in the details, and often those details are not evident until experimentation is carried out. In our Mir experiments, in which we attempted to grow Super Dwarf wheat through a complete life cycle, the importance of Balkanine particle size (charged zeolite substrate) was learned only by microgravity experimentation. Furthermore, ethylene in the cabin atmosphere first made our plants sterile (no seeds) we learned only after failures were experienced in space experiments¹⁵. (Two

generations of seeds have now been obtained in microgravity by using a wheat cultivar, Apogee, that is more resistant to ethylene.) Another example is the importance of balancing the respiratory quotients of the crew with the assimilatory quotients of the various crops, which is not always easy! Such details might be known but are often easy to overlook (as we did with the ethylene).

Notes:

1. Two recent sources provide information about the topography of Mars: *Science* Vol. 278:1734-1774 (Dec 7, 1997) includes several excellent articles on the findings of *Pathfinder*; and *Science* Vol. 279:1671-1697 (Mar. 13, 1998) includes articles on *Mars Global Surveyor*.
2. During the 1960s and 1970s, Sanford Siegel at the Union Carbide and Carbon Laboratories in White Plains, New York, and later at the University of Hawaii in Honolulu, grew plants in jars at greatly reduced pressures and freezing temperatures. I have been unable to locate reports of this work, but my memory is that the low pressures and especially low oxygen partial pressures conferred frost resistance on the plants. Because plants can grow at pressures much below those suitable for humans, robotic production of the crops might reduce the necessary greenhouse pressure, but such an approach brings up the problems of designing the robots and transporting them to Mars.
3. I expected the engineers attending this workshop to convince me that such a structure was possible, but they instead convinced me that *current* technology could not produce such a structure.
4. What was known about the Martian environment before the space age is summarized in: Frank B. Salisbury. 1962. Martian biology. *Science* Vol. 136:17-26.
5. Soil scientists define a *soil* as a plant substrate that *contains organic matter*. Thus, we should speak of Martian *regolith* and not refer to it as *soil*.
6. See publications of Jack Meyers, Robert Kraus, Maurice Averner, Calvin H. Ward, and others. Some of their publications are cited in Luzian Wolf's review, which is referenced in the next note.
7. Luzian Wolf, Bioregeneration with maltose excreting *Chlorella*: System concept, technological development, and experiments. In: *Advances in Space Biology and Medicine* (S. L. Bonting, Ed.), pp. 255-274, JAI Press Inc., Greenwich, CT, 1997.
8. Lester Packer at the University of California, Berkeley, has developed techniques for culture of cyanobacteria, some of which are edible.
9. Frank B. Salisbury and Mary Ann Clark. 1996. Choosing plants to be grown in a controlled environment life-support system (CELSS) based upon attractive vegetarian diets. *Life Support and Biosphere Science*, Vol. 2:169-179.
10. F. B. Salisbury. 1999. Growing crops for space explorers on the Moon, Mars, or in space. *Advances in Space Biology and Medicine*, Vol. 7:131-162.
11. Bruce G. Bugbee and Frank B. Salisbury. 1988. Exploring the limits of crop productivity. I. Photosynthetic efficiency of wheat in high irradiance environments. *Plant Physiology*, Vol. 88:869-878.
12. F. B. Salisbury, J. I. Gitelson, and G. M. Lisovsky. 1997. Bios-3: Siberian experiments in bioregenerative life-support. *BioScience*, Vol. 47:575-585.
13. Josef I. Gitelson, Genry Lisovsky, and Robert MacElroy. *Man-Made Closed Ecological Systems*. In

press at OPA Overseas Publishing Associates (UK) Ltd, Reading, United Kingdom.

14. John Allen. 1997. Biospheric theory and report on overall Biosphere-2 design and performance. *Life Support and Biosphere Science*, Vol. 4:95-108.
15. Frank B. Salisbury. 1997. Growing Super-Dwarf wheat in microgravity on space station Mir. *Life Support and Biosphere Science*, Vol. 4:155-166.

Cost Effectiveness Issues Mars Inflatable Greenhouse Workshop

Alan Drysdale
Boeing
P O Box 21233,
Kennedy Space Center, FL

Cost Effectiveness on Mars

Cost effectiveness is an important measure of the value of using a greenhouse to grow plants on Mars. A plant growth facility will be cost effective when the cost to grow plants on site is less than the cost of shipping them. The cost of growing plants would include fixed costs such as the equipment required, and time-dependent costs such as the cost of power for plant lighting. It would also include crew time costs. The cost of shipping foods that are not locally grown would include packaging and other transport costs for the state the food is shipped in. (Thus, dehydrated foods would cost less to ship per crew person day than hydrated foods.)

Not all plant products are equally valuable. Locally produced foods that are highly palatable and high in effect on the crew's quality of life are highest priority. However, these may also be consumed in smaller quantities.. The priority would probably be:

- fresh perishable foods e.g. salad vegetables and fruits (smallest quantity)
- high productivity foods (largest quantity)
- foods providing nutrients short in the diet e.g. lipids, calcium, B12 with a vegan diet
- other foods.

The shipping penalty for foods shipped to Mars may be as much as one kg per kg required on-site (i.e. two kg is shipped for every kg of food required on site.) This penalty would include packaging, but also refrigeration and the secondary structure required to transmit the loads from the payload to the vehicle.

Most of the data in this document is defined in or derived from Drysdale and Hanford, 1999, the Baseline Values and Assumptions Document.

Cost Functions

Actual cost is difficult to identify early in a program, and is driven heavily by the mass that must be launched. Thus, cost is estimated here as equivalent system mass (ESM), the sum of true masses and mass penalties associated with a mission. The various components of ESM are discussed below.

Mass

Mass includes initial items: equipment, consumables, fluids, and propagules. The cost impact includes the actual mass required plus mass impacts of packaging and stowage as required. A typical mass factor is 2 x required mass.

Volume

The volume component is the pressurized volume required to accommodate machines, plants, and people. Crew access may be a significant factor if it is required routinely, but may be much less significant if automation is maximized. Typical equivalencies for different

construction technologies are shown in Table 1. An unprotected inflatable could be considerably lighter than shown if the pressure across the fabric is low enough. It could be transparent for use of sunlight, but high transmittances are unlikely to be achieved with materials that must be strong enough to hold a pressure and resist UV light for many years.

Habitat	Description	Volume Equivalency (m ³ /kg)
ISS module	Rigid aluminum chamber	0.015
Transhab module	Inflatable kevlar/ceramic fabric chamber, rigid composite core	0.48
Unprotected inflatable	Similar materials to Transhab but without meteoroid protection.	> 1

Table 1. Typical Volume Equivalencies

Power

Power is required for various functions, including lighting, fans, compressors, pumps, monitors, and physical automation. The time-phasing of demand will vary with the function and the crop plant. For example, wheat can usefully be illuminated for 24 hrs a day, while soybeans require from 10 to 12 hrs a day and will not produce a crop if the day is too long.

Power equivalency varies according to the power generation and storage systems used and the environment assumed. Typical equivalencies for the surface of Mars are shown in Table 2. Solar power is generally cheap, simple, and reliable when it can be used, but is only available during the day. During the night, any power that is required must be stored and energy storage is costly. Furthermore, Mars is noted for having dust storms that can last from days to months. During the longer storms, power storage on any significant scale would be prohibitively costly. Some light does reach the surface, but ten times the collector area would be needed [Cataldo, 1998], and would need to be kept clear of dust.

Technology	Equivalency (kW/kg)	Size
Solar photovoltaic – no dust	0.011	not sensitive
Solar photovoltaic – dust storm	0.002	not sensitive
Nuclear – small system	0.011	100 kWe
Nuclear – large system	0.33	500 kWe

Table 2. Power System Equivalencies

The equivalency of solar photovoltaic (SPV) power is typically about 0.011 kW/kg, without significant storage. Much lower equivalency (higher cost) must be used in calculations if solar power is to be available for use during a dust storm, perhaps as low as 0.002 W/kg. There is considerable uncertainty over the effects of dust deposition during normal weather or a dust storm, and this is not included in this calculation but could easily double the cost.

Nuclear power is typically also about 0.011 kW/kg on a 100 kWe scale. However, this would be unaffected by darkness. A much lower cost would result if the demand is large, about 0.033 kW/kg on the half megawatt scale required for electrical lighting of a plant system sized to provide substantial food closure. Night-time power would not be a concern, and might be marginally cheaper, as the ease of heat rejection would be greater. Dust would still be a concern as heat must be rejected from the reactor, but the area involved is smaller than the area of SPV

arrays. Heat rejection for the power generation system is included in the cost of power generation.

Cooling

Heat rejection must be provided for power consumed, heat generated chemically within the habitat, and heat gained from the environment (e.g. sunlight). For the surface of Mars, the equivalency for heat rejection is typically 0.015 kW/kg, though it does depend on the latitude, time of day, distance from the Sun, and the weather. As mentioned above, there is uncertainty over the effect of dust deposition, and this could affect heat rejection equivalencies. Mars Pathfinder measured dust deposition rates of 3% per day over many days. However, the other two vehicles that were on Mars for some time (Viking 1 and 2) did not get covered with dust, so the rate is probably quite variable from place to place and time to time.

Crew Time

Crew time is needed for life support system O&M, including operations involving plants and machinery. Crew time would be needed for equipment setup, planting, daily care, and harvesting. Estimates based on the KSC biomass production chamber (BPC) show that O&M could be as high as 26 crewperson hours per m² of crops per year. However, the BPC was not designed to minimize crew time, and the estimate does include significant research tasks. Some of these tasks would not need to be performed on Mars, and should in any case should not be charged against life support. Crew time for setup could be quite large if extensive outfitting is required.

The effect of crew time requirements on ESM is calculated by multiplying the ESM without crew time by $(1 + \text{life support crew time} / \text{available crew time})$.

Logistics

Support is needed for operation of any system, including spares and consumables. Time dependent mass and, in some cases, volume, can be significant over a number of years. Maintenance manpower has been included in crew time. Spares are not well defined for bioregenerative systems at present, but might include items like replacement lamps, ballasts, pumps, fans, and sensors. Consumables would include nutrient and reagents. Items like seed supports might be shipped or locally produced.

Propagules might need to be shipped from Earth or they might be produced locally. Propagules might need to be supplied from Earth where genetic techniques are used to produce the propagule, as for hybrid corn, or because of the risk of genetic change due to radiation. The decision could depend on the mass involved. Thus, wheat seeds are planted densely, and could be a significant logistics load, while lettuce seeds are much smaller and are planted further apart. Some crops, such as potatoes, might be propagated by tissue culture. In this case, the costs of tissue culture would have to be considered. Pathogens are considered on Earth when selecting propagation methods, whether eelworms for potatoes or viruses for many plants. This should be a much less significant issue in space.

Effectiveness

A number of measures of effectiveness could be proposed for a bioregenerative system. Some are identified below.

Food

Food production is a major reason for considering bioregeneration. Without producing food locally, no life support system can be considered self sustaining (one of the goals of the HEDS program). Food production can be characterized by the edible biomass produced, and this

metric is simple to use and measure. The world record for biomass production rate is about 60 - 80 g edw/m²/d (wheat). This level of productivity does require high light levels and accurate control of the environment.

Other measures are also meaningful, including fresh weight for some crops and nutritional value. Relevant parameters are caloric value, nutrients, and psychological value (particularly for fresh food).

The record production rate is close to the maximum theoretically achievable with wheat, in which case the focus needs to be on reducing production costs, though even with wheat, there would be opportunities for increasing harvest index. Other plants have not yet achieved the same production rates, and there are significant opportunities for improvement in production of these crops.

Water

Water is also a useful product of plant growth, inevitably provided as food closure becomes significant. However, PC approaches to water regeneration do seem more cost effective than bioregeneration unless major cost reductions are attainable for bioregeneration.

Transpiration rates in the BPC are typically about 4 kg/m²/d. Thus, there would probably be an excess of water produced with a system providing significant food closure. KSC data suggests there could be as much as a factor of 26 between food and water closure. (100% water closure with as little as 4% food closure.)

Air Regeneration

Plant growth also regenerates the air - removing CO₂ and releasing O₂. The amounts of CO₂ and oxygen involved (assimilatory quotient - AQ) vary according to the plant tissue being produced. Thus, if lipids are being produced (such as with peanuts or soybeans), more oxygen would be released than if carbohydrates are being produced (such as with potatoes).

The demand by the crew also varies according the amount of physical work they perform. The crew's respiratory quotient (RQ) with typical amounts of dietary fat is about 0.87, so equimolar amounts of CO₂ and O₂ are not required.

Gas exchange occurs whether plants are producing food or inedible biomass. A ballpark figure would be 100% air closure with 50% food closure and 50% harvest index. However, this picture is complicated by food loss (processing loss and table wastage) and by the RQ vs the AQ.

Other Benefits

There are other benefits of bioregeneration. For example, plants can also dispose of human wastes. Removal of CO₂ and waste water are mentioned above. In addition, plants require minerals, many of which are present in crew waste.

In the event of a contingency, a bioregenerative system can be quite robust as plants do grow and reproduce. Thus, if a part of a crop is lost, the plants will tend to fill in the canopy. If a crop is lost, additional plants can be started to replace the crop, provided sufficient contingency supplies are available for the crew to wait for this.

Additionally, there are hard-to-quantify benefits of plant growth in at least some situations. Most people like to see plants growing. Crews on long duration space flights have commented that they miss growing plants, and that the environment becomes too constant day after day. These benefits would be minimal if the plants are grown in a chamber that is not readily accessible by the crew, whether because of the layout or the air pressure and composition. These hard-to-quantitative benefits are not considered further in this paper.

Baseline

For estimating the ESM of a typical plant chamber, the BIO-Plex plant chamber design was used, based on Barta et al, 1997. This concept uses an ISS-like hard module, similar in size to the ISS common module, but 40 feet long. This design is considered to be close to the best currently achievable, though that remains to be proven as no plants have yet been grown in the chamber to validate performance.

The ESM was estimated by calculating the mass, volume, power, heat rejection, crew time, and logistics requirements for the entire chamber and divided by the crop area. On a square meter basis, the ESM was estimated as being approximately 277 kg + 53 kg/y. (I.e. the initial ESM was 277 kg / m² and every year of operation increased the ESM by 53 kg / m².)

The design used for this estimate was modified somewhat from the BIO-Plex design. An inflatable (Transhab) module is assumed. A flight-like design and design for a Mars-like environment are assumed for secondary structure, both of which would reduce the ESM somewhat. The flight-like design is assumed to be about 70% less massive than the existing design. Operating in the lower gravity of Mars is assumed to reduce the structural loads, and hence the mass of structural members. Although the gravity on Mars is 0.38g, only a 50% mass savings is assumed to be conservative.

Electrical lighting is assumed to be needed, in view of the uncertainty of daylight on Mars. This would also allow plant illumination for up to 24 hours 40 minutes a day, for those plants that are daylight neutral and which can therefore take advantage of it.

80% plant nutrient recycling is assumed. This is considered reasonable in view of the 85% recycling achieved with the KSC BPC.

A 5 mm nutrient solution depth is assumed. This is a tenth of what is used in the BPC, but there are a variety of reasons for thinking that a shallower system could be used without affecting productivity. Shallow nutrient film technique (NFT) is used at various other sites, such as Cornell University. Nutrient solution channeling and deoxygenation have been observed at KSC. Furthermore, fill and drain approaches have been used commercially and in BIOS 3. These allow the roots to remain wetted, well rinsed, and oxygenated. Minimizing nutrient system depth would be less critical if local (ISRU) water is available at low cost.

A sea-level, one atmosphere, air pressure is assumed. This is consistent with most plant growth work, though some work has been done, for example at Logan Utah, at lower pressures, in the variable pressure growth chamber at JSC and in the bullet chamber at ARC.

Reductions in Costs

This design would not be cost effective for operational use without very long duration (~15 year) missions. However, there is the potential for significant reductions in costs. The ESM could be greatly reduced in by the factors identified in Table 3, making bioregeneration attractive for shorter missions.

- Using lightest inflatable membrane considered reliable
- Reduced pressure
- Reduces mass of pressure envelope and leakage mass
- May increase crew time costs
- Reduced lighting costs
- Improving lighting efficiency
- Use of natural sunlight
- Reductions in crew time requirements (mechanization)

- In-situ resource utilization (ISRU)
- Water and gases
- Regolith and mineral deposits

Table 3. Potential Reductions in Cost

The use of an inflatable habitat seems to be well-accepted currently and can reduce volume cost by at least one to two orders of magnitude. These numbers are based on Transhab data. However, the Transhab design includes meteoroid protection that would not be needed on the surface of Mars.

Lower pressures would also reduce volume equivalency. Reduced air pressure would allow the envelope to be thinner and lighter. It would also have an affect on plant growth, but we do not know what the affect would be. Preliminary indications are that a moderate reduction in pressure would do no harm, and might actually increase plant production. Reduction in pressure below where the crew could perform O&M in the plant chamber in short sleeves would result in a crew time cost increase. The increase might be minor, if they merely had to wear masks or if extensive automation was used.

Lighting is one of the major cost factors with the baseline design. Improvements in efficiency are achievable by improving luminaire and lamp design, using inherently more efficient lamp types, and designing the chamber to minimize losses between the lamp and the plant canopy.

Natural lighting is an attractive option used widely in terrestrial agriculture. However, it is more problematical on Mars. Because Mars is further than the Earth from the Sun, the intensity is lower. Problems with dust are likely. Dust storms reduce the available light by one to two orders of magnitude (though less than the optical density might lead one to conclude). Furthermore, the structure of the plant chamber is likely to reduce the available light significantly. Terrestrial greenhouses commonly lose 50% of the light due to reflection, obstructing structures, and dirt. A Martian greenhouse would be expected to lose even more light, as significant pressure differentials would also need to be contained.

The crew time estimates given should be regarded as an upper bound, and operational time requirements should be lower. Terrestrial agriculture commonly works at much lower crew time rates than this, but a Martian greenhouse would probably be significantly more complex also. Some degree of physical automation would most probably reduce crew time requirements significantly, despite the additional tasks involved in automation system O&M. However, design of automation systems can be costly, and automation should be justified by trading off reduction in crew time vs automation costs. A low level of automation (mechanization) seems to work best on Earth in view of the wide range of tasks and task elements that need to be performed to grow a crop.

ISRU would be synergistic with both PC and bioregenerative systems. Water and air for a plant growth module could be acquired from Mars.

Air for a plant chamber could be acquired from the Martian atmosphere. Ample carbon dioxide is available for a remote (crew-less) startup, some oxygen is available also, or it can be manufactured from the carbon dioxide, and nitrogen and argon could be used for inert gas.

However, the distribution of water on Mars is undetermined. Water is ubiquitous in the air, just as on Earth, but the concentration is low, perhaps too low for extraction to be economically attractive. It is believed to be common in subsurface permafrost from 40 degrees of the equator to the poles, but this is unproven. It is present at the poles, but this would unduly restrict location of surface activities. Minerals required by the plants are likely to be present in the regolith. However, whether this is a useable and cost effective source would depend on the concentrations and forms the minerals are in.

Estimates can be made of each of these methods for reducing cost, but good data is not available at this time. The best estimate we have would reduce the ESM to about 73 kg + 9.8 kg/y. This is significantly improved from the baseline, and would imply a great reduction in bioregenerative system ESM and an earlier cost crossover compared to non-bioregenerative options. However, significant R&D would be needed to make these lower estimates a realistic possibility.

Potential for Increases in Plant Productivity

Options expected to increase plant productivity on a per-chamber basis are shown in Table 4.

- Improved plant chamber designs
- Improved light distribution across and within the canopy
- Improved crop varieties:
- Higher HI (shorter stems, fewer roots)
- Better nutritional qualities
- Reduced environmental sensitivity
- Less processing e.g. removal of anti-nutritional factors
- Reduced pressure may improve productivity

Table 4. Potential Increases in Plant Productivity

Chamber design improvements might include axial rather than transverse air flow. This would improve gas exchange and thus allow lower air flow rates, which would reduce the energy requirement. The savings could be significant as fan power is typically 10 – 20 % of the lighting power in a well-designed system.

Light distribution depends largely on the luminaire and chamber design. Uniform distribution is difficult to achieve within a confined space. However, if the optimum level of lighting is used, and the lighting is not uniform, some parts of the chamber will be at sub-optimum light levels, and others at supra-optimum levels. This may be less significant when the plants are being operated at close to optimum levels, as the change of productivity with illuminance is lower near the optimum, but it could still be a factor.

Improved crop varieties could be useful in a variety of ways. A higher HI due to shorter stems and fewer roots is likely to increase productivity. This has been seen in the development of USU wheat varieties, for example. However, if these trends are taken too far, they will become counter productive.

Better nutritional qualities would allow us to reduce the variety of crops that must be grown to provide an adequate diet, while reducing the sensitivity to the particular diet used. While dietary variety would be expected to improve crew acceptance, being constrained excessively to requiring variety is not good for contingency situations.

As plants are pushed harder and harder, they become more sensitive to the environment. Thus, if the environment is slightly suboptimal, productivity will fall. Reduced environmental sensitivity would allow us to increase control setpoints without impacting production, as well as reducing the impact of environmental anomalies.

Most crops require some food processing, even if it is only removal of roots as for lettuce. Other crops require extensive processing, such as soybean. Some crops such as cassava require extensive processing to remove toxins. Many others have antinutritional factors that are removed by suitable processing such as cooking. If less processing is required for removal of antinutritional factors, for example, development of varieties without these factors would increase flexibility in use of crops and increase contingency options.

Issues

A number of issues exist about which we have insufficient data. In some cases, basic research is needed. In other cases, applied research is needed to determine engineering data. Issues that are likely to need additional work are shown in Table 5.

- Productivity of selected plants in a flight-like (minimum mass) system
 - Air pressure - little data at the preferred pressure (70 kPa, norm-oxic)
 - Effect of design compromises in plant environment
 - Closure (build up of trace gas contaminants)
 - Unknowns in plant responses to novel conditions
- Radiation protection
- Unknowns on Mars
 - Environmental conditions vs. time:
 - Light intensity, color, and directionality
 - Affects of trace quantities of dust
 - Affects of using regolith as growth medium
- Availability and cost of ISRU
 - Cost of Mars-derived atmospheres and water vs. productivity
 - availability and cost of extraction of plant minerals
- Operational planning:
 - Crop-related scheduling
- Mechanization / physical automation
 - Interfaces with crew systems: crew access to low-pressure systems
- Unique aspects of operation on Mars:
- Heat rejection could be more significant impact than provision of power, particularly with use of sunlight
-

Table 5. Plant Production Issues

Productivity of plants has traditionally been measured in the field, in greenhouses, or in growth chambers. Typically, one intent has been to establish maximal growth rates without regard to operational-scale production costs. In an operational system for use in space, any plant growth will occur in a constrained system. Mass and energy will be strictly limited. Thus, plant growth for the ALS program should be measured in a flight-like system, maximizing production (edible biomass) per unit ESM. The estimation of ESM will depend on the mission and mission assumptions. However, there is no point in assessing how well we can grow plants on Mars if it is cheaper to ship food supplied from Earth. Only where food is impossible to ship in the desired state or is more costly to ship it is bioregeneration likely to be justifiable to mission management.

Closure (build up of trace gas contaminants) is known to have a generally detrimental effect through ethylene and perhaps other trace gases at very low levels (below 100 ppm in the case of ethylene). These gases can be scrubbed, some quite readily. However, due to the low partial pressures that have biological effects on plants, effective scrubbing can be difficult.

While we try to design plant chambers that will provide known and acceptable conditions, the results in space experiments, such as on the Shuttle and on Mir, have been less than uniformly successful. Some of the problems were obvious in retrospect, and often due to

poor communication between different scientific and technical disciplines. Others are less obvious.

Plants are generally less sensitive than people to ionizing radiation. Radiation protection is generally accepted to be required for people during transit. Two forms are generally discussed. The first is to reduce exposure time. Thus, a rapid transit for the crew is desired particularly to minimize the exposure to energetic (high z) particles. These are difficult to shield against and are always present at predictable levels. The second is to provide low atomic weight shielding such as water. This is primarily needed for protection against solar particle events (SPEs). Large SPEs are rare, but would be lethal without shielding.

Neither of these sources of radiation are as much of a concern on the surface of Mars as they are during transit. The bulk of the planet reduces the incidence by 50%. Siting of a base next to a sheer cliff, while perhaps exposing it to falling rocks and restricting site choices, would reduce the incidence by another 50%. The atmosphere provides only 1% of the shielding that Earth's atmosphere provides, about 6 g/cm^2 . The vehicle would also provide some shielding.

Additional shielding might still be needed during large SPEs. Transhab shielding against SPEs was initially estimated at about 19 cm of water. Later work reduced this to about 6 cm (6 g/cm^2), which would argue that the Martian atmosphere would be adequate. The surface segment duration would be longer, but, as a first approximation, it is peak loads rather than average that determine radiation shielding requirements from SPEs.

Plants are generally more resistant to the effects of radiation, and we are more willing to risk plants being killed. Thus, onion would die at radiation exposures that would be about 60 times what would be required for observable effects on people. Kidney beans are about 25 times less sensitive than onions [Schwartzkopf, 1990]. In consequence, we almost certainly can ignore the acute effects of ionizing radiation on crop plants on Mars. Genetic effects could still be a concern.

Unknowns on Mars

Many things of relevance to bioregeneration are presently unknown about Mars. We know the general environment, but not all of the conditions that are relevant to plants. To predict plant growth using natural conditions, we would need to know, as a minimum, the light intensity, color, and directionality over time.

Dust is ubiquitous on Mars. We need to know the affects of trace quantities of Martian dust on growing plants. We expect that the effects would be minimal, as the dust is probably mostly sand with high rust content. However, it would be foolish to depend on plants for life support on Mars before we have established beyond any doubt that plants can flourish there.

Regolith has been proposed as being usable as a growth medium for crop plants. Most regolith seems to be a fine dust, which would not be very suitable, but larger particle regolith can probably be found. Whether even this will support rapid plant growth would depend on the physical and chemical structure of the regolith used, what treatment was used, if any, to prepare it for use, and the economics of the operation. On Earth, gravel is commonly used as a substrate for hydroponics. But it can also become a holding medium for plant diseases, and is often used for a time then discarded and fresh gravel used. Alternatively, it can be sterilized with steam or chemicals. In any of these cases, there would be significant costs associated with regolith use.

ISRU may make resources like air and water more readily available on Mars than if we had to take everything with us. ISRU could provide water, gases, and minerals for plant growth on Mars. However, the availability, suitability, and cost of ISRU products must be determined before we can decide if it is cost effective to use this approach. With Mars-derived atmospheres, plant minerals, and water, the composition and quality affect both cost and plant productivity.

Concept

A concept for a Mars greenhouse is presented in Figure 1 for future discussion. The concept assumes that a hemispherical membrane is used, held to this shape by hold-downs driven into the substratum. The membrane is assumed to have an overall transmission of 20%, including the effects of dust, varying light incidence, any structure, supplementary lighting, and other obstructions. A thermal blanket is assumed to be drawn over the structure at night, but otherwise, the structure is assumed to be close to thermal equilibrium.

The average lighting on Mar is about 21 mol/m²/day (Gertner, 1999). This would correspond to 500 μmol/m²/d. 50% of this, to allow for envelope transmission losses, is 250 μmol/m²/d. This is low, but might be adequate for broad-leaved plants, particularly in the southern summer, when days are longer. Mars is closer to the Sun during the southern summer, and the levels would be somewhat higher. Supplementary lighting is assumed to be provided for plants requiring more light, during the night (for day-neutral plants), and during short lived dust storms.

Air circulation and dehumidification would probably be required, though in a large unit thermally driven convection currents and condensation on the envelope might be adequate.

The air is assumed to have a total pressure of 70 kPa, with about 50 kPa of nitrogen/argon mixture, 21 kPa oxygen, and 0.12 kPa CO₂, derived from the Martian atmosphere and maintained by crew respiration and plant photosynthesis.

The plants are assumed to be grown in coarse regolith and compost, steam sterilized between crops, and irrigated by a nutrient solution balanced to minimize the need for pH control. This solution would be irrigated through the gravel at intervals, and pumped out to the storage tank by a recirculating pump. Inedible biomass would be composted and mixed back into the gravel. Additional nutrients would be added to the storage tank. Condensate from the air would be collected and provided to the crew for use. Crew waste water and excess condensate would be added back to the storage tank.

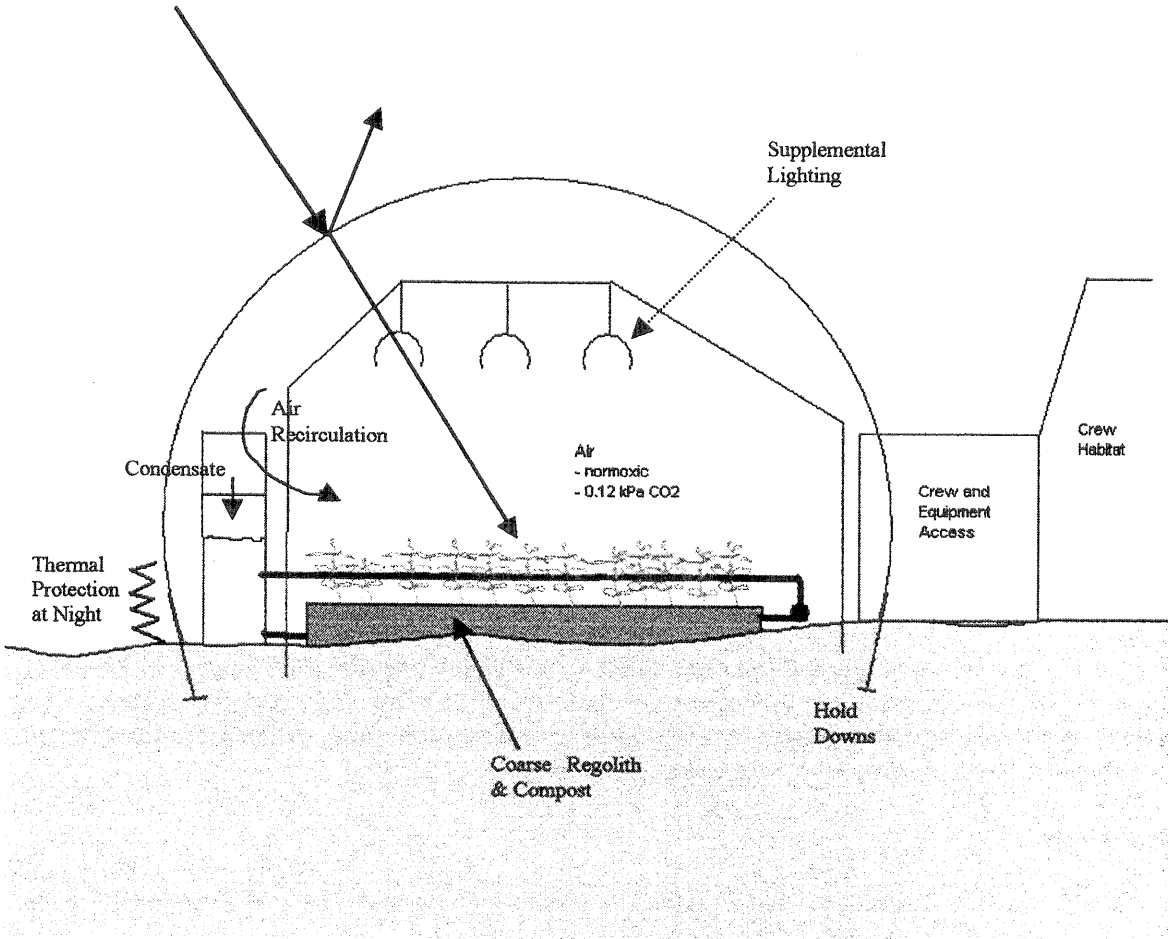

Fig. 1. Mars Greenhouse Concept

Plants would be sowed by hand, using hand-operated seeders. Environmental control would be automated. The crew would visually monitor crop growth on a daily basis. They would harvest crops either by hand (lettuce, potatoes) or using hand operated tools (wheat, soybean). The bed would be steam sterilized as required between crops. Additional compost would be mixed into the gravel.

Alternative scenarios could be derived from this scenario. Notably, an opaque membrane could be used with electrical lighting. This would reduce the dependence on the vagaries of natural sunlight and would simplify membrane design and thermal control, but would require more power.

A low pressure version could also be developed. If the diluent gas is avoided, the pressure could be reduced to about 21 kPa, reducing the membrane mass required by about 75%. However, the crew would be less comfortable in this mix, and sustained activity should not be expected of them.

Lower pressure might be used, perhaps as low as 10 kPa (Wheeler, personal communication). This would allow still lighter membranes to be used. However, the crew would then need pressure suits for operating in the chamber, probably requiring more extensive automation for crop activities.

Summary and Conclusions

In summary, plant growth on Mars looks attractive for long-duration missions. However, the analysis is complex as bioregeneration would affect all life support systems. For bioregeneration to be cost-effective, major improvements must be made in plant chamber design, with regard to both plant productivity and system cost.

References

1. Barta, D., Castillo, J., and Fortson, R. (1997). Crew and Thermal Systems Division, NASA JSC. *Bio-Plex Biomass Production System IDR*.
2. Cataldo, R. L. (1998). *Comparison of Solar Photovoltaic and Nuclear Power Systems for Human Missions to Mars*. Mars Exploration Forum, Lunar and Planetary Institute, Houston, Texas, 4 – 5 May.
3. Drysdale, A. E. and Hanford, A. J. (1999). *ALS SMAP Baseline Values and Assumptions Document*. JSC 39317. 6/18/99
4. Gertner, B. (1999). *Mars Greenhouse Study: Natural vs Artificial Lighting*. SMAP position paper.
5. Schwartzkopf, S. (1990). *Lunar Base CELSS*. LMSC/F369717.

Low Pressure Systems for Plant Growth

Ronald Lacey

Department of Agricultural Engineering, 201 Scoates Hall MS 2117,
College Station, TX 77843-2117

and

Malcolm Drew, and Robert Spanarkel

Department of Horticultural Science, Texas A&M University

Background

Plant growth systems have been identified as an important component of the National Aeronautics and Space Administration's (NASA) Advanced Life Support (ALS) program. Plant growth systems can provide atmosphere regeneration and edible biomass production in closed environments such as low Earth orbit stations and extraterrestrial colonies (Drake, 1998; Hoffman and Kaplan, 1997). There are a number of parameters that have been proven or identified as potential contributors to plant growth and survival under these harsh environments. Of these, total pressure within an enclosed life support system has been identified as providing one of the most significant impacts on the ALS metric. Reduced internal pressure drives reduced supply needs, reduced atmosphere leakage from the ALS, and potentially enhanced crew mobility by shortening time required for adjustments to changes in pressure before and after extra-vehicular activity.

Texas A&M University has been involved in low-pressure plant growth research since the mid-to-late 1980s where the first generation Low Pressure Plant Growth (LPPG) system was developed (Elo *et al.*, 1992). A modified version of this system was used to grow lettuce at 0.7 and 1.0 atmospheres while maintaining the partial pressures of oxygen and carbon dioxide at the same level in both chambers (Spanarkel, 1998). Growth from germination to harvest over a 32-day period resulted in increased biomass yield at reduced total pressures. Recently, a research grant from NASA has provided funding to revitalize the existing system into a second generation LPPG and to create a third generation system that will have enhanced operating characteristics and expanded capacity. The objective of this paper is to describe the second-generation system and discuss the engineering design and control for the third generation LPPG system.

Second Generation LPPG

The second generation LPPG is designed around an operational scheme similar to the modified first generation system used by Spanarkel (1998). The system consists of a pair of plant growth chambers, one of which operates at near ambient total pressure (101 KPa) while the second operates from ambient total pressure to approximately 70 KPa. Control parameters are total pressure, oxygen mass flow, carbon dioxide mass flow, nitrogen mass flow, and coolant flow. Measured system responses include total pressure, oxygen concentration, carbon dioxide concentration, dry bulb temperature, mass flow into and out of the chambers, and water vapor condensate collected. Table 1 lists the methodology used for each response measurement and Table 2 details the control devices employed. A piping and instrumentation diagram for the second-generation system is shown in Figure 1.

Table 1. Measured system response variables for 2nd generation LPPG

Parameter	Method	Instrument
Tdry bulb	thermistor	custom circuit
O ₂	electrochemical cell	CiTY O2 sensor
CO ₂	NDIR	Rosemount Infrared Gas Analyzer 880A
mass flow	thermal conductivity	Tylan Mass Flow Meter, 240
pressure	thin film transducer	Ashcroft K-1 pressure transmitter

Table 2. Control devices employed in 2nd generation LPPG

Parameter	Method	Device
O ₂ mass flow	thermal conductivity	Tylan Mass Flow Controller
CO ₂ mass flow	thermal conductivity	Tylan Mass Flow Controller
N ₂ mass flow	thermal conductivity	Tylan Mass Flow Meter
Coolant flow	NC 3-way solenoid valve	ASCO

The control logic used for operations of the 2nd generation LPPG does not vary significantly from that used in the original system. The control program was entirely rewritten in LabView (version 5.1, National Instruments, Austin, TX) to add a graphical user interface, improve flexibility in experimental operation, and simplify software maintenance of the program. The program operates in a series of nested conditional loops that follow the LabView wiring diagram shown in Figure 2.

Based on learning to date, there are several areas of opportunities to improve the first (and second) generation LPPG system. Foremost, among the areas in need of improvement is the volume of sample withdrawn for CO₂ measurement. Approximately 600 ml of headspace sample gas is removed from the 66 L growth chamber three times per hour. This translates to a gas exchange rate of 72% of the growth chamber volume per day. Make-up gases (O₂, CO₂, and N₂) are added back at the correct proportions to maintain total pressure but any potential accumulation of trace gases released by vegetation (e.g. ethylene) is diluted. The 600 ml volume is constrained by the IRGA, which requires a sample flow rate of 500 ml/min for analysis. The second area for improvement concerns the measurement of oxygen concentration at low pressure. The electrochemical cell currently used exhibits a marked, non-linear decline in response as the total pressure falls below 70 kPa (O₂ partial pressure of 14 kPa) Thus, 70 kPa is a practical lower limit to low pressure while using this sensor. Since we desire to test at total pressures of 25 KPa or lower, an alternative method to measure oxygen concentration is necessary. The third major shortcoming with the current system is the constraint of having only two chambers. This allows us to perform experimental treatment versus control, but replication is limited to sequential tests. Expansion of the system to six chambers (three experiment and three control) will allow for improved statistical comparison of test results. With these improvements in mind, a 3rd generation LPPG system has been designed.

Third Generation LPPG

The third generation LPPG system will consist of six plant growth chambers, each designed for independent operation from ambient total pressure (101 kPa) down to approximately 5 kPa total pressure. Partial pressures of oxygen and carbon dioxide will be controlled separately. The buffer gas will be nitrogen but other gases could be used with little modification. A piping and instrumentation diagram is shown in Figure 3 for the new system. This arrangement will allow for three replications of two level of pressure in each experiment. These replicated treatments will enhance the statistical analysis of results.

Total pressure, oxygen partial pressure, and carbon dioxide partial pressure have been established as the control parameters based on experimental objectives. The design ranges of these variables are summarized in Table 3. Total pressure will range from 20 kPa to 101.325 kPa (nominal ambient pressure) and oxygen partial pressure will vary from 5 kPa to 21 kPa (nominal ambient). Carbon dioxide partial pressure will range from 0.035 kPa (nominal ambient) to enhanced levels up to 1 kPa (10,000 ppm). Oxygen volumetric concentration will typically be maintained below 23.5% to avoid safety concerns related to oxygen enriched environments (Code of Federal Regulations, 1999). However, experiments at higher oxygen concentrations and lower total pressures will be possible and may be desirable as little data exists for plant growth under low total pressure conditions. Figure 4 is a graph of oxygen partial pressure and total pressure showing these constraints. A practical lower limit for total pressure of 21 kPa is established based on plant growth experiments that indicated no growth below 5 kPa of oxygen (Schwartzkopf and Mancinelli, 1991). This limit is determined by constraining oxygen concentration below 23.5%, oxygen partial pressure at 5 kPa, and accounting for the partial pressures of water vapor and carbon dioxide (1000 ppm). Other data indicates that an oxygen partial pressure below 10 kPa results in reduced plant growth (Saglio *et al.*, 1984), so a practical lower limit to total pressure may be as high as 43 kPa.

Table 3. Operation specifications for low pressure plant growth (LPPG) facility.

Variable	Range
Total Pressure	5 kPa to 101 kPa
O ₂ Partial Pressure	5 kPa to 21 kPa
CO ₂ Partial Pressure	0.035 kPa to 1 kPa
O ₂ concentration	< 23.5%

In order to determine the effects of oxygen partial pressure, carbon dioxide partial pressure, and total pressure on plant growth the instrumentation for the third generation LPPG system will include pressure transducers for each growth chamber, mass flow controllers for oxygen, carbon dioxide, and nitrogen, and measurement of gas concentrations by a process gas chromatograph (GC) with a thermal conductivity detector. The process GC resolves two problems with the second-generation LPPG system; (1) the gas sample will not have to be repressurized to ambient pressure for measurements and (2) the sample size will be approximately 1 – 2 ml instead of 600 ml used in the previous system. These features will maintain a closed system and allow measurement of the accumulation of trace gases over the growth cycle of the plants. Additional details of the instrumentation are shown in Table 4.

Table 4. Third generation LPPG instrumentation specifications for gas composition measurements. Use or mention of specific products does not constitute an endorsement by Texas A&M University.

Variable	Transducer Model	Range	Accuracy
Pressure	Ashcroft K1	0 – 101 kPa	± 0.5% full scale (FS)
Oxygen Flow	Aalborg DFC3600 mass flow controller	0 – 200 sccm	± 1% FS
Carbon Dioxide Flow	Aalborg DFC3600 mass flow controller	0 – 100 sccm	± 1% FS
Nitrogen Flow	Aalborg DFC3600 mass flow controller	0 – 1 slm	± 1% FS
Oxygen Concentration	Rosemount Analytical GCX Process Gas Chromatograph	0 – 21%	±1% FS
Carbon Dioxide Concentration	Rosemount Analytical GCX Process Gas Chromatograph	0 – 2%	±1% FS

The water vapor concentration at saturation is a strong function of temperature following the psychrometric equation (ASAE, 1999) but is not affected by total atmospheric pressure. At an ambient temperature of 20°C, the saturated vapor pressure would be 2.3 kPa. For a relative humidity (RH) of 75%, the contribution of water vapor to the total pressure would be 1.7 kPa. Assuming an available supply of liquid water, the contribution of water vapor partial pressure to total pressure is a constant at a constant temperature but will be a greater percentage of the gas volume as the total pressure is reduced. For example, at 5 kPa total pressure at 20°C and 75% RH, water vapor will comprise 34% of the gas composition. Control of the partial pressure of water vapor in the closed environment is critical as transpiration by the plants is driven by the vapor pressure gradient (VPG) from inside the leaf to the atmosphere beyond the boundary layer. Wet bulb and dry bulb temperature measurements will be taken in each chamber to determine water vapor pressure as well as ambient growth temperature. Each plant container will be supported on a 0 – 10 kg load cell so that water loss per unit time (i.e. transpiration rate) can be measured directly. A secondary means of measuring transpiration used in the earlier systems was to monitor the volume of condensate removed from the air in the growth chambers.

Growth media employed in low-pressure plant growth experiments has been either liquid solutions (hydroponics) or a solid (e.g. soil). The majority of the research has utilized hydroponic systems but data on oxygen uptake in maize roots indicated reduced oxygen uptake at oxygen partial pressures below 35 kPa for liquid media and below 10 kPa for soil (Saglio *et al.*, 1984). This difference in uptake rates was attributed to differences in oxygen diffusion in the boundary layer between the media and the root. Liquid media provided a thicker boundary layer and consequently required a greater difference in oxygen partial pressure to maintain a diffusive flux of oxygen to the root for consumption during respiration. For this reason, we have chosen to use a solid support medium for the plants. Work at Texas A&M University on low pressure plant growth has included evaluation of simulated lunar and mars regolith (Spanarkel, 1998).

In summary, Texas A&M University possesses a unique experimental tool in the LPPG system. The system is currently undergoing expansion to enhance the experimental capabilities

and should soon be providing data for the response of plants to non-terrestrial atmospheric conditions which may be utilized for exploration of mars or the lunar surface.

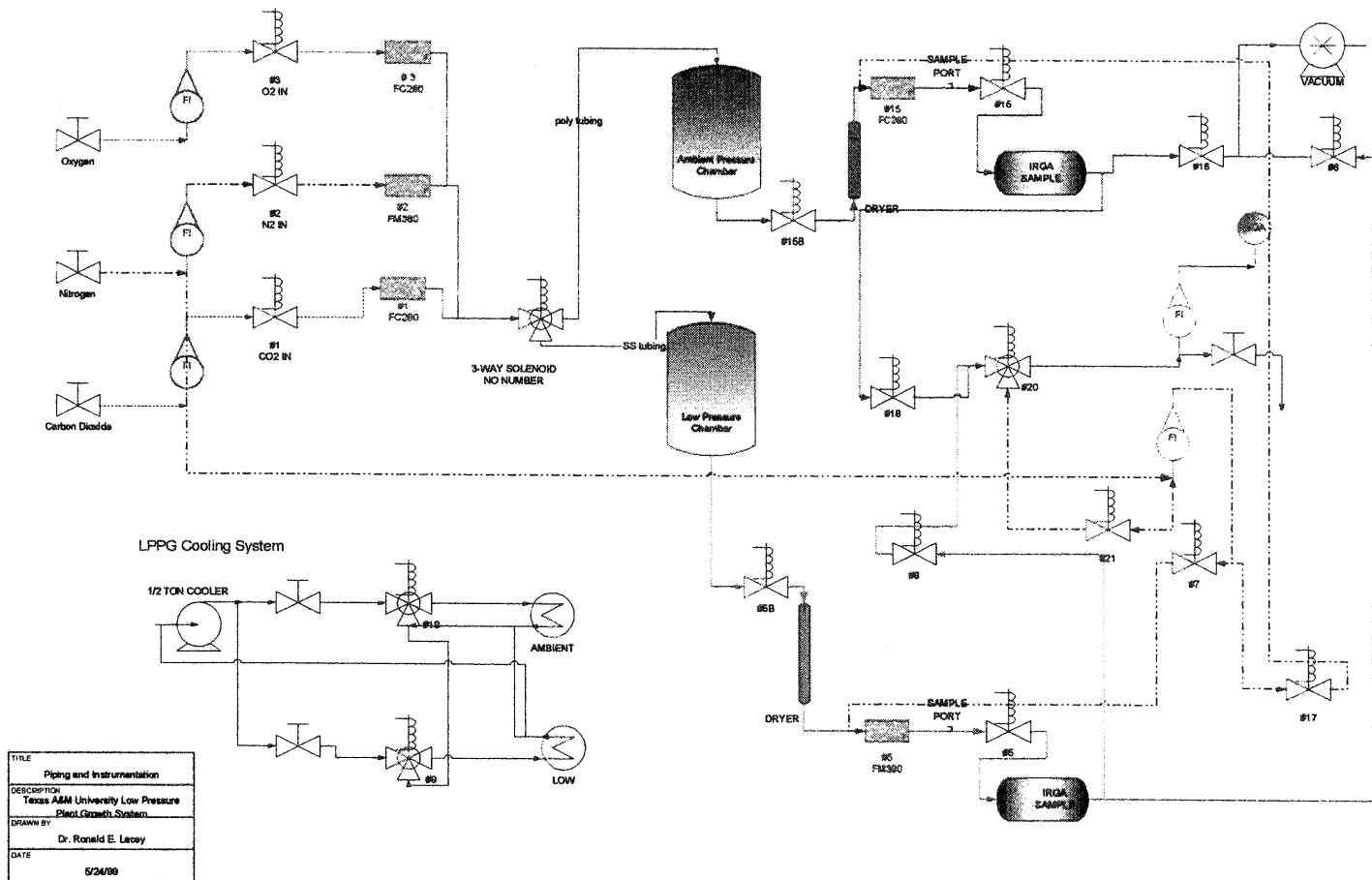

Fig. 1. Piping and instrumentation drawing for 2nd generation low-pressure plant growth system at Texas A&M University.

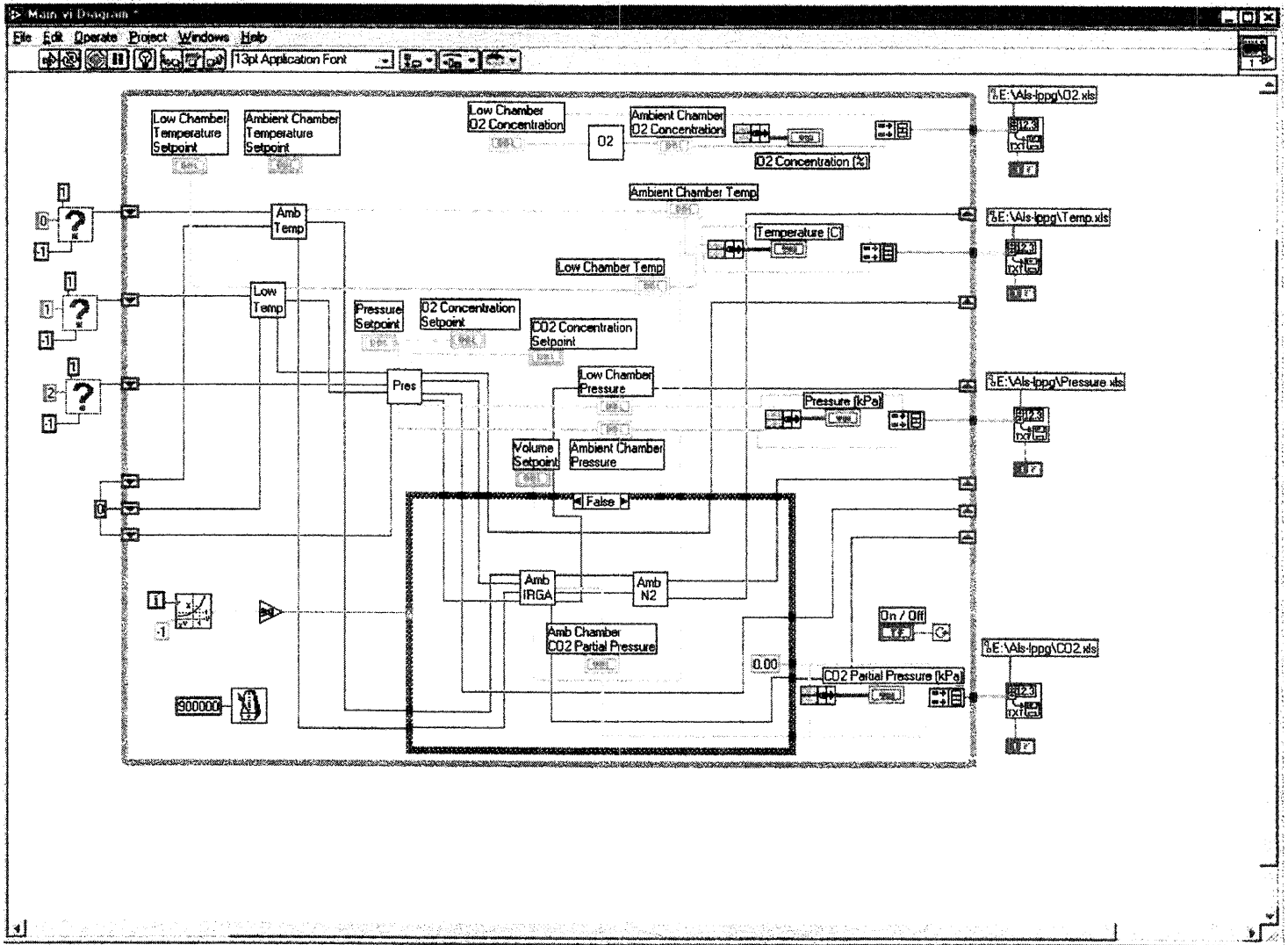
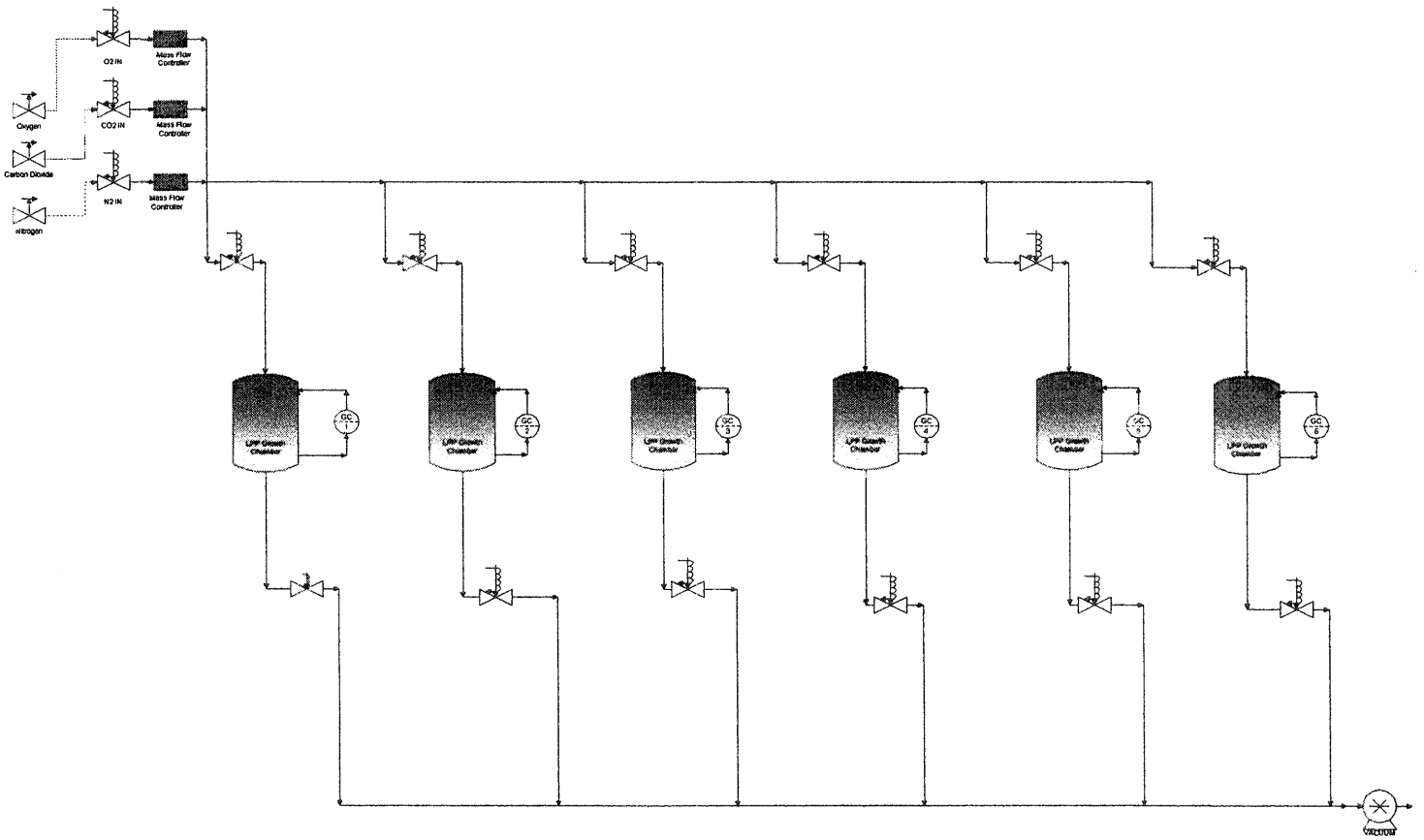

Fig. 2. LabView™ wiring diagram of control system for 2nd generation low-pressure plant growth system at Texas A&M University.

Fig. 3. Piping and instrumentation diagram for 3rd generation low-pressure plant growth system at Texas A&M University.



Texas A&M Low Pressure Plant Growth System 3rd Generation				
Gas Flow and Measurement				
Drawn by: Ronald E. Lacey	ISA	78020	Sheet 1	1 of 1
Date: November 30, 1999	Scale	1:1	Sheet	1 OF 2

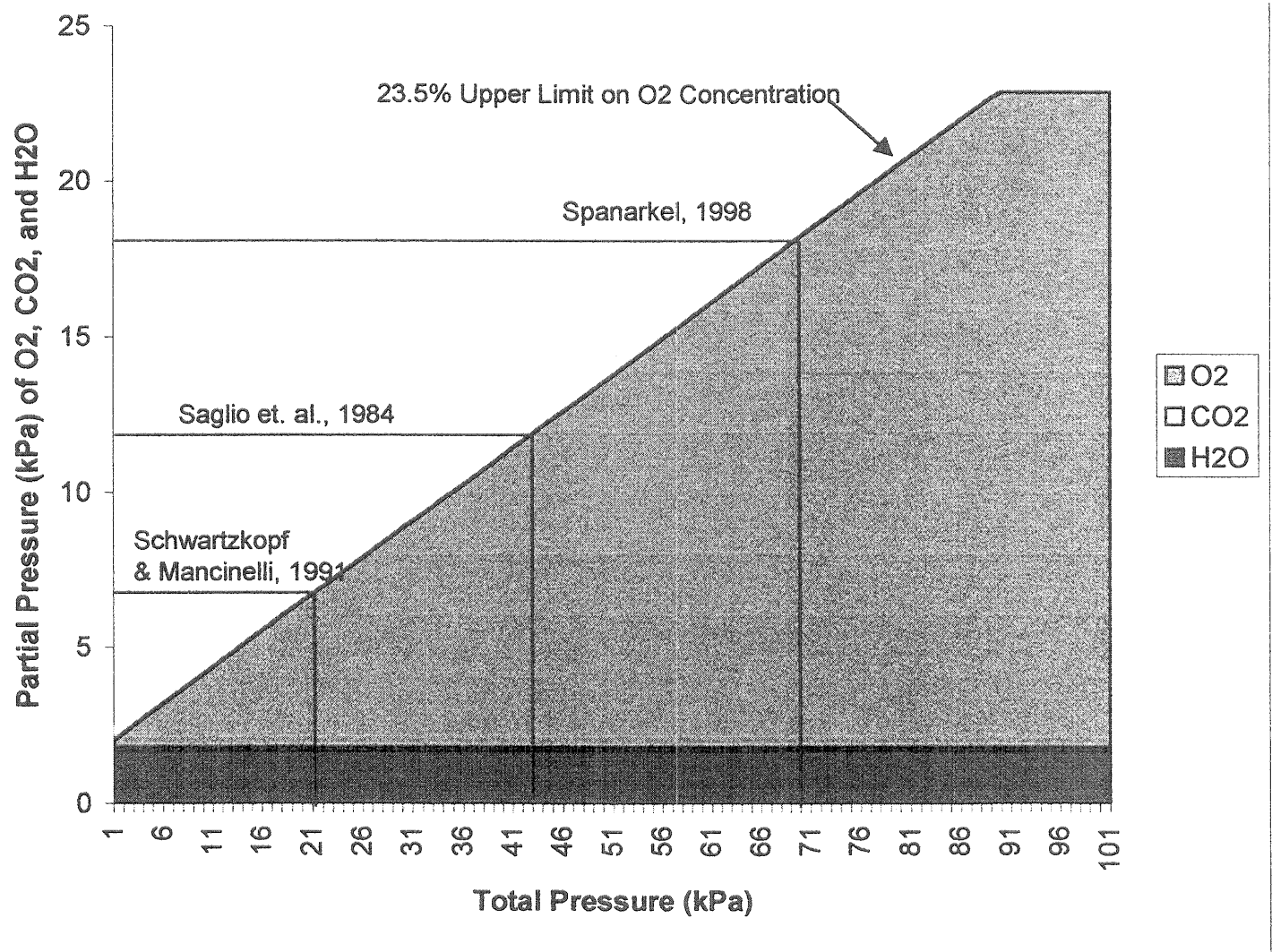

Fig. 4. Constraint on total pressure for low pressure plant growth at an ambient temperature of 20°C, 1000 .ppm carbon dioxide concentration, and oxygen concentration maintained at less then 23.5%. Experimental points from the literature are annotated.

References

1. ASAE (1999). ASAE D271.2 DEC94 Psychrometric Data. In "ASAE Standards", Vol. 46th edition. ASAE, St. Joseph, MI.
2. Code of Federal Regulations (1999). 29 CFR Ch. XVII S 1910.146. .
3. Drake, B. G., ed. (1998). "Reference Mission Version 3.0, Addendum to the Human Exploration of Mars: The Reference Mission of the NASA Mars Exploration Study Team," Vol. EX13-98-036. NASA, Lyndon B. Johnson Space Center, Houston, Texas.
4. Elo, S., Rykiel, E. J., Etter, B., Drew, M., Fu, A., and Stahl, R. (1992). "NASA/Texas A&M University Low Pressure Plant Growth Project,". Texas A&M University, College Station, TX.
5. Hoffman, S. J., and Kaplan, D. L., eds. (1997). "Human Exploration of Mars: The Reference Mission of the NASA Mars Exploration Study Team," Vol. NASA Special Report 6107, pp.. 1-215. NASA, Houston, Texas.
6. Saglio, P. H., Rancillac, M., Bruzan, F., and Pradet, A. (1984). Critical oxygen pressure for growth and respiration of excised and intact roots. *Plant Physiology* 76, 151-154.
7. Schwartzkopf, S. H., and Mancinelli, R. L. (1991). Germination and growth of wheat in simulated martian atmospheres. *Acta Astronautica* 60.
8. Spanarkel, R. (1998). The Effect of Low Atmospheric Pressure, Variable Oxygen and Carbon Dioxide Concentration, and Alternative Soilless Root Media on the Growth of Plants. Ph.D. Dissertation, Texas A&M University, College Station, TX.

PLANT RESPONSES TO RARIFIED ATMOSPHERES

Kenneth A. Corey, Department of Plant & Soil Sciences, University of Massachusetts, Amherst, MA 01003
Philip A. Fowler, Dynamac Corporation, Kennedy Space Center, FL 32899, and
Raymond M. Wheeler, National Aeronautics & Space Administration, Kennedy Space Center, FL 32899

Abstract

Reduced atmospheric pressures will likely be used to minimize mass and engineering requirements for plant growth habitats used in extraterrestrial applications. This report provides a brief survey of key literature related to responses of plants to atmospheric variables and a broad rationale for designing minimal atmospheres for future plant growth structures on the Martian surface. The literature and recent work suggest that atmospheric pressure limits for normal plant function are likely to be 10 kPa or perhaps slightly lower. At Kennedy Space Center, a chamber with high vacuum capability was used to design and begin construction of a system for testing plant responses to reduced pressure atmospheres. A test rack with lighting provided by 3, high-pressure sodium vapor lamps was built to conduct measurements of short-term plant responses. Initial experiments with lettuce showed that a pressure of 10 kPa resulted in a 6.1-fold increase in the rate of water loss compared to water loss at ambient pressure (101 kPa). Plants were severely wilted after 30 minutes exposure to 10 kPa, but relative humidity was only 44 %. Water loss was found to be inversely correlated with atmospheric pressure over the range of pressures from 21 to 101 kPa; the rate of water loss at 21 kPa was 4.3 times higher than water loss at ambient pressure. Older leaves showed moderate wilting during exposure to 21 kPa, but those exposed to 46 kPa remained turgid. Relationships between water loss and vapor pressure deficit were nonlinear, suggesting an effect of atmospheric conditions on pathway resistance. Follow-up experiments demonstrated that plant turgidity could be maintained at atmospheric pressures in the range of 10 to 20 kPa, depending on temperature and relative humidity. Further work will be required to separate and clarify the roles of vapor pressure deficit, stomatal conductance, and reduced pressure atmospheres on plant function. Past and present work suggest that deployment of lightweight plant growth structures for Mars using ambient solar flux and atmospheric pressures of one-tenth atmosphere are feasible.

Introduction

Sending organisms to Mars or other extreme environment outposts and sustaining their life-giving functions provides humans with the opportunity to meet one of the major technological challenges of the twenty-first century. There is little doubt that Mars may be recognized as the next frontier. Prior to sending humans to Mars, it will be necessary to develop energetically cost efficient methods for providing them with oxygen, potable water, and food. Early travelers to Mars will likely employ physical-chemical systems to provide the first two requirements with nearly all the necessary food requirements for the journey being launched. Plants may be used to a limited extent primarily to provide supplemental consumables (food, oxygen, and water) to a crew and to help meet human aesthetic and psychological needs.

Long term economic trade-off studies suggest that advanced life support systems for extraterrestrial applications will utilize plants to supply human life support requirements for food, oxygen, and potable water (Barta and Henninger, 1994). There is a need to reevaluate and update such studies to incorporate in situ resource utilization practices for specific scenarios such as reduced atmospheric pressures for plant growth structures on Mars. Even without this rationale, it is certain that plants will at some time in the not too distant future, be a vital and integral component of the human exploration and settlement of space. Life support requirements of plants can be provided more readily from available resources on Mars than those of humans. The Martian atmosphere contains the major essential elements carbon, oxygen, nitrogen, and hydrogen, all of which can be converted into biomass given sufficient solar flux at the Martian surface and an appropriately engineered, controlled environment habitat.

The prospect of plant culture outside Earth environments gives rise to questions regarding the pressure and composition of the atmosphere of growth habitats. If humans and plants share the same atmospheric volumes, then plant culture is constrained by the priority of human requirements. Human requirements will likely not involve oxygen partial pressures below 15 to 20 kPa or total atmospheric pressures below 50 kPa. However,

those partial pressure values are fairly conservative given the fact that people are known to adapt to much lower partial pressures of oxygen such as those experienced at high altitude villages in the Himalayas and Andes mountain regions.

It may not be necessary to consider habitats designed for integration of plants and people since pressures selected for human habitation are probably not those that would be optimum for growth of plants. Hypobaric pressures will likely be used to decrease the mass and engineering requirements for establishing and sustaining plant growth habitats on extraterrestrial outposts (Figure 1). The major engineering consideration justifying the use of hypobaric pressures is that the structural requirements to contain a pressure gradient decrease with decreasing pressure. Therefore, a premise of this paper is to consider the use of reduced pressure atmospheres in autonomous plant growth structures [Boston, 1981; Clawson et al., 1999] that would be isolated from human habitation, and provide, in early phase advanced human life support systems, a back-up or perhaps lifeboat to physical-chemical systems. With such a premise, it follows that it will be necessary to define the limits of atmospheric pressure and partial pressures of oxygen and carbon dioxide for growth of plants. Questions related to exploring theoretical and practical limits of atmospheric variables (pressure and composition) for plant growth also have relevance to numerous other fields related to advanced life support program goals (Figure 1).

Reduced Atmospheric Pressure Research

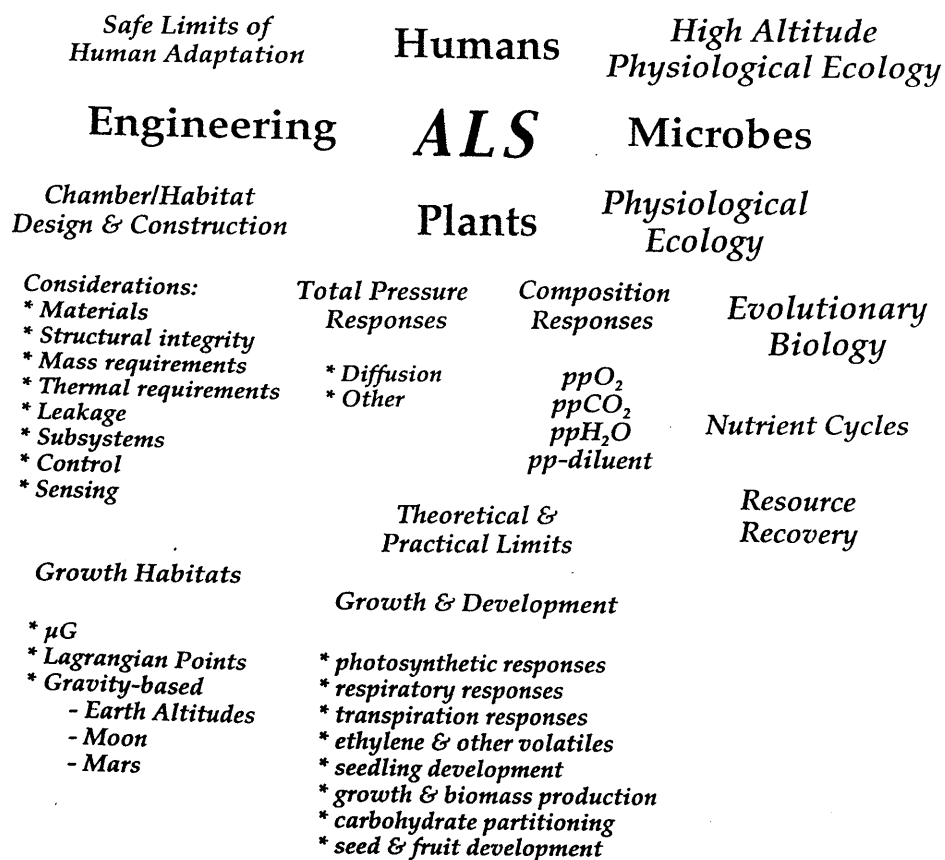

Figure 1. Interdisciplinary nature of advanced life support systems goals and fields of scientific endeavor relevant to reduced atmospheric pressure research with emphasis on future considerations for designing atmospheres for plant growth in extraterrestrial habitats.

Historical

High altitude regions provide us with an excellent Earth-based analog for reduced pressure studies over a limited pressure range. The equation $P = P_0 (1 - 0.0065 A/288)^{5.255}$ expresses the relationship of total atmospheric pressure with increasing altitude and is illustrated in Figure 2. The curves are expressed over the range of sea level atmospheric pressure up to an altitude of over 30,000 meters or the approximate equivalent of the Martian atmospheric pressure (~ 1 kPa). The summit of Mt. Everest, while rarefied for terrestrial Earth locations, nevertheless has about one-third atmosphere pressure. Based upon theoretical considerations of atmospheric pressure, diffusion, and stomatal resistance relationships, Gale (1972) tested the idea that decreased ppCO₂ with increasing altitude led to decreased availability of carbon dioxide for photosynthesis. He concluded that the increased rate of CO₂ diffusion with decreasing pressure should compensate for the effect of lowered ppCO₂ with decreasing pressure. Experimental work confirmed this prediction for corn and bean and also demonstrated enhancement of transpiration rates with decreasing pressure (Gale, 1973). The relationship of diffusion rates of carbon dioxide and water vapor with total atmospheric pressure can be expressed by the following equation: $D' = D^0 (T'/T^0)^m (760/P')$. Figure 3 illustrates this relationship as a ratio of diffusivity at some pressure, P, with that of ambient sea level pressure (101 kPa). Thus, possible enhancements of rates of carbon dioxide uptake and transpiration with decreasing pressure are predicted based upon enhanced diffusivity of gases (e.g. D at 10 kPa ~ 10 D at 101 kPa).

Several test facilities have been used to assess metabolic and developmental responses of plants to reduced pressure [Andre and Massimino, 1992; Corey et al., 1996, 1997a, 1997b, 1999; Daunicht and Brinkjans, 1992; Ohta et al., 1993; Rule and Staby, 1981, Schwartzkopf and Mancinelli, 1991]. However, most studies thus far have not provided clear separation of pressure and oxygen effects, nor have they involved complete growth tests of large plant samples for assessment of yield. On the basis of enhanced diffusion of gases at reduced pressure, water flux may increase. Although enhancements of water flux with decreased pressures have been documented for several plants, separation of effects of total pressure and water vapor pressure deficit have not been clear.

If reduced pressure is also accompanied by reduced partial pressure of oxygen, enhancement of net photosynthesis and growth may occur through a reduction in carbon loss by suppression of photorespiration. Evolutionary biologists generally recognize that organisms with photosynthetic capacity existed and evolved during a time in geologic history when the partial pressure of oxygen was very low. Thus, the biochemistry of plant metabolism evolved under low partial pressures of oxygen. In 1920, Warburg observed that oxygen release by illuminated *Chlorella* was inhibited by oxygen; the discovery that the photosynthetic mechanism was poisoned by the oxygen it had released. By the 1950's and 1960's, the biochemical pathways for this photoinhibition by oxygen were elucidated. Most lower and higher plants studied thus far, possess this carbon-wasteful process known as photorespiration. Direct and indirect effects of oxygen on photorespiration and growth of C₃ pathway plants are well documented [Bjorkman, 1966; Gerbaud and Andre, 1989; Musgrave et al., 1988, Musgrave and Strain, 1988; Parkinson et al., 1974; Siegel, 1961] and have been reviewed [Ehleringer, 1979; Jackson and Volk, 1970; Quebedeaux and Hardy, 1976]. Photorespiratory carbon losses may be minimized by either low oxygen (i.e. 2 - 5 kPa) or high partial pressures of carbon dioxide (>100 Pa).

Andre and Richaud (1986) and Andre and Massimino (1992) determined physiological responses of wheat to pressures as low as 7 kPa. Their objectives were to determine if plants can grow in a quasi-vacuum and if there was a need for a diluent gas (e.g. nitrogen). Their work demonstrated that wheat was insensitive to depressurization, that an inert 'diluent' gas is unnecessary, and that water loss was accelerated. With lettuce [Corey et al., 1996], carbon dioxide uptake was found to be nearly constant in the range of 50 to 100 kPa atmospheric pressure and that enhancement of photosynthesis with reduced pressure in this range was primarily due to decreased partial pressure of oxygen. A 34-day test and complete growth tests of wheat in Johnson Space Center's Variable Pressure Growth Chamber demonstrated enhancements of photosynthesis and transpiration at 70 kPa atmospheric pressure and reduced ppO₂ of 14 kPa [Corey et al., 1996b, Corey et al., 2000]. Whole stands of wheat exhibit marked responses to ppO₂ down to 5 kPa (Figure 4) despite ppCO₂ in excess of 100 Pa (Corey, 2000, unpublished data). Enhanced photosynthesis in those tests also translated into increased total biomass. Thus, the use of reduced pressure atmospheres also provides an additional rationale for modification of gas compositions (O₂, CO₂, H₂O, and diluent) to optimize plant growth and development.

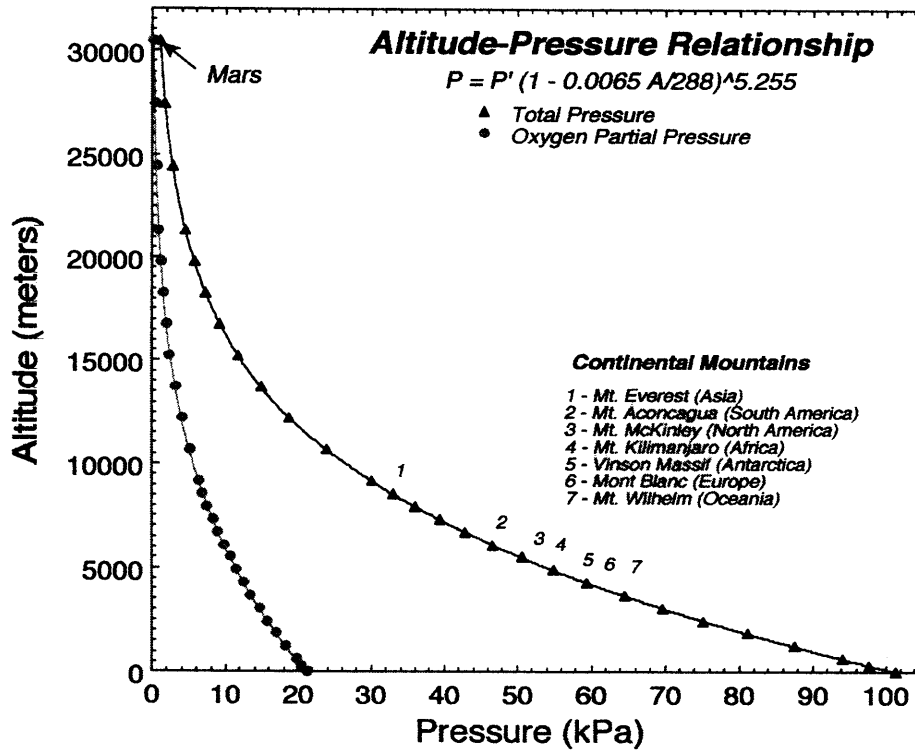

Figure 2. Relationships of total atmospheric pressure and partial pressure of oxygen with altitude. Values for total pressure were calculated after Gale (1972) and values for oxygen partial pressure were estimated assuming a constant mole fraction of 0.209.

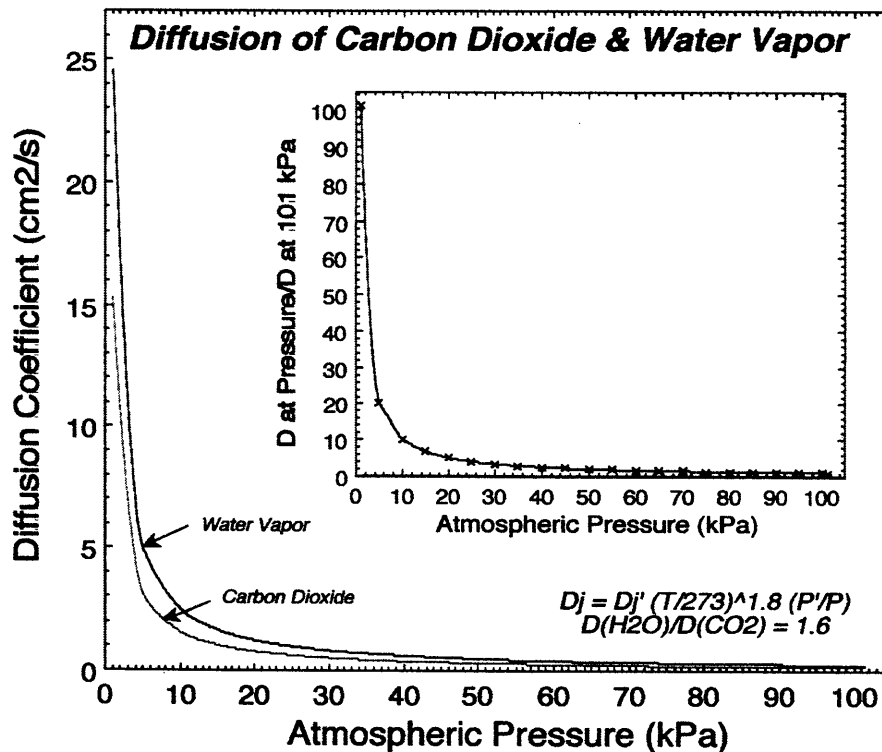

Figure 3. Diffusion coefficients for carbon dioxide and water below 1 atm pressure and the ratio of diffusivities at some pressure, P, to those at mean sea level pressure.

Thermotron Studies at Kennedy Space Center

During the summer of 1999, low pressure studies were initiated at the Kennedy Space Center as part of a Mars inflatable greenhouse project. A broad goal of the work is to define limits of total pressure and composition for plant growth. Short-term plant responses to reduced pressure atmospheres were measured in a thermal vacuum chamber or Thermotron (Thermotron Industries, Holland, Michigan), a high vacuum chamber rated for 1 torr and thermal control in the range of -72 to 177 C. Effective internal dimensions of the chamber are 1.22 m wide X 1.22 m high X 1.62 m deep. Fans and motors are housed internally in the rear of the chamber and the vacuum pump is located external to the chamber. Temperature and pressure measurements inside the chamber were made with thermocouples and a Barotron pressure transducer, respectively.

Chamber Leakage Measurement

Vacuum chambers have penetrations and seals that usually result in some leakage of external air into the chamber and evacuation of internal gases to maintain constant pressure. Measurements involving the rates of uptake or evolution of a gas such as carbon dioxide during plant photosynthesis and respiration will be affected by significant leakage rates and therefore must be measured. The most rapid and straightforward method for leakage measurement is to disable the vacuum pump and follow the pressure increase over time. Evaluation of the first derivative of this function at the pressure of interest will give a chamber leakage value that can be applied to making corrections to measurements of plant metabolic rates. A detailed treatment of leakage measurements, calculations, and application to gas exchange measurements at reduced pressure has been reported [Corey et al., 1997a; Corey et al., 2000].

The first of such rate of rise tests for the Thermotron was conducted on June 16, 1999. The chamber was pumped down to 17 mm Hg, the pump disabled, and the pressure allowed to increase up to 86 mm Hg. Chamber temperature during the test was between 20 and 21 C. The leakage rate was measured to be 0.46 mm Hg/min. Using a previously determined volume measurement of 3382 liters (Corey, 1999), the air leakage rate of the chamber, L_a was calculated as 0.87 chamber volumes per day at 20 C and pressures < 10 kPa. Based upon previous experiences with gas exchange measurements at reduced pressure and rough calculations, this value is low enough to permit sensitive measurements of CO_2 uptake measurements, given a sufficient plant sample size. The plant sample size required for the acquisition of short-term measurements of good sensitivity and reasonable duration (< 30 minutes) for the Thermotron is likely in the range of 0.5 to 1.0 m^2 area.

Plant Test Stand

A rack was built to accommodate the space and light requirements for measuring short term plant responses to reduced pressures. Three, 400-W high pressure sodium (HPS) vapor lamps were mounted on a rack that measured 112 cm wide X 152 cm deep X 116 cm high. Photosynthetic photon flux measurements were made with a LICOR quantum sensor and gave values in the range of 300 to 400 $\mu\text{mol}/\text{m}^2\text{s}$ depending on position and canopy height; more than adequate for testing short-term physiological responses or for growth of lettuce plants. The first phase involved testing small samples of lettuce (*Lactuca sativus* cultivar Waldeman's Green) plants grown in a controlled environment growth chamber. Plants were grown at a temperature of 22 C, 75 % relative humidity, a photosynthetic photon flux of 260 $\mu\text{mol m}^{-2} \text{s}^{-1}$, a ppCO_2 of 120 Pa, and a light/dark cycle of 18 hr/6 hr. Seeds were sown in a solid medium (1:1 peat-vermiculite mix), transplanted as seedlings into the same medium, and grown in 15-cm diameter plastic pots. Plants were fertilized with half-strength modified Hoagland's solution every other day until 15 days-old, and every day thereafter.

Lettuce Transpiration Experiments

The first chamber test with lettuce involved placing 2 plants on a scale (0.1 g sensitivity) and monitoring weight loss at ambient pressure, followed by pumping the chamber down to a pressure of 10 kPa. Plants were watered to bring the soil up to an approximate field capacity moisture content prior to the start of the experiment, and then placed in plastic bags that were tucked loosely under the foliage to minimize the evaporative water loss

component. Temperature control for the comparison was excellent, but relative humidity was lower at reduced pressure (~44 %). Weight loss was over 6-fold higher at 10 kPa pressure and plants exhibited severe wilting from which they recovered fully in about 30 minutes after return to ambient pressure. The next test involved an incremental step down in atmospheric pressure from ambient with plants held at each pressure for about 30 minutes each. Since plants exhibited severe wilting at 10 kPa, the lowest pressure treatment selected was 21 kPa. Rate of water loss increased with decreasing pressure; the rate at 156 mm Hg (~ 21 kPa) being about 4.3-fold higher than the water loss at ambient pressure (Figure 5A & 5B). Over the range of 156 to 766 mm Hg, the rate of water loss was inversely correlated with pressure (Figure 5B). Relative humidity was controlled fairly well, though it was lower (68 %) for the 156 mm Hg treatment than the average of 76 % across all treatments. The relationships of water loss and vapor pressure deficit for those experiments were nonlinear (data not shown) suggesting an effect of atmospheric conditions on stomatal resistance.

The next experiment simply involved a partial repetition of the previous experiment with a direct comparison of ambient atmospheric pressure and 147 mm Hg (21 kPa). At the end of the experiment, all leaves of each plant were detached and area determinations made with a LICOR portable area meter (model LI-300A). Results of the previous experiment were confirmed, with water loss expressed on a leaf area basis being 6.8 times higher at 147 mm Hg than that of ambient pressure (Table 1). Only slight wilting of the older leaves was observed on the low pressure treatment. Several months later, better control of relative humidity and ppCO₂ enabled measurements at pressures down to 10 kPa. This particular batch of lettuce plants held at 10 kPa and 75 % relative humidity for several hours exhibited no signs of wilting.

Table 1. Water loss from lettuce plants held for 30 minutes in the Thermotron at ambient and reduced atmospheric pressures.

Pressure ^a (mm Hg)	Temperature ^b (C)	Relative Humidity ^b (%)	Water Loss ^c (mg/min·m ²)
777 ± 0.1	22.9 ± 0.3	81 ± 3	77
147 ± 1.0	22.8 ± 0.1	73 ± 5	522

^aValues represent means of 7 readings ± 1 S.D. taken over a period of 30 minutes.

^bValues represent means of 2 instruments and 7 readings each ± 1 S.D. taken over a period of 30 minutes.

^cWater loss was expressed on the basis of an average leaf area of 0.31 ± 0.03 m²/plant.

Future Directions in Reduced Pressure Research

This report presents a brief overview of the rationale, history, and current directions of research on plant responses to reduced atmospheric pressure for extraterrestrial crop production. If the atmospheric requirements of plants are considered, the two broad categories of necessary research are to define the limits of total pressure and of partial pressures of oxygen, carbon dioxide, water vapor, and diluent gas (Figure 1). The simulation of reduced atmospheric pressure environments involves the use of vacuum systems or the use of terrestrial, Earth-based analogs such as mountains or high altitude flights. The terrestrial analog limit of pressure is about one-third atmosphere. Testing the limits of plant function and growth and attempting to make the delta pressure for a Martian growth structure a minimum, will involve testing at pressures in the range of 2 to 20 kPa. Perhaps short-term responses could be measured using high, constant altitude flight experiments conducted at altitudes of 13,000 to 30,000 meters.

Based upon current work at KSC, it appears that lettuce will be able to tolerate pressures as low as 10 kPa without wilting, provided that high moisture in the root zone and high humidity in the atmosphere are maintained. The preliminary tests of the Thermotron experiments did not involve control of carbon dioxide partial pressure, a variable known to effect stomatal physiology. Therefore, future tests will require modifications that will enable carbon dioxide measurement, injection, and control to hold partial pressure constant for comparisons of different atmospheric pressures.

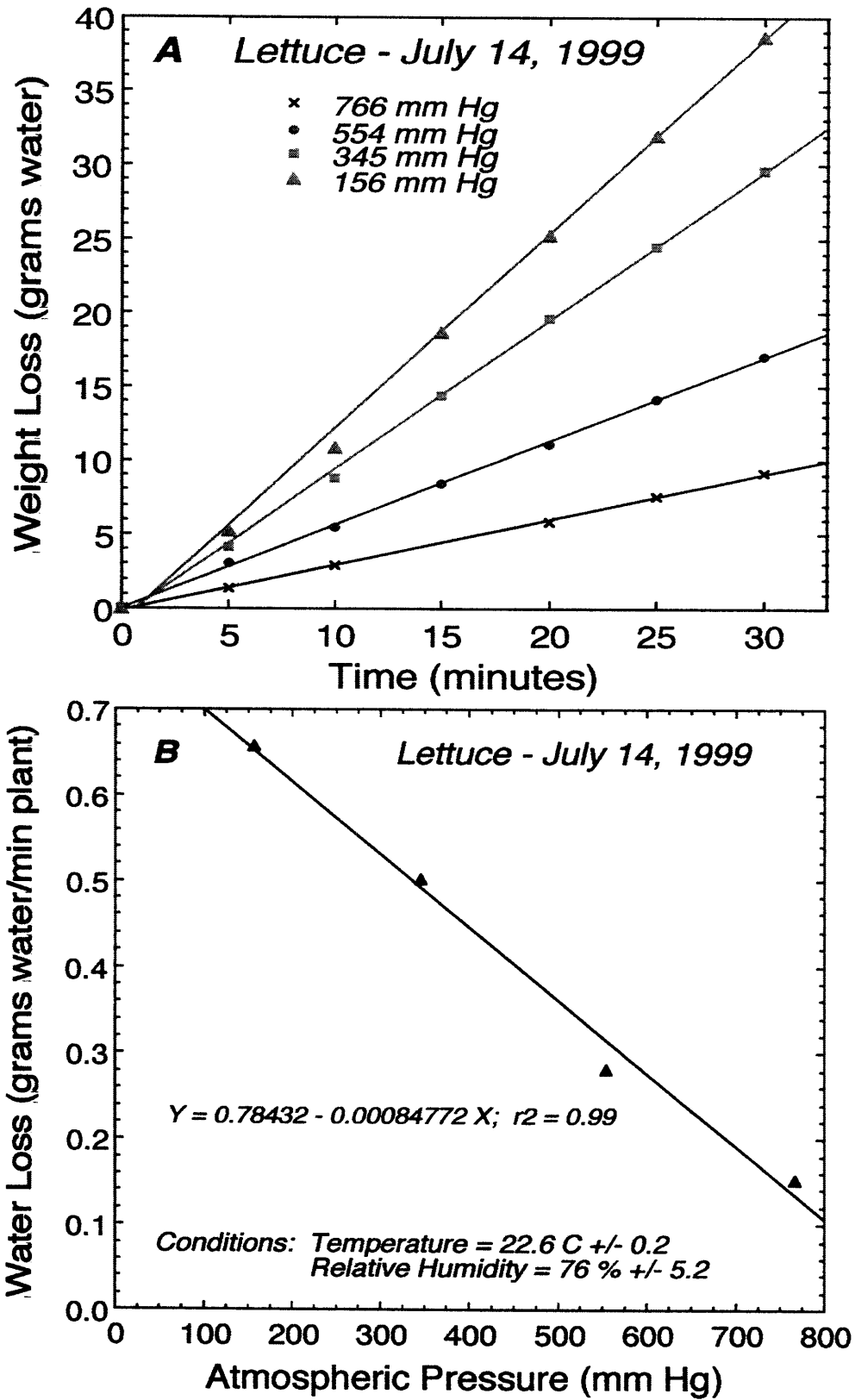

Figure 5. Changes in weight of lettuce plants exposed to progressive reductions in atmospheric pressure (A) and the relationship of water loss to atmospheric pressure (B).

In future studies, it will be important to have a higher degree of control of relative humidity and to be able to control at a higher value (>90 %). The lower limits of atmospheric pressure attainable without adverse effects to plants will depend largely on temperature and relative humidity, the primary factors controlling the leaf-to-atmosphere vapor pressure deficit. Higher relative humidity and lower temperature will both have the effect of decreasing the gradient for water transfer from the leaf to the atmosphere. Considerable research will be needed to determine the safe limits for plant growth at low pressure for growth from seed to harvest maturity of different species. Perhaps development and growth from seed will lead to developmental, morphological, and physiological adaptations to the reduced atmospheric pressure environment.

Beyond such studies, there will be additional needs to control other atmospheric gases such as oxygen and nitrogen, construct an appropriate hydroponic nutrient delivery system, and monitor key atmospheric and nutrient solution variables. Following testing with at least two crop species, it will then be possible to use results of such tests to define some of the requirements for inflatable structures and specifically for near term prototype testing of such structures on ISS or on the Moon. In the long run, it will be economically and psychologically necessary to have plants, microbial life, and other life forms connected with the human settlement beyond the boundaries of planet Earth.

References

- Andre, M. and Ch. Richaux. 1986. Can plants grow in quasi-vacuum? In: CELSS 1985 Workshop, NASA Publication TM 88215, 395-404.
- Andre, M. and D. Massimino. 1992. Growth of plants at reduced pressures: experiments in wheat-technological advantages and constraints. *Adv. Space Res.* 12: 97-106.
- Boston, P.J. 1981. Low-pressure greenhouses and plants for a manned research station on Mars. *J. British Interplanetary Soc.* 54: 189-192.
- Barta, D.J. and D.L. Henninger. 1994. Regenerative life support systems – why do we need them? *Adv. Space Res.* 14 (11): 403-410.
- Bjorkman, O. 1966. The effect of oxygen concentration on photosynthesis in higher plants. *Physiol. Plant.* 19: 618-633.
- Clawson, J.M., A. Hoehn, L.S. Stodieck, and P. Todd. 1999. AG-Pod: The integration of existing technologies for efficient, affordable space flight agriculture. SAE Paper No. 1999-1-2176, 29th International Conference on Environmental Systems (ICES), Denver, Colorado.
- Corey, K.A., D.J. Barta, and K.E. Henderson. 2000. Carbon use, water flux, and growth of wheat at reduced atmospheric pressure. Manuscript in preparation.
- Corey, K.A. 1999. Testing plant responses to rarified atmospheres for inflatable greenhouses. 1999 Summer Faculty Fellowship Program Contract Report. 10 pages.
- Corey, K.A., D.J. Barta, M.A. Edeen, and D.L. Henninger. 1997. Atmospheric leakage and method for measurement of gas exchange rates of a crop stand at reduced pressure. *Adv. Space Res.* 20 (10): 1861-1867.
- Corey, K.A., D.J. Barta, and D.L. Henninger. 1997. Photosynthesis and respiration of a wheat stand at reduced atmospheric pressure and reduced oxygen. *Adv. Space Res.* 20 (10): 1869-1877.
- Corey, K.A., M.E. Bates, and S.L. Adams. 1996. Carbon dioxide exchange of lettuce plants under hypobaric conditions. *Adv. Space Res.* 18 (4/5): 265-272.
- Daunicht, H.J. and H.J. Brinkjans. 1992. Gas exchange and growth of plants under reduced air pressure. *Adv. Space Res.* 12: 107-114.
- Ehleringer, J.R. 1979. Photosynthesis and photorespiration: Biochemistry, physiology, and ecological implications. *HortScience* 14: 217-222.
- Gale, J. 1973. Experimental evidence for the effect of barometric pressure on photosynthesis and transpiration. In: *Plant Responses to Climatic Factors*, Proceedings of the Uppsala Symposium, UNESCO, Paris, pp. 289-294.
- Gale, J. 1972. Availability of carbon dioxide for photosynthesis at high altitudes: theoretical considerations. *Ecology* 53: 494-497.
- Gerbaud, A. and M. Andre. 1989. Photosynthesis and photorespiration in whole plants of wheat. *Plant Physiol.* 89: 61-68.
- Jackson, W.S. and R.J. Volk. 1970. Photorespiration. *Ann. Rev. Plant Physiol.* 21: 385-432.
- Musgrave, M.E., W.A. Gerth, H.W. Scheld, and B.R. Strain. 1988. Growth and mitochondrial respiration of mungbeans (*Phaseolus aureus* Roxb.) germinated at low pressure. *Plant Physiol.* 86: 19-22.
- Musgrave, M.E. and B.R. Strain. 1988. Response of two wheat cultivars to CO₂ enrichment under subambient oxygen conditions. *Plant Physiol.* 87: 346-350.
- Quebedeaux, B. and R.W.F. Hardy. 1976. Oxygen concentration: Regulation of crop growth and productivity. In: Carbon Dioxide Metabolism and Plant Productivity, R.H. Burris and C.C. Black, eds., University Park Press, Baltimore, Maryland.

- Ohta, H., E. Goto, T. Takakura, F. Takagi, Y. Hirosawa, and K. Takagi. 1993. Measurement of photosynthetic and Transpiration rates under low total pressures. American Society of Agricultural Engineering Paper No. 934009.
- Parkinson, K.J., H.L. Penman, and E.B. Tregunna. 1974. Growth of plants in different oxygen concentrations. *J. Expt. Bot.* 25: 135-145.
- Rule, D.E. and G.L. Staby. 1981. Growth of tomato seedlings at sub-atmospheric pressures. *HortScience* 16: 331-332.
- Siegel, S.M. 1961. Effects of reduced oxygen tension on vascular plants. *Physiol. Plant.* 14: 554-557.
- Schwartzkopf, S.H. and R.L. Mancinelli. 1991. Germination and growth of wheat in simulated Martian atmospheres. *Acta Astronautica* 25: 245-247.

Can CO₂ be Used as a Pressurizing Gas for Mars Greenhouses ?

Raymond M. Wheeler
NASA Biomedical Office
Kennedy Space Center
FL 32899 USA
raymond.wheeler-1@ksc.nasa.gov

Background

The possibility of using plants to provide oxygen (O₂) and food during space travel has been discussed and studied for nearly 50 years (Myers, 1954). The concept is based on the process of photosynthesis, which uses CO₂ as a substrate and is driven by light (photosynthetically active radiation—PAR) in the 400 to 700 nm waveband (Galston, 1992). In addition to the CO₂ and light, the plants would require a controlled environment with acceptable temperatures (~10 to 35°C) and humidities (~40 to 85%) (Tibbitts and Kozlowski, 1979), adequate supplies of water and mineral nutrients (Marschner, 1995), and minimum levels of oxygen to sustain respiration (Siegel et al., 1962; Musgrave et al., 1988; Schwartzkopf and Mancinelli, 1991).

Because the atmospheric pressure of Mars is likely too low (0.6-1.5 kPa; McKay, 1984) to sustain acceptable plant growth (Andre and Richaud, 1985; Schwartzkopf and Mancinelli, 1991), and plant growth modules on Mars would need to be pressured to some level. This might be achieved by regular additions of some inert diluent gas, such as N₂ or Ar. Both nitrogen and argon are present in the Martian atmosphere, but in small quantities (2.7% and 1.6%, respectively; McKay, 1984). Hence it might be difficult to obtain adequate supplies of these gases. In contrast, CO₂ is relatively plentiful on Mars—0.95% of the atmosphere. Could this CO₂ be used as a pressuring gas? Clearly CO₂ is not biological inert, but a continuous supply of CO₂ would be needed to sustain plant photosynthesis and using it as a pressurizing gas could also satisfy this requirement. Assuming a Martian plant growth module is designed to operate at 20 kPa total pressure, perhaps at least 5 kPa of this would need to be O₂ to sustain plant (especially root-zone) respiration (Siegel et al., 1963; Musgrave et al., 1988), and up to 2 kPa would have to be water vapor to maintain adequate relative humidity in the module and avoid plant stress (Andre and Richaud, 1985). If CO₂ were used as a pressurizing gas, it could comprise up to 13 kPa of the 20 kPa atmosphere. At Earth ambient pressures, this would equate to 130,000 ppm of CO₂, or over 300 times the current concentration of about 360 ppm.

CO₂ Effects on Plants

The effects of CO₂ on plants have been widely studied and the research literature is extensive. Among the most commonly observed effects of increased CO₂ are increased photosynthesis (for C₃ plants) and decreased transpiration (Wittwer and Robb, 1964; Hicklenton, 1988; Drake et al., 1996). These changes typically occur as CO₂ is increased from ~300 ppm (0.03 kPa) to about 1000 ppm (0.1 kPa). As a consequence, many controlled environment plant production systems on Earth (e.g., commercial greenhouses) enrich CO₂ concentrations to increase photosynthetic rates and overall plant growth (Wittwer and Robb, 1964; Porter and Grodzinski, 1985; Hicklenton, 1988). But there is little advantage to going to levels much greater than 2-3 X ambient and few terrestrial greenhouses enrich CO₂ much above ~1000 ppm (0.1 kPa). Consequently, there are relatively few studies of plant responses to CO₂ concentrations >0.2 kPa (Wheeler, 1993; 1999).



Figure 1. Leaf bleaching on soybean noted at high CO₂ (0.5 kPa) partial pressures. Rusty flecks / spots are typical of normal senescence.

Our research group at NASA's Kennedy Space Center has been interested in the effects of super-elevated or supraoptimal CO₂ concentrations for a number of years, primarily because of the high CO₂ concentrations encountered in human-habitats in space environments. For example, CO₂ concentrations in NASA's Space Shuttle Orbiter commonly range from 0.4 to 0.6 kPa, and occasionally exceed 1.0 kPa (Wheeler et al., 1993). When we grew soybeans at a range of CO₂ concentrations, the upper canopy leaves showed some premature senescence and bleached, necrotic areas at the highest CO₂ level—0.5 kPa (Wheeler et al., 1993) (Fig. 1). This occurred during late pod fill of the plants and consequently had no significant effect on plant biomass or seed yield (Table 1). Subsequent studies with potatoes (Mackowiak and Wheeler, 1996) and radish (Mackowiak et al., 1996) showed similar injury at 1.0 kPa (10,000 ppm) CO₂. This result was not surprising based on other reports of possible CO₂ toxicity to plants (Berkel, 1984; Ehret and Jolliffe, 1985; Hicklenton, 1988; Bugbee et al., 1994). (Note, toxicity implies a substance is beyond the "sufficiency" level, or supraoptimal, but not necessarily at lethal levels). Most of our studies were conducted at a light level of $\sim 300 \mu\text{mol m}^{-2} \text{s}^{-1}$ PAR with a 12-h photoperiod, or about $13 \text{ mol m}^{-2} \text{day}^{-1}$ of total light. This is a relatively low total light level, which may have minimized potential injury at the high CO₂ levels, and additional studies are needed with super-elevated CO₂ at higher light intensities Wheeler et al., 1999).

Table 1. Biomass yields, water use, and water use requirements (water needed per unit biomass) of soybean and potato plants grown at different CO₂ partial pressures.

Crop	CO ₂	Total Dry Mass	Total Water Use	Water Use Requirement
	(kPa)	(kg)	(kg)	(kg g ⁻¹)
Soybean	0.05	2.04	845	414
	0.10	2.49	822	330
	0.20	2.27	879	387
	0.50	2.27	1194	526
Potato	0.05	3.25	483	149
	0.10	4.02	573	142
	0.50	3.66	916	250
	1.00	4.04	910	225

A more surprising observation from our studies was a significant increase in leaf transpiration and plant water use at the super-elevated CO₂ concentrations (e.g., 0.5 – 1.0 kPa) for most of the species tested (Table 1). This was a result of high stomatal conductance, i.e., the stomatal pores were more open (Wheeler et al., 1999) (Fig. 2). Although the stomatal conductance is also high at low CO₂ concentrations (e.g., 0.05 kPa), the stomata at these lower concentrations close during dark cycles (Wheeler et al., 1999). But this dark period closure does not occur or is incomplete with soybean, potato, radish, or sweetpotato at 0.5 and 1.0 kPa CO₂. At present, we still do not understand why this occurs.

Are High CO₂ Concentrations Tolerable in a Mars Plant Production System ?

The observations from these studies suggest the transpiration for many species will be high at very high CO₂ concentrations (e.g., > 1.0 kPa). This may not be a concern in terrestrial, hydroponic systems where ample water is available, but presents a challenge for space-based systems where water supplies are limited and rapid recycling is essential. Moreover, a consistent observation from low pressure studies with plants is that transpiration tends to rise due to increased gas diffusion rates between leaves and the surrounding atmosphere (Gale, 1973; Daunicht and Brinkjans, 1992; Corey et al., 1996). Thus if plants are grown at low pressures (e.g. 20 kPa) in an atmosphere where CO₂ is higher than ~0.5 kPa, plant watering requirements could be high. This could be offset somewhat by raising humidities in the plant modules, but maintaining high humidities may be difficult at lower pressures where heat exchange systems tend to condense humidity from the air very rapidly (see Fowler, this proceedings).

Do these findings preclude the use of CO₂ as a pressuring gas for Martian greenhouses? Carbon dioxide is readily available from the Martian atmosphere and could be provided by compressors/collectors envisioned for *in situ* propellant production systems. Use of local CO₂ could reduce or eliminate resupply gas costs and improve the economic feasibility of plant production systems. In addition, if a high proportion of O₂ is required for low-pressure atmospheres, high concentrations of CO₂ could provide some fire protection (quenching) advantages over Ar or N₂, but this would need to be determined. The leakage rates of different gases through component materials would also need to be compared. But, plant tolerance to very high CO₂ levels remains key. The fact that wheat showed no apparent injury and only moderate changes in transpiration at very high CO₂ suggest that capabilities exist for plant tolerance to super-elevated CO₂ (Bugbee et al., 1994; Grotenhuis and Bugbee, 1997).

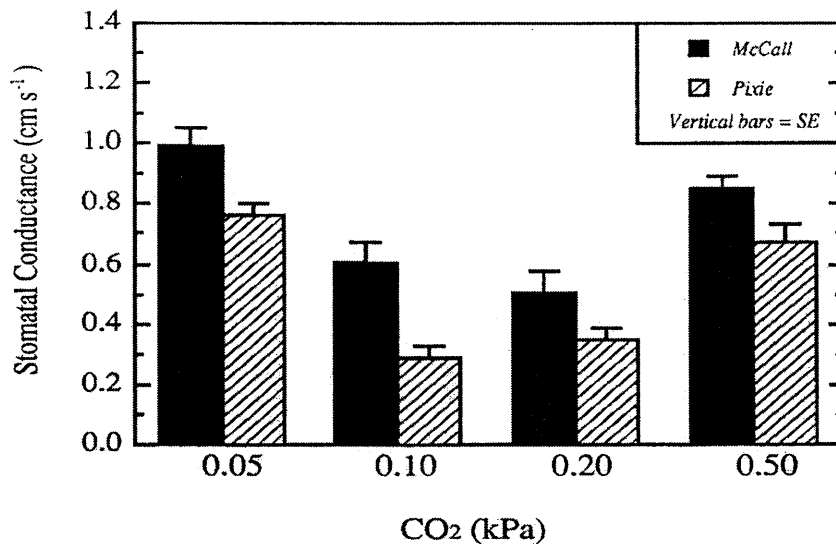

Figure 2. Stomatal conductance of two cultivars of soybean (McCall and Pixie) at different CO₂ partial pressures.

Alternatively, *in situ* gas compressing / collecting systems might produce sufficient Ar or N₂ to pressurize plant production modules. This could avoid the need for maintaining very high CO₂ pressures, but complicate the systems somewhat by now requiring CO₂ control (for photosynthetic needs) and separate pressurizing-gas controls. In addition, use of Ar would require testing to assess the effects of Ar-enriched atmospheres on plants. For example, as with CO₂, Ar is heavier than N₂ and would alter boundary layers around leaves, which in turn would affect gas diffusion and convective heat exchange (Larcher, 1975). A curious alternative exists for using N₂ as a pressurizing gas, where some of the N₂ might be produced through bacterial denitrification. Assuming the plant production system is not sterile, microflora that colonize the plant roots might be used to generate N₂ gas from nitrate (Garland, 1994). These “denitrifying” organisms can use nitrate as a terminal electron acceptor under anaerobic conditions, and in the process reduce the nitrate through N₂O to N₂ (Smart et al., 1996). This approach would require anaerobic zones or pockets in the root zone, and a supply of nitrate salts to meet the nitrogen needs of the plants and bacteria; in addition, the plants would have to be tolerant of hypoxic root environments (e.g., flood-tolerant species, such as rice). Clearly the kinetics and management of such an approach would need study, but the concept would fit well with low O₂ partial pressure systems where denitrification may be unavoidable.

Conclusions

Use of low-pressure enclosures for growing plants on Mars could reduce the structural requirements and gas leakage, and increase the potential for finding satisfactory transparent materials. This would require assessing plant responses to different combinations (partial pressures) of O₂, H₂O, and CO₂. In addition, the effects of total pressure and choices for pressurizing gases would need to be studied. The pressurizing gas would likely represent largest leakage loss from the system and costs could be reduced if this gas were obtained locally, i.e., the Martian atmosphere. Because CO₂ is relatively plentiful on Mars, CO₂ might be used as a pressurizing gas in addition to sustaining photosynthesis. But results from plant studies using very high CO₂ partial pressures (e.g., > 0.5 kPa) indicate that CO₂ might become injurious and/or

increase water demands in some species. Further studies are needed to define these CO₂ responses and to begin selecting or genetically engineering plants to perform well in low total pressure, high CO₂ partial pressure environments.

References

1. Andre, M. and Ch. Richaud. 1985. Can plants grow in a quasi-vacuum? In: R.D. MacElroy, M.V. Martello, and D.T. Smernoff (eds.) CELSS '85 Workshop. *NASA Technical Memorandum* 88215. NASA Ames Research Center, Moffett Field, CA.
2. Berkel N. van. 1984. Injurious effects of high CO₂. *Acta Horticulturae* 162:101-112.
3. Bugbee B., B. Spanarkel, S. Johnson, O. Monje, and G. Koerner. 1994. CO₂ crop growth enhancement and toxicity in wheat and rice. *Advances in Space Research* 14(11):257-267.
4. Corey, K.A., D.J. Barta, and D.L. Henninger. 1997. Photosynthesis and respiration of a wheat stand at reduced atmospheric pressure and reduced oxygen. *Advances in Space Research* 20(10):1869-1877.
5. Daunicht, H. J. and H. J. Brinkjans. 1992. Gas exchange and growth of plants under reduced air pressure. *Advances in Space Research* 12(5):107-114.
6. Drake, B.G., M.A. Gonzalez-Meler, and S.P. Long. 1996. More efficient plants: A consequence of rising atmospheric CO₂? *Annual Reviews of Plant Physiology and Plant Molecular Biology*. 48:609-639.
7. Ehret D.L. and P.A. Jolliffe. 1985. Leaf injury to bean plants grown in carbon dioxide enriched atmospheres. *Canadian Journal of Botany* 63:2015-2020.
8. Gale, J. 1973. Experimental evidence for the effect of barometric pressure on photosynthesis and transpiration. In: *Plant Response to Climatic Factors*, Proc. Uppsala Symp. (1970).
9. Galston, A.W. 1992. Photosynthesis as a basis for life support on Earth and in space. *BioScience* 42:490-493.
10. Garland, J.L. 1994. The structure and function of microbial communities in recirculating hydroponic systems. *Advances in Space Research* 14:383-386.
11. Grotenhuis T.P. and B. Bugbee. 1997. Super-optimal CO₂ reduces seed yield but not vegetative growth in wheat. *Crop Science* 37:1215-1222.
12. Hicklenton P.R. 1988. *CO₂ enrichment in the greenhouse*. Timber Press, Portland, Oregon, USA.
13. Larcher, W. 1975. *Physiological plant ecology*. Springer-Verlag, Berlin.
14. Mackowiak, C.L., L.M. Ruffe, N.C. Yorio, and R.M. Wheeler. 1994. Effect of carbon dioxide enrichment of radish production using nutrient film technique (NFT). *NASA Technical Memorandum*, 109198. Kennedy Space Center, FL.
15. Mackowiak, C.L. and R.M. Wheeler. 1996. Growth and stomatal behavior of hydroponically culture potato (*Solanum tuberosum* L.) at elevated and super-elevated CO₂. *Journal of Plant Physiology* 149:205-210.
16. Marschner, H. 1995. *Mineral nutrition of higher plants. Principles of plant nutrition*. Academic Press, New York, NY, USA.
17. McKay, C.P. 1984. A short guide to Mars. In: P.J. Boston (ed.) *The eCas for Mars*. Vol 57, Science and Technology Series, Amer. Astronautical Soc., San Diego, CA.
18. Musgrave, M.E., W.A. Gerth, H. W. Scheld, and B.R. Strain. 1988. Growth and mitochondrial respiration of mungbeans (*Phaseolus aureus* Roxb.) germinated at low pressure. *Plant Physiology* 86:19-22.
19. Myers, J. 1954. Basic remarks on the use of plants as a biological gas exchangers in a closed system. *J. Aviation Med.* 25:407-411.
20. Tibbitts, T.W. and T.T. Kozlowski. 1979. *Controlled environment guidelines for plant research*. Academic Press, Inc. New York, NY, USA.

21. Schwartzkopf, S.H. and R.L. Mancinelli. 1991. Germination and growth of wheat in simulated Martian atmospheres. *Acta Astronautica* 25:245-247.
22. Siegel, S.M., L.a. Rosen, and C. Giunarro. 1963. Plants at sub-atmospheric oxygen-levels. *Nature* 198:1288-1290.
23. Smart, D., K. Ritchie, and B. Bugbee. 1996. Mass transfer in the biological fast lane: High CO₂ and a shallow root zone. *Life Support and Biosphere Science* 3:43-46.
24. Wheeler, R.M., C.L. Mackowiak, L.M. Siegrist, and J.C. Sager. 1993. Supraoptimal carbon dioxide effects on growth of soybean (*Glycine max* (L.) Merr.). *Journal of Plant Physiology* 142:173-178.
25. Wheeler, R.M., C.L. Mackowiak, N.C. Yorio, and J.C. Sager. 1999. Effects of CO₂ on stomatal conductance: Do stomata open at very high CO₂ concentrations? *Annals of Botany* 83:243-251.
26. Wittwer SH, Robb W.M. 1964. Carbon dioxide enrichment of greenhouse atmospheres for food crop production. *Economic Botany* 18:34-56.

Inflatable Habitats Technology Development

Kriss J. Kennedy, Space Architect
TransHab Project Office
NASA Johnson Space Center

ABSTRACT

For many years inflatable structures have been theorized for use as satellite dishes, deployable arrays and human habitats. They fall into human-rated and non-human rated structures. As such the structural design requirements and safety redundancy are much different. This paper will discuss the Habitat and Surface Construction Technology that would support the development of Mars greenhouses and well as habitats. This paper will briefly describe the ISS TransHab architectural design and structural testing for the proposed as a habitation module for the International Space Station. It will also discuss inflatable greenhouse design considerations and examples.

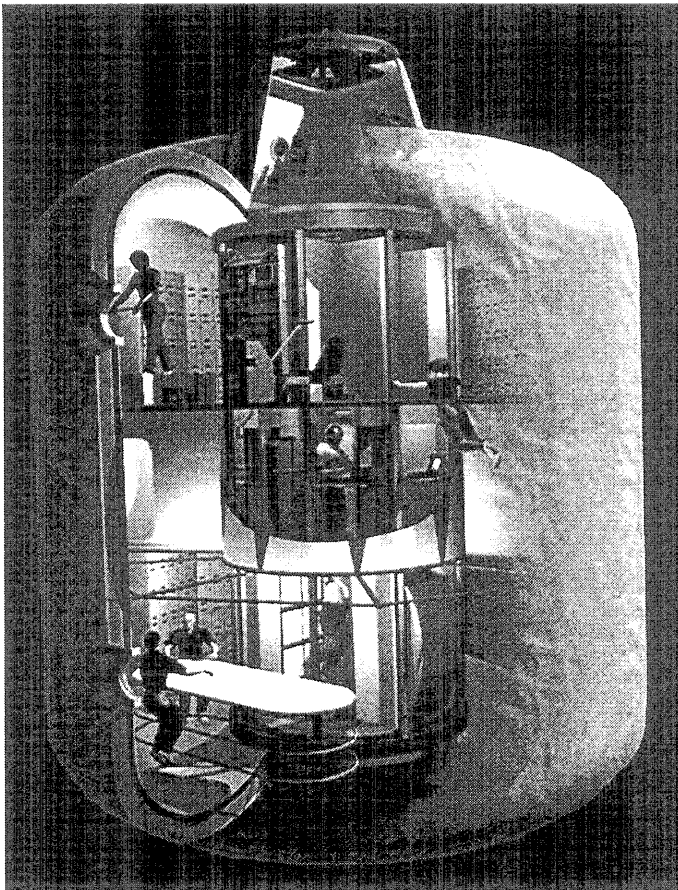

Figure 1. ISS TransHab Internal View, NASA JSC S99-05363

INTRODUCTION

Space habitats are a re-creation of the earth environment for the purpose of sustaining human life. The space environment is characterized by vacuum, orbital debris, micro gravity for orbital space stations and transfer missions, partial gravity for planetary exploration missions, radiation, and planetary dust. Habitats are complex, heavy, expensive elements around which support systems are functionally arrayed, both in transportation systems and permanent facilities like space stations and future planetary bases.

NASA has considered tensile fabric structures in the past. In the late 1960's several inflatable structures were designed and tested for space applications. The Langley Research Center leads efforts to develop and test a 24' diameter torus space station, a Lunar Stay Time Extension Module prototype and a large space station module nick-named Moby Dick. All of these were successfully tested, but were moth balled when the Moon program was halted in favor of a new space vehicle. During the 60s, 70s, and 80s NASA relied on metal (mostly aluminum) structures for all their habitat efforts. It was known, safe and proved reliable. So when the Lunar Base System Study team started proposing an inflatable as a primary structure; they drew a great deal of criticism. It took many years of persistence, and a few failures, before the textile industry turned the technological corner with fibers like Kevlar, Vectran and Polybenzoxazole (PBO).

Over the years the idea of inflatable structures for space habitats slowly began to make sense. Several important NASA reports such as the Synthesis Group Report identified inflatable structures as an enabling technology that would allow NASA to accomplish lighter weight structures at a lower cost. Inflatable structures have caught on and are one of the promising new technologies for NASA. They will change how we think about designing habitats and laboratories, hotels, resorts for space and greenhouses. They will also revolutionize the space architecture world by opening up the possibilities of shapes and sizes to create human settlement of the solar system.

With the emergence of TransHab, NASA is at a crossroads of not being limited to cylindrical hard modules. Many wonderful and architecturally pleasing

shapes will emerge bringing in a new space era and new century. Perhaps this is fitting that NASA step into the new century with inflatable structures leading the way.

TransHab pushed the technological envelope beyond previous design work. The innovative engineers at JSC soon shaped a revolutionary concept from the hard aluminum shell alternative. Since that early inception in early 1997 it has been through numerous design iterations. The current design is proposed as the habitat module for the International Space Station. A team of architects and engineers at the Johnson Space Center has been working, designing and testing this concept to mitigate the risky technical challenges that the critiques continue to throw at them. So far the TransHab Project team has surpassed every challenge with vigor and determination.

Habitats & Surface Construction

NASA has long been a leader in research and development of new technologies for space activities. Many of which have spun off to benefit human kind and Earth. Prime examples are computers, medicine, recycling and there are many, many more. Numerous technology thrusts were identified for NASA technology development need. One of these technology thrust areas is Advanced Habitats and Surface Construction Technology as part of the Exploration Office technology strategy. Habitats are categorized into three classifications. Class I is a pre-integrated habitat in that it is entirely manufactured, integrated and ready to operate when delivered to space. Class II is a pre-fabricated habitat and space or surface deployed. Class III is an in-situ derived habitat that it's structure is manufactured using local resource available on the Moon or Mars. For example, mining Martian gypsum and making a concrete material used to form habitats.

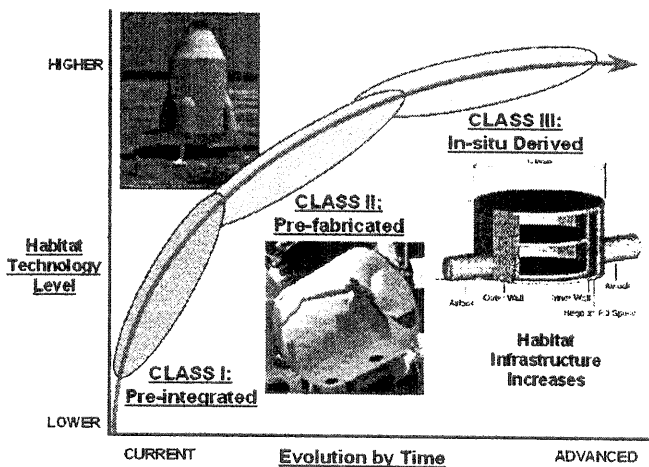

Figure 2. Habitat Classifications

A Class I technology road map for inflatable structures was laid out that includes the development of different technical solutions and different manufacturing

approaches types of inflatable habitat structures, figure 3. Whereas inflatable structures are in the fore front of the technology roadmap, there are other important areas such as robotic construction, self deploying structures, smart structures and self-healing structures to mention a few.

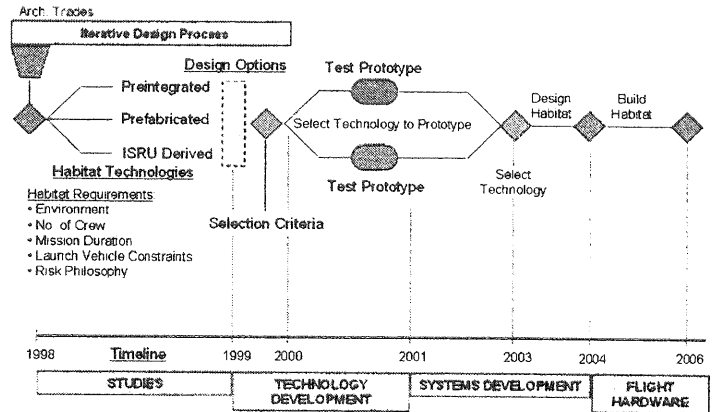

Figure 3. Inflatable Habitat Technology Development Strategy

The Advanced Habitation and Construction Technology vision is to begin working on innovative technologies required to enable the Human Exploration and Development of Space Enterprise to meet the demanding environment of better, faster, cheaper. Space and planetary habitation, pressure structures and unpressurized shelters are being sought out for innovative structural solutions that combine high strength and light weight materials, along with the reliability, durability, reparability, radiation protection, packaging efficiency and life-cycle cost effectiveness. Advances in material developments and manufacturing techniques that enable the structure to "self-heal," and the emplacement, erection, deployment or manufacturing of habitats in space or on the Moon and Mars are considered enabling technologies for the evolution of humans into space and the eventual settlement on Mars. Integration of sensors, circuitry and automated components to enable self-deployment and "smart" structures are considered necessary to allow a habitat to operate autonomously.

The objective is to create an advanced habitat that becomes a "living" structure that not only runs autonomously, but also has self-healing capability. A number of technologies and techniques have been proposed that allow the delivery of deployable habitats to space and planet surfaces or the manufacturing and construction of habitats on planet surfaces. Many new and exciting break-throughs in biotechnology have opened up exciting possibilities. The use of biotechnology combined with a fabric or matrix structure could someday produce a self-healing property analogous to our human skin.

NASA will be researching methods and techniques for fully integrated inflatable "skin" and sensors/circuitry that enables "smart" structures that autonomously detect, analyze, and correct (repair) structural failure. Manufacturing methods of integrating miniaturization

technology into the habitat skins, thus reducing weight and increasing self-autonomy are being considered. Technologies of this nature will be required to develop large planetary bases and support infrastructure such as inflatable greenhouses.

Methods for designing, manufacturing and testing of inflatable structures that meet human space flight requirements are being developed for TransHab. History has taught us that architects and engineers have shaped our built environment; and they will continue to do so on Earth and in space. Ground breaking technology work by architects and engineers at JSC are laying the technology foundation by which many will follow for years to come. Whereas the TransHab team has made incredible strides there still remains a great deal of work on the ground and in space to get humans living in fabric structures. Many companies are very interested in this technology for many different space applications.

TransHab Architecture

TransHab is a unique hybrid structure that combines a hard central core with an inflatable exterior shell. An integrated pressurized tunnel is located at one end to provide access to the space station. An unpressurized tunnel is located at the opposite end and houses the TransHab inflation system. Figure 4 shows an overview of the ISS TransHab architecture.

The ISS TransHab is divided into four functional levels within its pressurized volume. Levels one through three are for living space and the fourth is the connecting tunnel. Level one is the galley / wardroom and soft stowage area. Level two is the crew quarters and mechanical room area. The crew quarters are inside the central core and radiation shield water tanks. Level Three is the crew health care area and soft stowage area.

The architecture of TransHab provides an integrated habitable environment that creates private and social spaces. A functional and physical separation of the crew health care area, crew quarters, and galley/wardroom area creates a home-like design for the crew while they are in space. With a larger volume than a station hard module TransHab provides more storage volume, two means of unobstructed egress, and permanently deployed equipment, such as a treadmill and ergometer. Some of the important design objectives of TransHab are to maintain a local vertical configuration, separate the exercise area from the dining area and to provide larger crew quarters.

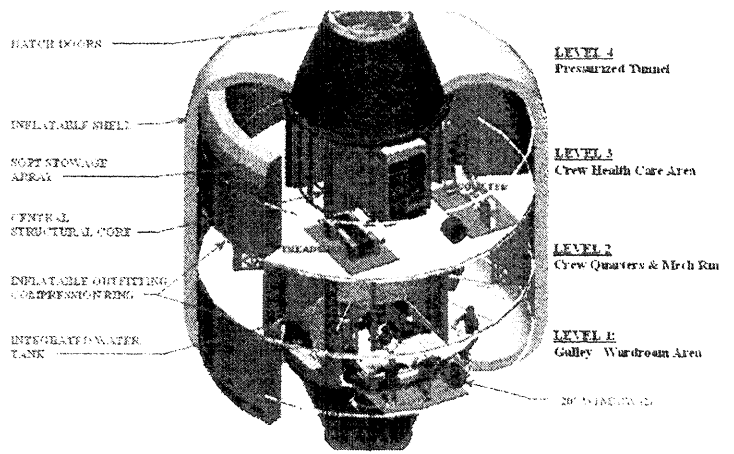

Figure 4. TransHab Overview

The TransHab module currently being proposed for the ISS is approximately 40 feet (12.19 m) long overall by 25 feet (7.28 m) internal diameter providing 12,077-ft³ (342 m³) of pressurized volume. Levels 1 and 3 are 8-ft tall at the Central Core and Level 2 is 7-ft tall at the Core. TransHab is 23 feet from inside bulkhead to inside bulkhead (not including the 7-ft long Level 4 pressurized tunnel). This module is packaged and launched in the Space Shuttle for delivery to the space station. After the Orbiter docks with station the TransHab is removed from the Orbiter payload bay and berthed with station. Once captured on station the TransHab is deployed and inflated to its internal operating pressure of 14.7 psia. Following inflation of the module, systems are activated for conditioning the environment for crew entry and outfitting.

Because TransHab is a prefabricated, packaged and deployed habitat, it requires the crew to perform setup and outfitting activities in order to make it operational.

Level One

Level one incorporates the galley, wardroom and soft stowage area. This level has three ISS galley racks, a large wardroom table, an Earth-viewing window and a soft stowage array that incorporates ISS standard collapsible transfer bags (CTB), figure 5 and 6.

A unique aspect about this area is that it includes a clerestory above the wardroom area. The clerestory (two story opening) was created in response to the psychological and visual creation of open space. This is very important for crew moral and productivity during long duration isolation and confinement in space.

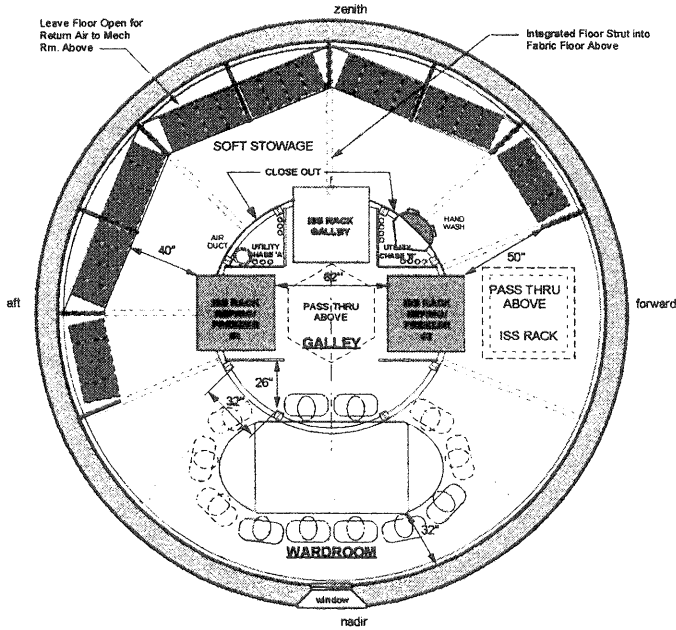
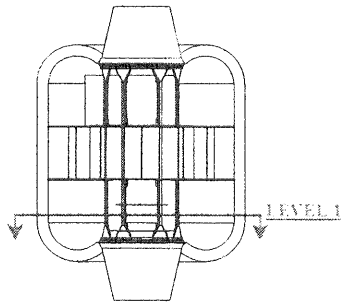

Figure 5. TransHab Level 1 Top View

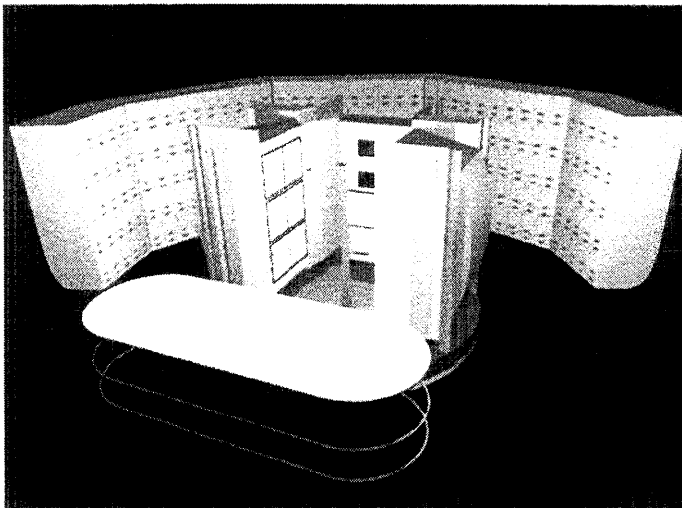

Figure 6. TransHab Level 1 Galley/Wardroom Area CAD image

Level Two

Level Two is composed of the mechanical room and the crew quarters (C.Q.). The crew quarters area has six crew quarters and a central passageway located within the second level central core structure and water tanks. The

Mechanical Room is external of the core structure and uses only half the floor space. The other half of this area is the clerestory above the wardroom area, figure 7 and 8.

The crew quarters are surrounded by a 2.5 – 3” thick water jacket for radiation protection during solar flares. Access to this area is from Level 1 (below) or Level 3 (above), via the 42” central passageway. The shown configuration will be assembled and outfitted after TransHab’s inflation. Launch shelves are used as crew quarters partitions and the crew quarter door panel and door are installed on-orbit. Rack based crew quarters equipment from the Node 2 will be moved into the TransHab crew quarters.

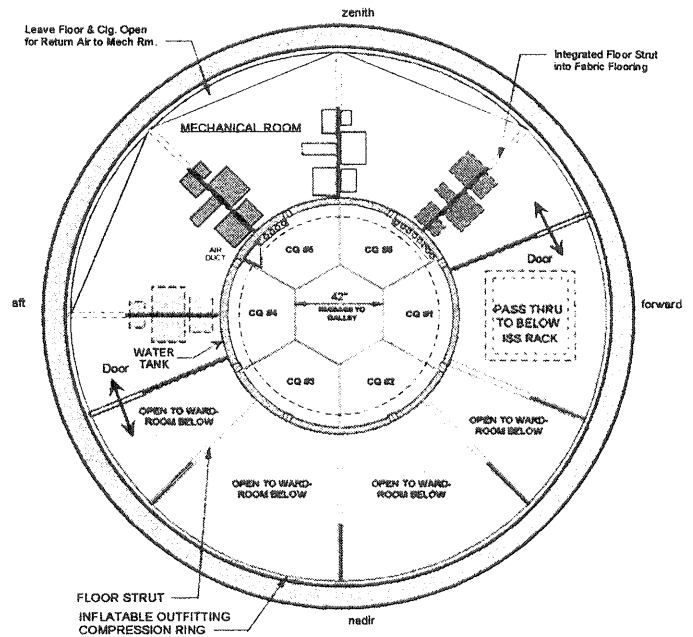
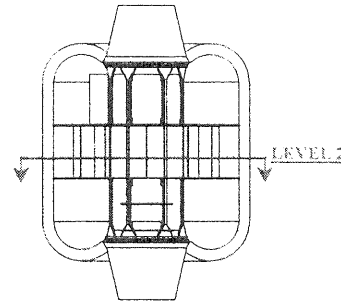

Figure 7. TransHab Level 2 Top View

Each of the crew quarters is $\approx 81.25\text{-ft}^3$ of volume (C.Q. 5 & 6 are less) and has a full height of 84”. This is $\approx 27\%$ larger than the ISS Rack-based CQ (flush face) which is $\approx 64\text{ c.f.}$

Each C.Q. will have personal stowage, a personal workstation, sleep restraint, and integrated air, light, data and power, figure 8. An integrated soffit at the top of the crew quarters contains the ductwork, and power and data cables that feed the work station area. The acoustic wall panels will be designed for cleanability and change out.

This change out capability could allow new crew members to bring “personalized” panels to decorate their crew quarter according to personal taste. Studies and research on long duration isolation and confinement have shown this concept and larger private crew quarters to have a very positive impact on crew moral and productivity.

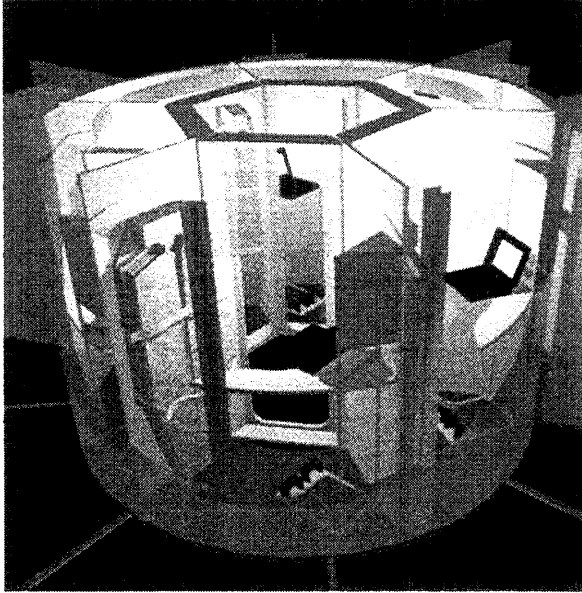

Figure 8. TransHab Crew Quarters CAD Image, JSC S99-05359

Level Three

Level Three is the crew health care and soft storage area. The crew health care area incorporates two ISS Crew Health Care System (CHeCS) racks, a Full Body Cleansing Compartment (FBCC), changing area, exercise equipment (treadmill and ergometer), a partitionable area for private medical exams and conferencing, and an Earth-viewing window, figure 9. Also included on this level is a soft storage area identical to level one.

The exercise equipment are permanently mounted in their deployed position, figure 9. This will save crew time in the deployment and stowage of exercise equipment on a daily basis. Placement of the exercise equipment is synthesized with the window location to allow the crew Earth viewing during exercise. Two launch shelves are placed on the floor struts as exercise equipment mounting platforms and structural integration.

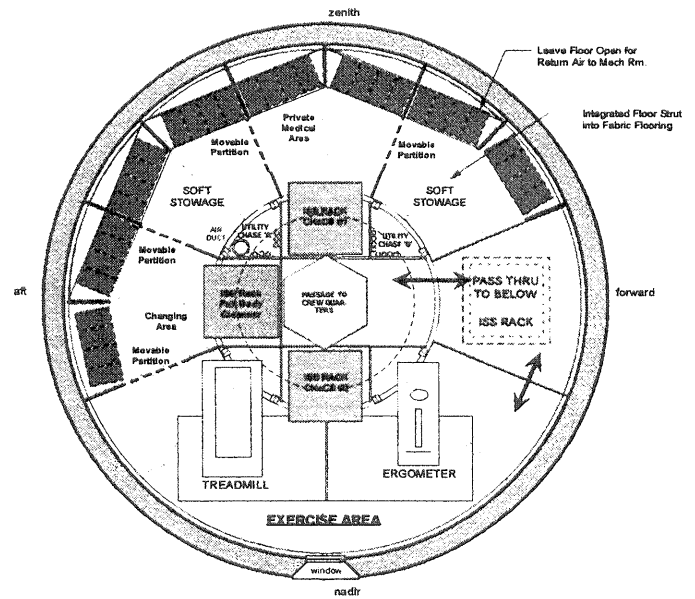
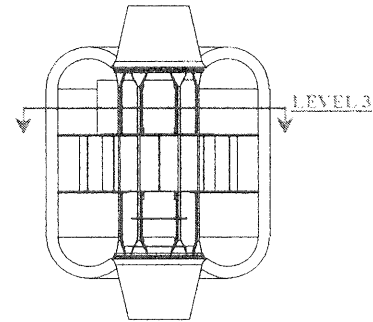

Figure 9. TransHab Level 3 Top View

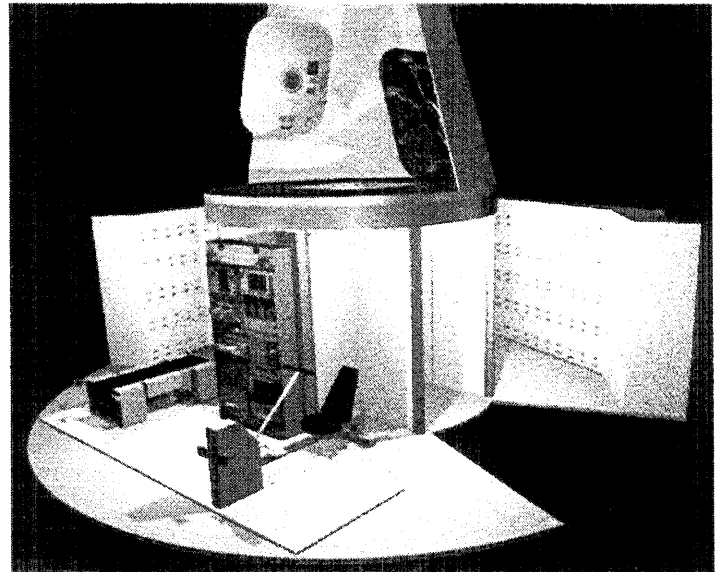

Figure 10. TransHab Level 3 CAD Image

Level Four

Level Four is the pressurized tunnel area. It has two station standard hatches, avionics and power equipment. Its function is to 1) provide a “transition” between Node 3

and TransHab, 2) house critical equipment required during inflation, and 3) provide structural connection to space station. It is the only pressurized volume in TransHab during launch. The packaged central core will vent during launch to a vacuum state until TransHab is inflated. Once TransHab is berthed and bolted to Node 3, Level 4 provides immediate access to the vestibule area between Node 3 and TransHab. This will allow the critical power and data vestibule connections to enable initiation of the deployment and inflation operations.

TRANSHAB STRUCTURE

TransHab has a unique hybrid structure that incorporates an inflatable shell and a central hard structural core, figure 11. This unique hybrid structure combines the packaging and mass efficiencies of an inflatable structure and the advantages of a load carrying hard structure.

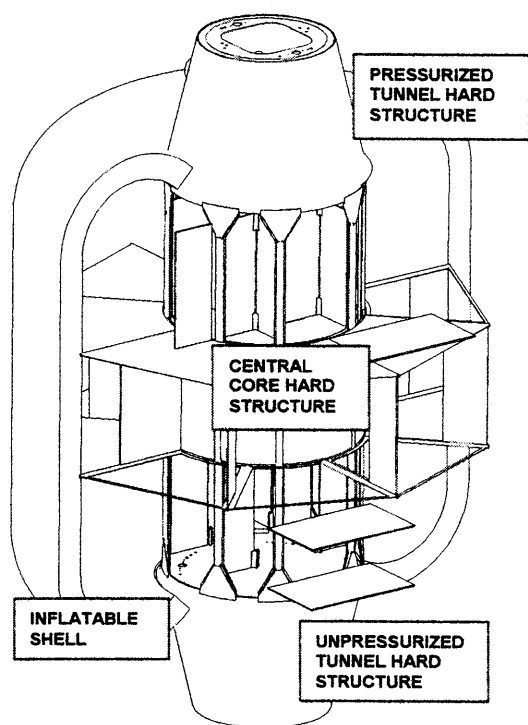

Figure 11. TransHab Structure

Central Core Structure

The central core structure is the hard structure that is comprised of the longerons, repositionable launch shelves, bulkheads, radiation shield water tanks, utility chases (2), and integrated ductwork. The inflation system and tanks are incorporated into Level 0, the unpressurized tunnel.

The launch shelves are placed into the central core for launch. There are 36 shelves in two different sizes: a) 30" x 84" and b) 50" x 84". About half of the shelves are repositioned once on-orbit and the others remain in place, figure 12.

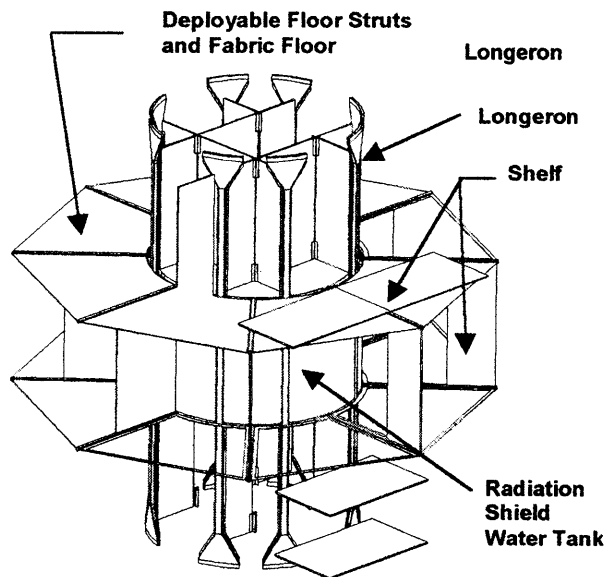

Figure 12. TransHab Deployed Core Structure

Inflatable Shell Structure

The inflatable shell is composed of four functional layers: the internal scuff barrier and pressure bladder, the structural restraint layer, the Micrometeoroid/orbital debris shield, and the external thermal protection blanket, figure 13.

Key Structural Features

- **Composite Longerons:**
The longerons provide the primary load path through the core reacting to both pressure loads and launch loads. They are 23 feet long with flares at each end to attach to the bulkheads.
- **Radiation Storm Shelter and Crew Quarters for Six**
The crew quarters are located within Level 2 central core annular water tanks. The water tanks provide a safe haven in the event of a solar flare. The water tanks are sandwiched between inner and outer shear panels that are structurally connected to the longerons.
- **Light Weight Launch Shelves**
For ground operations and launch, these shelves provide structural support and lightweight equipment mounting for pre-integration. For launch they are locked into position in the central core for TransHab launch loads. Once TransHab is deployed, approximately one half of the shelves are relocated into the habitat volume to support floor beams and equipment. The shelves are designed with dual use in mind—primary and secondary structure.
- **Multi-Layer Shell**
The inflatable shell is the TransHab's primary structure. Folded and compressed around the core at launch, it is

deployed on orbit. The shell contains the crew's living space, provides orbital debris protection and thermal insulation.

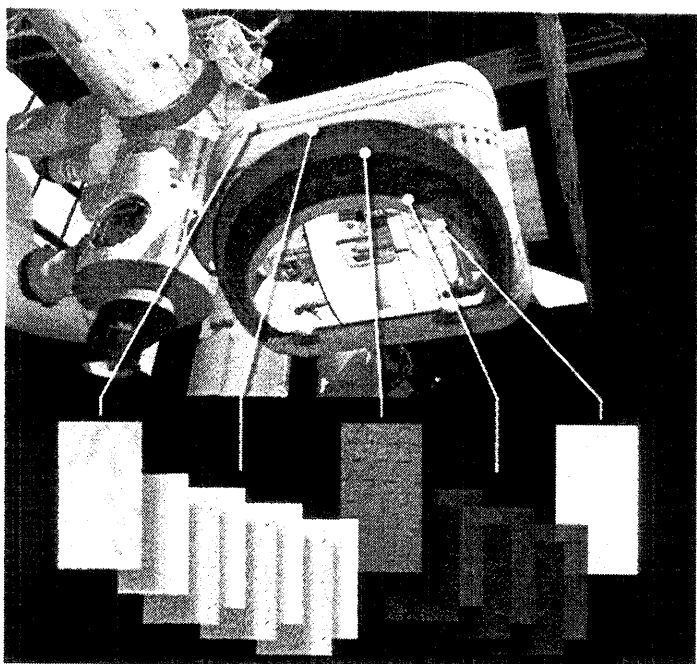

Figure 13. TransHab Shell Multi-Layers NASA JSC S99-05362

- **Micro-Meteoroid Orbital Debris Protection (MMOD):** Particles hitting at hyper velocity impact expend energy and disintegrate on successive Nextel layers, spaced by open cell foam. Backing layers of Kevlar add an additional degree of protection. Still undergoing further development and testing, the configuration above (figure 14) has withstood impacts of up to a 1.7-cm diameter aluminum projectile fired at 7 km/s (15,600mph).

- **Restraint Layer:** Woven from 1" wide Kevlar straps, the restraint layer is designed to contain four atmospheres of air pressure. Each shell restraint area is structurally optimized for that area's load. In order to accomplish this, strap seams were developed achieving over 90% seam efficiency.

- **Bladder/Inner Liner Assembly:** An inner liner of Nomex provides fire retardance and abrasion protection. Three Combitherm bladders form redundant air seals. Four layers of felt provide evacuation between bladder layers (necessary for launch packaging).

Demonstration of Inflatable Shell

TransHab's design concept is based on a relatively unproven space inflatable structural technology. The team had to prove this technology would work and is safe. There were three important goals set to prove to skeptics that inflatable structures will work in space:

1. How to protect an inflatable structure from being ruptured by micrometeoroid and orbital debris impacts.
2. Prove a large diameter fabric inflatable structure can hold one atmosphere pressure in the vacuum of space with a Safety Factor of four.
3. Prove TransHab can be folded, packaged and then deployed in the vacuum of space.

Goal One

The first goal was achieved by building a typical shell lay up and performing Hyper Velocity Impact testing at JSC and the White Sands Test Facility. The one-foot thick orbital debris shield took shot after shot and kept passing—exceeding all expectations. Whereas testing continues, TransHab's shell has survived a 1.7-cm Aluminum sphere at hypervelocity of 7 km/second.

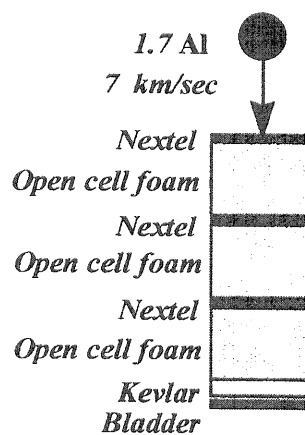

Figure 14. TransHab Orbital Debris Shield

Goal Two

Two shell development test units were built and tested at JSC to prove the second and third goals. The first test unit was to prove the inflatable restraint design would hold the 14.7 psia operating environment for the crew to live in. This unit was 23 feet in diameter by 10 feet tall. Since the hoop stress was being tested, it did not have to be full height. Figure 15 shows the test article being lowered into the large Neutral Buoyancy Lab pool.

A Safety Factor of four was used for this test; thus the restraint layer had to withstand the equivalent stress of four atmospheres. A hydrostatic test of four-atmosphere delta pressure was successfully performed in the Neutral Buoyancy Lab at JSC in September 1998.

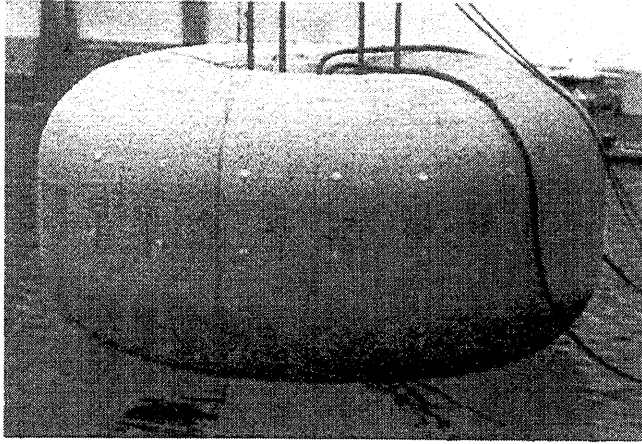

Figure 15. TransHab Hydrostatic Test

Goal Three

The second test unit was to prove the inflatable shell design could be folded and deployed in a vacuum environment. This test unit reused the hydrostatic test article bulkheads and rebuilt a full height restraint layer. Also included in this test was the orbital debris shield that was proven in the first goal. The one-foot thick debris shield is vacuum packed to reduce its thickness for folding to enable the module to fit into the Orbiter payload bay. Once on orbit, TransHab is deployed and the debris shield is released to its desired thickness. Figure 16 shows two technicians performing a final inspection of the test unit before folding the unit. TransHab was successfully folded and deployed in the vacuum environment of Chamber A in December 1998, proving the third goal.

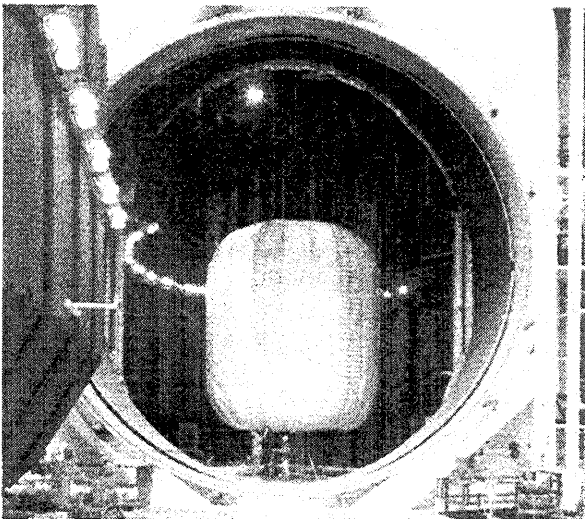

Figure 16. TransHab Vacuum Chamber Test

With the successful completion of the Hyper Velocity Impact testing and inflatable shell development tests, TransHab has proven that the inflatable structure technology is ready for the space age.

TransHab has made great strides to prove inflatable structures technology is ready to be applied as habitats for space applications. ISS TransHab's design meets or exceeds habitation requirements for space station and it has put the "Living" into "living and working in space." TransHab is proposed as a replacement of the hard aluminum can habitat for the International Space Station. It would be launched as the last station element in late 2004, figure 17.

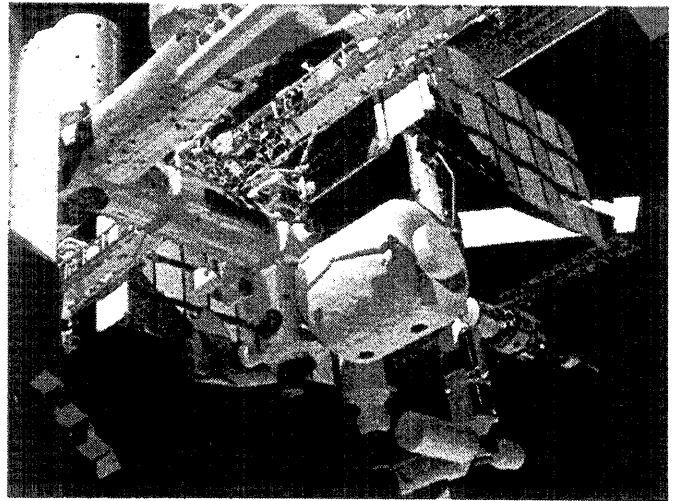

Figure 17. Proposed ISS TransHab on Space Station

When deployed on the International Space Station the TransHab will provide a habitable volume nearly three times larger than a standard ISS module; and yet it is launched on the Space Shuttle. TransHab provides facilities for sleeping, eating, cooking, personal hygiene, exercise, entertainment, storage, and a radiation storm shelter. TransHab also helps to develop, test and prove technologies necessary for long duration interplanetary missions.

This basic design and technology are appropriate for space and planetary surface habitats. Technologies developed for TransHab have multiple applications for both Earth and space. Technological advancement on material, manufacturing and deployment will continue to be developed, which will enable the design and manufacture of deployable greenhouse for use on other planetary bodies.

Mars Inflatable Greenhouses

When one thinks of growing plants for food we think about maximizing the crop yield per given growth area. This intuitively makes sense, produce the most edible mass per growth area. The scientists have studied and researched plant types and their growth environments that will yield the highest return. However these are under optimum

'controlled' conditions, with abundant power, an ample supply of nutrients, and human interaction to ensure success. These optimum conditions are being performed in "growth chambers."

A greenhouse and a growth chamber are two different systems; each performing the function of growing plants. A growth chamber is relatively small, self-contained and tends to be dedicated to a specific crop at one time. It provides the plants necessary nutrients, air, water, and light. Examples of a growth chamber range from a small desktop chamber growing a couple of plants to larger human-tended pod the size of a 55-gallon drum. Growth chambers, due to its very use and size, do not have to be a human-rated pressure vessel/system. As such it should not have to meet the verification, reliability or failure redundancy as it would if it is human-rated.

A greenhouse on the other hand is a larger facility that a human would walk into to tend a larger variety of crops on a larger production scale. A greenhouse also has to provide the plants' necessary nutrients, air, water, and light. An example of a greenhouse ranges from the one used by Nigel Packham in the 90-day CELSS test at JSC to large covered facilities such as those used at the South Pole. The biggest impact to a greenhouse design is that it is a pressurized space system that will have to meet the human-rated requirements and subsequent testing. This will impact the greenhouse design, mass and costs. An underlying assumption about a Mars Greenhouse is that it will be an inflatable structure in order for it to have a low mass and yet provide a large pressurized volume(s) on the surface. As such it needs to have a high packaging ratio when stowed and be easily deployable.

Inflatable structures are in fact tensile fabric membrane pneumatic structures. As such they are inflated by air or a fill material to stress the membrane in tension. There are three basic pneumatic structure types:

- 1) Air Inflated: a multi-layer composite membrane that is inflated by internal pressure (fig. 18), i.e. TransHab.

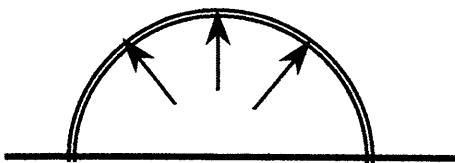

Figure 18. Air Inflated Pneumatic Structure

- 2) Air Supported: a multi-layer dual membrane cavity or air beams that rely on air pressure in the cavity wall to maintain the volume (fig. 19) with a resulting volume that can be pressurized at a lower pressure or not at all.

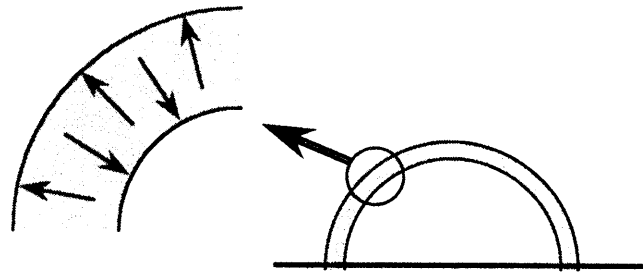

Figure 19. Air Supported Pneumatic Structure

- 3) Rigidized: a multi-layer single or dual membrane that relies on change-of-state in materials to rigidize the shell or beams upon deployment (fig. 20) with a resulting volume that can be pressurized at a lower pressure or not at all.

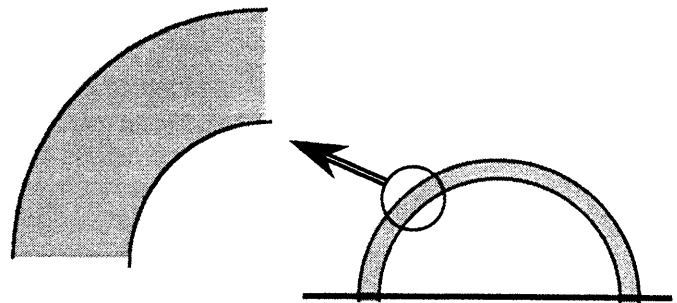

Figure 20. Rigidized Pneumatic Structure

Greenhouse Requirements

The functions of an inflatable greenhouse are to provide an environment to grow plants and interface with equipment, provide life support, robotics and human interfacing. From this a strawman list of requirements can be derived as a starting point. Whereas these requirements are not all inclusive, they do provide a beginning point for Mars Greenhouse design.

- Provide low internal pressure: 3 –5 psia (to be verified).
- Provide tbd c.f. (c.m.) growth area per crewmember per tbd% food supplement.
- Provide pressure vessel enclosure
- Provide secondary structure to support equipment and plant growth systems.
- Provide Environmental Control and Life Support: air distribution and collection, water and thermal conditioning.
- Provide communications: human to human, human to machine/system.
- Provide command and data handling.
- Provide a transition space (airlock) for crew and equipment into greenhouse.
- Provide lighting: natural and artificial, tbd fc.

- Provide external structural interfaces to other pressurized vessels (modules).
- Provide external power interface to power supply and/or other pressurized vessels (modules).
- Provide external data interface to data supply and/or other pressurized vessels (modules).
- Provide external thermal interface to thermal supply and/or other pressurized vessels (modules).
- Provide external water interface to water supply and/or other pressurized vessels (modules).
- Provide external gaseous oxygen and nitrogen interface to oxygen and nitrogen supply and/or other pressurized vessels (modules).
- Provide external wastewater interface to waste water return and/or other pressurized vessels (modules).
- Provide external communication (audio/video) interface to other pressurized vessels (modules).
- Provide tbd robotic system interfaces, i.e. grapple fixture, etc.
- It shall have integrated subsystems.
- It shall be easily deployed and assembled. Requiring less than tbd watts for deployment, has a mass less than tbd lbs. (kg), requires less than tbd EVA/IVA crew members hours to become operational.
- Provide tbd radiation protection.
- Provide tbd micrometeoroid and/or dust storm protection.
- Provide tbd % natural sunlight to enter through into the greenhouse interior.

Materials

Composite inflatable structures require three principal components or materials. The first component is for structural (load bearing) purposes, and is usually comprised of high tenacity fibers to react stresses associated with the structure. The second component is an impermeable gas barrier or liner needed to minimize air loss inside the module. The final component is a joining or matrix material whose function is to maintain alignment of the other components, particularly while folded and during deployment, and, while pressurized, to transfer loads between structural elements by inter-laminar shear.

Several joining techniques are employed for inflatable structures, including stitching at fiber intersections, adhesives, and use of braiding to restrain movement of adjacent fiber members. Choice of stabilization technique/material exerts a significant influence on the complexity of the subsequent fabrication task and on the performance of the final product.

The following set of material selection criteria should be considered to assist in selection of all materials for the an inflatable greenhouse:

- High strength-to-weight;
- Minimal Creep at working pressure for 10 - 15 year service life;
- No weakening when folded for extended periods (months);

- Negligible degradation in expected environment.

The tensile structure concept, the flexible matrix materials, and the full-scale manufacturing method must clearly be mutually compatible. The relationships between requirements and concept compatibility are diagrammed in figure 21 (Brown, Harris).

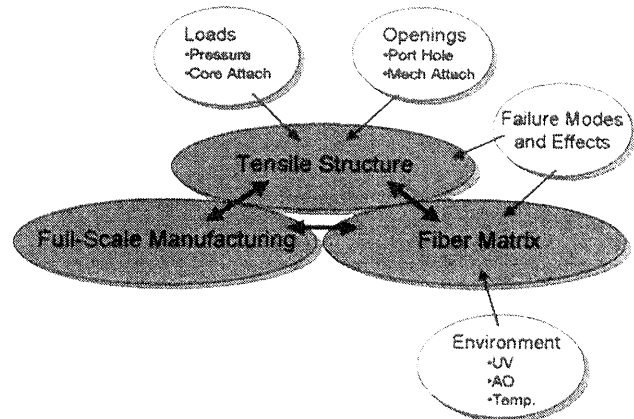

Figure 21. Inflatable Structure Relationship Diagram

Strength is not the only consideration, however. The lifetime anticipated for ISS is 10-15 years. Creep in the structural component over this lifetime must be minimal. When most textile fibers are subjected to load, they suffer three kinds of distortion:

- Elastic Deformation: closely proportional to load and fully and instantly recoverable upon load removal.
- Primary Creep: Increases at a decreasing rate with time and which is fully, but not instantaneously recoverable with time following load removal.
- Secondary Creep: varies in an obscure manner with time and load and is completely non-recoverable upon load removal.

Potential fiber choices that provide tenacity exceeding 22 gram/denier for flexible composite structures include most of the current generation high tenacity fibers, such as Kevlar™, Technora™, and Vectran™. The superior abrasion resistance demonstrated by Vectran™ during folding/unfolding cycles coupled with high tenacity combine to make Vectran™ the current leading candidate. This material has also exhibited excellent resistance to long term radiation damage.

Significant additional work remains to be accomplished before a determination of optimum materials can be made; however, the results to date appear exceptionally promising. Development of flexible composite structures from these materials will enable creation of large enclosed volumes for a variety of space missions with minimal mass and volume penalty incurred during the launch process

Interfaces

An important feature of any pressure vessel is the use of interfaces to connect to other pressurized vessels (modules) as well as utilities. There are both internal and

external interfaces. These interfaces are critical to overall system's capability and performance. Not only are fluids, data, power, etc passed through the interfaces, but also are the internal connections to the plant growth systems. The more interfaces required the higher the risk of potential failure areas and/or leaks (fluid or gas). Use of known and approved space qualified hardware will reduce the risk of failures. However, these items are costly and tend to be heavy. Interface connections play an important role of an inflatable greenhouse and should be identified early and resources allocated accordingly. Pay attention to line length limits and bend radii.

Subsystems

Greenhouse subsystems include its structure, avionics, environmental control and life support (ECLSS), power management and distribution, crew accommodations, and plant growth system.

The greenhouse structural system will include the pressure vessel, connection ports, ground/anchoring interface, radiation protection, micrometeoroid/sand protection, and internal secondary support structure. The design of these items will depend on evaluation selection criteria of cost, schedule, performance and risk. Optimizing a system concept will take several trade studies with a clear set of assumptions, constraints and requirements.

The avionics subsystem includes the communications, and command & data handling. The communications has both the audio and video. Also included is the caution and warning system. If crew are going to be inside then every precaution will be taken to protect them and ensure their safety. The command & data handling can run off the habitat's main computer or provide a secondary tier for control of the greenhouse. In either case, software commands and data control, retrieval and storage will be a function of this subsystem.

A greenhouse's ECLSS system can either rely on the main habitat's ECLSS, provide it's own, or a combination thereof. The ECLSS subsystem includes the collection and distribution of air, water, waste, and thermal control. Based on the mission objectives, trade studies should be performed to optimize the ECLSS performance for the lightest mass and most efficiency power consumption.

Power generation and storage will be a part of the surface base infrastructure, so the greenhouse power system will include the management and distribution of power to the other subsystems and plant growth systems. This subsystem will include the power switching, relays, wiring harnesses and connectors. Control of the power allocation can be done in the computer or at the switching equipment by use of firmware controllers. The big unknown about the greenhouse power is the quantity of power required and subsequently the massive amount of cabling.

Since the greenhouse will have crew personnel interacting within the pressure vessel there will be the need for a crew accommodations subsystem. This ensures human factors design is considered, as well as restraints and mobility aids, lighting for crew and repair tasks, human to machine interfaces for maintainability and repair of equipment, and the interaction of crew and crops.

The plant growth subsystem will vary depending on the mission objectives and growth rate requirements. The basic system would include plant holding, plant nutrient distribution and collection, lighting, and air circulation.

Each subsystem can be optimized for its own performance, but as a whole they have to work together in harmony to produce the desired design at a reasonable cost, schedule, performance and risk.

Transition Spaces / Airlocks

When crew and/or equipment move from one pressurized environment to a different environment then a transition space is needed. These spaces are typically know as airlocks, but other types of spaces can serve a similar function. An airlock is the extreme example of a transition space since it is taking you from a 14.7 psia environment to a vacuum. The Apollo Lander did not use an airlock. It vented the entire cabin to vacuum. Where as this worked for a small environment and short mission; it is not recommended for long term surface habitats and greenhouses.

Examples of other transition spaces are vestibules and pressure chambers. A pressure chamber could also be considered an airlock depending on its purpose and function. A vestibule allows crew to lower or increase pressure between the spaces by manually opening a valve to equalize the pressure or by opening the door (hatch).

Concepts

There are numerous concepts of growth chambers and inflatable greenhouses; and there are many more to be invented and created. At this point in time, there is no one best solution. Numerous point designs should be embraced and then evaluated based on a prioritized set of selection criteria. Often the final design that gets built is a hybrid of many ideas and concepts.

The 'TorDome' is but one of many ideas by this author. It is an inflatable structure that combines both a high-pressure (8.3 – 10.2 psia) environment for the humans and a lower pressure (3 – 5 psia) environment for the plants. An 8'-10' (2.43 – 3.04 m) inner diameter torus circumscribes the larger low-pressure domed greenhouse at the ground level, figure 22. By splitting the functions of the human area and the greenhouse area the inflatable structure can be optimized and thus more efficient and lighter.

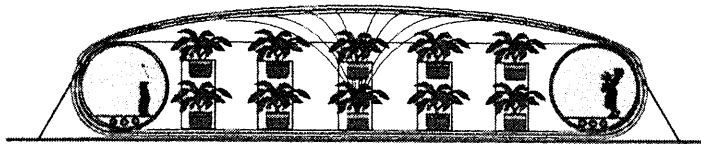

Figure 22. Inflatable Greenhouse Concept

The torus section incorporates the port interface to an airlock or habitat, utility interfaces and distribution, human viewing ports and workstations for monitoring and tending the crops. The dome section encapsulates the torus and provides the plant growing area. The optimum size and shape is to be determined. However, the basic shape of a Quonset style elongated cylinder may prove volume efficient for plant growth, fig. 23.

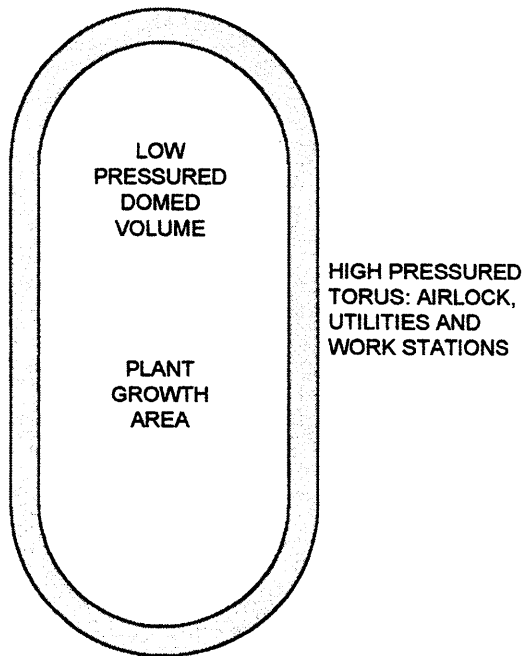

Figure 23. Inflatable Greenhouse Concept

A portion of the dome's roof could be designed to allow natural sunlight to enter into the greenhouse, fig. 24. The percent of roof opening and translucency will have to be determined based on material availability, structural integrity and plant growth rate. The technological challenge is to develop a 100% translucent bladder. The plants growth scientists would like 100% of the solar capability at the Mars surface, which is about half of what the Earth gets. The purpose of providing natural light is that this will reduce the lighting needed during the grow time. This will drop the power required and thus the overall mission mass due to reductions in power generation and storage. However, there are other concerns with a translucent bladder. One, it will not have the structural strength to with hold the 3-5 psia and thus will require some sort of restraint system. This will further reduce the amount of light getting through. Two, there is not a 100%

translucent bladder materials available that are space qualified. Three, it will allow a large thermal loss to the Mars atmosphere, thus rendering the greenhouse interior cold.

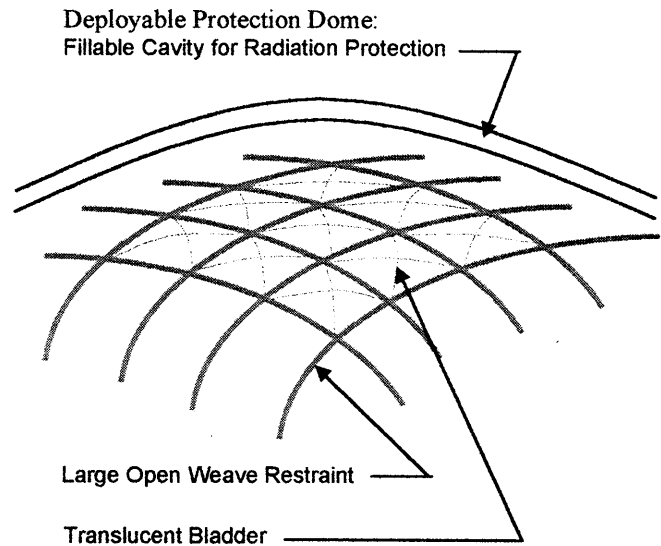

Figure 24. Inflatable Greenhouse Shell Concept

A deployable protection dome could achieve radiation and thermal protection. This concept is an external cavity shell (separate from the bladder/restraint shell) that can be filled or flooded with water when protection is desired during the night or intense solar activity, fig. 24. This protective shell would include the multi-layer insulation (MLI) and protective beta cloth. Section of it can be left open (no MLI/Beta) to allow the natural sunlight to enter through. This idea has some advantages and disadvantages. The advantages are 1) you can control or section the areas (flood) that you want protection; 2) You can vary the thickness of the protective layer; 3) you can use a variety of fluids/materials to fill the cavity; 4) It can be folded, packaged and deployed void of the fill; and 5) it can make use the in-situ water supply on Mars. Disadvantages include 1) it will reduce the translucency of the 'openings' for natural sunlight; 2) it will require ports, valves and fill lines; 3) it may have to be kept warm to keep the fluids from freezing; and 4) unknowns about maintenance and repair. This idea of a deployable protective dome and the 'TorDome' is very preliminary and requires a lot more design and analysis before it should be considered feasible.

SUMMARY

There are several points to summarize from this paper.

1. **Lower Mass:** The overall greenhouse mass should be designed to be light as possible. A shell mass metric of 1.5-3 kg/m³ volume deployed should be considered and an overall system mass of 10-20 kg/m³ should be strived for.

2. **Less Power:** Use of natural sunlight should be studied and traded against mass savings in reduced equipment and power systems. Every kg saved on the Mars surface has enormous savings in launch mass from Earth-to-Orbit. Other concepts such as fiber optic sunlight delivery systems should also be traded in mass savings.
3. **Efficient Lighting:** Development of higher output efficiency, robust and safe lighting is important to the success of greenhouse capability in food production. The emerging technology of Light Emitting Diodes (LED) integrated into solid state lighting systems is very promising for growth chambers and greenhouses.
4. **Genetically Engineered Plants:** The impact of this technology on greenhouse design and food production efficiency is tremendous. If plants can be engineered for maximum output at less than optimum conditions this will reduce the water, nutrients, light and growth area that is required. Thus reducing the system mass.
5. **Heat/Thermal Sharing:** Often we think about having to keep the greenhouse warm, when in fact we usually are trying to cool them off. There will be a delicate balancing act between the amount of heat given off by the internal lighting and systems, the amount lost through the inflatable membrane and the amount needed by the plants. One should consider a technologies that collects, distributes and exchanges the waste heat produced by the internal systems to keep the greenhouse environment in a optimum growing temperature.

In summary, there is much research to be done on the plant growing systems before optimally design

greenhouses can be considered. Parametric trade studies should be performed, which will help flush out the driving requirements, issues and technologies that inflatable greenhouses will rely on in the future. However, it is premature to begin designing greenhouses when there are so many unknowns about the plant growth systems and environments needed to sustain a productive and healthy crop.

CONTACT

For more information about the ISS TransHab please contact NASA Johnson Space Center's Public Affairs Office.

REFERENCES

1. Brown, G. & Harris, P. (Oct., 1998) *SBIR Advanced Habitats Phase I Final Technical Report*. Vertigo, Inc. Report Document #2000-11-0001, Lake Elsinore, CA.
2. Kennedy, K.J. (1999) *ISS TransHab Architecture Description*. Proceedings of the 29th International Conference on Environmental Science (ICES); paper #1999-01-2143. Society of Automotive Engineers, Warrenton PA
3. Kennedy, K. and Harris, P. 2000. "Wound Construction of Inflatable Space Structures." SPACE 2000: Engineering, Construction, and Operations in Space Conference. Published by ASCE
4. Kennedy, K. and Adams, C. 2000. "ISS TransHab: An Inflatable Habitat." SPACE 2000: Engineering, Construction, and Operations in Space Conference. Published by ASCE
5. Kennedy, K. and Capps, S. 2000. "Designing Space Habitation." SPACE 2000: Engineering, Construction, and Operations in Space Conference. Published by ASC
6. Man-System Integration Standard, Vol. 1, NASA STD-3000, Rev. B (1995). NASA-Johnson Space Center, Houston, TX.

Development of an Inflatable Greenhouse for a Modular Crop Production System

J. M. Clawson

Ph.D. Candidate

Aerospace Engineering Sciences

University of Colorado, Boulder

Introduction

Plants offer the greatest opportunity for self-sufficiency and possibly cost reduction, in the form of lower equivalent system mass (ESM), for long duration missions (Drysdale and Hanford 1999). Self-sufficiency is perhaps the greatest advantage of a plant-based bioregenerative system enabling it to handle contingencies for degraded and/or extended missions. Plants have the unique ability to provide for food regeneration and they can also provide redundancy to physicochemical (PC) air and water regeneration. Further, the redundancy they provide is dissimilar to PC systems rather than multiples of the same technology, which reduces risk from an inherent flaw in a particular technology found far from home. However, missions are sold based mainly on cost, which in this case relies on mass. Therefore, plant-based systems first have to compete on the basis of their equivalent system mass (ESM)

Mass is one of the primary drivers for Mars mission costs since it is such a dominant driver in propulsion and launch vehicle selection (Drake 1998). As a result, reduction of equivalent system mass (ESM) is at the core of the primary metric by which NASA measures advanced life support (ALS) technology development. ESM is a method of comparing different options for system architectures, particularly where the technologies employed vary significantly. Conversions, based on spacecraft and mission architecture, are used to calculate equivalent masses for commodities such as power, thermal rejection, and spacecraft volume (Drysdale and Hanford 1999). The ESM method is not limited to evaluating the particular system in question, but also evaluates the impact to other systems such as replacement of them or redundancy to them. For example, if more than about 25% of the food is produced locally, all the required water can be regenerated by the same process and at 50% or more, all the required air can be regenerated (Drysdale, Beavers et al. 1997).

The following investigates the potential benefits of spaceborne greenhouses to plant research aboard the International Space Station (ISS) and to the viability of plant-based bioregenerative life support systems for long duration space mission. Existing space plant growth units for use on the Shuttle and ISS are restricted in size, which can limit the scientific return on the research conducted in them. For life support, current structures and methods proposed for space mission crop cultivation are mass, power, and volume intensive resulting in a high equivalent system mass (ESM), which restricts their use to all but the longest duration missions.

As on Earth, greenhouses for space missions offer an efficient method to use direct solar illumination through their transparent structures. A spaceborne greenhouse would reside external to the crew habitat pressurized volume (spacecraft or surface habitat) and use the natural solar illumination for all or part of the lighting needs for plant growth. It is proposed that this can reduce the equivalent system mass (ESM) of crop production systems by eliminating the use of spacecraft internal pressurized volume and by reducing power and heat rejection resources that would otherwise be needed for total artificial lighting. Furthermore, placing these structures in the space or extraterrestrial surface environment produces a natural difference in pressure that can take advantage of mass-saving inflatable structure technology. Finally, rating the internal environment and external structure for plants only permits the use of lower pressures and reduced factors of safety, which reduces leakage rates and further reduces mass.

Existing Spaceflight Plant Growth System Concepts

The last decade has seen the maturation of technology for closed system plant growth during space flight. Several plant growth systems have been developed, see Figure 1, and either have been or will be operated on orbit from days or weeks to months at a time (Hoehn, Clawson et al. 1998). Much effort has been directed toward selecting and qualifying technologies for various subsystems that enable precise control over CO₂, temperature, humidity, and scrubbing of harmful contaminants from the atmosphere. The goal of these efforts is to maintain a proper physiological environment for the plants. The Plant Generic Bioprocessing Apparatus (PGBA), built and operated by BioServe Space Technologies at the University of Colorado, is the latest entry to the group of space flight plant growth chambers to demonstrate on-orbit operation. The design of PGBA has benefited from lessons learned on earlier plant hardware efforts such as Plant Growth Unit (PGU), Astroculture™ (ASC), Plant Growth Facility (PGF), and even the Russian SVET greenhouse. These lessons will be further built upon by the Biomass Production System (BPS) and the Commercial Plant Biotechnology Facility (CPBF) that are currently under various levels of development at Orbitech, Inc., and the Wisconsin Center for Space Automation and Robotics (WCSAR), respectively.

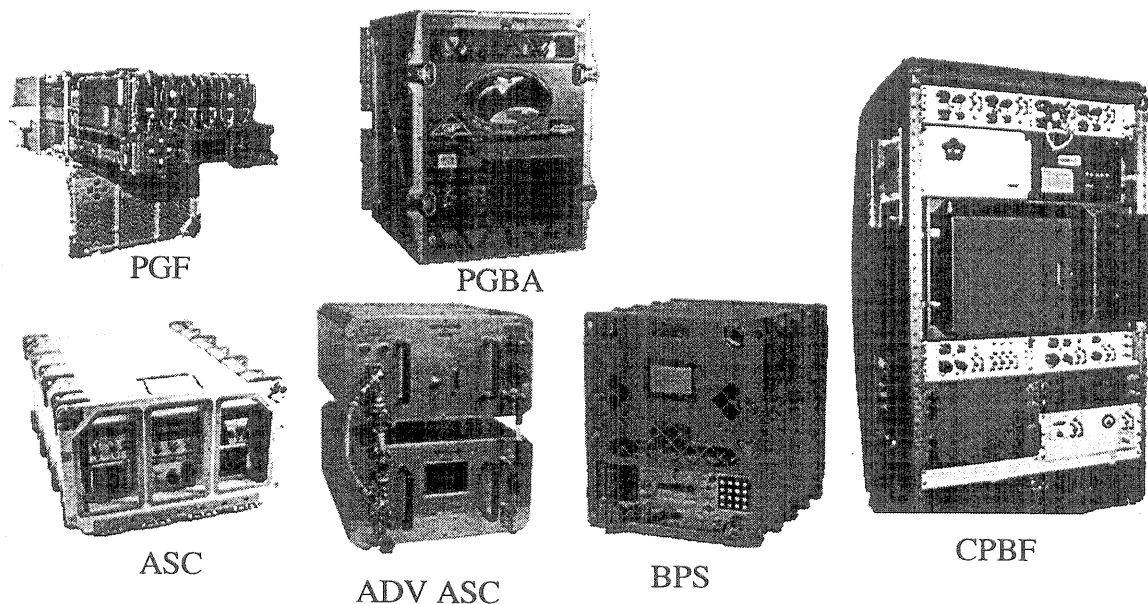

Figure 1. Existing space plant growth facilities either operational or under development.

Despite the advances made in the design of these facilities, limited volume, power, and heat rejection resources restrict their capabilities. The volume limitations are a result of the constraints imposed on payloads residing within the interior of the pressurized modules of a spacecraft such as the Shuttle or the International Space Station (ISS). Pressurized volume is expensive, in terms of ESM, and is difficult to obtain given the numerous disciplines all vying for it. As a result, obtaining valid experimental results is difficult due to the small number of repetitions currently available within the latest and even next generation hardware. This constraint can slow the progress of basic plant gravitational biology and life support application research and make it difficult to attract commercial plant biotechnology concerns to space research.

The efficient use of allocated volume is important to obtaining the most out of any payload. For a plant growth payload, it is important to look at the percentage of total payload volume that was allocated to plant growth, or what can be termed as plant payload volume

efficiency (PPVE). Figure 2 shows the PPVE for each of the existing space plant growth units. Generally, as the total payload volume increases, so does the PPVE (Figure 2 (right)), indicating that the volume taken by the subsystems of the payload does not scale linearly with plant growth volume. This makes sense, for example, in the case of the computer systems where the same size computer could operate any of the payloads regardless of their physical size.

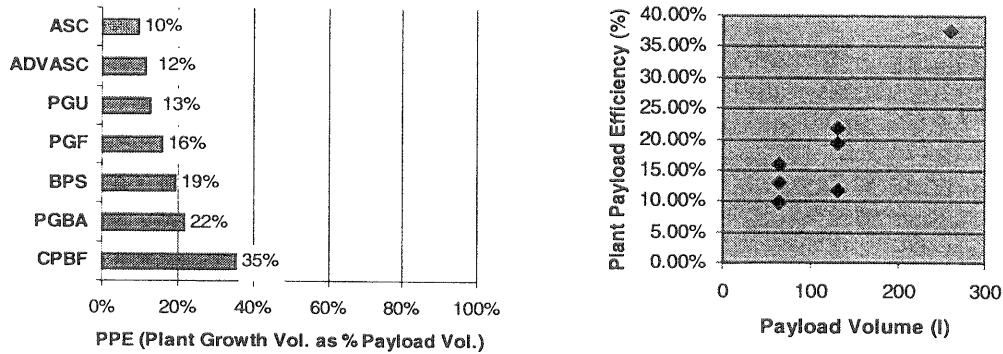

Figure 2. The volumetric efficiency, PPE, of current and proposed space flight plant growth units (left) and plant payload volume efficiency versus total payload volume (right). (ASC – Astroculture; ADVASC – Advanced Astroculture; PGU – Plant Growth Unit; PGF – Plant Growth Facility; BPS – Biomass Production System; PGBA – Plant Generic Bioprocessing Apparatus; CPBF – Commercial Plant Biotechnology Facility)

Mass is also an important parameter in the design of spaceflight equipment. With reference to plant growth units, it is important to know how much plant growth volume can be provided per kilogram of payload, or what can be termed specific plant growth volume (m^3/kg). Figure 3 shows the inverse of the specific plant growth volume, or the mass of a cubic meter of plant growth volume (kg/m^3), plotted versus the available plant growth volume for current space flight plant growth units. The mass is calculated as the total ESM calculated with the Mars outbound transit ESM conversions applied in order to enable comparison later. The total ESM for the system was then used to calculate the specific plant growth volume. As with volume efficiency, this parameter also improves with total payload volume. In other words, plant growth units become both more mass and volume efficient as they become larger. However, Figure 4 illustrates that these gains are most prominent for the transition from smaller payloads into larger facilities, although the extrapolation of this data to very large facilities is quite risky.

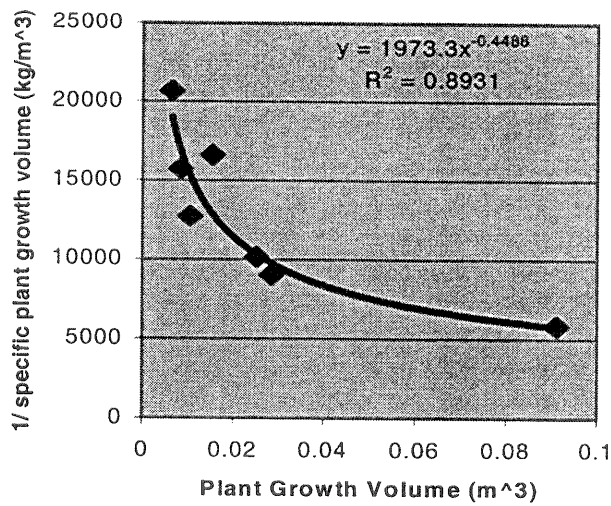

Figure 3. The inverse of the specific plant growth volume versus the available plant growth volume for current space flight plant units.

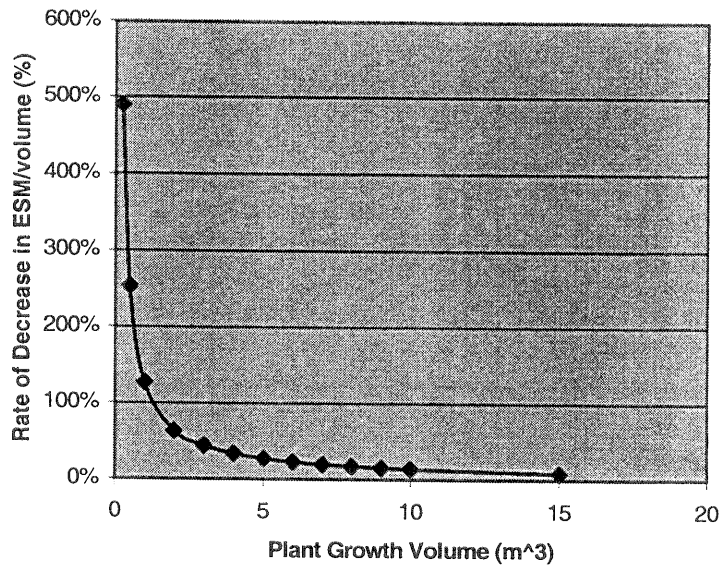

Figure 4. The rate of decrease in the inverse of specific plant growth volume versus plant growth volume. Large increases in mass efficiency can be made with small increases in volume in the smaller payload regime.

An Inflatable Greenhouse Concept

The Autonomous Garden Pod (AG-Pod) is an inflatable greenhouse concept proposed to extend the capabilities for plant research aboard the ISS as well as lower the equivalent system mass (ESM) for bioregenerative life support systems. This plant-only rated module resides external to the habitat pressurized volume and can use natural direct solar illumination. This reduces the ESM of crop production systems by eliminating the use of spacecraft internal pressurized volume and by reducing power and heat rejection resources that would otherwise be needed for artificial lighting. However, lowering of the crop production ESM is also achieved

from the use of lightweight structures including composite and inflatable technology. AG-Pod's baseline external structure incorporates an inflatable cylinder section capped on either end by rigid ellipsoidal end-caps, one transparent for harvesting direct sunlight. The unit can be stored in a small volume on launch or landing and, once in orbit, be deployed outside the vehicle. This maximizes the growing volume while minimizing launch volume.

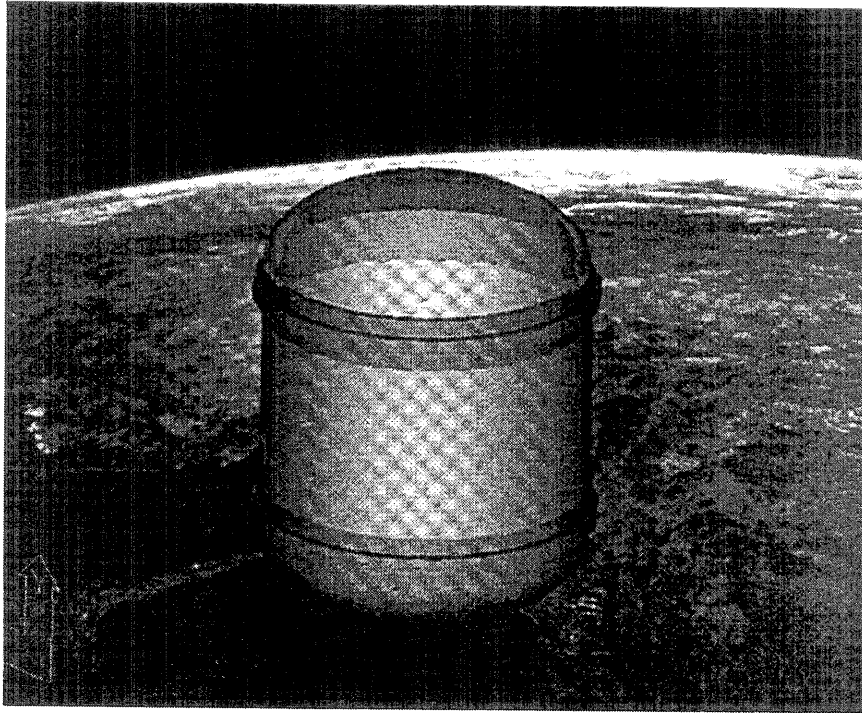

Figure 5. The AG-Pod concept incorporates a simple, collapsible cylindrical structure with rigid end caps. The forward end allows for solar or artificial illumination while the aft end houses the command and control and environmental subsystems.

One of the major innovations of the AG-Pod program is the concept of a modular crop production system (Clawson, Hoehn et al. 1999). This modular approach has many advantages over a single large greenhouse concept. The inherent redundancy of an interchangeable, modular system decreases cost, improves reliability, and adapts to meet varying system demands. With multiple units, the loss of a single unit by either crop infection or mechanical failure is not as critical to the overall system. For example, despite the elaborate disinfecting and quarantine protocols sometimes used in preparation for space missions, microorganisms have flourished aboard spacecraft. These organisms pose a moderate threat to the use of plants as part of an advanced life support system. Schuerger (1998) suggests isolating plant production systems into separate modules to mitigate the risk of crop loss due to pathogen infections. AG-Pod's modular approach isolates various crop elements from each other to avoid cross contamination. It also allows for customization of the growth environment to the particular part of the crop's growth cycle. Further, a group of units lends itself to more frequent batch harvesting, which can eliminate the need for long-term crop storage that can lead to spoilage. Finally, a system consisting of a number of similar or identical units with interchangeable parts decreases unit cost by allowing more economical manufacturing processes and amortizing nonrecurring costs over more units.

Furthermore, the exact configuration of future missions is yet undecided and is likely to go through many iterations prior to selecting that which is optimal. Modularity allows the system to be easily scaled to meet varying system demands or objectives. The simple addition or removal of a number of units can accommodate a variety of mission scenarios. Finally, a modular system, in Figure 6 for example, may permit the use of such crop units during the transit phase and then combine these with additional units on the surface to increase the system capability for the long surface stay.

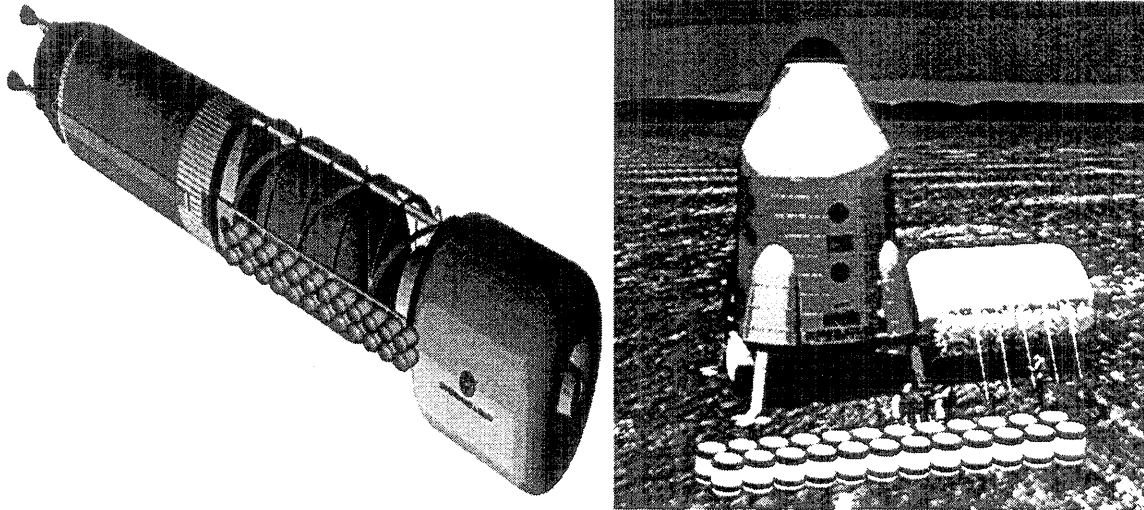

Figure 6. An array of AG-Pods could serve as a food supplementation/production system for Mars transit (left) and surface operations (right). [Background images from Reference Mission Version 3.0]

Growing plants outside of the pressurized volume of a spacecraft allows for greater growth areas and volumes as well as access to power- and mass-saving direct solar irradiance. The deployment of such units outside of the spacecraft conserves precious internal space for delicate experiments that need the pressurized environment and higher crew involvement. If needed, these units can also be stored externally between crops. The bulk of an AG-Pod system - power, thermal, structure, and environmental - can remain outside without taking up precious internal experiment or habitable space.

System Configuration

The original baseline is comprised of a structural subsystem that incorporates an inflatable cylinder section capped on either end by rigid end-caps, one being transparent for harvesting direct sunlight. Much of the overall concept for this structural subsystem was borrowed from the existing designs illustrated in Figure 7 (left), including the Shuttle Space Suit Assembly, the EMU helmet, the US Air Force's portable hypobaric chamber, and BioServe's Plant Generic Bioprocessing Apparatus (PGBA), all of which contribute technologies to the AG-Pod system. Relying on existing, proven technologies results in an initially high technology readiness level (TRL). However, application of newer technologies can increase the performance of the AG-Pod concept. Figure 7 (right) depicts an advanced concept in which the functions of the forward end-cap and flexible cylinder are combined into a single component fabricated from a transparent flexible material assembly. This greenhouse structure concept has the potential of dramatically decreasing ESM as well as improving packaging efficiency.

Since AG-Pod's structure does not require it to be rated for human occupancy, only 'plant rating' will be required. This rating can reduce the cost of design, parts, and, most importantly, the qualification - even as part of a bioregenerative life support system. For example, plants do not require as much radiation shielding as humans. Also, due to the built-in redundancy of a modular system, the loss of a single component should not adversely affect the overall system; therefore, a single unit can have less restrictive reliability margins, which generally reduces costs.

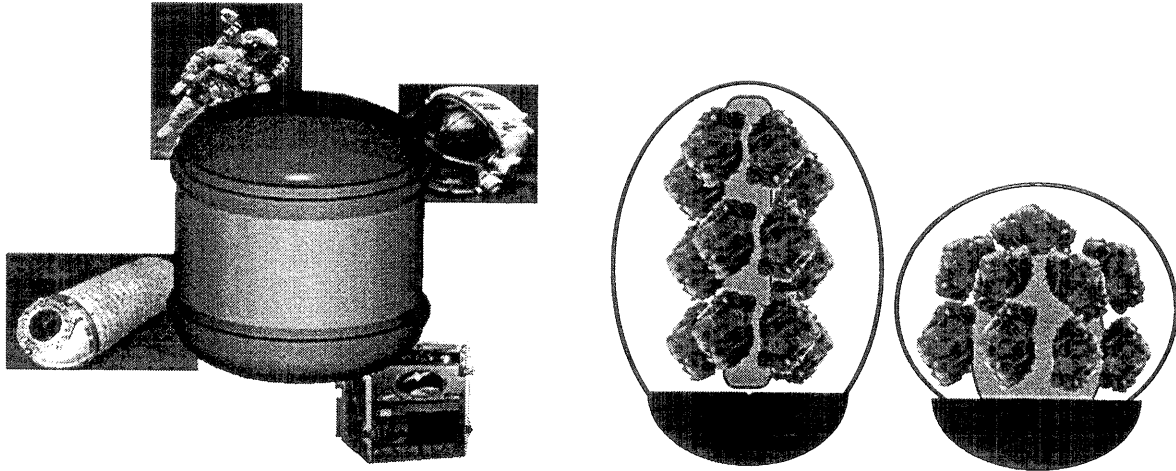

Figure 7. AG-Pod's systems are based on flight proven technologies (left) and more advanced concepts based on flexible transparent material technology (right).

Because AG-Pod is located outside the crew habitable portion of the spacecraft, it could be operated at lower pressures, which may reduce structural mass and leakage rates. The structure should be capable of full atmospheric pressures, if needed. However, we anticipate that our transparent flexible designs will not be able to achieve these pressures. Therefore, we will need to establish a plant-appropriate lower pressure regime in which to operate our structure. Corey (Corey, Barta et al. 1997) showed that low pressures (70 kPa) and ppCO₂/ppO₂ ratio manipulation can modify wheat photosynthesis rates suggesting higher biomass production rates could result. Corey (Corey, Bates et al. 1996) also studied lettuce at low pressures (51 kPa) and concluded that productivity may be enhanced by at least 25%, enabling rapid crop throughput. Low pressures may contribute to more than just enabling lower mass structures; it may increase the performance of the crops themselves.

External Location

AG-Pod's external location, or placing the unit outside of the spacecraft interior, reduces the use of spacecraft internal volume for plant growth, provides opportunities for direct radiative, convective, and/or conductive heat transfer, and access to direct solar illumination. Spacecraft internal volume is a very expensive commodity, in terms of ESM, for plant growth. Placing the unit outside can decrease the total ESM of the plant growth system by up to half (Clawson, Hoehn et al. 1999). Direct heat transfer to the environment eliminates the inefficiencies of transporting rejected heat over long distances from the interior of the spacecraft. Direct solar illumination reduces both power and heat rejection resources common with artificial lighting.

External location, however, does place limitations on the design and operation of such a system. Locating the unit externally means that harvesting, replanting, and maintenance will

require it to be brought inside if the crew is to do the work. There are two options for crew access to AG-Pod aboard a spacecraft or habitat. One option would be to ‘dock’ AG-Pod to a common berthing port, similar to a Mini-Payload Logistics Module (MPLM) on the ISS. However, AG-Pod would then become part of the spacecraft pressurized volume and require a man-rating, which increases complexity, weight, and cost. The alternate solution is to take the unit into the pressurized habitats. However, this will restrict the unit’s size and becomes the driver to sizing the outside diameter.

Aboard the ISS, there are a number of places designed to accommodate external payloads. Larger payloads can be mounted directly to the truss structure as an Attached Payload (AP), while smaller ones can be accommodated on the EXPRESS Pallet Adapter (ExPA) or the Japanese Experiment Module’s (JEM) External Facility (EF). Both of these small payload platforms, shown in Figure 8, can support experiments with power, heat rejection, and data that reduces the need for these subsystems on this first generation. The JEM EF standard payload is assumed to be 1.85m x 1.0m x 0.8m (6.2ft x 3.3ft x 2.7ft) and weighs 500kg (1110 lb.) (Anon. 1999). The ExPA’s maximum single payload weight is 227 kg (500 lb.) and the payload envelope dimensions are shown in Figure 9 (Anon. 1999).

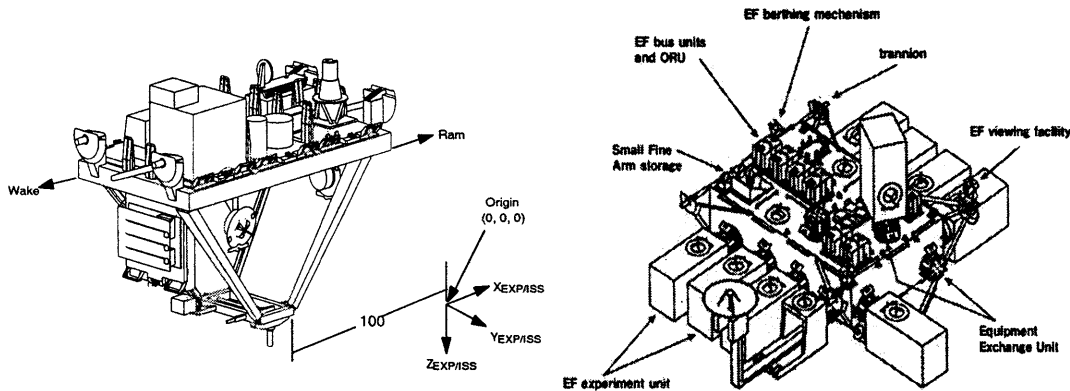

Figure 8. The EXPRESS Pallet Adapter (ExPA) (Top) and the Japanese Experiment Module (JEM) Exposed Facility (EF). Both platforms provide experiments with power, heat rejection, data, etc. (Anon. 1999; Anon. 1999).

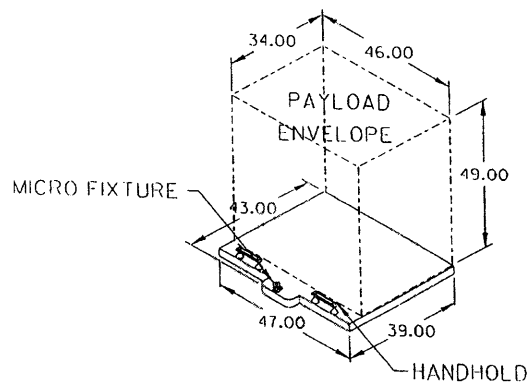

Figure 9. The ExPA payload envelope. Dimensions are in inches (Anon. 1999).

A double ExPA payload platform provides ample room for a 0.9 m external diameter AG-Pod structure with additional room remaining for micrometeoroid/orbital debris (M/OD) protection, multi-layer insulation (MLI), and various commodities. To maximize the plant growth volume, only the inflatable portion of the unit could be brought through the hatch while the

M/OD and MLI will remain outside. A thin structure on the inside diameter of the M/OD and MLI blankets would protect them from repeated insertion and removal of the inner unit.

Similar provisions could be incorporated into a longer duration mission, such as a Mars transit and surface stay. Also, current reference Mars missions require several crew EVAs per week providing ample opportunity for manual placement of the Pods in the airlock. However, adaptations to rovers could provide remote transport of the Pods to the airlock without the need for crew EVA.

Solar Illumination

There is a wide variety of available lighting schemes, from natural solar illumination via transparent materials to artificial illumination powered by externally mounted solar arrays, that AG-Pod could accommodate. For advanced life support applications, the use of direct natural sunlight via transparent materials can save considerable mass, power, and heat rejection resources that would otherwise be required for artificial lighting systems, which uses up to 80% of the power and heat rejection resources of existing space flight plant growth chambers (Clawson, Hoehn et al. 1999). To illustrate, LEDs (Barta, Edeen et al. 1992) typically operate at maximum of ~10% efficiency, and fluorescent lamps operate at ~20% efficiency (Sager and Wheeler 1994). When solar power electric generators, operating at >10% efficiency, are used to power the already inefficient artificial lights, the overall system mass becomes excessive and very expensive, achieving an overall light-to-light energy conversion as low as 1-2%. Additionally, up to 99% of the originally available solar energy has to be rejected as waste heat. Even for large terrestrial systems, the power for artificial lighting requires approximately 45% of total system power, while cooling (heat rejection, humidity control) uses another 35% of the total electrical power (Ikeda, Tanimura et al. 1992).

For supplemental illumination schemes, even with severe degradation of solar irradiance, such as by Martian global storms, any amount of direct solar illumination can help to decrease the burdens of artificial lighting. For example, using the data in Figure 10, the Mars surface irradiance during a local storm is about 175 W/m² or 23% that of Earth's surface on a clear day. Most plants are generally saturated somewhere between 200-300 W/m² (Bjorn 1976). So, even when correcting for spectral differences between Earth surface and Mars surface, as much as half of the plant lighting requirements can be met with direct natural illumination.

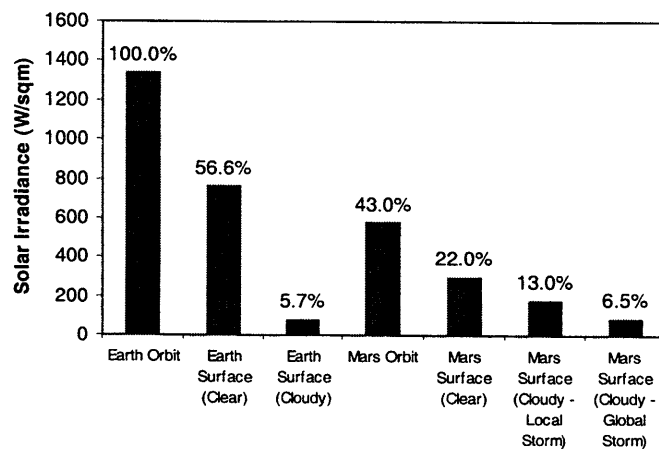

Figure 10. Relative total solar intensity of the Mars environment, including orbital and surface, compared to Earth orbit and surface. [Adapted from Reference Mission Version 3.0, 1998, with additional data from Bjorn, 1976].

Direct illumination is proposed in lieu of collector/distributor systems because of the low collector efficiencies in diffuse light (Mars dust storms) (Landis and Appelbaum 1991) and high transmission losses of current fiber optic or light pipe distribution systems (Cuello 1998). Direct illumination also provides a convenient method for hybrid lighting. Supplemental lighting can be placed externally to the unit and illuminate the interior through the same transparent end-cap that harvests the sunlight as illustrated in Figure 11. This also helps to not overburden the greenhouse thermal system with parasitic heat removal from the lamp systems since most transparent materials provide some filtering of infrared (IR) and coatings can be applied to many materials to limit IR transmission even further. This is similar to high performance terrestrial plant growth systems, which use barriers to interrupt infrared transmittance into the aerial zone (Wheeler, Berry et al. 1993). The heat generated within the lighting system can be dissipated directly to the environment or stored separately to be used to buffer nighttime heat loss in the greenhouse.

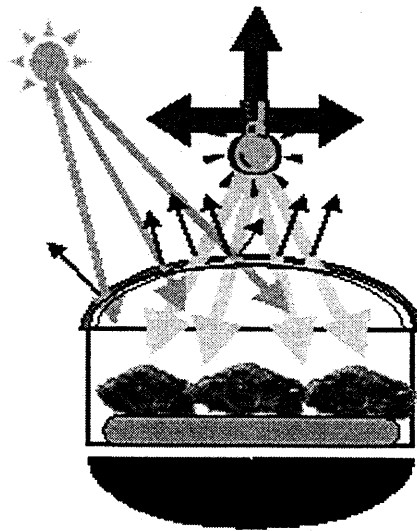

Figure 11. The combination of solar and artificial lighting

Radiation

Since AG-Pod will reside in LEO, in deep space during interplanetary transit, or on a planetary surface with presumably little atmosphere, it will not only be exposed to a broader and more intense electromagnetic spectrum, but also to an increased ionizing radiation environment. The ionizing radiation environment has always been of concern in low earth orbit and in deep space missions. For human-rated habitats, this requires the addition of a carefully designed radiation shield with low mass, adequate protection, and suppression of secondary radiation, or Bremsstrahlung. However, plants show a lower susceptibility to ionizing radiation than humans do (Casarett 1968). A number of experiments have demonstrated the ability of plants to tolerate this environment. Plant seeds have been exposed to cosmic radiation on LDEF for 6 years (Eckart 1996) and plants have been successfully germinated and grown, even from seed to seed, in the space environment aboard several spacecraft including Skylab, Shuttle, and Mir. Most of the plant growth problems experienced during space flight can ultimately be attributed to environmental conditions other than space radiation. The radiation environment in the orbit of the ISS includes protons and some electrons from the trapped radiation belts. The protons are capable of introducing a small amount of radioactivity through inelastic reactions on atomic nuclei. The average ionizing radiation dose rate due to galactic cosmic rays is around 10 mrad/day in a 55 orbit at 370 km, with fluctuations related to the solar activity cycle. Trapped electron and proton radiation add about 10-50 mrad/day to this level based on daily trips through the South Atlantic Anomaly (Curtis 1974). These very rough estimates, based on thinnest possible shielding,

suggest a maximum of 50 mrad/day received by the plants. This sums to 2.5 rads (cGy) over an 8-week growth cycle. AG-Pod's location outside of the human rated facilities allows possibilities for research as well. Simple modifications to AG-Pod's shielding could further help investigate the effects of broad-band cosmic radiation and high energy particles on plant material and the effects of radiation that could help alleviate concerns over consumption of space grown food.

Table 1 demonstrates that the radiation dose that produces observable effects is much higher for plants (377 REM for onion, to 9,137 REM for Kidney beans) than for humans (25 REM). Lethal doses for plants are also higher (from 1,500 REM for onions to 36,100 REM for Kidney beans) than for humans (450 REM). So, the shielding for a 'plant only' habitat could be minimal compared to a human rated facility.

Table 1. Effects of Ionizing Radiation on Selected Plants (Casarett 1968). Plants show lower radiation sensitivity than humans. Extra-terrestrial greenhouses that are not continuously human-tended (like AG-Pod) could use minimal or no radiation shielding.

Organism	Observable Effects	Lethal Dose
Human (Annual Limit < 5REM)	25 REM	450 REM
Onion	377 REM	1,491 REM
Wheat	1,017 REM	4,022 REM
Corn	1,061 REM	4,197 REM
Potato	3,187 REM	12,608 REM
Rice	4,974 REM	19,677 REM
Kidney Beans	9,137 REM	36,149 REM
Potential Dose:	Solar Minimum:	40 REM
	Solar Maximum:	120 REM
	Proton Flare:	500 REM

With regards to radio-activation, proton-induced reactions produce neutron-poor isotopes of C, N and O in living matter, and these have half-lives of a few minutes. This means there is little radioactivity, a maximum of 700 pCi/kg, at steady state (Todd 1962). Furthermore, following harvest, this level falls below 1 pCi/kg in about one hour, which is less than one ten thousandth of the permissible level. Exposure of plants to space radiation will therefore not produce a hazard condition by making the plants 'radioactive'. This safe condition is reflected in new FDA approval for the use of food irradiation for the stabilization of food products. In conclusion there is no obvious need to associate radiation-effects with AG-Pod-grown plants.

Comparison

Figure 12 provides a comparison of the proposed AG-Pod inflatable technology to the current spaceflight plant growth technology extrapolated to larger sizes. The inverse of the specific plant growth volume is plotted against the available plant growth volume of the payload. A plant growth volume of 0.694 m³ provides 1 m² of flat crop area with a 55 cm of crop height. A power series fitted to the existing spaceflight plant growth chamber data was extrapolated to the size of the proposed AG-Pod unit. The mass of AG-Pod's structure is based on design calculations for the forward and aft end-cap and area mass estimates of the current space suit inflatable structure. These structural mass estimates were combined with subsystem mass estimates derived for the proposed BIO-Plex, which were based on the BPC. The amount of artificial lighting was reduced to about 25% of that proposed for BIO-Plex since artificial lighting will be supplemental. However, current units do not provide much more than that. To accommodate the same plant growth volume, the current technology could weigh as much as 2300kg per m² of growth area. The estimates for an AG-Pod unit are less than 400kg per m². This is a potential 6-fold decrease.

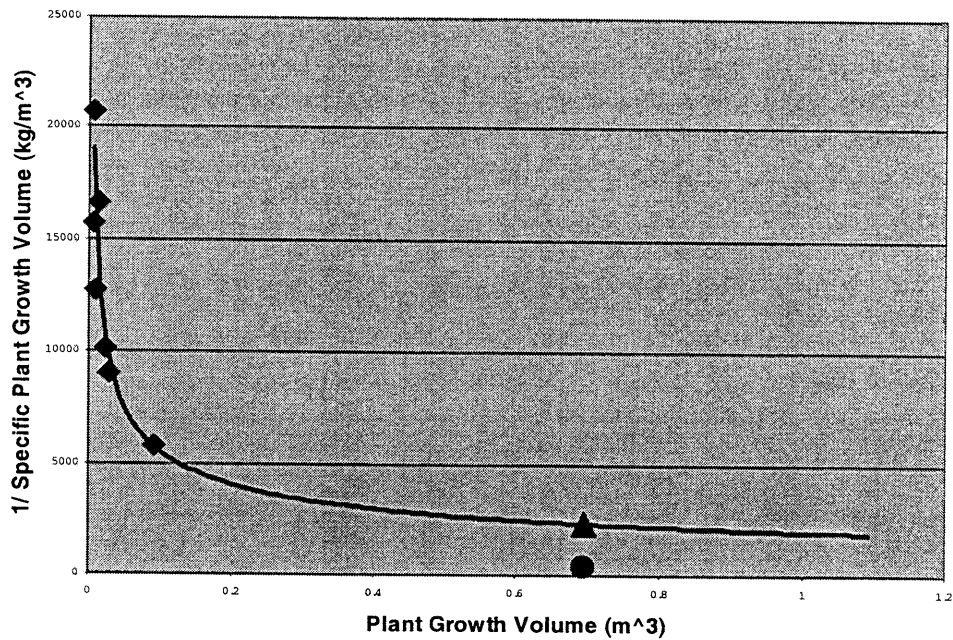

Figure 12 Comparison of a proposed AG-Pod to extrapolated data of existing spaceflight rated plant growth chambers. A plant growth volume of 0.69 m³ can easily accommodate 1 m² of plant growth area with 55 cm crop height.

Conclusion

For spaceborne crop production, the modular concept based on inflatable units described above, offers many advantages such as:

- An external plant payload offers direct solar illumination reducing power, thermal rejection needs, and internal volume needs
- External supplemental lighting reduces thermal loads
- Larger Payload Offers Superior Plant Growth Volume / Volume Efficiency
- Inflatable Structure Offers Mass Reduction, Packaging Efficiency and Technology Demonstration
- Interchangeable Components and Modular System Architecture Increases Reliability, Maintainability, and Adaptability
- Plant-rated vs. Man-rated Allows Altered Pressure & Radiation Environment Testing in Microgravity
- Allows Greater Opportunities for Plant Growth on Transit Vehicle

Significant gains in lowering the ESM of crop production systems appear to be possible even with current, high TRL technologies. Even greater reductions in ESM may be possible with the application of flexible transparent materials. However, much work is yet to be done to demonstrate the viability of these types of structures for use in the space environment at the higher pressures required for plant growth. Developments in low pressure plant growth can enable the use of this technology.

References

1. Anon. 1999. International Space Station Interface Definition Document - Expedite the Processing of Experiments to Space Station (EXPRESS) Pallet Payloads - Working Draft.
2. Anon. 1999. JEM Structure Exposed Facility, NASDA.
3. Barta, D.J., M.A. Edeen, et al. 1992. Regenerative Life Support Systems Test Bed Performance: Lettuce Crop Characterization. 22nd International Conference on Environmental Systems, Seattle, WA, SAE, ASME, ASMA, AIAA, & AIChE.
4. Bjorn, L.O. 1976. Light and Life, Seven Oaks: Hodder & Stoughton.
5. Casarett, A.P. 1968. Radiation Biology. Englewood Cliffs, N.J., Prentice-Hall.
6. Clawson, J.M., A. Hoehn, et al. 1999. AG-Pod - The Integration of Existing Technologies for Efficient, Affordable Space Flight Agriculture. 29th International Conference on Environmental Systems, Denver, CO, SAE.
7. Corey, K.A., D.J. Barta, et al. 1997. Photosynthesis and Respiration of a Wheat Stand at Reduced Atmospheric Pressure and Reduced Oxygen. Advances in Space Research 20(10): 1869-1877.
8. Corey, K.A., M.E. Bates, et al. 1996. Carbon Dioxide Exchange of Lettuce Plants Under Hypobaric Conditions. Advances in Space Research 18(1/2): (1/2)301-(1/2)308.
9. Cuello, J. 1998. Harnessing Solar Irradiance for Space Life Support. Tuscon, AZ, University of Arizona.
10. Curtis, S.B. 1974. Physics and Dosimetry. Space Radiation Biology and Related Subjects. C. A. T. a. P. Todd. New York, Academic Press: 21-99.
11. Drake, B.G. 1998. Reference Mission Version 3.0 Addendum to the Human Exploration of Mars: The Reference Mission of the NASA Mars Exploration Study Team. Houston, NASA Johnson Space Center Exploration Office.
12. Drysdale, A.E., D. Beavers, et al. 1997. KSC Life Sciences Project Annual Report for January to December, 1997. Kennedy Space Center, Florida, The Boeing Company.
13. Drysdale, A.E. and A.J. Hanford. 1999. Advanced Life Support Research and Technology Development Metric - Baseline. Houston, NASA Johnson Space Center.
14. Drysdale, A.E. and A.J. Hanford 1999. Advanced Life Support Systems Modeling and Analysis Project Baseline Values and Assumptions Document. Houston, NASA Johnson Space Center.
15. Eckart, P. 1996. Spaceflight Life Support and Biospherics. Torrance-Dordrecht / Boston / London, Microcosm Press-Kluwer Academic Publishers.
16. Hoehn, A., J. Clawson, et al. 1998. Mass Transport in a Spaceflight Plant Growth Chamber. 28th International Conference on Environmental Systems (ICES), Denver, CO, SAE.
17. Ikeda, A., Y. Tanimura, et al. 1992. Environmental Control and Operation Monitoring in a Plant Factory Using Artificial Light.
18. Landis, G.A. and J. Appelbaum. 1991. Photovoltaic Power Options for Mars. Space Power 10(2): 225-237.
19. Sager, J.C. and R. M. Wheeler. 1994. Application of Sunlight and Lamps for Plant Irradiation in Space Bases. Advances in Space Research 12(5): 133-140.
20. Schuerger, A.C. 1998. Microbial Contamination of Advanced Life Support (ALS) Systems Poses a Moderate Threat to the Long-term Stability of Space-Based Bioregenerative Systems. International Journal of Life Support & BioSphere Science 5: 325-337.
21. Todd, P. 1962. Proton Activation in Space Vehicles, University of California Radiation Laboratory: 1-14.
22. Wheeler, R.M., W.L. Berry, et al. 1993. A data base of crop nutrient use, water use, and carbon dioxide exchange in a 20 square meter growth chamber: I. Wheat as a case study. Journal of Plant Nutrition 16(10): 1881-1915.

Inflatable Structures for Space Applications

Charles R. Sandy and Dave Cadogan
ILC Dover, Inc
Frederica, Delaware, USA

Abstract

Inflatable structures offer many benefits over conventional structures for various space and planetary exploration mission components. Perhaps the most noteworthy benefit is the ability to collapse the inflatable structures into small volumes of various shapes for launch. This capability yields high deployed volume to stowed volume ratios that reduce launch costs by increasing usable payload volume. Inflatable structures can also be manufactured from high strength materials such as Vectran or PBO to yield low mass structures. This class of structures also offers reduced system cost, not only because of the increased payload volume use efficiency, but because of their simplicity in design and construction. The benefits of inflatable structures have been realized in several applications such as the Extra-Vehicular Activity Space Suit, the Mars Pathfinder impact attenuation landing system, and hyperbaric chambers.

Inflatable structures have been proposed for use in various greenhouse structures to capitalize upon their benefits for optimized economic performance in space and planetary exploration activities. Inflatable greenhouse structures offer the promise of providing the means for economically efficient plant growth in space. This paper will present several inflatable structures with similar requirements to demonstrate the performance capability and readiness of this technology for use in space greenhouse applications.

Related Inflatable Structures

There are numerous inflatable structures that have performed similar functions as the proposed greenhouse structures, and can be used as a basis for design in space applications. The following is a description of several examples of engineered inflatable structures with related attributes, and some information on the materials from which they are manufactured.

Space Suit – One of the most well known inflatable structures is the Extra-Vehicular Activity Space Suit, which is itself a self-contained spacecraft (Figure 1). The Space Suit Assembly (SSA) is compiled of numerous inflatable components (arms, legs, gloves, etc.) that are manufactured from coated and woven fabrics, and films. The flexibility of the materials enable the mobility of the joints of the suit and also allow the suit to be packaged into a small volume during launch and landing.

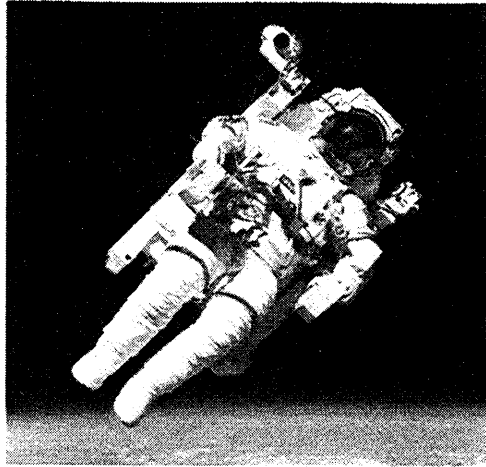

Fig.1. Space Shuttle Suit

The materials used in the SSA are configured to provide a comfortable environment for the Astronaut while providing protection from the thermal, radiation, and micrometeoroid / orbital debris environments of space. The load regime witnessed in the Space Suit allows the load-carrying portion, known as the restraint, to be manufactured from a polyester fabric. Polyester fabric was selected because of its flex characteristics, cost, and ability to reduce stress concentrations by local elongation.

Pathfinder Airbags - Another interesting example of a highly engineered inflatable structure used in a space application is the Mars Pathfinder impact attenuation system (Figure 2). The impact attenuation system consisted of a series of airbags that were attached to the exterior of the lander and absorbed the high g-loads of landing on the rocky terrain of Mars.

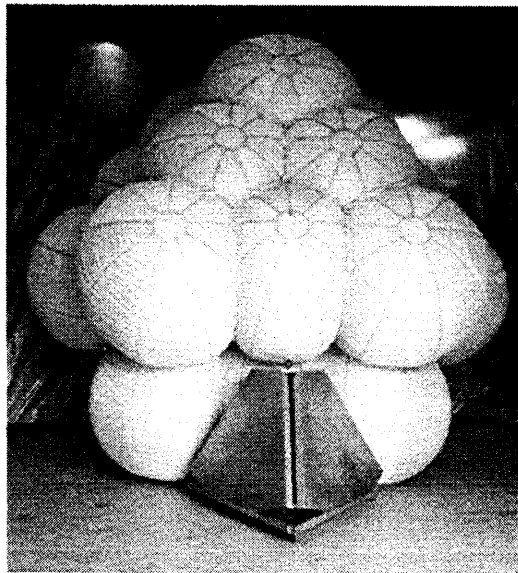

Fig.2. Mars Pathfinder Airbags & Lander

The greatest challenge in the design of this system was to develop a lightweight material lay-up that could support the inflation loads and protect the airbags from penetrations from impacting on sharp rocks. The airbags had to structurally perform while meeting the environmental challenges of the long cold cruise to Mars and the rapid violent inflation and landing sequence, which increased the materials development challenge. Extensive component and system level testing lead to a multi-layered airbag construction: a coated fabric bladder layer that retained gas while supporting pressure-induced membrane loads

and multiple cover layers for abrasion, puncture and tear protection. Requirements specific to these materials included:

- ◆ Low mass. The system mass limit required that all materials be mass optimized.
- ◆ High tensile strength. Both the bladder and abrasion layers required high strength for supporting membrane loads and local rock-induced loads.
- ◆ High tear strength. To survive the rocky impacts, all layers resisted tear propagation, particularly the abrasion layers.
- ◆ Low gas permeability. The bladder had to retain inflation gas throughout the landing event.
- ◆ Low temp flexibility. Retraction required that all layers remain flexible at -83°C.
- ◆ Strength at elevated temperature. The bladder material supported its highest loads immediately following inflation of the gas generators.
- ◆ Retention of strength after flex/crease. All layers were tightly packed for months prior to deployment.
- ◆ Low coefficient of friction. Enabled retraction.
- ◆ The materials had to lend themselves to reliable fabrication processes for assembly.

For the bladder layer, a coated fabric construction was selected over a separate restraint/bladder construction because it could be made lighter because the gas retaining compound can be thinner as a coating than as a separate film. It is also simpler and therefore more reliable because no bladder/restraint indexing is required. The woven base fabric is the structural element while the coating provides the necessary gas retention.

The airbag bladder material selected was a silicone coated Vectran fabric:

Base Fabric : Fabric Construction

Yarn	200 denier Vectran HS
Weave	50 x 50 plain weave
Weight	2.7 oz/yd ²
Tensile Strength	400 lbs/inch
Tear Strength	150 lbs

Coated Fabric

Coating	Silicone rubber
Coating Adhesion	7.0 lbs
Coating Weight	1.6 oz/yd ²
Coated fabric weight	4.3 oz/yd ²

Vectran is a liquid crystal polymer fiber manufactured by Hoechst-Celanese. With comparable yarn tenacity to Kevlar 29, it has better flex-crack/abrasion resistance. Kevlar fibers are more readily damaged by flexing and sliding against themselves, when the fabric is folded. While Kevlar offers more strength retention at higher temperatures than Vectran, Vectran retains its full strength upon cooling and actually gets stronger at low temperatures. In addition, system level testing revealed that the bulk gas temperature in the airbags never reached temperatures that degraded Vectran strength. Since exposure to heat sterilization temperature occurs in an unloaded condition, Vectran's superior flex-crack resistance led to its selection.

The 50 x 50 plain weave 200 denier fabric construction was selected to yield the required tensile strength while providing a smooth topography so that the lightest gas retaining coating could be applied. The base fabric was calendered to enhance smoothness for this purpose. The abrasion layers were manufactured from a similar uncoated Vectran fabric.

Mars TransHab - NASA JSC is currently working on a program to develop an inflatable habitat structure to be used as a transfer vehicle to Mars, or possibly as the habitation module on the International Space Station (Figure 3). The design is compiled of a metallic central core with a flexible composite outer shell that is cylindrical and has toroidal ends. The inflatable structure is packaged around the central core

to decrease its volume for launch, then inflated, on-orbit, to its approximate 25 ft diameter by 30 ft length (Figure 11). The high packing efficiency of the system will allow the entire module to be launched on a single Shuttle launch as compared to two launches for an equivalent volume rigid structure. The inflatable structure is a series of material layers that perform numerous functions including; Gas retention, Structural Restraint, Micrometeoroid/Orbital Debris (MMOD) Impact Protection, Thermal Protection, and Radiation Protection.

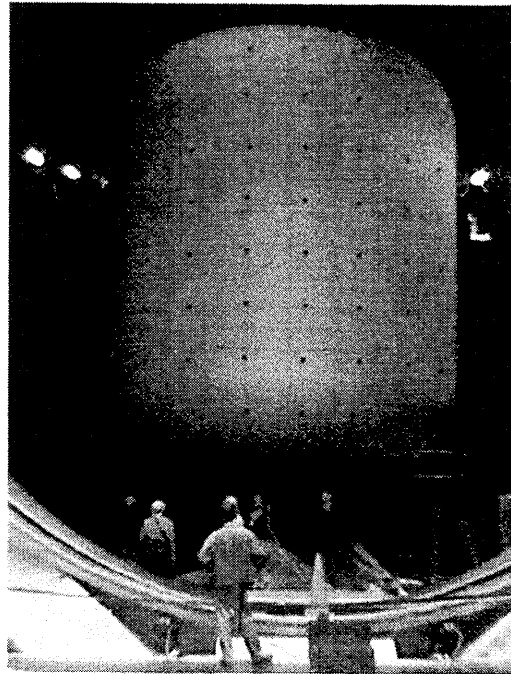

Fig. 3. TransHab Test Unit in Chamber Test

Gas retention is achieved by a redundant bladder assembly. Structural restraint is achieved by a series of Kevlar webbings that are interwoven and indexed to one another to form a shell. The webbings are terminated to pins which are mounted to the ends of the metallic core structure. The webbings are sized to withstand the 14.7 psi internal pressure (Space Station variant) loads with a factor of safety of 4 over ultimate. This yields a structure that must withstand approximately 8820 lb/in maximum stress in the hoop direction and 3529 lb/in stress in the longitudinal direction. Other materials, such as Vectran, are also being considered for the webbings in flight configurations.

MMOD impact protection is being accomplished by a series of woven 0.06 in thick Nextel layers separated by foam spacers to create a multi-hull structure. This structure was tested for hypervelocity particle impact by JSC and found to provide greater protection than the current Space Station design. Testing revealed that 0.71 in diameter particles traveling at 7 km/sec would not penetrate the structure. This provided margin over the current limit of 0.51 in diameter particles at 7 km/sec for the Space Station in a roughly equivalent mass system. The Nextel layers were coated with polyethylene to enhance their stability. The polyethylene also provides a significant amount of radiation protection. Thermal protection is accomplished by a series of metallized films on the exterior of the assembly that reflect radiation.

The bladder is manufactured from a lay-up of various materials to provide a double redundant bladder. Each individual bladder layer is a laminate of polyethylene, nylon, ethylene vinyl alcohol (EVOH), and polyethylene film. The resultant laminate is an ultra-low permeable film. Polyethylene is placed on both sides to facilitate thermal sealing of the structure. Three layers of the bladder laminate are separated by a 4 oz/yd² non-woven polyester to allow flow paths for pressure monitoring between each layer which is used to sense leaks in the individual bladder layers.

MK50 Torpedo Recovery System - The MK50 Torpedo Recovery System, designed and manufactured by ILC Dover, is a high strength reusable inflatable system that is packaged into a very small volume on a torpedo and remotely triggered to inflate to bring the torpedo to the surface for recovery. Although this is a terrestrial application of engineered inflatable structures, it is discussed here because of its similarity to space greenhouses in several mission requirements and design. This component is 2.6 ft in diameter by 2 ft long, inflates to 28 psi, and has a packing efficiency of 60% (Figure 4). The inflatable portion of the assembly consists of a Urethane coated Kevlar fabric that is bound externally by a series of Kevlar webbings that support the longitudinal and circumferential stresses in the assembly. The MK50 recovery systems have been successfully used in thousands of training exercises by the U.S. Navy.

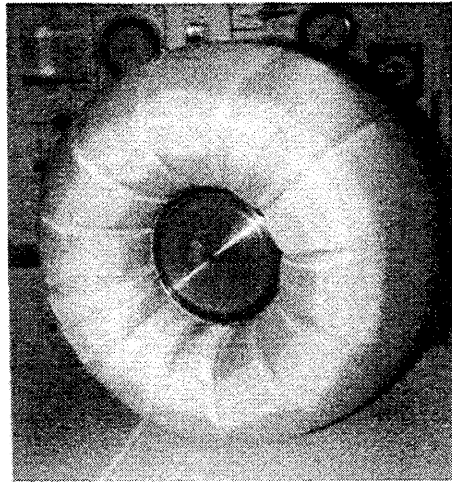

Fig. 4 . MK 50 Torpedo Recovery System

Collapsible Hyperbaric Chamber - Another example of a high technology inflatable that has structural similarities to inflatable space greenhouses is the ILC Dover Collapsible Hyperbaric Chamber (Figure 5). This 2.6 ft diameter by 7 ft long cylindrical structure is used as a portable chamber to use in hyperbaric treatment of high altitude flight personnel or space station crew who experience the bends. This structure consists of a bladder layer that provides pressure retention, and a restraint layer that supports structural loads. The bladder is a urethane coated polyester and the restraint is made up of a series of polyester webbings stitched to a polyester fabric substrate. The system operational pressure is 2.8 atmospheres with a factor of safety of 3 over ultimate.

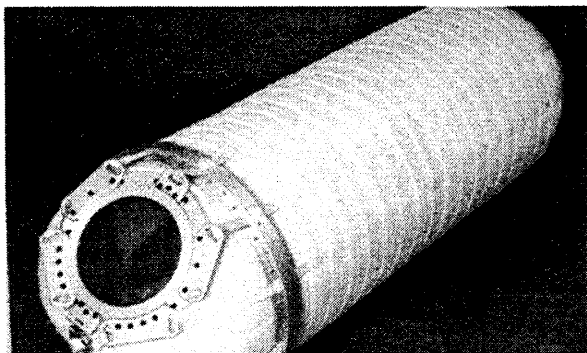

Fig. 5.
Collapsible Hyperbaric Chamber

Inflatable Space Greenhouse Structures

Inflatable structures have been proposed for use in numerous greenhouse and habitat structures for space and planetary exploration over the past several decades. The maturity of the technology, as witnessed in the above examples, is high and available for application in space agriculture facilities. The ability to tailor the design of the inflatable structure to meet various geometrical and structural requirements translates into highly efficient greenhouse facilities.

There are numerous materials available for use in inflatable greenhouse structures. Considerations have to be made not only for the structural portion of the greenhouse, but also for the air retention layer and environmental protection layers. The selection of the material is predicated on the requirements of the system and can include many of the following factors:

- ◆ Strength with Factor of Safety
- ◆ Mass
- ◆ Flexibility (for packaging)
- ◆ Permeation of inflation gas
- ◆ Outgassing (into or from greenhouse)
- ◆ Interface to hardware (windows, etc).
- ◆ Thermal protection (optical properties)
- ◆ Cycle life (pressurization/deployment/thermal)
- ◆ Environmental resistance (AO, radiation, etc.)
- ◆ Flex fatigue (manufacture & deployments)
- ◆ Puncture/tear resistance
- ◆ Component life
- ◆ Manufacturing & assembly

Depending on the requirements of the greenhouse, a single or double layer wall may be selected to provide the pressure retention and structural restraint function. A single layer wall is typically a coated fabric, which has its advantages in mass and indexing between layers. The double layer wall typically consists of a sewn fabric restraint with an indexed, coated fabric or film bladder. The double layer wall is advantageous because of its flexibility in design and manufacture.

There are numerous high strength fabrics available to use in the structural portion of the greenhouse. Many of these would be acceptable in providing a long lived green house in space, but should be traded to determine the optimal approach depending on the system's configuration. Several candidate materials and their properties can be seen in Table 1.

There are also several factors that must be considered in the design of the greenhouse structure such as:

- ◆ Large vs small structure (economies in size)
- ◆ Operational pressure
- ◆ Effects of loss of a unit (1 big vs. many small)
- ◆ Logistics of harvesting
- ◆ Ingress/egress for harvesting
- ◆ Retrieval method for harvesting
- ◆ Method of lighting
- ◆ Thermal regulation
- ◆ Man-rating

Fiber	Dacron® Type 68	Spectra 1000	Vectran HS	Kevlar 29	Technora	Zylon HM
Material Type	Polyester	Polyethylene	LCP	Aramid	HT Aramid	PBO
Physical Properties						
Tenacity @ Break (g/d)	8.4	33	23	22	28	42
Modulus (psi)	2.03×10^6	29.1×10^6	9.4×10^6	10.2×10^6	10.1×10^6	3.97×10^6
Elongation @Break (%)	17	3.4	3.30	3.6	4.6	2.5
Density (g/cm ³)	1.38	0.97	1.4	1.44	1.39	1.56
Temperature Limitations	Melts at 256°C	Melts at 149°C Exhibits creep with increasing temperature	Melts at 329°C. Tensile strength ↓ as temp ↑	Decomposes at 427°C. Tensile strength remains fairly constant with temperature	Decomposes at 550°C. Tensile strength remains fairly constant with temperature	Decomposes at 650°C. Tensile strength remains fairly constant with temperature

Table 1.
Candidate Reinforcement Materials

These design and other factors will determine the configuration of the greenhouse that best meets the overall system performance requirements.

Conclusions

Flexible composite inflatable structures offer many advantages over conventional structures for space applications. Principal among the advantages is the ability to package inflatable structures into small volumes for launch. This allows for smaller launch systems to be used, which reduces program costs dramatically, and yields greater deployed volume on site. Mass reductions are also realized in the structural and hypervelocity impact shield portions of the assembly when inflatables are utilized.

The design, manufacture, and test of inflatable space structures has been ongoing for decades. This is evidenced by items such as space suits, Mars Pathfinder airbags, and inflatable habitat structures. Design maturation and the development of advanced materials and fabrication processes have made the concept of inflatable space greenhouses achievable in the near future.

Bibliography

1. Balinskas, Robert (Hamilton Standard), James W. McBarron II (NASA Johnson Space Center), and Spampinato, Philip M. (ILC Dover). "Shuttle Extravehicular Mobility Unit (EMU) Operational Enhancements." Proceedings of 20th Intersociety Conference on Environmental Systems. Williamsburg, VA: SAE, July 9-12, 1990.
2. Cadogan, David and Grahne, Mark (ILC Dover) and Mikulas, M. (University of Colorado). "Inflatable Space Structures: A New Paradigm for Space Structure Design." Proceedings of 49th International Astronautical Congress. Melbourne, Australia. September 28 - October 2, 1998.
3. Cadogan, David, and Sandy, Charles, and Grahne, Mark (ILC Dover). "Development and Evaluation of the Mars Pathfinder Inflatable Airbag Landing System." Proceedings of 49th International Astronautical Congress. Melbourne, Australia. September 28 - October 2, 1998.
4. Crimmins, Rob. "Final Report for Conceptual Design Study for Modular Inflatable Space Structure." ILC Dover. December 4, 1989.
5. Kosmo, Joseph J., Spenny, William E. (NASA Lyndon B. Johnson Space Center) and Gray, Rob and Spampinato, Phil (ILC Dover). "Development of the NASA ZPS Mark III 57.2-kN/m² (8.3 psi) Space Suit." Proceedings of 18th Intersociety Conference on Environmental Systems. San Francisco, CA: SAE, July 11-13, 1988.
6. Morgenthaler, George W. "Some Realistic Barriers to International Mars Human Exploration Now: Work to be Done - New Approaches." Proceedings of 1996 AIAA Space Programs and Technologies Conference. Huntsville, AL: September 24-26, 1996.
7. Shortliffe, Glen (GB Tech) and Christiansen, Eric (NASA). "Mars Trans Hab Meteoroid and Orbital Debris Shield Performance Assessment." Prepared for the JSC Engineering Directorate (EA). June, 1997.
8. Stein, Jim, Cadogan, Dave, Fredrickson, Thad, and Sharpe, George. "Deployable Lunar Habitat Design and Materials Study, Phase I Study Program Results." ILC Dover. January 29, 1997.
9. Tynan Jr., C.I., Williams, J.G., and Osborne, R.S. "Expandable Structures Technology For Manned Space Applications." Proceedings of AAS/AIAA Variable Geometry and Expandable Structures Conference. Anaheim, CA: April 21-23, 1971.

DESIGN NEEDS FOR MARS DEPLOYABLE GREENHOUSE

Ray A. Bucklin

Agricultural and Biological Engineering Department, University of Florida, Gainesville, FL

Phil A. Fowler

Dynamac Corporation, Kennedy Space Center, FL

James D. Leary

Agricultural and Biological Engineering Department, University of Florida, Gainesville, FL

The types of structures that might be used for plant production on Mars vary from small automatically deployed structures serving to house a small number of plants for research purposes to larger structures that would be used to grow plants as part of a manned expedition. The structural requirements will vary depending on the size and purpose of the greenhouses, but the functions necessary for successful plant growth will be similar regardless of size. This paper will focus on design concepts for small automatically deployed structures. Structural requirements will be discussed first and then the relationships between the structure and the functional needs of the plants will be discussed from the point of view of experiences with terrestrial greenhouse engineering.

The first step in structural design is to determine the loads. Martian gravity is 0.38 of Earth gravity ($3.73 \text{ m}^2/\text{s}$) so the dead loads will be considerably less than on Earth. The Martian atmosphere has a density of about 0.01 that of Earth. Wind loads on structures are calculated from:

$$q = (2\rho V^2)C_D \quad (1)$$

Where:

q = pressure on vertical flat plate, Pa
 ρ = air density, kg/m^3
 V = air velocity, m/s
 C_D = drag coefficient

For Earth, ρ of $1.2 \text{ kg}/\text{m}^3$ is used and dividing by 1000 to give kPa:

$$q = (6 \times 10^{-4} V^2) C_D \quad (2)$$

Assuming 0.01 Earth density for the Martian atmosphere, gives

$$q = (6 \times 10^{-6} V^2) C_D \quad (3)$$

The drag coefficient for a dome or half cylinder resting on the ground varies from +1.4 positive pressure to -0.5 suction across the structure (ASCE, 1995). The wind forces on a Deployable Martian Greenhouse would be expected to be small because of the low atmospheric density. However, in a major storm, the squared velocity term in equation 3 combined with the low Martian gravity could produce a risk of uplift or overturning of a very light structure. Problems with distortion or fluttering of the wall could also occur if the velocity pressure is a significant fraction of the internal pressure. Gusts of up to 100 m/s are reported as possibilities on Mars, but even for these extremely high velocities, equation 3 gives a pressure of 0.06 kPa on a vertical flat plate.

Stresses in a curved shell loaded by internal pressure are calculated from (Timoshenko and

Woinowsky-Krieger, 1959):

$$\sigma_t = pr/t \tag{4}$$

Where:

- σ_t = tensile stress in shell, kPa
- p = internal pressure, kPa
- t = shell thickness, m
- r = radius of curvature, m

Bending stresses in a rectangular flat plate carrying a pressure load are calculated from (Timoshenko and Woinowsky-Krieger, 1959):

$$\sigma_b = KpL^2/t^2 \tag{5}$$

Where:

- σ_b = bending stress in a square plate, kPa
- p = pressure, kPa
- L = length of a side, m
- t = shell thickness, m
- K = Constant determined by length to width ratio and edge conditions. For a square plate with clamped edges, $K = 0.0513$

Inflatable structures with curved geometry have been studied for Lunar and Martian use (Abarbanel and Criswell, 1997; Nowak, Sadeh and Morroni, 1992; Sadeh and Criswell, 1995; Schroeder and Richter, 1994). The structures in these studies have been large enough for human occupancy, but many of the same principles will apply to the smaller structures being considered for a deployable greenhouse. Inflatable structures are a type of tensile structure (Irvine, 1981; Leonard, 1988; National Research Council, 1985; Otto, 1973; Shaeffer, 1996). Tensile structures include tents and other structures fabricated using membranes as structural elements. Membranes only carry tensile loads in the plane of the shell or fabric and can not carry compressive or bending loads.

Greenhouse Design factors

A complex set of design parameters must be determined for a Mars greenhouse. The Martian gravity, length of year and length of day are well known, but other factors have varying degrees of uncertainty or are unknown. As a starting spot, as much information as possible about the location, size, shape, maximum allowable weight and required lifetime of the structure is needed. In addition, as much information as possible is also needed about the type of plant to be grown and the plant's temperature, humidity and lighting requirements.

Ambient Conditions

Atmospheric Pressure

Atmospheric pressure varies widely with location and season on Mars. NASA (2000) gives the surface pressure as about 0.61 kPa and lists observed values from 0.69 kPa to 0.9 kPa at the Viking 1 Lander site. Atmospheric pressure is always extremely low compared to Earth and from a structural analysis viewpoint is effectively zero.

Winds and Dust

Wind gust velocities of up to 100 m/s have been estimated to occur on the Martian surface. Because of the low atmospheric density, the loads produced by these wind velocities will be low enough to neglect. However, the dust carried by windstorms is important, Dust suspended in the air changes the overall quantity of light and the distribution of direct and diffuse radiation.

Temperature

The average surface temperature on Mars is about -63°C. The diurnal temperature range observed at the Viking 1 Lander site was -89° C to -32° C (NASA 2000). This temperature range is far below the temperature range where plants can survive, so any plant growth on Mars must take place in heated environments.

Light Levels

Estimates of light levels vary and it is often difficult to determine whether the tabulated values are for the Martian surface or for the Martian orbit. The distribution of direct and diffuse light is needed. Plant photosynthesis does not respond to the entire spectrum of light. Values of Photosynthetically Active Radiation (PAR) levels are needed for Mars.

Ambient light levels on Mars are high enough to sustain plant growth. However, because of the extremely low temperatures, any plant production must be conducted inside an enclosure. Even the best clear wall material for an enclosure will reduce light levels. The ideal wall material would allow transmittance into the structure of the wavelengths above 300 nm at angles of incidence from zero to 90° and zero transmittance out of the structure for all thermal wavelengths beyond 3000 nm (Aldrich and Bartok, 1994; Evans, 1963; Hanan, 1998; Robbins and Spillman, 1980).

Another problem is that the wall materials with the highest light transmissivity are thin films that have low thermal resistance and low mechanical strength. It may be necessary to supplement ambient light with artificial lighting to achieve satisfactory plant growth. The power requirements of artificial lighting are very high; however, in contrast to most situations on Earth, the waste heat from artificial lights would be very useful for a Martian greenhouse.

Dust

Dust is important because it reduces the overall light level and produces diffuse radiation. The rate of deposition of dust on the surface of a greenhouse is needed. The power produced by the solar cells on Mars Pathfinder dropped by 0.33% per day (Muser and Alpert, 2000). It will be necessary to develop a method of dust removal from the exterior of the greenhouse.

Structural Needs

The main structural load on any structural configuration will be imposed by the internal pressure. Gravity loads and wind loads will be much smaller. As discussed earlier, the stresses in a curved shell are directly related to the internal pressure and the shell radius and are inversely related to the wall thickness. Stresses in flat sheets increase with pressure and sheet width and bending stresses in flat sheets also increase as sheet thickness decreases. A greenhouse wall must be as transparent as possible, which typically means the wall should be as thin as possible. Most greenhouse films are less than 1 mm thick, so stresses can rapidly approach the failure strength of the film. Reinforcing material can be added to films and sheets, but reinforcing material blocks or reduces light levels.

The first greenhouses will be deployed from unmanned landers and must use a frame structure that is lightweight and that lends itself to being stored in a folded configuration and then automatically deployed into its functional configuration. The wall material must also be capable of being folded and be able to be automatically unfolded with the frame into the functional configuration. A spherical shape gives the best strength to weight ratio for carrying pressure loads and curved shapes such as hemispherical domes or half cylinders have better strength to weight ratios than structures fabricated with flat sides. The curved shapes also have lower surface area to volume ratios, which is an advantage when considering heat loss through the wall surfaces. However, the lower surface area to volume ratio can be a disadvantage when light collection is considered.

Many film materials exhibit large thermal expansion and contraction. Large stresses are produced if the film is restrained from changing length as the temperature changes. Cycles of expansion and contraction can also produce stresses at joints that can lead to leakage problems. Many clear materials are sensitive to ultraviolet radiation and become brittle and discolor over time.

Environmental control

The dominant environmental parameter in a Mars deployable greenhouse will be temperature. A heating system will be a necessity at night. There may be times during daylight hours that enough solar energy can be collected to maintain desired temperatures. However, even on the best days, supplemental heating will be required for a large portion of daylight hours. If a transparent film is used for wall material, the heating system will consume major quantities of energy, so utilizing as much solar energy as possible will be critical. Significant quantities of solar energy are available on the Martian surface, but as on Earth, the solar energy on Mars is not always available when required and is never available at night. If supplemental lighting is used, cooling may be necessary because electrical lights produce very large quantities of waste heat. Because of the cold surroundings, cooling should consume much less energy than heating. The quantity of solar energy available to heat a greenhouse can be increased by the use of solar collectors and concentrators. Thermal storage is necessary when using solar systems in order to provide a steady supply of energy throughout the day.

The greenhouse effect occurs in an enclosed volume with clear walls when visible light is transmitted through the clear wall material and a portion of the light is absorbed by objects inside the enclosure. As objects inside the enclosure absorb light, their temperature increases and the objects emit infrared radiation. If the wall material is transparent to visible light and opaque to infrared radiation, then the infrared energy is trapped inside the enclosure, and the air temperature in the enclosure increases. Glass is transparent to visible wavelengths of light and opaque to infrared wavelength and is an ideal wall material for greenhouses. Unfortunately, many plastic films such as polyethylene are transparent to infrared radiation. The radiation characteristic of wall materials must be carefully selected to optimize transmission of Photosynthetically Active Radiation and block as much radiation in the infrared range as possible.

All practical closed systems holding gas under pressure leak and because of the pressure differential across wall surfaces and the difficulties of maintaining tight seals of flexible materials, some leakage will occur from the greenhouse. Replacement gases will have to be heated, adding to the energy load on the greenhouse. Carbon dioxide can be replaced from the Martian atmosphere, but water vapor and oxygen will be difficult to make up.

The greenhouse will require a ventilation system. The plants will require some minimum air velocity over leaves for gas exchange. Plants transpire and release oxygen as a byproduct of photosynthesis. Even if the overall system is closed, the plant growth volume must be maintained within a certain range of relative humidities and at some point surplus oxygen will need to be removed from the system and carbon dioxide will need to be added.

Temperature and relative humidity will need to be constantly controlled to maintain a satisfactory environment for plant growth. An overall environmental control system will be required to manage the interactions between lighting, temperature, relative humidity, oxygen level, carbon dioxide level, pressure, the hydroponics system and plant growth.

Plant Considerations

The consideration that has the largest impact on structural design is the internal pressure of the greenhouse. The absolute minimum internal pressure is the sum of the partial pressures of carbon dioxide, water vapor and oxygen inside the greenhouse. The partial pressure of carbon dioxide in Earth's atmosphere is 0.35 kPa. The partial pressure of carbon dioxide in the Martian atmosphere is about 0.57

kPa. The partial pressure of water vapor in Earth's atmosphere referred to as the vapor pressure varies with temperature and relative humidity. At comfortable room conditions of 25°C and 50% relative humidity, the vapor pressure for Earth's atmosphere is 1.6 kPa. Table 1 gives values of vapor pressure for several combinations of temperature and relative humidity.

T, °C	RH, %	Partial Pressure of Water Vapor, kPa
20	50	1.2
25	50	1.6
30	50	2.1
35	50	2.8
20	80	1.9
25	80	2.5
30	80	3.4
35	80	4.5

Table 1.
Partial Pressure of Water Vapor in Earth's Atmosphere for
Example Temperatures and Relative Humidities.

The values of vapor pressure in Table 1 vary by a factor of close to four. This variation can be neglected in open systems operating at Earth atmospheric pressure, but the variation is important in closed systems operating at reduced pressures. Tests in the vacuum test chamber at Kennedy Space Center (Fowler et al, 2000) indicate that plants tolerate pressures down to 0.2 atmosphere or about 20 kPa without problem, but begin to wilt below this value. It is believed that low dissolved oxygen level in water in the root zone caused the observed wilting. The saturation level of dissolved oxygen in water is a function of pressure, and as pressure dropped, the oxygen carrying capacity of the moisture in the root zone dropped below that necessary for proper root function. Plants have a region of temperatures in which they function best and also upper and lower limits beyond which they display heat or cold damage. Temperature also has a major influence on transpiration rate and on dissolved oxygen levels in root moisture.

The internal gas mix must contain minimum levels of carbon dioxide, water vapor and oxygen. The maximum desirable levels of these components will not total 20 kPa so some inert gas will be required to supply the remainder of the desired pressure. The pressure and the gas mix in the greenhouse will require monitoring and control. In a totally closed system, the carbon dioxide partial pressure will drop as carbon dioxide is consumed by photosynthesis. At the same time, oxygen is released by the plants and the oxygen partial pressure will increase. Water vapor partial pressure will increase as the plants transpire and add water to the gas mix. Excess water vapor will have to be removed from the gas mix and recycled into the hydroponic system's water. Water vapor pressure will fluctuate by several kilopascals as relative humidity varies (Table 1). Carbon dioxide will have to be replaced as it is consumed by photosynthesis and oxygen will have to be harvested and stored or discharged before it reaches undesirable levels.

Just as with temperature, plants require a certain range of relative humidity to function. Relative

humidity is the ratio of the ambient water vapor pressure to the water vapor pressure at saturation for the same temperature and total pressure. So for a given temperature and total pressure, relative humidity is a function of ambient water vapor pressure. The vapor pressure increases as moisture is added to the air through transpiration or evaporation from leaks in the hydroponic system. Under Earth atmospheric pressure in an open system, the change in vapor pressure is not important, but in a totally closed system at low pressure, fluctuations in vapor pressure will have a significant influence on total pressure.

The hydroponic system needs to be as tight as possible to reduce the quantity of water that evaporates from leaks. At high relative humidities, condensation on interior wall surfaces will occur. Condensation by itself will reduce light levels and over time will promote dirt collection on wall surfaces that will further reduce light levels.

A minimum internal air velocity is needed for the gas exchanges required for photosynthesis to occur. Velocities in excess of this minimum should be produced by the ventilation system operating to remove moisture from the system, so maintaining the minimum required velocity is not expected to be a problem. The plant will also require some minimum volume for its canopy.

The biggest challenge for the design of a deployable Martian greenhouse is to achieve the maximum light transmittance while keeping heat loss to acceptable levels. Radiation heat transfer should dominate for Martian conditions. The low density atmosphere will reduce conductive heat transfer through the atmosphere outside the greenhouse to minor levels. Convection should also be small because of the low air density, but convection could be important at high wind velocities. Operating the greenhouse at internal pressures as low as 0.1 Earth atmosphere has been discussed, but it appears that plants may not tolerate pressures below 0.2 or 0.3 Earth atmospheric. Conduction and natural convection inside the structure will be greatly reduced at 0.1 Earth atmosphere but will become more important if the pressure is increased.

During the day, the greenhouse will receive direct radiation from the sun and some diffuse radiation. The greenhouse will lose radiant energy to all of the very cold surrounding objects and depending on sky conditions, it will lose radiant energy to cold portions of the sky away from the sun. At night, the surrounding objects will be even colder and the greenhouse will lose radiant heat to the cold sky.

Preliminary calculations indicate that in the middle of the day and in the middle of the summer, a greenhouse can operate on Mars if radiation losses are controlled, but a practical greenhouse design must be designed for conditions during the winter and at night year round.

The presence of plants complicates the heat transfer analysis by adding latent heat transfer (evaporation and condensation) to sensible heat transfer (conduction, convection and radiation). Plants consume carbon dioxide and give off oxygen during photosynthesis, but they also respire and require a small level of oxygen. Plants also give off water vapor during transpiration. The changing mix of carbon dioxide, oxygen and water vapor in the greenhouse must be accounted for in heat transfer analysis. Other factors of importance include leakage from the hydroponics plumbing and condensation on the inside of the greenhouse wall.

There is a great deal of uncertainty about most of these design factors except for outside temperature, and even this will vary with location on Mars. The first step is to decide on the best available values for external ambient conditions. The question of the internal pressure is critical for design of the components of the greenhouse. Once the outside design conditions have been established and the internal operating pressure has been selected, then the environmental control system must be designed with the needs of the plant in mind.

References

1. Abarbanel, J. E. and M. E. Criswell. 1997. Design development of an inflatable module for a Lunar/Martian base. SAE Paper No 972486. 27th International Conference on Environmental Systems, Lake Tahoe, Nevada.
2. Aldrich, R. A. and J. W. Bartok. 1994. Greenhouse Engineering Northeast Regional Agricultural Engineering Service. Ithaca, NY.
3. ASCE. 1995. Minimum Design Loads for Buildings and Other Structures. ASCE-7-95. American Society of Civil Engineers, New York, NY.
4. Evans, L. T. 1963. Environmental Control of Plant Growth. Academic Press. New York, NY.
5. Fowler, P. A., R. Wheeler, R. Bucklin and K. Corey. 2000. Low Pressure Greenhouse Concepts for Mars. Mars Inflatable Deployable Workshop.
6. Hanan, J. 1998. Greenhouses: Advanced Technology for Protected Horticulture. CRC Press. Boca Raton, FL.
7. Irvine, H. M. 1981. Cable Structures The MIT Press. Cambridge, MA.
8. Leonard, J. W. 1988. Tension Structures: Behavior and Analysis. McGraw Hill. New York, NY.
9. Muser, G. and M. Alpert. 2000. How to go to Mars. *Scientific American*. 282(3): 40-51.
10. NASA. 2000. Mars Fact Sheet. <http://nssdc.gsfc.nasa.gov/planetary/factsheet/marsfact.html>
11. National Research Council. 1985. Architectural Fabric Structures: The Use of Tensioned Fabric Structures by Federal Agencies. National Academy Press. Washington, DC.
12. Nowak, P. S., W. Z. Sadeh and L. A. Morroni. 1992. Geometric modeling of inflatable structures for Lunar base. *Journal of Aerospace Engineering*, ASCE, 5(3): 311-322.
13. Otto, F. 1973. Tensile Structures The MIT Press. Cambridge, MA.
14. Robbins, F. V. and C. K. Spillman. 1980. Solar energy transmission through two transparent covers. *Transactions of the ASAE*. 23: 1224-1231.
15. Sadeh, W. Z. and M. E. Criswell. 1995. Inflatable structures for a Lunar base. *Journal of the British Interplanetary Society*, 48(1): 33-38.
16. Schroeder, M. E. and P. J. Richter. 1994. A membrane structure for a Lunar assembly building. Proceedings of Space 94, The 4th International Conference on Engineering, Construction and Operations in Space. American Society of Civil Engineers, New York, NY. pp 186-195.
17. Shaeffer, R. E. 1996. Tensioned Fabric Structures: A Practical Introduction American Society of Civil Engineers. New York, NY.
18. Timoshenko, S. and S. Woinowsky-Krieger. 1959. Theory of Plates and Shells McGraw-Hill. New York, NY.

Preliminary Estimates of Possibilities for Developing a Deployable Greenhouse for a Planetary Surface (Mars)

V. Ye. Rygalov¹, R.A. Bucklin², P.A. Fowler³, and R.M. Wheeler³

¹Institute of Biophysics, Krasnoyarsk, Russia

²Dept. Agric. and Biol. Eng., Univ. of Florida, FL, USA

³Kennedy Space Center, FL, USA

Introduction

Mars is one of the planets nearest Earth in the Solar System. Climatic conditions on Mars somewhat resemble those of the polar regions of Earth, so this planet is a prospect for exploration in the near future. However, the long-term success of this exploration will depend on the possibilities of plant production on the Martian surface.

Work done to date, including the BIOS-3 Project of 1960 to 90 in Russia, EEC Project of 1960 to present, CELSS Program of 1960 to present in Russia, USA, Japan, and elsewhere, and the Biosphere-II project, can furnish data to estimate plant production capabilities for a Deployable Greenhouse (DG) on Mars.

Physical conditions on the Martian surface demand specialized facilities for sustaining the growth of terrestrial plants. The ambient atmospheric pressure is less than 1% of Earth's, with an average temperature near -57°C to -60°C . There are large daily (23°C to 73°C) and seasonal (-125°C to 18°C) thermal fluctuations. A Martian day is 1.027 X that of Earth's, while year on Mars is 1.88 of Earth's. Annual average insolation is approximately 0.43 of Earth's, or about 600 W m^{-2} , and changes in seasons of the Mars year are 1.45 times those of Earth. These conditions can cause dust and sand storms on the surface of Mars when wind speeds exceed $\sim 100\text{ m s}^{-1}$. The normal duration of such storms is 50-100 days. The height of a storm can exceed 7-15 km (5). Dust and sand from these storms could accumulate on a DG on Mars and reduce the light transmitted into DG if it is not removed.

Two of the main conditions for plant growth and development on the Martian surface are irradiation (optimal range from 80 W m^{-2} to 180 W m^{-2} of photosynthetically active radiation) and temperature (optimal range from 20°C to 27°C). The only known natural source of energy on Mars is sunlight, with a general intensity of $589 \pm 142\text{ W m}^{-2}$ (Martian Solar Constant, calculated from data in 4, 5, and 6).

Comparisons of plant growth requirements with conditions on the Martian surface are presented in Table 1, while some basic considerations for implementing plant growth in a Martian DG are presented in Table 2. The general scenario and approximate schedule of startup and development of operations in the DG are shown in Table 3. Issues related to mechanical maintenance and repair of a DG on the Martian surface are not addressed in this paper.

Table 1. Growth conditions and demands for higher plants in a Martian surface greenhouse.

Parameter	Units	Low value	High value	Optimal value	Expected outside range [5]	Proposed actions to maintain plants in DG
Temperature	°C	+5.0	+35.0	+20 to +27	-125 to -10	Additional heating, up to 500 W/m ²
Atmospheric pressure	kPa	10.0 (?)	100	100	0.5 to 0.7	Stock of atmospheric gases
Photosynthetically active light (400-700 nm)	W/m ²	50	500	150 to 200	0 to 277 (outside DG) 0 to 90 (inside DG)	Additional illumination up to 100 W/m ² PAR
Partial pressure CO ₂	kPa	0.03	3.0 to 5.0	0.1 to 0.2	0.5; 95% of vol. of atmosphere	Artificial composition of atmosphere with low pressure
Partial pressure O ₂	kPa	5.0	27 to 30	10 (?) to 22	Trace levels	
Relative Humidity	%	55	100	70 to 85	~0.1 % of vol. of atmosphere	Rapid water recycling in low atmospheric pressure

Table 2. Problems of implementing a plant production system in closed, unmanned volumes.

Problem	Initial Approach to a Solution	Source of Data for the Approach	Comments	Nearest experimental works
1. CO ₂ -supplying, -O ₂ -removal & accumulation.	1A. Burning of carbon stock (biomass, packaging) 1B. Injection of CO ₂ -enriched from storage, with simultaneous extraction of O ₂ -enriched air for storage.	BIOS-3 experiments (IBP data) BIOSPHERE - II NASA's CELSS program and other.	The system of O ₂ accumulation will increase the weight of the DG Probability of successful realization p ₁ =1.	Growth of plants in atmospheres of low pressure and modified composition.
2. Provision and maintenance of plant nutrients.	2A. Use of nutrient-enriched, synthetic soil for plant growth 2B. Continual monitoring and correction of pH and nutrient levels in solutions.	Greenhouse SVET (IBMP- Moscow) BIOS-3, NASA CELSS, Biosphere-II, KARUSEL (at IBP -Krasnoyarsk), Others.	The weight of the DG is practically the same in both variants. Probability of successful realization p ₂ = 1.	Restoring and continuing work on supplying plants with liquid nutrients in low gravity conditions.

3. Heat exchange.	Using special engineering constructions (e.g., double layer extrusion from synthetic materials) and configuration.	Experience of heat removal from space stations. Experiments needed to determine thermal conductivity and transfer of simulated Martian soils.	Any additional installations make the DG heavier. Probability of successful realization $p_3=1$	Experiments with small scale DG-model to evaluate heat exchange in conditions similar to Martian surface. Selecting DG materials and developing configurations.
4. Dust removal from DG and additional illumination.	4A. Removal of dust by automated, mechanical systems 4B. Installation of lighting system.	Experience from BIOSPHERE-II, BIOS-3, and others. Additional experiments in rarefied atmospheres are needed.	Installation of dust-removal systems for increases the weight of DG. It is possible that natural processes (e.g. wind) will limit or control dust accumulation. Probability of successful realization $p_4=1$	Experiments with small scale DG-models to evaluate dust accumulation mechanisms and related conditions of illumination. These to be combined with heat exchange experiments.
5. Spectral composition of light.	Combination of natural light, transmitted through transparent material, and artificial light of special spectral composition.	Greenhouse SVET, BIOS-3, NASA-CELSS. Experiments with the transparent materials for DG are needed.	Additional lighting. Probability of successful realization $p_5=1$. These estimates need evaluation by materials specialists.	Selection of materials to reduce the UV radiation.
6. Managing the chemistry of the transpired water and water recycling.	Develop on Earth the requirements for the stock of correcting salts and reagents.	BIOS-3 long-term experiments, NASA CELSS, and others.	This problem will appear when people arrive at the DG on Mars. Probability of successful realization $p_6=1$.	Humidity experiments in combination with heat exchange experiments.
7. Contamination by microbial & organic materials (may develop during long-term operations).	Catalytic thermal oxidation of microbial & organic contaminants in air.	BIOS-3 long-term experiments & the BIOSPHERE-II 2-year experiment. Additional long-term experiments are needed.	Oxidizing microbial & organic contaminants may produce oxides that are toxic for plants. Thermal oxidizing equipment will increase weight of DG. Probability of successful realization $p_7=0.9$.	Long-term experiments with microbial composition of closed environments containing higher plants.
8. Unknown factors: Influence of low gravity, high level of space radiation, etc.	Experiments with higher plants in MIR and Intl. Space Station.	Data about higher plant growth in space station MIR (NASA & Institute of Biomedical Problems, Moscow).	$p_8=?$	Experiments with higher plants in conditions approaching that of Mars (Intl. Space Station and MIR)

Table 3. Possible scenario for deploying an inflatable greenhouse on a planetary surface.

Name of Phase	Approximate Time of Development, Days
1. Arrival, installation and inflation on the surface of the planet: installation of supplemental lighting, start of the water cycle, supply of nutrients and CO ₂ , installation of additional lighting and heating, etc.	0.3 to 7 d; depends on DG sizes and level of technical development.
2. Initiation of plant growth: planting and cultivation of different crops, accumulation and extraction of O ₂ , adjustment of nutrient solutions.	~ 90 d; depends on the time of development of the slowest crop.
3. Arrival of personnel: initiation of closed cycle air exchange, nutrient supply, and water recycling; and of harvesting, processing and transportation of solid plant matter, etc.	Up to 180 d for steady-state operations. Confirmed by direct experiments in BIOS-3

The duration of the first stage of deployment is determined by engineering and technical considerations, and could be up to one week. The duration of the second stage is determined by biological considerations, especially the development time of the slowest crop. Faster-growing crops might be started later to synchronize finish times for crew arrival. Alternatively, early maturing crops may have to be maintained in an air-dry state while other crops grow to maturity. The last stage's duration depends on the overall goals and schedules of the Mars mission.

All the following calculations and estimates are based on a 3-member crew, mainly because:

- A. Standard crew for an DG should include at least a technical engineer, a biologist-agronomist, and a medical specialist.
- B. For the BIOS-3 project, all experiments were conducted with a 3-person crew, so the data from that work may be applied directly, without recalculation.
- C. It is easy to manage an DG of such dimensions.
- D. An DG functions as one entity, with one stock of substances and one system of controls. The 3-person DG can be duplicated if numbers of participants increase.

Experiments with the BIOS-3 System showed that for supplying three persons with oxygen, water, and the vegetable part of their diets (35% to 45%), lighting of 120 to 150 W m⁻² PAR was adequate on 94.5 m² (where 41.0 m² was for plant growth, 31.5 m² was for habitation, and the remainder was walkways). Volume of the BIOS-3 facility used for these tests was 244.25 m³, with an unused volume of 78.75 m³ and area of 31.5 m² available for emergency / contingency.

Initial approaches to solving problems of Martian DG implementation

1. CO₂ supplying – O₂ removal and accumulation

Maintenance of the composition of the atmosphere for automatic plant cultivation can be provided by at least two modes (Table 2).

1A. Burning of the waste carbon, for example dry cellulose. It can easily be operated automatically. According to the experiments with the BOIS-3 System [2, 3] the dry weight of plant products which supply a 3-person crew by vegetarian diet, water and oxygen are about 173 kg. 70-80% of this weight is polysaccharides. So, the initial stock of cellulose for the DG is

about 130 kg. 43 kg is the stock of mineral salts for nutrient solutions. A consequence of burning waste carbon would be the consumption of O_2 .

If it is proposed to maintain plant cultivation after the initial plant conveyor is established, the stock of cellulose must be increased. In any case the probability of realization of this element of DG development can be estimated as $p_1=1$.

1B. Technically it is easy to inject air enriched in CO_2 or CO_2 from the Martian atmosphere, while simultaneously extracting and storing O_2 -enriched air. In principle, it is possible to estimate the probability of this as $p_1=1$. Experiments are needed to determine how often the enriched CO_2 atmosphere must be injected into the DG, and what degree of enrichment is optimal. This approach obviously increases the weight of the system by the addition of containers and pumps. In any case, when the crew arrives, they become the main source of CO_2 for the plants.

2. Correction of nutrient solutions

There are extensive data from calculations and operations of plant production facilities on the use nutrient solutions for plant cultivation in controlled environments [2, 3]. The question is how to automatically and remotely manage these solutions. Two possible approaches are:

2A. Use of a synthetic soil substrate for plant growth, enriched by biogenic solutions. Numerous data are accumulated in the Institute of Biomedical Problems (IBMP, Moscow) and in the framework of NASA's CELSS program. So, the probability of realizing this approach can be estimated as $p_2=1$.

2B. Continual monitoring and correction of pH and nutrients levels in solutions [2, 3]. There are numerous data in this area from the BIOS-3 project (IBP, Krasnoyarsk) and in from CELSS program experiments. When we know the average plant productivity and biomass composition through growth and development, it is possible to calculate frequency and quantity of additions/corrections to nutrient solutions. The correction of pH could be made automatically with a pH-meter. Because these operations would be similar to those on Earth, the probability of success could be estimated as $p_2=1$.

3. Heat exchange

Mars receives an average of 600 W m^{-2} of solar radiation [4, 5, 6]. During a dust storm, perhaps 30% of this reaches the surface of the planet, and during a clear time about 70%. Thus the atmosphere can attenuate 170 to 400 W m^{-2} , depending on conditions. In the DG, almost all of the remaining incident radiation will convert to heat because the relatively low photosynthetic conversion efficiency (e.g., up to 5.0% - 8.0% converted to biomass). Heat removal to the Martian atmosphere is difficult because it is less than 1/100 the density of Earth's atmosphere. Thus the DG will gain heat by solar radiation, any supplemental heat, and waste heat from any supplemental lighting system.

Heat transfer from objects inside DG will involve conduction through the air mass to the walls, convection within the air mass, and radiant heat exchange between objects inside and the wall material. Depending on the temperature of the walls, latent heat exchange involving evaporation and condensation of water on the wall surfaces will also occur.

Synthetic materials can be treated or coated to block infrared in the same way that glass does, but they still might be thin with low thermal resistance, so the wall materials will reach equilibrium with the outside environment. Here, conduction heat transfer between the outside wall surface and the outside environment should be minor, and convection heat transfer to the atmosphere should be minor, except when air velocities do reach rates of near 100 m s^{-1} .

The outside surfaces of DG will exchange radiant heat with the sky and with all objects in their field of view. The rate of this transfer will depend on the emissivities, absorptivities and

temperatures of the outside wall surfaces, the surrounding objects, and the sky temperature. The temperatures of the outside and inside wall surfaces will be close to equal if the thermal resistance of the wall material is low. If the thermal resistance of the wall material is high, then the inside wall temperature will approach the inside air temperature, and the outside wall surface temperature will reach some value in equilibrium with the outside overall thermal environment.

A rough estimate of the thermal range in the Martian DG can be made from the equation:

$$\dot{T} = \left\{ \frac{\left(\frac{1}{k_R} - 1\right)(k_T J_o + I_o)}{\left(\frac{1}{k_R} - 1\right) + k_T} + H - \frac{k'_T \cdot \sigma T^4}{k'_R \left(\frac{1}{k'_R} - 1\right) + k'_T} - \frac{k_s + \psi k_A}{\ell} (T - T_o) \right\} \frac{C}{c m};$$

where:

k_R = coefficient of reflection of light from inside of DG ($0 < k_R < 1$);

k_T = coefficient of transmittance of light inside of DG ($0 < k_T < 1$);

k'_R = coefficient of reflection of long-wave's infrared radiation from inside of DG ($0 < k'_R < 1$);

k'_T = coefficient of transmittance of long-wave's infrared radiation outside of DG ($0 < k'_T < 1$);

k_s = coefficient of thermal conductivity of DG's material into Martian soil;

k_A = coefficient of thermal conductivity of DG's material to the Martian atmosphere;

C = area of light absorbing surface (floor) of DG;

c = heat capacity of the Greenhouse (includes capacities of water, plants, walls, etc);

m = average prearranged mass of DG;

ℓ = thickness of the material of DG;

J_o = the intensity of outside source of light (Martian Solar Constant);

I_o = the intensity of inside source of light;

H = the intensity of additional inside the DG heating;

T_o = average temperature outside the DG;

T = average temperature inside the DG;

ψ = DG shape geometrical coefficient (ratio, of the area of surface that is contacting the Martian atmosphere, to the area of the floor);

σ = Stefan-Boltzmann constant, for radiation of absolutely black body.

If heat conductivity of the atmosphere is not high, and the deviation of inside DG temperature from outside temperature is not large, it is possible to use this next approximation:

$$\dot{\Delta T} = \left\{ \frac{\left(\frac{1}{k_R} - 1\right)(k_T J_o + I_o)}{\left(\frac{1}{k_R} - 1\right) + k_T} + H - \frac{k'_T \cdot \sigma T_o^4}{k'_R \left(\frac{1}{k'_R} - 1\right) + k'_T} \left[1 + 4 \frac{\Delta T}{T_o} \right] - \frac{k_s}{\ell} \Delta T \right\} \frac{C}{c};$$

where: $\Delta T = T - T_o$

By using this approximation, it is possible to get some estimates of the temperature ranges in DG related to outside temperatures, and of the additional actions that would be needed to maintain optimal temperatures for growth of terrestrial plants. The correct values of some significant coefficients are unknown at this time. So, we need to make reasonable assumptions concerning them:

- $k_r = 0.25$ (assumed on the basis of data from [1, 4];
- $k_f = 0.93$ (assumed and calculated on the basis of data from [1, 4];
- $k_r' = 0.05$ (assumed on the basis of data from [1, 4, 6];
- $k_f' = 0.8$ (assumed on the basis of data from [1, 4, 6];
- $k_s = 2.1 \text{ W} \cdot \text{cm/m}^2 \cdot \text{grad}$ (assumed on the basis of data from [4];
- $l \sim 1.0 \text{ cm}$ (assumption);
- $\sigma = 5.67 \cdot 10^{-8} \text{ W/m}^2 \cdot \text{grad}^4$ (value from [4, 6]; calculation)
- $J_0 = 589 \text{ W/m}^2$ (calculation on the basis of data from [4, 5, 6].

The results of these calculations are presented in Table 4.

Table 4. Estimates of temperatures in DG on Martian surface, and additional actions needed to maintain the optimal range

Different times of Martian day and year	Temperature (°C)		Additional actions to maintain the optimal range of temperatures (calculations)
	Martian surface [5]	DG without additional actions (calculations)	
1. The end of night and early morning.	-73	-73	Additional illumination or heating up to 600 W/m ² .
2. About noon	-23	+24.4	There are no additional actions.
3. Evening and early night.	-45	-42.3	Additional illumination or heating up to 300 W/m ² .
4. Winter (about noon)	-125	-14.0	Additional illumination or heating up to 100 W/m ² .
5. Summer (about noon)	-18	+26.1	There are no additional actions.

For more precise estimations, we need in more accurate data about round-the-clock and round-the-year values of the basic parameters of the Martian environment at different latitudes. In addition, more accurate values are needed for the coefficients in the mathematical models. These values could be found from experiments with small scale physical DG models in conditions approaching the Martian environment (low temperatures and pressures in an atmosphere containing 97% CO₂, with sand and dust depositing on surfaces, etc.). The basic elements of plant growth implementation in the Mars DG are presented in Table 2. The general scenario and schedule of the startup and development of operations in the DG are in Table 3. I have not considered problems of mechanical maintenance and repair of the DG on the Martian

surface for this discussion because it is not directly connected with plant growth, but clearly these are important issues.

4. Dust accumulation and conditions of illumination

The intensity of illumination in DG can be calculated according to the formula:

$$I = k_1 \cdot k_2 \cdot k_3 \cdot k_4 \cdot I_0,$$

Where I_0 - intensity of illumination on the Earth (Solar Constant);

k_1 - decrease caused by greater distance from Sun, than Earth;

k_2 - decrease in the atmosphere of Mars;

k_3 - decrease by dust accumulated on the surface of DG;

k_4 - decrease in passing through the transparent material of DG.

If $I_0 = 1.37 \text{ kW m}^{-2}$ [4, 5, 6];

$k_1 = 0.43$ [5];

$k_2 = 0.30$ (in the dust storm); $= 0.71$ (in the clear sky) [5, 6];

$k_3 = 0.3$ to 0.5 (currently unknown; assumption);

$k_4 = 0.33$ to 0.53 (currently unknown; assumption and calculation from [1]).

So, the range of insolation in DG could be:

$$I = (0.047 \text{ to } 0.194) \text{ kW m}^{-2}$$

Photosynthetically active radiation (PAR) is approximately 47% to the total solar spectrum. That is I of PAR would be ~ 0.022 to 0.091 kW m^{-2} . The low value is less than the PAR compensation point for photosynthesis of some plants, while the higher value is acceptable for photosynthetic productivity, but lower than optimal. Accordingly, in this situation, it is probably better to have the capability for additional illumination in the DG for optimal plant growth and development. This estimate is based on a narrow band of equatorial Martian latitudes, and in the part of the Martian orbit which is nearest the Sun. But it is well known that the orbit of Mars is very elliptical. Alternatively, a special installation for dust and sand removal from DG surface would be needed. This would increase the intensity of PAR entering DG by a factor of 2 or 3. In addition, about 8% of the UV (ultraviolet light) needs to be filtered out [6] to protect terrestrial plants. The probability of successful realization $p_4=1$.

5. Spectral composition of light

Spectral composition of the solar light on Mars is important, particularly the portion of UV (ultraviolet). The intensity of incident UV must be reduced, which is probably not technically difficult. Light transmittance testing of transparent materials for the DG is needed. The IR (infra red) needs to be absorbed by DG. So, the probability of realization of this element of plant growth is $p_5=1$, because it depends on the selection of materials for DG. This evaluation should be done in more detail by group of specialists.

6. Management of the chemistry of transpired water

This problem becomes important when people arrive at the DG on Mars. Experiments with the BIOS-3 System, for example, showed that after some additional cleaning and mineralization, transpired water can be used for drinking, for sanitation and other uses, after the usual boiling [2, 3]. Numerous measurements showed that 1 m^2 of illuminated plant gives 6.2 to 7.1 L day^{-1} of condensed water. So the needs of one person could be satisfied with at little as 2 to 3 m^2 occupied by higher plants [1,2].

Thus, the initial stock of water for DG for 3 persons can be estimated as follows: water, circulating between plants in the phytotrons - 100 to 200 kg (according to BIOS-3 data); water, accumulated in the biomass of the plant system - 164.4 kg (according to BIOS-3 experimental data); evaporated water (at an operating temperature of 20°C) not more than 6.9 kg (according to ref. 3 and BIOS-3 data). Therefore, the whole stock of water would 271.3 to 371.3 kg. Probability of realizing water cycle can be estimated as $p_6 = 1$, based on the successful experiments in BIOS-3, the CELSS-program, and Biosphere-II. Calculations from a simple mathematical models shows that humidity in a Martian DG with the same dimensions as BIOS-3 could be about 75%.

6. Contamination by microbial and organic materials

Experiments with the BIOS-3 system showed that microbial growth did not reach steady-state conditions in quality and quantity during 180 days of continuous operations (1, 2). There were no dangerous microbial influences on the plants during that period. However, such contamination could be a problem for longer-term operations as in the Mars mission, and in general, it may be among the more troublesome technical areas for the long-term success of the project.

In any case, in a characteristic period of up to 90 days (the time for development of plant production in the DG) the probability of realization of acceptable conditions for plant growth in this item can be estimated as $p_7 = 0.9$, because the problem only appears in long-term operations. Duration of the Mars mission is about $t \approx 2$ years. Based on successful experimental operations with BIOS-3, in the microbial organic contamination time might be estimated at $T \sim 20$ years. So p_7 can be estimated according formula $p_7 = 1 - t/T \approx 0.9$.

7. Unknown factors

There could be long-term influences from low gravity on higher terrestrial plants, from high levels of space radiation, or from other unanticipated factors. So, it is difficult to estimate the probability for p_8 . Thus is it important to continue the experimental program with higher plants with MIR and the International Space Station.

Conclusions

The general probability of successful realization of the DG project based on this data can be evaluated as:

$$P = p_1 \cdot p_2 \cdot p_3 \cdot p_4 \cdot p_5 \cdot p_6 \cdot p_7 \cdot p_8 = 1.0 \cdot 1.0 \cdot 1.0 \cdot 1.0 \cdot 1.0 \cdot 1.0 \cdot 0.9 \cdot ? \approx 0.9 \text{ (neglecting } p_8 = ?)$$

Thus an uncertainty of 0.1 must be eliminated by experiments within the 3-year period of preparation of the DG Project for the Mars mission.

A preliminary list of experiments to prepare for the DG is presented in Table 2 (last column), and a preliminary evaluation of the minimum weights of the biological part of DG is presented in Table 5.

Clearly there are lingering uncertainties. For example, the probability of success may be lower than estimated; e.g., $p_8 \cdot p \rightarrow 0$. Hopefully the planned 3-year program of work under conditions similar to those of Mars will reduce these uncertainties.

For better estimates, and for further development of DG project, the following is needed:

1. Detailed data on the ranges of the Martian surface climatic and environmental parameters (round-the-year and round-the-clock values of insolation, temperatures, heat exchange, wind velocity, atmospheric density, etc).
2. More precise mathematical models, describing:
 day-to-night environmental changes of the planet surface,
 heat exchange between DG and the thermal environment of Martian surface,
 and possibly other factors.
3. Designing DG configurations according to optimize the ratio of wall area to contained volume (low values assist in retaining heat, while higher values can provide better lighting).
4. Selecting and developing DG cladding materials that afford a high level of natural illumination and heat conservation at the same time (e.g., double layer extrusion).
5. High thermal resistance of wall material to prevent condensation or freezing of evaporated water on inside surface of the DG walls.

Table 5. Minimum initial mass of materials for development of a plant production system based on BIOS-3 experiences (for 3 persons).

Main components	Mass	Comments
1. Seeds and other materials for planting	39 kg	High mass is caused by chufa and potato. If seeds only are used, weight can be reduced.
2. Biomass/cellulose for burning	130 kg	---
3. Stock of nutrient salts	43 kg	---
4. Synthetic soil substrate and material for mechanically maintaining plants upright	About 2000 kg	If expanded clay aggregates are used. If synthetic materials are used, mass could be reduced.
5. Initial water	270 - 370 kg	---
6. Initial atmosphere (dry air)	About 394 kg	If DG is operated at lower pressure, this could be reduced.
Total weight	2876 to 2976 kg	Could be decreased by using synthetic materials and by implementing a DG project with reduced atmospheric pressure and/or modified composition.

Bibliography

1. Closed system: Man and higher plants (4-month experiment). Prof. G. M. Lisovsky (ed.). Novosibirsk, Nauka (Siberian Branch), 1979, 160 p.
2. Experimental ecological systems including men. /Problems of space biology, V. 28, Moscow, Nauka, 1975, 312 p. Acad. V.N.Chernygovskiy (ed.).
3. Handbook of Chemistry and Physics. A Ready-Reference Book of Chemistry and Physical Data. Charles D. Hodgman, (ed.). Chemical Rubber Publishing Co.
4. Ksanfomaliti L.V., Rediscovered Planets. Moscow, Nauka. 1978, 152 p.
5. Ksanfomaliti L.V., Rediscovered Planets. Moscow, Nauka. 1978, 152 p.
6. McGraw-Hill Encyclopedia of Science & Technology. 8th Edition. An International Reference Work in Twenty Volumes, 1997.

Low Pressure Greenhouse Concepts for Mars

Philip A. Fowler

Dynamac Corporation, Kennedy Space Center, FL

Raymond M. Wheeler

NASA, Kennedy Space Center, FL

Ray A. Bucklin

Agricultural and Biological Engineering Department, University of Florida, Gainesville, FL

Kenneth A. Corey

Department of Plants and Soil Science, University Massachusetts, Amherst, MA

Abstract

A project was initiated to begin testing some environmental limits for managing plant growth systems. These limits will help determine some of the concepts for building plant enclosures for use on Mars. In particular, the study focuses on the effects of reduced atmospheric pressures. Structural design is considered as it relates to the biological processes that would occur within that structure. The design must be closely tied to the functionality of the biological system and has a few primary concerns that need to be tested to resolve the question as to the path of design. Early test indicate that plants can survive and grow at low (>76 mb) pressure.

Background

The Martian surface is a cold (-143°C to 17°C), dry environment with a very low-pressure atmosphere (7 to 9 mb). The gas makeup of the atmosphere consist of 95.3% CO₂, 2.7% N, 1.6% Ar, 0.13% O₂, and traces of other gases (McKay, 1984). There is no evidence of any surface water, but water in the form of ice may exist as subsurface permafrost (Levin and Levin, 1999). Solar radiation from the sun has a mean of 590 W m⁻² with much higher levels of ultra-violet wavelengths reaching the surface (McKay, 1984).

In order to grow plants on the surface of Mars some protective structure must be provided to maintain a viable environment. Some concerns for such structures are: they must be able to maintain temperatures of ~15°C to 30°C, provide light at a level that will promote growth, maintain an atmosphere with the proper gas mix and pressure, and have a low mass and sufficient volume. Mass and volume are directly related to structure design and influenced by the previous concerns. In order to achieve the best mass/volume combination it is necessary to determine the lowest pressure, light, and temperature range that will grow plants efficiently.

The project does not consider the actual design of such structures but relies on design concepts to influence how plants will react to a given environment based on structure design. The crossover of structural design and plant environment can be seen when one considers the issue of transparency of the structure. If the structure is transparent and allows sunlight to be used as the primary energy input, then the level of light available to the plant must be adequate for viable growth. This becomes complicated because lightweight transparent films do not insulate well enough to maintain an acceptable growing temperature. Another consideration of lightweight films is the amount of structural stress that they can withstand. This is determined by the minimum inside pressure of the structure that is required to grow plants. The lowest pressure that plants will tolerate and still grow efficiently is not known. In addition, some plants require a relatively large volume, which means the structural stress will increase with volume. As the structure grows in size the total stress on the structure increases to a point beyond the ability of the transparent thin films limits, without adequate structural reinforcement. If more

reinforcement is added the transparency is reduced and a point of diminishing returns is reached. Design and development of transparent, high-strength, and high r-value thin films is needed to help further research for Mars greenhouse structural design. Because there is no definitive answer as to plant minimum requirements for growth it is not possible to design a structure at this time that will meet all the criteria required. Other options include opaque structures with electric or concentrated solar lighting. These structures allow for better thermal control and higher strength capabilities with some increase in mass cost. If the structure is opaque then it is possible to make it large enough to be human rated from a mobility standpoint and perhaps from an atmospheric one as well. The ability to maintain a low pressure in the structure has many benefits, such as low gas loss to the outside, the potential for using in situ gases for pressure maintenance, lowers the need for supplied make-up gases, reduces heat loss, reduced structural stress, and facilitates easier shipping and deployment.

Structural geometry is an important consideration when designing an environmental container. Geometry determines the amount of surface area of the structure both inside and out. The surface area will determine three important considerations in design, the total stress, the gas leak rate, and the mass heat transfer. When plants are first propagated, they require little volume to continue growth. As plants mature they need an appropriate volume to match their size (Prince and Bartok, 1978). Different plants require different amounts of volume at maturity. The ideal structure would expand and collapse in accordance with the desired volume needed for plant growth. This change in volume would reduce the required atmospheric gases and increase the efficiency of the system. Geometry also influences the ability for use of ambient light, air circulation, cycling of water/humidity, and access to the plants. The ability to illuminate the plants will be affected by the geometric shape of the structure. If the structure is transparent (Figure 3), then the shape will determine where the light comes from and the degree of attenuation it will have as it passes through the film. If the structure is opaque, then its size can increase and the lights could be mobile within the structure to maximize light usage. The ultimate shape will be determined by the manner in which the structure is deployed. A flexible structure will lend itself to rounded shapes, while rigid-structure will tend to have more flat space (Figure 5). A compromise might use an inflatable expanding foam concept (Figure 4), where the shape can be inflated to a dome or cylinder and then rigidized into a solid structure. The total surface area of any particular shape will greatly influence the thermal characteristics of the structure. The lower the surface area the lower the heat loss in the structure.

Materials considerations in the building of a greenhouse structure will not be addressed in this paper (see Sandy, 2000) but the requirements for those materials are a consideration for this study. The outside shell material, depending on the path taken (transparent or opaque), will need to withstand the rigors of the Martian atmosphere, including ultra-violet radiation and low temperatures. The inside shell must be able to withstand high humidity, interaction with nutrient solutions, thermal stress, and bio fouling. Internal components must be made of materials that can tolerate any volatile organic compounds associated with plant growth. The biological interactions of materials in the structure must be kept at a minimum so that they remain functional throughout the mission. All of the materials must be able to undergo extreme temperature changes imposed from the transit part of the mission.

One of the best gauges of how effective any part of a space mission is the return from mass delivered into space or equivalent system mass (Drysdale, 1995). Most components of a space mission have no return, other than being required to accomplish the mission, this is not the case when it comes to Advanced Life Science (ALS). The mission of ALS is to generate the necessities of life from on board or in situ materials and then to recycle as much of that as is possible. This can reduce the mass required to launch and give a potential return on investment. There is no such thing as a closed loop system, which means that there will always be some required input and some loss from the system. The Mars Greenhouse Project is an attempt to maximize the utilization of plants for life support at the lowest mass required.

Methods and Materials

In an effort to define low pressure limits for plant production systems, a series of tests was initiated to define humidity sensing and control capabilities, heat rejection issues associated with electrical lighting, dissolved oxygen (DO) in nutrient solutions, and plant transpiration responses. Tests were carried out in a vacuum chamber located at KSC (Thermotron, Figure 1). This chamber is ~1.22m x 1.22m x 2.4m giving a volume of ~3.57m³ which does not account for reduced volume from mechanics and instrumentation. It is capable of going to a low pressure of less than 1 mm Hg with thermal control of about a 1KW heat load. At low pressure, the ability to remove heat is greatly diminished.

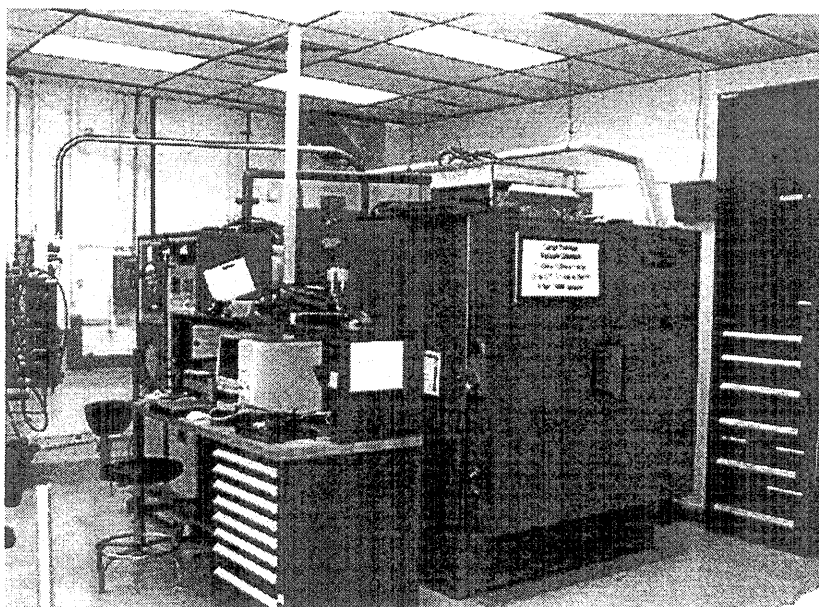

Figure 1 Thermotron test chamber

To support plant testing, a light test stand consisting of three 400 W high-pressure sodium (HPS) lamps was assembled. The removal of the heat from the lamps was handled efficiently by the Thermotron cooling system, but as the air was cooled, the moisture condensed, thus reducing the humidity. In order to maintain humidity in the system two impeller type humidifiers were added. This addition of moisture to the system helped to achieve a relative humidity (RH) of >75% at low pressures ≤ 20 kPa but were insufficient to maintain 75% RH at 10 kPa. Maintaining humidity control was critical to assessing plant transpiration rates at low pressure. These tests did show that plants could survive at low pressure. For a more in depth description and results (see Corey et al. 2000). These early tests concluded that some means of heat removal would be required to continue test in the Thermotron. To address this problem, two approaches were pursued: addition of two more humidifiers, and incorporating a water barrier for the removal of the excess heat. The addition of more humidifiers did maintain a higher humidity but created large amounts of water condensing to the chamber floor. We then designed a water barrier to be placed under the lamps to aid in the removal of heat. This barrier consisted of three sheets of acrylic plastic, a 25 mm middle core, with cutouts to allow for water, and two outer 3 mm sheets to contain the water. The barrier had one inlet and one outlet. The first static test on the barrier leaked at 14 kPa. The barrier was then reinforced with angle aluminum and 3 mm through bolts and tested again. This time it did not leak but burst at about 27 kPa. This then led to version three, which used 6 mm polycarbonate, sheets as an outer skin. The next test obtained about 103 kPa before shearing one of the through bolts. Next version used 6 mm bolts and was tested again. When pressured to the maximum expected pressure (137 kPa) there was a small amount of leakage but the outside skin distended approximately 25 mm from the flat plane (Figure 2). This distention shows how a small amount of pressure can cause large amount of stress.

It is estimated that over 17000 N of force was exerted on each panel. This testing was for the worst case scenario and although the barrier may have worked, we have since been delivered a water jacket enclosed HPS lamp (250 W) designed by Phil Sadler (Sadler Machine Co. Tempe, AZ). We tested the lamp with its surrounding water jacket and found it satisfactory at worst-case pressures expected. Based on this preliminary test, we plan to replace the three 400 W HPS lamps with three water-cooled lamps. Assuming that about 70% of the lamps output is long wave radiation and that most of the long wave radiation from these lamps can be removed by the water jackets, this should remove $400 \text{ W} \times 0.7 \times 3 = 840 \text{ W}$ of the added heat. The water is circulated through an access plate and cooled outside the chamber thus removing the heat.

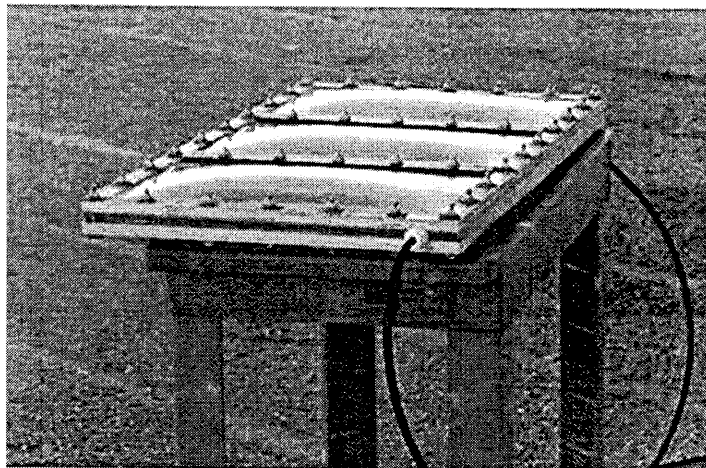

Figure 2 Water barrier test.

One of the unknowns when we started the project was whether the instrumentation would work at low pressure. Certain types of instruments are unaffected by low pressure such as thermocouples and pressure sensors, while others such as humidity sensors, dissolved oxygen (DO) probes, or pH could be sensitive. We tested various types of humidity sensors to determine their capabilities at different pressures. The instruments tested were: Vaisala HMI 41 Humidity and temperature indicator (capacitance type), Edgetech Vigilant hygrometer (chilled mirror type), LI-COR 6252 (infrared type), and the basic wet/dry bulb type systems. The test consisted of taking the instruments down in pressure and reading their outputs. This information was logged and plotted as shown in Figure 6, showing the variation in readings from the different instruments. All of the tracked closely with each other except the infrared detector, which tended to be slightly lower at lower pressures. We suspect the infrared detector was not given enough time to equilibrate to the conditions. From this test, we can conclude that pressure did not adversely affect the ability of the sensors to detect humidity levels. When final design of the control system is considered the selection will be either the wet/dry bulb sensor or the Vaisala sensor, other criteria such as maintenance may be primary factors deciding the ultimate selection.

An important factor in the growth of plants is the amount of DO present in the root zone. In a reduced pressure atmosphere, the DO in soils or nutrient solutions should be related to the partial pressure of oxygen. For many crops, DO levels need to be kept at $\sim 3\text{ppm}(\text{mg/l})$ or greater to achieve optimal growth. A YSI model 51B oxygen meter was tested to determine its capabilities at low pressure. The experiment consisted of the probe being placed in a container of water inside the vacuum chamber. The pressure was lowered and the water was allowed to equilibrate and readings were taken. These readings were then plotted and compared against the theoretical predictive values (Figure 7). This test showed that the instrument was unaffected by the reduced pressure, which suggests that this type of probe should be useful for low-pressure greenhouses.

Using the vacuum chamber for low-pressure test has certain challenges when trying to get the data. Quite often only sensors from instruments are placed in extreme environments and the data is then relayed via electrical lines outside. When operating a system on Mars it is apparent that all of the sensing system will have to operate at the Mars ambient conditions. We have chosen to put all of the instrumentation in the environment that it will have to operate. The fact that the experiment is at a different pressure means that some interface must be done to bring data from a low-pressure level to a high-pressure level. Initially the readings were taken by directly reading the instruments through a window in the chamber. This system did not work, as quite often when pressure changes were made the window would mist over preventing readings. The chamber has now been outfitted with an internal network that allows instruments to be connected on this network to get the data out. All of the instruments selected have a RS232 protocol output. This protocol does not allow multiple units on the same network. To solve this problem RS232 to RS485 converters are used. The RS485 protocol is a current sensing system that can then be multiplexed onto a multi-drop 3-wire system. Each 232/485 converter has an address that is unique. This gives the ability to communicate with each instrument individually and log the data outside the chamber. Some of the instruments are able to operate independently which then leads to a distributive type system. Should any of the instruments fail this will not stop the other instruments from reporting their data. A central computer is responsible for communicating with each data and then logging the data.

Results and Discussion

These early tests have shown the difficulty in conducting low-pressure plant test. Although the Thermotron chamber can supply some of the data required to gain knowledge in low-pressure studies, it is not the ideal test bed. Further testing will be conducted in this chamber with adaptations being made as necessary. Upgrades to the lighting system are underway and when completed should help resolve the humidity control situation. At present only short-term test have been conducted. Long term tests are needed with better monitoring and control. A dedicated low-pressure plant growth chamber is needed to conduct long term test. The system needs to be automated for maximum data collection. A CO₂ controlled injection system is required to conduct certain photosynthesis test. The project needs a series of models to be developed which include heat transfer models, Mars ambient light supply model, plant growth at extreme conditions model, power usage model with respect to lighting and heating, deployment schemes, materials models, and others.

References

1. Corey, K.A., P.A. Fowler, and R.M. Wheeler. 2000. Plant Responses to Rarefied Atmospheres. This proceedings.
2. Drysdale, A.E. 1995. The Effect of Resource Cost on Life Support Selection. SAE Technical Paper 951492. 25th International Conference on Environmental Systems.
3. Levin, G.V. and R.L. Levin. 1998. Liquid Water and Life on Mars. <http://www.biospherics.com/mars/spie2/spie98.htm>. Biospherics Inc. Beltsville, MD
4. McKay, C.P. 1984. A Short Guide to Mars. In: P.J. Boston (ed.) The Case For Mars, Vol. 57:303-310. American Astronautical Society, Science and Technology Series. Univelt, Inc. San Diego, Ca.
5. Prince, R. P. and J.W. Bartok, Jr., 1978. Plant Spacing for Controlled Environment Plant Growth. Transactions of the ASAE 21:332-336, 1978.
6. Sandy, C.R. and D. Cadogan. 2000. Inflatable Structures for Mars Greenhouse Concepts. ILC Dover, Inc. This proceedings.

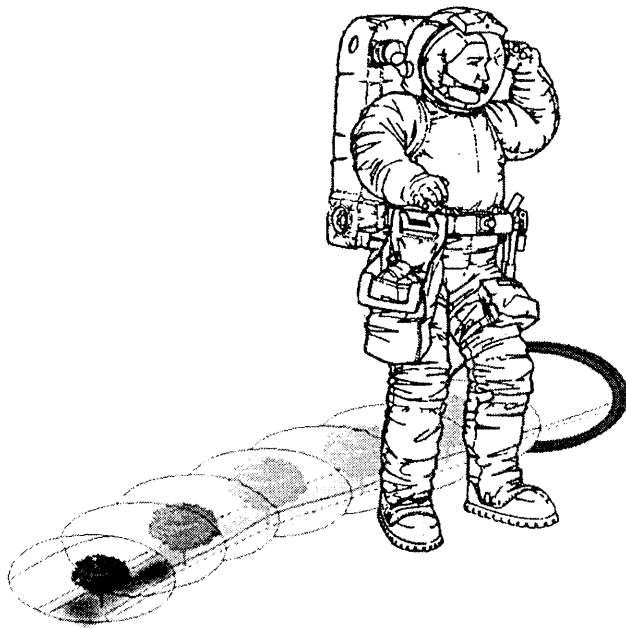
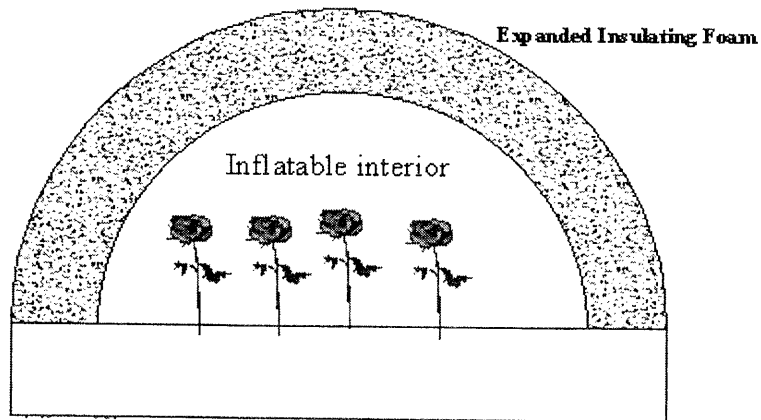

Figure 3 Clear expanding tube on Mars



Expanded foam greenhouse structure

Figure 4 Expanding foam rigid structure

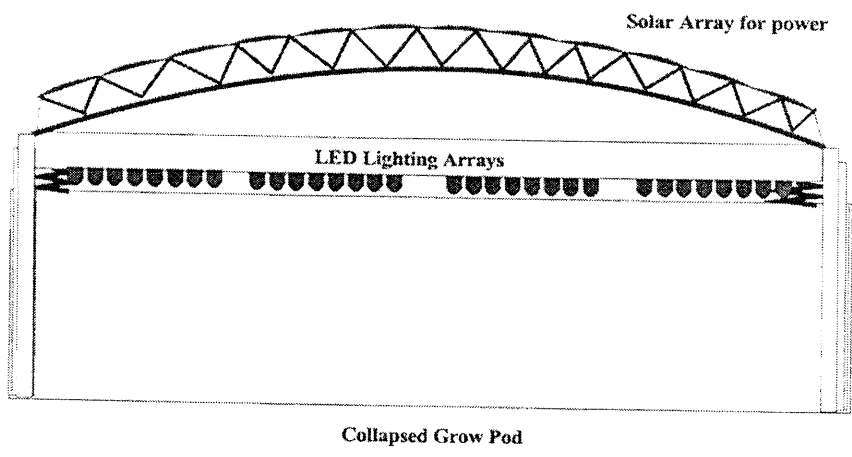
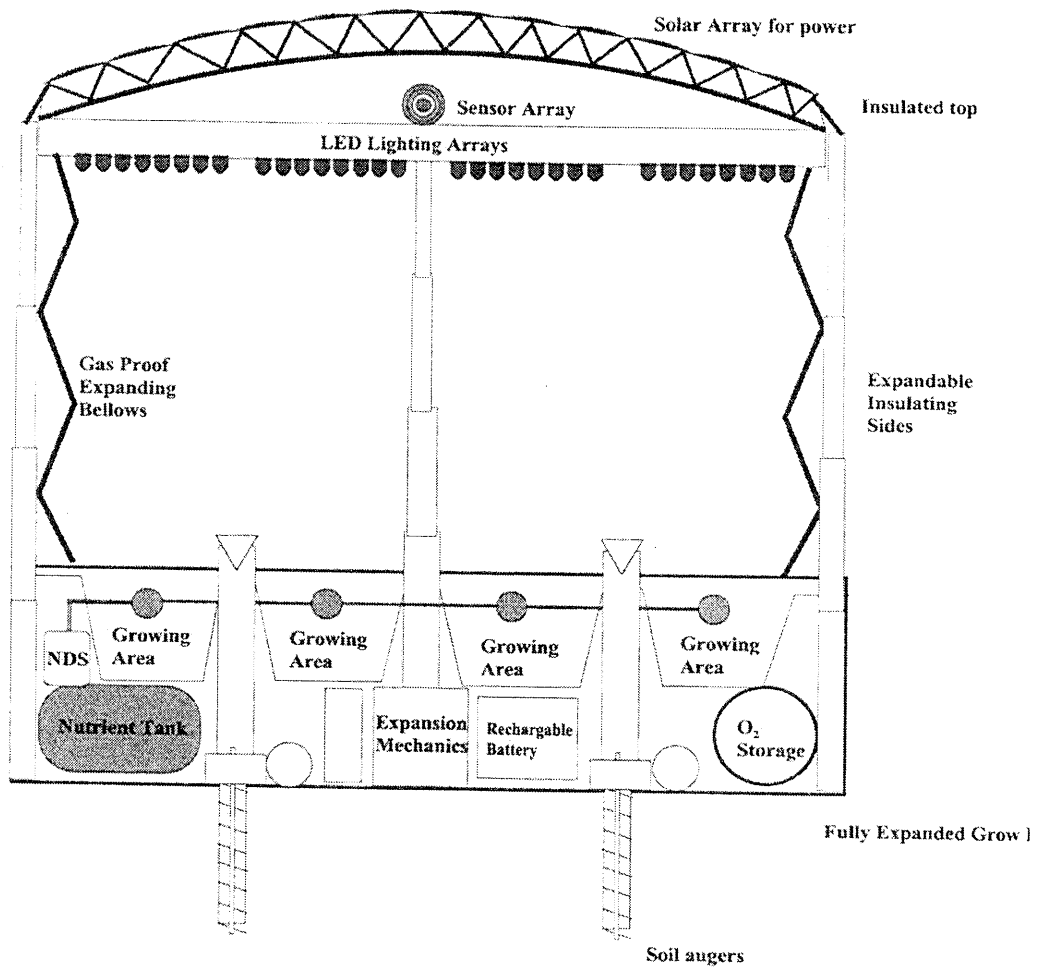

Figure 5 Rigid expanding structure

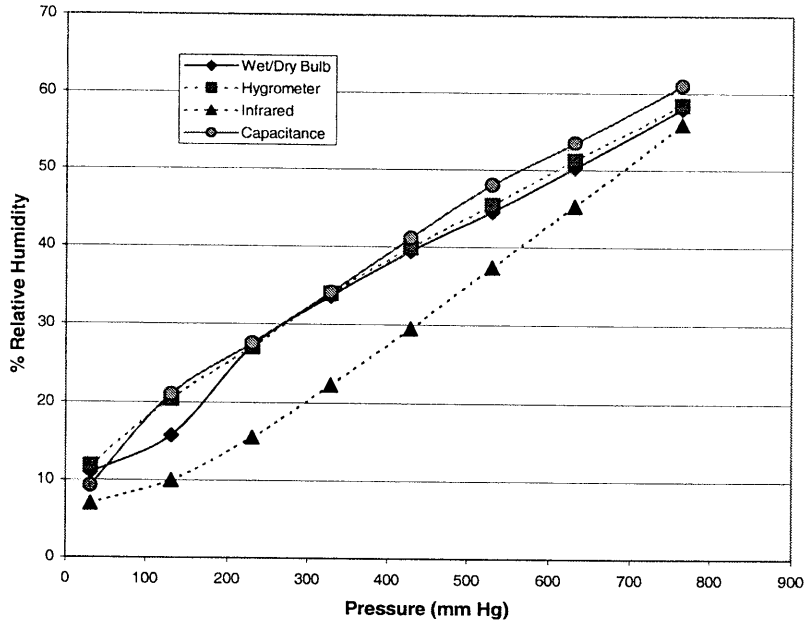

Figure 6. Comparison of humidity sensors at different atmospheric pressures.

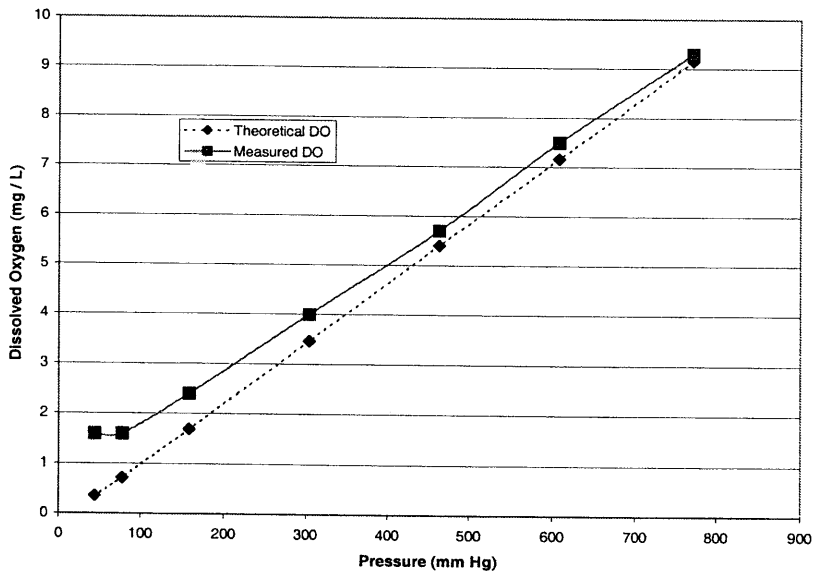

Figure 7. Dissolved oxygen (DO) vs. atmospheric pressure (21% O₂).

Mars Greenhouse Study: Natural vs. Artificial Lighting

Bruce Gertner
Lockheed Martin Space Mission Systems & Services
Science, Engineering, Analysis, and Test
2400 NASA Road 1, P.O. Box 58561, Houston, TX 77258-8561
September 21, 1999
Task Order 9HECECAYS
HDID-2G42-1167
LMSEAT 33214

This paper discusses a preliminary study that compares artificial light to the natural lighting for growing crops on Mars. This study relates the amount of edible plant mass that would be grown to the amount of light available as:

$$\text{Edible} = 0.77 \cdot \text{PAR} - 6.1$$

where *Edible* is the of edible plant mass produced, g/(m²·day), and *PAR* is the lighting level of photosynthetically active radiation (PAR) in mol/(m²·day) [1]. This equation defines the relationship between light and edible plant growth within this study. The assumption that the crew needs 0.97 kg food/(crew-day) was used with the above equation to calculate the area that is needed to grow enough food for a Martian year (686.5 Earth days). Assuming 6 crewmembers, the total amount of food needed in a Martian year is 3995.4 kg. By using the above correlation and the total amount of PAR for each scenario, the total growing area to provide the correct amount of food for each scenario was determined. With the area, all other assumptions (see Table 1. Assumptions and Values) were translated into mass, volume, power, and cooling [2]. Then, those numbers were translated into an equivalent systems mass (ESM) [2].

The three scenarios chosen were a rigid biomass production chamber (BPC), an inflatable greenhouse, and a hybrid greenhouse that utilized some artificial light. Some systems were not included in the ESM calculation. All air, water, solids, and similar systems were assumed to be the same for all scenarios. The thermal equipment was assumed to be the same in each scenario except for the equipment involved in cooling the lights and plant machinery. The plant nutrient system was assumed to be the same since the same amount of edible plant mass was grown. The differences in these three cases were the amount of lighting used, the amount of support structure and machinery used, and the equivalent volume of the various outer structures.

The level of available PAR depended upon whether natural lighting or artificial lighting was used. To determine the amount of natural lighting, some assumptions were made involving deep space radiation and what might happen as it passes through the Martian atmosphere [3]. Atmospheric conditions for nominal weather and local dust storms were calculated. That dust storms would prevail for the "winter" season was also assumed. With these assumptions, the average daily PAR on Mars was calculated as 20.8 mol/(m²·day). The actual amount of daily PAR changes throughout the Martian seasons. This would cause a variance in the amount of edible biomass grown. One assumption was that food was stored during the year when excess was grown. For the times when natural lighting conditions worsened and did not allow the generation of enough food, the stored food made up the difference. When artificial lighting at 1000 μmol/(m²·s) is used, there is 43 mol/(m²·day) of PAR. When 400 μmol/(m²·s) of artificial lighting is used, there is 17 mol/(m²·day). Also, the lower the transmittance that can actually be achieved, the more comparable the hybrid system becomes to the natural greenhouse system. The higher the transmittance the more favorable the natural greenhouse system is over the other two systems. The assumed overall transmittance for the greenhouse in this study was 85%. The reduction from 100% transmittance is to account for structural interference and material for all natural lighting calculations.

The end result of this study was that the inflatable greenhouse using only natural lighting (ESM of 52 MT) was only marginally better than an inflatable hybrid system (ESM of 55 MT). Both performed better than a rigid BPC arrangement (ESM of 113 MT). {MT is a metric ton equivalent to a Mg.}

- The rigid BPC was much more massive than either the inflatable greenhouse or the hybrid system. The rigid BPC had a large ESM (113 MT) for two reasons. First, though the overall volume for a rigid BPC is considerably less than either of the other options, the mass per volume for the rigid structure at 66.7 kg/m^3 is significantly heavier than the inflatable structures at 2.07 kg/m^3 . Second, the high power and cooling requirements associated with the completely artificial lighting also contributed to its high ESM.
- The power and cooling requirements for machinery accounted for most of the ESM (52 MT) associated with the inflatable greenhouse. The machinery power and secondary structure mass were significant because the growth area was triple that of the rigid BPC.
- The hybrid system had an ESM (55 MT) because it made use of natural lighting plus some artificial lighting. Using artificial light required a quantity of power, yet it was sufficient to reduce the area significantly. Still, this did not help reduce its mass below that of the inflatable greenhouse that used only natural lighting.

The results of this study depend heavily upon the assumptions made. The following items need further evaluation to test the ideas presented in the study:

- The lighting levels on Mars need to be measured to a greater accuracy, especially spectral distribution with regard to PAR for plant growth.
- The inflatable greenhouse concept needs further development, including all support structure and machinery needed to use the greenhouse.
- Plant growth at both low pressure and low light levels needs further investigation to accurately quantify yields.
- Investigations need to be performed to determine edible yields for specific crops at these varying conditions, and how transpiration and gas exchanges are affected.
- Any further analysis of this topic will need the full-time support and expertise of a horticultural scientist.

<u>General</u>			<u>Secondary structure and Machinery [2]</u>		
Number of crew	6	Crew	Mass per Area	9.8	kg/ m ²
Total Edible grown needed	0.97	kg/E day/crew	Volume per Area (Estimate)	0.5	m ³ / m ²
Total Edible grown needed	5.82	kg/E day	Power per Area (Estimate)	0.3	kW/ m ²
Duration	1	Mars yr	Cooling per Area (Estimate)	0.3	kW/ m ²
Duration	686.5	E day			
Duration	668	Mar day	<u>Lighting for 1000 μmol/ m²/s [2]</u>		
Martian Day	24.665	E hr	Lamp per Area	5.07	lamp/ m ²
Duration	16476	E hr	Mass per Lamp	0.21	kg/lamp
Total Edible grown needed	3995.4	kg	Volume per Lamp	0.000625	m ³ /lamp
			Power per Lamp	0.4	kW/lamp
			Cooling per Lamp	0.4	kW/lamp
			Mass of cooling equipment	7.02	kg/m ²
<u>Plants</u>			<u>Lighting for 400 μmol/ m²/s</u>		
Edible=0.77*PAR -6.1			Lamp per Area (0.4 times above)	2.028	lamp/m ²
	Edible	g/ m ² /E day	Mass per Lamp	0.21	kg/lamp
	PAR	mol/ m ² /E day	Volume per Lamp	0.00625	m ³ /lamp
Note: Must have at least	200	μmol/ m ² /s	Power per Lamp	0.4	kW/lamp
			Cooling per Lamp	0.4	kW/lamp
			Mass of cooling equipment (0.4 times above)	2.808	kg/m ²
<u>Greenhouse</u>			<u>Volume per growth Area</u>		
Transmittance Efficiency	0.85		BPC Length	11.3	m
Average PAR	20.754	mol/ m ² /E day	BPC Diameter	4.572	m
PAR is a function of season			BPC growth Area	82.4	m ²
			BPC Volume	185.5	m ³
			BPC Ratio	2.25	m ³ / m ²
			Length of Greenhouse	15.0	m
			Diameter of Greenhouse	7.6	m
			Width of growing area (2m tall, 1m clearance)	4.46	m
			Greenhouse growth Area (length *width)	66.9	m ²
			Greenhouse Volume (Semi cylinder)	340.2	m ³
			Greenhouse Ratio	5.08	m ³ / m ²
<u>BPC</u>					
PAR if constant 1000 PPF	43	mol/ m ² /E day			
<u>Hybrid</u>					
PAR if constant 400 PPF	17	mol/ m ² /E day			
Transmittance Efficiency	0.85				
Average PAR	20.754	mol/m ² /E day			
PAR is a function of season					
<u>ESM Costs [2]</u>					
Volume BPC (ISS module)	66.7	kg/m ³			
Volume Inflatable	2.08	kg/m ³			
Power	87	kg/kW			
Cooling	66.7	kg/kW			

Table 1. Assumptions and Values

REFERENCES

1. Wheeler, R., *et al.* "NASA's Biomass Production Chamber: A Testbed for Bioregenerative Life Support Studies." *Adv. Space Res.*, Vol. 18, No. 4/5, pp. 215-224, 1996.
2. Drysdale, A. and Hanford, A. "Advanced Life Support Systems Modeling and Analysis Project Baseline Values and Assumptions Document." JSC-39317 (CTSD-ADV-371), National Aeronautics and Space Administration, Johnson Space Center, Texas, June 1999.
3. Hanford, A., Lockheed Martin Space Operations, Houston, Texas. Personal Communications. September 1999

Wire Culture for an Inflatable Mars Greenhouse and Other Future Inflatable Space Growth Chambers

Philip D. Sadler
Sadler Machine Co., 416W. 14th St., Tempe, Arizona 85281-5655, USA

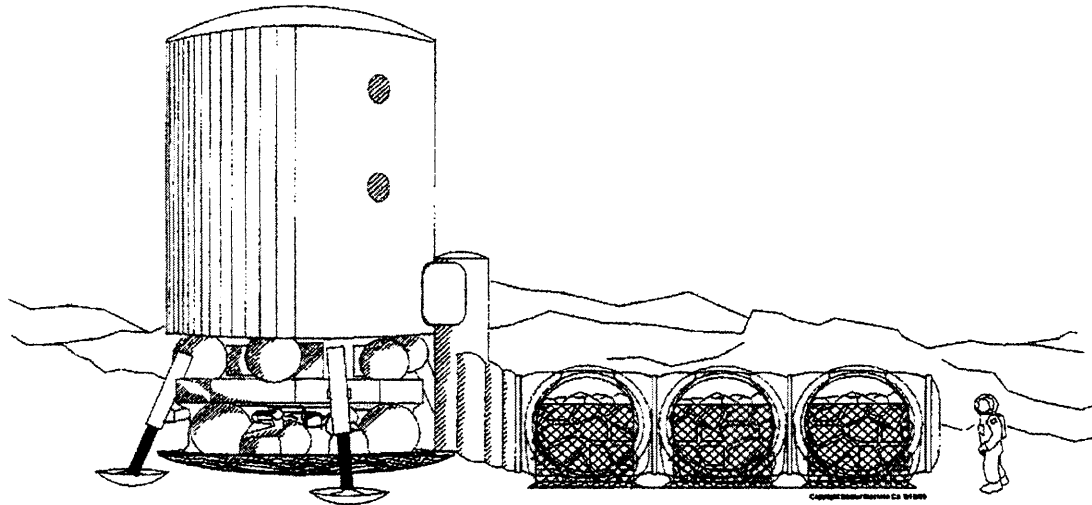

Mars Lander With Inflatable Greenhouse Deployed (Fig.1)

Introduction

With the initiation of construction of the International Space Station (ISS) and the proposed manned missions to Mars, on site food production and atmosphere/water revitalization utilizing photoautotrophs grown in space growth chambers may become a primary component of future space endeavors. Inflatable structures are also proposed for future space growth chamber application, and their inherent low total systems mass can be of major benefit to mission planners. To maximize the degree of mission suitability of an inflatable growth chamber structure, it necessitates the development of a growing system that possess attributes that work in concert with the containment structure, like compressibility, minimal attachment points to the soft portions of the inner shell, and low mass. The goal of this paper was to propose and illustrate a growing system that could exploit the benefits of the inflatable structure to the fullest while offering the potential for maximum crop production.

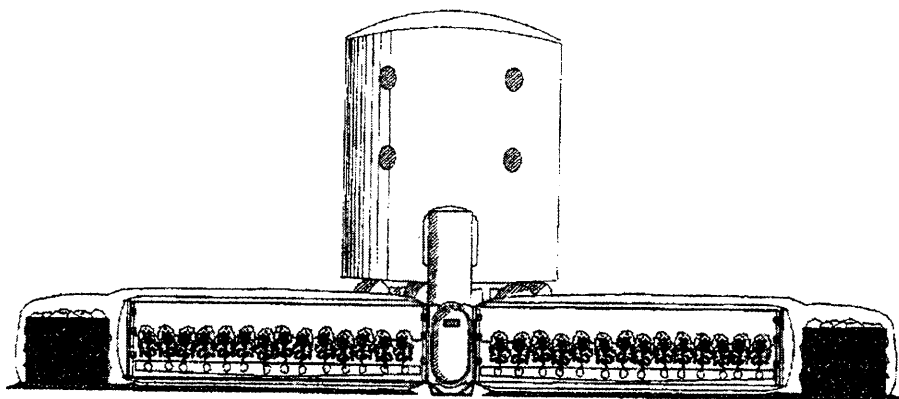

Front View Mars Inflatible Greenhouse (Fig.2)

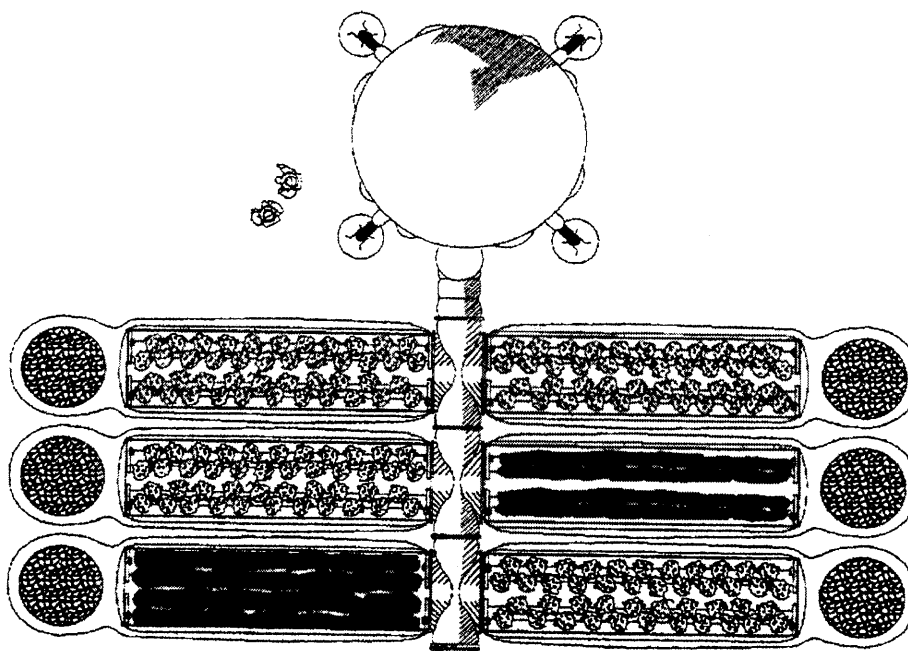

Top View Mars Inflatible Greenhouse (Fig.3)

Copyright Sadler Machine Co. 9/10/99

Strategies

Numerous strategies for the manned Mars missions have been proposed. Careful consideration of these strategies is needed to ascertain the growth chamber requirements for these future missions. Multiple Mars mission landing sites will be selected in probably a similar manner as the Apollo Lunar landing sites, with each visit to a different site. Some strategies call for an advanced cargo vehicle to land at the site before the manned Mars piloted vehicle. With the carbon dioxide rich atmosphere of Mars, an inflatable greenhouse could be deployed autonomously from an unmanned cargo vehicle, and have harvestable crops waiting for the arrival of the manned vehicle. The piloted Mars lander, either with or without the cargo vehicle included in the mission, could utilize a manually operated growth chamber on missions of sufficient duration for crop production (Fig.1, 2,3).

Phobos, the closest moon of Mars, has been sited as a potential source for mining frozen water and carbon dioxide and a future space station for Mars. If a plentiful supply of water can be found on Phobos and successfully mined, it could be brought to ISS by the returning Mars mission vehicle, and converted into fuel for the next Mars mission along with being utilized for ISS support. Also, bladders filled with frozen Phobos water, affixed to the exterior of a space vehicle or module, could be utilized for radiation and micrometeorite protection. As illustrated (Fig 10), the mining process may produce holes that could in-turn be utilized for autonomous growth chambers, producing freeze-dried grain and beans, to be collected by the following Mars mission when they visit Phobos to recover the water.

ISS, in the future may be a candidate for a small inflatable growth chamber that has its own light collection system and operates in micro-gravity (Fig.13). This ISS growth chamber could be similar to a possible application on the manned Mars mission vehicle. And probably, at some point in time, another series of manned lunar missions may be undertaken. Autonomously and manually operated growth chambers could be part of a lunar research effort with chambers similar to what Phobos might require (Fig.12).

Wire Culture

Wire culture, cable culture, and/or bag culture has been around for some time and is one of many variations of Nutrient Film Technique (NFT) water culture. Wire culture consists of the plants being grown in plastic membrane bags suspended from support wires with nutrient solution flowing to the plant roots. This growing system consists of relatively lightweight and flexible materials, wire and plastic membrane material, that can be compressed and included into the uninflated growth chamber structure while stowed for transit and returned to their proper orientation upon inflation. Suspending membrane bags along an uninterrupted wire with the aerial portion being supported along another uninterrupted wire immediately above, allows all the plants of that row to be drawn along the wires toward an end point where a harvesting device might be located. The grain, bean, or sweet potato could be extracted as the bag unfolds and the row is pulled through the harvesting device, with the inedible portion going directly to the composter or incinerator. Cleaning of the growing membrane could be as simple as rolling up the growing bag and putting it into a conventional clothes washer.

Wire culture might be a particular advantage to mission planners to have an inflatable growth chamber that can work for extended periods in an autonomous mode. With wire culture, it is possible to have multiple growing bags, sandwiched closely together on their own separate wires, with seed tape loaded into the bag, with nutrient flow being provided to only the first bag of this group. Upon maturity and harvest, a second bag has its flow initiated by a remote operator, and the cycle is continued over a long period of time until all the bags have been utilized, then replenished by the next crew. Or, a single set of growing bags loaded with seed could be left for years by the last mission to use the growth chamber, and months before the next mission arrives, the nutrient flow could be initiated remotely, having a crop waiting for them.

Following are inflatable growth chamber applications for possible future 21st century space efforts using wire culture. Common to the following chambers is a basic cylindrical shape made of either

transparent membrane and/or of multilayered insulated material similar to a space suit or Transhab. Also in common is at least one solid working surface holding a wire securing framework and access door at one end and at the other is one moveable wire securing framework that attaches to the other end of the soft membrane cylinder structure. These two frameworks are connected by four cables and the cabin pressure keeps the cables stretched tight with considerable force. Also included on the two end wire frames are attachment points for the wires that hold the plant growing bags, support the upper portion of the plant, and support the supplemental lighting system. The wire securing framework has numerous wire securing points to allow any arrangement of wires to be utilized for maximum flexibility in cultivation of a wide variety of crops.

Mars Greenhouse

The manually deployed Mars surface greenhouse is intended to be attached to the Mars lander and consists of six separate growth chambers, connected by a central spine passage (the number of chambers could be increased by adding more growing units on the end of the central spine) (Fig.4). The central spine would be made up of insulated multi-layered durable materials similar to the construction of a space suit and would connect to the Mars lander and provide a pressurized passage to all six growth chambers (Fig.7). The metallic components of the central spine would consist of six bulkheads, a connecting walkway, overhead supports to connect the opposing bulkheads together, and a support framework that connects to the bottom of the bulkheads to keep the central spine elevated above the surface material (Fig.6, 8).

The bulkhead would connect the central spine passage to the six individual growth chambers. Around the perimeter of the bulkhead would be the attachment points of the bulkhead to the spacesuit like material making up the walls of the central spine and the growth chamber's clear membranes. This attachment to the bulkhead would provide a pressure tight seal isolating the central spine and the growth chambers. The bulkhead would include a pocket door that would allow access to each of the growth chambers, and in the advent of decompression of one of the growth chambers, the door would be shut automatically to maintain central spine interior pressure (Fig.9). Around this pocket door would be located the required hydroponic support hardware, nutrient reservoirs, pumps, plant ventilation fans, supplemental lighting cooling system, and electronic hardware. Jumpers would be utilized between the six bulkheads and the main Mars lander, to connect in series, supply feeds like oxygen recovery from the chambers, waste water condensate from the lander for hydroponic nutrient water make-up, cooling water for condensing pre-potable water from the growth chambers interior humidity, hot water recovery from the supplemental lighting, and the required wiring harnesses. If decompression of one of the growth

Individual Growth Chamber And Central Spine

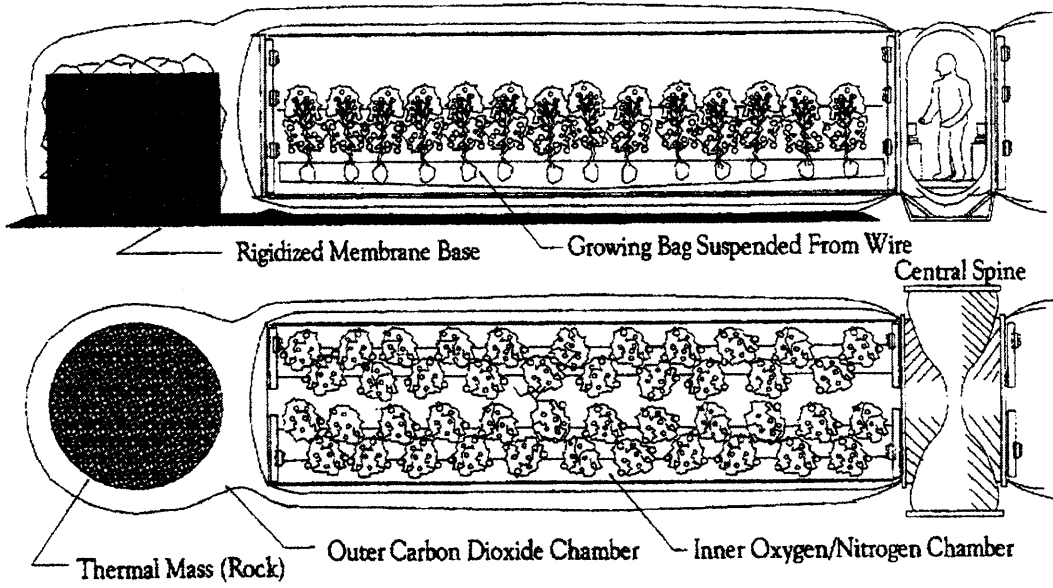

(Fig.4)

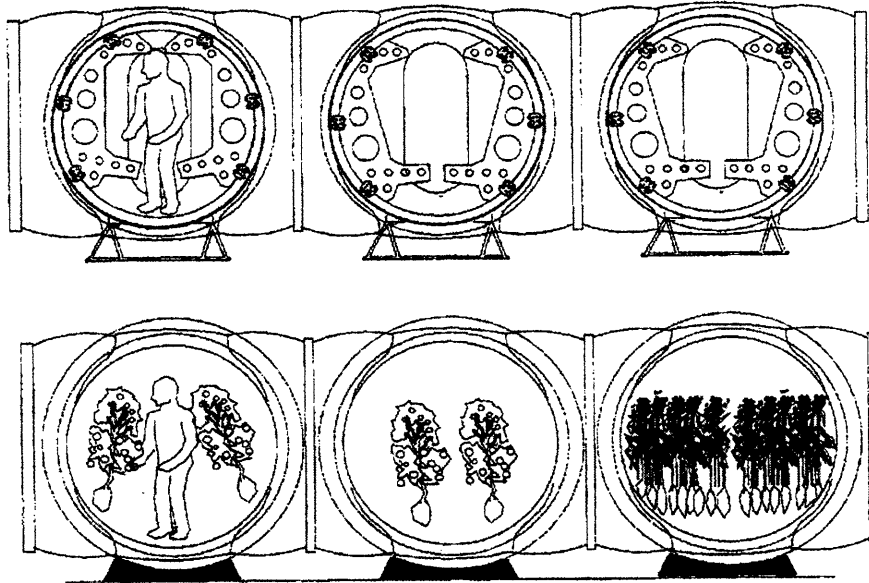

X-Section of growth chambers showing central spine bulkhead with rotating wire frames, growing bags suspended from support wires, and plants rotating upward to allow passage.

(Fig.5)

Mars Inflatable Greenhouse Exploded and Cut-away Views of Metallic Components

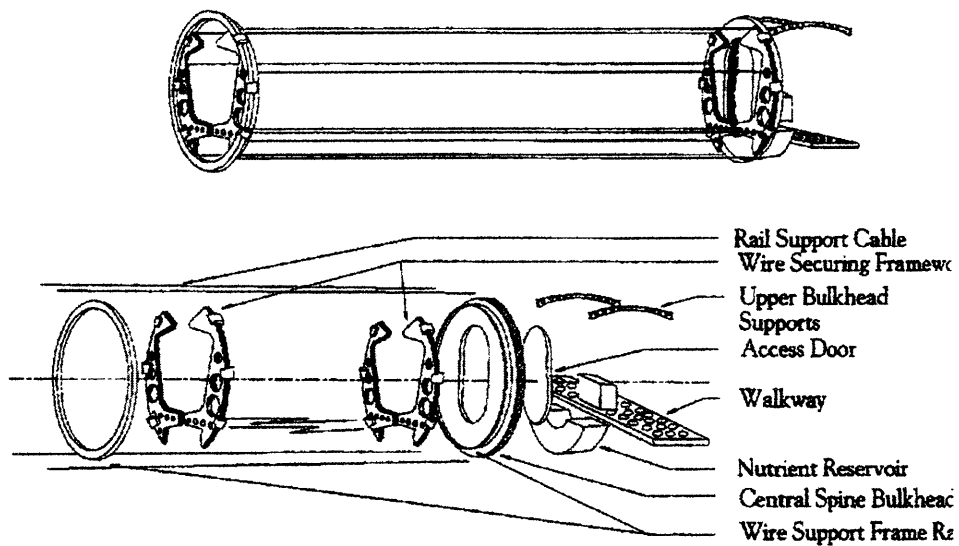

(Fig.6)

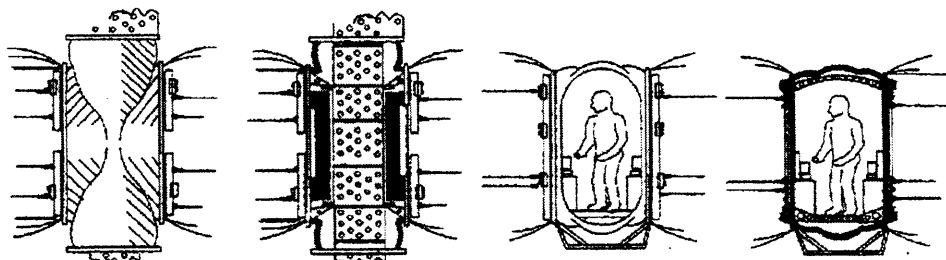

Top View X-Section

Front View X-Section

(Fig.7)

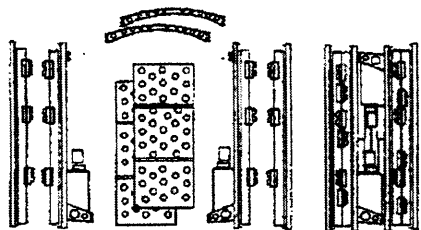

Chamber Component Package for Transit

(Fig.8)

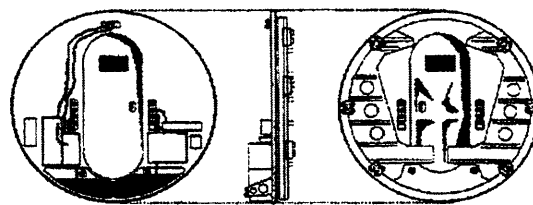

Back View

Side View

Front View

Central Spine Bulkhead

(Fig.9)

Copyright Sadler Machine Co. 9/10/99

chambers did occur all penetrations of that bulkhead for plumbing and ventilation would automatically be closed, so as not to allow loss of cabin pressure from the central spine.

The environment of Mars will present sizeable challenges for the development of a growth chamber membrane that will be able to withstand the extreme cold of Mars while retaining its structural integrity. The growth chamber with only a two membrane wall, that is required for light passage, represents a greater crewmember hazard than does the central spine passage with the multi-layered wall material similar to a space suit. The crewmembers would need to limit the amount of time actually in the growth chambers to as little as possible. It might be necessary for crewmembers not to be able to enter the growth chambers and instead use robotic devices to plant and harvest crops. This will all depend on if a suitable membrane material can be identified or developed that satisfies all safety concerns about crewmembers occupying the growth chamber.

The growth chamber part of the greenhouse consists of two chambers, an inner chamber where plants are grown and the atmosphere is shared with the Mars landers and an outer chamber where the atmosphere of Mars is concentrated from outside to provide a carbon dioxide rich atmosphere maintained at a lesser pressure than the inner atmosphere (Fig.4). In the advent of catastrophic depressurization of the inner atmosphere, the outer membrane of the carbon dioxide atmosphere would be able to capture the escaping oxygen atmosphere and allow a crewmember to vacate the chamber without suffering the debilitating affects of depressurization. Having the second membrane and atmosphere is very important from a safety standpoint, but also extremely important from a thermal dynamic position in that if the extreme cold temperatures of Mars are able to come in contact at any point with the humid atmosphere of the inner chamber, condensation and precipitation occur. This results in condensation forming on the membrane and loss of transparency, reducing available light for plant growth. Losses will occur in production of pre-potable water, algal and possibly plant pathogen growth will occur, and it produces a housekeeping situation that requires constant attention. The outer carbon dioxide chamber will need to maintain its temperature above the dew point, so as not to have the inner membrane promote condensation of the inner atmosphere. Also, the outer carbon dioxide chamber will need to be filtered, as to not allow dust to collect on the transparent membrane and reduce light passage.

The bottom of the growth chamber is also of major importance. The growth chamber would need to be supported by a separate inflatable structure between it and the Mars surface (Fig.4). Abrasion between rocks and dust would soon wear a hole in the membrane of the pressurized outer chamber. What could be possible is a separate attached inflatable support structure of a rigidizing membrane on the bottom of each growth chamber that, depending on the type of resin used, infra-red light, water, carbon dioxide, etc. would turn solid and the need for pressurization of the support structure would then be eliminated. This would keep the pressurized growth chamber above the surface and from coming in contact with the rocks and abrasive materials. Also, the rigidized membrane could conform to the surface better, accommodate rocks and make it possible to provide a more level area for the growth chamber to rest. The bottom of the growth chamber would not need to be made of the same transparent membrane of the top half. It could be made of a heavier material like the central spine and include insulation.

The differences between Mars day and night temperatures are significant and possibly by adding thermal mass to the outer carbon dioxide chamber, would help maintain elevated night time temperatures with less use of station power. Before the Mars Inflatable Greenhouse is deployed, crewmembers will need to remove some rocks that interfere with the structures support. These rocks could be piled at the two ends outside the perimeter of construction. Once the greenhouse is initially inflated, the ends of the outer chamber could be opened up and rock from the surrounding area piled in net baskets at the ends (Fig.4). Once the net baskets were full, a breathable cover could be applied to the rock, so that dust would not contaminate the inside of the outer chamber. Another strategy for maintaining nighttime temperature would be for supplemental lighting to be run during part of the night with the heat from the water jacketed lamps being spread amongst other chambers. By having some chambers receiving supplemental lighting in the morning before sunrise and some chambers receiving it after sunset, some lighting would be on for the whole period of darkness providing heat. Also, some crops are tolerant of loss of photoperiod and could be grown 25 hours a day.

The inner growth chamber's plant support system would consist of two wire frame rails, two sets of wire frames with rollers and mechanized positioning motor, four cables for connecting the two wire frame rails, as many as needed plant bag support wires with spring loaded tensioning lever devices (Fig.6). The first wire frame rail would be attached to the bulkhead of the central spine, extending around the whole perimeter in a circle. The other rail at the opposite end would attach to flexible membrane tabs that are anchored to the ends of the inflatable chamber. Four cables would connect the two wire frame rails and the interior air pressure of the chamber would produce enough force to keep all wires attached to it stretched tight. Attached by means of track rollers on these rails is the wire frames. The purpose of moveable wire support structures is to allow the plants to be rotated upwards along these rails and produce a walking space in between the wires holding plants growing in bags (Fig.5). Once the crewmember has exited the chamber, the wire frames return to their original position and the walkway disappears, maximizing growing area. Also, during periods of supplemental lighting use, the plants could be rotated upwards, to improve orientation of the plant and move it closer to the illumination source.

With wire or cable culture, the growing bags are suspended from a horizontal bottom and top wire or cable and the foliage portion of the plant is supported by upper wires which keep it growing vertically. Depending on the cultivar utilized the number of wires could be increased or decreased as the plant grows. In the case of grains, netting could be drawn across between two wires for better support of the smaller plants. Supply nutrient lines from the growing bag connect to jacks that penetrate the central spine bulkhead and connect to the nutrient reservoir on the other side. The nutrient drain line come off the growing bag and connect to jacks that again penetrates the central spine bulkhead and return to the nutrient reservoir.

Phobos

The possible Phobos growth chamber would be part of an evolution towards a manned space station on Mars's closest moon (Fig. 11). Originally, an unmanned lander would land on the surface, drive down anchoring spikes through the meter thick regolith and deploy an inflatable parabolic reflector which would track the sun and concentrate light on a central collector (Fig. 10). Depending on what concentrations of frozen water and carbon dioxide Phobos is found to consist of, and what the content and spacing of rock is beneath the surface, mining of the water and carbon dioxide could be achieved by various means. One possibility would be by utilizing a Rodriguez Well, similar to the one currently being used at the NSF's South Pole Station, Antarctica to collect potable water from the frozen ice beneath the station. A steady supply of hot water is circulated from the surface to the ice below the station, this forms a reservoir of liquid water that can then be pumped to the surface and stored for station use. If Phobos has a thick layer of ice and rock below the meter thick crust of regolith, initially a tube could be drilled through the regolith and water heated by the solar collector could be circulated through the tube and begin to melt a cavity below the surface. Once large enough, the regolith would be undermined and the lander would hydraulically mine an opening large enough for the lander to fit and deploy inflatable seals between it and the regolith. Upon sealing the cavity below the lander, a hybrid Rodriguez Well-hydraulic mining effort would produce a shaft below the lander that an inflatable structure could be deployed in. Extra depth in the shaft could be used for storage of rock encountered in this mining process. Water and carbon dioxide would be stored in inflatable bladders for offloading to the Mars mission return spacecraft and transport back to 155 and for later use in supporting cultivation.

The hole produced by the mining effort would become the space for deployment of an inflatable autonomous growth chamber. Suspended from the lander would be an insulated inflatable structure that would contain a similar wire or cable culture growing system that was described for the Mars surface effort, except the wire frames would not move and the wires would be arranged in a radial pattern (Fig.10). Light would be supplied to the plants via fiberoptic light guides and supplemental artificial lighting. Outside, the same collector that was used to support the mining efforts now is used to supply light to the fiberoptic lighting system and generate power for the supplemental lighting system during dark periods of the moons orbit and the other electrical requirements.

The best candidate crops for autonomous crop production on Phobos would probably be grains which utilize anemophilous pollination and their inflorescence are produced at relatively the same height. Harvesting might amount to having a robotic arm place a threshing device at the end of the wires and pull the crop along the wire into the device, separating the grain from the plant. The discarded plant would be incinerated and the carbon dioxide recycled back to the growth chamber. The grain would next be compressed, freeze dried, and packaged for the next Mars mission to pickup when they arrive to remove water from the Phobos.

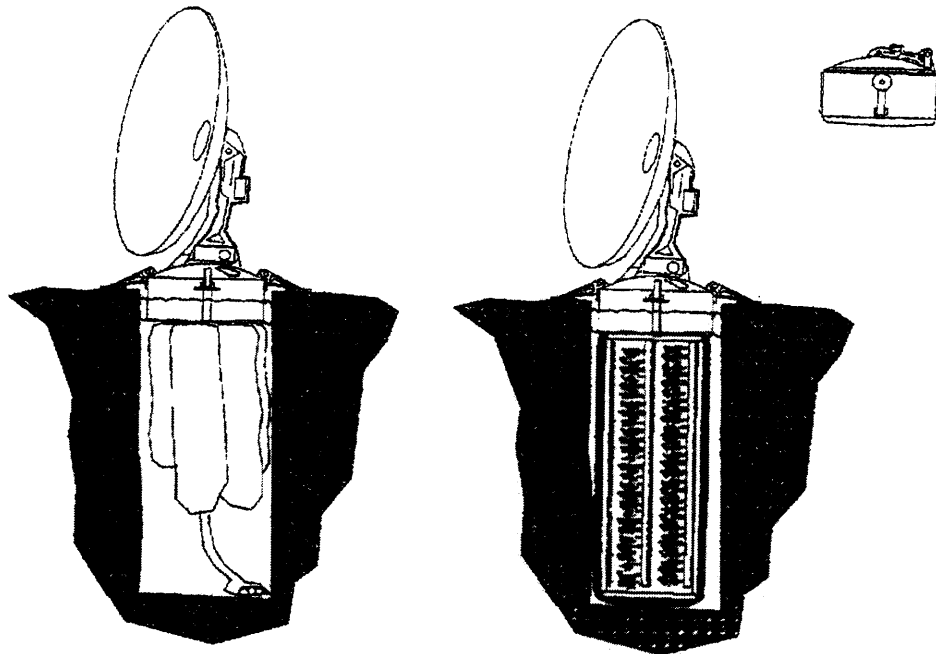

(Fig.10)

Phobos Lander In Water Mining and Crop Production Modes

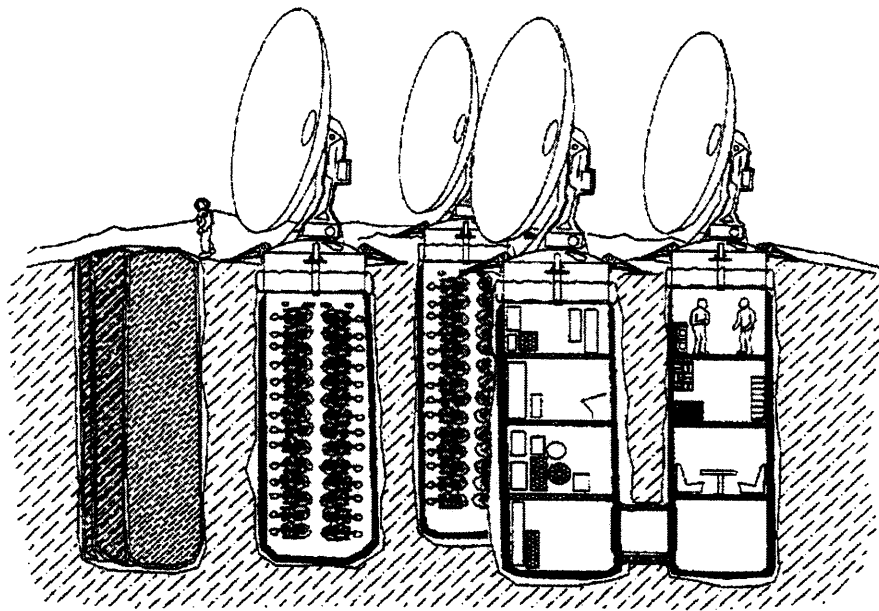

(Fig.11)

Phobos Manned Space Station With Water Mining and Crop Production

Copyright Sadler Machine Co. 9/10/99

ISS

The hazards presented to the space station's electrical hardware from the possible escape of plant growing system's liquid nutrient in micro-gravity may motivate the directors of ISS to support a separate inflatable module for an ISS growth chamber and/or space horticulture experiments. As illustrated, the ISS growth chamber would be of similar construction as the Transhab with light being supplied by an inflatable parabolic dish collector mounted somewhere close to the chamber (Fig.13). The concentrated PAR light would be delivered to the plants via fiberoptic light guides and the remainder of the spectrum would be used for power generation to support the conventional supplemental lighting of the plants during the dark portion of ISS's orbit.

Again, the inflatable structure would have two wire frames, one connected to the solid bulkhead structure which would have space for the hydroponic support hardware and would ultimately connect with an ISS node. The other wire frame would attach to the other end of the inflatable structure and the interior air pressure would keep the two wire frames apart, limited by the four cables running between both frames. Moveable smaller diameter plant support wires with spring loaded tensioners would run between the fixed wire frames and provide the support structure for the plant growing bags and upper plant support.

A most formidable challenge is in designing a growing bag that will keep the nutrient in the bag while in micro-gravity and not requiring a restrictive seal on the plant stem. Having a separate dedicated module for the growth chamber would allow Advance Life Support to use less stringent requirements for nutrient containment in the growing bags design. Free floating liquids in the shuttle cabin migrate towards the ventilation inlet. With a separate isolated growth chamber approach, an acceptable level of nutrient loss from the growing system could be established and secondary recovery could be achieved at the return air inlet for the ventilation system of the chamber. This module might also offer a safe environment to place other water intensive operations and hardware that would not pose a biological threat to crop production if a leak occurred, such as using a shower suit to take a shower, laundry, or dishwasher.

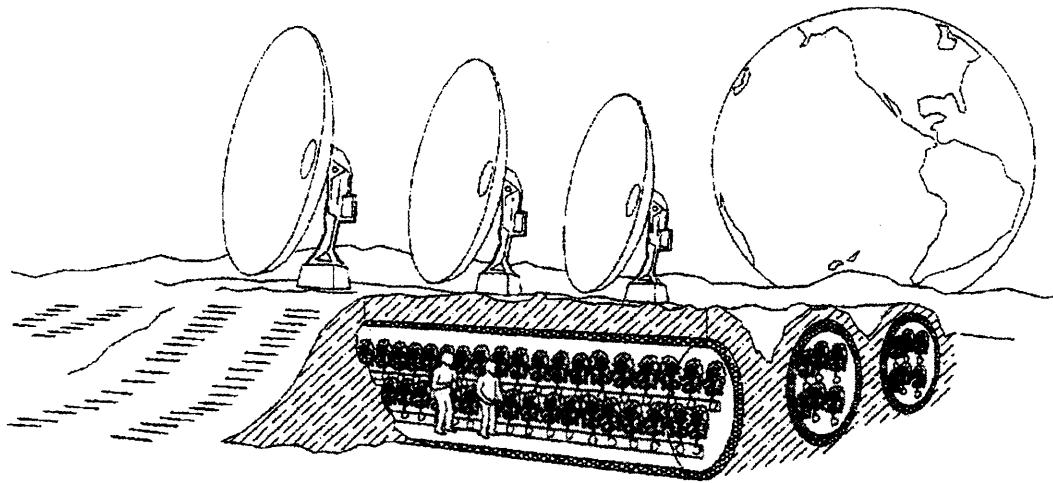

(Fig.12)

Lunar Research Station With Crop Production

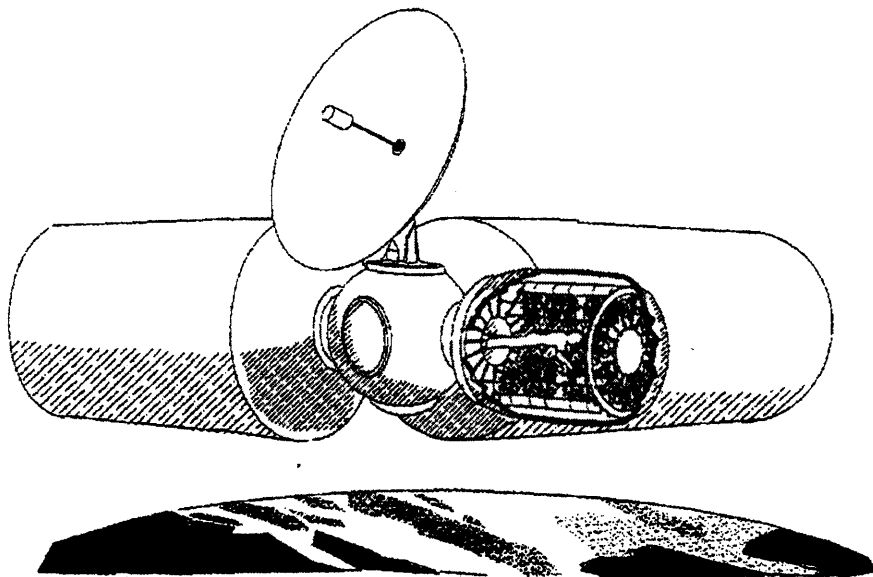

(Fig.13)

ISS Growth Chamber Module With Light Concentrator

Copyright Sadler Machine Co. 9/10/99

Lunar Base

If a Lunar base ever becomes a reality and growth chambers are included in the effort, an inflatable structure could provide a suitable module for crop production. The lunar regolith that would be required to cover the lunar base would weigh one sixth of what it would weigh on Earth and may have similar properties to snow on Earth. The inflation pressure of the module may support the weight of the lunar regolith, and possibly the use of rigidizing membrane material could allow the station to be depressurized while unoccupied without the weight of the regolith crushing the module.

Wire culture use for a lunar growth chamber would combine the moveable wire frames and central spine of the Mars growth chamber and the transhab type membrane and lighting system of the ISS and Phobos growth chambers. A lunar research base may not be continually occupied and the autonomous mode of operation might be initiated so that there is a crop waiting for the next arriving crew. For extended periods of the lunar base being uninhabited and depressurized, and autonomous operation being required prior to the next lunar mission, frozen organic material left in a composter or frozen blocks of dry ice could supply the carbon dioxide necessary to support the plants until the next crewmembers arrive.

Summary

There are many different types of hydroponic crop production cultures to choose from for possibly space horticulture utilization. The system with the lowest total systems mass and the highest production potential in both manual and autonomous operational modes will be the system of choice. Utilizing an inflatable structure for growth chamber applications on future missions, and developing a growing system that works in concert with the inflatable structures, can possibly provide a considerable advantage to mission planners. As with any growth chamber application, providing light of sufficient quality and quantity to the plants will present a challenge, whether it involves transmission through a plastic membrane, fiberoptic light guide, and/or conventional artificial lighting. Extreme cold presents another sizeable challenge to growth chamber development and suitable testing facilities and analogs will need to be identified. Hopefully, an inflatable growth chamber structure along with wire culture may provide Advanced Life Support with a successful growing system for the manned Mars missions and beyond.

References

1. D.W. Ming, D.L. Henninger. 1989. Lunar Base Agriculture: Soils for Plant Growth. Amer. Soc.of Agronomy, Crop Sci. Soc. Of America, Soil Sci.Soc.of America, Madison, Wisconsin, USA
2. H. Resh. 1978. Hydroponic Food Production. Woodbridge Press Pub. Co. Santa Barbara, Ca. 93102, USA