

510-44  
358987

## **Development of Ultra Low Temperature, Impact Resistant Lithium Battery for the Mars Microprobe**

*H. Frank, F. Deligiannis, E. Davies, B. V. Ratnakumar and S. Surampudi*

*Electrochemical Technologies Group, Jet Propulsion Laboratory*

*4800 Oak Grove Dr., Pasadena, California*

and

*P. G. Russel and T. B. Reddy*

*Yardney Technical Products, Inc.,*

*82, Mechanic St., Pawcatuck, CT*

### **ABSTRACT**

The requirements of the power source for the Mars Microprobe, to be backpacked on the Mars 98 Spacecraft, are fairly demanding, with survivability to a shock of the order of 80,000 g combined with an operational requirement at  $-80^{\circ}\text{C}$ . Development of a suitable power system, based on primary lithium-thionyl chloride is underway for the last eighteen months, together with Yardney Technical Products Inc., Pawcatuck, CT. The battery consists of 4 cells of 2 Ah capacity at  $25^{\circ}\text{C}$ , of which at least 25 % would be available at  $-80^{\circ}\text{C}$ , at a moderate rate of C/20. Each probe contains two batteries and two such probes will be deployed. The selected cell is designed around an approximate 1/2 "D" cells, with flat plate electrodes. Significant improvements to the conventional Li-SOCl<sub>2</sub> cell include : a) use of tetrachlorogallate salt instead of aluminate for improved low temperature performance and reduced voltage delay, b) optimization of the salt concentration, and c) modification of the cell design to develop shock resistance to 80,000 g. We report here results from our several electrical performance tests, mission simulation tests, microcalorimetry and AC impedance studies and Air gun tests. The cells have successfully gone through mission-enabling survivability and performance tests for the Mars Microprobe penetrator.



# **Development of a Ultra- Low Temperature, Impact-Resistant Li primary Battery for Mars Microprobe**

**Harvey Frank, Frank Deligiannis, Evan Davies,  
Kumar Bugga and Rao Surampudi**

**and**

**Phil Russel and T. B. Reddy  
Yardney Technical Products**

**Nov. 18, 1997**

**NASA Aerospace Battery Workshop  
November 18-20, 1997, Huntsville, AL**



# JPL Mars Microprobe - Mission Description 1

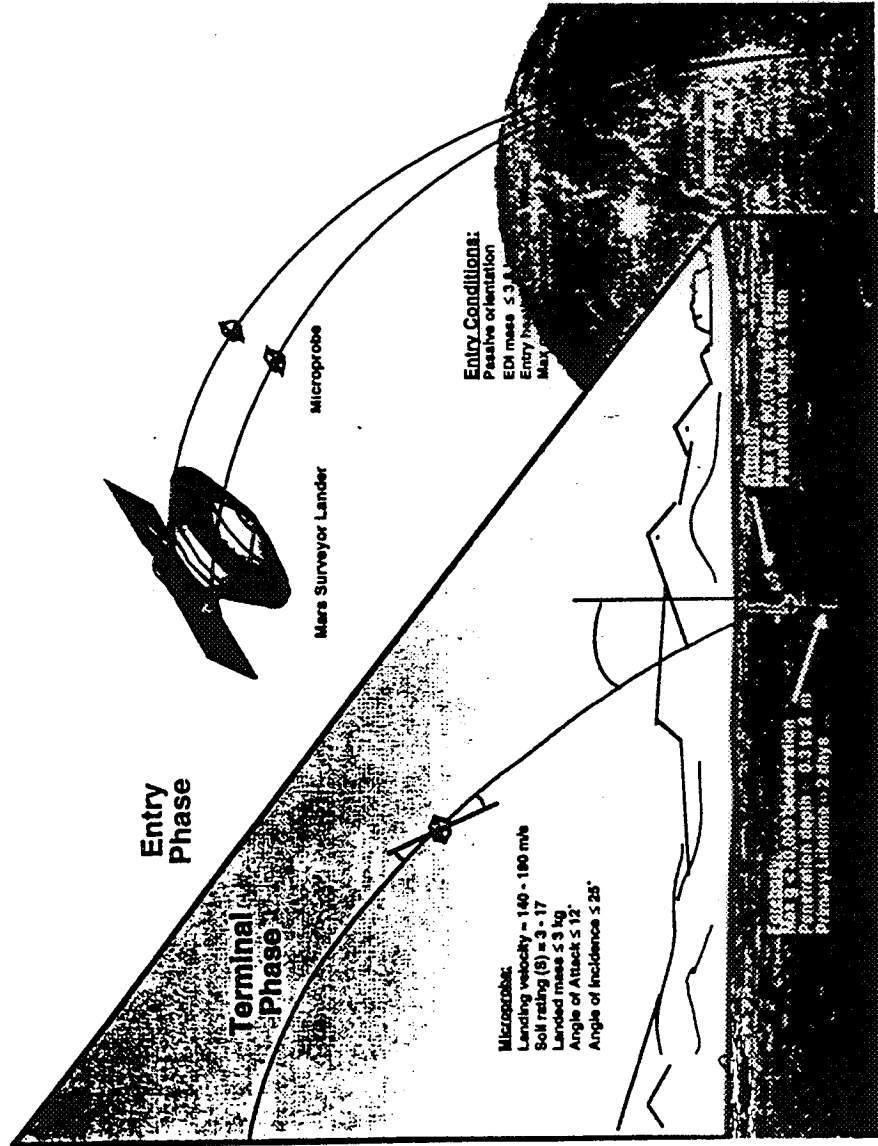



## SCIENCE OBJECTIVES



- **Acceleration data during entry and descent**
- **Atmospheric pressure data**
- **Soil temperature data**
- **Soil water content - spectrometer and electromechanical drill incorporated in the forebody.**



# Mars Microprobe - Mission Description 2

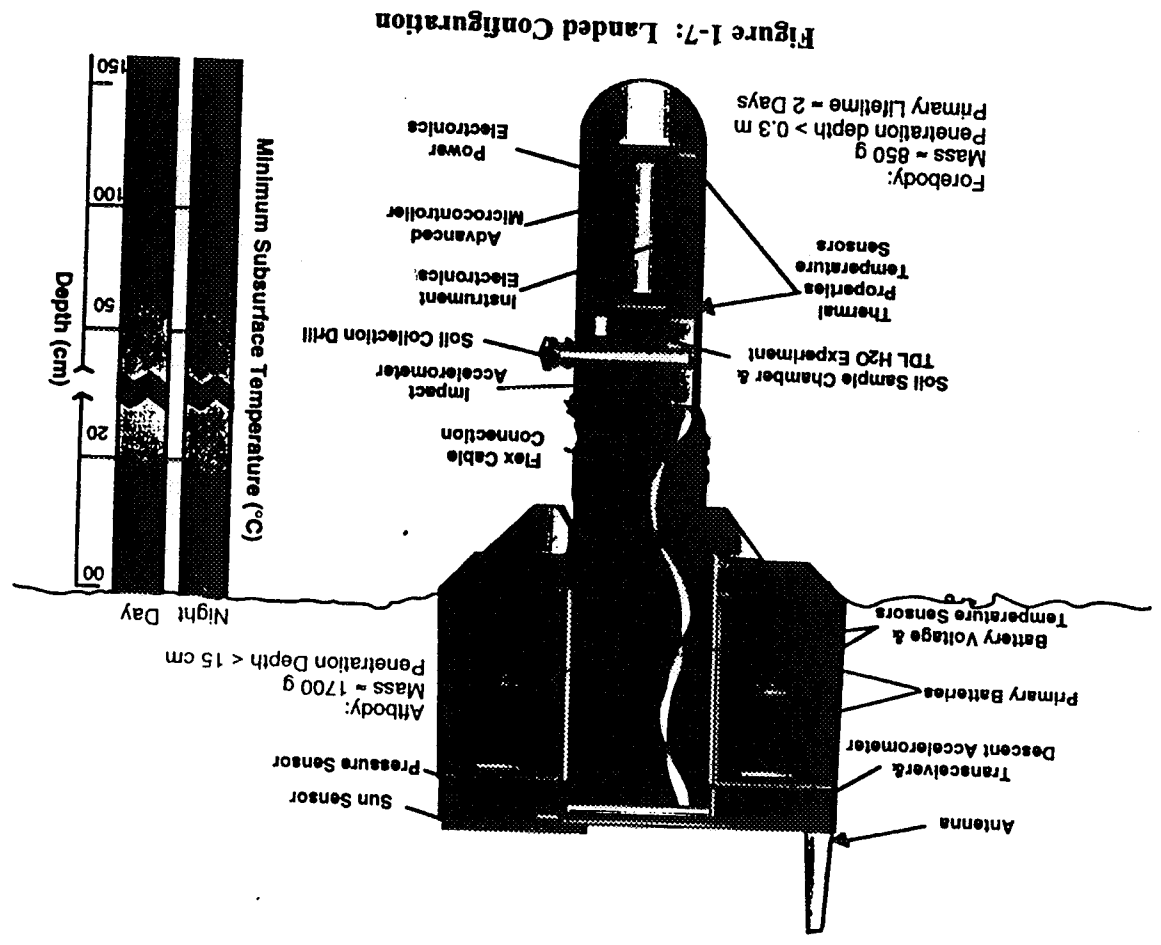

## Mars Microprobe Battery Objective

- Demonstrate flight like hardware that meets performance requirements after representative impact test in representative thermal environment
  - 6 - 12 volts
  - 2 year life
  - 2 A-hr capacity RT
  - 0.5 A-hr capacity at -80°C
  - Survive impact 200 m/sec
  - Load profile attached



## BACKGROUND

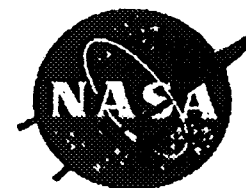

- **Li-SOCl<sub>2</sub> is the most suitable system from the polarization curves and discharge tests at -80°C.**
- **Lithium tetrachlorogallate gave improved discharge and voltage delay characteristics compared to tetrachloroaluminate.**
- **Lower salt concentrations (0.5 M vs. 1.0 M) improve electrolyte conductivity.**
- **Pancake (flat-plate) design in sliced “D” cell.**



# MARS MICROPROBE CELL



VERTICAL CROSS-SECTION OF THE FINAL  
2 AH CELL DESIGN

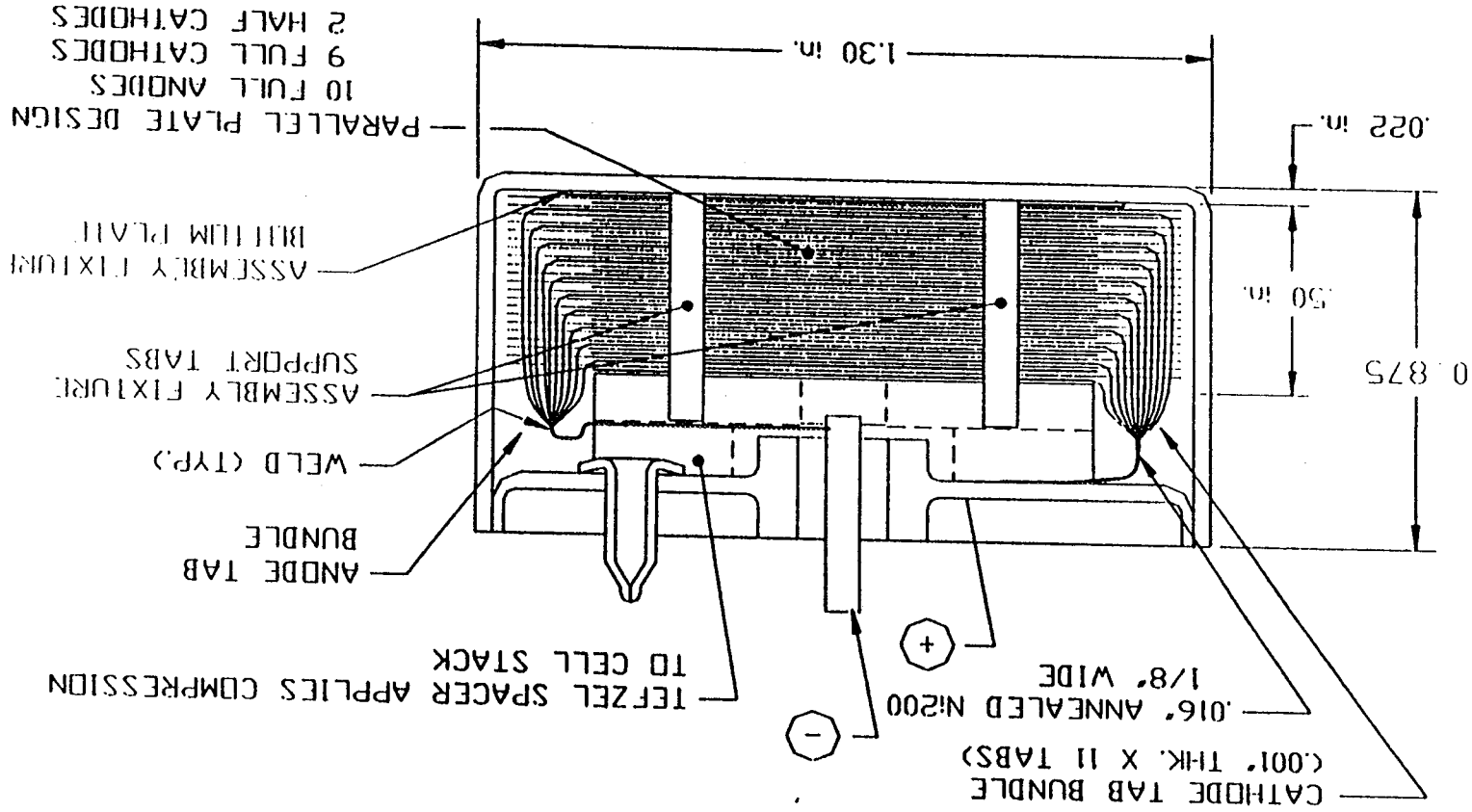



# TOPICS

- Microcalorimetry and AC Impedance
- Battery Motor Tests
- Voltage Delay
- Impact Testing
- Accelerated Storage
- Special Topics
  - Inspections
  - Installation and Wiring
  - Safety
  - Prior Issues
- Schedule
- Assessments

# LOAD PROFILES

## REQUIRED LOADS (ORIGINALLY)

- Descent: first 10 min @ -40 °C
  - 8 mA -4 min, 13 mA -4 min, 30 mA -2 min
- Surface Operations for next 6 hrs
  - Sleep mode: 1 mA, -60 to 80 °C
  - Science pulses: 33 mA, -60 to -80°C, each 1/2 hr
  - Drill: 88 mA, 10 min, -40 °C, TBD time
  - H<sub>2</sub>O Heater: 605 mA, 20 min, -60 °C, TBD time
  - Transmit: 176 mA, 15 min, -80 °C, TBD time

## NEW REQUIREMENTS FOR SURFACE OPS

- H<sub>2</sub>O Calib, 605 mA, 2 min, -60°C, TBD time
- Transmit: Highest Power, 15+min, -60 to -80 °C

---

# MICROCALORIMETRY

## OBJECTIVE

- Predict capacity loss of cells for 2 year stand @ RT.
- Determine effect of temperature on capacity losses.
- Obtain 'acceleration factor' for elevated temperature storage tests.

## APPROACH

- Measure heat from cell from cells using microcalorimeter, periodically during storage.
- Measure heat from cells over a range of temperatures.
- Analyze data to make predictions.



## Observed Cell Heat Output During Storage

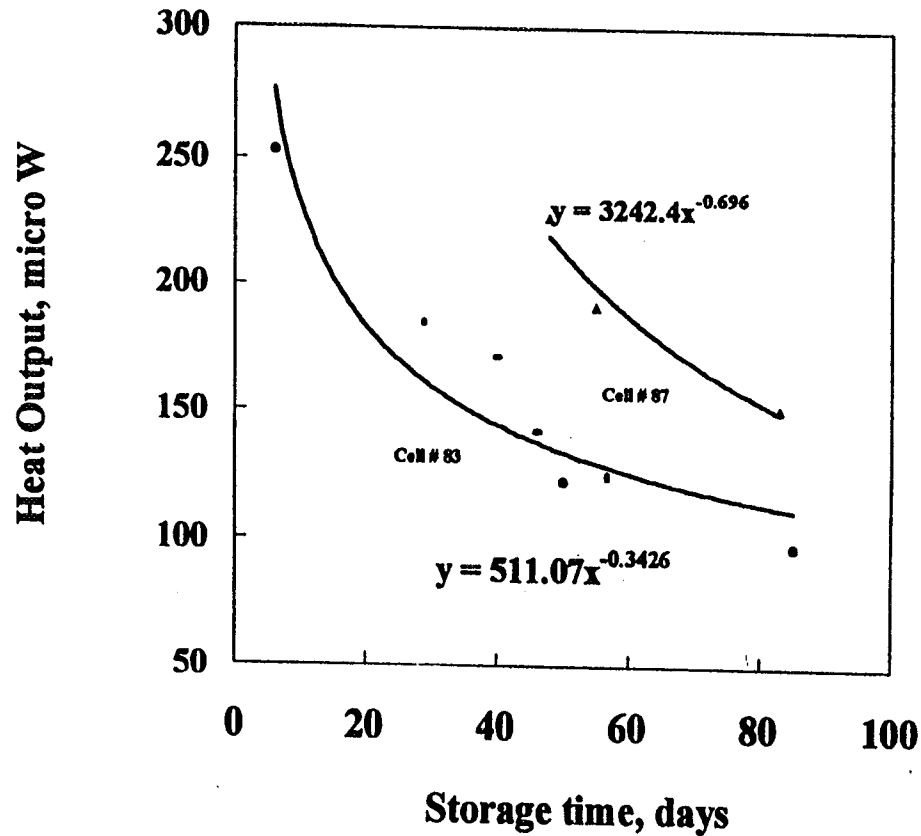

- Exponential decay in corrosion rate during storage

## Predicted Cumulative Heat Output Over 2 Years

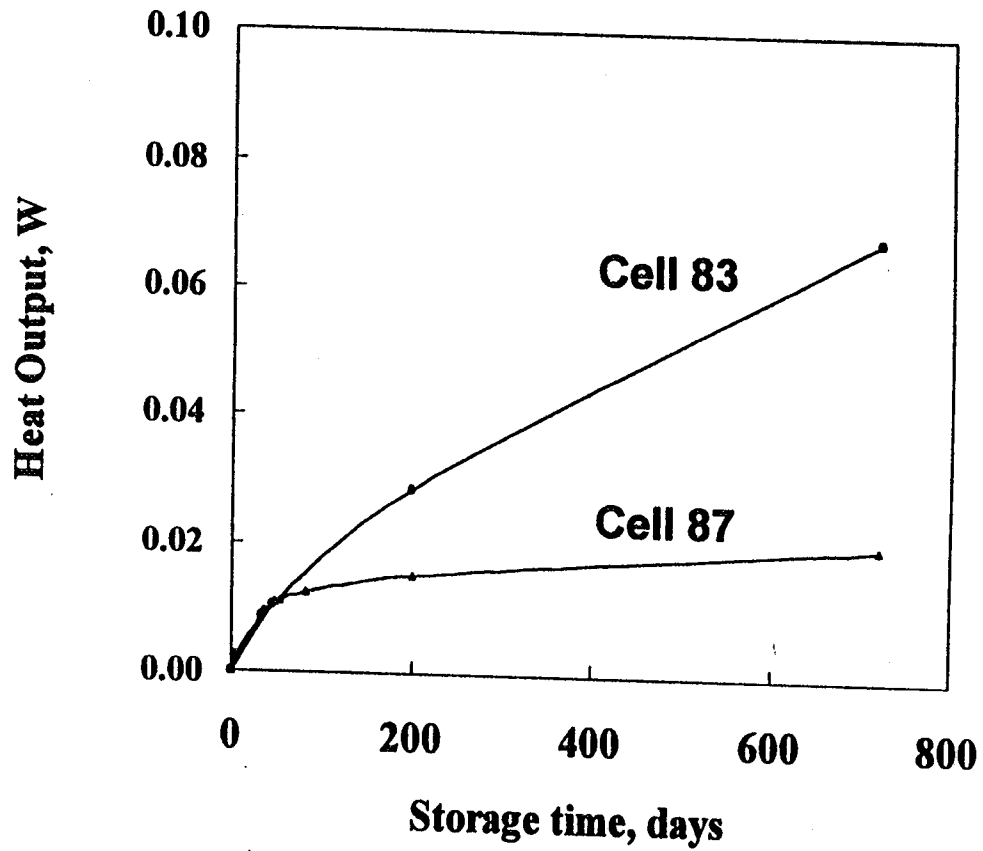

- Predicted based on extrapolation of experimental data

- Calculated based on a thermoneutral voltage of 3.72 V

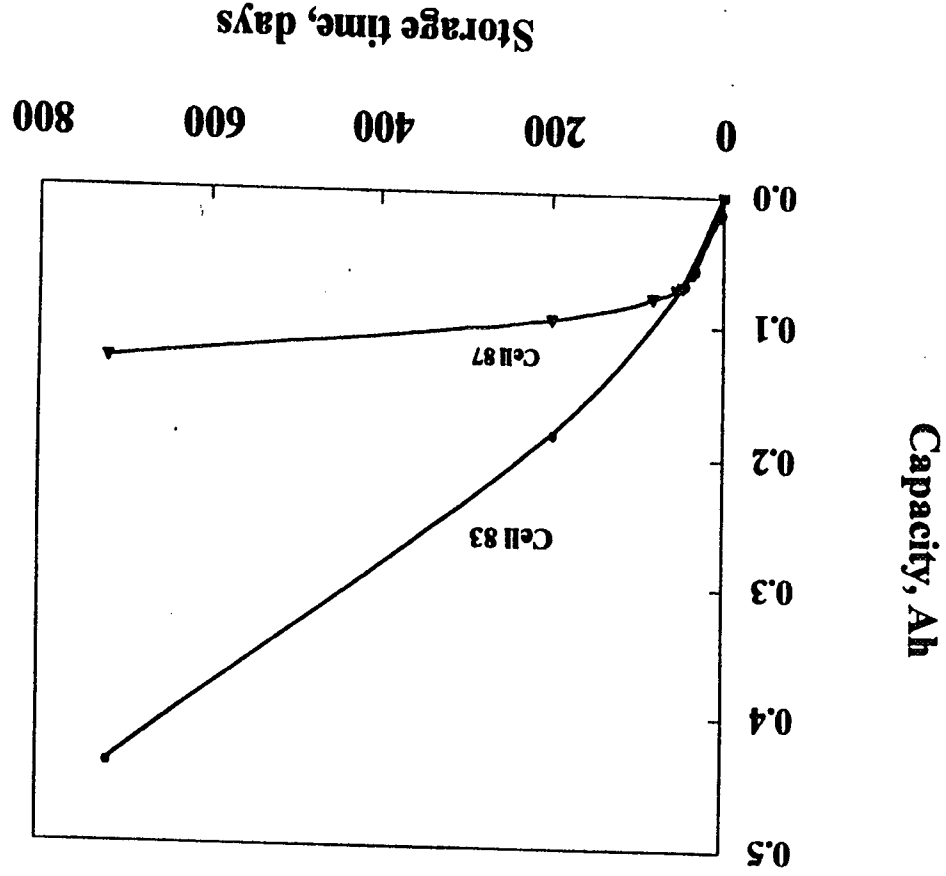

Predicted Capacity Loss During Storage at RT

## Arrhenius Plot of Li Corrosion (Self Discharge)

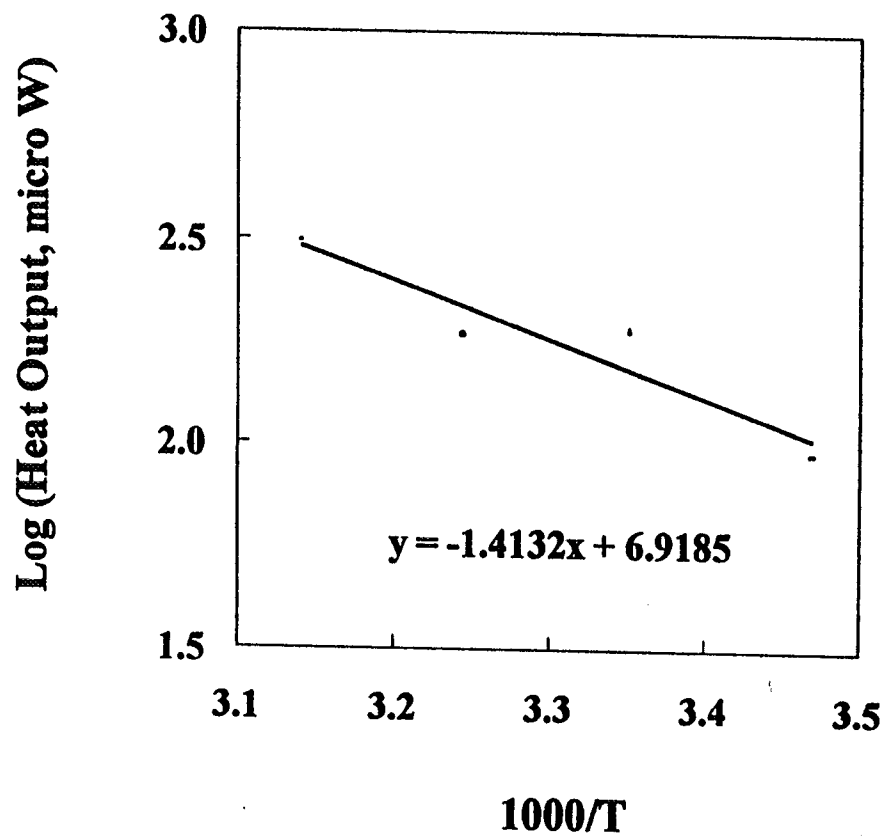

- Activation Energy : 1.64 kcal/mole

## Predicted Capacity Loss vs. Storage Temperature

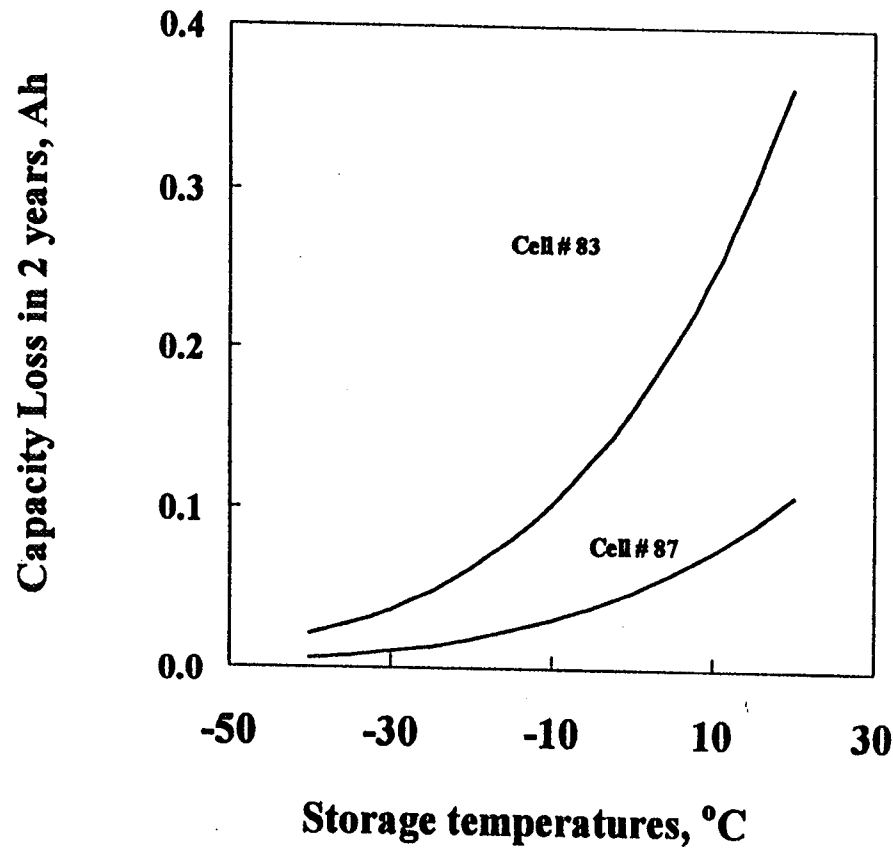

- Lower storage temperature desired.



---

## **ELECTROCHEMICAL IMPEDANCE SPECTROSCOPY**

### **OBJECTIVE**

- **Examine variations in the cell construction and or workmanship non-destructively.**
- **Examine the (lithium) interfacial conditions that would impact stability (life) and voltage delay.**
- **Detect signs of cell degradation during stand.**

### **APPROACH**

- **Establish baseline impedance spectra of the cells.**
- **Establish correlations, if any, with the life and voltage delay characteristics.**

## Impedance Spectra of Fresh Cells

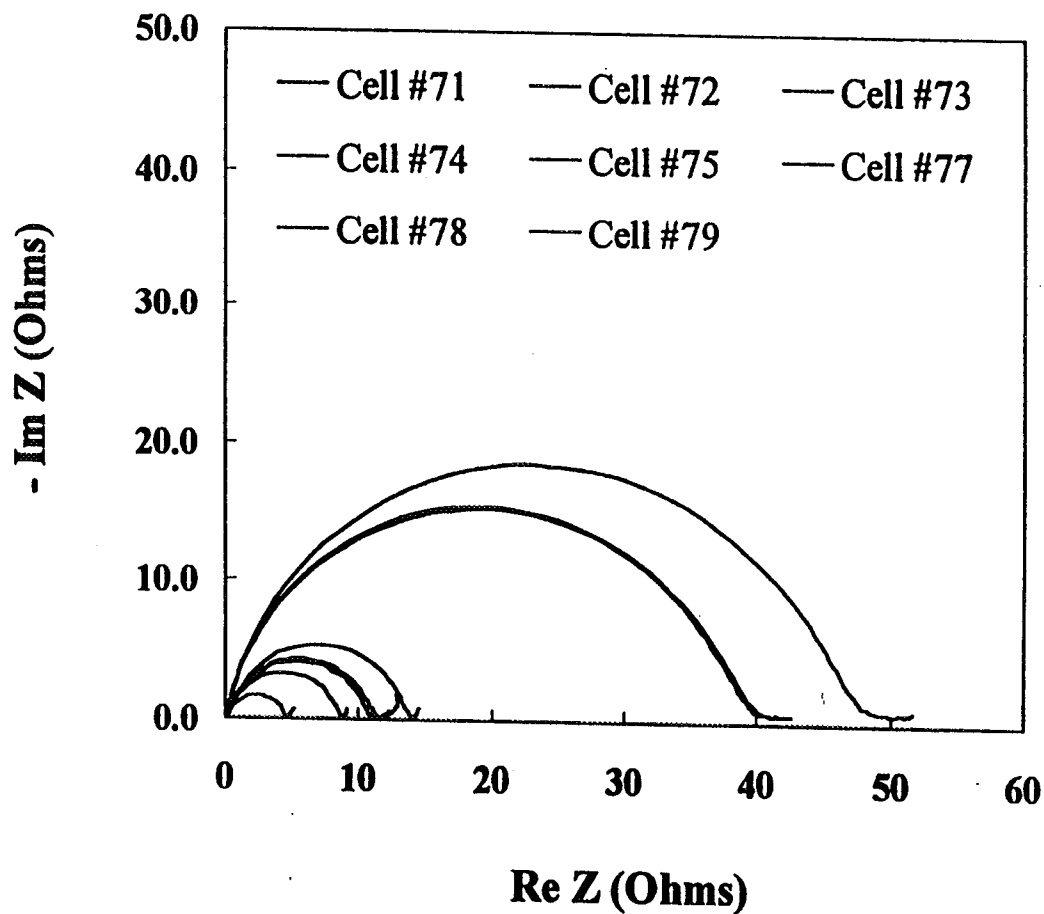

- **Film Resistance varies from cell to cell.**

- Cell Resistance 150-210 m $\Omega$ ; consistent with the m $\Omega$ m measurement after film voltage delay.

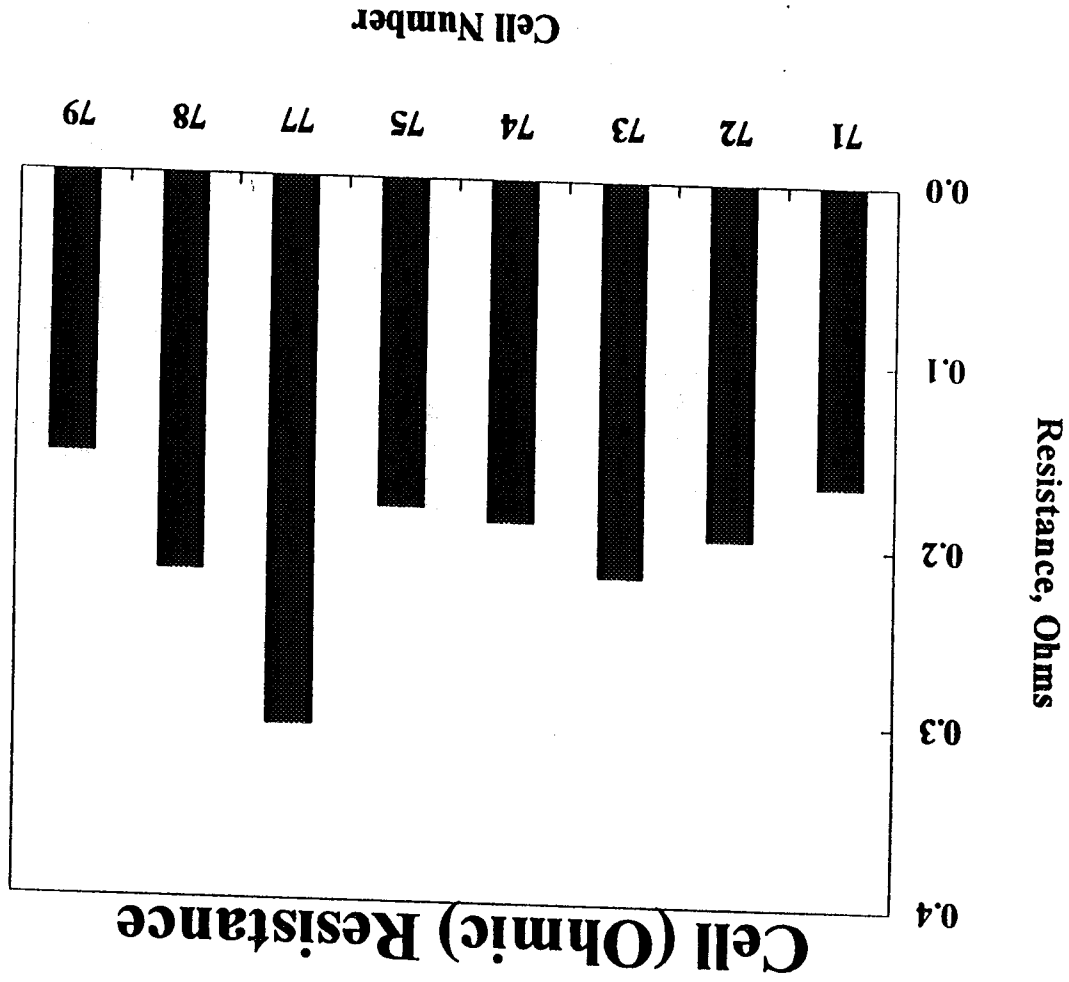

## Film Resistance

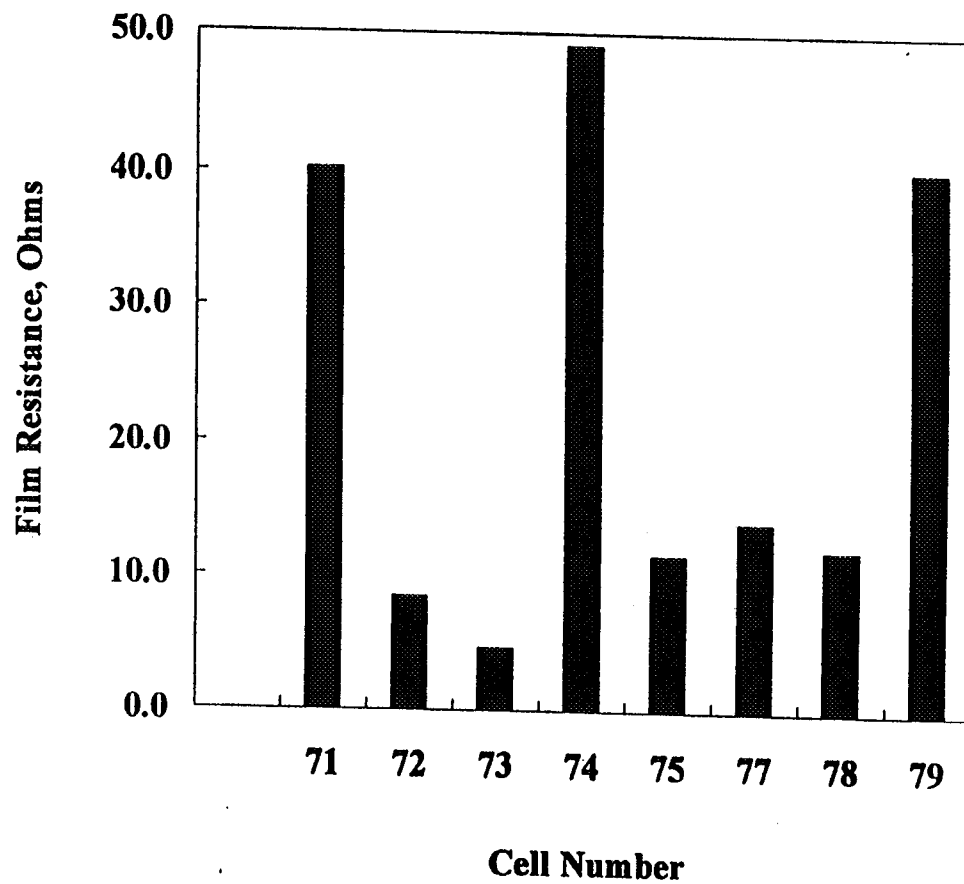

- Film resistance varies from 5-40  $\Omega$ .

# VOLTAGE DELAY

(EXPLORATORY DATA ON YTP 2 AH CELLS)

Delay at 100 mA at -40 C

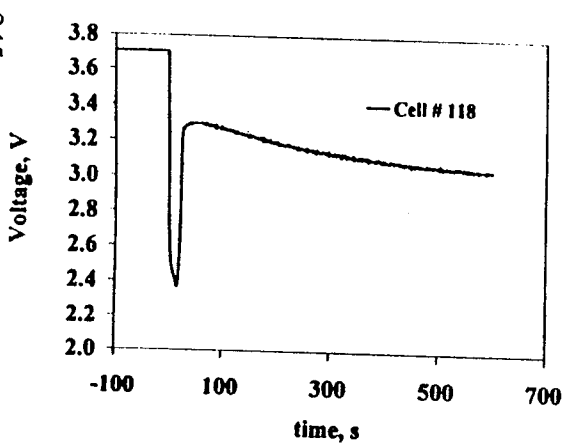

Delay at 100 mA at -40 C

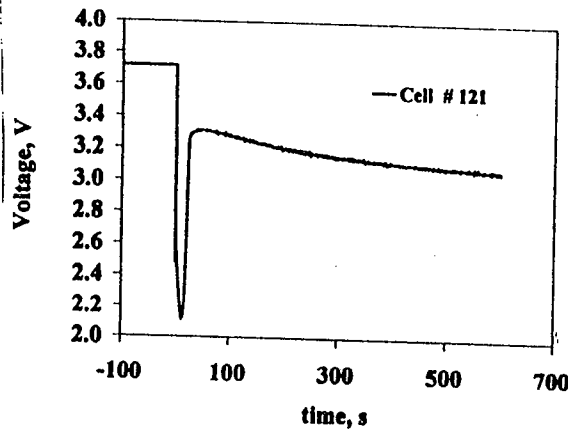

Delay at -80 C

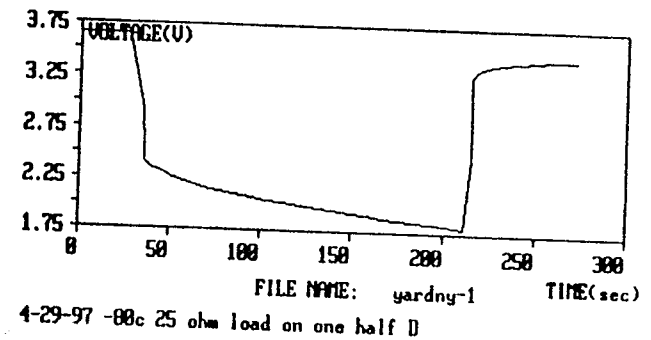

- Delay appears significant but not excessive @ moderate currents @ -40 to -60 degrees C
- Delay could pose problems at moderate currents @ -80 degrees C

# VOLTAGE DELAY

## CONCLUSIONS

- Voltage depression from delay is significant but not excessive at moderate loads @ -40 to -60 degrees C
  - Can meet early descent loads with adequate voltage @ temps to -60 degrees C
- Voltage depression from delay is appreciable at moderate loads @ -80 degrees C
  - Can meet Initial transmit load but with little margin
  - May incorporate short conditioning discharge prior to transmit @ -80 degrees C
- No voltage depression from delay later in profile @ -60 degrees C for H2o Expt @ 605 mA, and even high new transmit to 1A.

# BATTERY - MOTOR TESTS

## OBJECTIVES

- DETERMINE CAPABILITY OF BATTERY @ -30 TO -80 degrees C TO RUN DRILL MOTOR @ -120 degrees C
- DETERMINE TRANSIENT MOTOR START AND OPERATIONAL MOTOR CURRENTS AND VOLTAGES
- DETERMINE TRANSIENT MOTOR STALL AND STEADY MOTOR STALL CURRENTS AND VOLTAGES.

# DS2 BATTERY/MOTOR TEMP TEST

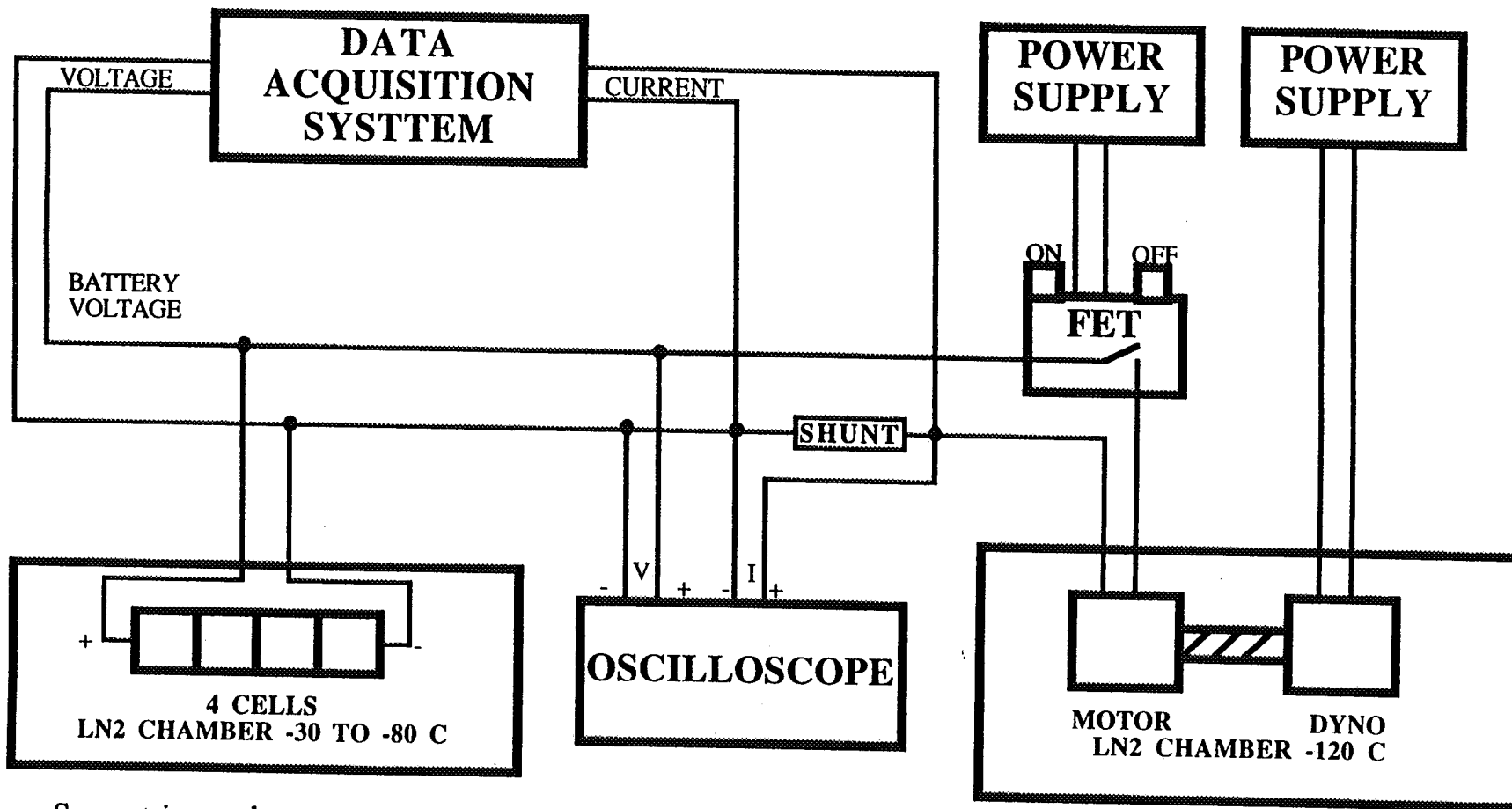

- Scope triggers by motor start and records transient voltage and current
- Dyno set for 1 inch-lb to simulate drill
- Motor shaft frozen for stall
- DAS records steady state voltage and current



# BATTERY MOTOR TESTS

(Sample - Transient Start @ -60 degrees C)

- Scope trace @ -60 degrees C
- Peak current near 1A and Min V near 10.0 V
- Lasts only 25 ms
- Current quickly tapers to near 70 mA
- Similar results from -30 to -70 degrees C

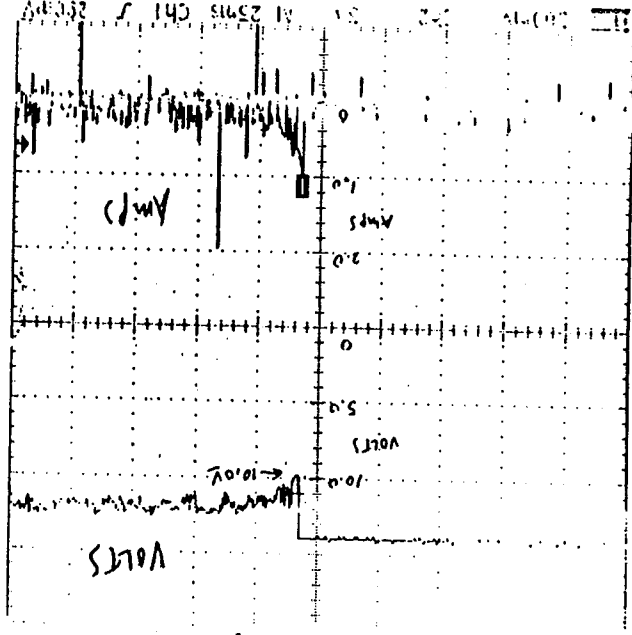

# BATTERY MOTOR TESTS

Sample - Stall Run @ -60 degrees C

- DAQ trace @ -60 degrees C for 4 min.
- Start spike noted
- Voltage near 7.7 V @ 390 mA
- Similar results from -30 to -70 degrees C

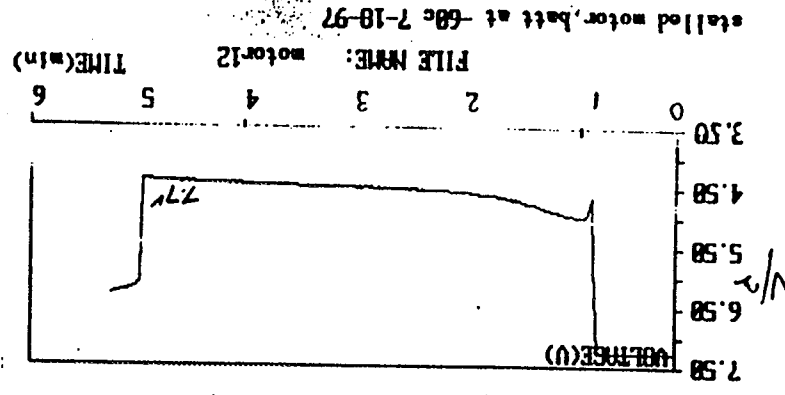

**BATTERY VOLTAGE AFTER 4 min  
STALL OF MOTOR @ -120 °C**

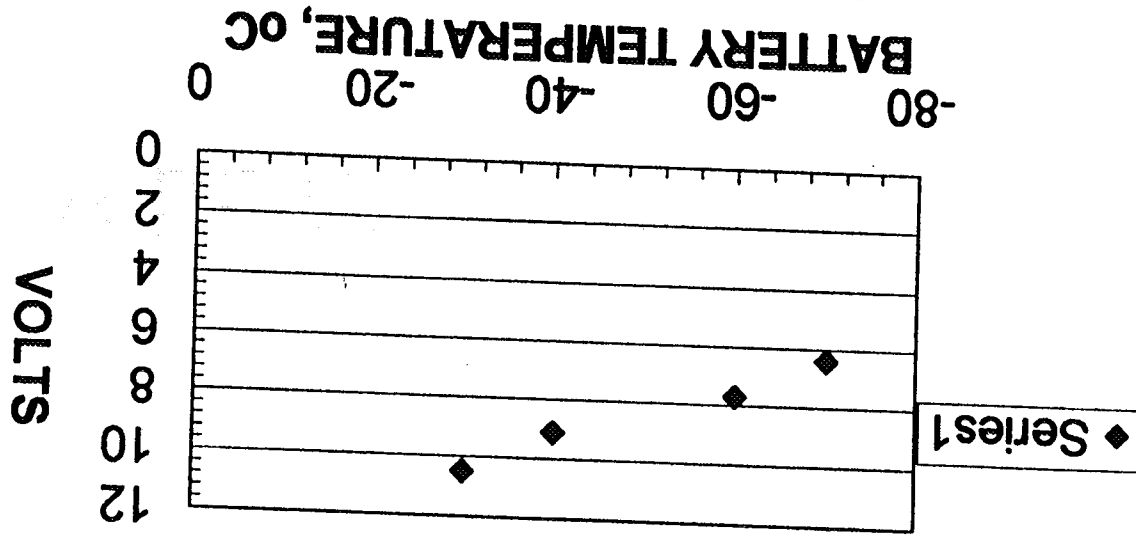

# BATTERY MOTOR TESTS

## Summary/Conclusion

### •STARTING CHARACTERISTICS

- Current near 1 A for 25 ms
- Minimum voltage decreases with temp (8V @ -70 degrees C, 4V @ -80 degrees C)

### •RUN CHARACTERISTICS

- Currents near 70mA
- Voltages relatively stable for at least 10 min
- Voltage level declines with temp (10V @ -70 degrees C, 4V @ -80 degrees C)

### •STALL CHARACTERISTICS

- Currents near 400 mA
- Voltages relatively stable for 4 min
- Voltage level declines with temp (7.7 V @ -60 degrees C)

### •BATTERY CAN OPERATE DRILL AND STALL @ -60 Degrees with margin

# IMPACT TESTING

## OBJECTIVE

- Demonstrate capability of battery:
  - Withstand 200 m/sec impact shock
  - Deliver required electrical loads at minimum temperatures

## APPROACH

- Install cells in probe assemblies
- Fire assembly into target with airgun
- Retrieve assembly and conduct discharge tests in accord with mission profile and temp.

# IMPACT TESTING

## TEST ITEMS

- Two cell types
  - Old: GTM + Cover with fill port in center as terminal
  - New: New GTM + Thicker cover with pin in center & fill tube on side
  - Electrode stacks + electrolyte same for old and new types

- Two cell configurations in probe

OLD

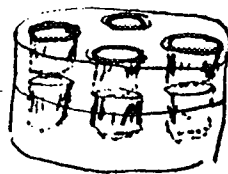

2 LAYERS OF  
FOUR CELLS

NEW

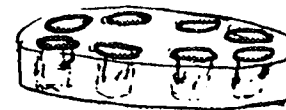

1 LAYER OF  
EIGHT CELLS

# IMPACT TESTING

## OVERVIEW

TEST NO.	DATE	CELL TYPE	NO CELLS	PROBE TYPE	AOA	HIGHLIGHT
36	3/13/97	OLD	4	2I	10 degrees	All got GTM cracks and leaks, 3 functioned
38	4/4/97	OLD	2	1I	NA	Both got GTM cracks and leaks, both functioned
42	5/29/97	OLD	8	1I	+2	All got GTM cracks and leaks, 1 opened, 7 functioned
50	8/28/97	NEW	8	1I	-15	No cracks, no leaks, 1 rented, 1 bulged, 7 functioned
53	10/29/97	NEW	7	1I	+2	No cracks, no leaks, 7 functioned

# AIRGUN TEST # 42

## OVERVIEW

- 8 cells, old design, 1 layer config
- No venting
- But all cells had small cracks & slow leaks in GTM
- 1 cell developed "open" condition
- Remaining 7 cells delivered good output @ -80 °C

## Significance

- \* One layer configuration appears best
- \* Old GTM-Seal assembly inadequate
- \* Cells survived and functioned (with leaks)
- \* "Open" due to faulty pin weld



# AIRGUN TEST #42

## DISCHARGE TEST RESULTS

### •Descent Load Tests @ - 40 degrees C

Had computer problems

Best estimates below

611 ohm.....	3.3 - 3.5 V
61 ohm.....	3.2 - 3.4 V
10 ohm.....	3.2 - 3.3 V

### •Discharge Load Tests @ - 80 degrees C

<u>Cell #</u>	<u>Ah</u>
71.....	0.75
72.....	0.36
73.....	0.64
74.....	0.87
75.....	0.80
77.....	0.85
78.....	0.82
79.....	0.01 (Opened)

# AIRGUN TEST # 53

## OVERVIEW

- 7 cells as 4 and 3 cell batts, new seal design, 1 layer config
- Improved external wiring
- No leaks and no venting
- 4 cell batt delivered good output on profile, also delivered high power transmit of 10 W @ -60 °C
- 1 bad cell in 3 cell batt limited output but this batt operated on constant load @ -80 °C

## SIGNIFICANCE

- New seal design again withstood shock
- External wiring mods appear to have eliminated shorts
- Must investigate cause for bad cell in 3 cell batt

# AIRGUN TEST # 53

## MISSION PROFILE TEST

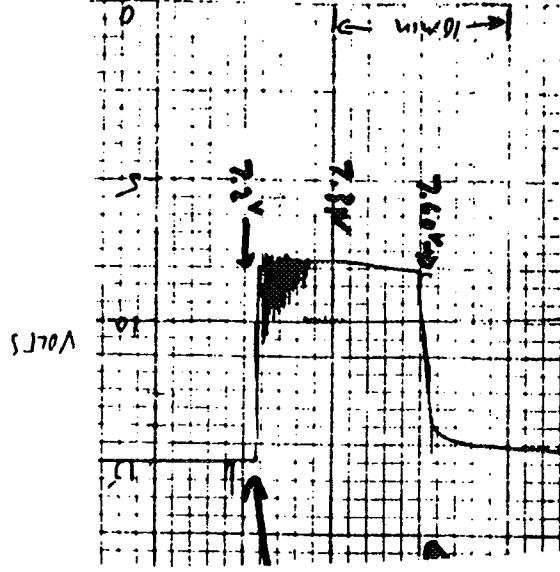

$T = -80^{\circ}\text{C}$

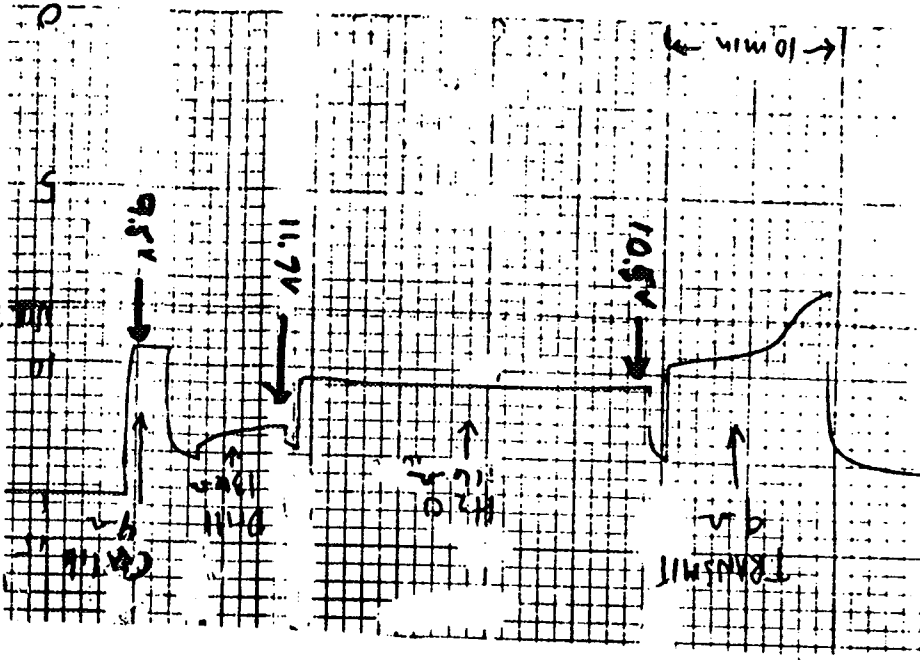

$T = -60^{\circ}\text{C}$

9280-0764

GRAPHIC CONTROLS CORPORATION BUFFALO, NEW YORK

# ACCELERATED STORAGE

## OBJECTIVE

- Project performance after 2 years storage.
- Support microcalorimetric projections.

## APPROACH

- Store some cells at ambient temperature.
- Store additional cells at elevated temperature.
- Periodically remove and test cells.
- Compare actual with projected capacities
- Also examine trends in voltage delay.

# ACCELERATED STORAGE

## CAPACITY TESTS @ RT

1 month @ RT

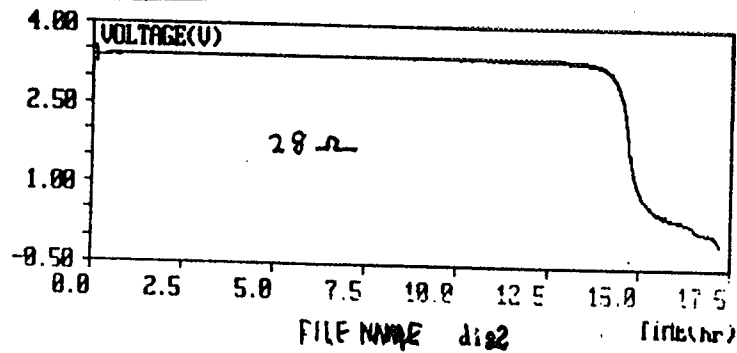

1 month @ 50 degrees C

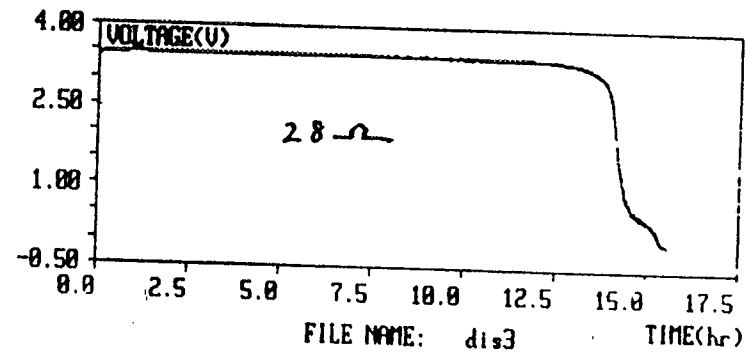

No measurable loss in capacity at 50 degrees C

# ASSESSMENT 1

- Favorable Project for meeting 2 year shelf life
  - 78-93% capacity retention after 2 yrs @ RT
  - Improved retention at lower temps
  - Accelerated tests consistent with projections.
- Battery can successfully operate drill motor
  - Sustain 1 A surge starting current
  - Run motor > 10 min @ temp < -60 degrees C
  - Sustain 1 A surge stall current
  - Run motor > 4 min @ temp < -60 degrees C

# ASSESSMENT 2

## •VOLTAGE DELAY

- Effects present but not excessive for planned moderate initial loads @ -40 to -60 degrees C
- Limits maximum initial load especially at very low temperatures, - 80 degrees C

## •IMPACT SURVIVABILITY

- New GTM-cover design eliminated cracking and leaks and external wiring mods eliminated external shorting
- Several cells delivered good post impact perf and a battery met profile and 10 W
- Must determine cause for one "low" cell in Airgun #53
- Successful repeat run would help ensure meeting qual

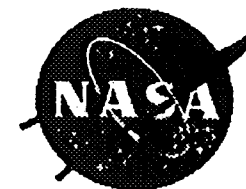

## Acknowledgement

**This work was carried out at the Jet Propulsion Laboratory, California Institute of Technology under contract with National Aeronautics and Space Administration and in collaboration with Yardney Technical Products, Inc.,**