

The Gamma-Ray Observatory

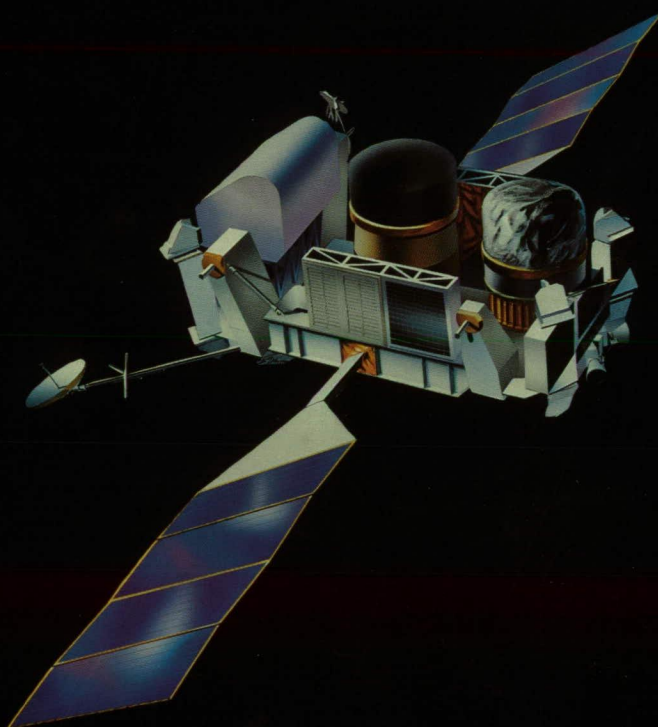

NASA

National
Aeronautics and
Space
Administration

(NASA-NP-124) THE GAMMA-RAY OBSERVATORY
(NASA) 39 P CSCL 22B

N91-17115

Unclas
G3/18 0325894

The Gamma-Ray Observatory

C O N T E N T S

INTRODUCTION	3
THE GAMMA-RAY OBSERVATORY	4
Detecting Gamma Rays	6
Locating Gamma-Ray Sources	10
Observatory Operations	11
THE GAMMA-RAY UNIVERSE	14
How Gamma Rays Are Produced	14
Nucleosynthesis	16
Particle Acceleration	16
Matter/Antimatter Annihilation	16
Sources Of Gamma Rays	17
Supernovae	17
Neutron Stars and Pulsars	17
Quasars	18
Active Galaxies	20
Bursters and Transient Sources	20
Black Holes	21
Milky Way Galaxy	22
Extended Sources	22
Extragalactic Diffuse Radiation.....	22
Unidentified Sources	22
INSTRUMENTS IN THE GAMMA-RAY OBSERVATORY	24
Burst And Transient Source Experiment (BATSE)	24
Oriented Scintillation Spectrometer Experiment (OSSE)	28
Imaging Compton Telescope (COMPTEL)	31
Energetic Gamma Ray Experiment Telescope (EGRET)	34
Arthur Holly Compton.....	36
GRO Mission Team.....	38

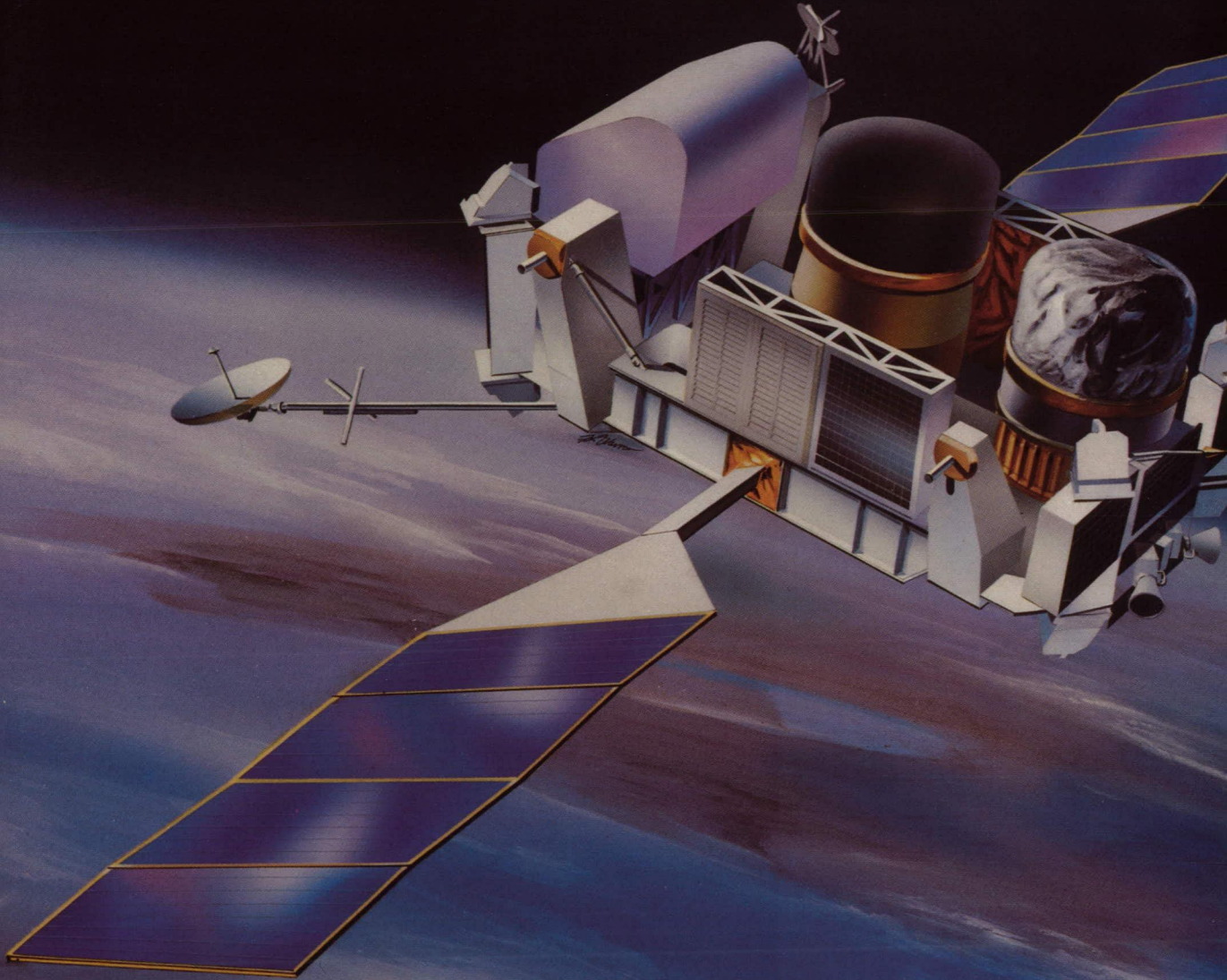

Gamma-Ray Observatory

- *Probe of exotic and explosive celestial objects*
- *View of universe at shortest wavelengths (highest energy radiation)*
- *Largest gamma-ray instruments ever flown*
- *Heaviest unmanned spacecraft (about 35,000 pounds)*
- *First science payload with refuelable onboard propulsion system*

Introduction

ORIGINAL CONTENTS
COLOR ILLUSTRATIONS



Space around Earth is filled with invisible electromagnetic information emanating from the nearest stars to the most distant quasars at the limits of the observable universe. Radio waves crackle about pulsars and active galaxies; microwaves echo the "Big Bang," thought to signal the beginning of space and time; X-rays given off by supernova remnants indicate hot spots in the sky; and gamma rays emitted by quasars and neutron stars mark the most energetic celestial bodies and processes.

Gamma rays, the radiation that reveals the most energetic phenomena in the universe, are particularly interesting because they are our only source of information for some events. Because gamma rays from cosmic sources do not penetrate Earth's atmosphere except at extremely high energies, the information they bear is not available to observatories on the ground.

The Gamma-Ray Observatory (GRO) is one of several major new space observatories that we are using to explore the universe. It is designed to identify sources and processes that give rise to extremely high-energy radiation. GRO will make a full-sky survey in the gamma-ray spectral region and characterize many classes of sources. Through gamma-ray observations, we may witness the birth of elements and the deaths of stars, gain more clues to mysterious quasars and pulsars, and glimpse the spacetime precipice of a black hole. Gamma-ray astronomy is a means of viewing some of the most energetic and chaotic objects in the universe, and it can tell us much about their origin and evolution.

The Gamma-Ray Observatory is a part of NASA's Great Observatories program.

Other observatories in the program are the Hubble Space Telescope (HST), covering the visible portion of the spectrum from the near ultraviolet to the near infrared wavelengths; the Advanced X-ray Astrophysics Facility (AXAF), providing high-resolution spectroscopy and imaging in the X-ray band; and the Space Infrared Telescope Facility (SIRTF), an advanced telescope sensitive to photons at infrared wavelengths. GRO will perform coordinated observations with HST during its initial years of operation, and perhaps later with the AXAF and SIRTF observatories. By observing the same object at the same time with different types of instruments, scientists can gain a greater understanding than from separate observations. Such coordinated observations will provide a unique capability to examine the nature of astrophysical objects.

With the other Great Observatories in space, the Gamma-Ray Observatory has a crucial role in our exploration of the universe across the electromagnetic spectrum with unprecedented resolution and sensitivity. By addressing fundamental questions about the greatest transfers of energy in the universe, and by providing the potential for discoveries, GRO will move us closer to understanding how the universe is evolving, the nature of puzzling astronomical objects, and the processes that produce very high-energy radiation.

GRO is a NASA cooperative program with scientific flight hardware furnished by the Federal Republic of Germany, the Netherlands, and the European Space Agency and scientific advisory support from the United Kingdom.

The Gamma-Ray Observatory

To expand our understanding of the gamma-ray universe as revealed through the early, exploratory missions of the 1970's, astronomers recognized the need for an observatory of greatly enhanced sensitivity, angular resolving power, and operating lifetime. The Gamma-Ray Observatory (GRO) is the first spacecraft with a complement of large, sophisticated instruments designed to study a broad range of gamma-ray energies. Its advanced instruments are the most sensitive flown to date, capable of detecting gamma-ray photons, measuring their energies, and determining where they originated with unprecedented precision.

Pioneering observations in gamma-ray astronomy have been made with previous instruments aboard balloons and smaller spacecraft. Better observations require massive detectors that operate for long periods of time above the atmosphere. Soon, the Space Shuttle will place the heaviest scientific observatory ever designed into orbit. GRO weighs nearly 17 tons and fills one-half of the Shuttle bay; the instruments weigh about 6 tons, and three are each about the size of a subcompact car.

The spacecraft is designed to have a minimum life of 2 years, but it can be extended to 4 years or longer. During its first year of operation, it will make a more detailed survey of the gamma-ray universe than any yet obtained. In later years, it will view in greater depth the intriguing objects identified by the survey. The longer observing time dedicated to a particular source or region will permit a much more detailed characterization of its properties and the processes responsible for its gamma-ray production.

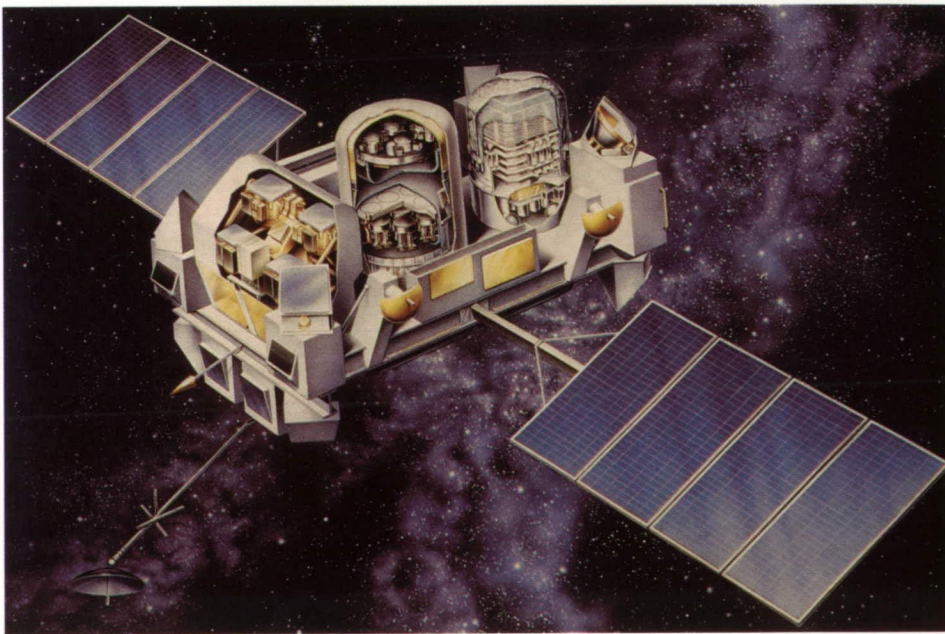

The GRO spacecraft has greater capabilities for observing than any previous gamma-ray mission.

*Gamma-ray
astronomy timeline*

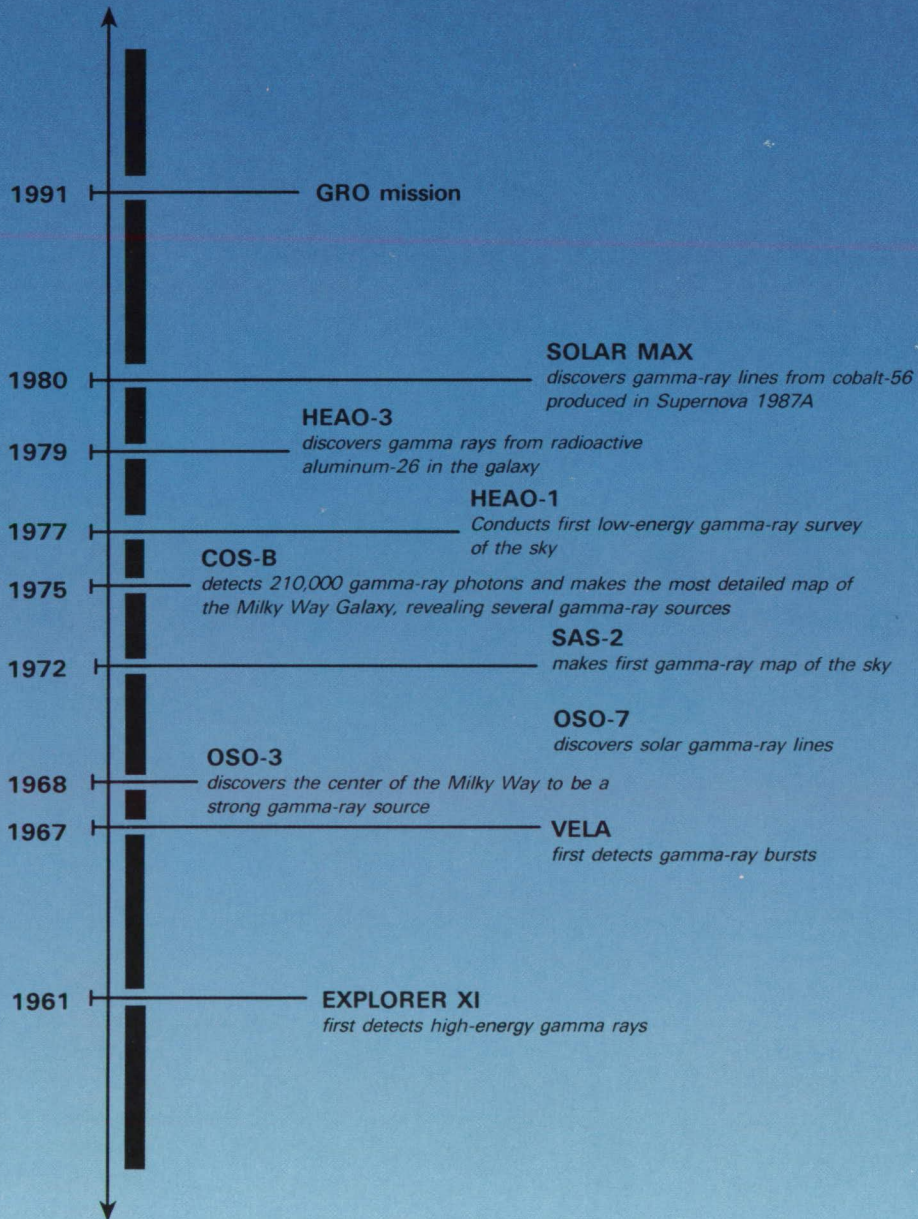

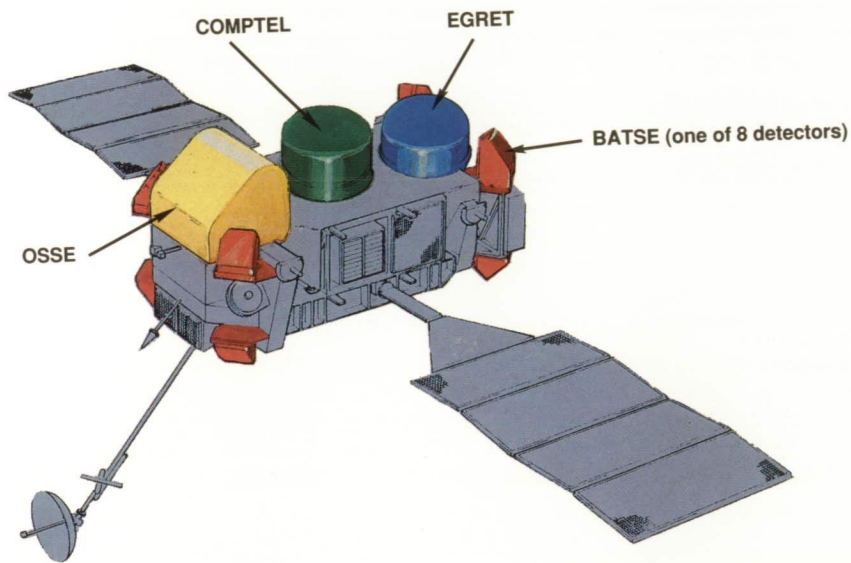

GRO instruments

Detecting Gamma Rays

GRO has a complement of four instruments: the Burst and Transient Source Experiment (BATSE), the Oriented Scintillation Spectrometer Experiment (OSSE), the Imaging Compton Telescope (COMPTEL), and the Energetic Gamma Ray Experiment Telescope (EGRET).

GRO instruments are much larger and much more sensitive than any gamma-ray instruments ever flown in space. Size is crucial for gamma-ray astronomy; because gamma rays are detected when they interact with matter, the number of gamma-ray events recorded is directly related to the mass of the detector. Since the number of gamma rays from

sources is small, large instruments are needed to detect a significant number of photons in a reasonable amount of time.

GRO detects photons with energies from the upper end of the X-ray spectrum at 20 thousand electron volts (keV) to more than 30 billion electron volts (GeV). By simultaneously monitoring gamma rays across a wide range of energies, physicists will be better able to catalogue the energies of photons from each source and model the mechanisms that produce gamma rays. Different detection methods are required to observe the various regions of the gamma-ray spectrum. Each observatory instrument is tailored to recognize gamma rays within a specific energy range, with each instrument's coverage overlapping another's so that data can be compared.

Gamma rays cannot be focused on detectors by the usual means of optical astronomy. All of the observatory instruments have scintillators. Just as fluorescent paint converts ultraviolet radiation to visible light, scintillators change gamma rays to visible light. When gamma rays interact with certain types of crystals, liquids, and other materials, they produce flashes of light (scintillations). These light pulses are recorded by photomultiplier tubes, electronic sensors much more sensitive than the human eye. The brighter the light pulse, the higher the energy of the gamma ray.

Unfortunately, cosmic rays (charged particles with high energies) also react with scintillators to produce light. Cosmic rays are much more numerous than gamma rays; trying to detect gamma rays against this cosmic ray

background is like trying to look at the stars during the day. To reduce the background, each GRO instrument distinguishes gamma rays from cosmic rays and other particles. All four instruments have a plastic outer particle detector, called an anticoincidence

counter, that records cosmic rays and other charged particles by giving off a signal different from gamma rays.

OSSE is designed to detect 0.1-10 million electron volts (MeV) gamma rays entering the field of view of any of four identical detectors. Each detector has a

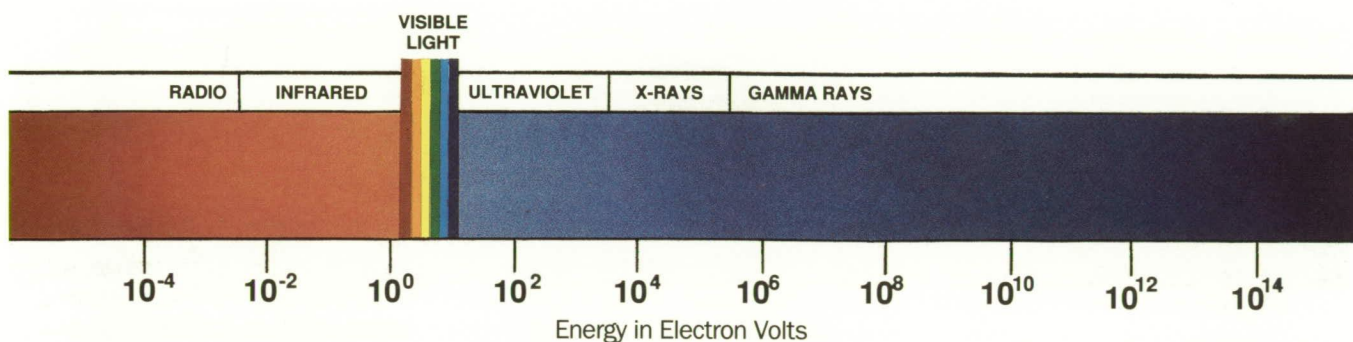

Electromagnetic spectrum

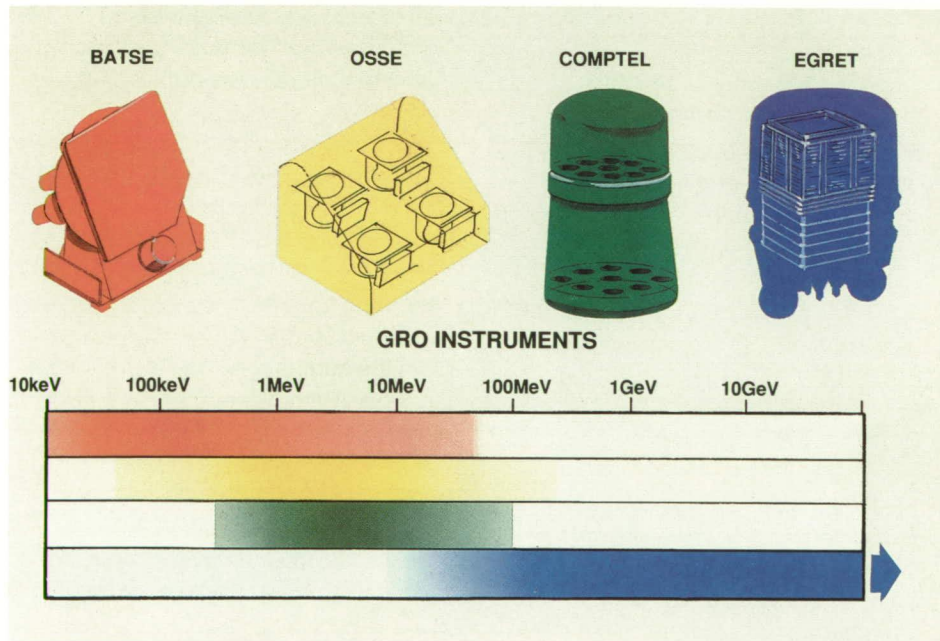

GRO energy range

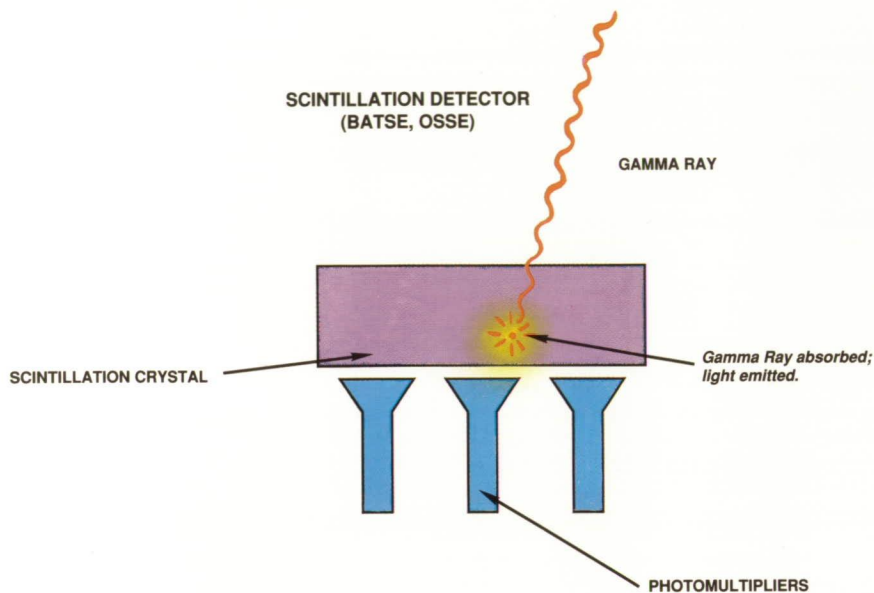

Scintillation detector

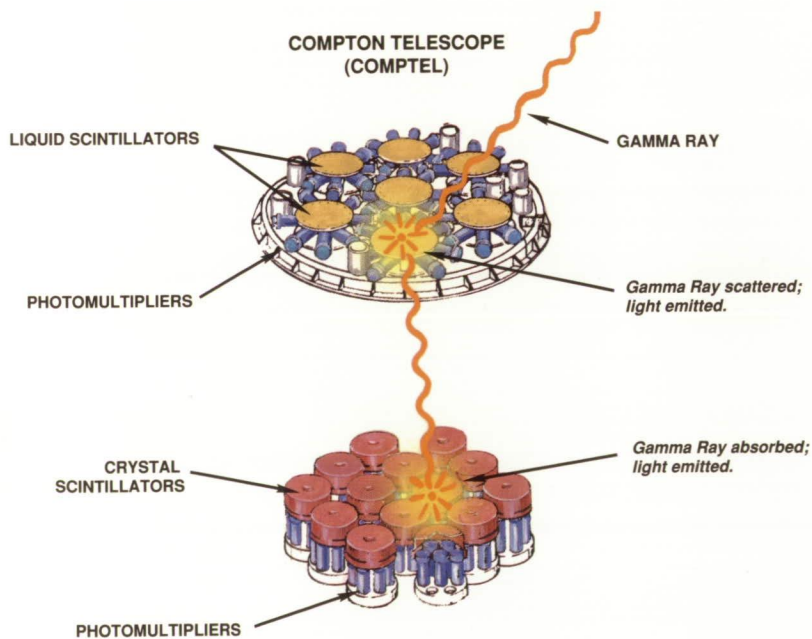

Compton telescope

main scintillation crystal made of sodium iodide surrounded by other scintillators that absorb gamma radiation arriving from the sides and back of the detector. A massive collimator, which defines a $3.8^\circ \times 11.4^\circ$ field of view, provides the collimation for gamma radiation entering directly into the front of the detector. Each detector can be rotated to point at the source under study or offset from the source to measure the gamma-ray background. Subtraction of the background measurements from the source observations enables OSSE to derive the intensity and spectrum of very weak cosmic gamma-ray sources.

BATSE observes the entire sky not blocked by Earth in the field of view of its eight detectors and looks for changes in gamma-ray flux. BATSE is optimized to detect low-energy gamma rays at energies from 20 to 600 thousand electron volts (keV) and can record changes in gamma-ray intensity in time intervals as short as a fraction of a millisecond.

As the energy of gamma-ray photons increases, scientists can distinguish them from lower-energy photons and other particles such as cosmic rays by the unique ways that they interact with matter inside a detector. COMPTEL observes gamma rays from 1 to 30 MeV; gamma rays in this range are scattered by electrons in the liquid in COMPTEL's upper detectors. This process, called Compton scattering, occurs only between electrons and high-energy photons, not between electrons and charged particles. The scattered gamma rays are then detected by

COMPTEL's lower set of crystal scintillation detectors.

The EGRET instrument is configured to detect gamma rays with the highest energies. When a gamma ray with energy greater than 10 MeV encounters the metal layers of a detector called a spark chamber, it produces an electron and its antimatter equivalent, a positron, that behave in a distinctive manner. The track of the pair and the angle between them is related to the direction and energy of the incoming gamma ray. A massive scintillation detector helps to determine the energy of the incoming gamma rays.

Each instrument measures the energy of individual gamma-ray photons, but the final data appear in different formats. The BATSE and OSSE detectors measure the energy of photons and produce spectra that help identify the nuclear species and processes of gamma-ray sources. COMPTEL and EGRET collect spectral data as well as image the gamma-ray sky. The four instruments will be able to study sources 10 to 50 times fainter than those observed previously, thus expanding the volume of the observable gamma-ray universe up to 300 times.

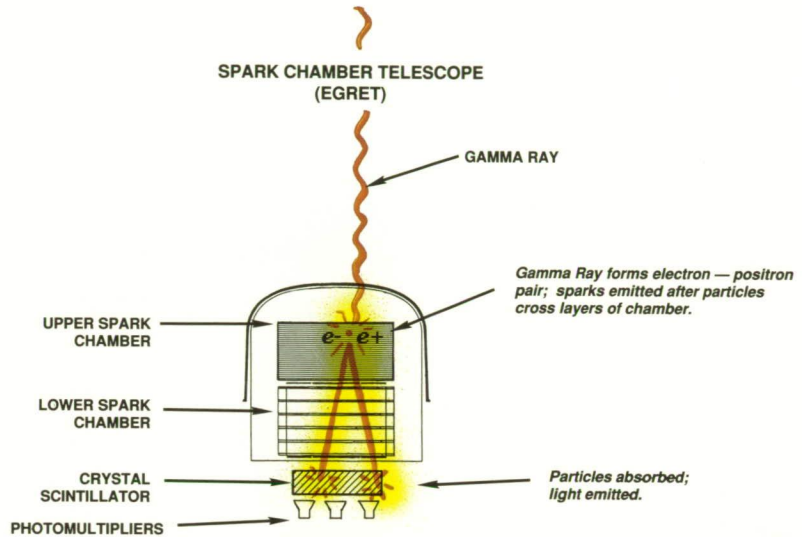

Spark chamber telescope

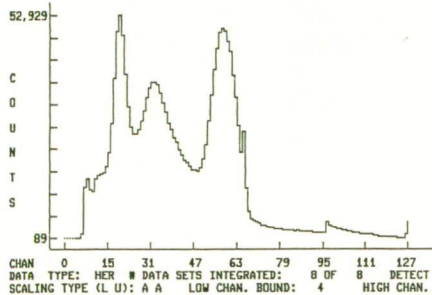

BATSE test spectrum

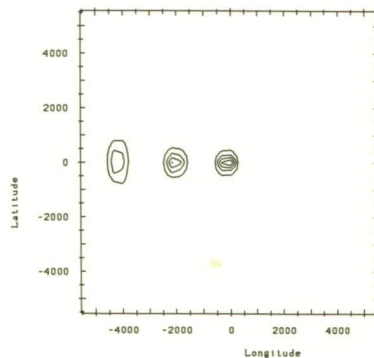

COMPTEL test image

Locating Gamma-Ray Sources

The GRO spacecraft provides scientists with some of the data needed to locate gamma-ray sources. The spacecraft points the instruments at specific regions of the sky for periods of about two weeks. The instruments are pointed within a half degree of the desired direction, and the pointing direction is known to within 2 arc minutes (0.03 degree). The time is constantly recorded and its accuracy of 1/10,000th of a second is the best yet developed for spacecraft science data. The attitude and timing data as well as orbital position are recorded and transmitted to the ground. Scientists will use this

information along with data from the specific detectors to determine the location of sources. The timing accuracy is important for correlating GRO measurements with other space- or ground-based observations.

Each detector's angular resolution, the ability to distinguish separate objects, is related directly to its ability to locate gamma-ray sources precisely. Previous instruments have detected gamma rays from more than 30 sources, but most of these have not been identified as objects known from optical, radio, X-ray or other observations. At best, these gamma-ray sources have been located within 1 degree of arc (60 arc minutes), an area twice as large as the apparent size of the full moon. There are

far too many objects in such an area to know with certainty which one is the gamma-ray source.

The GRO instruments will routinely locate sources within a fraction of a degree. EGRET (and to a lesser extent, COMPTEL) can locate sources within 0.1 degrees of arc, one-fifth the apparent size of the full moon. This will give other ground-based and space observatories better information to point to the same location in the sky and look for a recognizable source that also emits visible light or other radiation. With their improved detector resolution and greatly increased exposure times, the GRO instruments are expected to locate sources 10 times more accurately than previous gamma-ray instruments.

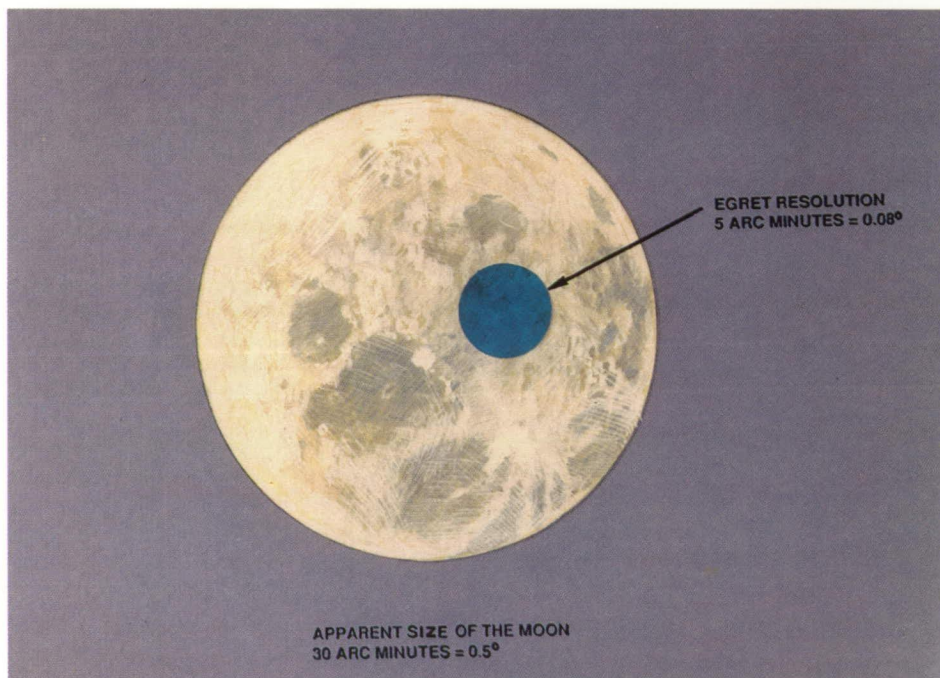

GRO location accuracy

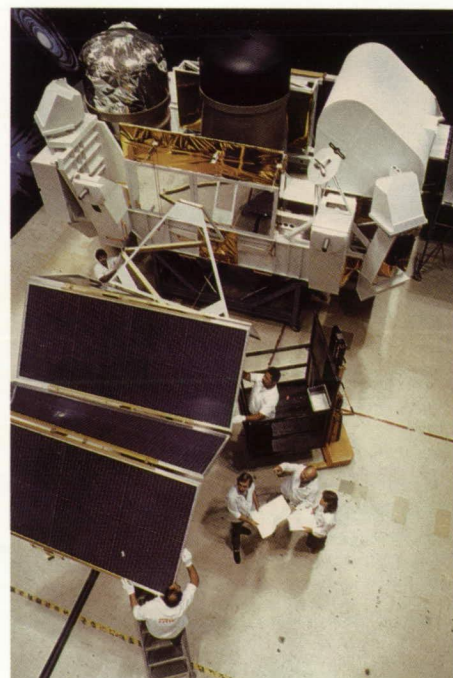

Gamma-Ray Observatory mockup

Observatory Operations

The Space Shuttle makes it possible to put massive observatories with sensitive instruments in space above the atmospheric veil. At an altitude of 450 kilometers (280 miles), the Shuttle's robot arm removes the GRO from the payload bay and places it in space.

The orbital altitude was chosen to minimize the effects of charged particles trapped in Earth's magnetic field and to keep the observatory high enough to reduce atmospheric drag that causes loss of altitude. The spacecraft has a propulsion system that can be used to reboost GRO and keep it in space much longer than its minimum 2-year life. Once the fuel is expended, the observatory's life can be extended if it is refueled

by a Shuttle crew or reboosted by the planned Orbital Maneuvering Vehicle (OMV).

The spacecraft also provides many essential services to the scientific instruments: power, pointing control, thermal control, precise timing, and data recording and transmission. Insulation and heat exchangers are used to protect the instruments from the harsh temperature extremes of space. Two solar arrays provide energy to six nickel cadmium batteries that supply an average of 2,000 watts of power to the observatory.

As the observatory orbits Earth, three of the instruments (OSSE, COMPTEL, and EGRET) are fixed on objects in deep space. During the portion of each 93-minute orbit when Earth blocks their

view, the instruments can be calibrated in preparation for the next observing period. Since BATSE has detectors mounted on both sides of the observatory, part of the sky is always viewed by BATSE. The OSSE detectors can be rotated, thus permitting them occasionally to be oriented to view the sun or other objects during Earth occultation of the primary source.

Each instrument's field of view defines how much of the sky it is exposed to at one time. The BATSE detectors view about two-thirds of the sky. OSSE sees a 3.8 by 11.4 degree rectangular area of sky; EGRET views a 30-degree field; and COMPTEL has a 60-degree field of view. The instruments are positioned on GRO so that they do not block each other's view. The viewing axes of the three pointed instruments are coaligned, enabling simultaneous studies of sources across the gamma-ray energy spectrum.

An observing plan is being developed by the scientists who designed the GRO instruments. The plan calls for COMPTEL and EGRET to spend the first year in orbit surveying the entire sky. Each field of the celestial sky will be viewed for two weeks. At the same time, OSSE will be recording the spectra of objects within these regions, and BATSE will observe bursts, solar flares, and other transients. If an interesting object such as a supernova or other new source is spotted, the observatory can be reoriented toward the event, temporarily interrupting the preplanned observing program.

Each instrument sends data from its own processor to the observatory's central data system where data are

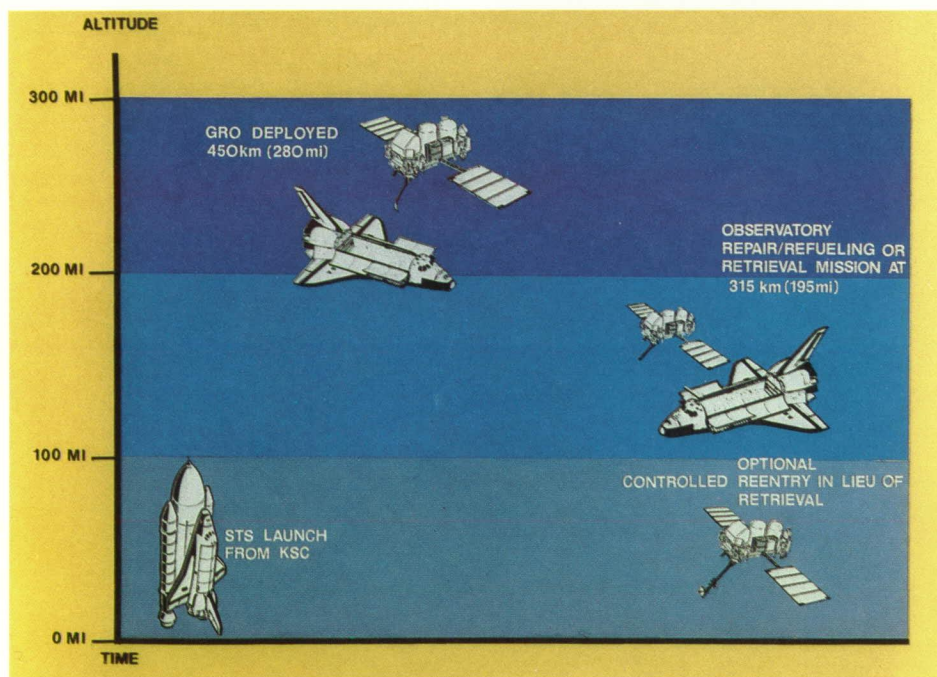

GRO mission scenario

stored and later sent to computers on the ground. Data are transmitted via NASA's Tracking and Data Relay Satellite System to the Goddard Space Flight Center (GSFC) Payload Operations Control Center (POCC). During the

observatory's initial operational phase, investigators from the instrument teams will work in the POCC where they will use computers and other equipment to interpret the data. In most cases, extensive data processing must be

performed to remove background radiation data to determine the true gamma-ray source flux.

To exploit GRO's observational capabilities and its resultant data archive, NASA is planning a Guest Investigator Program for substantial involvement of the broader astrophysical community in GRO investigations and data analysis. The observing plan for the second year will be defined based on the first year's observations.

It is highly probable that the Gamma-Ray Observatory mission will be extended beyond 2 years. If repairs or refueling are required, a team of Space Shuttle astronauts may visit the observatory and service the spacecraft. At any point during the mission, the Space Shuttle can retrieve GRO and return it to Earth or the observatory's reentry into the atmosphere can be controlled from the ground.

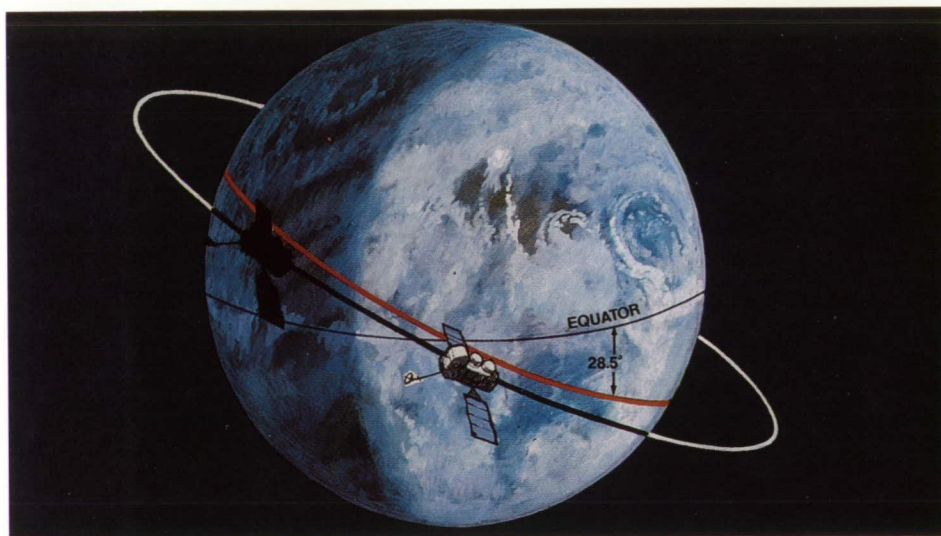

GRO orbit

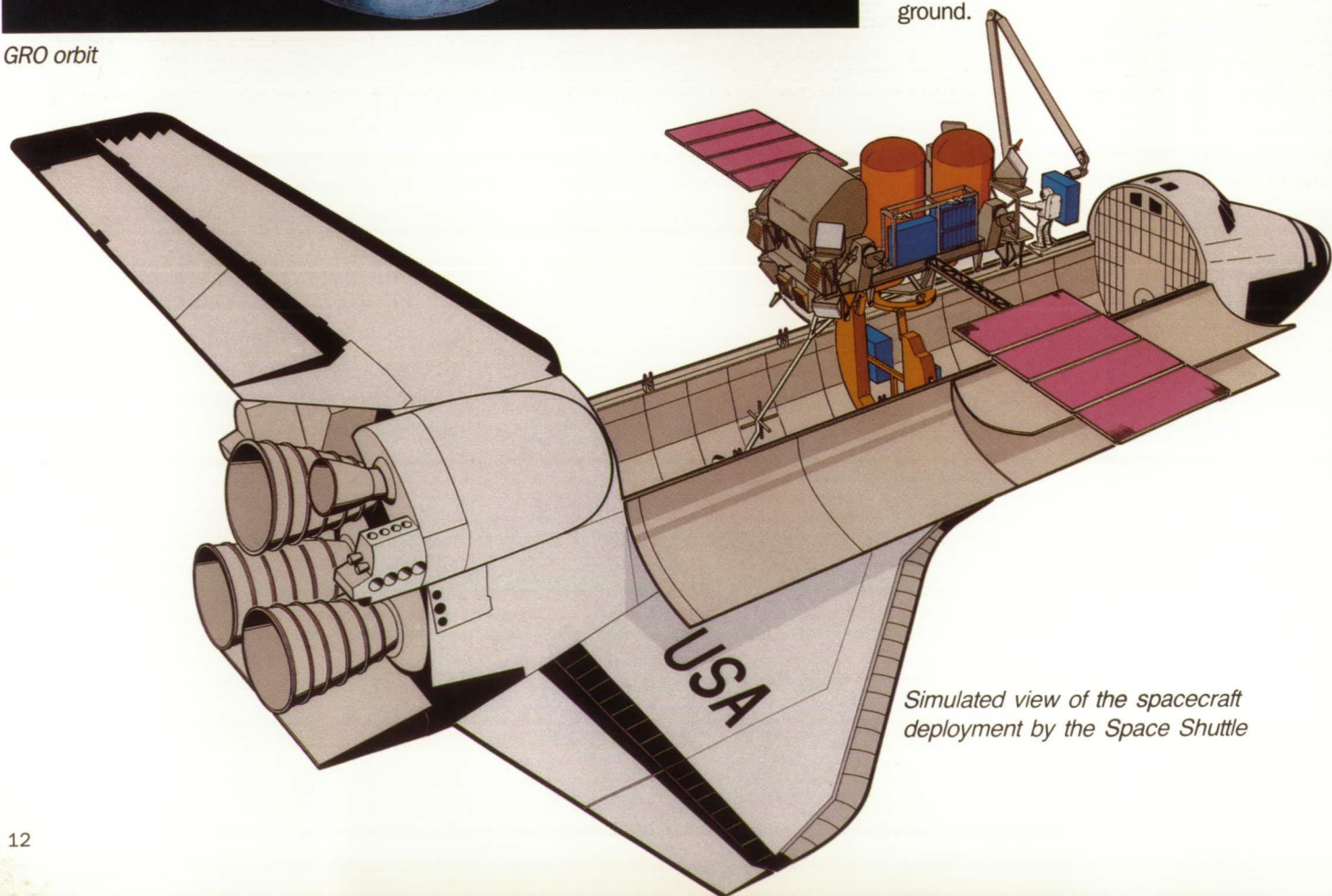

Simulated view of the spacecraft deployment by the Space Shuttle

*Training to refuel
the GRO spacecraft*

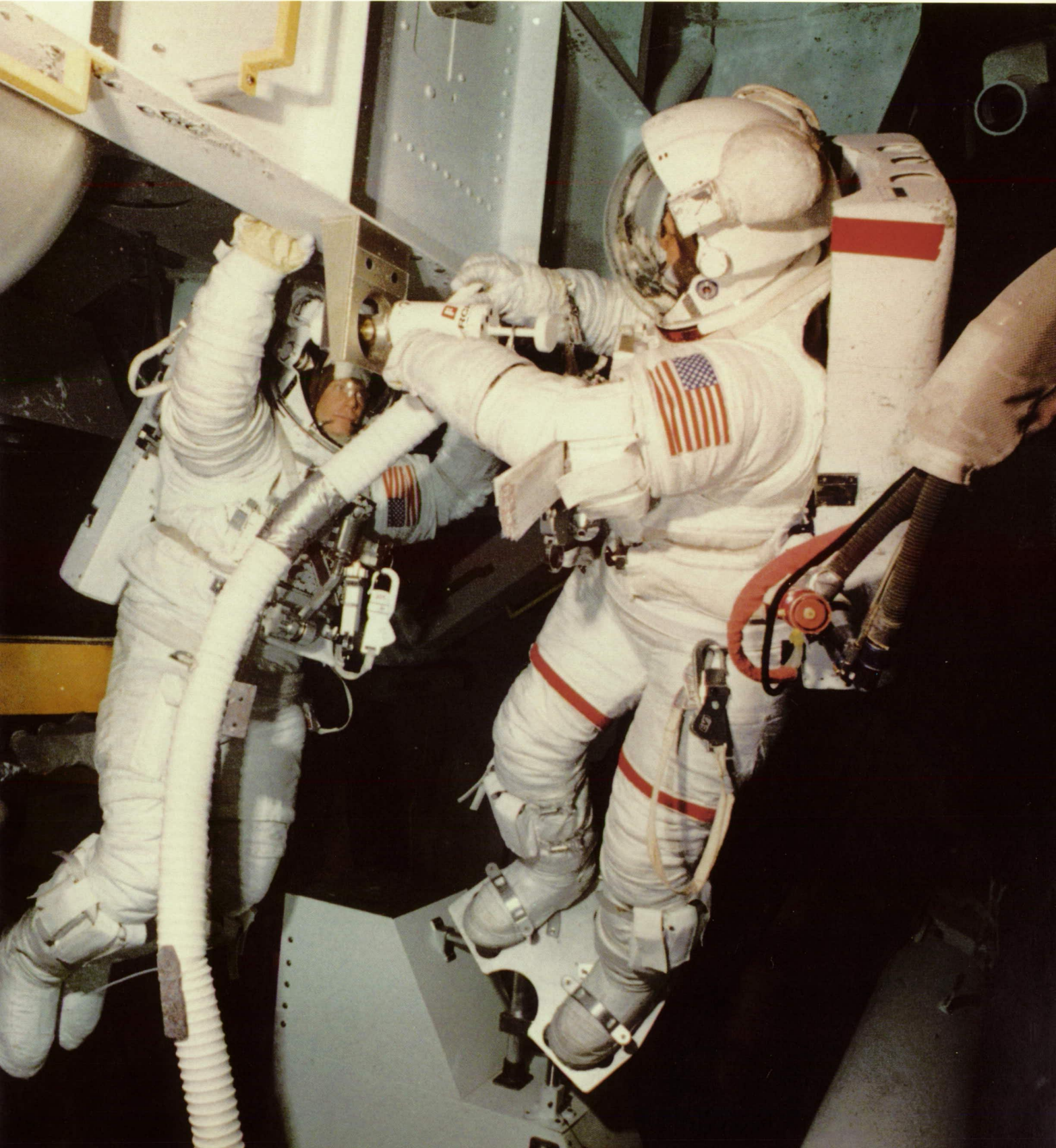

The Gamma-Ray Universe

The cosmic processes thought to be sufficiently energetic to produce gamma rays include, among others, the decay of radioactive nuclei, accelerated particles traveling in regions of strong magnetic fields, electrons colliding with and transferring energy to lower energy photons and boosting them to gamma-ray energies, very energetic nuclei colliding with other nuclei, energetic electrons “braking” as they traverse matter, and the annihilation of matter in the presence of antimatter. Instruments on the Gamma-Ray Observatory will seek to detect radiation from these processes, which, in many cases, is the only way to study them. Localized sources of gamma rays include supernovae, quasars, the centers of active galaxies, pulsars and neutron stars, gamma-ray bursters, and black holes.

How Gamma Rays Are Produced

The places in the universe where gamma rays are produced are of interest to scientists, who ask questions about the forces of change in the universe, the nature of explosive events, and the evolution of stars and galaxies. How did the universe begin? Will it continue to expand, or will it eventually collapse upon itself? How can charged particles be accelerated to incredible energies? What is the nature of quasars, and why are they so powerful? What causes sporadic, intense bursts of gamma rays in the sky? What is happening in the centers of galaxies; do massive black holes exist there? Where does the cosmic gamma-ray background radiation originate? Do stars and galaxies of



*Celestial gamma-ray emitter
(M87 galaxy)*

Crab Nebula





antimatter exist? How are the elements heavier than hydrogen and helium produced? Astronomers look to the Gamma-Ray Observatory for some of the answers to these questions.

Because gamma rays are highly energetic, they can penetrate much of the interstellar matter that blocks our view at other wavelengths; because they have no electrical charge, their paths are unaffected by magnetic fields in space. These two characteristics allow astrophysicists to locate the sources of cosmic gamma rays, and from these sources to learn about the high-energy processes in which gamma rays are produced.

The spectral signature of a particular source contains clues to the density, temperature, and chemical composition of that source. Atoms and molecules absorb or emit radiation of characteristic energies at infrared, optical, or ultraviolet wavelengths; at gamma-ray energies, nuclei and their radioactive isotopes and nuclear reactions can be identified. With the technique of nuclear spectroscopy, the detailed study of how intensity varies with photon energy, astronomers can model the physical conditions at the radiation's source. From these models, theories can be developed about the creation of elements in the explosion and

collapse of giant stars, the acceleration of charged particles to velocities approaching the speed of light, and the destruction of matter and antimatter — all processes associated with the production of gamma rays.

Nucleosynthesis

Gamma-ray observations have confirmed one of the central theories of modern astronomy — that heavier elements are formed from the fusion of atoms of lighter elements, a phenomenon known as nucleosynthesis. It is thought that most elements heavier than silicon form during giant star explosions known as supernovae. Instruments aboard the Gamma-Ray Observatory will examine the material that envelops known supernovae for gamma rays produced by radioactive decay. If the decay of unstable radioactive elements to stable elements is occurring in supernovae, the gamma-ray spectrum produced by the debris will contain lines peculiar to specific radioactive elements and will provide insight into the details of nucleosynthesis.

Particle Acceleration

In various regions of space, charged particles such as electrons, protons, and heavier nuclei are accelerated to very high energies. These processes include

some of the greatest transfers of energy in the Universe and involve the interaction of particles with the magnetic, electric, and gravitational fields in which they reside. Gamma rays can result from interactions of the accelerated particles with the fields, other particles, and photons in the region. By observing the spectral distribution of the gamma rays, astronomers are able to obtain information about both the acceleration process and the characteristics of the fields.

Matter/Antimatter Annihilation

Theory holds that every particle of matter of a particular mass and charge has a counterpart of antimatter of the same mass but opposite charge. The antimatter particle that complements the negatively charged electron, for example, is the positively charged positron. When particles of antimatter and matter interact, both are annihilated, with an accompanying release of gamma rays. For example, a collision between a positron and an electron destroys the pair and releases energy as two gamma rays, each with a particular energy of 511 thousand electron volts (keV). Photons of the known annihilation energy that are detected by the Gamma-Ray Observatory may point scientists toward the location of regions containing significant amounts of interacting antimatter and matter.

Sources Of Gamma Rays

Supernovae

The Gamma-Ray Observatory will survey known supernovae remnants, seeking evidence of nucleosynthesis. Supernovae explosions create the heavy elements, some of which are radioactive and produce gamma rays. Some stars that become supernovae are many times more massive than our sun and burn all their hydrogen within the span of 10 million years or so. As hydrogen is consumed, the inward pressure of gravity gradually increases until hydrogen nuclei in the star's core fuse, creating helium, which in turn begins to burn as temperatures rise. Under the influences of temperature and gravity, elements of increasing mass are produced until the star is made of elements as heavy as

iron at its center, surrounded by shells of lighter elements, the outermost being hydrogen. When the core of the star consists entirely of iron, no more thermonuclear energy is available. At this point, the star collapses into a tiny but very dense core of neutrons. With the star's collapse, a tremendous shockwave moves rapidly outward, blowing off the outer layers of the star, and radiating over the entire electromagnetic spectrum. For a while, the supernova may outshine its entire galaxy. Scientists believe that most of the visible light output of a supernova is powered by the decay of radioactive elements formed in the explosion. This decay can be observed directly in gamma rays.

Neutron Stars and Pulsars

Neutron stars are thought to be the collapsed remnants of stars after a supernova phase. These very small, very dense stars have tremendously strong magnetic and gravitational fields. The forces exerted by tightly compacted neutrons and those created by gravity are in equilibrium, keeping the stars from collapsing further. Rotating neutron stars called pulsars emit radio waves at regular intervals, similar to a lighthouse beacon. Two of these pulsars have also been seen in gamma rays and visible light, and one in X-rays. While many neutron stars may be pulsars, it is only when Earth is in line with the radiation that the emissions are detected. From radio observations of pulsars, the most accurate determination to date of the interstellar magnetic field has been made. Some pulsars rotate so regularly that they can be treated as standard clocks.



Vela Pulsar

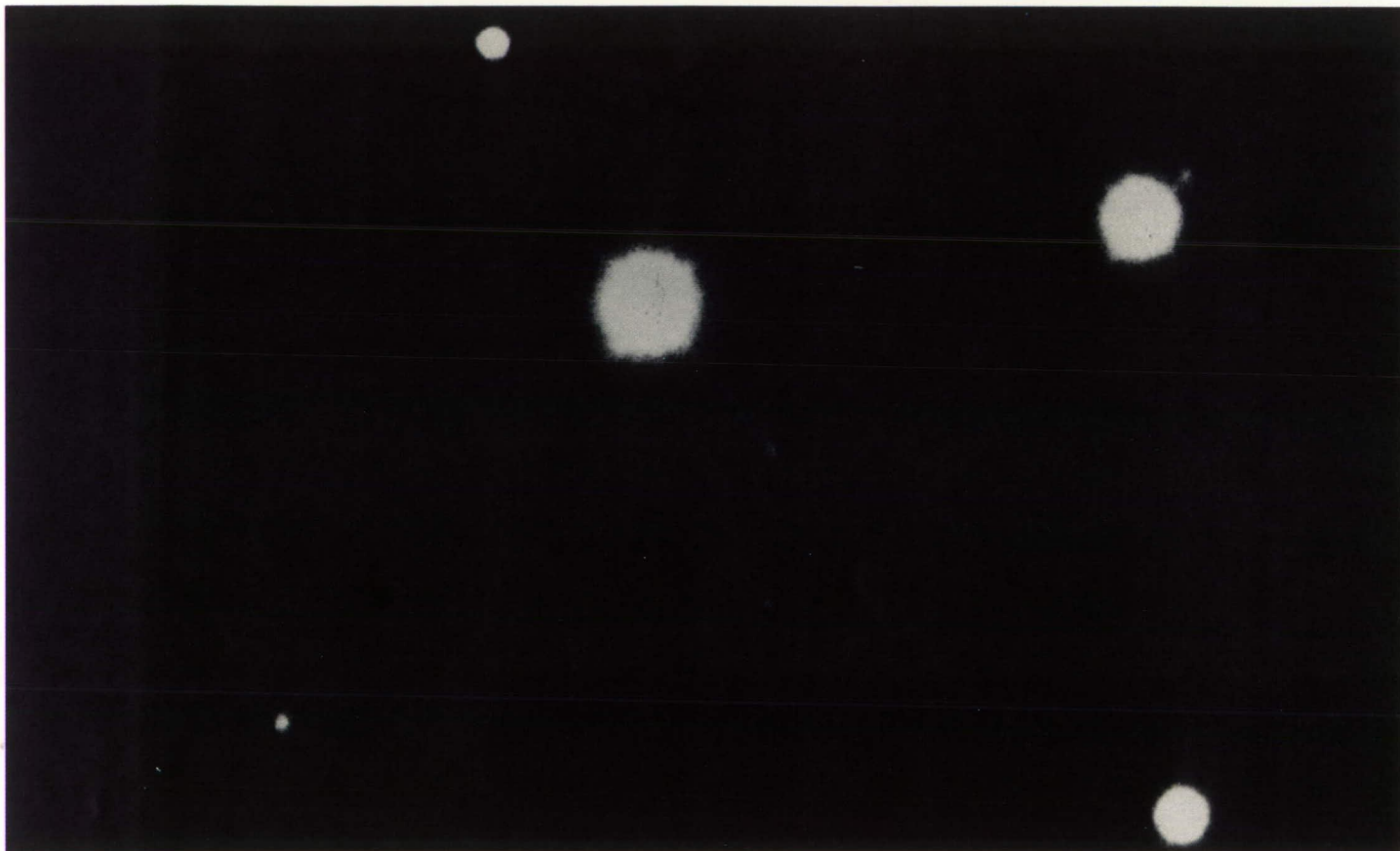

Quasar 3C 273

One of the major successes of gamma-ray astronomy to date has been the discovery of periodic gamma-ray emission from two radio pulsars and hints from others. The spinning neutron star efficiently converts rotational energy into gamma rays; there is no clear explanation of this process. Predictions for observations with the sensitivity of the instruments on the Gamma-Ray Observatory suggest that many additional pulsars may be observed.

Quasars

Quasars are the most energetic known objects in the cosmos and lie billions of light years distant. No other known class of objects in the universe emits more energy. Though, to date, only one quasar, 3C 273, has been identified as a gamma-ray emitter, the COS-B satellite revealed that half of the energy from this strange object is emitted as gamma radiation. This finding suggests that GRO may detect many such objects. The name quasar, shorthand for "quasi-

stellar radio source," implies the uncertainty over their nature. Although it is known that quasars flicker and that their radio waves and visible radiation vary on time scales of days to weeks, astronomers are not certain what quasars actually are nor how they can be so luminous. They may be cores of exploding galaxies or the nuclei of active galaxies that have no visible outer regions because of their extreme distance or young age.

Supernova 1987A (SN 1987A)

Astronomers using ground-based telescopes routinely detect supernova, several times each year, from outside our galaxy. However, on February 24, 1987, light from the first supernova explosion to be observed by the naked eye in nearly 400 years reached the Earth. Scientists worldwide, long anticipating such an event, celebrated the discovery; those in the Southern Hemisphere (where the supernova appeared) rushed to observatories to view the nearest visible supernova since the invention of the telescope. The supernova was designated SN 1987A because it was the first supernova discovered that year.

A flurry of activity began as astronomers used every available orbiting observatory. Within hours of the discovery, the International Ultraviolet Explorer began its observations of SN 1987A; two ultraviolet detectors aboard Voyager 2, on its way to Neptune, also focused on the supernova; the Solar Max satellite, observing the sun, was used to seek gamma rays from the exploding star; and the newly launched Japanese satellite Ginga was ordered into operation sooner than planned to take advantage of the discovery and to detect early X-rays from the event.

Theorists had predicted that massless (or nearly massless) neutrino particles would be ejected at the time of a supernova explosion. Data were searched from deep underground neutrino detectors to find any evidence of neutrino showers occurring near the time of the visual sighting of the supernova. Records from detectors in Japan and the United States revealed that the Earth did indeed receive a neutrino bombardment that correlated with the sighting. Theorists were elated by this striking confirmation of theory.

During the first few months of scrutiny, astronomers had their best look at the death of a massive star, witnessing an explosion that took place 170,000 years ago in a nearby galaxy, the Large Magellanic Cloud (LMC). SN 1987A is also teaching scientists about what lies between the Milky Way and the LMC and between the stars in our galaxy. As light from the supernova approaches Earth, it passes through gas clouds that absorb particular wavelengths of light, depending on the chemical composition of the cloud. Lines evident in the early spectra indicate that the spaces, though dominated by hydrogen, are also rich in calcium, sodium, magnesium, and potassium.

Beginning 6 months after the appear-

ance of the supernova, the Solar Max satellite and high-altitude balloon experiments detected gamma rays produced by cobalt-56, one of the elements indicative of radioactive decay leading to the formation of iron nuclei. The detection of these photons provides the first observed confirmation of theories about the formation of heavy elements in supernova explosions.

Details about SN 1987A are far from being understood. Instruments in ground observatories, aboard high-altitude balloons, and on satellites will continue to probe this nearby supernova for many years to come. When the Gamma-Ray Observatory begins operations, it will join these investigations, using its large, sensitive instruments to study the Large Magellanic Cloud and SN 1987A.



Active Galaxies

A normal galaxy shines with the accumulated radiation of its mantle of stars, and most of its radiation is emitted as visible light. Active galaxies, in contrast, shine brightest in radio, infrared, or X-ray energies, or even gamma rays. The peculiarity of most active galaxies is the varying intensity of their radiations, which may change from week to week, even from hour to hour. The reason for this variability is the cause of much speculation: the centers of active galaxies could be the sites of sporadic synchrotron processes (interactions of electrons with strong magnetic fields) that might produce the variability; or a series of explosions could be accelerating electrons to nearly the speed of light. Most astronomers believe that a massive black hole resides at the center of active galaxies and that accretion of material in its vicinity is the source of the tremendous energy output of these galaxies.

Bursts and Transient Sources

Intense, sporadic bursts of gamma rays appear throughout the sky. They have proven difficult to study in detail, because their occurrence is unpredict-



Centaurus A galaxy

able and their duration short. About a hundred gamma-ray bursts per year are recorded by detectors on various spacecraft. During their short lifetimes, bursters outshine all other gamma-ray sources combined. A burst that seemed to originate in the Large Magellanic Cloud, observed in 1979, released more energy in gamma rays in one-tenth of a

second than the total energy the sun will emit over the next thousand years. Many theories exist about the nature of bursters, but most astronomers speculate that they are related to neutron stars and their intense magnetic fields and that most are located within our Milky Way galaxy.

Black Holes

In theory, a massive star may collapse to a mere point. Its gravity attracts nearby matter or energy. Nothing escapes such an object, not even light, and astronomers call it a black hole. It is not possible to detect black holes directly, but the nearby regions may be alive with high-energy activity. Near a point of no return, matter is sucked into the black hole under extreme pressures and temperatures and at relativistic velocities; that region, known as the event horizon, radiates gamma-ray photons. The photons produced along the event horizon become valuable probes of the nature of the black hole. Black holes have yet to be conclusively identified.

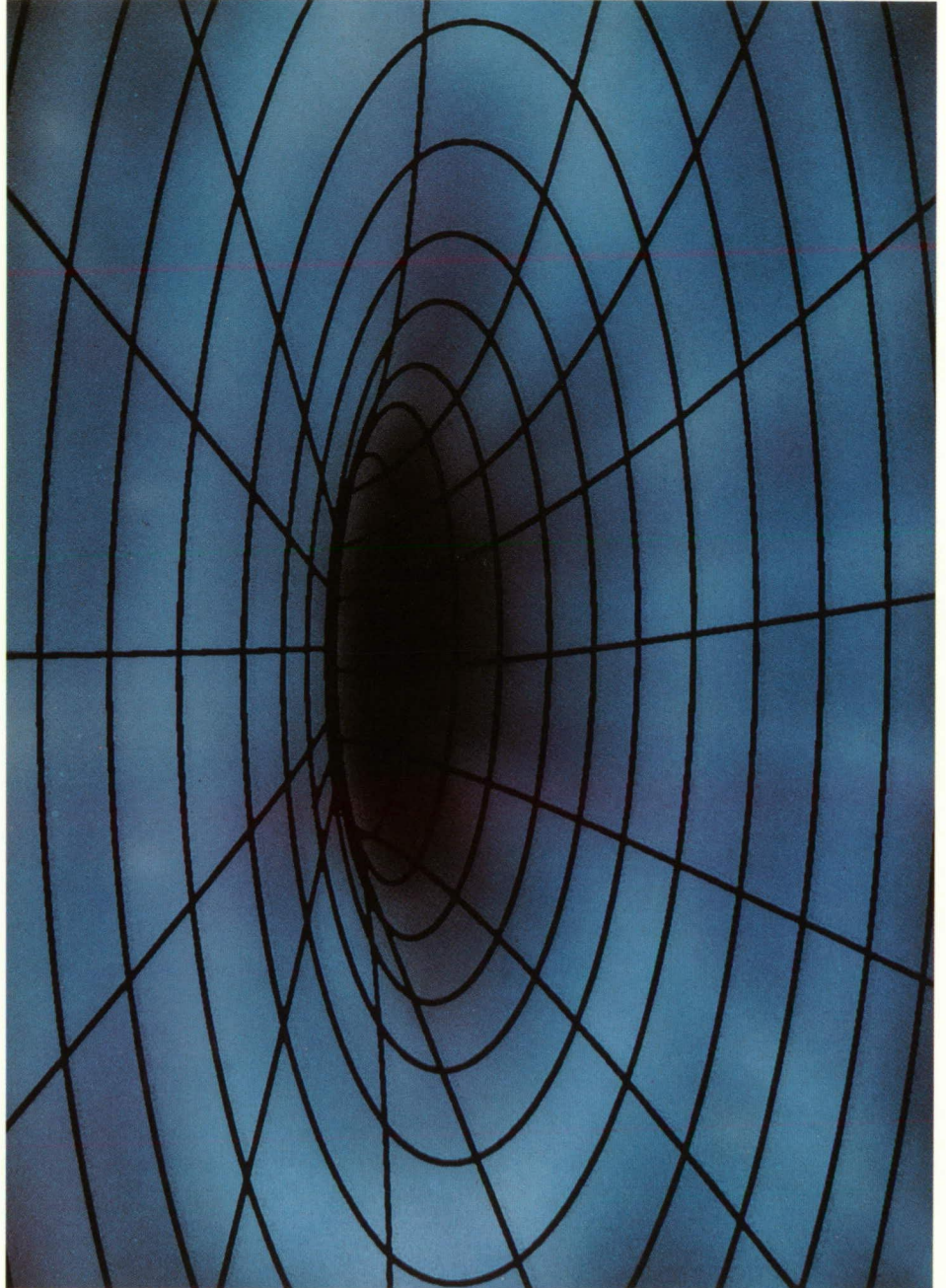

Black hole

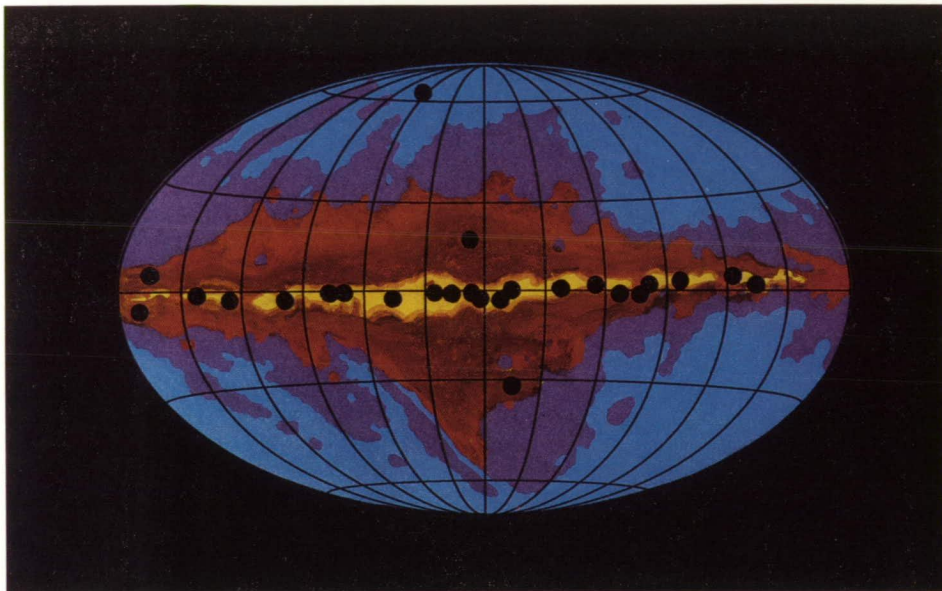

Gamma-ray map of the Milky Way galaxy

Milky Way Galaxy

A diffuse glow of gamma-ray emission from the plane of the Milky Way galaxy has been observed. However, neither the physical nature of this glow nor the degree to which heretofore undetected discrete sources contribute to the emission has been determined. Cosmic rays, which consist primarily of highly energetic hydrogen and helium nuclei, are present in the interstellar medium, and their interaction with other matter contributes to the diffuse gamma-ray emission. It is also known that the unresolved emission from localized sources must constitute some fraction of the observed gamma rays. These sources could be massive objects such as black holes or neutron stars, and the sites could involve binaries, supernova remnants, novae, or cosmic rays interact-

ing with molecular clouds or other regions of high matter density. Gamma rays are expected to reveal the powerhouse of our galaxy and add to our knowledge of galaxy formation.

Extended Sources

Observation of extended sources in our Milky Way galaxy has given a glimpse of the wealth of information to be gained about the dynamics of large-scale structures. Principally due to cosmic-ray interactions with various distributions of matter, gas, and dust in interstellar space, the regions range from more localized features such as the Orion and Rho-Ophiucus interstellar cloud complexes, light years in extent, to large-scale features such as the spiral arms of our galaxy. Through more refined observations of these regions, much can

be learned about the distribution of cosmic rays and matter in the galaxy and about the dynamic balance between expanding pressures of the cosmic ray gas, the galactic magnetic fields, and the thermal motion of matter and the gravitational fields that bind them to the galaxy.

Extragalactic Diffuse Radiation

The celestial sky has a fairly uniform glow at gamma-ray energies. This diffuse background is believed to originate mostly from beyond our own Milky Way galaxy. GRO will study the origin and nature of this glow which may come from events which occurred at very early times after the "big bang."

Unidentified Sources

Over 30 galactic sources have been reported from previous gamma-ray observations, many of which remain unidentified as sources at other wavelengths. Is this a major new class of objects seen only in gamma rays, or are these simply local fluctuations in matter and cosmic ray intensity? The improved sensitivity and angular resolution of the Gamma-Ray Observatory should provide the data needed to address this question, one of the major puzzles of gamma-ray astronomy.

GRO
Principal Investigators

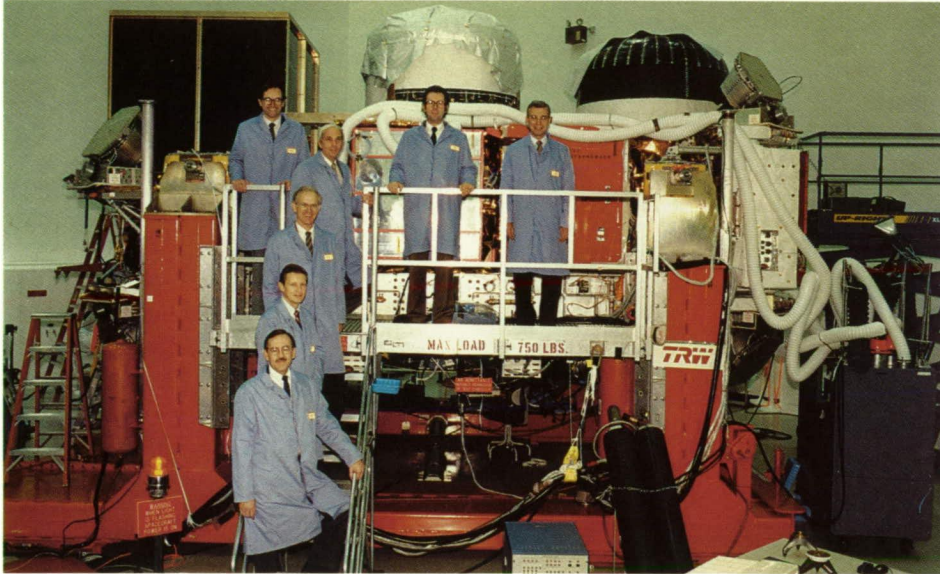

Members of GRO Science Working Team with Gamma-Ray Observatory during installation. Platform, left to right: J. Kurfess (OSSE), V. Schoenfelder (COMPTEL), C. Fichtel (EGRET), stairs, top to bottom: G. Fishman (BATSE), D. Kniffen (Project Scientist), D. Bertsch (Asst. Project Scientist), A. Reetz (Former Program Manager)

Instruments	Principal Investigators	Institutions
Burst and Transient Source Experiment (BATSE)	G. Fishman	NASA/Marshall Space Flight Center Huntsville, Alabama
Oriented Scintillation Spectrometer Experiment (OSSE)	J. Kurfess	Naval Research Laboratory, Washington, D.C.
Imaging Compton Telescope (COMPTEL)	V. Schönfelder	Max Planck Institute, Germany
Energetic Gamma Ray Experiment Telescope (EGRET)	C. Fichtel	NASA/Goddard Space Flight Center Greenbelt, Maryland
	R. Hofstadter *	Stanford University, Stanford, California
	K. Pinkau	Max Planck Institute, Germany

*Deceased

Instruments In The Gamma-Ray Observatory

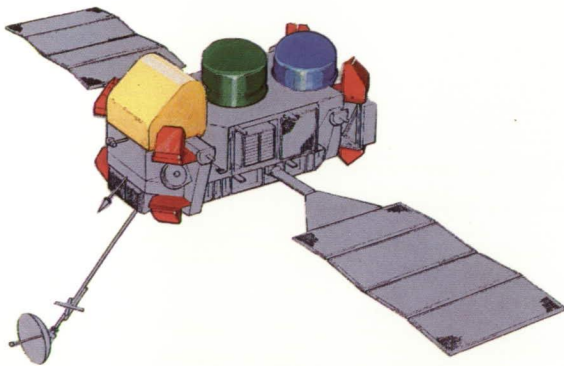

GRO instruments

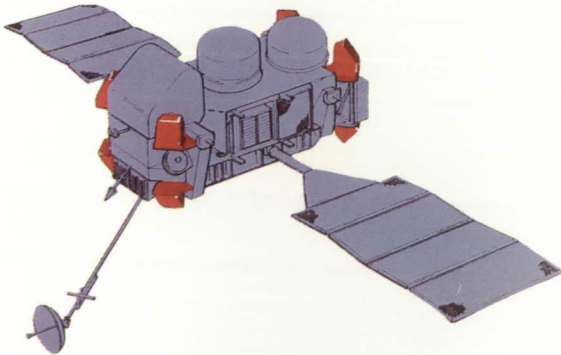

*Burst and Transient Source
Experiment (BATSE)*

Burst And Transient Source Experiment (BATSE)

The primary objective of BATSE is to investigate the intriguing phenomenon of gamma-ray bursts. Although extremely energetic, bursts are hard to study because they are brief events whose occurrence and location in the sky appear at random. The origin of gamma-ray bursts is uncertain, and scientists do not know with certainty what processes produce them.

Since bursts occur randomly in time and direction, BATSE is designed to monitor as much of the sky as possible. To accomplish this, eight identical detectors are located around the perimeter of the spacecraft. With four detectors mounted on the top of the observatory and four on the bottom, BATSE will observe the portion of sky not blocked by Earth (approximately two-thirds).

Since the other instruments have limited fields of view, BATSE serves as GRO's wide-field monitor, detecting and locating strong transient sources and outbursts of known sources from all regions of the sky. When BATSE detects a high flux of gamma rays, a signal is sent to the other GRO instruments. Some or all of the observatory instruments can then observe the burst simultaneously across a wide energy range, and spectra in various energy ranges can be compared.

Bursts emit more gamma rays at low energies than at high energies. Therefore, BATSE is optimized to detect gamma-ray photons from 20 keV to 600 keV, but the detectors are sensitive to gamma rays up to 100 MeV.

*Preparation of BATSE detector
module for flight*

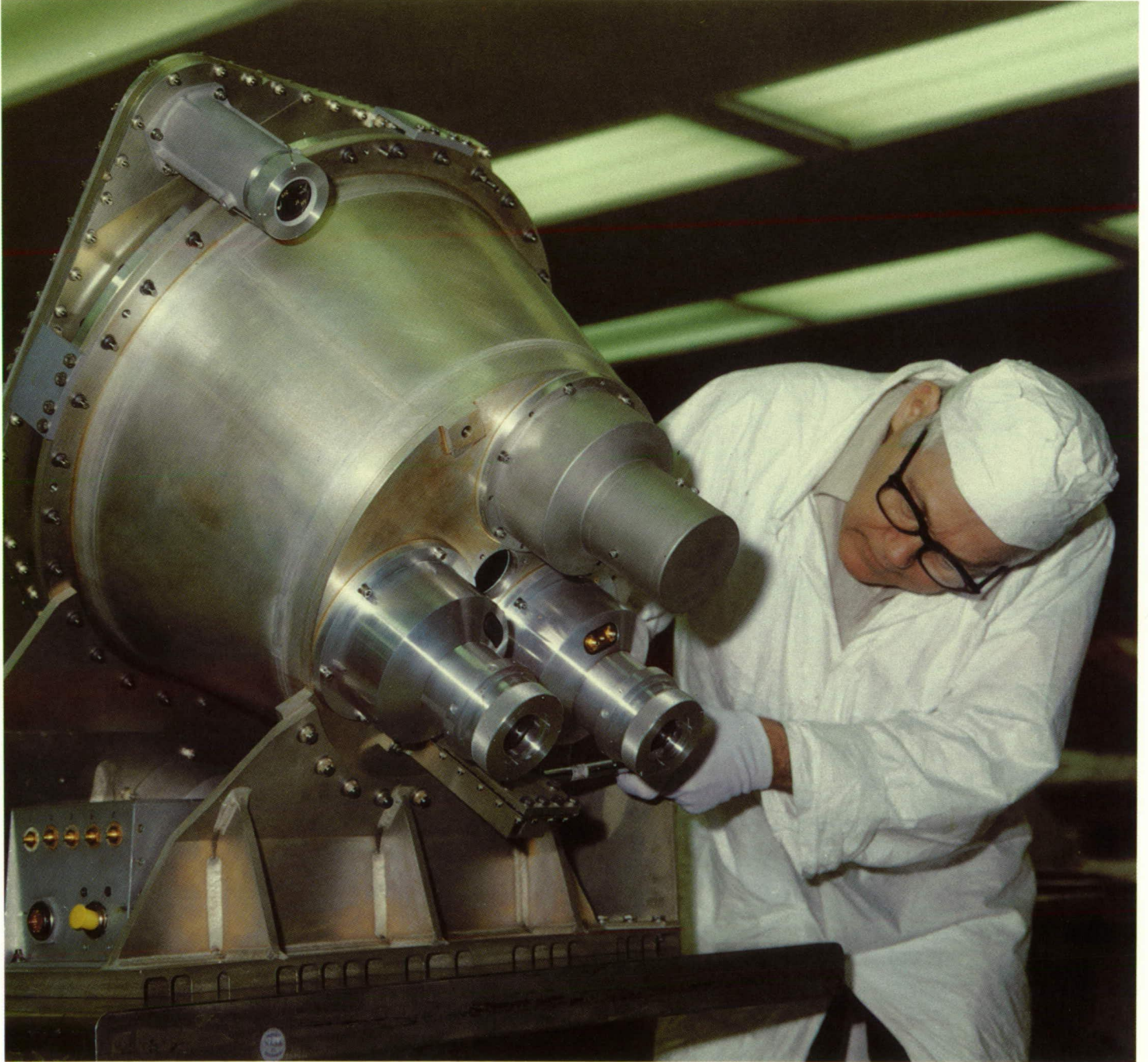



**BATSE DETECTOR MODULE
(1 OF 8)**

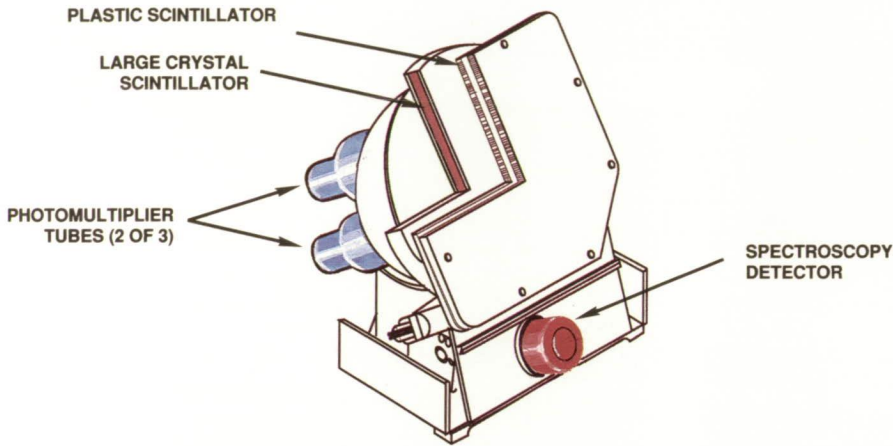

BATSE detector module

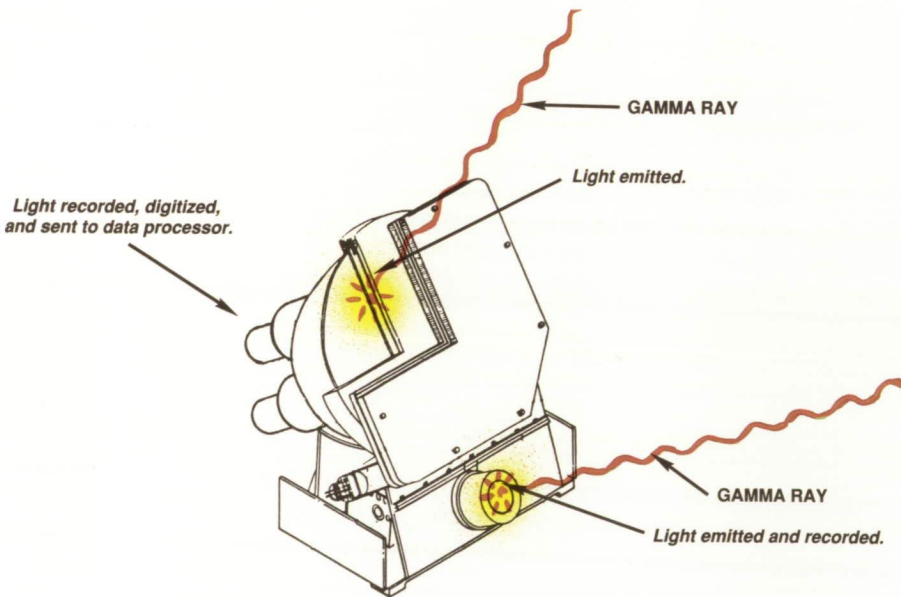

BATSE gamma-ray detection

To record the high flux of photons entering the detectors in a matter of seconds, BATSE has a special data system with a large memory that stores massive amounts of data in short intervals. The instrument measures time variations in events to a fraction of a millisecond, permitting studies of fast changes within a burst. This also will enable scientists to see periodic emissions from sources such as those which might be associated with the rotation of neutron stars.

The main BATSE detector in each of the eight modules is a disk of sodium iodide, 50.8 centimeters (20 in.) in diameter and 1.27 centimeters (0.5 in.) thick. The crystals are similar in design and size to those used in gamma-ray imaging cameras for medical purposes. Because the crystals are larger in diameter than any ever flown, the instrument is 20 times more sensitive than previous gamma-ray burst detectors. Individual bursts will be studied with unprecedented sensitivity to determine their temporal structure and spectral evolution. The improved sensitivity will allow BATSE to observe weak bursts approximately 10 times fainter than any seen before.

A light collector covers the back of each crystal and efficiently channels scintillation light into three 12.7-centimeter (5-in.) photomultiplier tubes. As the gamma ray is absorbed by the crystal scintillator, it produces light that is recorded by the photomultiplier tubes as electronic signals. These signals are processed in the detector electronics unit and then routed to the central electronics unit, which processes and stores large

amounts of data and subsequently transmits the data.

To reduce background radiation, the front of each module is covered with a plastic scintillator shield that rejects charged particles. A lead shield covers the back of the detector to keep scattered radiation from entering.

Each BATSE module also has a smaller secondary spectroscopy detector. Although not as sensitive as the primary detectors, these modules cover a greater energy range (from 20 keV to 100 MeV) and measure each photon's energy more precisely. The spectroscopy detectors consist of sodium iodide scintillation crystals 12.7 centimeters (5 in.) in diameter and 7.62 centimeters (3 in.) thick. Their enhanced energy resolution results from their smaller size, which permits the crystal to be attached directly to a single photomultiplier tube.

An important BATSE objective is to locate the sources of gamma-ray bursts. Every burst will be detected by at least four BATSE detectors, which will help scientists pinpoint the burst location to an accuracy between 1 and 10 degrees, depending on the strength of the burst. This is considerably more accurate than previous individual burst experiments. For the strongest bursts, BATSE data can be correlated with measurements from burst instruments on other spacecraft to yield extremely precise locations (approximately 1 arc minute).

For individual bursts, BATSE locations can be used to search archival photographic plates of the same region for evidence of past optical flashes that appear to be associated with some gamma-ray bursts. In cases where a

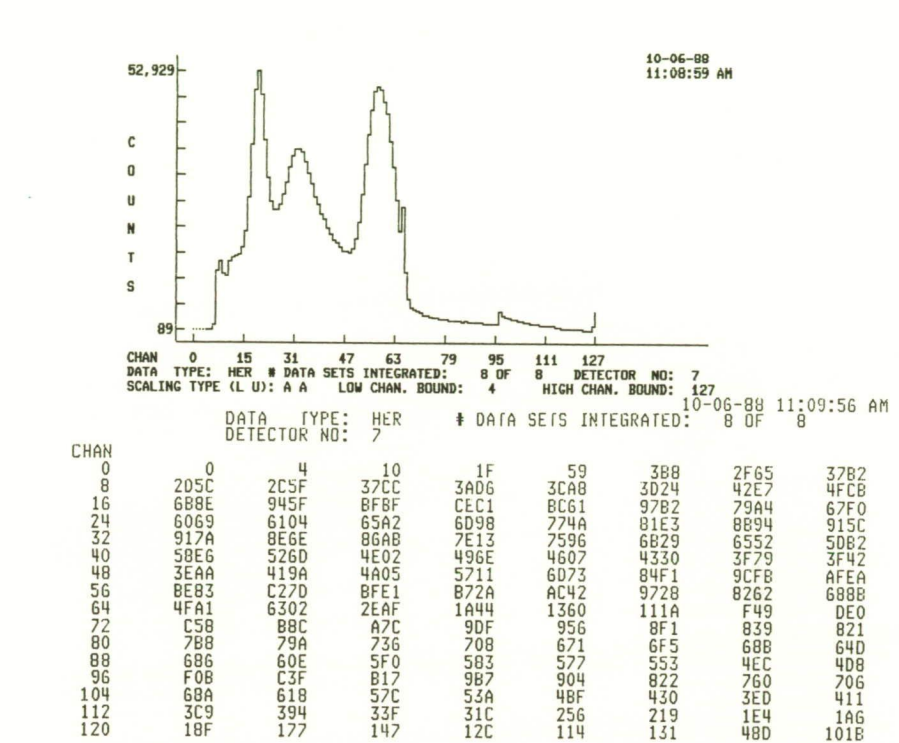

A calibration spectrum from one of the BATSE detectors. The radioactive isotope mercury 203 was used to produce this test spectrum. During a gamma-ray burst, hundreds of spectra will be obtained rapidly from the BATSE detectors in an attempt to better understand the nature of these enigmatic objects.

past optical flash is detected, a precise location for the underlying burst source will be determined. As a result of its ability to process burst locations with unprecedented accuracy and quickness, BATSE will allow, for the first time, coordinated observations of individual gamma-ray bursts in other wavelength bands (optical, radio, and infrared) soon after the burst.

BATSE is expected to record approximately 100 to 400 bursts each year. The

more bursts it detects, the better astrophysicists will be able to catalogue the distribution of burst sources and determine if bursts originate within our galaxy as indicated by earlier observations or in external galaxies as suggested in some models. The BATSE data will result in a celestial map that shows the distribution of sources, permitting a correlation with known classes of optical objects.



Oriented Scintillation Spectrometer Experiment (OSSE)

The OSSE instrument is designed to measure the spectra and time variability of gamma rays from sources as near as the sun to active galaxies a billion or more light years distant. OSSE is particularly sensitive to the spectral signatures of radioactive elements. This enables OSSE to study those explosive objects such as supernovae and novae which are believed to be the sites where heavy elements are created. Radioactive decay of some of these elements will provide the signature by which to study these processes. For example, OSSE will map the concentrations of a radioactive isotope of aluminum in our galaxy to see whether it originates in supernovae or other sources.

OSSE is optimized to detect celestial gamma rays from 100 keV to 10 MeV, the energy region where many radioactive elements have emission lines. To identify the elements producing these

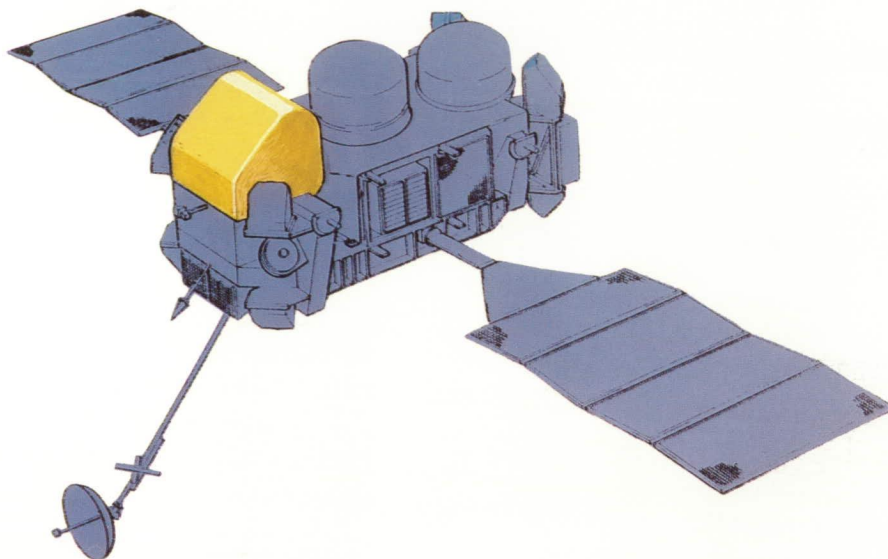

Oriented Scintillation Spectrometer Experiment (OSSE)

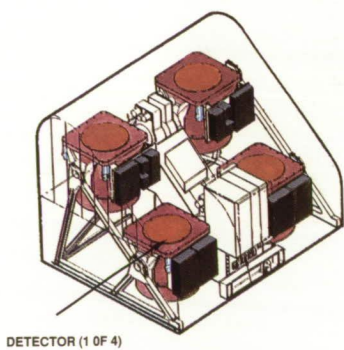

DETECTOR (1 OF 4)

OSSE instrument

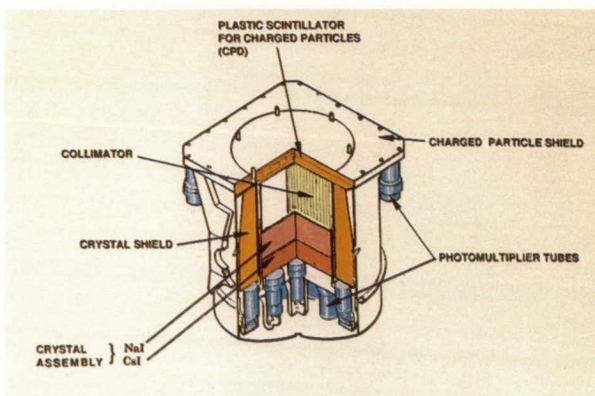

OSSE detector module (1 of 4)

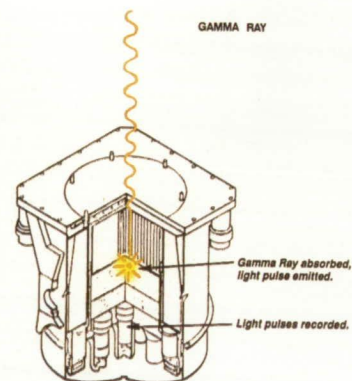

OSSE gamma-ray detection

OSSE
installation

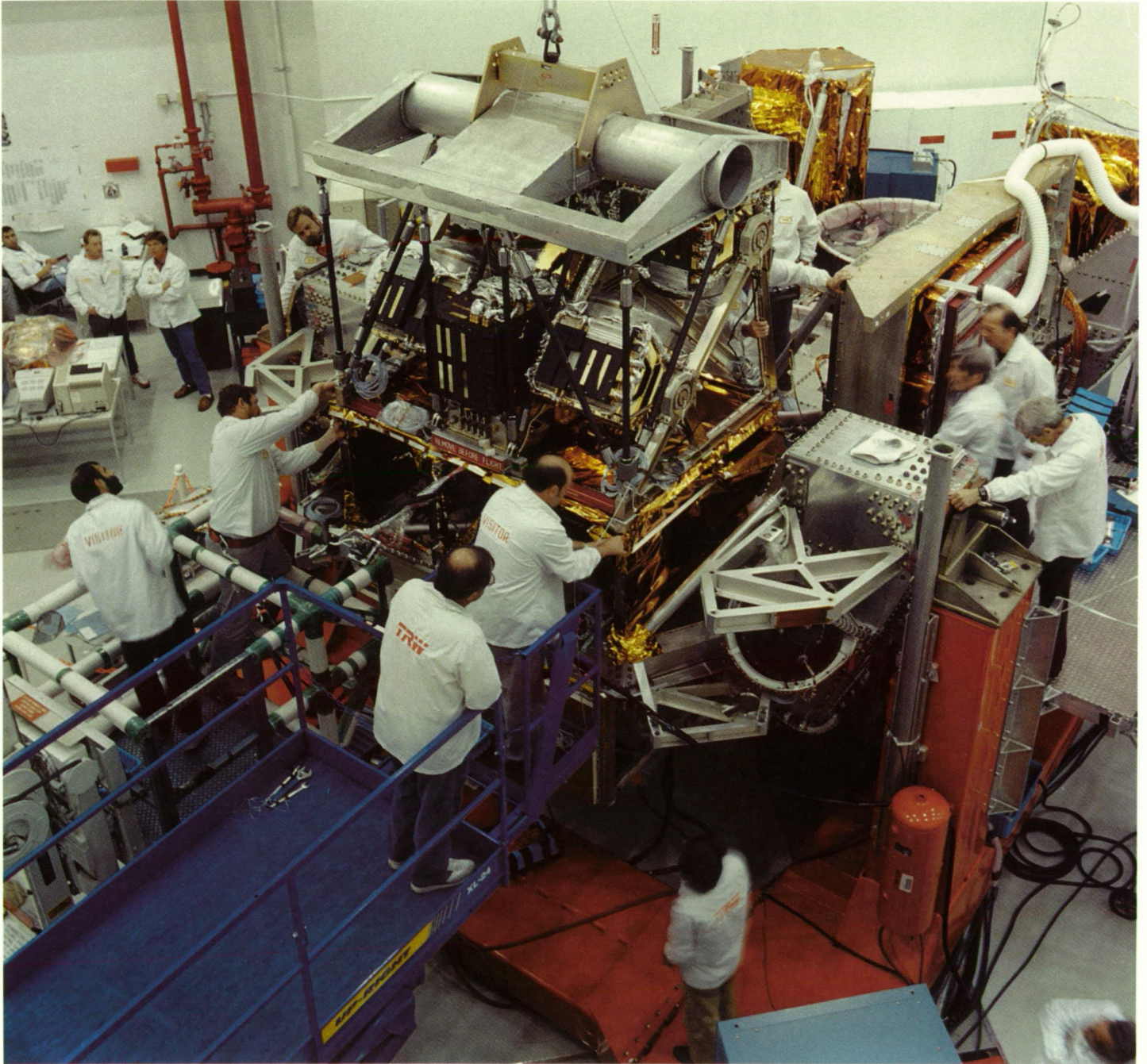

gamma rays, OSSE uses a set of four detectors to measure the energy of each gamma-ray photon very accurately. These measurements are plotted to reveal emissions at specific energies — spectral lines that are the signatures of radioactive elements. The broad emission between spectral lines, or continuum, reveals the physical conditions (such as temperature, particle velocities, and magnetic field strength) in the source region.

Each of OSSE's four identical detectors has a single-axis pointing system, which is used for offset pointing from the source under study to obtain background measurements. This capability also can be used to view sources in different parts of the sky when the source located near

the viewing axis of the spacecraft is occulted by the Earth. Since the detectors can move without being pointed by the observatory, it is possible for OSSE to examine sudden solar events or transient sources without disrupting the observing program of other GRO instruments.

OSSE is surrounded by other detectors that reject events associated with locally produced background photons and cosmic rays. A cesium iodide crystal coupled directly to the main sodium iodide crystal absorbs gamma rays entering the back of the detector; a sodium iodide annular shield provides shielding to background radiation from the sides; and a plastic scintillator rejects events produced by cosmic ray

interactions. To allow only those gamma rays in a detector's forward field of view to be detected, a tungsten collimator defines the 3.8 by 11.4 degrees aperture.

Seven photomultiplier tubes coupled to the main crystal assembly record the scintillation light produced as a gamma ray is absorbed by the sodium iodide crystal. The light pulses are processed into digital signals by the instrument's data acquisition and control system. Normally, individual source spectra are accumulated every 4 seconds.

OSSE may be operated in several different modes, depending on the type of source under study. To study rapidly rotating pulsars, spectral accumulation times are increased in order to provide high time resolution, 0.125 milliseconds. A second mode useful for observations of gamma-ray bursts allows the data from all four detectors to be sampled and recorded every 2 milliseconds.

OSSE can determine the direction of an isolated source to a fraction of a degree when operated in a source positioning mode. In this mode, the instrument pointing capability is used to position the source at several places in the field of view and use the known angular response of the collimator to determine the best fit location of the source on the sky.

The size and number of the crystals and their design to minimize instrument background allow OSSE to achieve a significant improvement compared to gamma-ray instruments previously flown. OSSE will detect gamma-ray line emissions and the continuum spectrum with a sensitivity 10 to 20 times better than previous instruments.

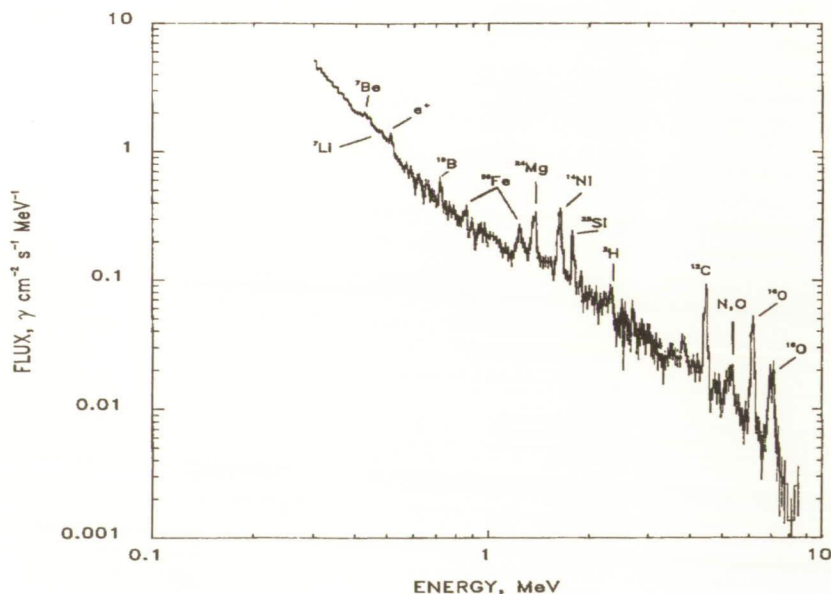

OSSE line spectrum

Imaging Compton Telescope (COMPTEL)

The Imaging Compton Telescope (COMPTEL) is somewhat similar to an optical camera: an initial detector, which is the analog of the camera's lens, directs gamma rays to a second detector, analogous to the film, in which the scattered photon is absorbed. Although the photons are not focused, as in the case of the camera, COMPTEL is capable of reconstructing sky images over a wide field of view.

COMPTEL detects gamma rays with energies from 1 to 30 MeV, which have been difficult to measure with previous detector technology. This instrument's size and unique detection technique make it 20 times more sensitive than prior gamma-ray detectors in this energy range. COMPTEL studies gamma rays

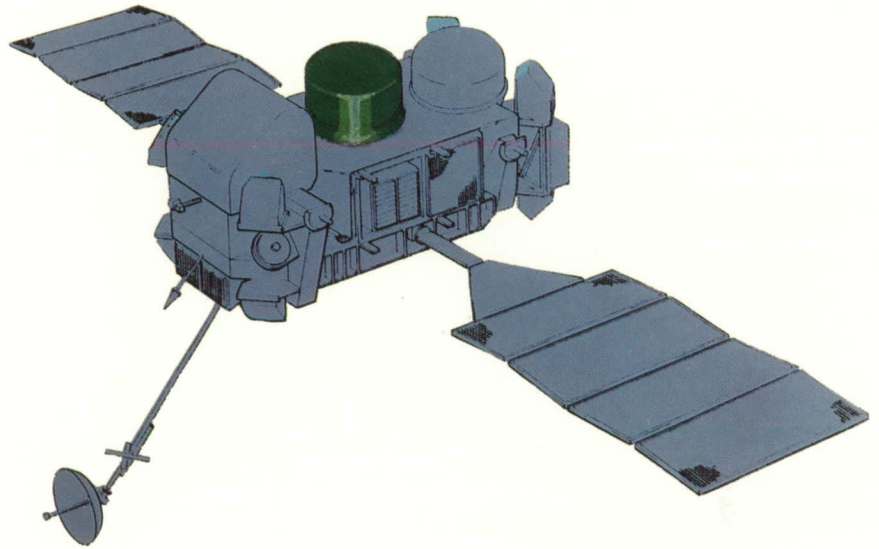

Imaging Compton Telescope (COMPTEL)

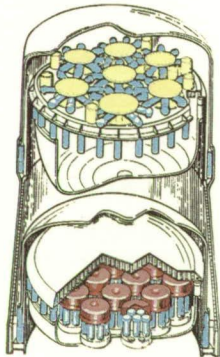

COMPTEL instrument

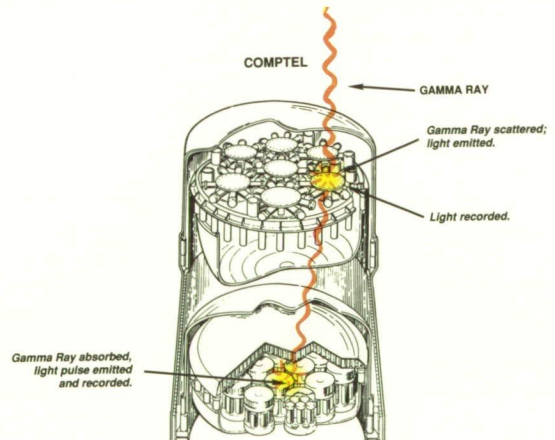

COMPTEL gamma-ray detection

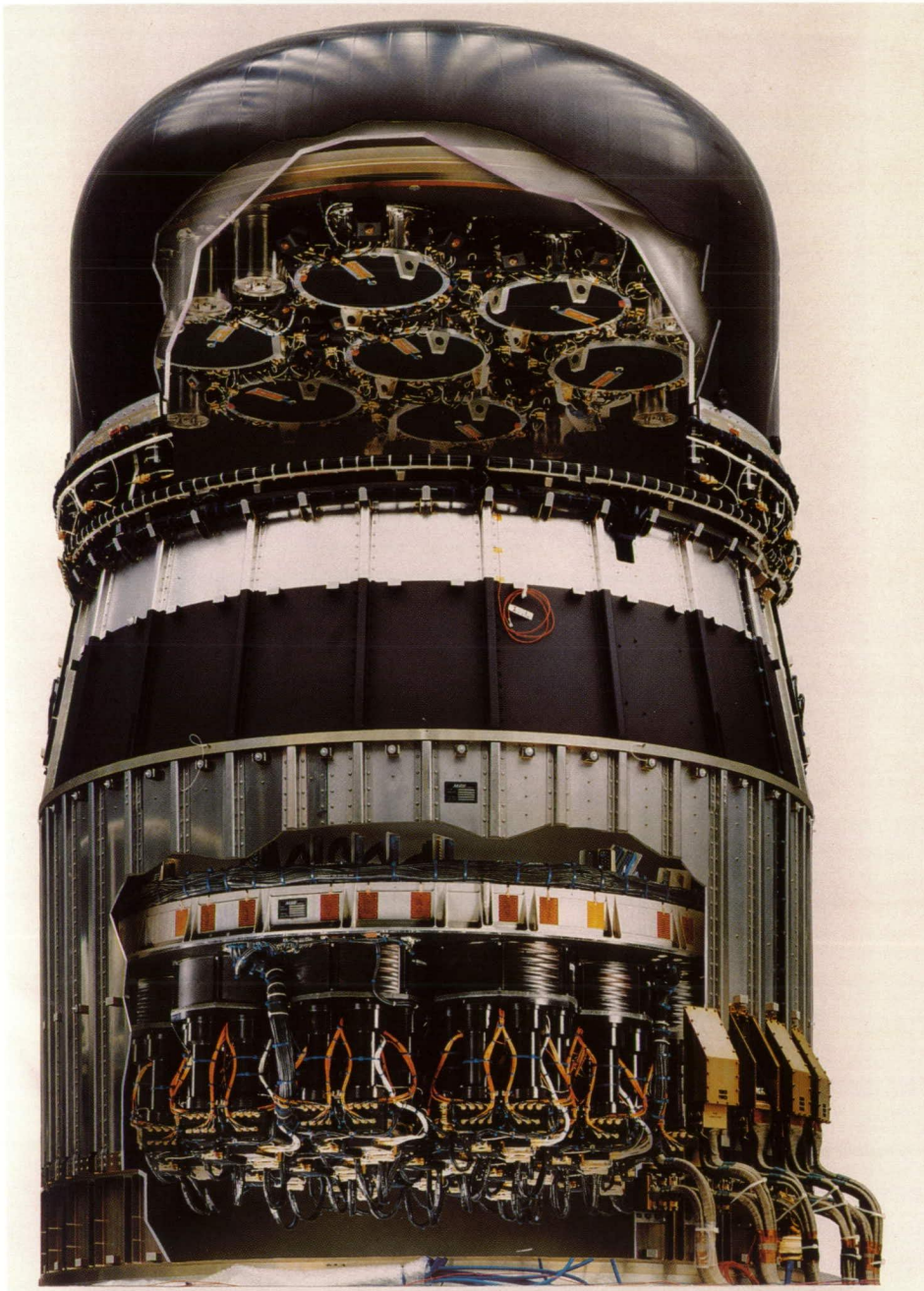

COMPTEL

from point sources such as neutron stars and galaxies and diffuse emission originating in our galaxy and beyond. The structures of our galaxy will be revealed as COMPTEL images gamma rays created when cosmic rays interact with interstellar matter. COMPTEL also records spectra that complement and extend the OSSE spectral data to higher energy.

COMPTEL's detection technique is novel, with detectors stacked on top of each other for two-step absorption. The upper detector array is made of seven aluminum modules filled with liquid scintillator. Each detector module is viewed by eight photomultiplier tubes that record scintillations. The lower detector array consists of 14 cylindrical crystals of sodium iodide mounted on a baseplate with a diameter of 1.5 meters (5 feet).

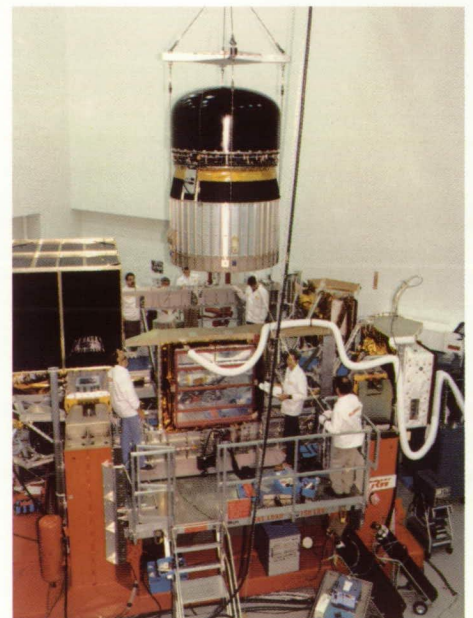

COMPTEL installation

Each crystal detector is viewed by seven photomultiplier tubes. To be recorded, a photon must interact with both the upper and lower detectors. Plastic scintillators on the outside of the instrument and between the detectors identify cosmic rays so that they do not mimic gamma rays in the main detectors.

COMPTEL's operation is based on the process known as Compton scattering, in which a photon interacts with an electron. As a result of this interaction, a photon of lower energy emerges at a different angle from the initial photon, the energy "lost" by the photon being carried off by the recoiling electron. As a gamma-ray photon encounters electrons in the atoms of an upper liquid detector, it undergoes Compton scattering, resulting in a scintillation that is recorded by photomultipliers. The scattered photon travels through the instrument and is absorbed in the lower crystal detector where its scintillation is recorded by more photomultipliers. By measuring the energy lost by the gamma ray in the upper detector and the energy of the absorbed photon in the lower detector, the energy of the incident gamma ray may be determined.

The photomultipliers also record the places where the gamma rays strike the liquid and crystal detectors. By measuring the location of the photon interactions in the upper and lower detectors, a ring in the sky where the gamma ray originated can be determined. After numerous photons have been recorded and sorted, the direction of the source can be determined by comparing where the paths of the rings intersect. For the highest energy gamma rays, the direction

of arrival can be determined within less than a degree. The energy resolution of the two detectors, the well-defined physics of the Compton interaction, and the instrument's wide field of view permit reconstruction of the gamma-ray emission from a large area of the sky with a resolution of a few degrees.

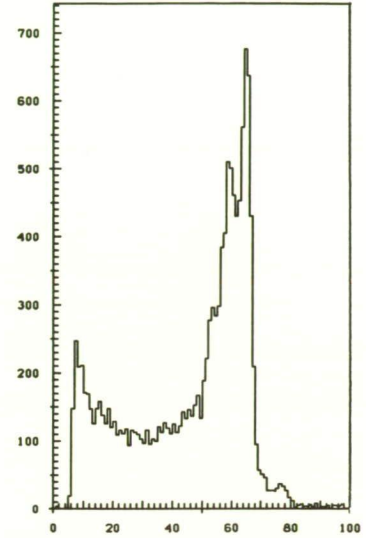

COMPTEL line spectrum

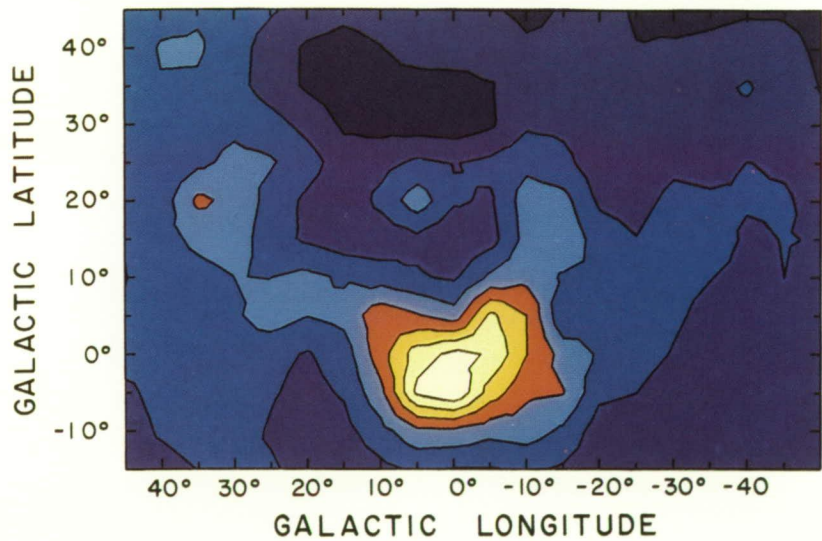

COMPTEL image (balloon flight)

Energetic Gamma Ray Experiment Telescope (EGRET)

The EGRET instrument is sensitive to the highest energy gamma rays, detecting photons with energies from approximately 20 MeV to 30 GeV. These high-energy gamma rays are generally associated with the most energetic processes occurring in nature.

EGRET is between 10 and 20 times larger and more sensitive than any high-energy gamma-ray telescope previously flown in space. By virtue of its size, EGRET will be able to observe sources much fainter than those already detected. It also will be able to measure the energy spectrum of the high-energy diffuse gamma-ray emission with greatly improved accuracy and determine spectra of many discrete sources. One of its primary goals is to examine quasars over a wide energy range so that

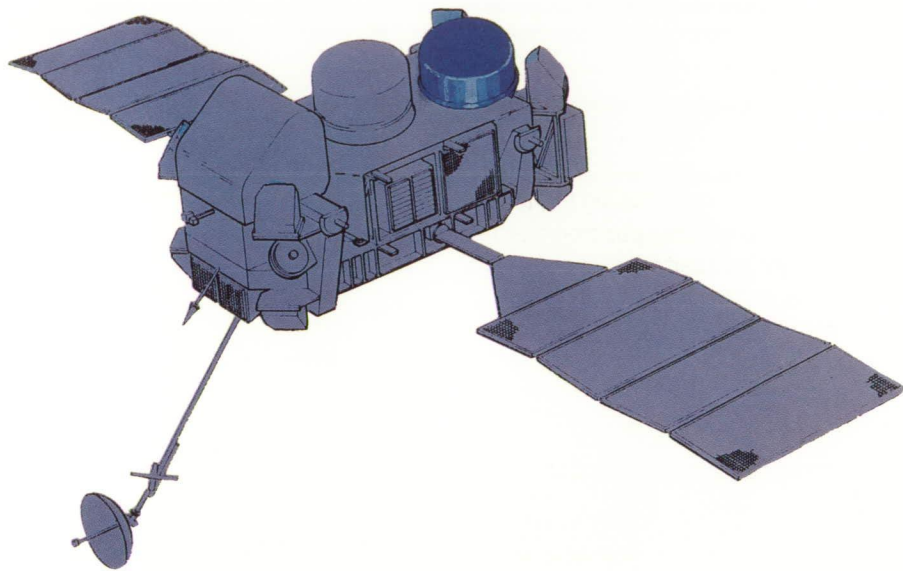

Energetic Gamma Ray Experiment Telescope (EGRET)

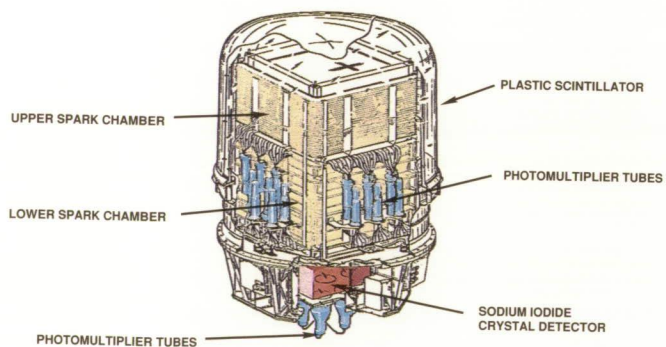

EGRET instrument

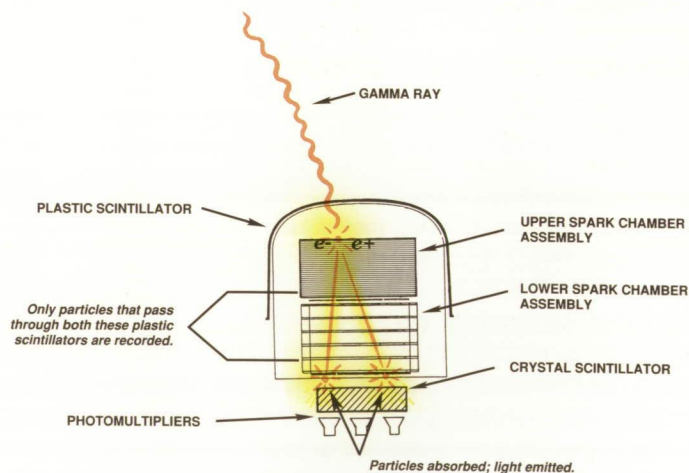

EGRET gamma-ray detection

their energy production can be determined more precisely. It will survey the universe for other high-energy sources: gamma rays escaping from matter near black holes, stellar and galactic explosions, matter and antimatter annihilation, and perhaps new classes of objects that may have escaped notice because they were too faint to be seen by previous instruments.

EGRET shares its detection techniques with high-energy particle physics, where gamma rays from subatomic particle collisions are detected. To study cosmic high-energy gamma rays, EGRET uses 36 digitized spark chambers, a 32-element coincidence system, and a 408-kilogram (900-pound) sodium iodide crystal, enclosed in a large anticoincidence scintillator dome. The upper 28 spark chambers are interleaved with thin tantalum sheets.

When a high-energy gamma ray entering the top of the telescope interacts in one of the tantalum sheets, it produces a pair of particles - an electron and its antiparticle, the positron. The electron-positron pair travels downward at nearly the speed of light. If at least one particle of each pair passes through the coincidence telescope and no external charged particle has been recorded in the anticoincidence system, the spark chambers are activated and the path of the pair is recorded. At the same time, the energy deposited by the pair in the large sodium iodide crystal at the bottom is measured.

As the charged particle intensity in space is several thousand times that of the gamma rays from cosmic sources, it would overwhelm the instrument were it

not for the anticoincidence shield, which detects the presence of charged particles and signals that they are not valid gamma-ray events. Upward moving charged particles are vetoed by the coincidence system, which can discriminate between upward and downward moving particles and photons.

The direction of the incoming gamma ray is determined by examining the initial directions of the electron-positron pairs, and its energy is ascertained from the measurement in the sodium iodide crystal and the characteristics of the pair tracks in the spark chamber assembly. The time of arrival of each gamma ray is measured to better than one ten-thousandth of a second, permitting, for example, the detailed study of pulsars. Positions of strong high-energy sources can be located to an accuracy of approximately 10 arc minutes (0.17 degrees) or better. EGRET is also able to observe the high-energy portion of gamma-ray bursts and solar flares.

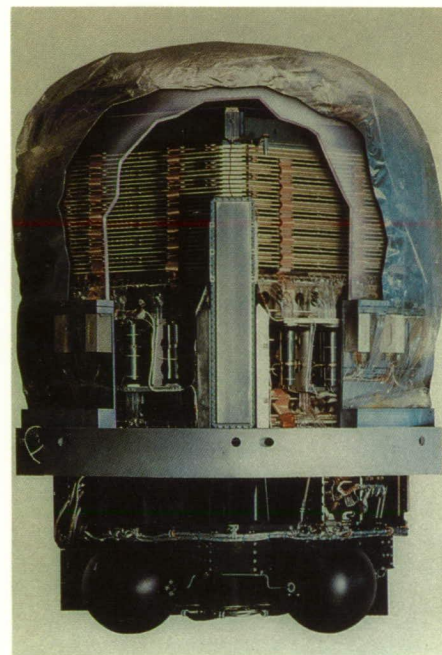

EGRET

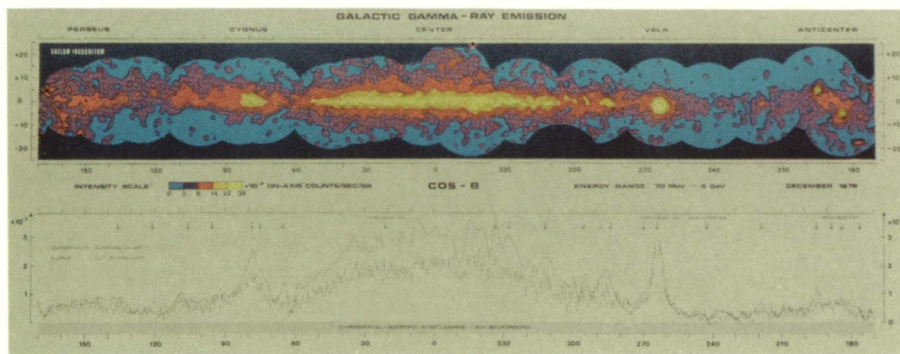

Gamma-ray map of the galactic plane



Arthur Holly Compton (1892-1962)

Astrophysicists exploring the universe with instruments carried aboard the Gamma-Ray Observatory are indebted to Arthur Holly Compton, the American physicist whose work on the interaction of high-energy radiation and matter played a key role in the development of modern physics. All experiments on the observatory rely heavily on the detailed knowledge of the interactions of gamma rays with matter that Compton first described.

The Compton effect refers to the interaction of high-energy photons that are scattered by electrons. Compton and others observed that gamma rays and X-rays scattered by matter were more easily absorbed than expected, meaning that they must have lost energy.

Compton further observed that the larger the scattering angle, the larger the indicated loss of energy. These findings showed that, in addition to its wavelength nature, radiation had the characteristics of a particle, possessing both energy and momentum — a duality of nature that contradicted existing physical theories that defined radiation as having only wave-like properties.

Compton proposed a theory that when a high-energy photon (an X-ray or gamma ray) is scattered, it transfers some of its momentum and energy to an electron. Furthermore, this theory also stated that the increase in the electron's momentum

and energy is equal to the difference in momentum and energy between the primary and scattered photons, thus resolving an apparent violation of the law that matter and energy are never destroyed or created.

When quantum physicists later showed that radiation and matter may exhibit both wave-like and particle-like properties, the Compton effect was recognized as an experimental proof of the new physics. In 1927, Compton received the Nobel Prize in Physics for his discovery.

Compton was also one of the pioneering high-energy astrophysicists. In the 1930s, his comprehensive studies of cosmic rays showed conclusively that cosmic rays were composed mostly of charged particles rather than very high-energy photons, as many others then believed.

GRO

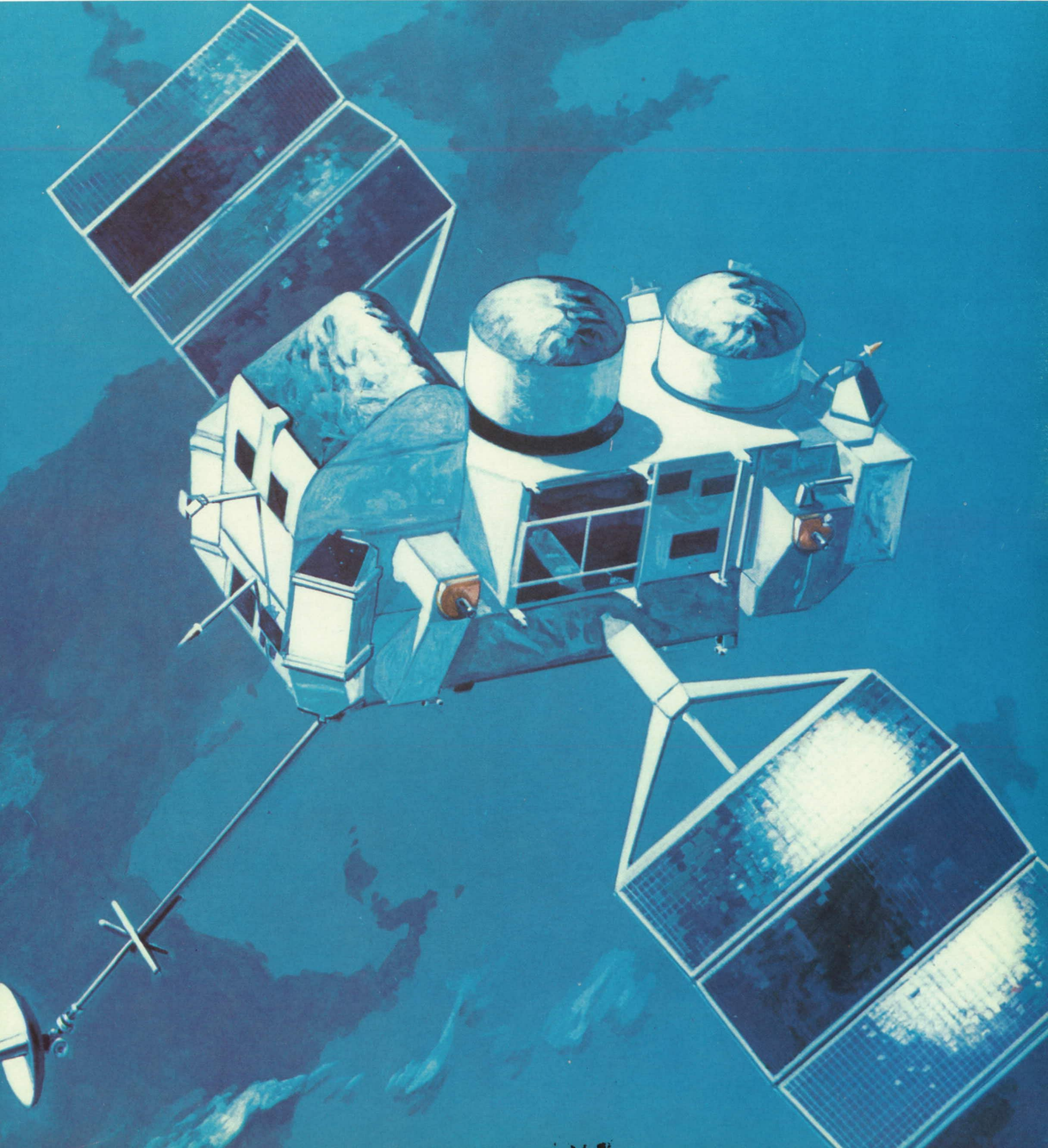



GRO Mission Team

NASA Project Management: Goddard Space Flight Center

Mission Contractor: TRW

Contractors:

Communication and Data Handling:	Fairchild and IBM
Power Modules:	McDonnell Douglas
Star Trackers and OSSE Instrument:	Ball Aerospace
COMPTEL Instrument:	Messerschmitt - Boelkow - Blohm (MBB)

BATSE

NASA Marshall Space Flight Center
University of Alabama, Huntsville
University of California, San Diego
NASA Goddard Space Flight Center

OSSE

Naval Research Laboratory
Northwestern University
Clemson University
Royal Aircraft Establishment (Great Britain)

COMPTEL

Max Planck Institute (Federal Republic of Germany)
European Space and Technology Center (ESTEC)
Space Research Laboratory Leiden (The Netherlands)
University of New Hampshire

EGRET

NASA Goddard Space Flight Center
Max Planck Institute (Federal Republic of Germany)
Stanford University
Grumman Aerospace

Program Manager:	Douglas R. Broome NASA Headquarters
Deputy Program Manager:	Nickolus O. Rasch NASA Headquarters
Program Scientist:	Alan N. Bunner NASA Headquarters
Assistant Program Scientist:	Gerald H. Share Naval Research Laboratory

Project Manager:	John A. Hrastar NASA Goddard Space Flight Center
Deputy Project Manager:	Thomas A. LaVigna NASA Goddard Space Flight Center
Project Scientist:	Donald A. Kniffen NASA Goddard Space Flight Center
Assistant Project Scientist:	David L. Bertsch NASA Goddard Space Flight Center

Credits

Illustrations provided by NASA, with the following exceptions:

- Hale Observatories: title page and page 20
- TRW: pages 2, 10, 29, 32, 37, 38, and 40-1
- COMPTEL team: pages 9, 32, and 33 (both)
- National Optical Astronomy Observatories:
pages 14 and 18
- Lick Observatory: page 15
- Smithsonian Astrophysical Observatory: page 17
- University of Toronto: page 19
- OSSE team: page 30

GRO in the assembly room



NASA



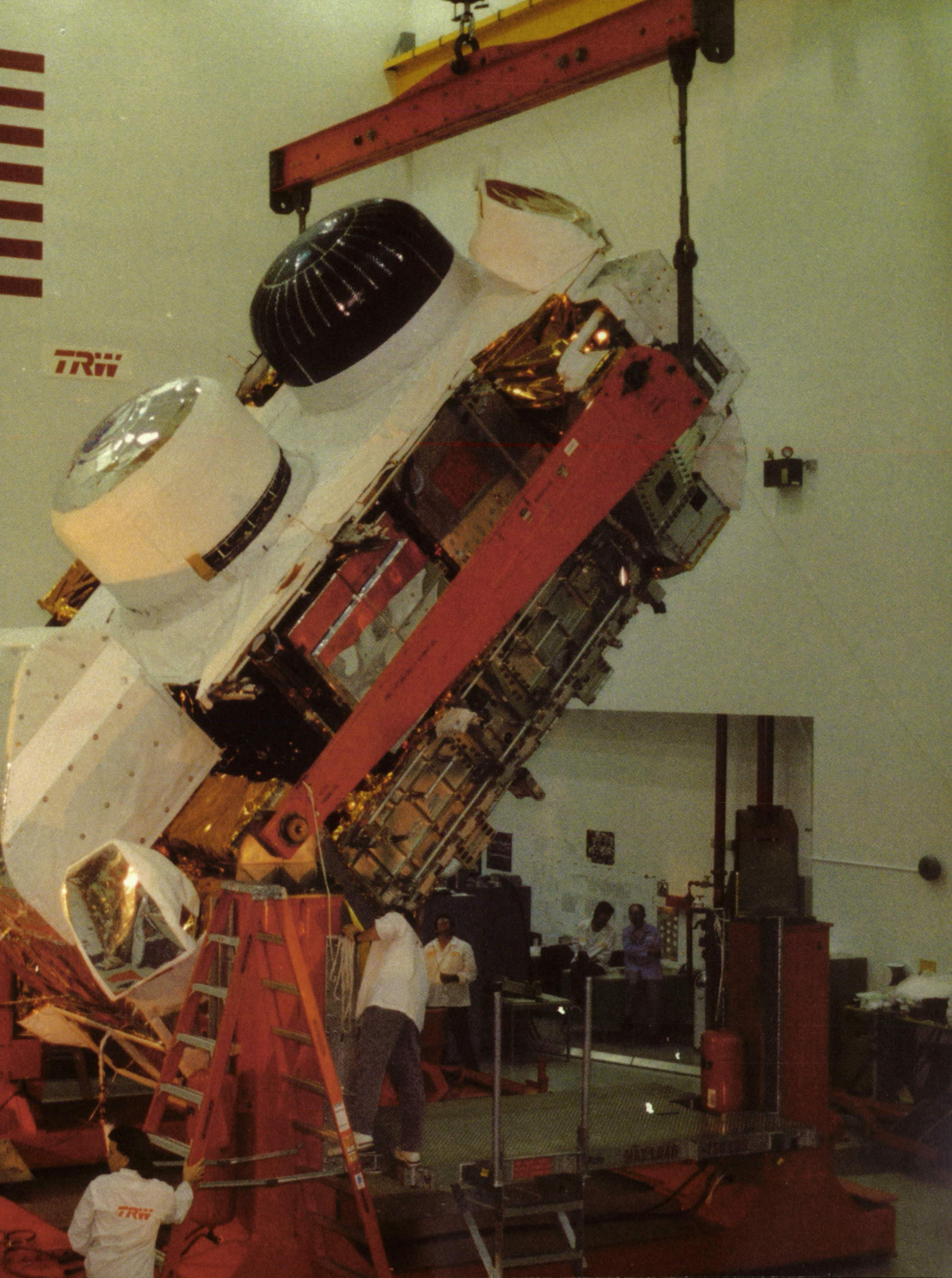

TRW

TRW



NASA

National
Aeronautics and
Space
Administration