

P-53

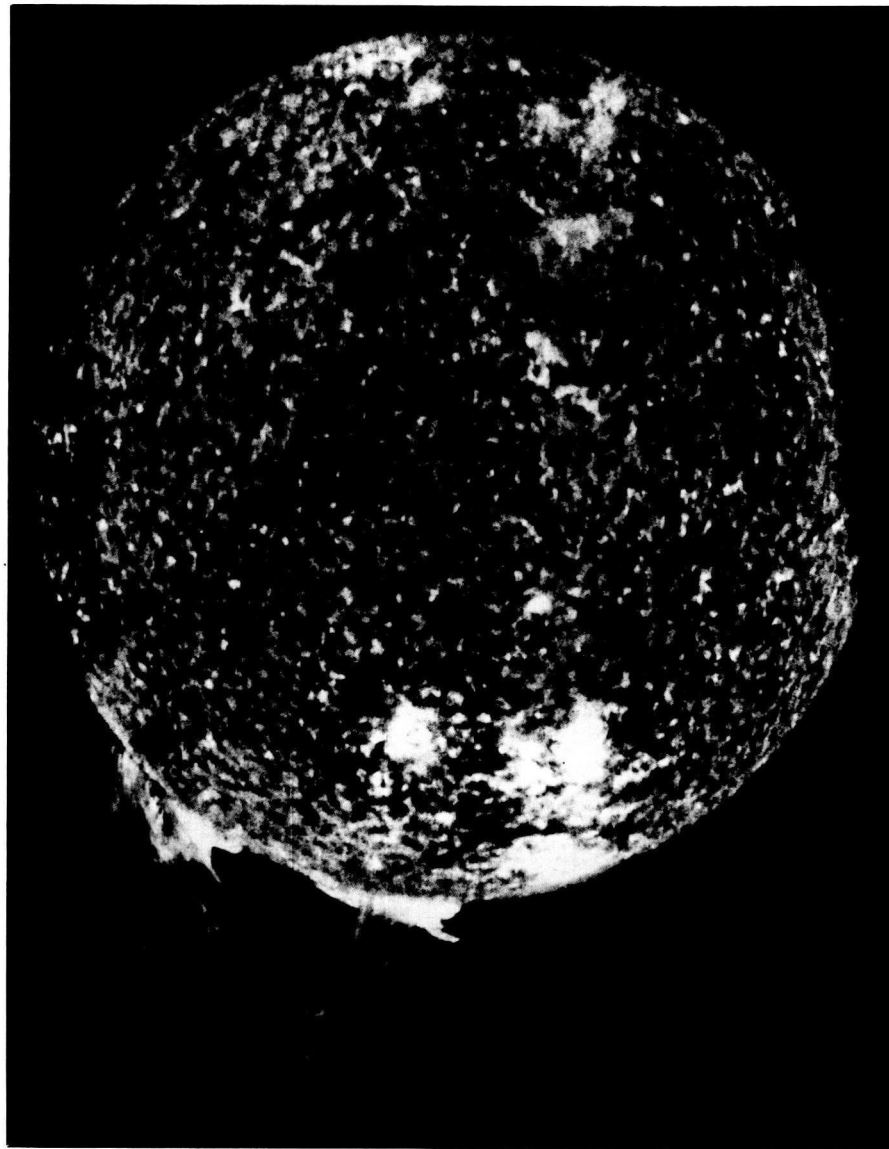

ORIGINAL PAGE  
COLOR PHOTOGRAPH

Solar  
Physics  
In The  
Space  
Age

(NASA-NE-106) SOLAR PHYSICS IN THE SPACE  
AGE (NASA) 53 P  
CSCI 03B

N89-25818

H1/92  
Unclas  
0212077



# A Few Solar Facts and Figures

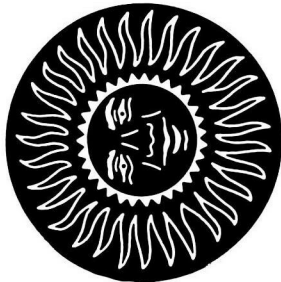

*Diameter* — 1.4 million kilometers (109 Earth diameters)

*Sun-Earth Distance* — 150 million kilometers (107 Sun diameters)

*Volume* — 1.4 billion billion cubic kilometers (1.3 million Earths)

## *Density*

At center — 160 grams per cubic centimeter (160 times density of water)

At surface — one gram per thousand cubic meters

In corona — one gram per ten cubic kilometers

## *Temperature*

At center 15,000,000 K (degrees Kelvin)

At surface 6,000 K

In sunspots 4,200 K

In chromosphere 4,300 K to 50,000 K

In corona 800,000 K to 3,000,000 K

## *Emission*

Total — 383 billion trillion kilowatts

At top of Earth's atmosphere — 1.36 kilowatts per square meter

## *Magnetic Field Strength*

In sunspots Up to 3,000 gauss

Elsewhere on Sun 1 to 100 gauss

Earth, at pole 0.7 gauss

*Age* — 4.5 billion years

*Life Expectancy* — about 5 billion more years

---

# Solar Physics In The Space Age

ORIGINAL PAGE  
COLOR PHOTOGRAPH

## Figure Credits

Page	
2, 16.	Carol Crannell, NASA Goddard Space Flight Center
7.	left middle bottom left left left left right
	W. Edward Roscher (c) 1960, National Geographic Society Carnegie Institution of Washington
9.	bottom
	Gary Emerson, NASA Marshall Space Flight Center
19.	left
	J. Zirker, National Solar Observatory
21.	left
	High Altitude Observatory
23.	left right
	Palomar Observatory Photograph Solar wind data from M. Neugebauer and C.W. Snyder, <i>Journal of Geophysical Research</i> , Vol. 70, No. 7, pp. 1587-1591 (1965), copyright by the American Geophysical Union
31.	
	J.W. Harvey, National Solar Observatory
33.	bottom
	D.M. Rust, The Johns Hopkins University Applied Physics Laboratory
37.	top left bottom
	American Science and Engineering and Harvard College Observatory Naval Research Laboratory
39.	
	American Science and Engineering and Harvard College Observatory
41.	
	T.A. Potemra, "Magnetospheric Currents," <i>Johns Hopkins APL Technical Digest</i> 4(4), 276-284 (1983).
43	
	Naval Research Laboratory and High Altitude Observatory
47.	
	J.W. King, "Sun-Weather Relationships," from the April 1975 <i>Aeronautics and Astronautics</i> ; copyright American Institute of Aeronautics and Astronautics.

## Text Credits

Text	
	Dr. Phil H. Dittmer with support from Dr. Adrienne F. Pedersen and the NASA Solar Physics Management Operations Working Group (Dr. J. David Bohlin, Chief of Solar Physics Branch, Chairman), with major contributions from Drs. David M. Rust, Carol Crannell, and Harjit S. Ahluwalia.

ORIGINAL PAGE  
COLOR PHOTOGRAPH

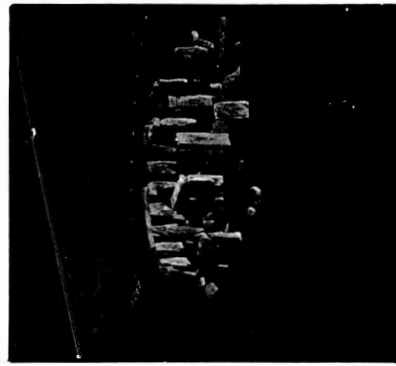
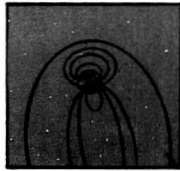
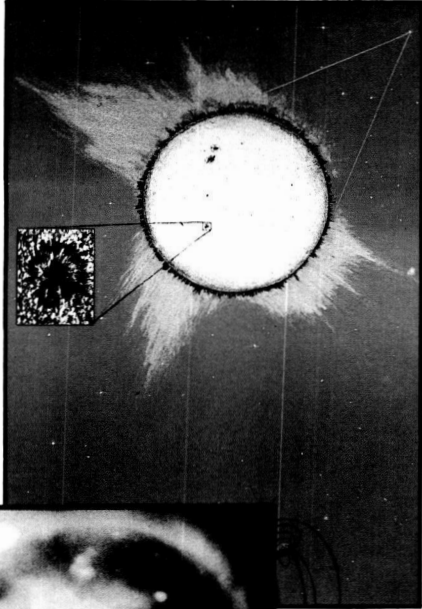
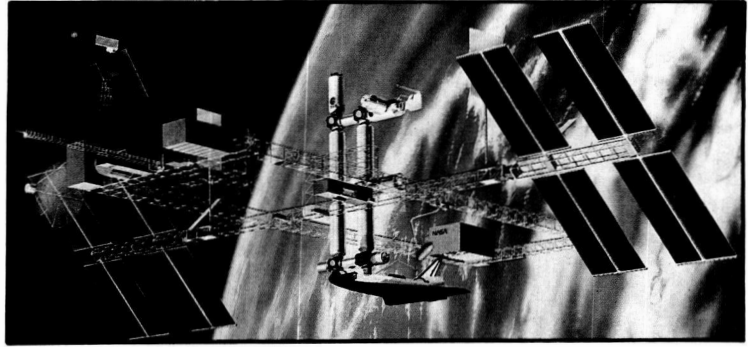

# Introduction

# Solar Study through History

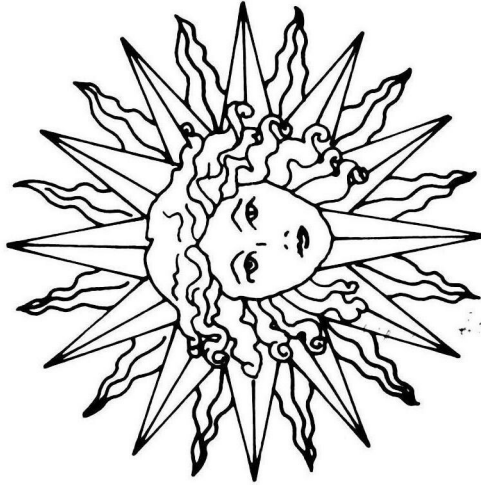

From the Stone Age to the Space Age, we have been keenly interested in the Sun. Even in ancient times, we built observatories like Stonehenge to record the Sun's changing path across the sky. We learned how the Sun governs our days and seasons, but knew little about the Sun itself. Most early observers were content with the opinion of the ancient astronomer Ptolemy that the Sun was a brilliant perfect sphere circling the Earth.

When Galileo turned the telescope heavenward in 1610, he opened a whole new era of solar inquiry. Subsequent observers have developed increasingly sophisticated ground-based instruments, like the great solar observatories on Mount Wilson. These instruments have shown us a Sun which deviates from Ptolemaic perfection by virtue of intricate phenomena and dynamic processes. Each new discovery has spawned new questions. What causes the mysterious dark spots on the Sun? Why does the number of spots increase and decrease in a regular way? What

triggers the violent "flare" explosions associated with these spots? How do these phenomena affect the Earth?

Today, we pursue the answers to these questions from the unique vantage point of space. Powerful space solar observatories have begun to probe all the Sun's complex and dynamic structure unencumbered by the limits our atmosphere imposes on dynamic range and spectral coverage. The solar space program will continue to yield breakthroughs, helping us master our own environment and contributing to other disciplinary particles to the cosmic questions of astrophysics.

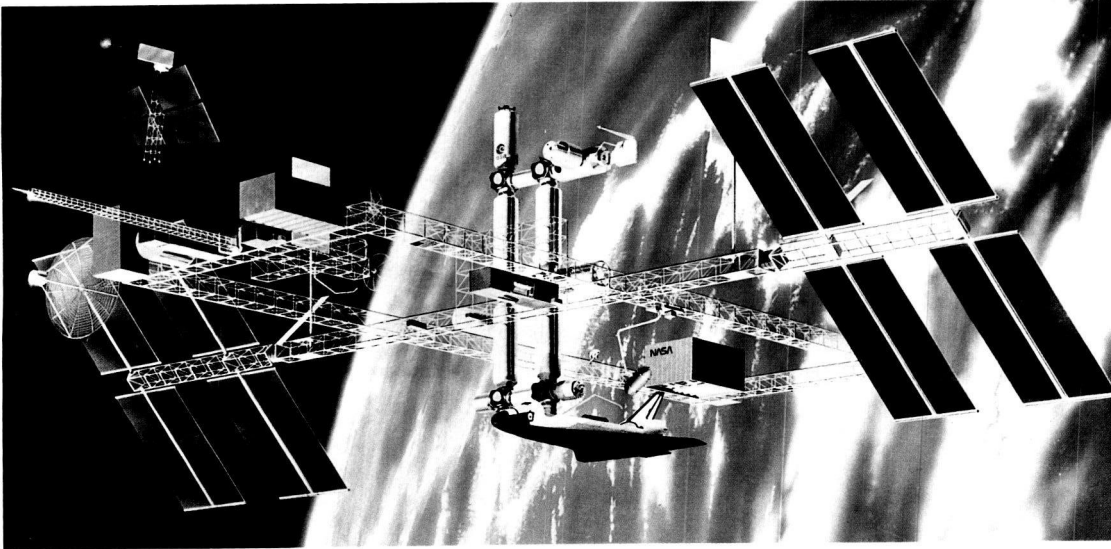

Space-Based Instruments — Space Station

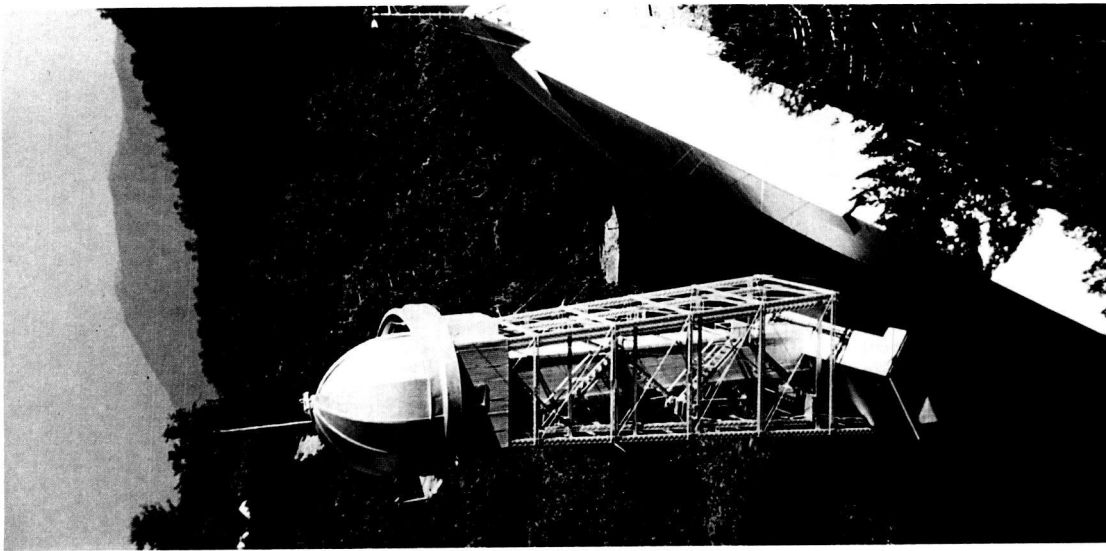

Ground-Based Instruments — Mt. Wilson

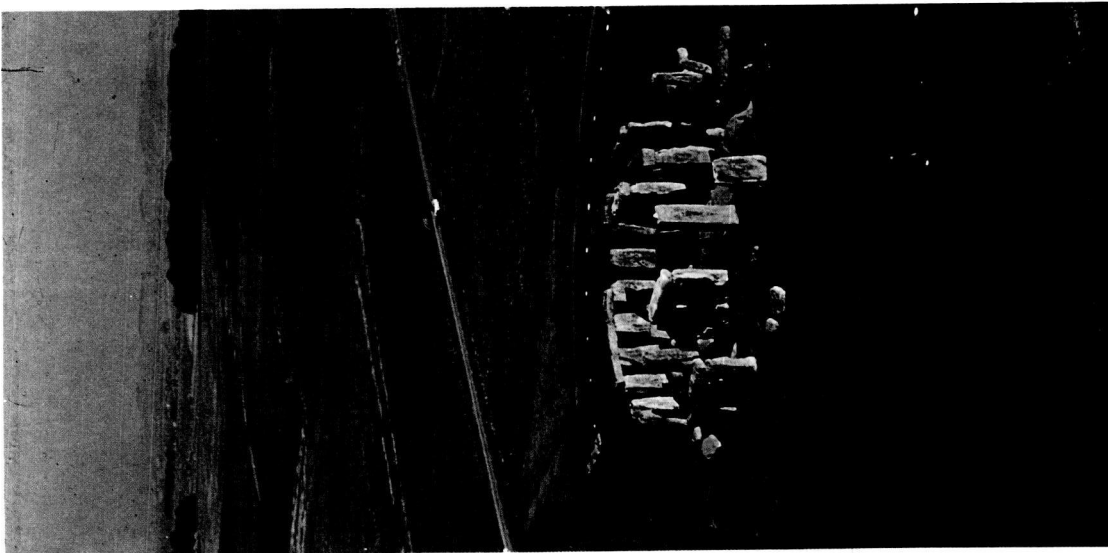

Ancient Observatories — Stonehenge  
**Solar Study through History**

# Why Study the Sun from Space?

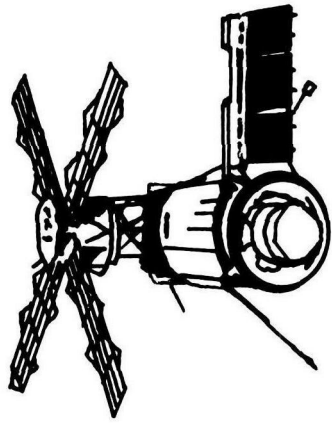

*Sky/lab*

The setting Sun reminds us vividly that we live at the bottom of an ocean of air. The air scatters and absorbs the Sun's light, leaving the Sun distorted and discolored. These effects delight the eye, but they also frustrate the solar scientist. This frustration persists even with the Sun overhead, because air currents blur the smallest solar structures, which otherwise could be seen through telescopes. From space we can surmount these difficulties; a large telescope in space will permit us to study solar features many times smaller than those visible from the surface of the Earth.

Space offers even greater advantages for studying the Sun's invisible radiations. These radiations come from the Sun's outer atmospheres, where temperatures exceed one million degrees under "quiet" conditions and are driven to tens of millions of degrees in the violent explosions called flares. The Earth's atmosphere completely blocks these radiations, protecting life on Earth from their harmful effects. Only instruments in space can receive

these radiations and the information they bring from the Sun. For example, the Sun's ultraviolet light displays an intricate network near the top of the Sun's middle atmosphere, the chromosphere. Solar X-rays brilliantly highlight the magnetic arches and streamers which shape its outer atmosphere, the corona. Still higher energy gamma rays come from the heart of solar flare explosions, and may yet reveal how and why these explosions begin.

With scientific instruments in space, we can go beyond observing the Sun to sampling the Sun's materials directly. Particles and fields from the Sun flow continually outward past the earth. The Earth's magnetic field protects us by turning aside this flow of particles and fields, but not before the flow compresses or inflates the Earth's magnetic domain. Spacecraft traveling outside this protective magnetic cocoon can measure these particles and fields, helping us determine their specific solar origins and terrestrial effects.



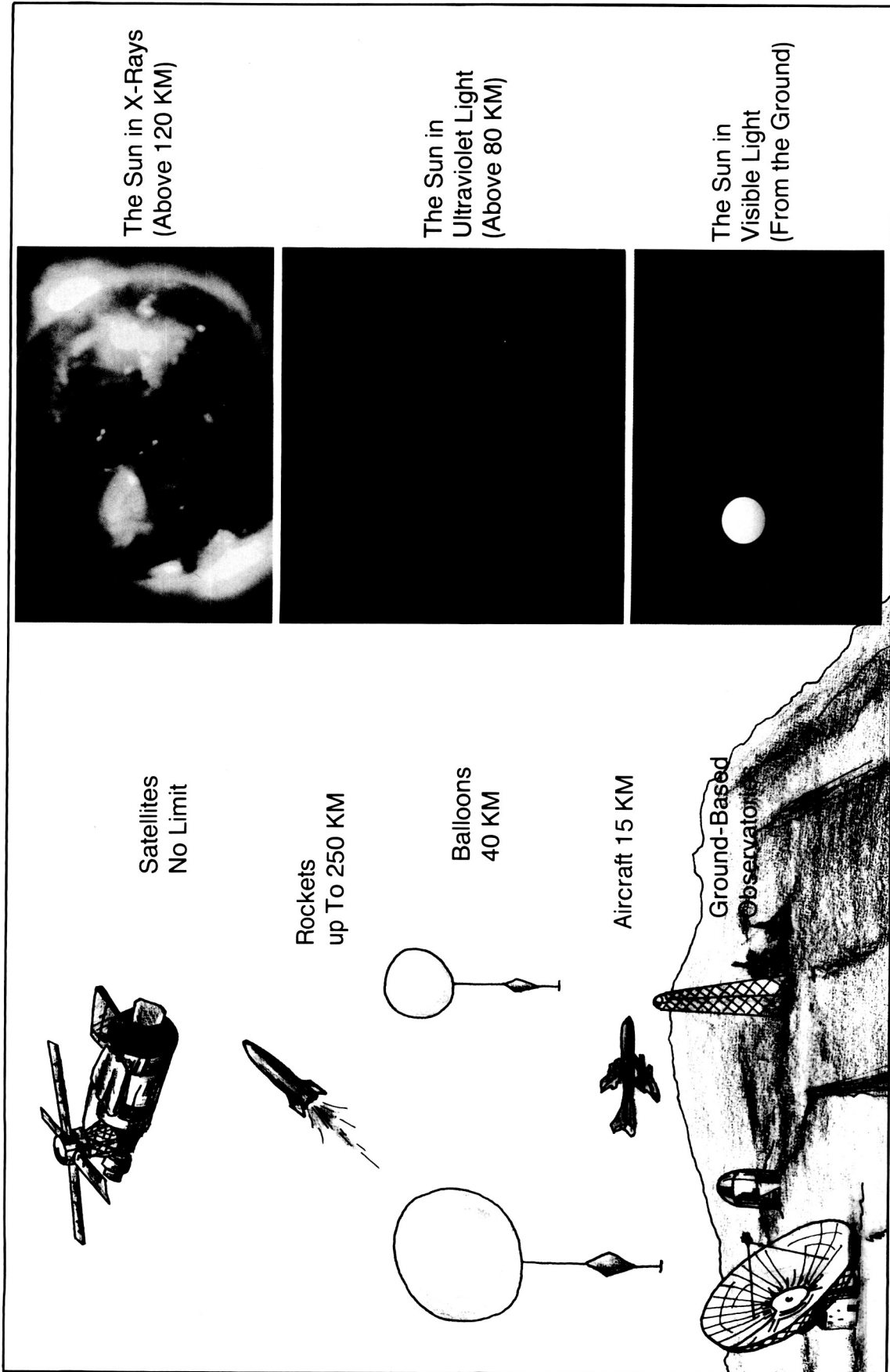

The Sun in X-Rays  
(Above 120 KM)

The Sun in  
Ultraviolet Light  
(Above 80 KM)

The Sun in  
Visible Light  
(From the Ground)

Satellites  
No Limit

Rockets  
up To 250 KM

Balloons  
40 KM

Aircraft 15 KM

Ground-Based  
Observatories

The Sun from Space

# The Relevance of Solar Study

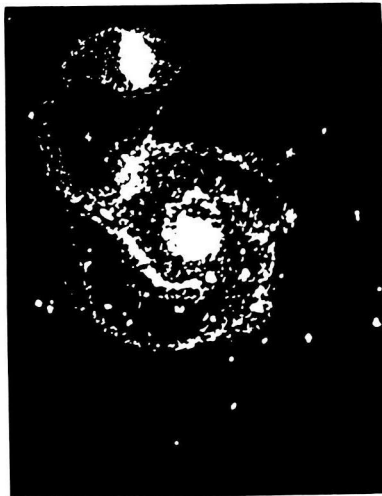

*The Whirlpool Galaxy (M51)*

Why do we study the Sun?

One of the reasons is that our life depends on the Sun—its light and heat make life on Earth possible. We are so certain of the Sun's constancy in performing this function that the Sun's rise each morning has become a metaphor for certainty. Recent spacecraft measurements have shown that the Sun's output is not constant but is marked by subtle variations. Similar variations may have triggered the ice ages of the past. The Earth's environment is also affected by the Sun's fluctuating emissions of particles, magnetic fields, and invisible electromagnetic radiation. These emissions disturb our magnetic field and create the aurorae and the ionosphere. For measuring these phenomena and identifying their effects on the Earth's environment, instruments in space have been invaluable.

We also study the Sun as a star. Astrophysicists classify the Sun as a star of average size, temperature, and brightness—a typical dwarf star just past middle age. But its

location, 275,000 times closer than any other star, makes it unique. The Sun's proximity serves us like a powerful telescope, permitting the discovery and study of sunspots, flares, convection, rotation, solar wind, and atmospheric structure, all of which have later been discovered on other stars. Furthermore, the Sun's mass, temperature, and age have been benchmarks in developing the theory of stellar structure and evolution. Even today, attempts to measure the products of the Sun's thermonuclear reactions reveal flaws in existing astrophysical theories. Hence, the Sun continues to act as a Rosetta Stone, helping us to decipher the secrets of astrophysics.

Finally, the Sun provides scientists a unique laboratory for testing the laws of modern plasma physics. These laws, which govern the interaction of hot gases with magnetic fields, cannot for reasons of scale be tested adequately within the confines of an Earth-bound laboratory.

ORIGINAL PAGE  
COLOR PHOTOGRAPH

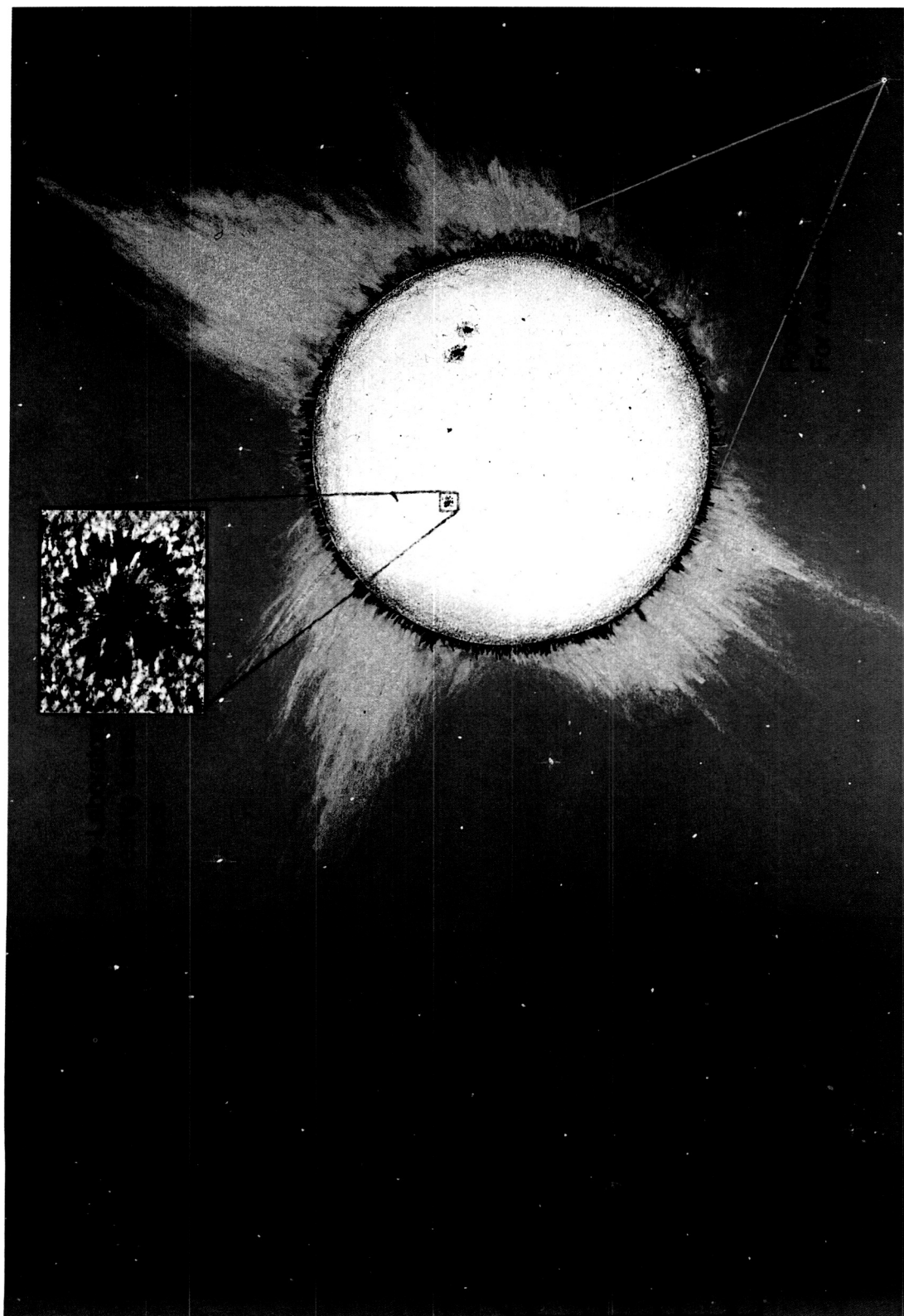

Why We Study the Sun

ORIGINAL PAGE  
COLOR PHOTOGRAPH

# A Physical Description of the Sun

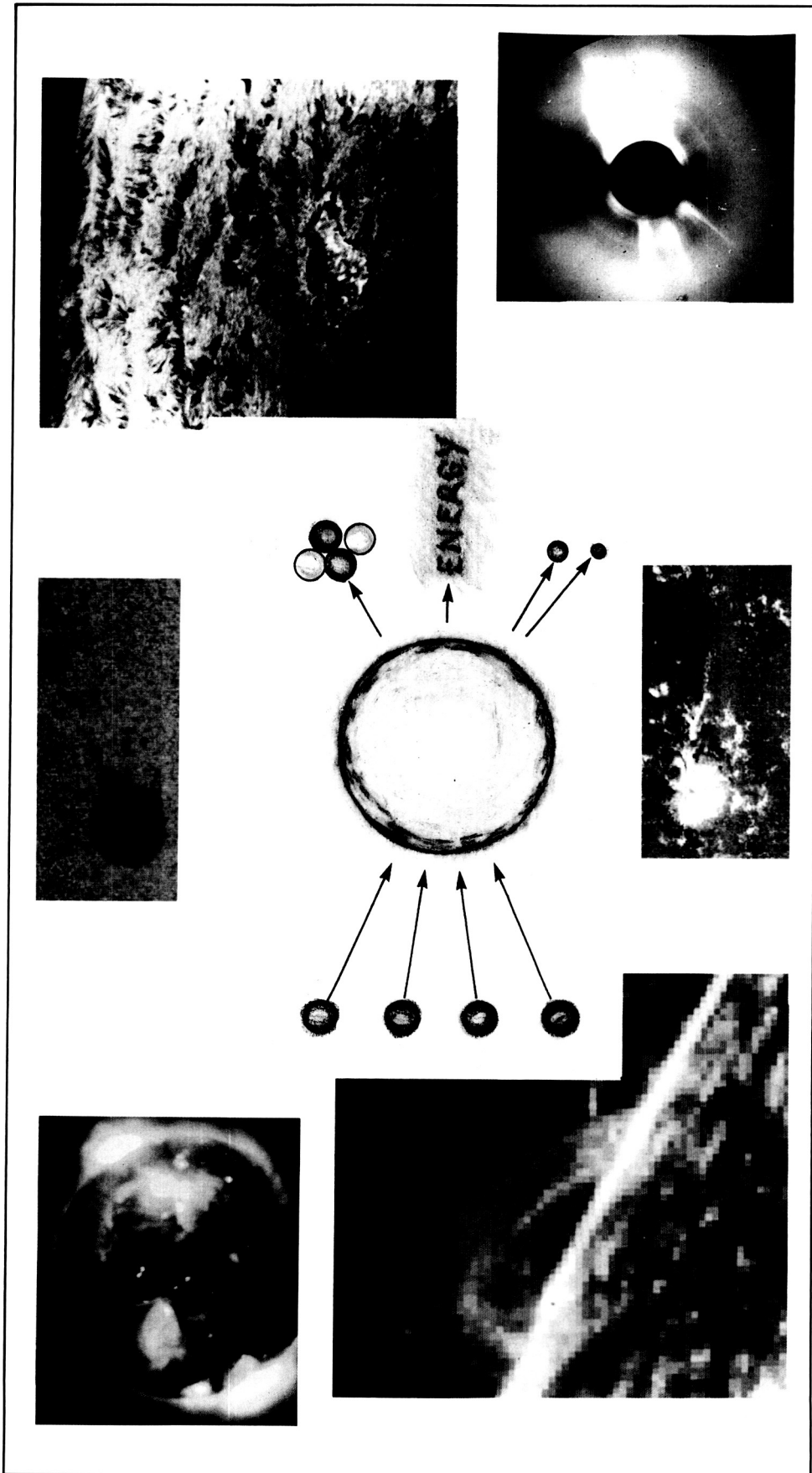

PRECEDING PAGE BLANK NOT FILMED

# The Five Heliographic Domains

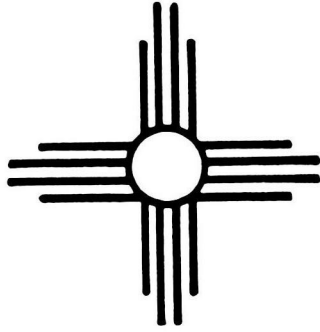

From the crushing pressure and density of its core to the near vacuum conditions in its magnetic field laced outer atmosphere, the Sun and its atmosphere span a vast range of physical conditions. To comprehend the discoveries and unanswered questions of solar physics, it is helpful to introduce the five heliographic domains.

- The Interior—site of the nuclear burning which heats the Sun, the Earth, and mankind.
- The Surface Atmospheres—the Sun's golden, visible surface, the photosphere, and its hotter overlying skin, the chromosphere.
- The Inner (Visible) Corona—the glowing halo of the Sun visible from Earth at times of solar eclipse.
- The Outer Corona and Solar Wind—the region where the Sun's superheated outer atmosphere overpowers its constraining gravity and magnetic fields and streams outward into space.

- The Sun-Earth Interface—the Sun's electromagnetic, particle, and magnetic field emissions and the processes by which they affect the Earth's space environment.

The age of space exploration has seen dramatic increases in knowledge of each domain, in many cases resulting from the expanded sensitivity and spectral coverage available from space.

ORIGINAL PAGE  
COLOR PHOTOGRAPH

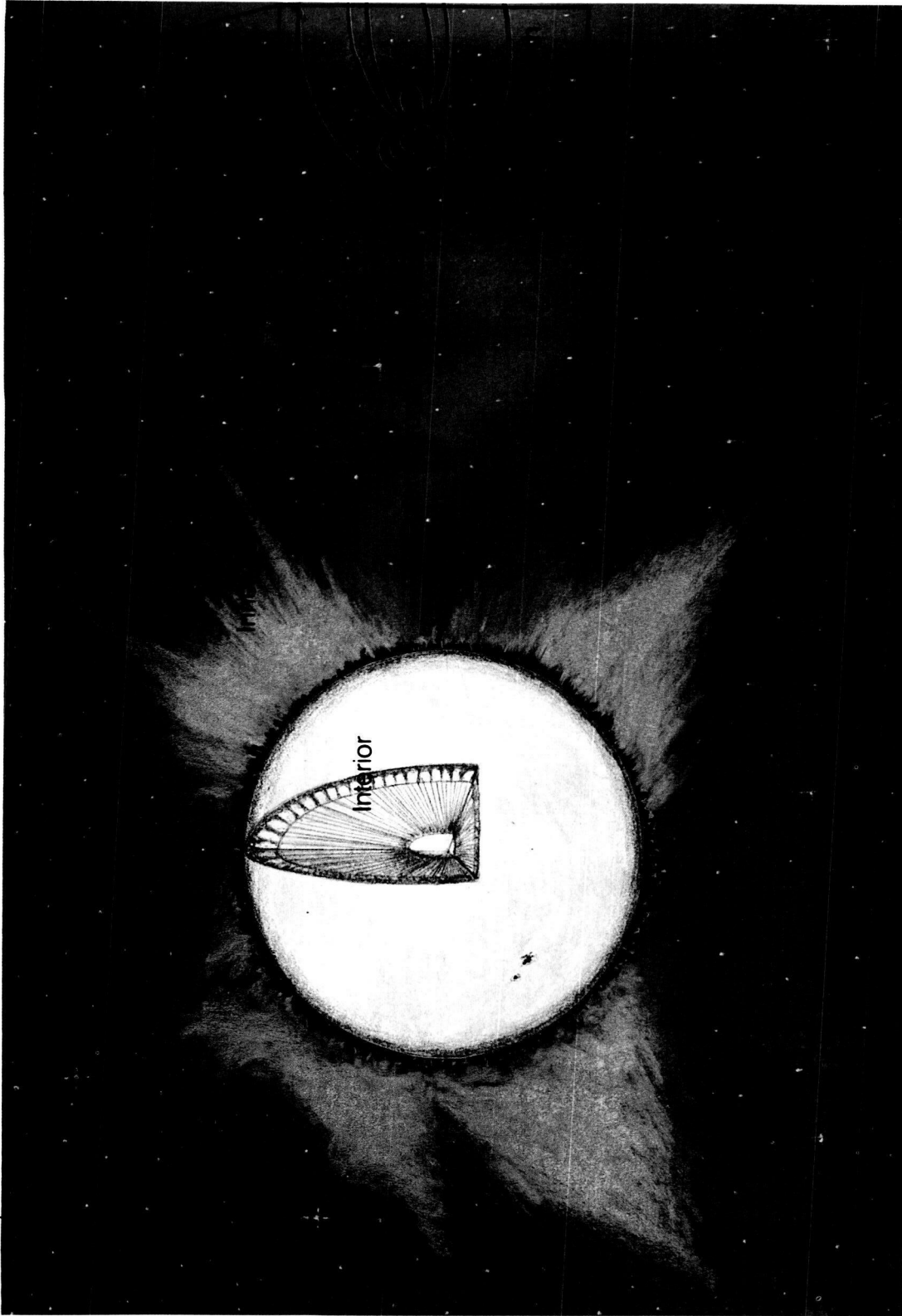

The Five Heliographic Domains

# The Solar Interior

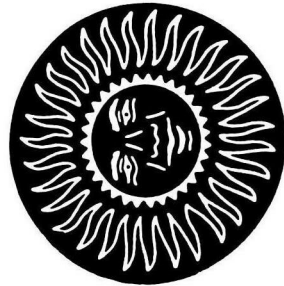

The Sun's surface is not solid like the Earth's, but its temperature and density make it just as difficult to see through. Hence, all we know of conditions within the Sun must be inferred by measuring the things we can see—its size, mass, and surface brightness and composition—and by applying the fundamental laws of physics.

The Sun's nuclear furnace is in its center, where intense heat (15 million degrees) and pressure (200 billion atmospheres) fuse hydrogen nuclei into helium. The photons of energy produced by fusion travel at the speed of light. Uninterrupted, these photons would reach the surface within three seconds, but in the Sun's crowded interior, these photons are absorbed and re-radiated so many times that their journey to the surface takes ten million years. In the Sun's outer layers, its outward flowing energy is lifted to the surface primarily by rising bubbles of hotter, lighter material pushed upward by buoyant forces in the process known as convection.

There are important uncertainties remaining in this picture of the Sun's interior. We

do not yet know the depth of the zone where convection occurs, a fact which may help us predict the behavior of surface magnetic fields. The unknown abundance of elements in the interior affects the rate energy leaks from the core and the way the Sun and other stars evolve. If the Sun's core rotates rapidly or contains strong magnetic fields, Einstein's General Theory of Relativity may need to be revised.

Answers to these questions will be sought by two recently developed techniques. One technique uses the detection of neutrinos, the tiny fast remnants of the nuclear burning process which escape unimpeded from the core. The other technique, which is called helioseismology, involves the measurement and interpretation of surface disturbances caused by sound waves traveling through the Sun's interior. Thus far, these techniques have yielded results which differ from those predicted by theory. For this reason, current plans for more sensitive solar neutrino experiments and for improved ground- and space-based measurements of solar oscillations are of the utmost importance.

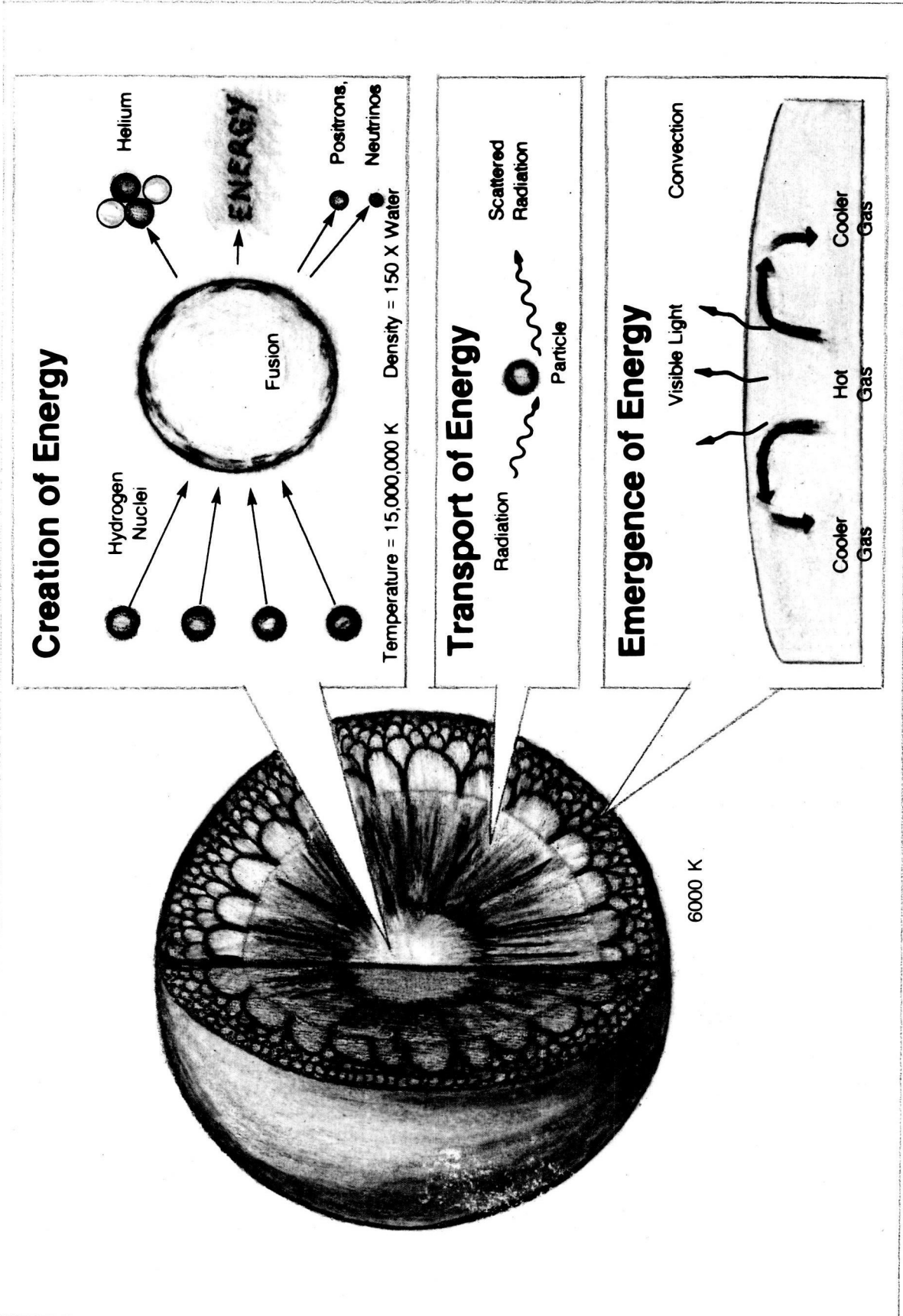

Energy Processes within the Sun



# The Surface Atmospheres

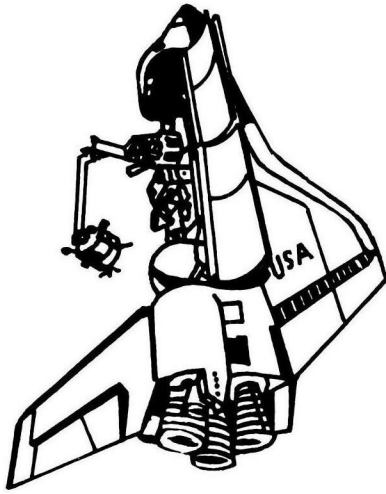

*Spacelab 2*

We call the golden surface of the Sun the photosphere. Even when the Sun is in its quiet state, this surface seethes with motion. Bubbles of hotter material well up from within the Sun, dividing the surface into bright granules that expand and fade in several minutes, only to be replaced by the next upwelling. Simultaneously, the surface undulates with wave motions which repeat at roughly five-minute intervals.

Above the photosphere is the chromosphere, so named because it may be seen briefly during eclipses as a reddish rim around the Sun. Like the photosphere, the chromosphere is mottled by a cellular convection pattern, but the cells are thirty times larger than granules and last several hours. Solar material flows horizontally outward from the center of these "supergranules," sweeping magnetic fields to the cell boundaries. Field concentrations along cell boundaries are marked by vertical jets of material called spicules.

Sometimes huge magnetic field bundles break through the surface, disturbing this quietly simmering Sun with a set of condi-

tions known collectively as "solar activity." These fields cool and darken the photosphere, producing the well-known sunspots. These same fields arch through higher atmospheric layers, heating them and creating glowing, bright "active regions." At times active regions explode with an intense release of magnetic energy called a solar flare, causing sudden large increases of radiation and expelling huge quantities of energetic particles into space.

Solar activity displays an enormous range of time scales. Flares begin in seconds and end in minutes or hours. Active regions last many weeks, and may flare many times before fading away. The number of sunspots and active regions rises and falls in a mysterious eleven-year cycle. Behind all of these phenomena and time scales are the Sun's magnetic fields, deriving their energy from the interplay of the Sun's rotation and convection motions. To observe and interpret the intricate interactions of fields and matter, we need to operate a large, high resolution solar telescope outside the Earth's own turbulent atmosphere.

ORIGINAL PAGE  
COLOR PHOTOGRAPH

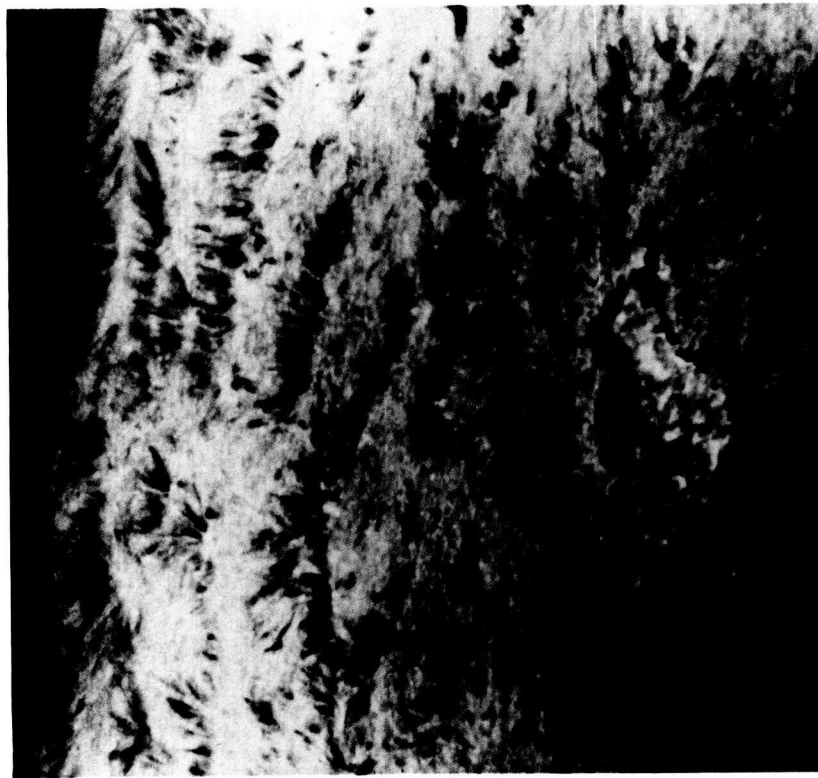

The Quiet Sun—Supergranules with Boundaries Marked  
by Spicules

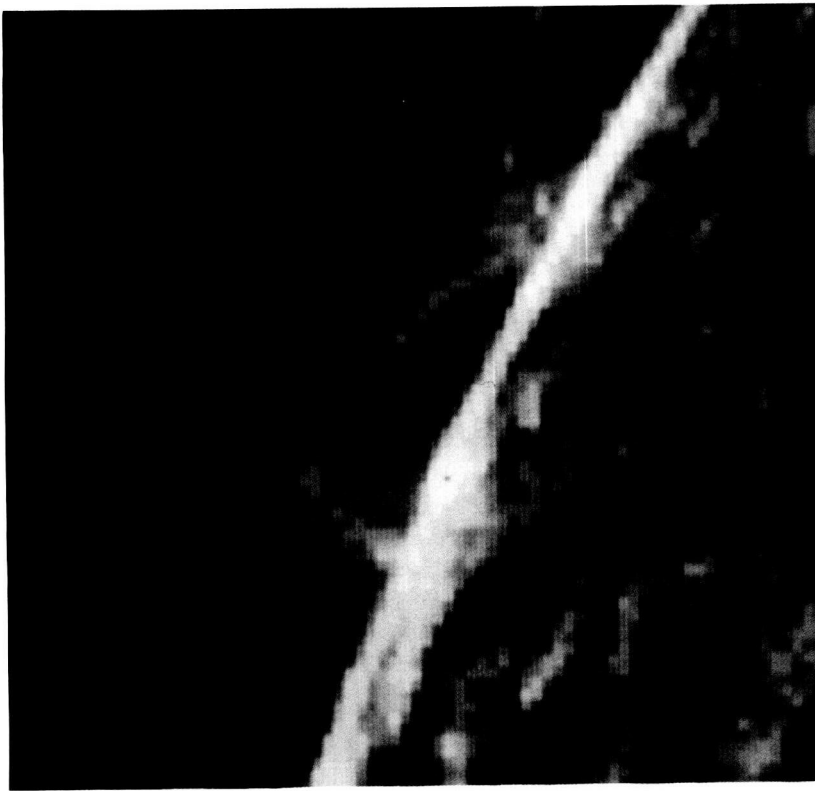

The Active Sun—Active Region Loops at Limb

---

The Sun's Surface Atmospheres

# The Inner Corona

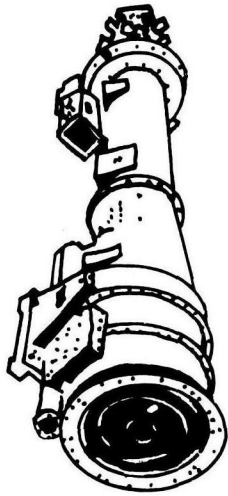

*Skylab S-054 X-Ray Telescope*

The Sun's wispy halo, the corona, reaches more than a million miles into space, making the corona larger than the Sun itself. But the Sun's brilliant disk blinds our view of the corona except when the moon covers the disk during an eclipse. Only fifty years ago, scientists learned that the corona's puzzling spectral signature is not caused by a new chemical element ("coronium"), but by a temperature much hotter than the underlying surface. This discovery defies intuition and theory, and the corona's two million degree temperature remains an intriguing mystery despite many attempts at explanation.

To increase opportunities for coronal observation, the French astronomer Lyot invented the coronagraph in 1930. This instrument artificially eclipses the Sun's surface so the corona can be observed at any time. Coronagraphs are especially effective in space, where the corona can be seen with exceptional clarity against the black background of space.

Our ability to launch instruments into space has also made it possible to observe the corona in X-rays, which do not penetrate the Earth's atmosphere. X-rays are produced abundantly in the ultra-hot corona, and reveal coronal temperatures and densities more directly than the corona's visible light, which is mostly second-hand light from the Sun's surface scattered by coronal material. Furthermore, because the corona is much brighter at X-ray wavelengths than the Sun's underlying cooler surface, it can be observed against the face of the disk. From this vantage point, it is clear that magnetic arches and streamers dominate the structure of the corona. Large and small magnetic active regions glow brightly at X-ray wavelengths, while open magnetic field structures appear as gaping holes in the corona. To understand the physical processes by which magnetic fields shape coronal structure and contribute to its extremely high temperature, we need to orbit X-ray telescopes of greatly improved resolution and sensitivity.



Corona Observed from Space  
with X-Ray Telescope

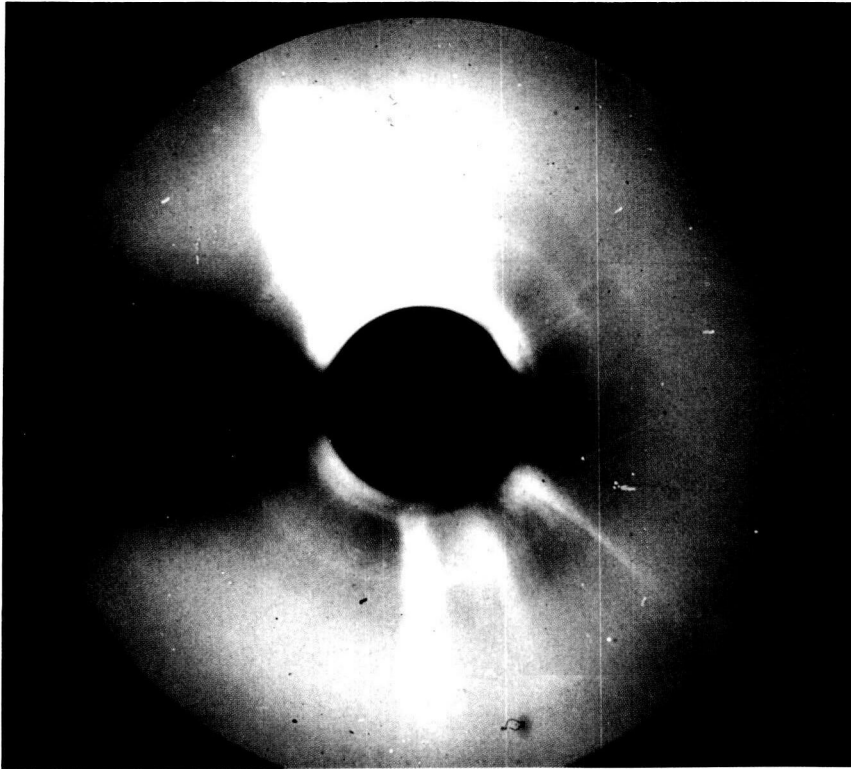

Corona Observed from Space  
with Coronagraph

The Inner Corona

# The Outer Corona and Solar Wind

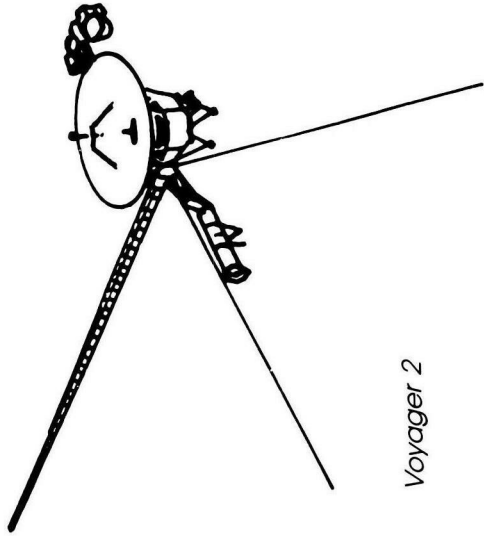

*Voyager 2*

One of the great discoveries of space physics is that the Earth is immersed in the Sun's expanding outer atmosphere. Eclipse observations of the Sun's corona gave an early clue of the outflow of solar material. Dual comet tails were another early clue; the straight, clumpy tail is caused by the Sun's radiation pressure, and a more diffuse tail by outflowing coronal material. In 1958, theorist Eugene Parker developed a theory predicting this outflow, which he called the solar wind. This prediction was decisively confirmed in 1962 by the Mariner 2 spacecraft on its way to Venus.

Continued spacecraft measurements reveal that the solar wind is much faster (a million miles per hour), thinner (a few particles per cubic centimeter), and hotter (several hundred thousand degrees) than any wind on Earth. The solar wind is hot enough to be a "plasma," meaning that its atoms are divided into electrically charged particles—electrons, protons, and ions. As a plasma, the wind carries with it magnetic fields from the corona, exposing the Earth alternately to the influence of the Sun's north and south magnetic poles. The Earth's own magnetic field deflects solar wind particles, but it interacts with solar

wind fields, allowing some solar wind energy to leak into the terrestrial environment by a variety of processes.

What causes the solar wind to flow? Its energy comes from the heat of the corona, but we have been unable to observe its acceleration because the action takes place in the inner corona, which has not yet been studied by telescope or by spacecraft. Observation of solar wind acceleration requires new observing techniques, or spacecraft that can withstand the tremendous heat close to the Sun, where the accelerating wind can be measured directly.

How far does the solar wind go before it succumbs to the magnetic influence of the galaxy? Instruments on the Voyager spacecraft continue to measure the wind beyond Saturn's orbit, and we hope these instruments will record the wind's termination in interstellar space.



Solar Wind Evidence — Dual Tails,  
Comet Mirkos

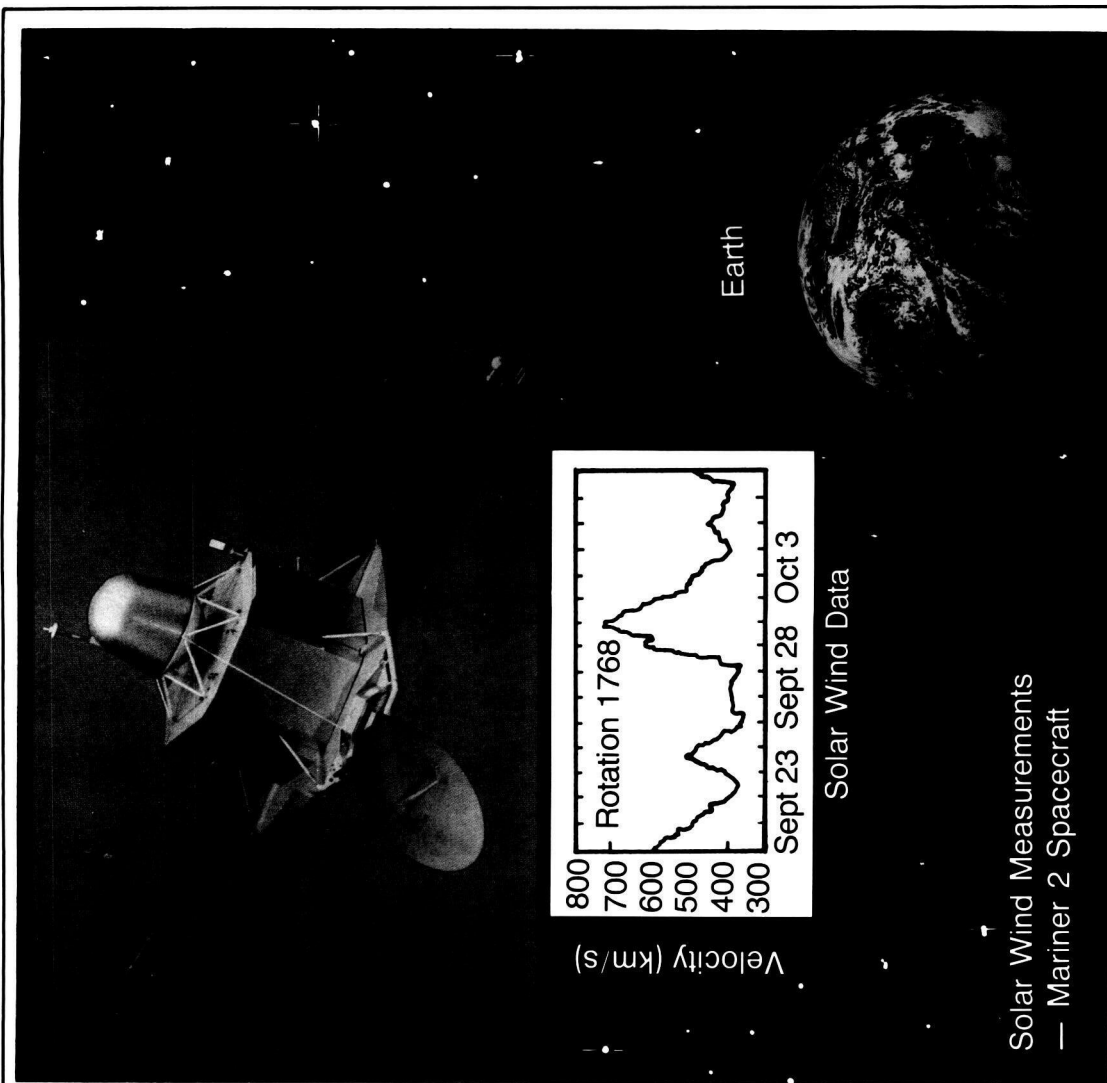

Solar Wind Measurements  
— Mariner 2 Spacecraft

# Solar Effects on the Earth

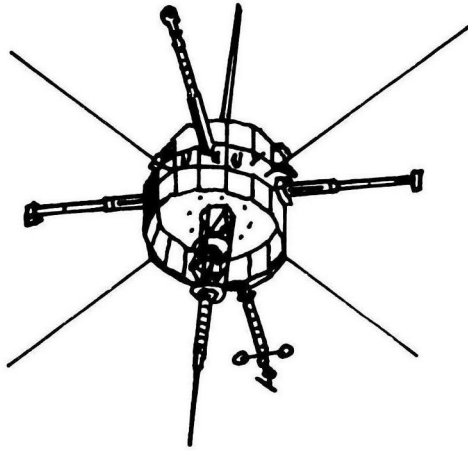

*International Sun-Earth  
Explorer (ISEE)*

The Sun continually bombards the Earth with energy in three forms: particles, magnetic fields, and electromagnetic radiation (radio, infrared, visible, ultraviolet, X-rays, and gamma rays). Since each form of energy affects our environment, we need to understand the solar patterns and processes which produce this energy.

Most of the Sun's energy output is in the form of visible light. This light provides the energy for photosynthesis and for the heat, wind, and even precipitation of our weather. Not yet known are the effects of the subtle changes in the Sun's visible light emission which have recently been detected by spacecraft. Space-based instruments have also measured much larger variations in the Sun's ultraviolet and X-rays, which are absorbed by the Earth's upper atmosphere. The absorption process heats the atmosphere and causes it to expand. The atmospheric density change which accompanies this expansion exerts a changing drag on low-altitude Earth-orbiting spacecraft and thus determines how long such spacecraft will stay in orbit. Ultraviolet and X-rays also break atmospheric atoms and molecules into electrons and ions and produce the ionosphere—the

layers of the atmosphere which reflect radio waves and make long-distance short-wave radio transmission possible.

The particles and fields of the solar wind are responsible for the aurorae and for perturbations in the Earth's magnetic field. Some of the largest auroral and geomagnetic disturbances occur when solar flares expel large quantities of hot gas into space—hot gas which the solar wind channels toward the Earth. Spaceborne instruments have detected other solar wind patterns and features which disturb the Earth but whose solar source is invisible from the ground. These instruments have also shown that the strength of solar wind disturbances of our environment depends not only on wind velocity and density, but also on its magnetic field orientation. It is this orientation which determines whether the solar wind leaks through or flows around the Earth's magnetospheric shield.

Direct observations of the solar wind striking the magnetosphere are no longer regularly available. A new and more advanced solar wind measuring spacecraft is urgently needed.

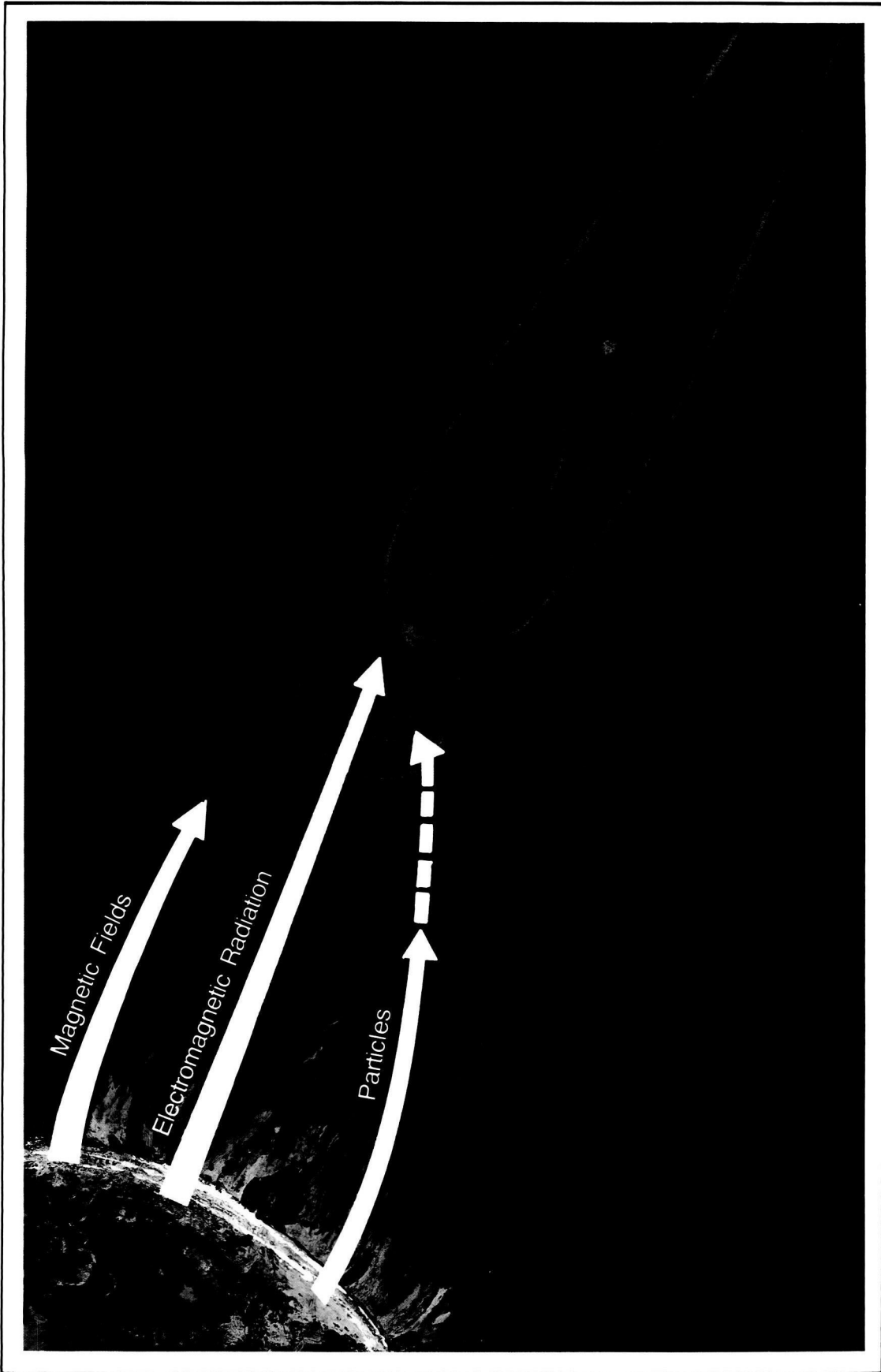

Solar Effects on the Earth (Drawing Not to Scale)



# Current Problems In Solar Physics

ORIGINAL PAGE  
COLOR PHOTOGRAPH

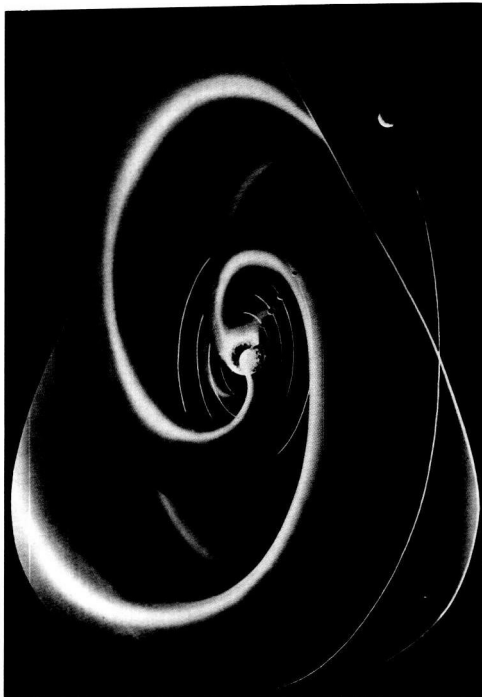
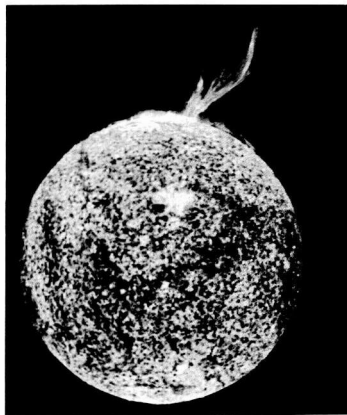

PRECEDING PAGE BLANK NOT FILMED

# Why Are There So Few Solar Neutrinos?

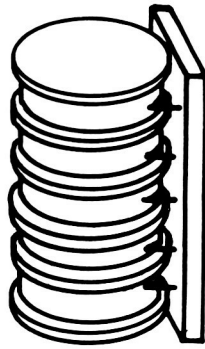

*Brookhaven Neutrino  
Detector*

Scientists would love to have a glimpse deep into the heart of the Sun. The inferno there is the source of the Sun's (and the Earth's) energy, and knowledge of conditions there may help us to harness the energy of nuclear fusion on Earth. The Sun's light cannot bring us this knowledge; light can travel only short distances below the Sun's blazing surface. But a glimpse of the Sun's very center has recently become possible using neutrinos — tiny subatomic particles which are produced by nuclear reactions within the Sun. Neutrinos travel with the speed of light, but unlike light, they rarely interact with matter, and can stream from the Sun's center undisturbed. To detect these elusive neutrinos on Earth, a 100,000 gallon tank of cleaning fluid has been placed deep within a mine (out of reach of cosmic rays). Current solar theories predict that this tank will capture six neutrinos per day, but it has detected only one third this many. This unexpected result seriously challenges current solar theories.

The magnitude of the challenge can be appreciated by a survey of proposed explanations. Solar theories can match the observed neutrino flux if material within

the Sun has undergone large scale mixing for some unknown reason. Alternately, the Sun may vary slowly, with a cool core temperature now implying a lower surface temperature in a few million years. This may explain past (and future?) ice ages. A cool central temperature may result from intense, trapped magnetic fields or from a rapidly rotating core. (The latter explanation would require adjustments in Einstein's General Theory of Relativity.) The most exotic explanation is that the Sun's energy is not generated by fusion at all, but by matter falling into a gravitational singularity (popularly known as a black hole) in the Sun's center. An explanation which leaves current solar theories intact is that neutrinos change to an undetectable form between Sun and Earth. This would have significance ranging from elementary particle physics to cosmology.

To help choose the correct solution, efforts are underway to build a more sensitive neutrino detector using gallium, a rare metallic element used in semiconductors. These measurements will be complemented by the emerging techniques of helioseismology, which use the Sun's own acoustic waves to probe its interior.

ORIGINAL PAGE  
COLOR PHOTOGRAPH

## The Problem

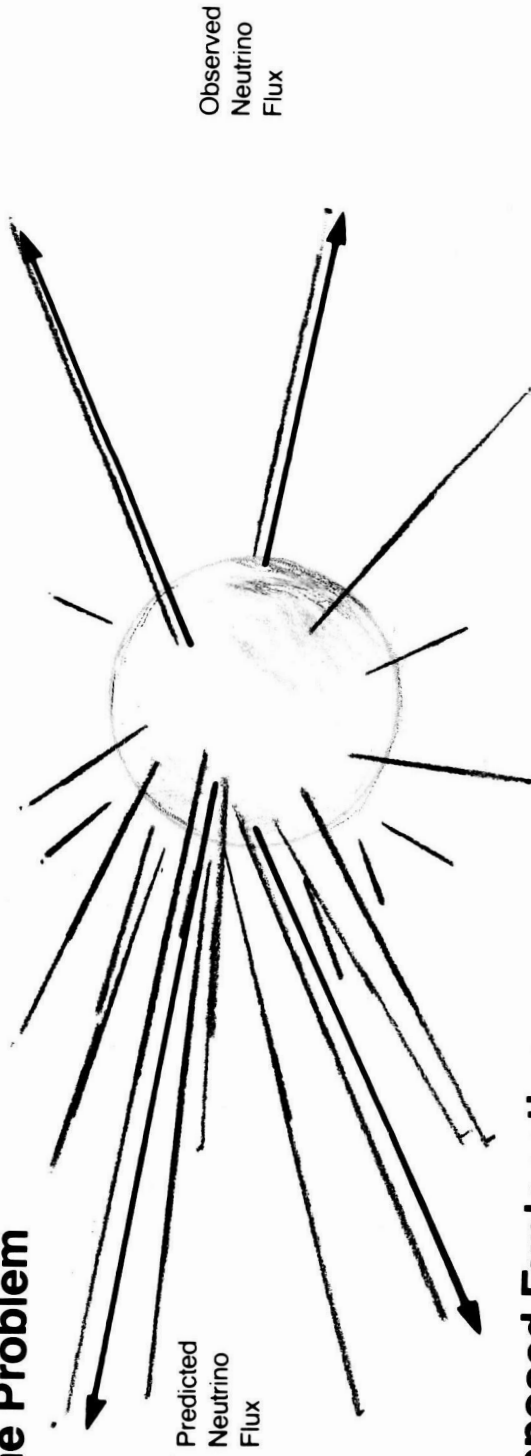

## Proposed Explanations:

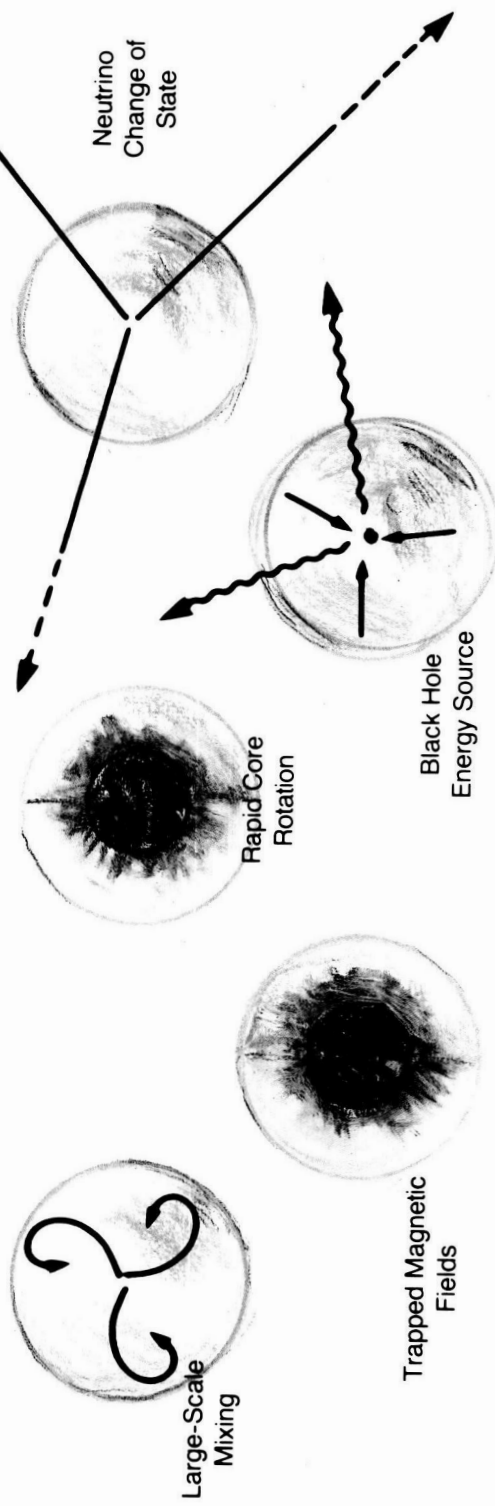

# What Will Helioseismology Uncover?

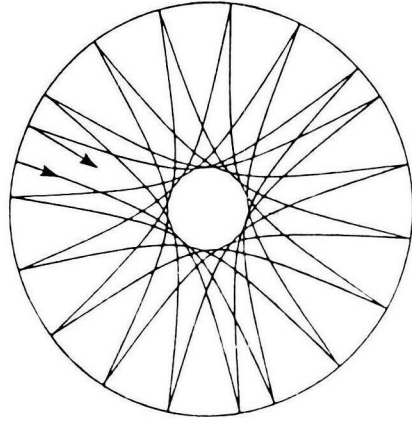

*Ray Path of One Acoustic Wave Mode Traveling through the Sun's Interior*

Much of what we know about the Earth's interior comes from seismology—the study of earthquake waves traveling below the surface. What might we learn if we could put seismographs on the Sun? In a sense, solar scientists have learned to do just that. By measuring minute shifts in the color of sunlight, we can measure solar motions of less than one meter per second, which is the pace of a leisurely walk. These motions are caused by acoustic waves traveling below the Sun's surface, waves which can be used to probe the Sun's interior. This procedure, which is called helioseismology, has already been used for preliminary measurements of the depth of the convection zone and the rate of solar rotation below the surface. It may yet help to solve the mystery of the missing solar neutrinos.

Helioseismology was developed using ground-based observations, but there are two tantalizing reasons for pursuing this technique with an observatory in space. One reason is to surmount the Earth's shimmering atmosphere. From space, we can observe clearly the small-scale solar motions which are ideal for probing the

Sun's shallow outer layers. The other reason is that an observatory in space can operate without interruptions for night or weather. Long, uninterrupted observations are essential to detect and measure the hour-long oscillations which penetrate the Sun's deepest layers. Interruptions may be avoided by putting the spacecraft in a halo orbit around the zero-gravity point between Sun and Earth. This orbit also keeps spacecraft motions relative to the Sun small, minimizing a potential source of error.

Instruments suitable for helioseismology observations from space are already planned, as are ground-based observing networks. These plans not only promise a powerful tool for addressing the solar neutrino problem, but also the prospect of discovering and exploring new surprises which the Sun now hides below its surface.

ORIGINAL PAGE  
COLOR PHOTOGRAPH



Solar Waves: Blue and Red Represent Expanding and Contracting Regions

# How Do We Explain the Behavior of the Sun's Magnetic Fields?

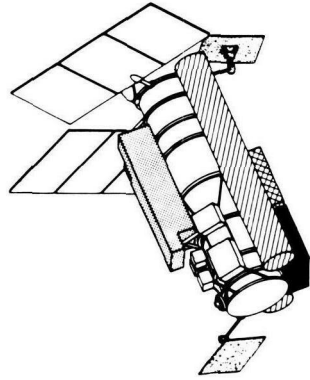

*Orbiting Solar Observatory (OSO)  
Sun Sync Free Flyer*

From the dark sunspots of the photosphere to the glowing arches of the corona, magnetic fields are responsible for many interesting things that happen on the Sun. Any serious effort to explain these phenomena inevitably leads to the problem of explaining the behavior of the Sun's magnetic fields.

On a large scale, magnetic field behavior is marked by the eleven year rise and fall in the number of sunspots. During successive eleven year periods, magnetic fields in spots and at the Sun's poles reverse polarities. Hence, the fundamental cycle is a twenty-two year cycle of the Sun's magnetic fields. This cycle results from the solar "magnetic dynamo," the stretching and twisting of magnetic fields by the Sun's upwelling convective motions and its more rapid rotation at the equator than at the poles. Successful dynamo theories must explain not only the eleven year cycle, but also variations in the strength of cycles, including the nearly complete disappearance of cycles which occurred between 1645 and 1710. Helioseismology

promises to improve dynamo theories by letting us measure the rotation and convection below the surface where magnetic dynamo action takes place.

The behavior of magnetic fields on small scales may be an even greater mystery. There is no explanation for the stability of the large, intense magnetic field concentrations which we observe in sunspots. The problem is compounded by the recent discovery that most magnetic fields outside of spots are concentrated in small bundles of high field strength. This discovery challenges some assumptions of the dynamo theories since these intense bundles cannot be moved about easily by the Sun's convection and rotation motions. It may also be the key to understanding the relation between magnetic fields and coronal heating. But the discovery itself is at the limits of ground-based observations, so further confirmation and exploitation must await high resolution velocity and magnetic field measurements available only from a large telescope in space.

### The Macro Problem — The Sunspot Cycle

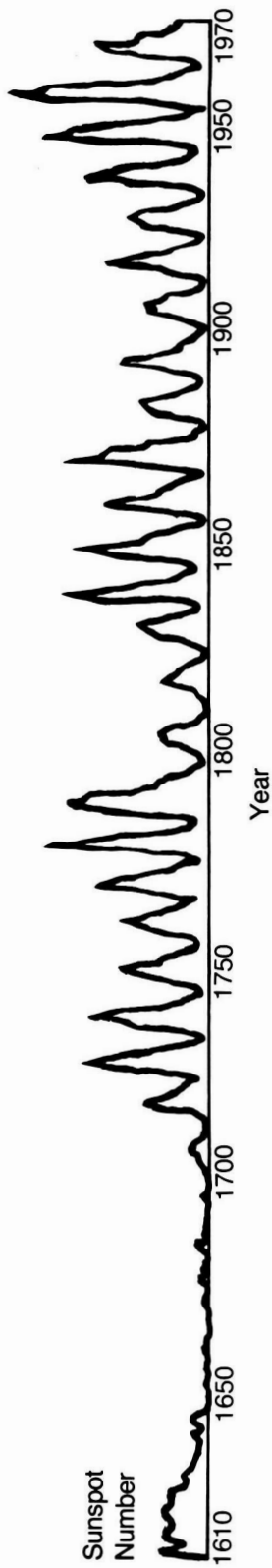

### The Micro Problem — Small-Scale Solar Magnetic Fields

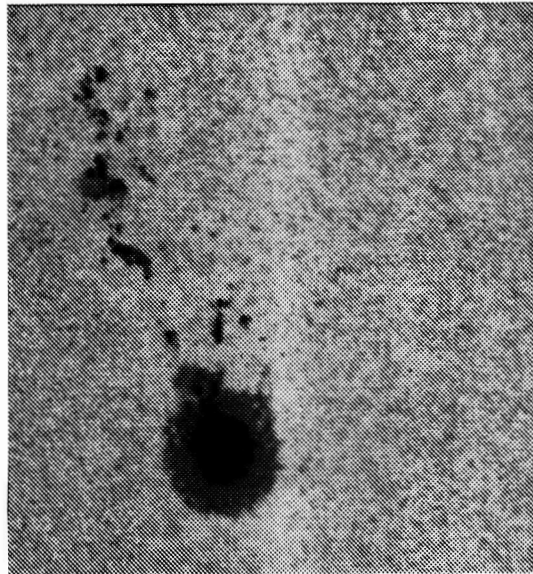

An Active Region Photographed in White Light



A Magnetic Field Map of the Same Region

### The Sun's Magnetic Field

# Why is the Corona So Hot?

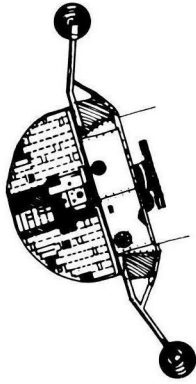

*Orbiting Solar Observatory  
(OSO-8)*

One of the Sun's most puzzling and persistent mysteries is the temperature profile of its atmosphere. Instead of becoming cooler further from the surface, the atmosphere becomes hotter. The temperature rises steadily in the chromosphere, then jumps abruptly in the corona to a level thirty times hotter than the surface. While the corona's energy must come from the Sun, this flow of energy seems to contradict thermodynamic principles requiring heat energy to flow from a hotter object to a cooler one.

For decades, the preferred explanation has been that energy flows from the Sun's surface to the corona in the form of sound waves generated by convective upwelling motions. Ground-based instruments observed sound waves in the Sun's lower atmosphere, but these instruments could not trace them through hotter, higher levels of the atmosphere. Space-based ultraviolet observations in the late 1970s proved that sound waves carry their energy high enough to heat the lower chromosphere, but *not* high enough to heat the corona, so the mystery remains.

Since that time, solar scientists have devised several alternate new theories to explain coronal heating. One theory is that magnetic fields convert sound waves into magnetohydrodynamic waves, whose material motions are hard to detect. Another theory is that jets of material thrust upward along magnetic field lines give the corona its energy. The high coronal temperature may come from the direct dissipation of coronal magnetic fields resulting from the twisting and tangling of their photospheric roots.

Choosing the correct theory requires sensitive measurements of gas motions and magnetic fields throughout the Sun's atmosphere. Only observations from space can resolve the smallest solar magnetic field structures and extend to the ultraviolet and X-ray wavelengths characteristic of the Sun's upper atmosphere. Hence, a sophisticated solar space observatory with a battery of high-resolution instruments offers our best hope of unravelling the mystery of solar and stellar coronal heating.



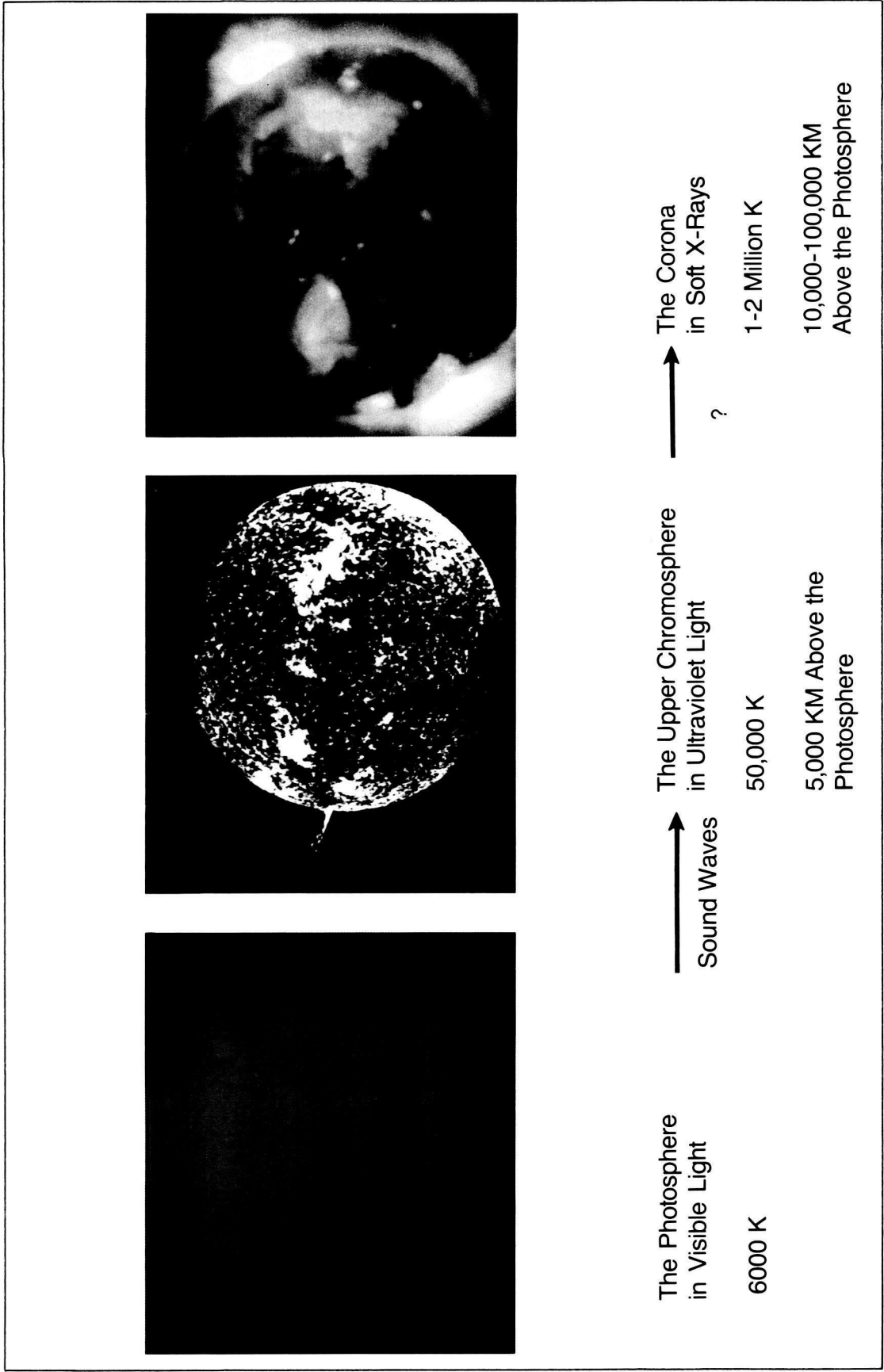

Coronal Heating

# Why Do Solar Flares Occur?

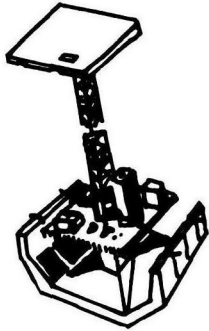

*Pinhole/Occulter Facility*

In less than an hour, flares release more energy than a billion nuclear explosions. Terrestrial by-products include strong aurorae, magnetic field perturbations, and ionospheric disturbances. In spite of these effects, flares were late to be discovered (1859) because much of their energy is released in forms not directly visible from the Earth's surface. All forms of flare energy can now be studied from spacecraft, greatly expanding our understanding of flare phenomena and processes.

Flares begin when complex coronal magnetic fields become explosively unstable. The resulting energy release raises temperatures to 100 million degrees and accelerates electrons and protons to near the speed of light. Particles accelerated outward produce distinctive patterns of radio interference at the Earth. Particles traveling inward strike the solar atmosphere. Protons colliding with ions in the Sun's atmosphere produce nuclear reactions, whose gamma rays and neutrons have been detected from spacecraft. These radiations can be used to measure the abundance of different chemical elements on the Sun, a key parameter in theories of stellar evolution.

Most flare energy is carried from the corona by thermal conduction electrons expanding outward along coronal magnetic loops. This energy heats the chromosphere to 10 million degrees and produces an impulsive chromospheric brightening visible in the red light of hydrogen atoms. This light provided the primary means of studying flares before space observations. The flare-heated chromosphere also radiates much energy at ultraviolet and X-ray wavelengths (X-ray emission during a large flare may reach 10,000 times the normal level). Heated chromospheric material expands upward into the corona and may escape into the solar wind.

While flare phenomena are now well known, one fundamental question remains: Why and how is magnetic energy released suddenly and explosively in flares? Flare onset is known to occur very suddenly and to be highly localized in coronal magnetic loops. Hence, imaging space-based high-energy detectors are needed to solve this fundamental question.

Flare Onset High In Coronal Loops  
Photographed In X-Rays

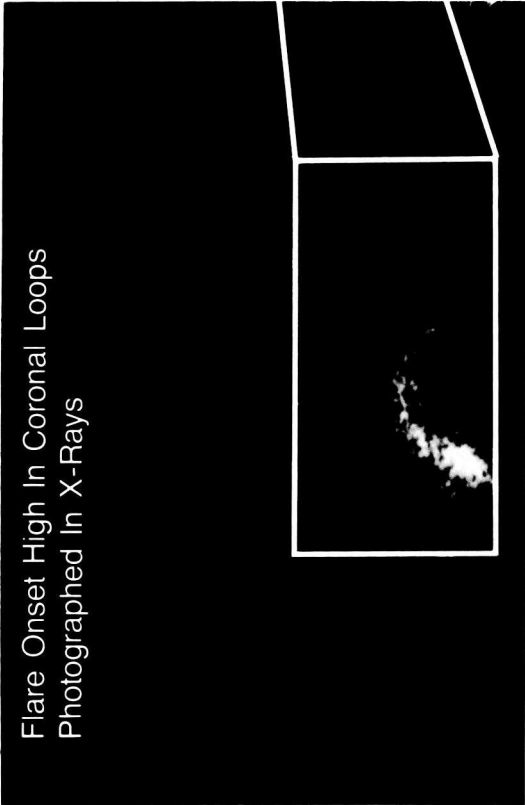

The Result: A Flare Photographed In  
the Chromosphere In the Red Light  
of Hydrogen Atoms

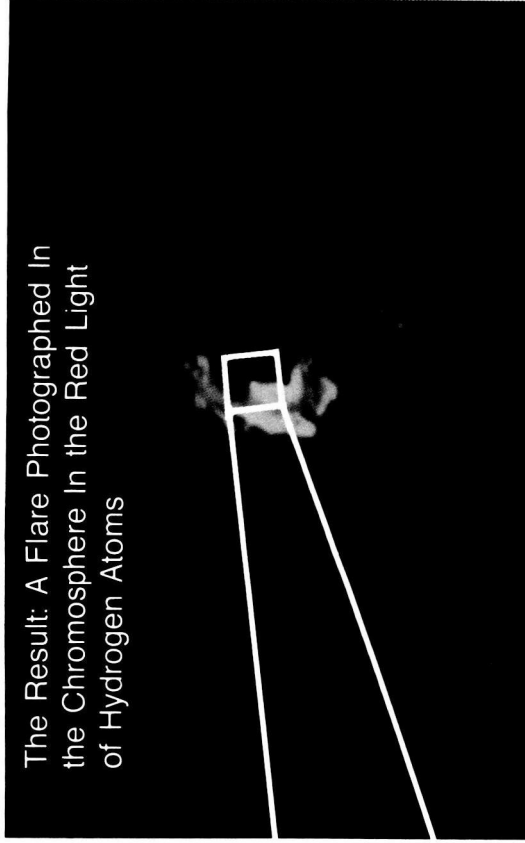

ORIGINAL PAGE  
COLOR PHOTOGRAPH

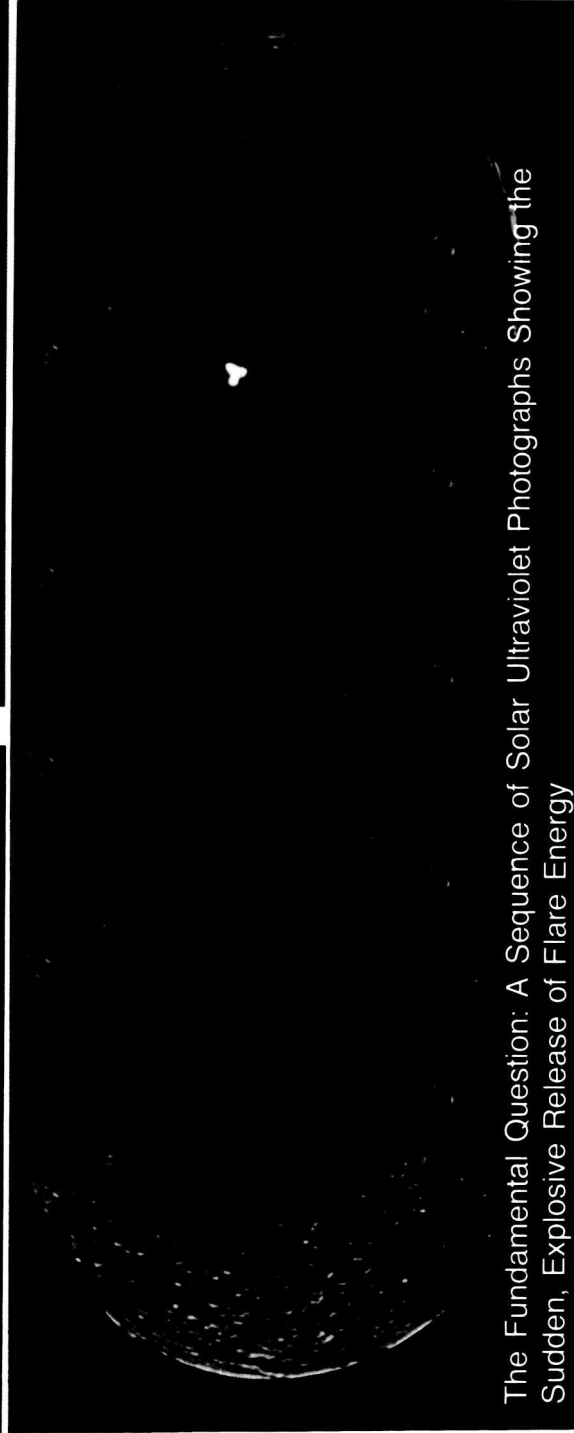

The Fundamental Question: A Sequence of Solar Ultraviolet Photographs Showing the  
Sudden, Explosive Release of Flare Energy

**Solar Flares**

# Why Are There Holes in the Corona?

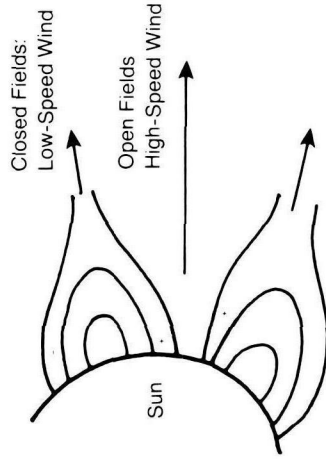

*Coronal Hole Magnetic Field Pattern*

When X-ray telescopes which could form images of the Sun's corona were developed and orbited, observers were surprised to discover that the corona sometimes appears to open into gaping holes.

What is the significance of these holes? In addition to being a surprising and dramatic discovery, they solve a half century old mystery of solar-terrestrial relations. The mystery dates to the 1930s, when Bartels recognized that there are sometimes disturbances in the Earth's magnetic field which repeat every 27 days. Since this is the Sun's rotation period, Bartels concluded that the disturbances must be caused by some solar feature, but he could find no feature which correlated with the disturbances. Bartels therefore labelled the responsible solar features M-regions, where M stands for mystery. When spacecraft discovered that Bartels' disturbed periods correspond to high speed streams in the solar wind, the mystery was half solved. However, it was only with the discovery of coronal holes in the early 1970s and their subsequent correlation with high speed streams that the mysterious M-regions were identified.

What is the cause of the holes? Calculations of coronal magnetic fields show that most coronal magnetic field lines are anchored to the Sun in two places, forming magnetic loops which confine the corona. But in a few places, the magnetic fields open outward into space, allowing the corona to escape freely to form fast, low density streams in the solar wind. The rapid escape of energy leaves behind a cool, low density coronal region that emits few X-rays and hence appears to be a hole in X-ray photographs. One question remains unanswered: Why does the Sun's magnetic dynamo sometimes produce open magnetic field regions? The question must be addressed through a combination of long term coronal studies and high resolution magnetic field measurements. The solution will help us to anticipate holes and the effects they produce on the Earth.

ORIGINAL PAGE  
COLOR PHOTOGRAPH



Coronal Holes - Observed from Skylab

# How Different is the Polar Solar Wind?

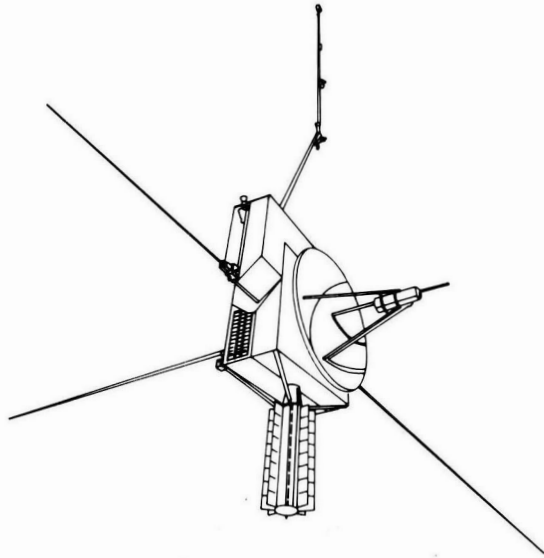

*Ulysses (International  
Solar Polar Mission)*

How limited our understanding of the Earth's weather would be if our measurements were limited to a few degrees from the equator! Yet our knowledge of the Sun's "weather" suffers from just such a limitation. The Earth's orbit keeps it within a few degrees of the Sun's equator, and all spacecraft heretofore sent to measure the solar wind have operated near the plane of the Earth's orbit (the "ecliptic").

What reason is there to believe the solar wind is different over the Sun's poles? One reason is that X-ray photographs have shown large, long lived coronal holes over the poles, and we know that near the equator such holes correspond to solar wind flows of increased speed and reduced density. Large high speed streams from the poles may mean that the Sun is losing mass to the solar wind much faster than has been inferred from our measurements near the equator.

There are also indications that the solar wind's magnetic field character is completely different over the poles. From our limited perspective near the Sun's equator, the solar wind magnetic field is not

random, but is organized into large sectors like the pieces of a pie. Within a sector, the magnetic field is predominantly in one direction, either away from or toward the Sun. It is now believed that these sectors are simply the extensions of the "north" or "south" polarity fields at the Sun's poles, which reverse signs every eleven years. The boundary between these regions is warped like the skirt of a twirling ballerina. The rotating Sun sweeps successive boundaries past the Earth, but the boundary is so thin that terrestrial effects are small. However, for cosmic rays carrying an electric charge, this magnetic field boundary presents a major obstacle. Comparisons over time have proven that solar wind magnetic fields are the solar system's first line of defense against cosmic rays. Hence a satellite over the Sun's poles can not only explore this changing magnetic field geometry, but may also have a unique opportunity to measure these high energy particles streaming in from the galaxy and beyond.

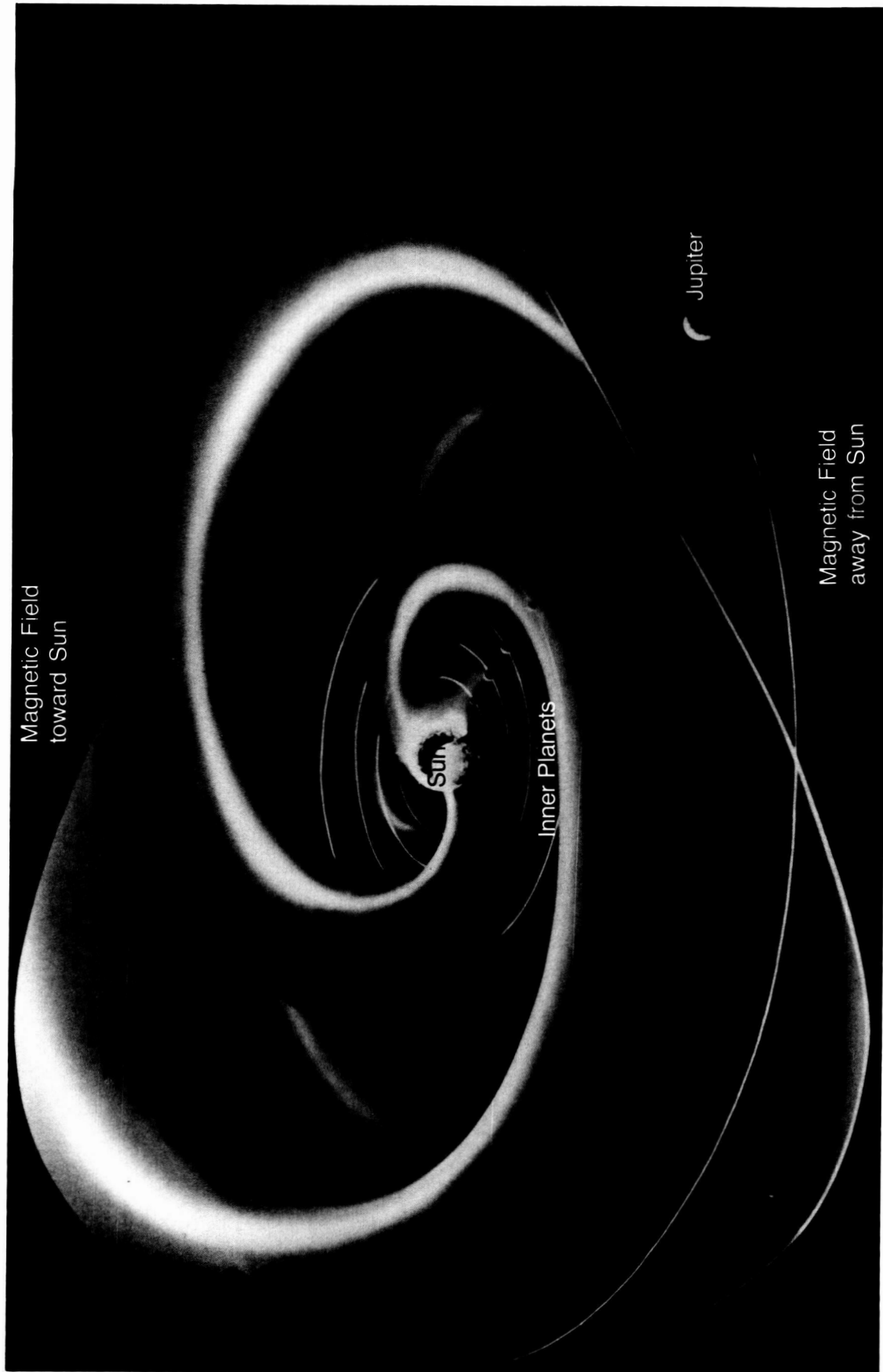

Three-Dimensional Structure of the Boundary between Magnetic Field Sectors in the Solar Wind (Artist's Concept).

# What Triggers Coronal Mass Ejections?

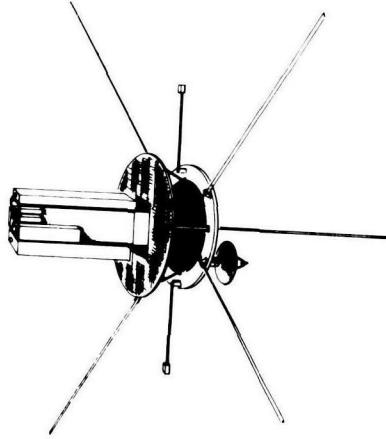

*Solar and Heliospheric Observatory (SOHO)*

Aided by the improved quantity and quality of coronal observations from spacecraft, we have learned that the Sun's loss of material to the solar wind is not always a slow, steady process. The corona is sometimes disrupted by large transient mass ejections traveling outward from the Sun. These ejections have the appearance of huge bubbles or clouds expanding outward through the corona. Notwithstanding their delicate appearance, transient ejections consist of billions of tons of solar material thrown outward so forcefully that they travel millions of kilometers within a few hours. These ejections are the most energetic events in the solar system.

Why do these events occur? Some are associated with solar flares, although it is unclear why some flares produce visible ejections while many do not. An even more frequent identifiable cause is an eruptive prominence in which material suspended over the Sun's surface by magnetic fields (a "prominence") is abruptly expelled outward. In some cases, no surface event can be found to cause the ejection.

tion; it evidently results from the gradual evolution of coronal magnetic fields to an unstable configuration.

If we could measure the particles and fields expelled by such an ejection, we could learn more about the Sun's composition and magnetic field structure, especially in the region where the ejection originated. Unfortunately, such measurements have not yet been possible because the ejections we see with coronagraphs are on the edge of the Sun, and pass the Earth's orbit 90 degrees (three months travel time) ahead of, or behind, the Earth. Therefore, coordinated measurements require either a spacecraft 90 degrees before or behind the Earth in its orbit, or a high resolution X-ray telescope which can identify against the Sun's disk ejections directed toward the Earth. Transient ejections from the Sun's corona are of interest not only because of their terrestrial effects, but also as an example of impulsive stellar mass loss. Mass loss processes affect many stars, and may have an important influence on whether they evolve to a quiet whimper or a final bang.



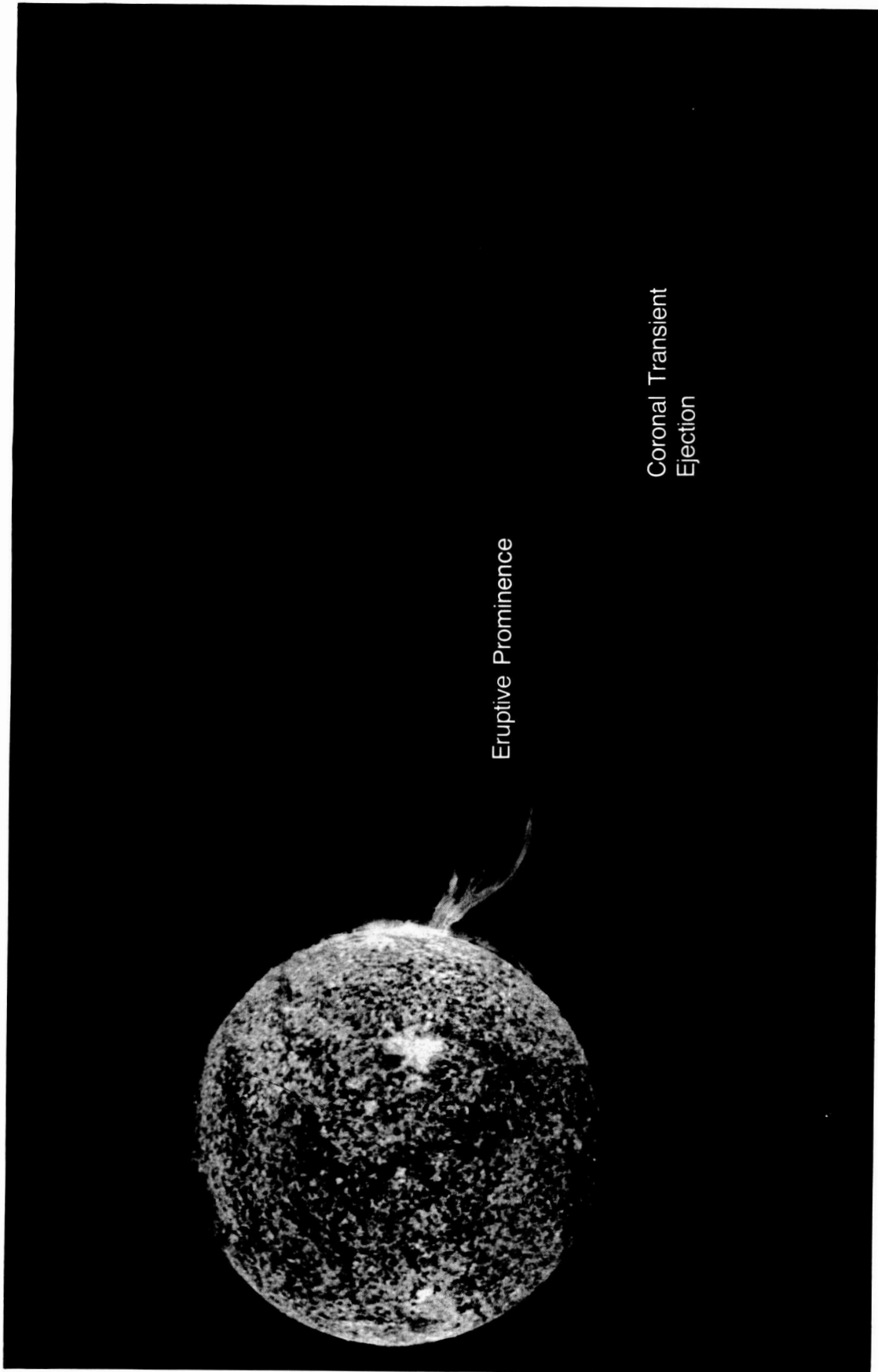

Eruptive Prominence

Coronal Transient  
Ejection

---

Coronal Transient Ejection - Observed from Skylab

# Why Does the Solar Constant Change?

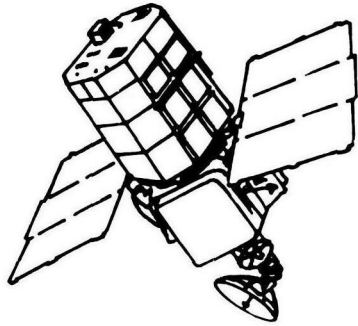

*Solar Maximum Mission — (SMM)*

While solar wind particles and flares have given us new knowledge of the Sun, the Sun's radiant energy remains the Earth's primary source of heat and light. The total of this energy (the "total solar irradiance") is about two calories per square centimeter per minute, meaning the Earth receives more than 100 trillion kilowatts of solar power. This total quantity has long been called the "solar constant" because no variations in total solar irradiance could be detected from beneath the Earth's changing atmosphere. Now, a very accurate radiometer on the Solar Maximum Mission (SMM) spacecraft has proved that the "solar constant" changes.

From SMM investigations, one type of change quickly recognized was a decrease in irradiance lasting about a week. It was found to correspond to, and to be explained by, the rotation of a large group of sunspots across the face of the Sun. This discovery was a surprise since it had been thought that the light blocked by sunspots would appear elsewhere on the Sun. Now we

must determine how, when, and where this missing energy appears.

Measurements have also detected a small but unmistakable decline in irradiance on a time scale of years. The decline is only one tenth of one percent in four years. But its importance may be appreciated by noting that if the Sun continued to dim at this rate, it would be left with only one half its current brightness in 2800 years. This decline has reversed with the beginning of the new solar cycle, starting in 1987, when the number of sunspots began to increase. We are searching for the source of this variation and studying how it affects our environment.

To further characterize and confirm these observations, the SMM radiometer will have to be supplemented by similar instruments on other spacecraft operating over many years. This investigation requires great patience, but it is justified by its great scientific and practical importance.

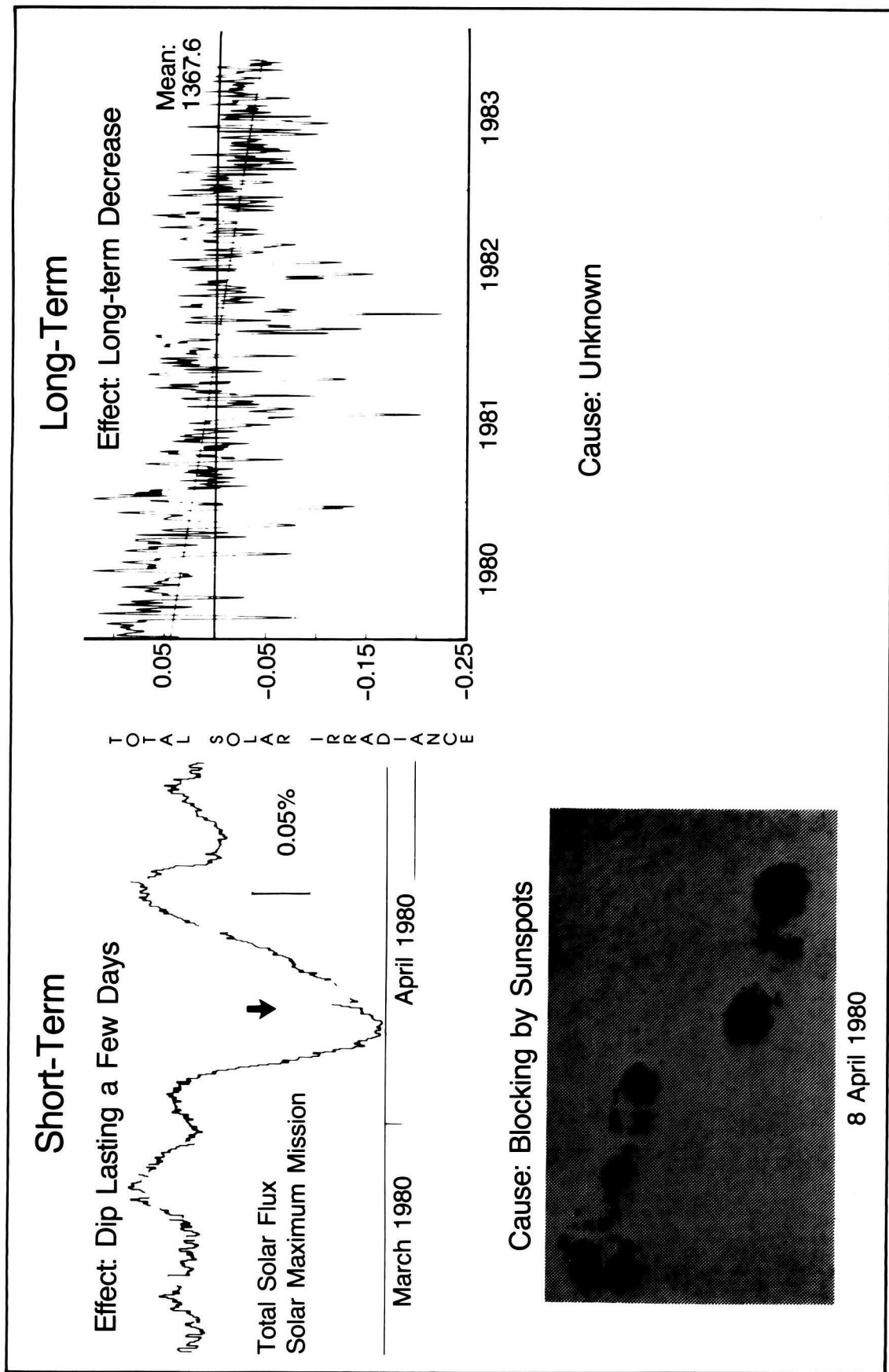

Variations in Total Solar Irradiance ("Solar Constant")

# Does the Changing Sun Change Our Weather or Climate?

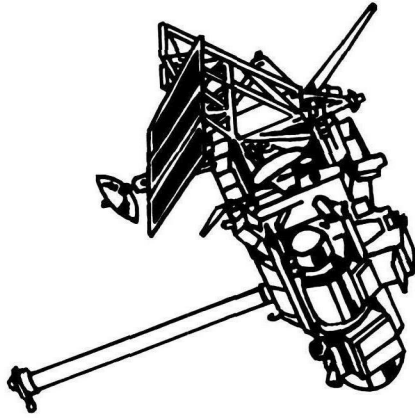

*Upper Atmosphere Research Satellite (UARS)*

The Sun is a variable star. It varies slightly its total energy output, and varies greatly its output of some forms of energy, including ultraviolet and X-rays, particles, and magnetic fields. This varying Sun is the energy source for our "weather engine." It provides heat, moves around air masses, and evaporates the water vapor which becomes precipitation. But our weather is so complex that we have until now been unable to prove that the changing solar output causes measurable changes in our weather.

Our ignorance persists in spite of years of investigation. Since the sunspot cycle was discovered in 1842, many investigators have looked for corresponding cycles in the Earth's weather. Some impressive correlations have been reported. For example, years with more sunspots correspond to increased rainfall at 70 to 80 degrees north latitude, and decreased rainfall at 60 to 70 degrees north latitude. But an apparent correlation at 50 to 60 degrees north latitude switched abruptly to anticorrelation, making a physical connection between the two phenomena unlikely, and casting doubt on all such correlations.

Recent studies have found stronger evidence that very long term solar variations affect our climate. For example, during the reign of the Sun King Louis XIV (1643-1715), there were very few spots on the Sun, and northern hemisphere temperatures were abnormally low. This trend is consistent with SMM data showing declining irradiance in years of declining sunspot number. There is thin but tantalizing evidence extending the connection between spots and climate backward for thousands of years.

While these correlations are impressive, this subject remains controversial because no physical mechanism has been found by which small changes in solar energy input can govern the large energy stored in the Earth's weather system. It is a situation akin to a flea biting an elephant; we are looking for a small input which produces a very large response. The search requires accurate measurements over an extended time period of all solar inputs to the Earth's environment. It is a labor of great patience which can be completed only from space.

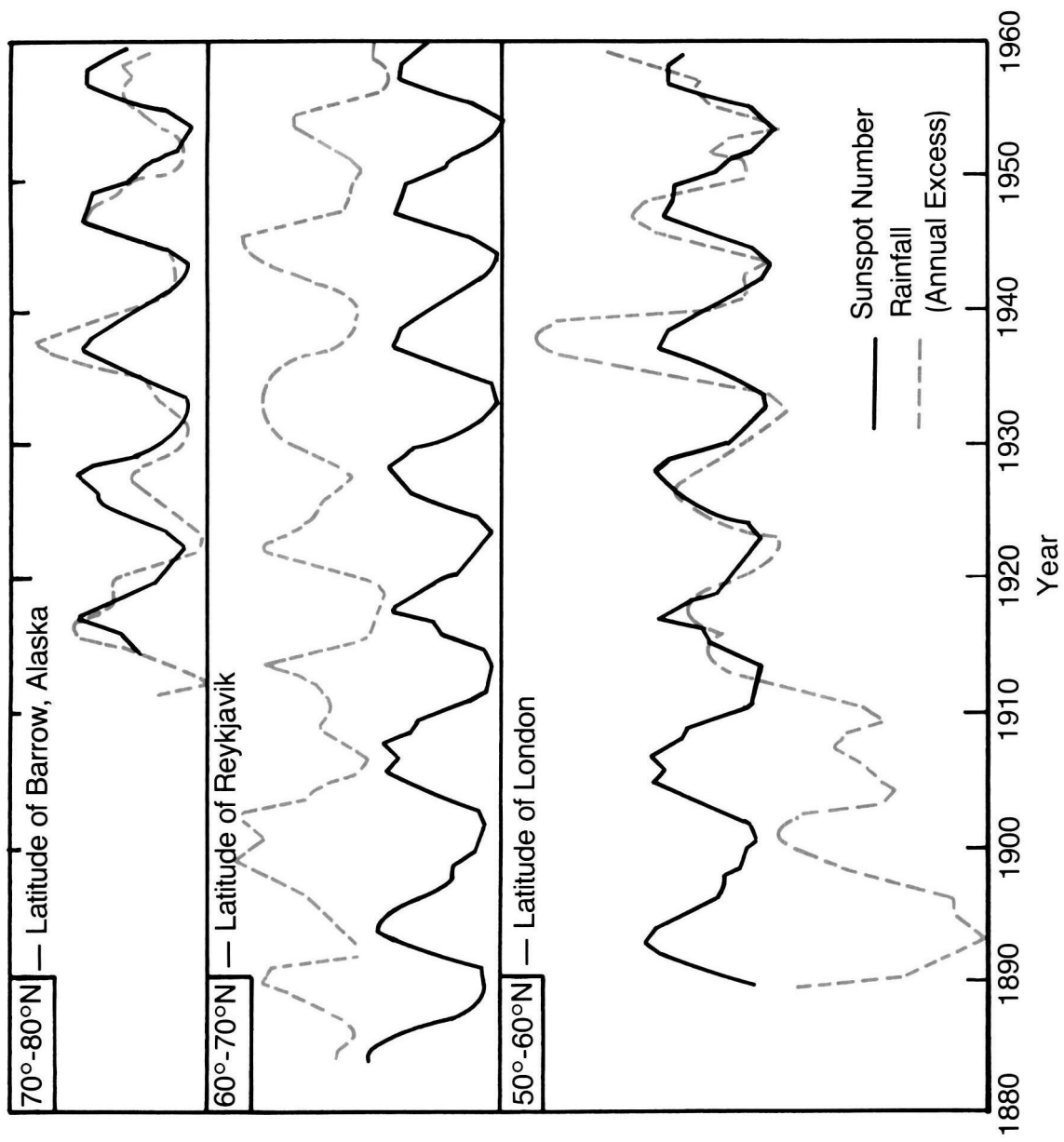

Solar Effects on Weather?

# The Future of Solar Physics

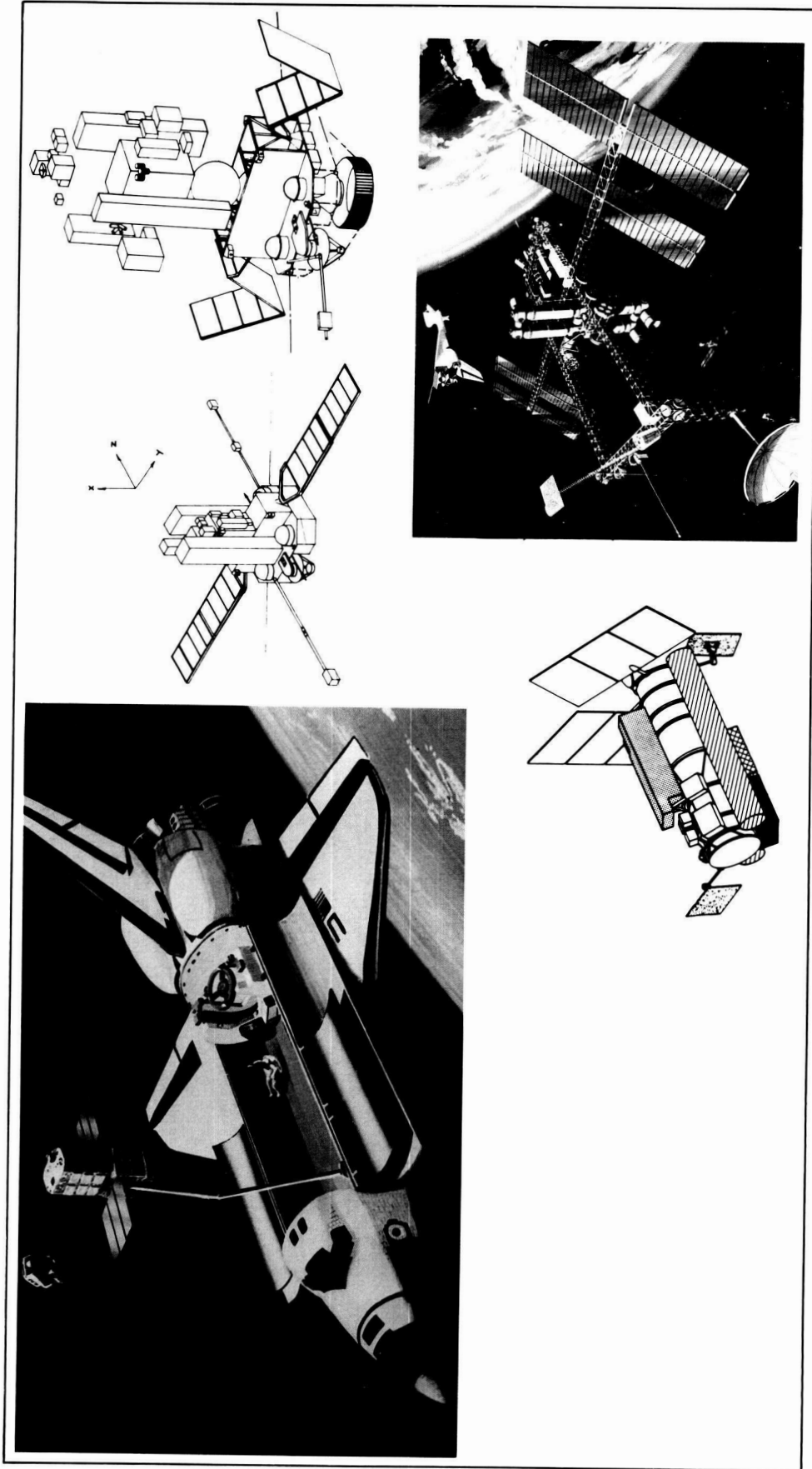

# Missions to Solve the Sun's Mysteries

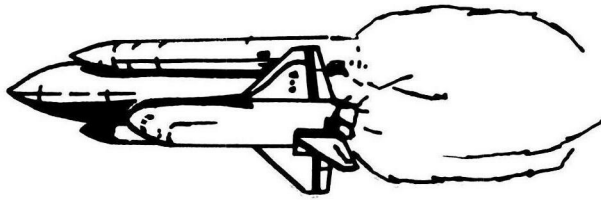

*Space Shuttle*

Solar scientists are justifiably excited about the unsolved problems of modern solar physics. These problems are diverse, extending over a wide range of conditions and phenomena. They are of fundamental importance for astrophysics, geophysics, and plasma physics. And most exciting is the availability of technology which brings the solution of these problems within our reach.

Space-based missions, with their expanded spectral coverage and improved spatial resolution, will continue to play a vital role in the investigation of these problems. It is revealing to describe likely key components of the solar space program and to assess their contribution to solving the Sun's mysteries.

- A one-meter diameter space telescope operating at visible, ultraviolet, and infrared wavelengths is needed to resolve fine structure magnetic fields and gas motions. Interactions between these fields and gases drive the magnetic dynamo, solar activity, and coronal heating.
- To study flare processes, we need a new generation of improved resolution detectors of X-rays, gamma rays, and energetic particles.

- A helioseismology observatory should be placed in a solar orbit between Earth and Sun where there are no day-night interruptions or large line-of-sight motions.
- A spacecraft using a swingby of Jupiter to escape the Earth's orbital plane (the ecliptic) is needed to measure the solar wind over the Sun's poles. (This spacecraft, *Ulysses*, is ready for launch.)
- Flights on balloons and rockets are ideal for new instrument development. Balloon-borne instrument packages can be ready for flight before the next solar maximum (1991).
- Many instruments developed earlier will be included in the Advanced Solar Observatory. It will be mounted on the Space Station, offering great advantages for instrument maintenance or incremental upgrades as new observing techniques become available or new solar problems are discovered.

Problem Addressed	High-Resolution Optical	High-Energy Observatory	Sun-Orbiting Observatory	Out-of-Ecliptic	Rockets-Balloons	Integrated Observatory
Solar Neutrinos						
Magnetic Fields						
Coronal Heating						
Flares						
Coronal Holes						
Polar Solar Wind						
Coronal Ejections						
Solar "Constant"						
Solar Weather Changes						
The Unknown						

Importance of Contribution  Primary  Secondary

Current and Planned Space Solar Physics Missions



# The Sun: Pathfinder for Astrophysics

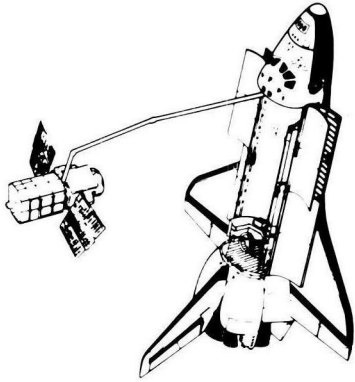

*SMM Repair Mission*

What part does the Sun play in modern astrophysics? Not only is it unique among astronomical objects because of its practical importance, but it is an object of great scientific importance as well. The Sun's proximity has permitted the discovery of such phenomena and processes as rotation, flares, spots, chromospheres, and coronae, paving the way for similar discoveries throughout astrophysics. Similarly, tools and techniques developed for use on the Sun have often found subsequent application in non-solar astrophysics. Solar precedence is not universal (radio waves from the galaxy were detected before those from the Sun), but it is typical because the abundant fluxes of various forms of energy we receive from the Sun are much easier to detect and analyze than the fluxes from distant stars or galaxies.

Current plans presage a continuation of this fruitful symbiotic relationship. The development of imaging X-ray optics for Skylab provided experience and confidence essential for the Einstein Observatory and for the future Advanced X-Ray Astrophysics Facility. Skylab also demonstrated the utility of simultaneous multispectral observation, a concept non-solar

astrophysics will apply with the Great Observatories Program. The successful repair in orbit of the Solar Maximum Mission spacecraft has demonstrated the feasibility of instrument and spacecraft maintenance in space. This maintenance capability has significantly influenced the design of the next generation of space astronomical missions.

Non-solar astrophysics also anticipates broad application of the answers to such current questions in solar physics as the neutrino problem and magnetic field behavior. The observational connection is summarized by Robert Rosner, theoretical astrophysicist at the Harvard College Observatory: "Solar observations can often be used both to constrain the physics and to suggest the appropriate observational tools: thus the Sun and its environs provide us with a directly observable laboratory for studying magnetohydrodynamics and plasma physics on astrophysical scales."

## Tool or Technique      Application to Astrophysics

	Solar	Non-Solar
Visible Spectroscopy	1802	1870's
Radio Wave Observations	1942	1932
Ultraviolet Observations	1949	1956
X-Ray Spectra	1949	1973
X-Ray Imaging	1963	1973
Simultaneous Multispectral Observations	1973	?
Manned Orbiting Observatory	1973	?
Instrument Repair in Orbit	1973	?

**ORIGINAL PAGE  
COLOR PHOTOGRAPH**

# Solar Research: A New Era Ahead

Solar physics crossed an important threshold when instruments capable of observing the Sun were first lifted above our atmosphere. An age of accelerated discovery ensued, aided by continued improvements in the size and quality of spaceborne instruments and the duration of their operation. This progress points to an important future milestone—the assembly of the Advanced Solar Observatory on the Space Station. It will include a full spectrum of advanced instruments operating from space but with opportunities for periodic servicing or evolutionary upgrading which are now available only for ground-based instruments.

To exploit coming opportunities like the Space Station, solar physics must continue its advances in instrument development, observational techniques, and basic theory. Even when the Advanced Solar Observatory becomes a reality, it will not eliminate the need for other space-based observations any more than they have eliminated the utility of observations from

the ground. For example, other space missions will be needed for instrumentation development and to exploit the advantages of unique orbits (for example, orbits out of the ecliptic or between Earth and Sun).

It is appropriate that solar physics be included as a major participant on the Space Station. Not only do the Sun's light and other emissions affect us in diverse ways, but our study of the Sun continues to shed light throughout astrophysics and other disciplines. In the words of Eugene Parker of the University of Chicago: "The observed behavior of the Sun defies theoretical understanding, and therein lies the future of solar physics. Indeed, it is the future of all stellar physics, for a dilemma posed by the Sun is a dilemma for all stars otherwise too distant to be properly studied. The Sun, after several decades of scrutiny, has become as enigmatic as the quasar, but with the advantage that the mysteries can be intimately probed by new techniques and instrumentation..."

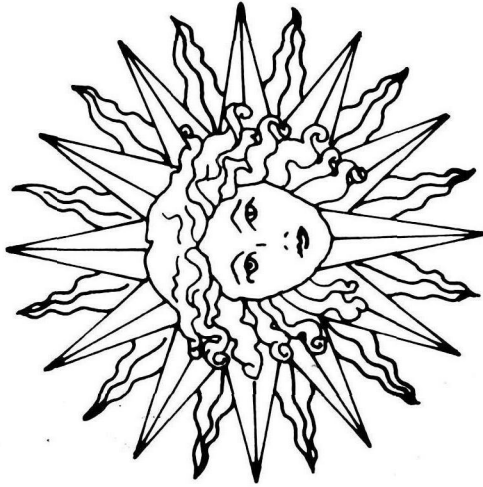

ORIGINAL PAGE  
COLOR PHOTOGRAPH

ORIGINAL PAGE  
COLOR PHOTOGRAPH

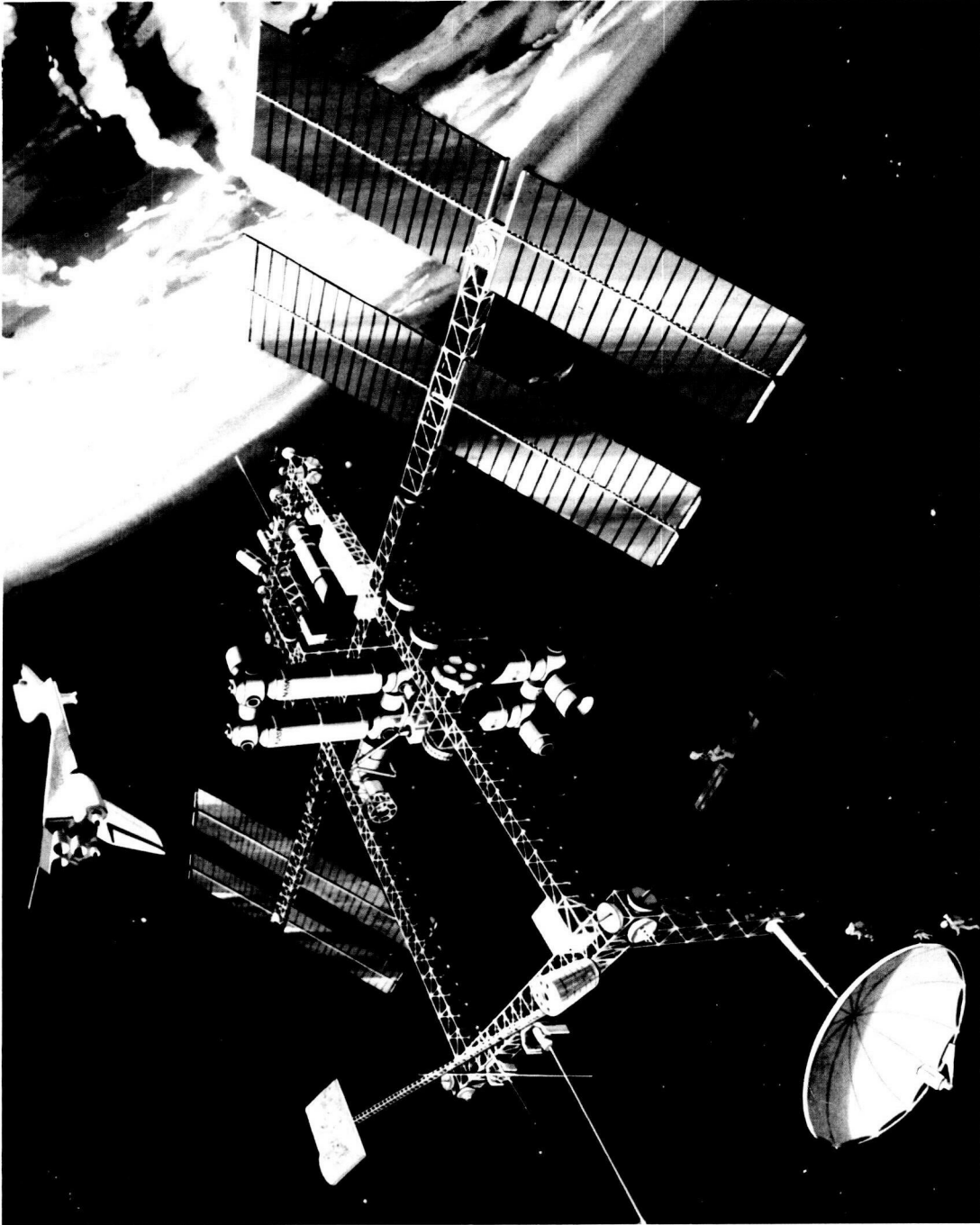

A New Era of Solar Research - Advanced Solar Observatory Mounted on Space Station (Extreme Left End of the Beam Structure)