

N87-11190

DEMONSTRATION TEST OF BURNER LINER STRAIN MEASUREMENTS  
USING RESISTANCE STRAIN GAGES

Howard P. Grant and Wilbur L. Anderson  
United Technologies Corporation  
Pratt & Whitney

SUMMARY

This program includes a demonstration test of burner liner strain measurements using resistance strain gages as well as a feasibility test of an optical speckle technique for strain measurement. The strain gage results are reported. Ten Kanthal A-1 wire strain gages were used for low cycle fatigue strain measurements to 950K and  $2000 \times 10^{-6}$  strain on a JT12D burner can in a high-pressure (10 atmospheres) burner test at the United Technologies Research Center under NASA Contract NAS3-23690 (ref. 1). The United Technologies Program Manager was Dr. Karl A. Stetson; the NASA Project Manager was Frank W. Pollack.

The procedure for use of the strain gages was developed under a previous contract, NAS3-22126 (ref. 2), and involved extensive pre-calibration and post-calibration to correct for cooling-rate dependence, drift, and temperature effects of about  $6000 \times 10^{-6}$  apparent strain. Results were repeatable within  $\pm 200 \times 10^{-6}$  to  $\pm 600 \times 10^{-6}$  strain, with best results during fast decels from 950K. (Scatter was worst during decels from lower temperatures and during slow decels.) The results agreed with analytical prediction based on an axisymmetric burner model, and results indicated a non-uniform circumferential distribution of axial strain, suggesting temperature streaking.

BACKGROUND

The measurement of local strain with wire resistance strain gages of less than 6 mm gage length in engine hot section testing at elevated temperatures during cycling from idle to high-power conditions has typically been limited to strain gage temperatures below 670K (750°F). At higher temperatures, stability and repeatability of strain gage electrical resistance deteriorates. The deterioration is due either to resistance drift in the gage alloy with time at temperature because of continuous or reversible formation of oxides, intermetallic compounds, or other metallurgical phases (including lattice order-disorder changes) or due to large resistance change with temperature (high temperature coefficient of resistance, tcr).

For low tcr, the metal alloy must be complex, but complex alloys tend to be unstable at high temperatures. The gage resistance then depends not only on temperature but also on cumulative time at temperature and on heating rates and cooling rates during engine accelerations and decelerations. One way to extend the use of wire strain gages above 670K is to recognize the dependence on the additional variables (especially the rate of temperature change during heat-up and cool-down) in the calibration and use of the gages. The effect of these variables on Kanthal A-1 wire was examined in detail during bench tests as part of a previous contract, NAS3-22126. Kanthal A-1 is an iron-chromium-aluminum alloy long used for high-temperature electrical heating elements because of its durability. It has been tested by several investigators (notably Bertodo, reference 3, and Lemcoe, reference 4) as a possible strain gage candidate.

Rules were developed to extend the use of these gages to about 980K (1300°F):

- (1) Measure strain during fast cool-down only (less than one minute) to minimize rate-dependent apparent strains.
- (2) The temperature is not to exceed 980K (1300°F) at any time.
- (3) Precondition by baking at least one hour at 980K (1300°F).
- (4) Monitor temperature with an adjacent thermocouple.
- (5) Precalibrate apparent strain during fast temperature cycles. To do this, install the gages on a piece cut from the burner liner; measure apparent strain due to temperature during fast isothermal cycles (strain-free except for uniform thermal expansion); and then weld the instrumented piece back into the burner liner. This procedure is described in greater detail below.

### BURNER TEST CONFIGURATION

A version of a burner can designed for the Pratt & Whitney JT12D engine was selected for the test (fig. 1). Methods of analysis for predicting strain had been developed under contract NAS3-21836 (ref. 5) at Pratt & Whitney for this type of burner structure (fig. 2). Some outside liner temperatures were documented in previous tests (fig. 3). Locations A, B, and C (fig. 1) in the vicinity of the third knuckle of the burner can were selected for strain measurement. The test consisted of seven cycles of burner operation using jet engine fuel, each cycle consisting of an acceleration (caused by an increase in fuel flow rate) from idle to high-power in about one minute, dwell time at the operating point for a minute or two, and a deceleration to idle in about a minute. Strain gage data was reduced for the fast deceleration portion of the cycle only.

### STRAIN GAGE INSTALLATION

The Kanthal A-1 wire static-strain gages were installed using the flame-spray aluminum-oxide precoat and SermeTel (TM) P-1 ceramic cement overcoat technique (fig. 4) developed in the previous contract NAS3-22126. Application of the cement is a critical step. If the gage wire is not thoroughly cleaned, or the cement layer is too thick, the result could be a partially bonded gage with internal voids, or a completely unbonded gage floating inside a cement envelope.

Ten Kanthal A-1 gages and seven Type K (Chromel-Alumel) thermocouples were installed on the piece cut from the burner can (fig. 5). This arrangement provided axial and hoop strain measurements on the weld flange and at a location aft of the knuckle, and hoop strain only on the knuckle. The thermocouple junctions were formed of 0.13 mm diameter bare thermocouple wires welded together (but not welded to the burner can) and embedded in the ceramic cement. Figures 6, 7, and 8 are photographs of the can with piece removed, the instrumented piece, and the can with the instrumented piece reinstalled by tungsten inert gas weld.

## STRAIN GAGE CALIBRATION

Before the combustor tests, apparent strain tests were run on the ten Kanthal A-1 gages on the piece cut from the burner can. The piece was installed in the can and the combustor tests were run. Then the piece was again cut from the can and many more apparent strain tests were run. Table 1 lists pertinent details of these calibration tests. Figure 9 is an example of the resistance behavior of a Kanthal A-1 strain gage on the piece cut from the burner can (gage no. 2) during fast and slow cool-downs from various temperatures. Smaller apparent strain is more typical during fast cool-down than during slow. Larger drift is more likely at temperatures in the 700K to 800K range than at 950K. The material memory is evident at temperatures near 950K (the gage always returns to a resistance value extremely close to the original) despite various drifts at the lower temperatures.

Calibration curves for each of the ten Kanthal A-1 gages on the burner can, and for eight Kanthal A-1 gages mounted on two gage-factor test bars (Figure 10) are presented in figures 11, 12, 13, 14, 15, and 16. In particular the results shown in figure 15 confirmed that the behavior of any one gage was repeatable from before to after the combustor tests. It is this repeatability that makes the use of Kanthal A-1 gages feasible. At 950K only one gage shows a difference larger than 250 parts per million in resistance change due to temperature. Table 2 lists the scaling factor showing the relative sensitivity to temperature for each gage. The factor varies from 0.93 to 1.08.

Gage factor versus temperature was measured for the eight gages on the two test bars. Gage numbers 1, 2, 3 on bar 1 were found to have low and erratic gage factors (fig. 17). Voids were found in the cement under the end loops of these three gages. The average gage factor of the remaining five gages was used to reduce the burner liner gage test data (fig. 18).

## COMBUSTOR TEST RESULTS

During the first test cycles in the high-pressure combustor rig the gages at location A (fig. 1) were accidentally over-temperated to 1040K (1400°F) and either failed or became erratic. The remaining six gages survived the entire test program and post-test calibrations. Typical results are presented in fig. 19, where all measurements obtained during the final four cycles of combustor test are summarized. The test conditions were about the same during each of these four cycles and are listed in Table 3.

At location B (fig. 1) on the knuckle the measured hoop strain was consistently in the predicted direction (tensile) with magnitude averaging about 80 percent of the predicted 1750 microstrain. During the final four cycles the two-sigma scatter was 268 microstrain.

At the aft location (C) (fig. 1) the measured hoop strain was consistently in the predicted direction (tensile) with magnitude larger than the predicted 355 microstrain by about 1000 microstrain. During the four cycles with gages 1 and 2, the two-sigma scatter of all measurements of hoop strain at this location was 314 microstrain. The two-sigma scatter for gage 1 alone was notably small: only 52 microstrain.

The axial strain increments measured were surprising. One gage (no. 7) consistently indicated an increment of about 700 microstrain in compression while the other gage (no. 8) consistently indicated an increment of about 1000 microstrain in tension. The predicted value was 1400 microstrain in compression. The repeatability of measurements with each gage was excellent (fig. 19). In fact, during the four cycles the two-sigma scatter for gage no. 7 was only 52 microstrain and for gage no. 8, 270 microstrain. The indicated difference in axial strain increment at the two locations is believed to be real, even though the temperatures at the two gage locations were the same. The difference may be a result of circumferential temperature gradients (streaks) at the liner lip inside the can.

#### CONCLUDING REMARKS

Strain gages made from Kanthal A-1 wire can be successfully employed in burner liner low-cycle fatigue strain measurements provided they are protected from temperatures higher than 980K. Careful attention to the application of ceramic cement is required to assure proper functioning of the gages. The individual gages, as installed on the test object, must be subjected to temperature calibration for apparent strain after a minimum of one hour preconditioning at 980K. The removal of a section of a burner for instrumentation and calibration makes this practical if the section can be welded back into place for subsequent testing. Strain measurements must be limited to strain change during rapid cooling of the test section in order to minimize apparent strain corrections and obtain best repeatability. More detailed comparison with computer modeling of strain fields will require more detailed mapping of temperature patterns.

#### REFERENCES

1. Contract NAS3-23690 final report.
2. Contract NAS3-22126 final report.
3. Bertodo, R.: Resistance Strain Gauges for the Measurement of Steady Strains at High Temperatures. Proc. Instn. Mech. Engrs., v178, pt 1, no. 34, pg. 907, 1964.
4. Lemcoe, M. M.: Development of Electrical Resistance Strain Gage System for Use to 2000°F. ISA Paper 75-572, 1975.
5. Moreno, V: Combustor Liner Durability Analysis. NASA Report CR-165250, NAS3-21836, February 1981.

TABLE 1

RESISTANCE CHANGE VERSUS TEMPERATURE, FOR GAGES ON THE BURNER LINER.  
 TESTS 1 THROUGH 8 WERE CONDUCTED BEFORE THE HIGH PRESSURE BURNER TESTS,  
 AND TESTS 9 THROUGH 40 AFTER.

Test No.	Max. Temp. T3 (K)	Approx. Dwell Time at T3 (Minutes)	Cooling Time t <sub>x</sub> T1 to T2 (Sec)	T1 (K)	T2 (K)	T <sub>1</sub> -T <sub>2</sub> / t <sub>x</sub> (K/sec)	$10^6 (r_{T1} - r_{T2}) / [R_o (T1-T2)]$						
							parts per million per Kelvin						
							Gage 1	Gage 2	Gage 3	Gage 4	Gage 5	Gage 7	Gage 8
1	950	10	12.8	811	-727	6.54	57.9	59.3	62.4	56.5	61.9	61.0	58.8
2	950	10	14.2	811	727	5.92	72.7	68.7	72.0	66.4	68.4	65.3	62.4
3	950	10	13.7	811	727	6.12	64.4	67.6	67.7	60.6	63.1	58.8	57.9
4	950	10	18.2	811	727	4.62	75.0	70.9	72.2	73.4	77.6	73.9	70.9
5	950	10	95.2	811	727	.88	85.8	84.0	89.1	88.1	87.1	86.0	90.9
6	950	10	26.4	811	727	3.19	75.2	70.7	76.7	72.2	78.3	70.4	71.1
7	950	10	54.4	811	727	1.54	80.3	78.1	83.3	81.4	82.2	80.3	82.9
8	950	10	11.1	811	727	7.55	63.9	62.5	67.2	64.6	70.4	69.6	66.7
9	950	10	12.0	811	727	6.98	63.2	62.2	68.4	58.4	67.8	57.4	57.6
10	950	10	13.1	811	727	6.41	59.4	61.2	61.4	53.9	61.3	55.6	59.3
11	950	10	16.6	811	727	5.05	70.1	73.2	74.0	70.1	76.9	63.1	63.3
12	950	10	22.2	811	727	3.79	74.8	77.4	75.3	78.1	83.9	70.8	74.1
13	950	10	30.5	811	727	2.76	80.9	82.1	79.4	82.4	82.6	76.3	78.7
14	950	10	57.6	811	727	1.46	81.5	74.3	83.3	77.1	94.8	80.4	78.7
15	950	10	38.9	811	727	2.16	79.5	76.9	81.1	81.0	89.2	78.9	81.6
16	950	10	12.2	811	727	6.89	59.3	59.4	62.0	60.7	70.2	64.7	65.4
17	819	10	20.0	811	727	4.21	68.7	65.5	65.8	68.8	80.8	65.6	72.1
18	819	20	18.6	811	727	4.53	66.0	65.0	66.4	70.1	83.1	66.9	74.0
19	819	10	113.6	811	727	.74	89.6	90.4	94.5	91.4	103.5	88.6	93.5
20	819	10	19.1	811	727	4.40	66.2	64.8	66.1	69.6	81.9	66.1	72.4
21	819	20	18.0	811	727	4.66	66.6	65.1	66.0	68.4	79.8	64.5	70.9
22	733	10	12.6	733	700	2.63	32.1	29.6	34.8	35.5	52.1	45.2	62.1
23	733	20	9.7	733	700	3.42	31.1	34.2	46.3	57.8	74.1	66.0	84.7
24	733	10	28.6	733	700	1.15	54.6	44.8	59.9	50.1	59.2	55.4	56.2
25	733	20	29.6	733	700	1.12	53.9	48.8	62.6	52.9	71.8	57.4	57.0
26	733	10	9.4	733	700	3.51	30.3	33.6	48.1	52.2	62.6	59.5	74.7
27	733	20	14.7	733	700	2.24	58.8	58.8	64.0	72.1	94.5	71.7	81.4
28	950	10	4.0	811	727	21.21	71.4	69.7	73.4	72.8	82.7	61.1	61.9
29	783	10	19.8	780	700	4.04	43.2	38.0	45.2	45.5	56.2	42.2	52.8
30	783	20	19.7	780	700	4.06	38.8	35.1	39.3	41.5	56.9	50.6	63.6
31	783	10	69.8	780	700	1.15	56.9	54.3	63.9	58.0	70.5	57.3	61.3
32	783	10	18.4	780	700	4.35	45.4	41.5	43.5	50.8	65.6	56.2	70.9
33	1041	10	27.3	1037	819	7.99	29.3	28.3	31.2	34.4	37.2	37.0	44.4
34	1041	10	105.4	1037	819	2.07	30.4	29.0	32.9	31.1	41.3	32.4	36.7
35	1041	10	264.3	1037	819	.89	28.0	30.3	36.0	29.3	41.0	18.7	23.4
36	1041	10	145.3	1037	819	1.50	29.3	39.7	35.8	38.2	35.9	16.1	24.4
37	1041	10	37.4	1037	819	5.83	44.9	46.8	46.7	52.8	57.2	35.3	42.2
38	1041	10	92.2	1037	819	2.36	42.7	44.0	45.1	48.8	55.2	31.4	36.8
39	1041	10	67.5	1037	819	3.23	42.2	45.0	44.8	48.5	56.3	31.4	38.1
40	1041	10	19.5	1037	819	11.17	32.8	29.3	33.6	31.3	26.7	27.6	37.9

TABLE 2

VALUES OF SCALING FACTOR C

Component	Gage No.	C
Burner Liner	1	0.95
Burner Liner	2	1.00
Burner Liner	3	1.08
Burner Liner	4	1.01
Burner Liner	5	1.02
Burner Liner	6	0.99
Burner Liner	7	0.93
Burner Liner	8	1.03
Burner Liner	9	1.03
Burner Liner	10	0.95
Test Bar 1	1-1	1.03
Test Bar 1	1-2	1.02
Test Bar 1	1-3	0.99
Test Bar 1	1-4	1.04
Test Bar 2	2-1	0.99
Test Bar 2	2-2	1.02
Test Bar 2	2-3	1.00
Test Bar 2	2-4	1.01

$$C = [(R_{950K} - R_{min})/R_{min}]/0.0165,$$

where  $R_{950K}$  and  $R_{min}$  are measured during rapid cooling from 950K ( $t_c = 12$  seconds).

TABLE 3

COMBUSTOR TEST TYPICAL STRAIN GAGE DATA AND ANALYSIS

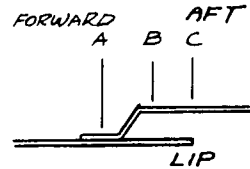
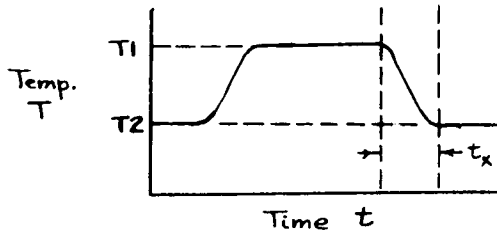

Cycle No. 6  
 Burner Run No: 5  
 Cum. Time At T1: 22 min.  
 Cooling time  $t_x$ : 15 sec.  
 (TT4)<sub>1</sub> 1255K  
 (TT4)<sub>2</sub> 955K  
 TT3 710K

P = 9 ATM.

Location	C				B		A		LIP
	HOOP	HOOP	AX.	AX.	HOOP	HOOP	AX.	- -	
Orientation	1	2	7	8	3	5	9	- -	
Gage No.	51	52	51	52	53	55	55	57	
Thermocouple No.	761	761	761	761	777	1041	1041	1072	
T1	(K)	722	722	722	722	819	819	833	
T2	(K)	722	722	722	722	819	819	833	
$10^6 (T_1 - T_2)/t$ (K/sec.)	2.60	2/60	2.60	2.60	3.67	14.8	-	-	
$10^6 (r_{T1} - r_{T2})/R^0 G$	49.8	46.4	53.4	61.6	46.1	14.1	-	-	
$10^6 (r_{T1} - r_{T2})/R^0 G$	956	891	1025	1182	1255	1728	-	-	
$10^6 (E_1 - E_2) K/B^1$	1970	2069	296	2118	2427	3476	-	-	
$10^6 (G_1 - G_2) e_2/G_1$	3	3	-10	-10	21	-16	-	-	
$e_1 - e_2$ (Equ. 1, Microstrain)	1011	1175	-719	946	1151	1764	-	-	

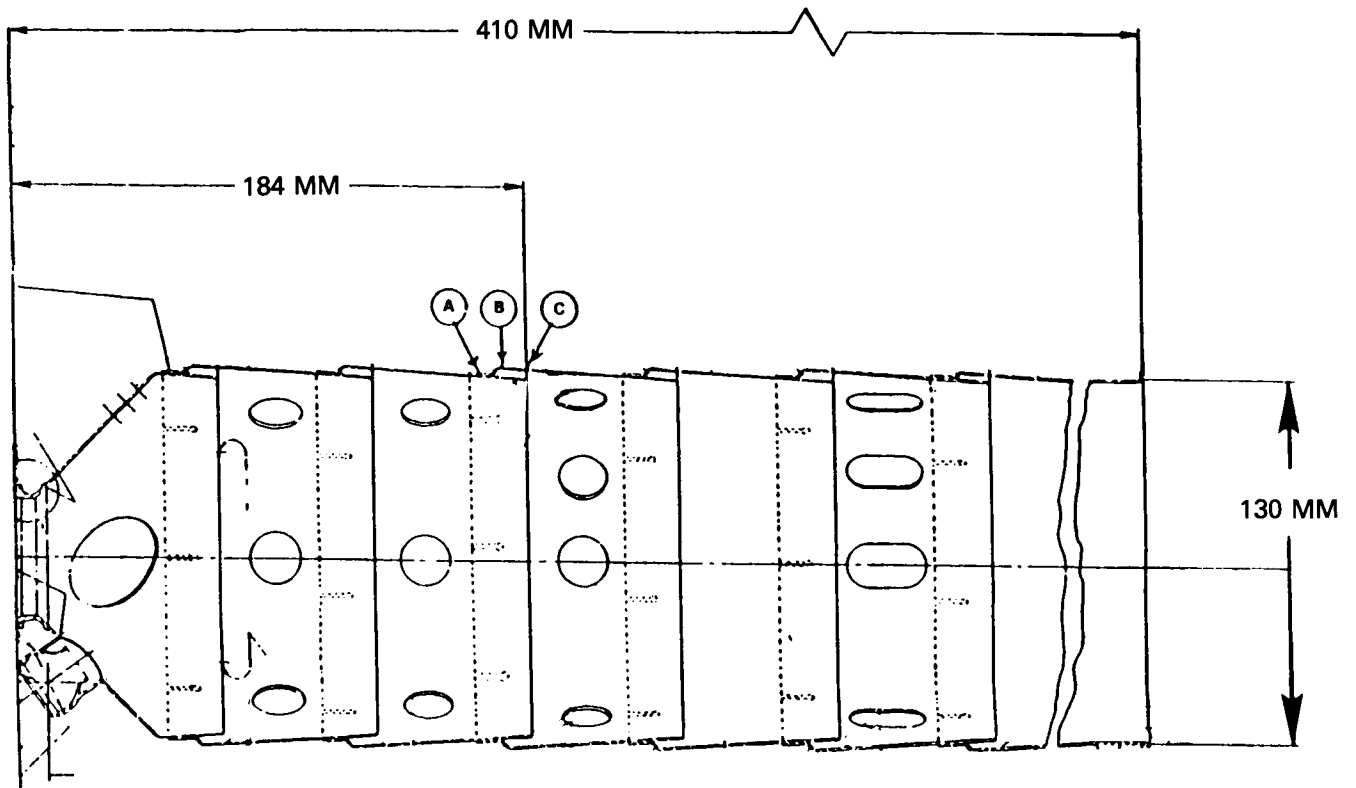

Figure 1 JT12D Burner Liner

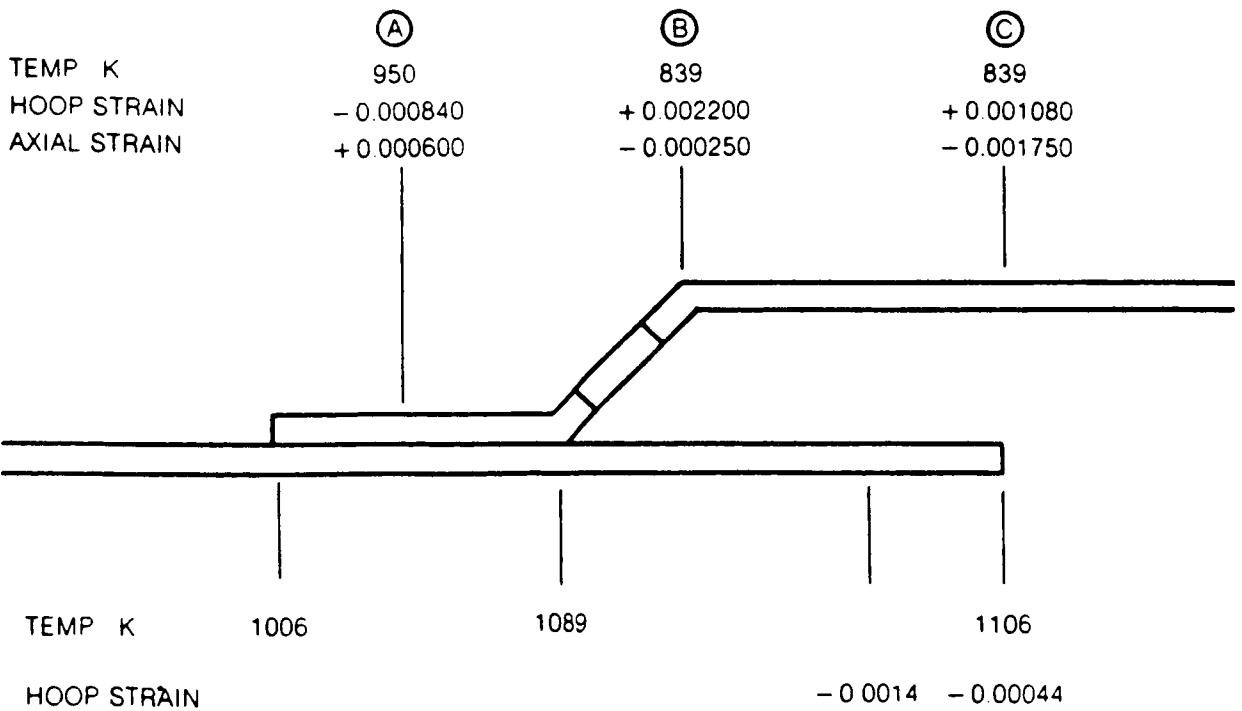

Figure 2 Strains Estimated For JT12D Burner Liner in Vicinity of Third Knuckle

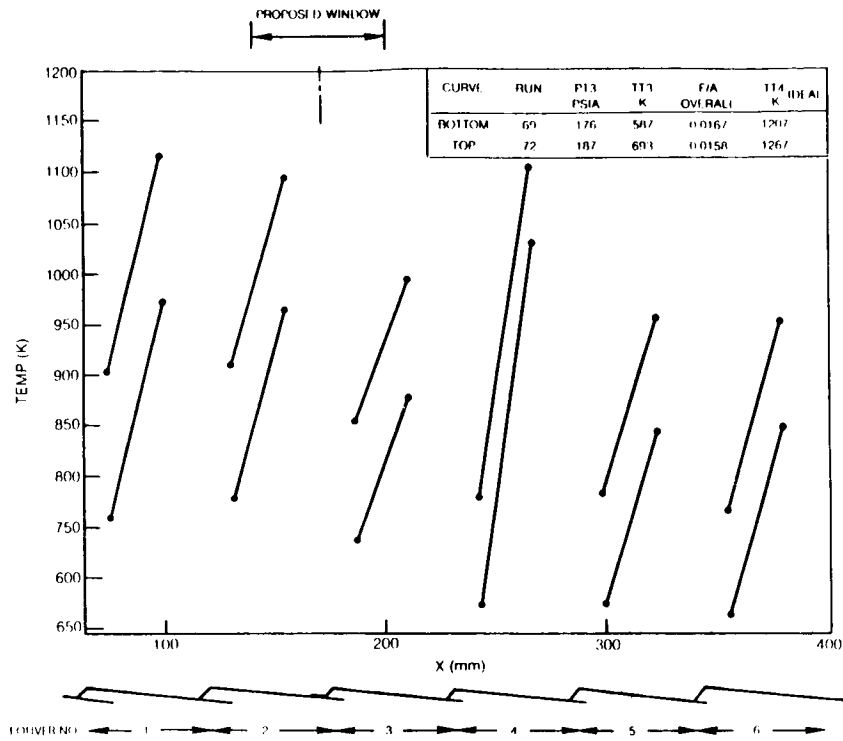
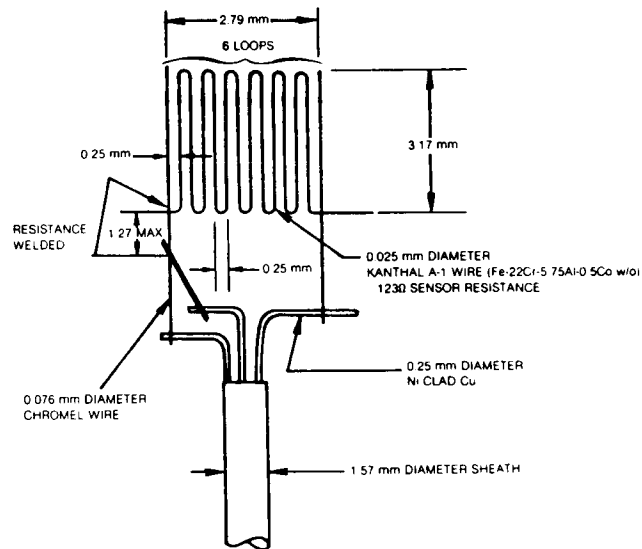

Figure 3 Surface Temperature Profiles Previously Measured on JT12D Burner Liner



**INSTALLATION**

SURFACE PREPARATION: Ni-Cr-Al (METCO 443) FLAME SPRAYED, ABOUT 0.127 mm THICK  
 PRECOAT: Al<sub>2</sub>O<sub>3</sub> (ROKIDE 11H) FLAME SPRAYED, ABOUT 0.127 mm THICK  
 OVERCOAT: AlP<sub>4</sub> (SERMETAL P-1) CERAMIC CEMENT, ABOUT 0.127 mm THICK  
 EXTENSION LEADS: 3c Ni-CLAD Cu WIRE WITH 1.57 mm DIAMETER  
 S/S SHEATH AND 0.025 mm DIAMETER CONDUCTORS  
 CABLE IS STRAP WELDED TO SUBSTRATE AND SPLICES  
 ARE BRAZED WITH MICROBRAZE 50 (AWS BNi-7)

Figure 4 Gage Installation



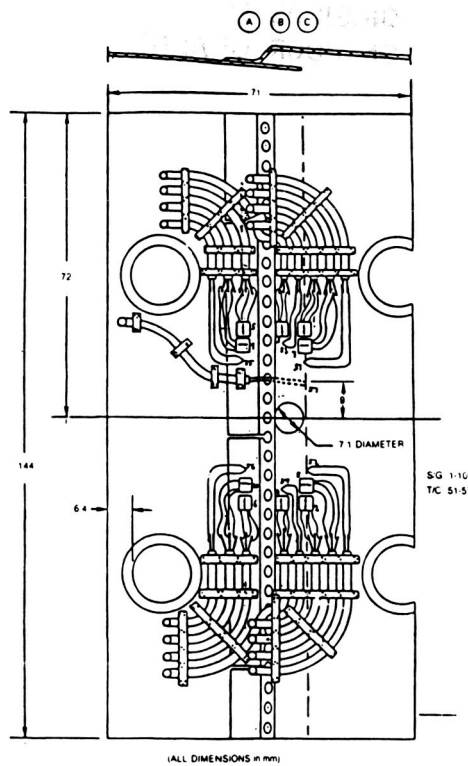

ORIGINAL PAGE IS  
OF POOR QUALITY

Figure 5 Strain Gage & Thermocouple Locations

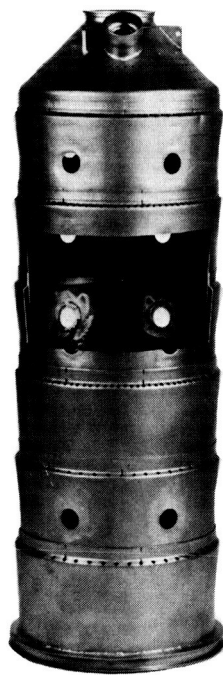

Figure 6 Burner Can with Section Cut Out

ORIGINAL PAGE IS  
OF POOR QUALITY

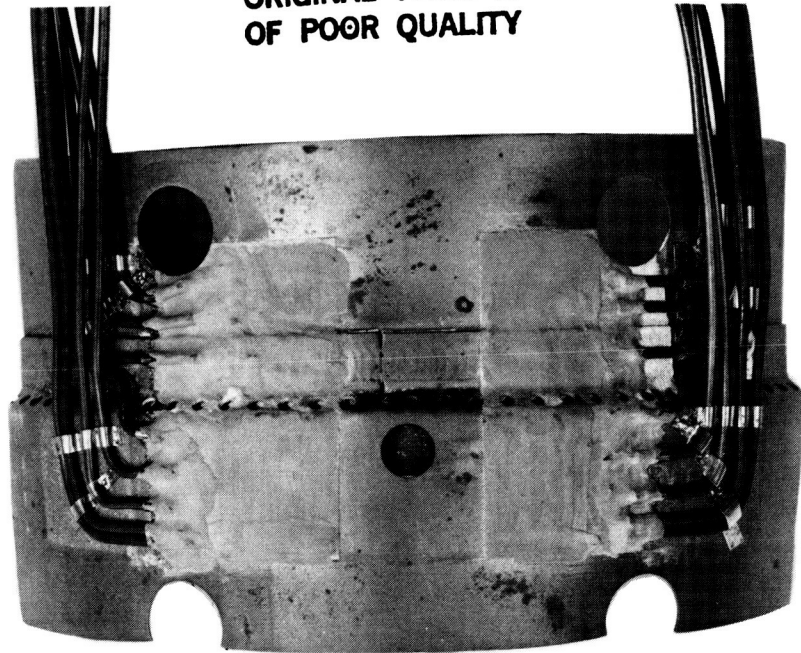

Figure 7 Instrumented Section of Burner Can

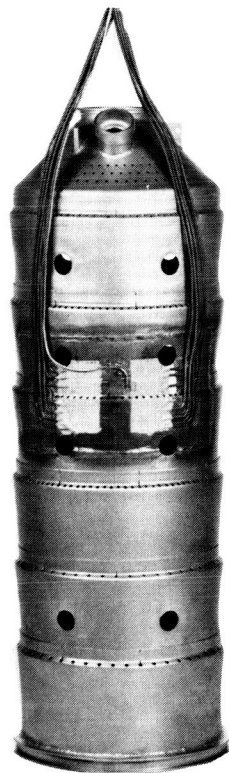
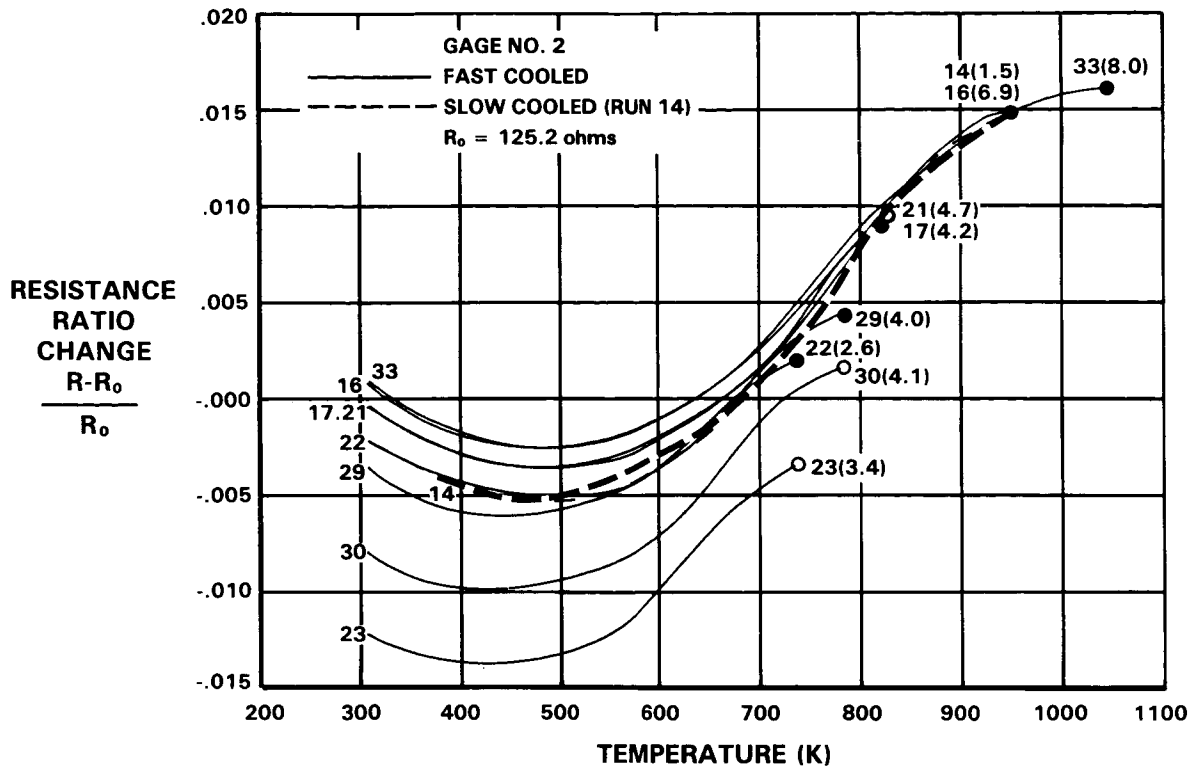

Figure 8 Burner Can with Instrumented Section Reinstalled



RESISTANCE RATIO CHANGE VERSUS TEMPERATURE OF KANTHAL A-1 STRAIN GAGE NO. 2 DURING RAPID COOLING FOR VARIOUS STARTING TEMPERATURES AND VARIOUS DWELL TIMES AT THE STARTING TEMPERATURE. A SOLID SYMBOL INDICATES DWELL TIME OF FIVE TO TEN MINUTES; AN OPEN SYMBOL INDICATES DWELL TIME OF TWENTY TO THIRTY MINUTES. THE NUMBER ON THE CURVE IS THE RUN NUMBER OF TABLE 1 AND THE NUMBER IN PARENTHESES IS THE COOLING RATE (K/SEC) IN THE 800K TO 700K RANGE.

Figure 9 Effect of Initial Temperature and Dwell on Change in Resistance Ratio

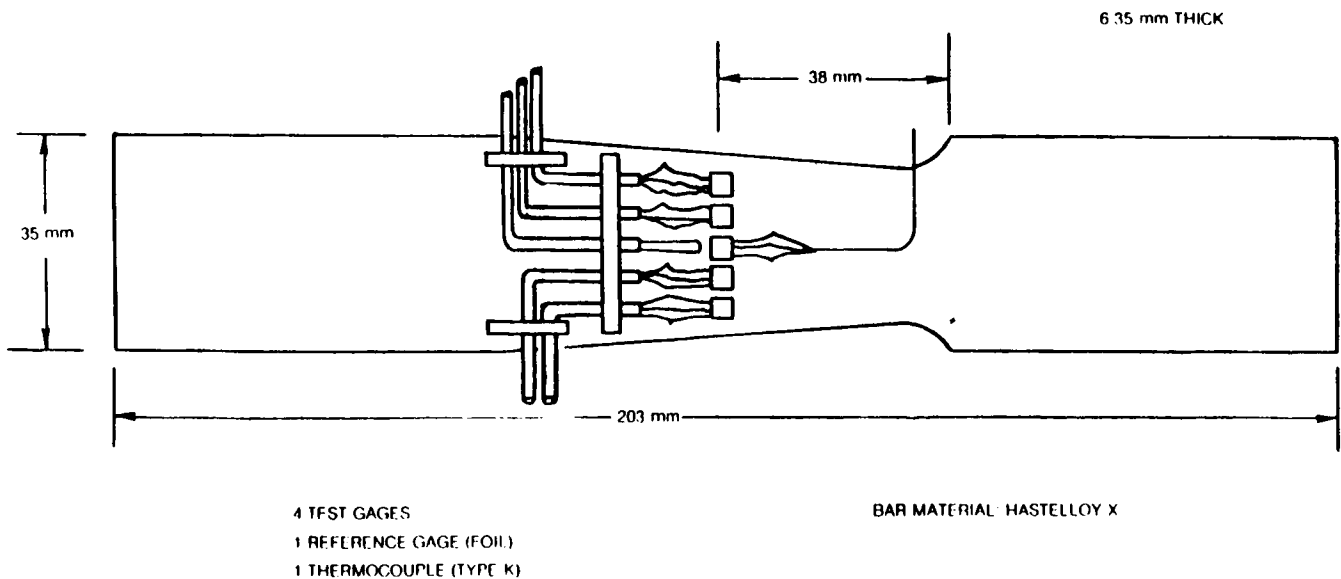
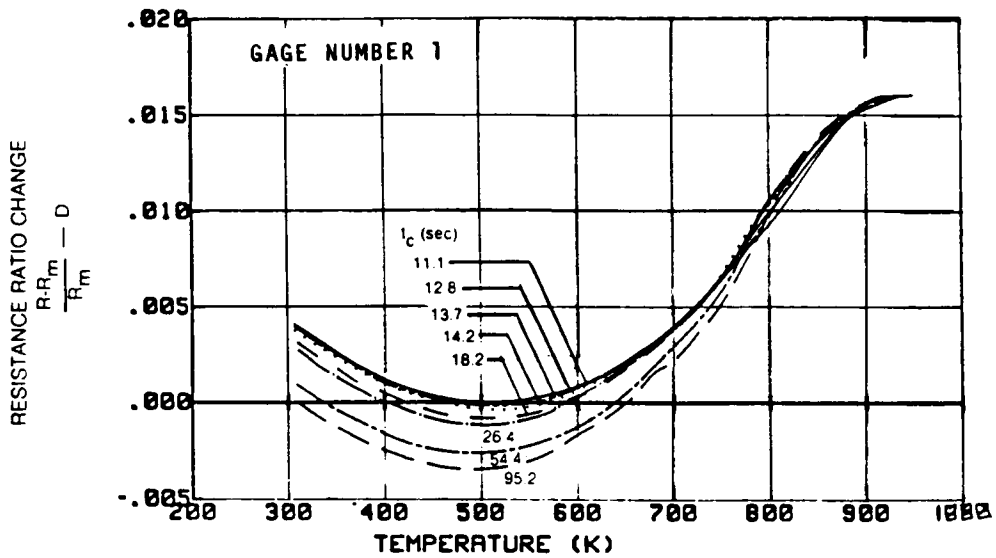

Figure 10 Gage Factor Test Bar



GAGE RESISTANCE RATIO CHANGE VERSUS TEMPERATURE FOR ONE GAGE ON THE BURNER LINER AT EIGHT COOLING RATES BEFORE THE COMBUSTOR TESTS. THE QUANTITY D IS AN ARBITRARY OFFSET ADJUSTMENT TO SUBTRACT THE EFFECTS OF SMALL DRIFTS AT 950K FROM ONE TEST TO ANOTHER SO THAT ALL CURVES PASS THROUGH THE SAME POINT AT 950K.

R = GAGE RESISTANCE  
 $R_m$  = MINIMUM RESISTANCE DURING FASTEST TEST ( $t_c = 12$  seconds)  
 $t_c$  = COOLING TIME FROM 811K (1000°F) TO 727K (858°F)

Figure 11 Gage Resistance Ratio for 8 Cooling Rates

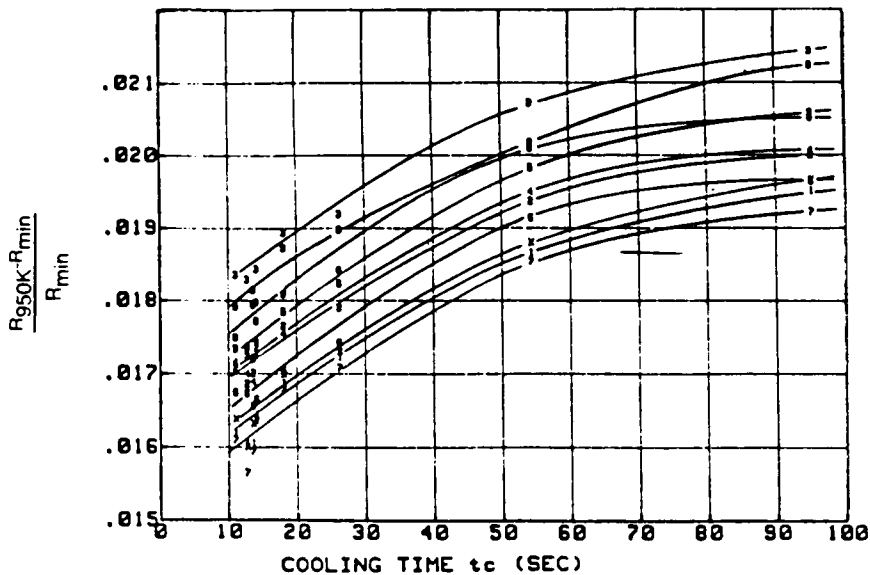

GAGE RESISTANCE CHANGE FROM 950K TO MINIMUM-RESISTANCE TEMPERATURE VERSUS  $t_c$ , THE COOLING TIME PARAMETER, FOR EACH OF THE TEN GAGES ON THE BURNER LINER DURING COOL-DOWN TESTS BEFORE THE COMBUSTOR TESTS.

$R_{950K}$  = GAGE RESISTANCE AT 950K  
 $R_{min}$  = MINIMUM GAGE RESISTANCE OBSERVED DURING EACH COOL-DOWN TEST

THE SYMBOL USED FOR EACH DATA POINT IS THE GAGE NUMBER FOR GAGES 1 THROUGH 9. SYMBOL X IS GAGE 10.

Figure 12 Gage Resistance Change Versus  $t_c$

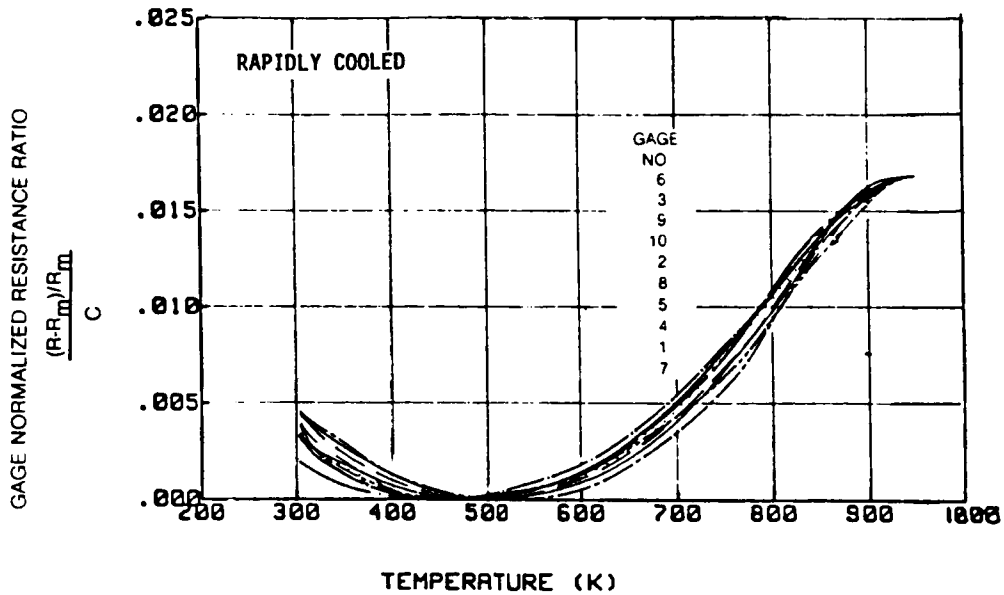

GAGE NORMALIZED RESISTANCE RATIO VERSUS TEMPERATURE DURING RAPID COOLING ( $t_c = 12$  seconds) FROM 950K FOR THE TEN GAGES ON THE BURNER LINER BEFORE THE COMBUSTOR TESTS.

R = GAGE RESISTANCE  
 $R_m$  = MINIMUM RESISTANCE IN EACH TEST  
 C = CALIBRATION CONSTANT FOR EACH GAGE

Figure 13 Normalized Gage Resistance Ratio for Combustor Gages Before Tests

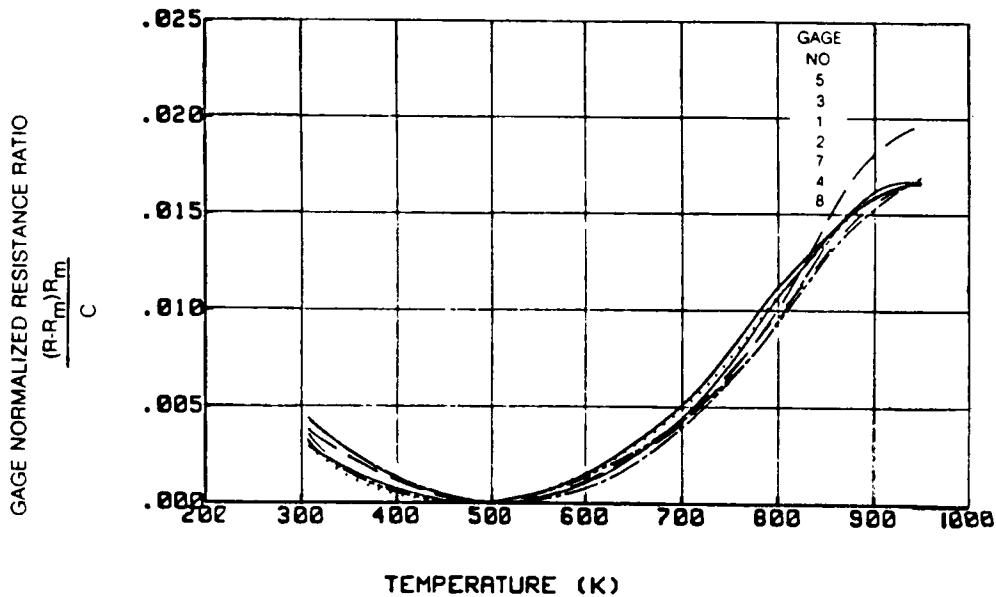

GAGE NORMALIZED RESISTANCE RATIO VERSUS TEMPERATURE DURING RAPID COOLING ( $t_c = 12$  seconds) FROM 950K FOR THE SEVEN GAGES ON THE BURNER LINER. AFTER THE COMBUSTOR TESTS THE CALIBRATION CONSTANT C FOR EACH GAGE IS THE SAME AS THAT USED IN FIGURE 13. THE RESULTS ARE ALL WITHIN THE ENVELOPE OF THE ORIGINAL CALIBRATION CURVES OF FIGURE 13 EXCEPT FOR GAGE NO. 5 WHICH EXPERIENCED OVER-TEMPERATURES TO 1041K DURING THE COMBUSTOR TESTS.

Figure 14 Normalized Gage Resistance Ratio for Combustor Gages After Tests

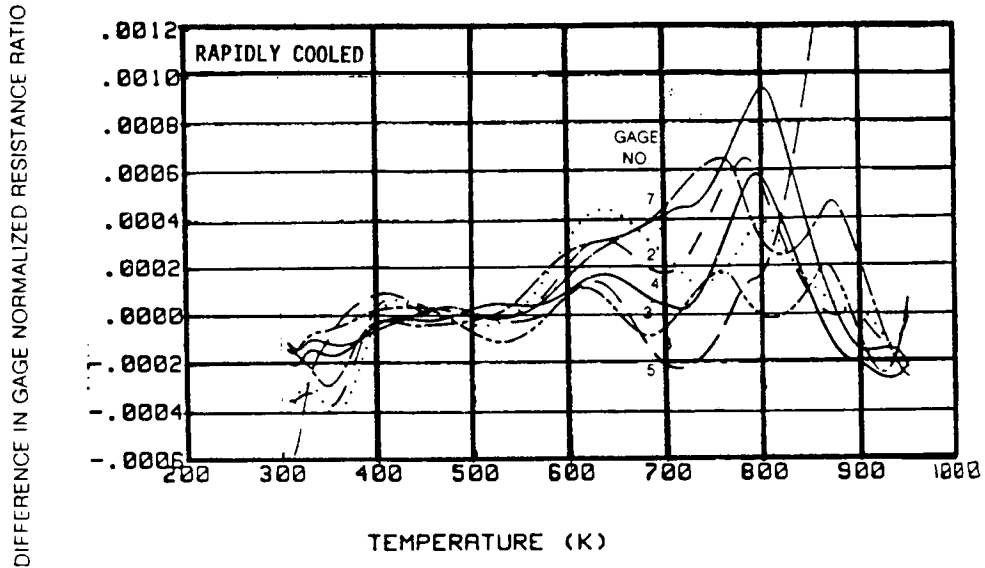

DIFFERENCE IN GAGE NORMALIZED RESISTANCE RATIO VERSUS TEMPERATURE FROM BEFORE TO AFTER THE BURNER TESTS FOR RAPID COOLING ( $t_c = 12$  seconds) FROM 950K. THE DIFFERENCE BETWEEN FIGURE 13 and FIGURE 14 IS PLOTTED FOR EACH GAGE.

Figure 15 Effect of Combustor Tests on Normalized Gage Resistance Ratio

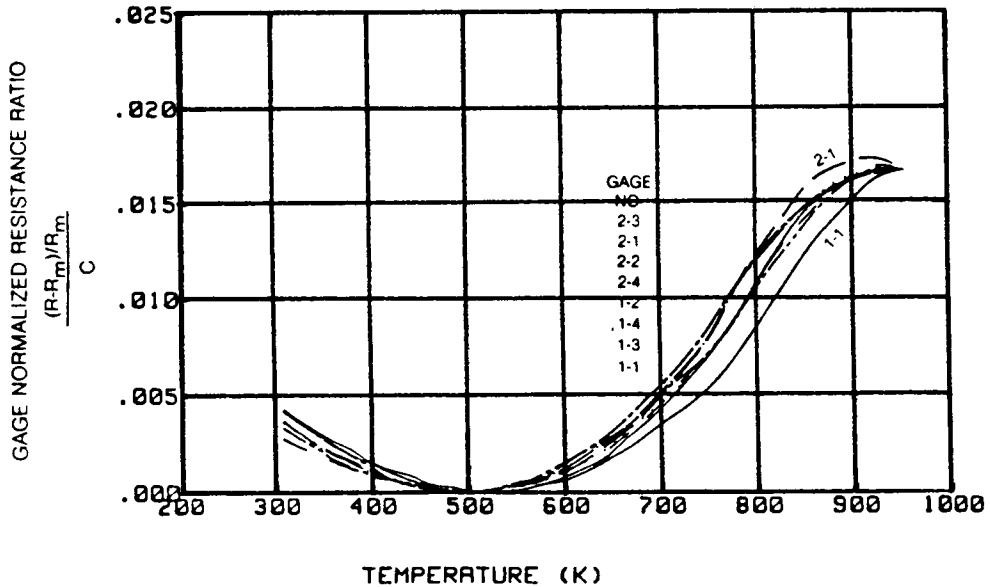

GAGE NORMALIZED RESISTANCE RATIO VERSUS TEMPERATURE DURING RAPID COOLING ( $t_c = 12$  seconds) FROM 950K FOR THE EIGHT GAGES ON THE TWO GAGE-FACTOR TEST BARS. ALL OF THESE CURVES FALL WITHIN THE ENVELOPE OF FIGURE 13.

Figure 16 Normalized Gage Resistance Ratios for Test Bar Gages

ORIGINAL PAGE IS  
OF POOR QUALITY

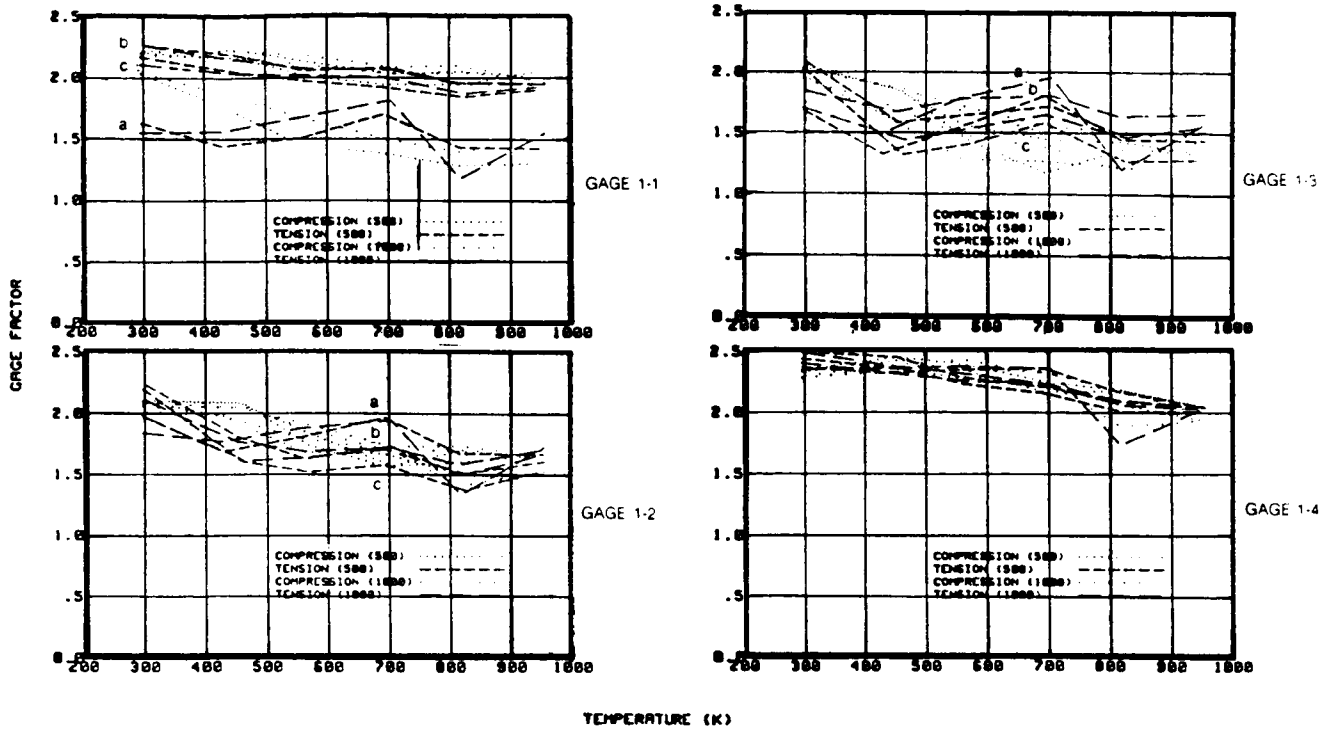

GAGE FACTOR VERSUS TEMPERATURE FOR THE FOUR GAGES ON BAR #1 (a) FIRST TEST, (b) AFTER 200 HOURS AT 950K, (c) Repeat of b.

Figure 17 Gage Factors for Bar 1 Gages

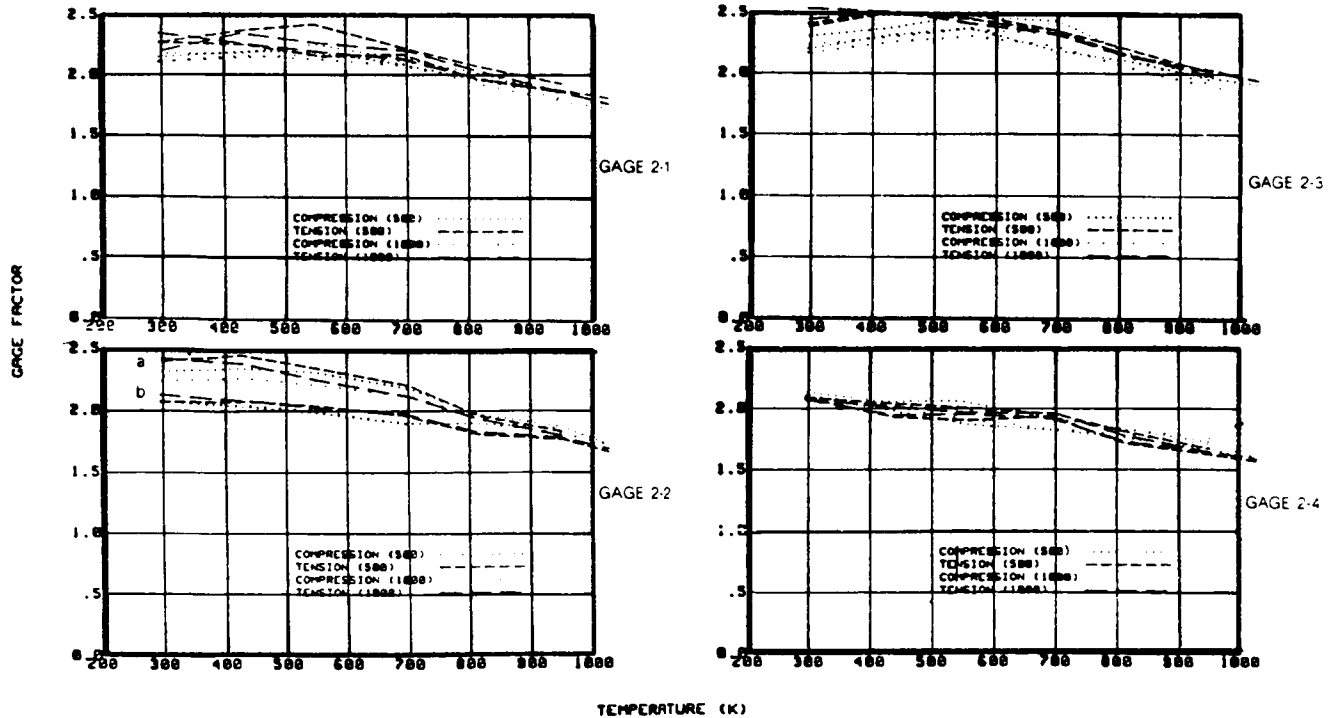

GAGE FACTOR VERSUS TEMPERATURE FOR FOUR GAGES ON BAR #2 (a) FIRST TEST, (b) AFTER RAPID COOLING FROM 950K TO ROOM TEMPERATURE AT  $t_c = 12$  seconds.

Figure 18 Gage Factors for Bar 2 Gages

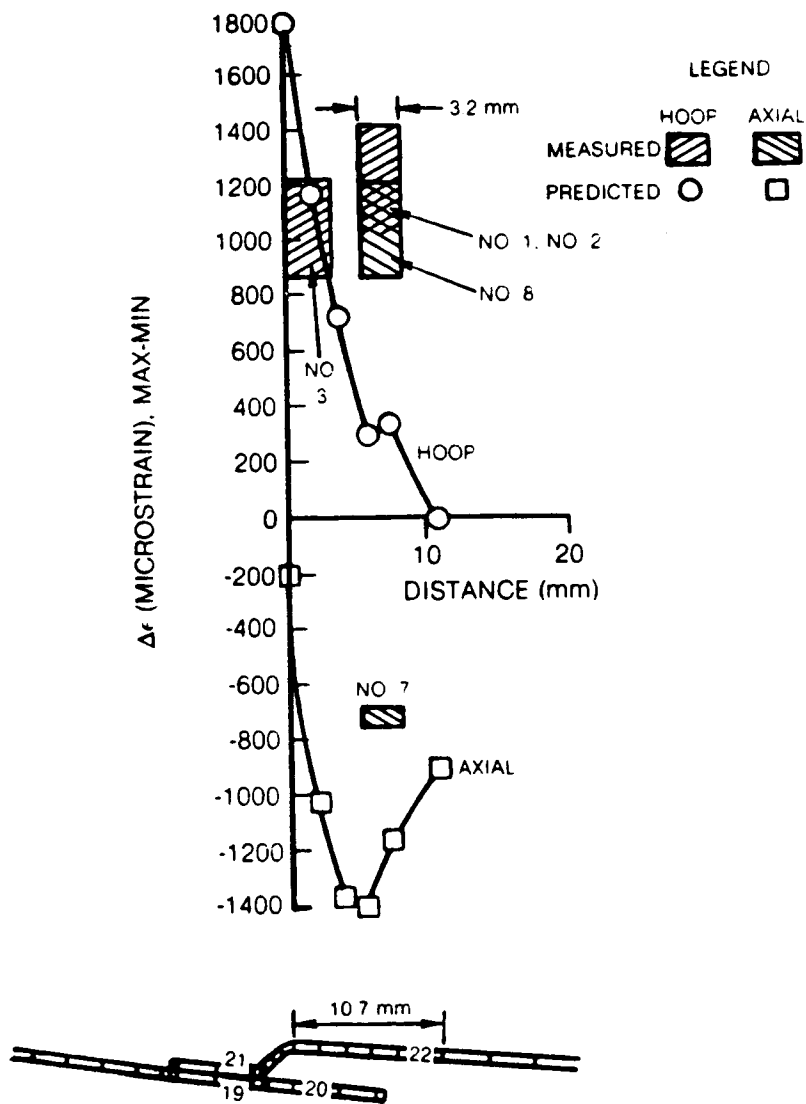

PREDICTED MECHANICAL STRAIN RANGE (USING AVERAGE TEMPERATURES) AND MEASURED STRAIN RANGE (USING KANTHAL A-1 GAGES) DURING BURNER CYCLES 4, 5, 6, 7.

Figure 19 Predicted and Measured Strains During Final Four Burner Cycles