

COMET HALLEY RETURNS

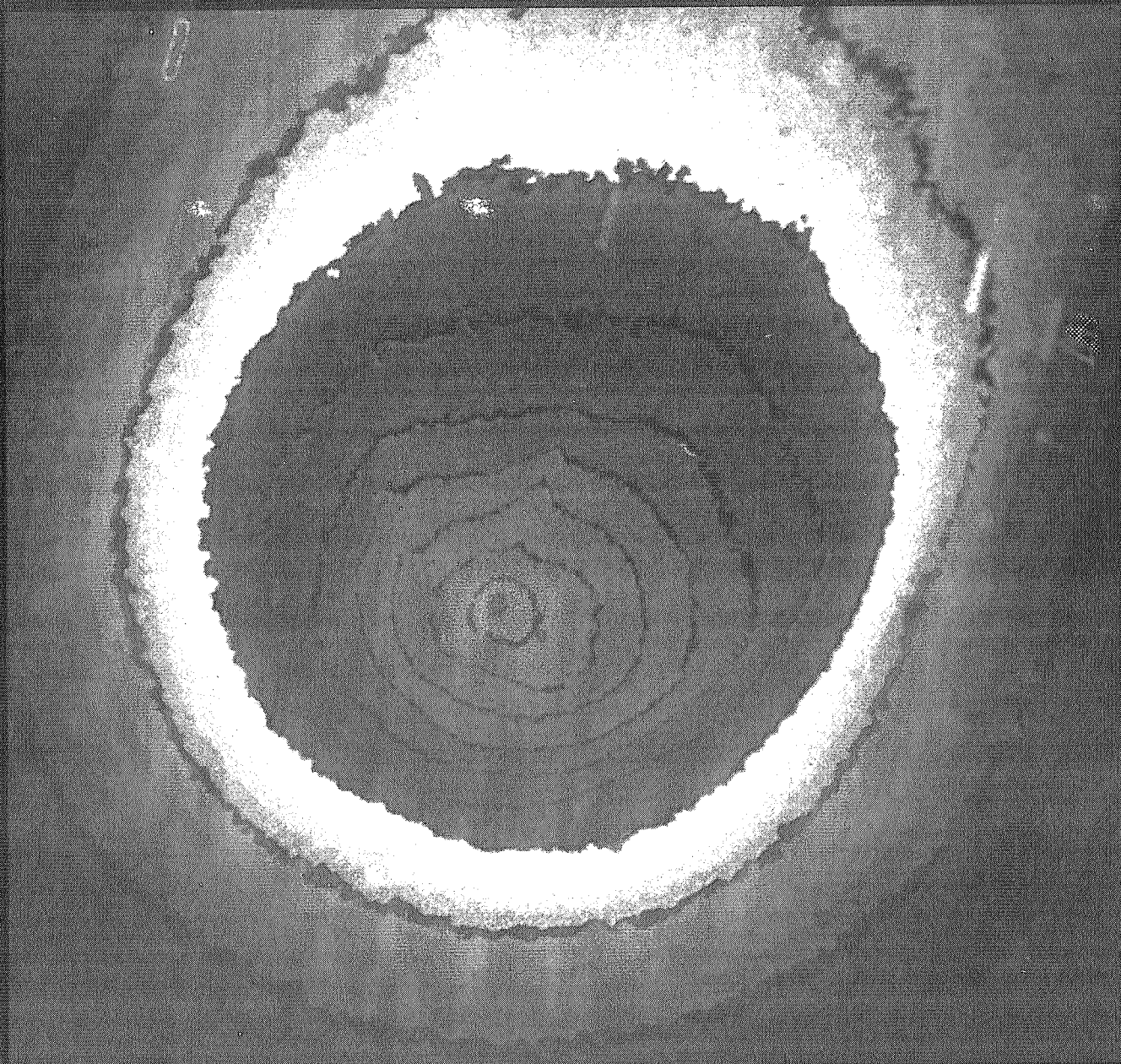

A Teachers' Guide
1985-1986

COVER: Computer enhanced image of Comet Halley from May 25, 1910. The image is the sum of four photographs originally made at the Helwan Observatory in Egypt. The photographs were digitized, added together and computer enhanced at the Interactive Astronomical Data Analysis Facility of the Goddard Space Flight Center by Dr. Daniel A. Klinglesmith, III.

COMET HALLEY RETURNS

A Teachers' Guide 1985-1986



National Aeronautics and
Space Administration

Educational Programs
Office of Public Affairs

Goddard Space Flight Center
Greenbelt, Maryland 20771

Robert D. Chapman, Ph.D.
Associate Chief,
Laboratory for Astronomy and Solar Physics
Goddard Space Flight Center
Greenbelt, Maryland

and

R. Lynn Bondurant, Jr., Ph.D.
Educational Services Officer,
Office of External Affairs
Lewis Research Center
Cleveland, Ohio

*For Sale by the Superintendent of Documents,
U.S. Government Printing Office,
Washington, D.C. 20402*

EP-197

PREFACE

Comet Halley is on its way to a 1985-86 rendezvous with the earth and the sun. This most famous of all comets is sure to generate an increasing level of interest among the general public and particularly among young people as it draws ever nearer to us. The event offers an unparalleled learning opportunity for students at all levels to gain the skills, understanding and enthusiasm necessary to study science.

This booklet has been put together as an aid for teachers in elementary and secondary schools. It is divided into two distinct parts. The first part is a brief tutorial which introduces some of the most important concepts about comets, including their historical significance. In the limited space available, it can only hit the high points. A list of selected readings is provided at the end of the booklet for those who desire a more in-depth treatment of the subject. The second part of the booklet contains a number of suggested activities, built around the comet. These include both classroom exercises and carefully described field work to observe the comet. Guidance is provided on where to look for the comet, how to observe it, and how to photograph it. Virtually every exercise can be done without special equipment. All that is needed is some thought on the part of the teacher to adapt the activities to the appropriate grade level.

Both authors of the booklet have proven, outstanding abilities to communicate science to laymen. In addition, Chapman is a recognized authority in the field of cometary research, having co-authored one of the few professional level textbooks on comets. The result of their collaboration is a scientifically accurate, and well-planned guide. If you use it well, your students will have a profitable educational experience with lifelong rewards.

Elva Bailey
Educational Programs Officer
Goddard Space Flight Center
July 1984

CONTENTS

	<u>Page</u>
PART I. THE NATURE OF COMETS	1
THE HISTORICAL IMPORTANCE OF COMET HALLEY	1
HOW COMETS ARE FOUND AND NAMED	3
COMETARY ORBITS	5
WHAT WILL COMET HALLEY LOOK LIKE	9
HOW AND WHEN WE CAN VIEW COMET HALLEY	10
WHAT IS A COMET?	10
COMETS OF THE PAST	18
COMET HALLEY IN 1910	19
PLANS TO OBSERVE COMET HALLEY	19
PART II. EDUCATIONAL ACTIVITIES	23
IN THE CLASSROOM	23
Newspaper Accounts	23
Oral History	24
Time Capsule	24
Comet Halley Artistically Speaking	24
Comets and Life Sciences	24
Comet Hall of Fame	24
OBSERVING THE COMET	24
Brightness	25
Length of Comet Halley's Tail in Miles	28
Recording Observations	30
Plotting the Location of Comet Halley	30
COMET HALLEY'S ORBIT	33
PLACES TO VISIT — THINGS TO DO	35
COMPUTING AN EPHEMERIS FOR COMET HALLEY	35
SELECTED READINGS	40
INDEX	41

Part I

THE NATURE OF COMETS

A bright comet is a spectacular object to behold. If you had awakened around 4:00 in the morning in early March, 1976 and braved the late winter cold you would have been rewarded with a beautiful sight: a view of the naked-eye Comet West. It would have been visible in the eastern sky, near the point where the sun would rise in a few hours. The comet's head would have been near the horizon, and its tail would have been seen streaming upward toward the zenith. For those of us who saw the comet, it will remain a memorable event. For those who have never seen one, it is well worth the effort to observe one.

Comet Halley will be visible to small telescopes, binoculars and even the naked eye in late 1985 and early 1986. The event is already stirring interest both in the scientific community and in the general public. What is it about this comet that generates so much interest? How can we observe it when it passes near the earth? What will scientists around the world try to find out? These questions and others will be answered in the following pages, as we tell the story of the comet. To begin let us take a look at the reasons that Comet Halley is so important historically.

THE HISTORICAL IMPORTANCE OF COMET HALLEY

To tell the whole story of the importance of Comet Halley would take a large volume, for we would have to look at the whole history of the development of our understanding the nature of the planets and how they move. The early Greeks thought that the planets all revolved around the earth in orbits that were combinations of perfect circles. In the first century A.D., Claudius Ptolemy proposed a complex system of epicycles that explained almost all of the observed facts about the motions of celestial bodies. This system was used to predict the motions of the planets for almost 14 centuries—a fact that attests to the success of the theory. However, natural philosophers began to take a new look at the universe in the Renaissance. Nicolas Copernicus (1473-1543) asserted that the planets all revolved about the sun. Actually, Copernicus' novel idea was based more on aesthetic grounds than on the basis of any scientific results. However, that would change in the late 16th century, when Tycho Brahe (1546-1601) developed new instruments that permitted him to measure the positions of celestial objects with unparalleled accuracy, before the invention of the telescope. Working with Tycho's data, Johannes Kepler (1561-1630) showed that Mars moves around the sun in an elliptical orbit. He then went one step farther and hypothesized that all planets orbit the sun in elliptical orbits.

Two of the most notable scientists of all time were Galileo Galilei (1564-1642) and Isaac Newton (1642-1727). These two men, more than anyone else, invented the modern science of mechanics. Newton also postulated the existence of universal gravity, which asserted that all bodies in the universe attract one another. It is the intense gravity of the massive sun that holds the solar system together.

In parallel with all of these developments in the concepts of planetary motion were developments in our understanding of comets. In the Fourth Century B.C., Aristotle believed that comets were a phenomenon of the earth's atmosphere. In his treatise *Meteorologica* he asserts that comets are "exhalations" in the outer reaches of the atmosphere. This view was repeated by such great philosophers as Ptolemy. It is interesting to note that the Roman Stoic philosopher Lucius Seneca (4 B.C. - A.D. 56) held the view that comets are celestial bodies which travel through space in elongated orbits. Before we give Seneca too much of a pat on the back, we must realize that his idea was as much of a guess as was that of Aristotle. It was not until the 16th century that Tycho, with his very accurate instruments, could make observations which established that comets are celestial objects. He observed the position of a bright comet that appeared in 1577 from various sites in Europe. If the comet were in the earth's atmosphere, then it would have a measurable parallax (see Figure 1), that is, it would shift against the background of the stars by a measurable amount as he moved his equipment about on the surface of the earth, viewing the comet from different angles. He could not detect a measurable parallactic shift, so he concluded that the comet had to be at least several times farther away from the earth than the moon, whose parallax he could measure.

In 1665, the Great Plague closed down Cambridge University, and the 23-year old Isaac Newton was forced into a two-year hiatus in his formal studies. With few responsibilities, Newton had little to do other than contemplate the mysteries of the universe. The results of his contemplations were formidable. He arrived at a formalized system of mechanics and a law of gravitation that together put the study of motions in the solar system on a firm mathematical footing.

Among his other accomplishments, Newton found a way of calculating the characteristics of the orbital paths of a comet from a series of observations of the comet's position in the sky. He did this, in part, by assuming initially that the comet's orbit was parabolic in shape. A young friend and contemporary, Edmund Halley, applied the method to a series of comets that were observed in the

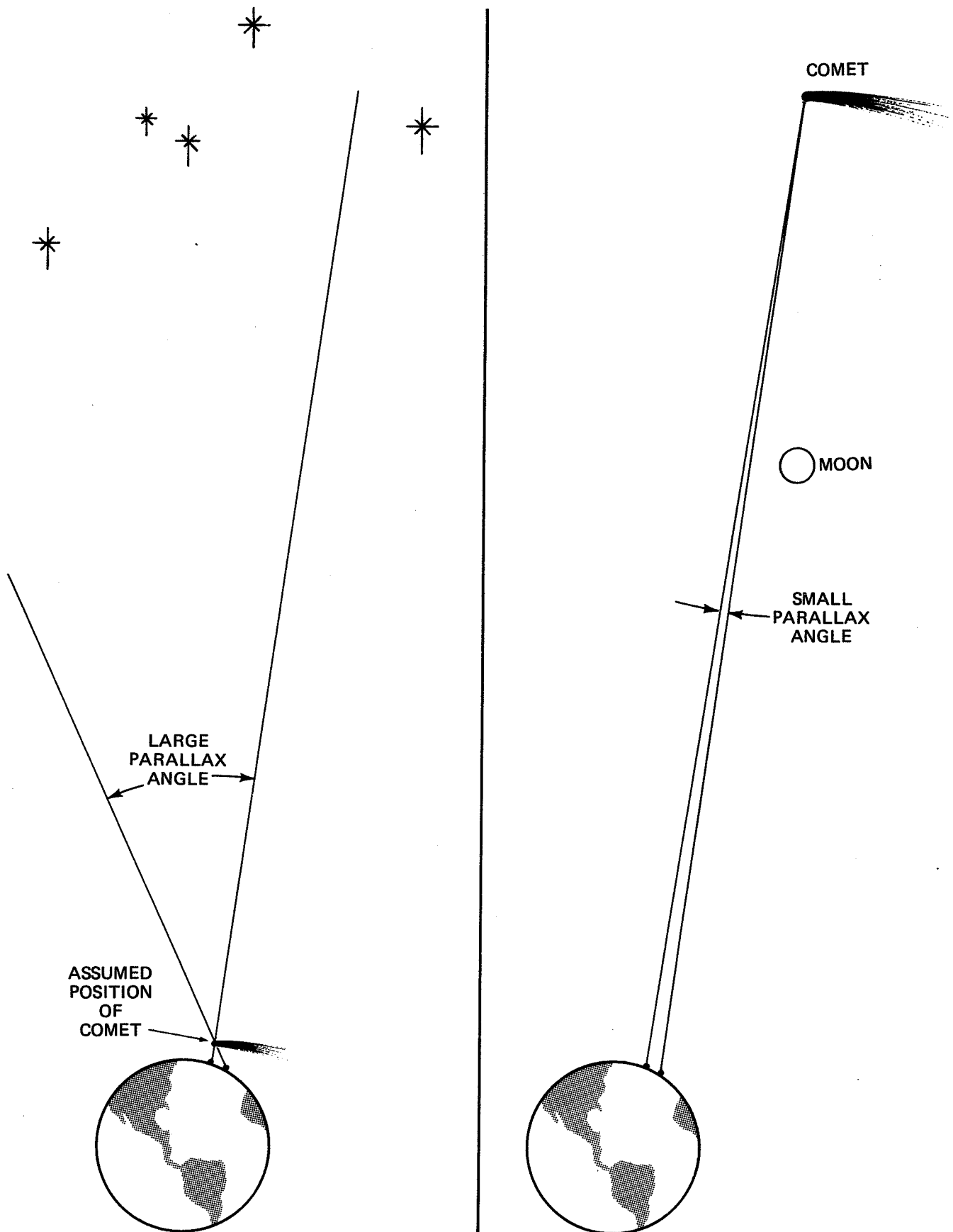

If the comet were in the atmosphere, it would appear to shift against background stars due to a small motion of the observer.

If comet were farther than the moon, the shift due to the motion of the observer would be smaller, and would have been difficult to measure in 16th century.

Figure 1. A comparison of the parallax of a comet if it were in the earth's atmosphere and if it were beyond the moon.

14th through the 17th centuries. Among the surprises that he turned up was the fact that comets observed in 1531, 1607, and 1682 all had very similar orbits. He concluded that the three comets were, in fact, repeated appearances of one and the same comet that orbited around the sun once every 75 years in an elongated orbit, as shown in Figure 2. He predicted that it would return to the vicinity of the earth and sun in 1758. The comet passed perihelion — the closest point in its orbit to the sun — on March 12, 1759, after being recovered by an amateur astronomer on December 25, 1758. Unfortunately, Halley died before the comet returned, and he did not see it again. The return provided incontrovertible proof of Newton's theory, and Halley's orbit calculations. In honor of the great importance of Halley's prediction, the comet was named after him.

In October 1982, astronomers working with the great 5-meter (200-inch) reflecting telescope on Palomar Mountain in California obtained the first observations of Comet Halley as it proceeded toward a 1985-86 rendezvous with the sun and the earth. When these early images were obtained, the

comet was well over a billion miles from the sun, farther away than the planet Saturn. It appeared as a very faint, starlike point of light on the photograph (Figure 3); it was too far from the sun to have formed the features that normally characterize a comet. How, then, did the astronomers recognize it as a comet? There are two reasons: first, the starlight point of light was seen to move relative to the stars when two exposures taken several hours apart were intercompared; and, scientists had calculated where the comet ought to be using observations made at all the passes since Edmund Halley's days, and the comet was found at the correct position.

HOW COMETS ARE FOUND AND NAMED

Many comets have been discovered by amateur astronomers who spend hours sweeping the sky with wide field, low magnification telescopes called "comet seekers." Typically, the observer sees a faint, fuzzy object among the stars in some region of the sky, where catalogs say there should not be a fuzzy object. There are many types of objects

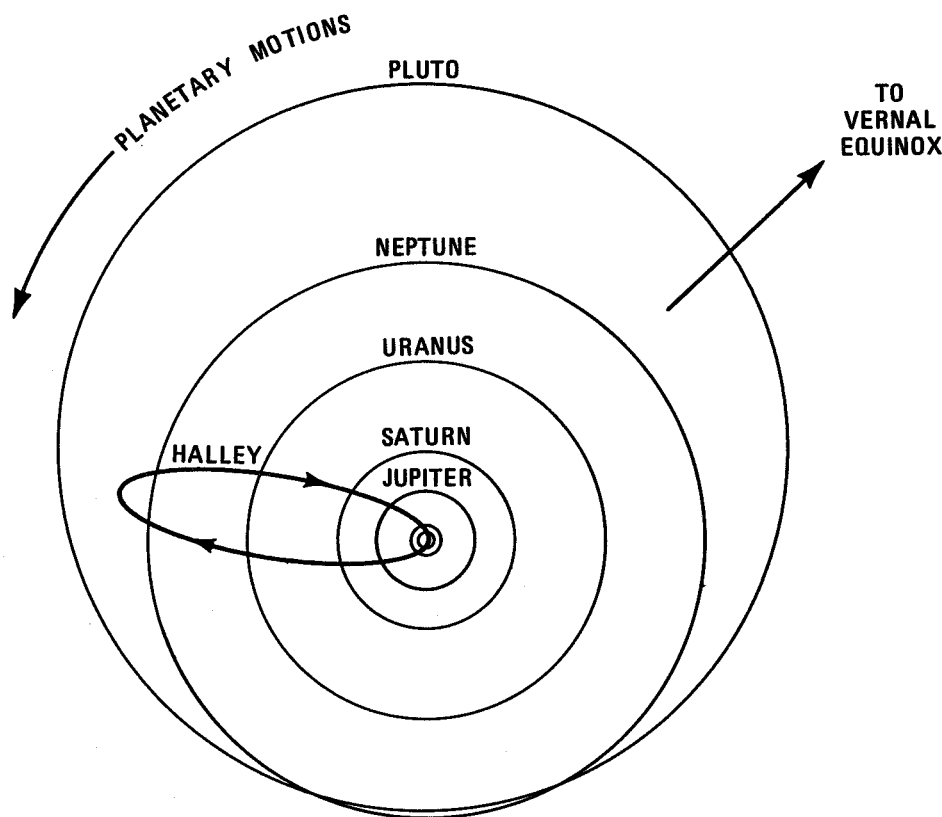

Figure 2. The orbit of Comet Halley. The circles represent, from the inside out, the orbits of earth, Mars, Jupiter, Saturn, Uranus, Neptune, and Pluto. The outer three planets' orbits are added for reference. These planets were unknown at the time Halley ascertained the parameters of the orbit of Comet Halley. Note that in this picture the planets orbit in a counterclockwise direction, while the comet orbits in a clockwise direction. The view is from above the north pole of the earth.

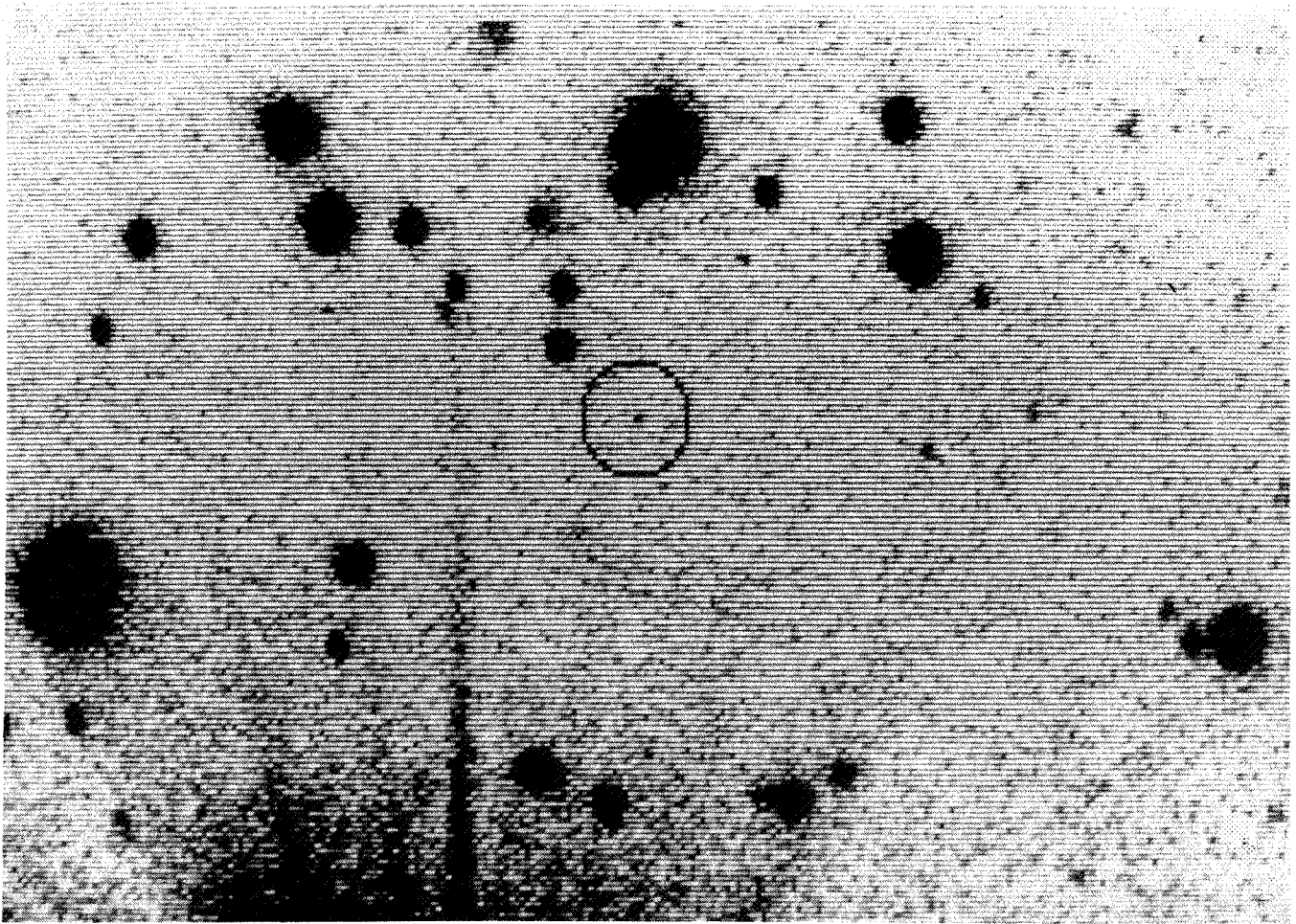

Figure 3. Rediscovery photograph of Comet Halley made in October 1982 using the great 200-inch reflector on Palomar Mountain, California. (Courtesy of G. Edward Danielson of Caltech.)

that appear fuzzy to a small telescope: galaxies, star clusters and glowing interstellar gas clouds all do. The clue as to whether an observed fuzzy object is a comet or not is its motion. A comet will be observed to move its position over the course of several hours, while any of the other objects mentioned do not appear to move relative to the stars.

When a person discovers a comet he or she is rewarded by having the comet named after him or her. Occasionally, two or even more observers find the same comet nearly simultaneously, in which case up to three independent observers will have their names attached to the comet. For example, Comet Ikeya-Seki, which became visible to the naked eye in 1965, was discovered by two Japanese amateurs, K. Ikeya and T. Seki. Kaoru Ikeya discovered his first comet in 1963 when he was only 19 years old, using a home-made telescope. His discovery, which culminated 16 months of searching, brought him much deserved fame for his energy and persistence. He has now discovered many more comets.

Not all comets have been found by amateurs, of course, although comet seeking is one field where the layman can assist and even compete with the professional. The most successful comet seeker of all times, Jean Louis Pons (1761-1831) started his career in astronomy as the caretaker at the Marseilles Observatory in 1789. In his active lifetime, he discovered *over* thirty-seven comets and worked his way up in the astronomy profession until he was appointed director of the Marlia Observatory.

One of the most incredible stories of the discovery of a comet is the following. An astronomer at the Lick Observatory, C. D. Perrine, discovered a comet in 1896. On subsequent nights he continued to make routine observations of the object. At one point, he received a telegram from the Kiel Observatory also reporting the position of the comet. However, unknown to him, there had been an error in the transmission of the telegram resulting in an incorrect position being listed. The incorrect position was only two degrees from the correct one, so Perrine did not notice the difference. When he looked at the wrong position, there was a second new comet.

Comet seeking is an area where women have distinguished themselves. Carolina Herschel discovered or co-discovered eight comets between 1786 and 1797, earning her a world wide reputation. In the U.S., Maria Mitchell discovered her first comet, Comet Mitchell, in 1847. She went on to become a professor of astronomy at Vassar College. Mitchell is considered to be the first American woman astronomer.

The method of naming comets after the discoverer leads to some tongue twisters. Names such as Comet Honda-Mrkos-Pajdusakova take a while to spell out. The astronomers A. Schwassmann and A. A. Wachmann together have discovered several comets, so we must speak of Comet Schwassmann-Wachmann I, Comet Schwassmann-Wachmann II and so forth. In 1973, L. Kohoutek discovered two comets within an eight day period. The first, and fainter Comet Kohoutek passed perihelion (its closest point to the sun) a few months after discovery and faded rapidly from view. However, the second one became quite bright and stirred a lot of interest at the time. Figure 4 is one picture made of the second Kohoutek during 1974. Both comets were called Comet Kohoutek, a fact that could lead to some confusion.

To avoid this type of confusion, comets are numbered as well as named. There are two numbering systems. First of all, when a comet is found, it is designated according to the order of discovery. The first comet discovered in 1983 is termed 1983a, the second 1983b, and so on. Comet IRAS-Araki-Alcock was the fourth comet discovered in 1983, so it is called comet 1983d. (Incidentally, this latter comet was first noticed in data gathered by NASA's Infrared Astronomy Satellite (IRAS), so it was named in honor of the satellite, a notable exception to the rule of naming comets after human discoverers.) On the scheme based on year and order of discovery, the two Comets Kohoutek were comet 1973e and 1973f. The second comet-numbering system is based on the order in which comets reach the perihelion points in their orbits. The first comet to pass perihelion in 1983 is termed comet 1983 I, the second comet 1983 II, etc. On this system, Comet Schwassmann-Wachmann I is also called comet 1925 II and Comet Honda-Mrkos-Pajdusakova is also called comet 1945 III.

COMETARY ORBITS

The orbit of a comet is a conic section, that is, an ellipse, a parabola, or a hyperbola. If the orbit is an ellipse, the comet will return periodically to the vicinity of the sun. A comet in a hyperbolic orbit, on the other hand, is not bound to the solar system. Such a comet will zip by the sun and head off into interstellar space never again to return.

An ellipse is a closed figure obtained by intersecting a circular cone with a plane. As shown in Figure 5, when the intersecting plane is perpendicular to the axis of the cone one obtains the limiting case of a circle. When the plane is tipped at an angle to the axis, one obtains an ellipse. The greater the intersecting plane is tipped, the more the ellipse is elongated, until a point is reached where the curve resulting from the intersection is no longer a closed curve. When the plane is parallel to a generatrix (a straight line through the apex of the cone and on the surface of the cone; for example, a pole in a tepee is a generatrix) of the cone, the figure is a parabola. If the plane is made parallel to the axis of the cone, then the conic section generated is a hyperbola.

The size and shape of the comet's orbit and the orientation of the orbit in space are specified by six quantities known as the orbital elements of the comet. Once the orbital elements are ascertained, a table of the future positions called an ephemeris can be computed. An initial calculation of the orbital elements can be carried out once three accurate measurements of the comet's position have been made. Usually, only a small arc of the orbit is included between the three initial positions, and the calculation of the elements of the whole orbit can be inaccurate. An ephemeris calculated from the initial orbital elements is usually only a rough approximation to the expected cometary motion. However, as more position observations become available, the orbital elements can be successively refined, and more accurate ephemerides can be calculated. For the initial calculation of the elements of the orbit of a comet, astronomers often follow Halley's lead and assume that the comet moves in a parabolic orbit. In fact, in a large fraction of the cases the refined orbit turns out to be very close to a parabola.

One does not have to understand about orbital elements to understand comets. However, let's take a closer look at the concept for those of you who are interested. There is more than one valid set of orbital elements, but we will choose a particular set for discussion. First, it takes three angles, i , Ω , and ω , to describe the orientation of the orbit in space. These angles are illustrated in Figure 6. Next, we must describe the size and shape of the orbit. Traditionally, the shape is given by the eccentricity, e , of the orbit. A circle has an eccentricity of 0.0, and a parabola has an eccentricity of 1.0. Ellipses have eccentricities between 0.0 and 1.0. The orbit's size is given by the parameter, q , which is the distance from the sun to the comet at perihelion. The five elements i , Ω , ω , e , and q fully describe any cometary orbit. Finally, we must specify where the comet is in the orbit. This is usually done by giving the time when the comet passes perihelion. The time of perihelion passage, T , is the sixth orbital element.

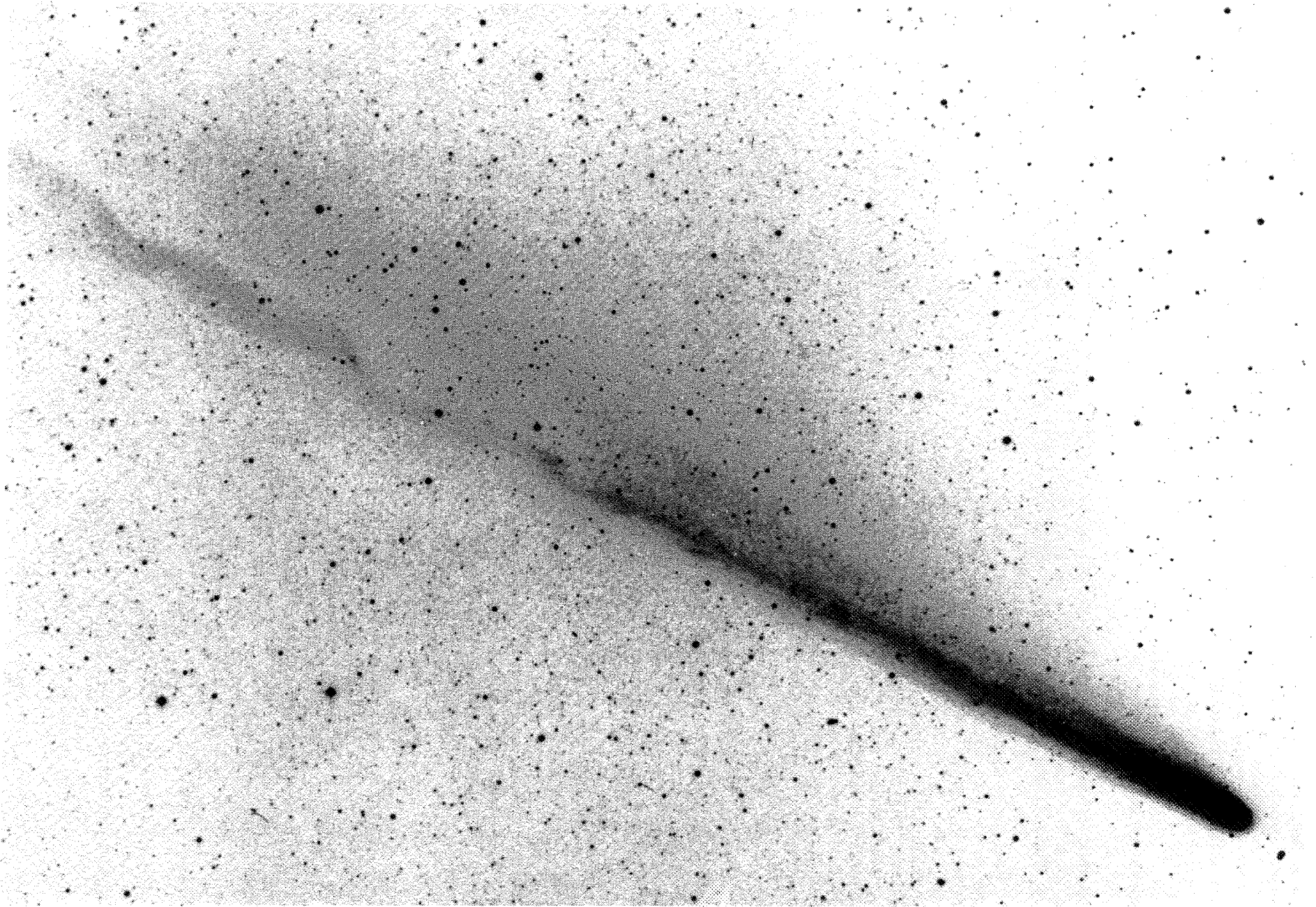
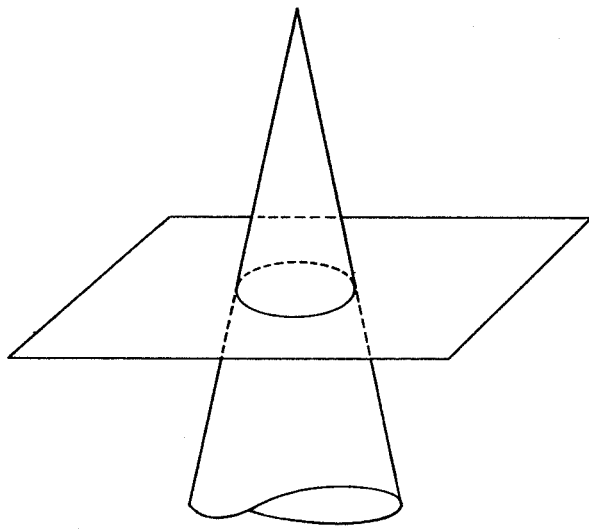
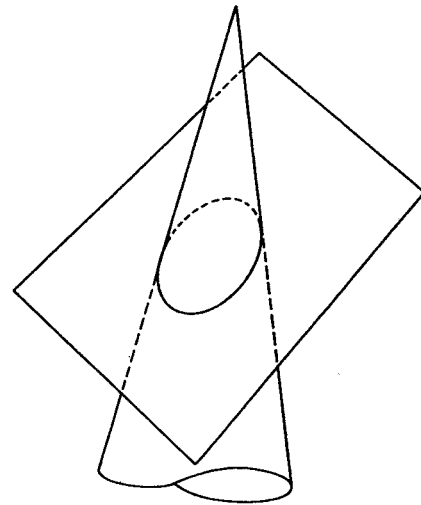

Figure 4. Comet Kohoutek on January 13, 1974. (*Joint Observatory for Cometary Research photograph.*)



(a)



(b)

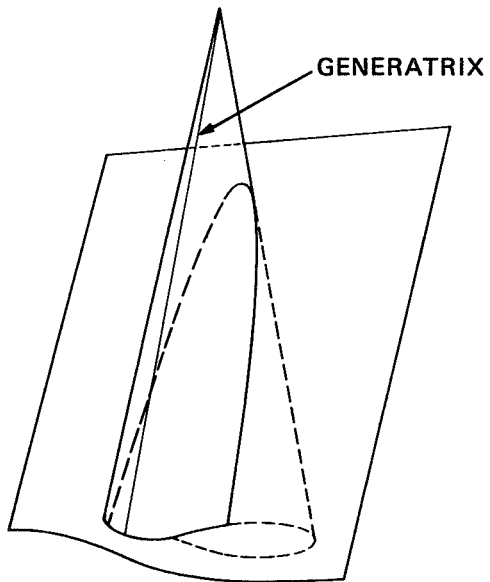

(c)

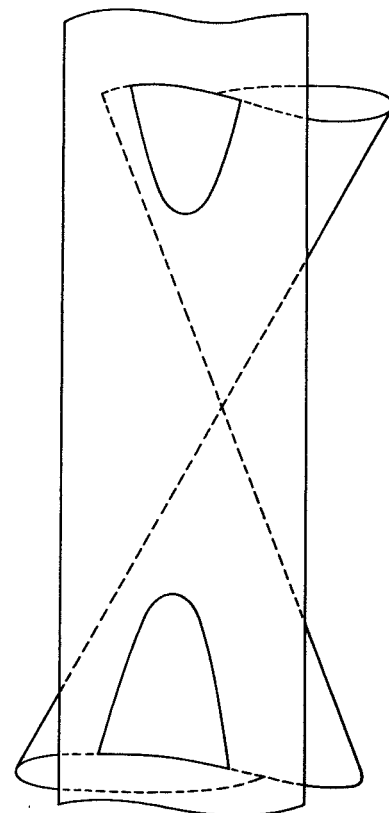

(d)

Figure 5. (a) A circle, (b) an ellipse, (c) a parabola, and (d) a hyperbola resulting from the intersection of a cone and a plane.

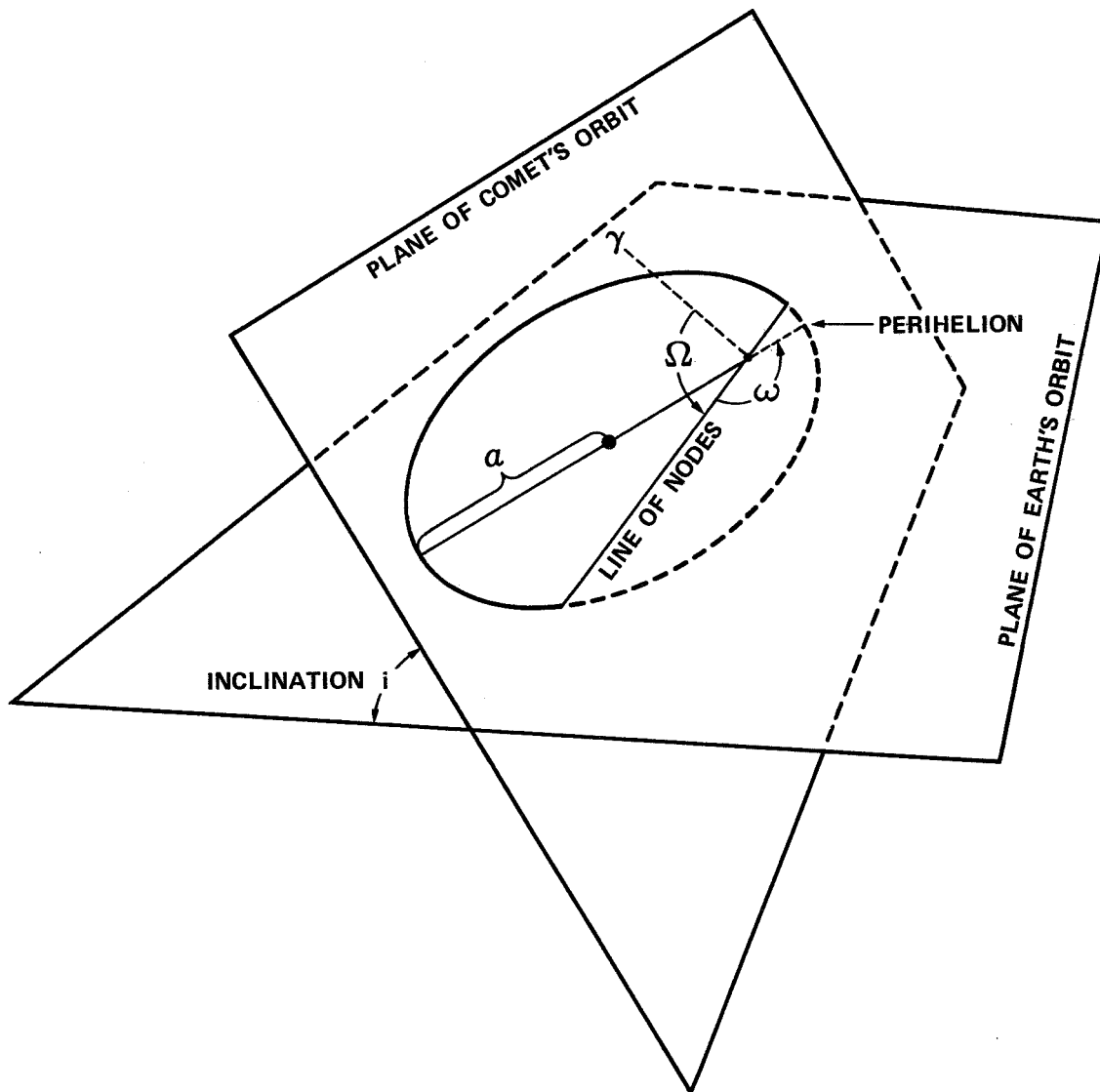

Figure 6. Graphical illustration of the angular elements of an orbit. The symbol marks the direction to the vernal equinox. The elements are explained in the text.

Comet Halley is a short period comet. Like the planets, it moves in an elliptical orbit. However, there the resemblance to planetary orbits ends. While the orbits of the planets are nearly circular, the orbit of Comet Halley is an elongated ellipse. The solar system, as defined by the region of space where the planets move, is a flat system. With the exception of Pluto, none of the planets' orbits is tilted by more than a few degrees from the plane of the earth's orbit. In addition to the flatness of the solar system, there is also a common direction to almost all motions in the system. For instance, all the planets revolve around in a counterclockwise direction as seen from far above the earth's north pole. In addition, all the planets except Venus and Uranus rotate in the same direction that they revolve, and of the 32 planetary satellites known before the last flyby of Saturn, 21 revolve about their parent planet in the counterclockwise, or *direct* sense.

In contrast to the flat, regularly moving system of planets, the system of comets is a hodgepodge — particularly for the long period comets. The inclinations of their orbits to the ecliptic can be anything from 0° to 90° and their orbital motion can be direct or retrograde. Comet Halley, for instance, moves in a retrograde sense in an orbit that is tipped by 18° to the earth's orbit.

The long period comets are those comets whose orbital revolution periods exceed 200 years. They are the majority of comets; only about 20% of all comets with well observed orbits (or about 100 comets) fall into the short period group. In fact, all comets that have well established periods are short period comets. The exact size of a very elliptical orbit, and therefore the period of revolution of the comet, is difficult to ascertain even from a series of good observations.

The group of short period comets has a mean period of revolution of seven years. The orbital planes of these comets tend to be near the plane of the ecliptic, and the comets motions tend to be direct. Comet Halley is somewhat exceptional, with its retrograde motion. Its period is among the longest of the short period comets as well. The shortest period comet known is Encke's comet with a period of 3.3 years.

One of the most uncertain facts about any comet is the magnitude that it will have when it is at its brightest. The factors determining the brightness are: (1) the distance from the sun to the comet, which tells how much light reaches the comet; (2) the size of the comet, which determines how much light it produces; and (3) the distance from the comet to the earth, which tells how much of the reflected light we receive. Of these three factors, the second is the most uncertain.

WHAT WILL COMET HALLEY LOOK LIKE

When a typical comet is first observed, it is a fuzzy, nearly round object in the sky. In May of 1983, astronomers found comet IRAS-Araki-Alcock

(Figure 7) using data obtained by the Infrared Astronomy Satellite, as we mentioned earlier. When it was first seen, it was a nondescript fuzzy object. In mid May, the comet reached naked eye brightness, when it appeared to be a nondescript, bright fuzzy object. The fuzzy spot of light is called the *coma*. As the comet approaches the sun, the coma will grow in size and brightness. Typical coma diameters range between 19,000 and 190,000 kilometers (12,000 and 120,000 miles). When Comet Halley was recovered in late 1982 (see Figure 3), it was so far from the sun that its coma had not yet formed. All that we see then is the *nucleus* of the comet. Even in the brightest comets, the nucleus remains a starlike point of light. When comets are near the sun the nuclei are difficult or impossible to see inside the bright coma. Cometary nuclei are estimated to be a few kilometers in diameter. From its brightness, for instance, we estimate the nucleus of Comet Halley is about 5 kilometers in diameter. The nucleus and coma make up the head of the comet.

The most spectacular characteristic of a comet is its tail, which develops as it nears the sun. A comet could have a tail as long as 160 million kilometers (100 million miles), although typical lengths

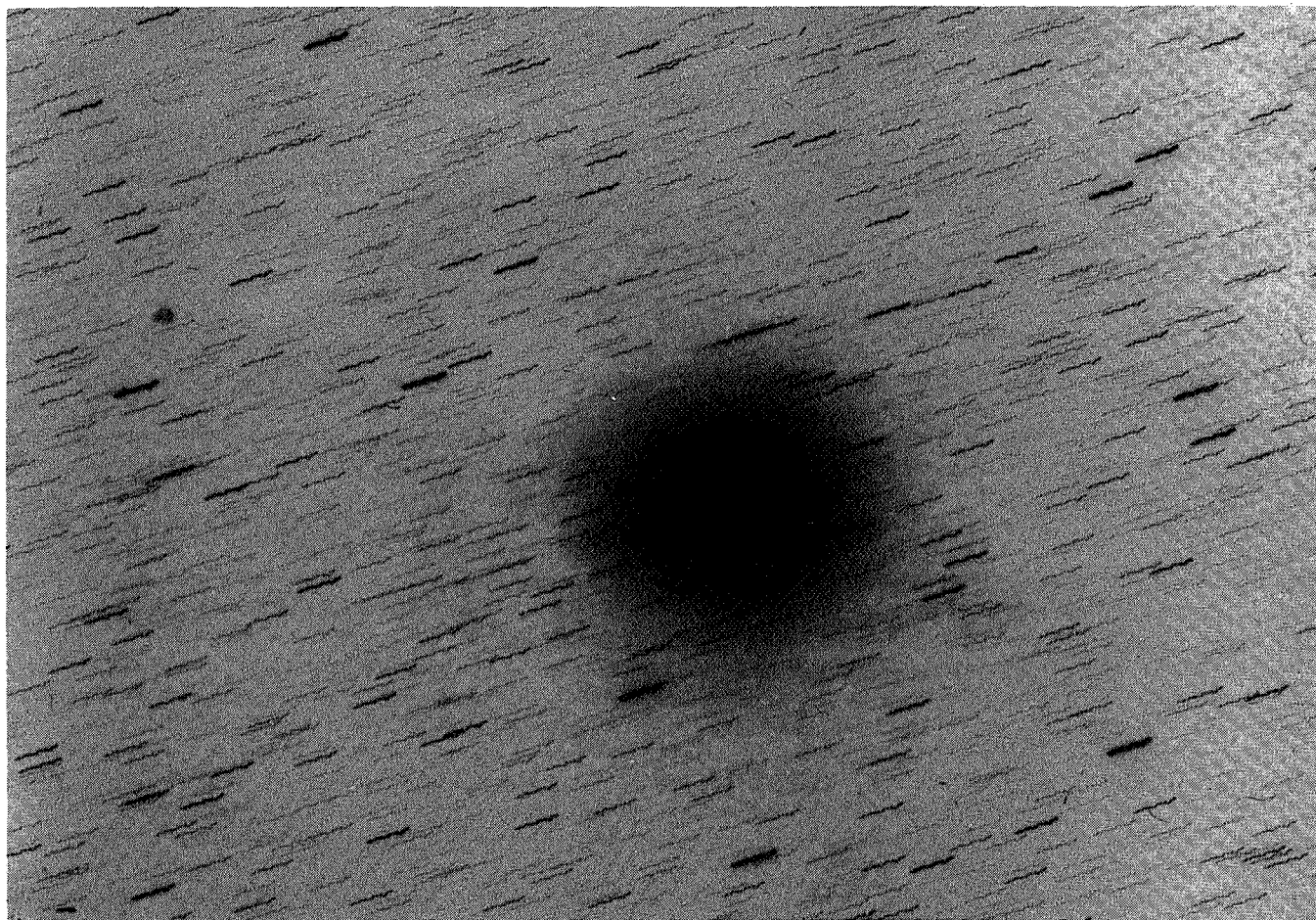

Figure 7. Comet IRAS-Araki-Alcock photographed on May 12, 1983. (Joint Observatory for Cometary Research photograph.)

are more like a few million kilometers. A comet's tail always points away from the sun. Comet IRAS-Araki-Alcock was unusual in that it did not develop a conspicuous tail. Most comets do develop tails. Comet Halley developed a tail each time it has been observed in the past, and there is no reason to believe that it will not develop one this time. Figure 8 is a well known photograph of Comet Halley made during 1910.

HOW AND WHEN CAN WE VIEW COMET HALLEY

We need to stress at the outset that the 1985-86 return of Comet Halley will not be as spectacular as the returns of 1835 or 1910. However, it will be a naked eye object during some time periods in 1985 and 1986. Many of you may remember that Comet Kohoutek was supposed to be an unusually bright comet in late 1973 and early 1974. Yet, many people did not see it. Why? The experience of some of the comet observers I know is instructive. One of my colleagues travelled to a well situated comet observatory (The Joint Observatory for Cometary Research) in southern New Mexico, on a high mountain near Socorro. During January 1974, he saw the comet as a bright naked eye object almost every night. By contrast, I remained in the Washington, D.C. area, and never really saw it well. The difference was the environment. In New Mexico, there was no industrial air pollution and no large cities with their bright lights to drown out the subtle light of the comet. In the Northeastern U.S., by contrast, it is hard to find a site away from air pollution and city lights. You should remember this as you plan to see Comet Halley. A trip to the mountains (and I don't mean all the way to the Southwest) will pay off in your ability to see the comet.

There are two time periods when Comet Halley will be most easily observed by someone in the U.S. The first period encompasses the last week in November and the first week in December 1985, when the comet will be fairly bright — though it will probably be observable only with binoculars. The comet will then pass through perihelion, and be invisible behind the sun until about March 1986. It is then predicted to be its very brightest in late March and early April of 1986. In late March, the comet will be observable in the morning sky, toward the southwestern horizon. If you are at the latitude of New York City, you can see it about 10° above the horizon. The farther south you are, the higher it will be in the sky at that time. From southern Florida or Texas, the comet will be almost 30° above the horizon. The best views will be from the southern hemisphere. If you could visit South America, for instance, you would have an exceptional view. The comet will then swing farther north, and will be visible in the evening sky for observers at the latitude of New York City as

much as 30° above the horizon. However, at this time it will once again require binoculars to be seen. Figures 9 through 11 summarize the discussion in pictorial form.

WHAT IS A COMET?

In the early 1950's, Dr. F. L. Whipple of the Harvard College Observatory presented a picture of comets that, with some minor modifications, is accepted today. Whipple proposed that the nucleus is in effect a dirty iceberg, a large mass of frozen water, methane, ammonia, carbon dioxide, and other constituents, in which is embedded meteorite-like solid particles of various sizes. When the nucleus is heated by the radiation of the sun, its ices sublime — that is, go from the solid state to the gaseous state — and as a result the nucleus is surrounded by a cloud of gas and the dust particles that were released. This cloud is the coma. Figure 12 illustrates the parts of a typical comet that we will describe here.

When one turns a spectrograph on the coma of a comet, the spectrum is found to contain lines or bands which indicate the presence of simple constituents such as H, OH, O, CN, C₂, C₃, CO⁺, NH, NH₂, CH, N₂⁺ H₂O⁺ as well as other constituents. When comets are observed at radio wavelengths, evidence of molecules such as methyl cyanide (CH₃CN) and hydrogen cyanide (HCN) may be found. With only a very few exceptions, these constituents will not exist as such when frozen in the nucleus. Instead, they must arise from chemical changes to the frozen molecules that are found there. We refer to the molecules frozen in the nucleus as "parent" molecules, and the observed constituents as "daughter" molecules. Astronomers believe the parent molecules to include ordinary water (H₂O), ammonia (NH₃), methane (CH₄), as well as C₂, N₂, and CO₂.

When the parent molecules are exposed after subliming from the nucleus, the ultraviolet photons from the sun can break them apart (photodissociate them) into the daughter molecules. The process takes place so quickly that we do not have time to see the parent molecules. The solar wind particles also have an effect on the constituents. The complete story is far from fully understood. We hope a detailed study of Comet Halley will shed additional light on these problems. In 1973, we issued a booklet like this one for Comet Kohoutek, and we ended this section by saying: "we hope a study of Comet Kohoutek will shed further light on these problems." It did. We first observed H₂O⁺ in Kohoutek, giving us additional evidence for the presence of water in the nucleus. But Kohoutek did not solve the problem, and Comet Halley will not solve the problem completely either. Employment is assured for future generations of comet scientists.

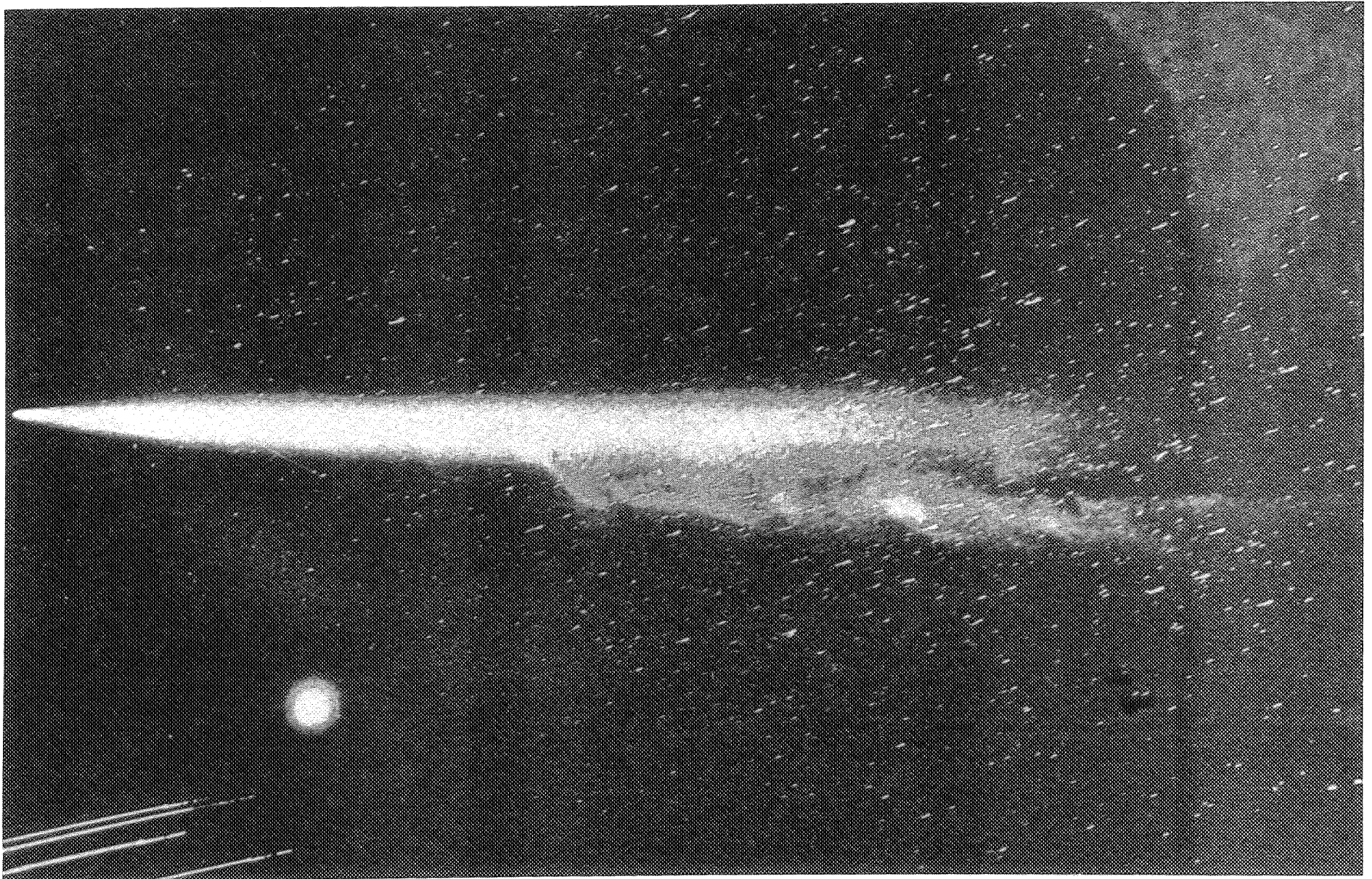

Figure 8. Comet Halley on May 13, 1910. The planet Venus and the city lights of Flagstaff, Arizona are visible in the picture. (*Lowell Observatory Photograph.*)

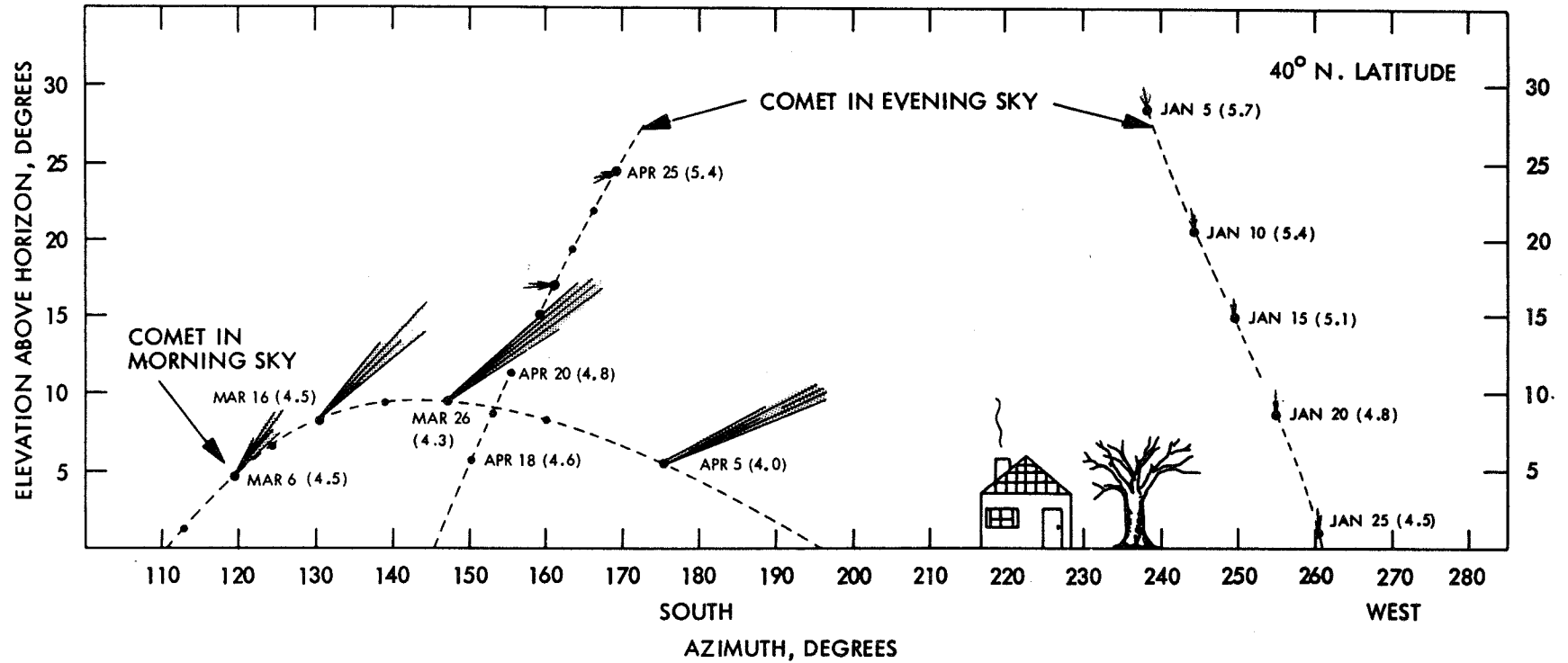

Figure 9. Comet Halley as observed in 1986 by an observer located at 40° north latitude. The comet positions are given for the beginning of morning twilight or at the end of evening twilight. Approximate visual magnitudes are given in parentheses following dates.
(From *Comet Halley Handbook*, Courtesy D. K. Yeomans.)

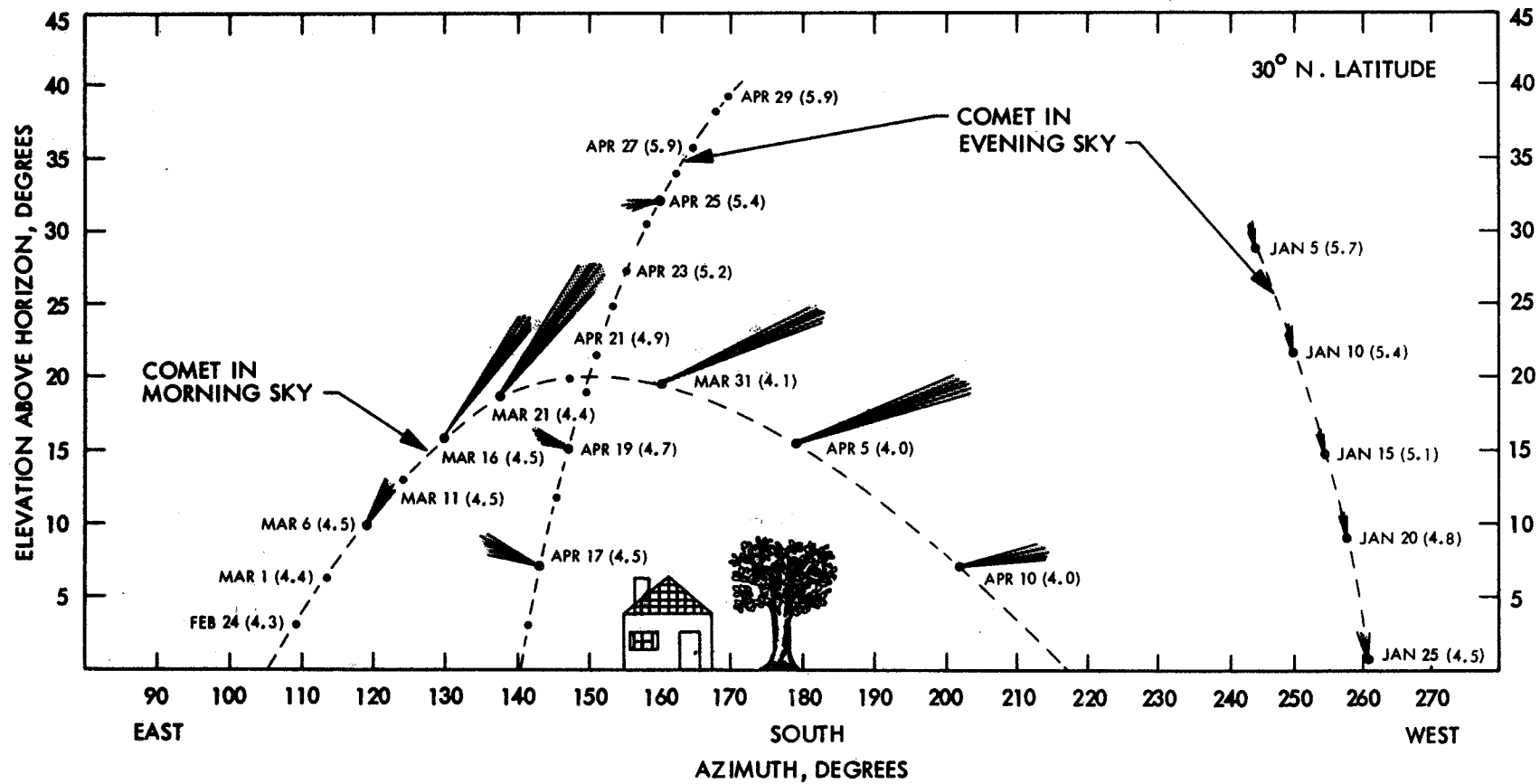

Figure 10. Comet Halley as observed in 1986 by an observer located at 30° north latitude. The comet positions are given for the beginning of morning twilight or the end of evening twilight. Approximate visual magnitudes are given in parentheses following dates.
From Comet Halley Handbook, Courtesy D. K. Yeomans.

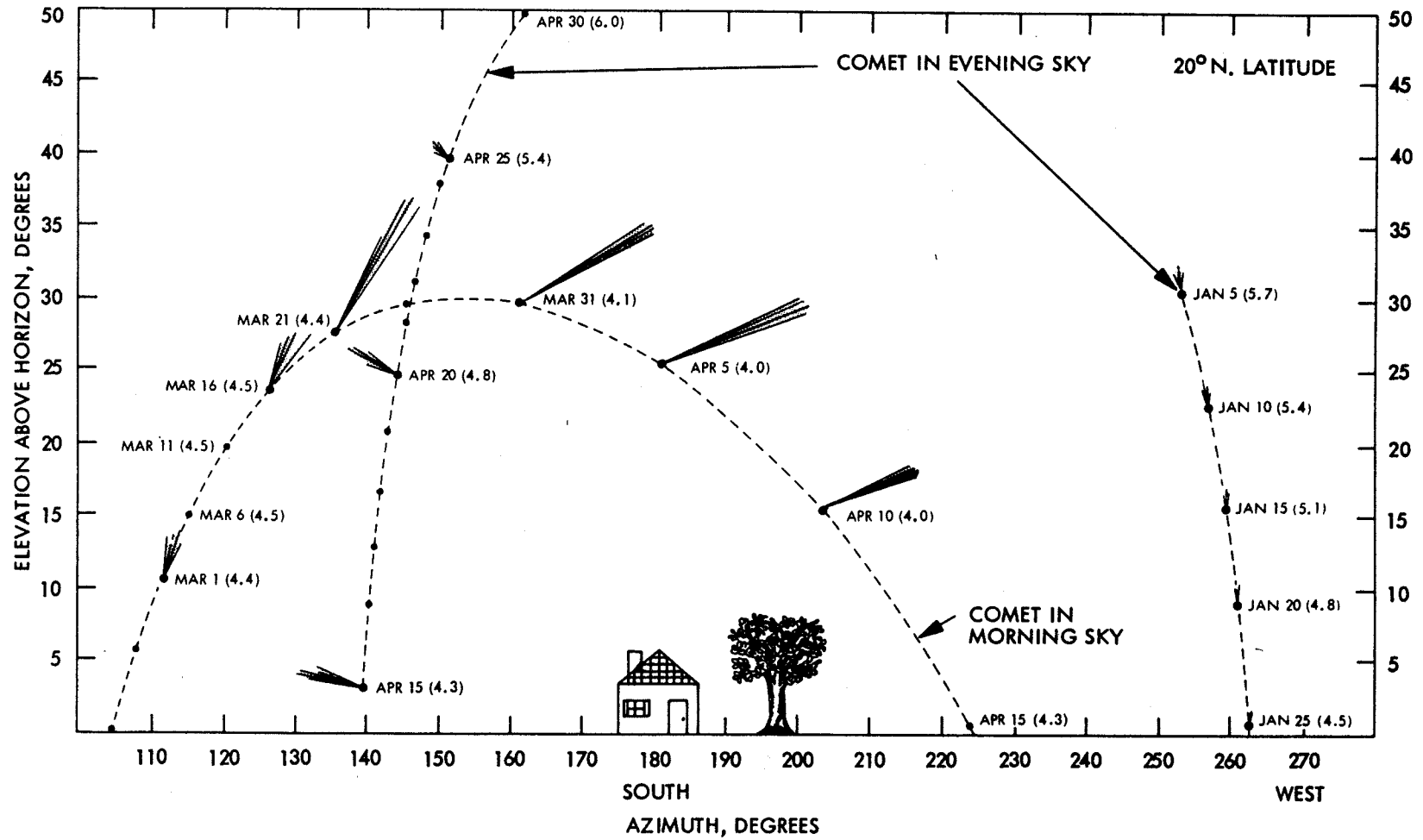

Figure 11. Comet Halley as observed in 1986 by an observer located at 20° north latitude. The comet positions are given for the beginning of morning twilight or the end of evening twilight. Approximate visual magnitudes are given in parentheses following dates.
(From Comet Halley Handbook, Courtesy D. K. Yeomans.)

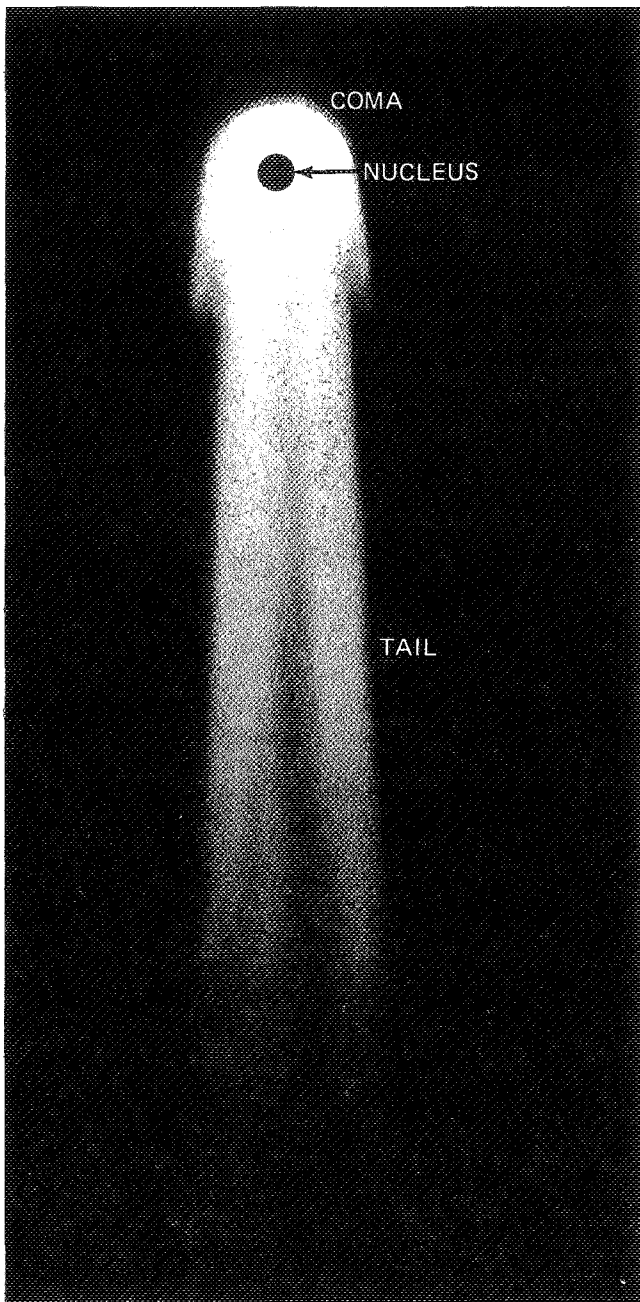

Figure 12. Artist's conception of a typical comet.

According to scientific theory, a light beam is composed of a stream of particles called photons. A beam of photons bouncing (reflected) off one side of a small dust particle exerts a force on it, and if the dust particle is small enough the photons can push it along. The intense sunlight falling on minute dust particles in the coma of a comet, when the comet is near the sun, pushes the dust particles out of the coma, producing the comet's tail which points *away from the sun* (Figure 13). If you look at Figure 14 you will notice two tails. One tail is gently curving and appears smooth. This tail is the dust tail, caused by the mechanical action of the solar radiation. The other tail is more nearly straight and has a turbulent appearance like

cigarette smoke in a breeze. That tail is composed of ionized molecules blown out of the coma by the solar wind, a stream of ionized atomic particles constantly blowing away from the sun. A color picture of a comet shows the dust tail to be yellowish, which is the color of sunlight reflected from the small particles. The gas tail is blue, on the other hand, caused by characteristic emissions of the ionized molecules present (predominantly CO^+).

As the comet approaches the sun, the coma is observed to grow. Clearly, this growth occurs because of increased sublimation of the ices of the nucleus. However, a point is reached when the coma may actually shrink as the comet approaches even closer to the sun. This shrinkage may occur when a point is reached when gas and dust are blown into the tail faster than it sublimates from the nucleus.

If an expert had been asked before 1969 to describe a comet, he would have told you about the nucleus, coma and tail. However, in 1969 and 1970 an unexpected discovery was made when the Orbiting Astronomical Observatory, OAO-2, was turned on Comet Tago-Sato-Kosaka and Comet Bennett. Each was found to be surrounded by a tenuous but giant cloud of hydrogen gas. The observations of comet Bennett were subsequently verified by the Orbiting Geophysical Observatory. The hydrogen cloud around comet Tago-Sato-Kosaka was as big as the sun, and the cloud around Comet Bennett was even larger. It is believed that the hydrogen cloud arises when ultraviolet photons from the sun break up water molecules sublimated from the nucleus, producing hydrogen and free OH radicals.

What happens to the material blown out of the comet's nucleus? Each dust particle circles the sun in an orbit similar to the parent comet's orbit. Eventually the entire path of the comet is outlined with dust. Occasionally, the earth passes not merely through the plane of the comet's orbit, but across the very path of the comet. Then the dust particles make their presence known as a shower of meteors (shooting stars). The particles are burned up in the earth's atmosphere due to the heat generated by friction between the air and the particles which may speed through the atmosphere as fast as 45 km/sec. For instance, the earth crosses the orbit of Comet Halley in May and again in October, each year, and each time a meteor shower is observed. The Eta Aquarid shower occurs in May and the Orionid shower in October. At the 1910 return the earth was to pass through the tail of Comet Halley. Some panic was generated by the announcement because of the noxious gasses in the tail. However, only the usual meteor shower resulted.

In some cases, the debris is bunched up in a clump which moves around the comet's orbit. In these

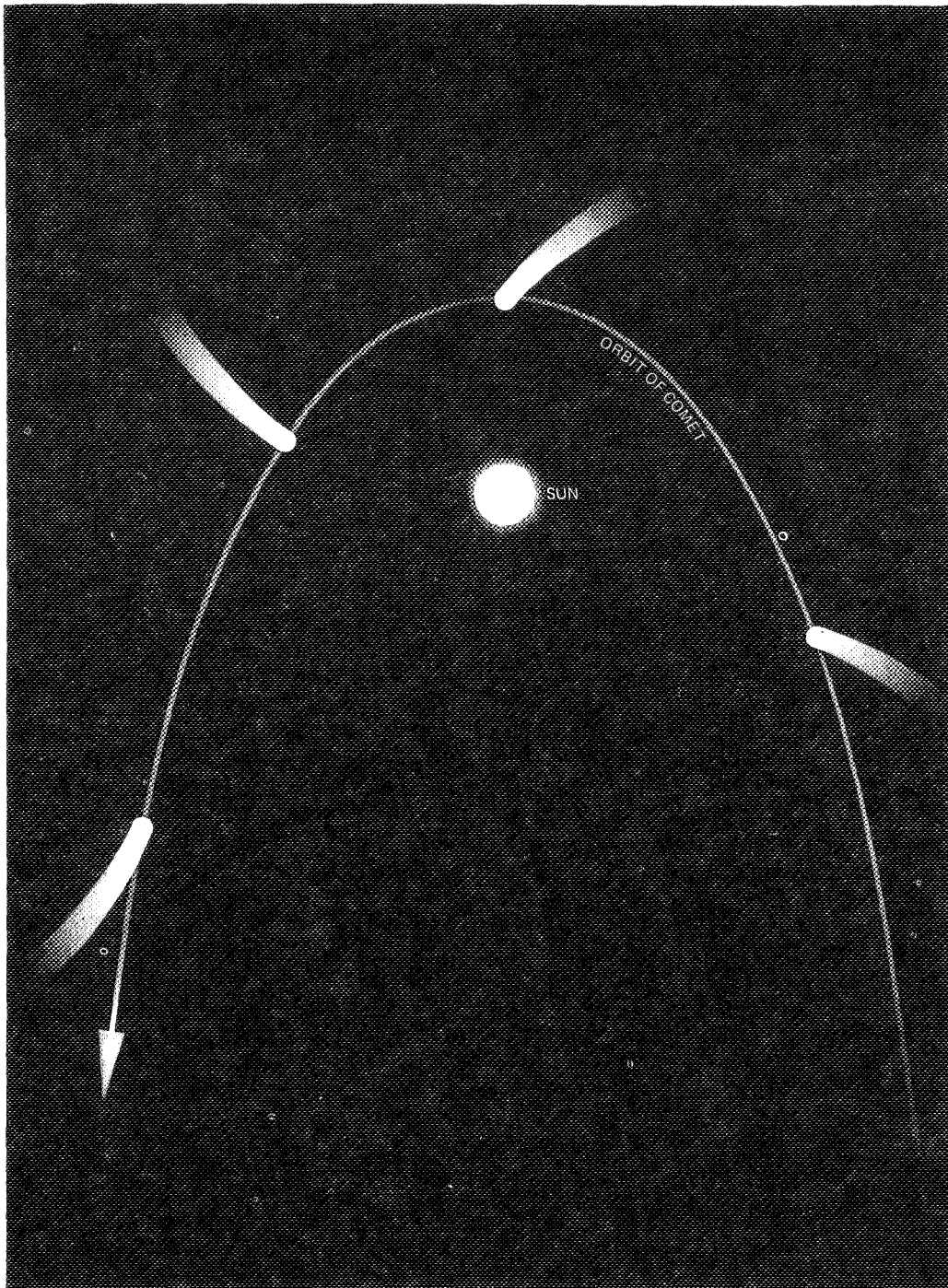

Figure 13. As a comet passes around the sun its tail swings around and always points away from the sun.

cases when the earth crosses the orbit only a few meteors are observed while at other times a spectacular meteor shower is observed. In 1866 the earth crossed the orbit of Comet 1866 I, and a meteor shower (the Leonid shower) with a rate of 100,000 meteors per hour was observed. As it turns out, the earth had also passed through the comet's orbit and met a dense shower in 1833, but in years between 1833 and 1866 no spectacular

shower was observed. The period of the comet in question is 33 years. In this case the debris is highly bunched up.

Since cometary nuclei slowly sublime while the comet is in the vicinity of the sun, it is clear that a comet must have a finite lifetime. Some estimates say that a comet cannot survive more than a few hundred close approaches to the sun.



Figure 14. Comet West on March 9, 1976. Note the gently curving, smooth dust tail uppermost in the picture and the straight but turbulent looking plasma tail. (Joint Observatory for Cometary Research photograph.)

We have arrived at a mystery. If a comet can last only a few hundred passes around the sun, then Comet Halley should live a few times 7500 years. Even a comet like Comet Kohoutek with a period estimated to be around 100,000 years will disintegrate in something like 10 million years. Both of these times is short compared to the 4 billion year age of the solar system. One would think, if this theory is correct, that there would be no comets left in the system today. Why do we see comets at all? Particularly, why do we see short period comets like Halley?

One possible answer to these questions was provided by the modern Dutch astronomer Jan Oort in 1950. He suggests that there exists a giant cloud of literally billions of comets completely surrounding the solar system at a distance from the sun at least as great as 150,000 times the earth's distance. This distance is a large fraction of the average distance between the sun and other nearby stars. Every few million years, one of the nearby stars, in their random motions through space will pass close enough to the sun to perturb a number of comets in the cloud. Some of these will be torn out of the solar system, and will fly off into space never to be seen again. However, some will be sent in toward the inner solar system. These comets will become long period comets, with periods of a few million years. A number of these comets will pass near the massive planet Jupiter on their trips through the inner solar system. The combined effect of Jupiter over several passes can be to slow the comet's motion, in which case it can gradually become a short period comet, forever remaining in the inner reaches of the system.

One fascinating aspect of Oort's theory is the thought that the comet cloud may actually be frozen chunks of the nebula out of which the sun and planets were formed, in which case comets consist of the primordial material of the solar system. What better reason that this do we have for the careful scrutiny of any comet? The hypothetical cloud of comets is now referred to as the Oort cloud in honor of Dr. Oort.

COMETS OF THE PAST

Many comets that have been observed over the last few centuries have exhibited unexpected behavior in various ways, and others have been spectacular because of their great size or brilliance. Lets look at some of the unusual comets of the past, since their behavior may tell us something of what to expect from Comet Halley and other bright comets that may appear in the near future.

Among the most unusual occurrences in the annals of cometary study is the behavior exhibited by Comet Biela. This comet, which had an orbital revolution period of 6.75 years, was observed for several passes in the late 18th and 19th centuries,

during which time it appeared to be a fairly ordinary comet. A few days after the comet was picked up on its return in 1846, it actually split into two distinct comets. For several months the two pieces followed one another in almost the same orbit, but with one trailing the other by 250,000 km (160,000 miles) or so. Each piece had an observable nucleus, a coma and a tail; in short, each was a complete comet. However, they underwent remarkable changes in brightness, with first one then the other being the most brilliant. In 1852, the comets returned on schedule, but now were about 2,400,000 km (1,500,000 miles) apart. The year 1866 was to be a particularly favorable one for viewing the comets, and astronomers awaited their return with great anticipation. But, alas, they have never been seen again.

Those of us sitting on the edges of our chairs awaiting the return of Comet Halley should take cognizance of Comet Enser which was discovered in 1906, and Comet Westphal which was discovered in 1913. Both comets were predicted to be spectacular when they passed perihelion, based on their orbits and on early observations. However, both comets grew very rapidly as they approached the sun and as they grew they became increasingly diffuse and faint, until they completely faded from view. By the time the comets should have passed perihelion they were nowhere to be seen. No doubt, in each of the cases we have described, we were seeing the end of the lives of the comets. In the case of Comet Biela, it had probably sublimed unevenly, leaving a distorted nucleus that could not hold together. After all, a snowball doesn't have much mechanical strength.

In June 1858 the Florentine astronomer G. B. Donati discovered a comet which appeared as a faint spot of light. In was not until late August of that year that the comet showed a tail, and then it was only as long as the diameter of the full moon. During September the comet increased remarkably in brightness as it approached the sun, and reached greatest brilliance in early October. The comet then had a tail which stretched one-fourth of the way across the sky, was very bright and easily visible to the unaided eye. After the comet passed perihelion, it moved very far south in the sky and could only be followed by southern hemisphere observers. It remained visible to large southern telescopes until March 1859.

Comets that are bright enough to be seen in broad daylight are few and far between. Estimates of the number range around four or five each century. The great comets of 1843 and 1882 were both daylight comets. If one would screen out the sun's full glare with a hand, one could easily have seen these comets. Interestingly, both comets fall into a class known as "sun grazing" comets. The comet of 1843 passed only 120,000 km (80,000 miles) above the surface of the sun and the comet of 1882 passed about 480,000 km (300,000 miles) above

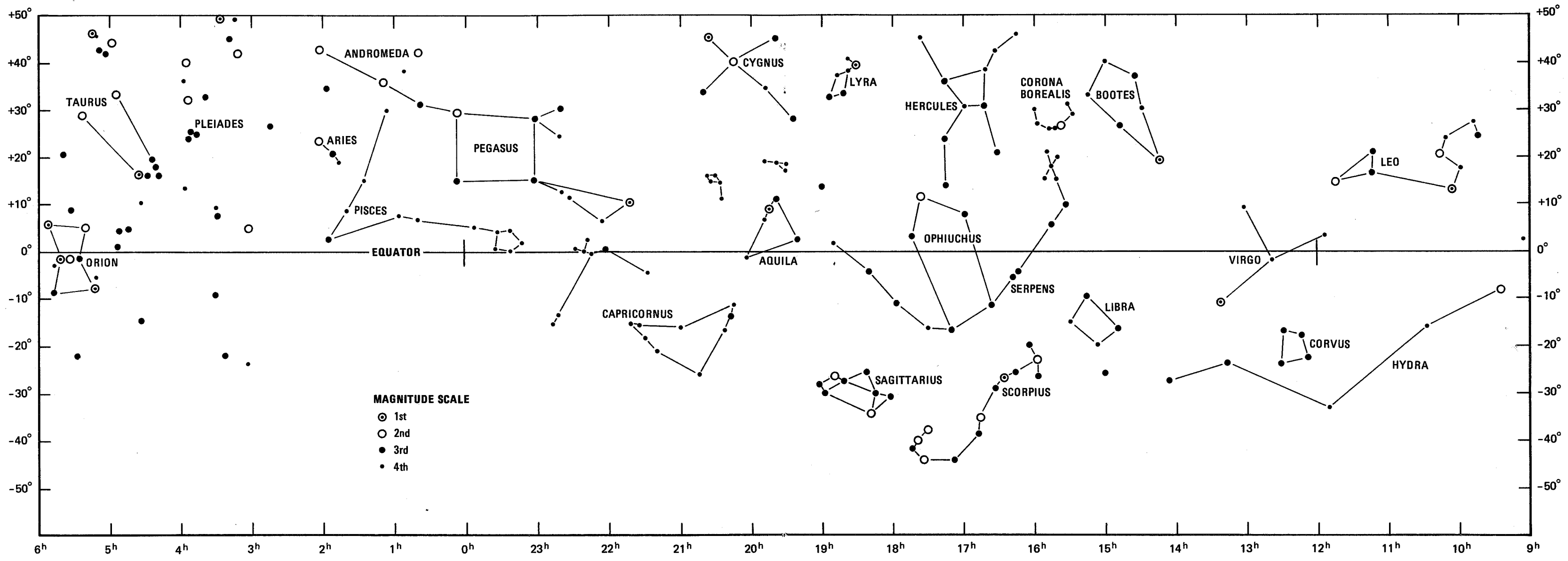

Centerfold — "STAR CHART"

the solar surface. These distances seem like a comfortable margin until we remember that the sun is 1,400,000 km (864,000 miles) in diameter, so in fact the distances are small compared to the size of the sun. The comet of 1882 was torn apart by the huge gravitational field of the sun; it was seen as four chunks after perihelion pass. The brightest sun grazing comet of the 20th century was Comet Ikeya-Seki observed in 1965.

Comet Howard-Koomens-Michels did the sun grazers one better. It plowed into the sun on August 30, 1979. The comet was discovered by an instrument flown on an Air Force satellite to study the solar corona. The comet was seen on several frames approaching very close to the sun, then it disappeared. At the moment of its disappearance, a portion of the corona increased measurably in brightness. One supposes that as the comet completely sublimed in the sun's ultra-hot atmosphere, the material briefly increased the density and therefore the brightness of the corona.

COMET HALLEY IN 1910

Comet Halley was rediscovered on its way toward its 1910 passage near the sun on September 11, 1909, roughly six months before it passed perihelion. Contrast this with the upcoming pass, when it was rediscovered 40 months before perihelion. This remarkable difference is due to the tremendous strides in technology in the 75 or so years between passes. One hopes that the discoveries during the rest of the 1985-86 pass are as much an improvement over 1910 as the discoveries to date. To give some idea of what we expect to see in 1985 and 1986, we will take a brief look at what happened in 1910. May 1910 was the most impressive time for Comet Halley. Then it was at its closest to the earth, and actually passed between the earth and the sun. On May 18, the tail of the comet was 120° long, its greatest length in 1910. Barnard described the comet during this period as quite bright to the naked eye, with a bluish white color.

On May 18, the comet passed directly between the earth and the sun. At the time of the actual transit of the solar disk, it was daylight in Europe, and detailed observations were made at the Moscow Observatory. The observations were completely negative. There was no sign of the comet as it passed across the sun. Given the geometry of the pass, the nucleus would have been seen in silhouette against the sun if it had been as large as 100 km. As we said earlier, we now think that the nucleus is a mere 5 km in diameter. The very tenuous coma caused no observable effect.

An interesting aspect of the passage of the comet between the sun and earth is the fact that the tail passed over or near the earth. The molecule cyanogen, CN, is a deadly poison, and there were those

that predicted the end of the world as the gas mixed into our atmosphere. The newspapers were filled with stories related to the impending passage of the comet. One entrepreneur down in Texas sold so-called comet pills to some of the unsuspecting locals. The pills, which turned out to be a harmless mixture of sugar and quinine, were supposed to ward off the evil effects of the cometary gasses. Business was brisk, and the fraudulent pill peddlers made a good piece of change, before they were caught. When the event actually happened, there was no noticeable effect, other than the meteor shower, mentioned earlier.

Recently, an interesting type of cometary event has been explained; a so-called disconnection event or DE in which a comet loses one tail and grows another. The event seems to occur when a comet crosses a region in space where the interplanetary magnetic field rapidly changes direction, and a process known as reconnection causes the tail to break off. A disconnection event was observed to occur in Comet Kohoutek in 1974, and then similar events were sought in other comets. A number of DEs have been found, including five in Comet Halley in 1910. Figure 15 shows one of the events. The unusual appendage to the comet's tail observed half way down the tail is actually the old tail that has been disconnected from the comet.

PLANS TO OBSERVE COMET HALLEY

There is a major worldwide effort underway to observe Comet Halley. Three different missions will encounter the comet in March 1986. The European Space Agency is mounting a mission called Giotto in honor of the great Italian painter who produced a masterful fresco of Comet Halley after its 1300 return. One of the chief objectives of the Giotto mission is close-up imaging of the nucleus of the comet. Images of the type the mission planners envision will go a long way toward proving or disproving Whipple's dirty iceberg model of the nucleus. Giotto will also study the gas and dust in the vicinity of the comet, and will measure its magnetic field. The Giotto spacecraft will pass within 1000 kilometers of the comet's nucleus in March 1986. The Soviet Union and Japan are each planning missions to the comet. The Soviet's spacecraft, built around their spacecraft that flew to Venus, will fly to within 10,000 km of the comet's nucleus. They call their mission VEGA. The Japanese *Planet A Mission* will pass within 100,000 kilometers of the nucleus, also in March 1986.

The United States is planning several efforts. The ASTRO mission consists of a group of instruments designed to carry out astronomical observations in the ultraviolet region of the spectrum from the Shuttle bay. NASA has decided to add a pair of small, wide field cameras to the payload to obtain images of the entire comet. The Astro payload will be sent into orbit for about a week when



Figure 15. Comet Halley (top to bottom) on June 6.66, 1910 from Wisconsin, on June 6.77, 1910 from Hawaii, and on June 7.29, 1910 from Lebanon. (Yerkes Observatory photograph.)

Comet Halley is closest to the earth, giving us our first detailed ultraviolet studies of the comet to compliment the studies done by the spacecraft mentioned above.

In addition to the Astro Mission, NASA is planning the International Halley Watch (IHW). The IHW will organize a series of ground-based observing networks to study the comet. The basic idea of the networks is as follows. Studies of Comet Halley in 1910 — and studies of other comets as well — showed that there are things happening in the comet that cannot be fully observed from one site. A complete disconnection event, for instance, takes about 24 hours. One night is too short to completely follow a DE, but so much happens during the daylight hours between two nights that it is hard to correlate what one sees on one night with what was seen the night before. The only answer is to observe the comet for 24 hours. This can be done by setting up a network of cooperating observatories all around the

world. As the sun rises at observatories in the Southwestern U.S., for instance, it is still dark in Hawaii. Thus Hawaiian observers can continue observing the comet for a number of hours. When the sun rises in Hawaii, it is night once again in Europe, and so forth. In the network to take large scale photographs of the comet to study such things as DEs, there are about 90 observatories spread around the world (Figure 16). Since there are so many observatories, it is also very likely that at least one of them will have clear skies when it is dark. The bottom line is, at least one observatory in the network will be able to observe the comet at any time. The wide-field imaging network is only one of several networks. Others will carry out spectroscopy, infrared and radio observations, photometry, and so forth. The data gathered by these networks will be essential to the understanding of the data collected by the spacecraft that will study the comet. We will see some very exciting observations come from these activities. I can't wait to see the close-up images of the nucleus.

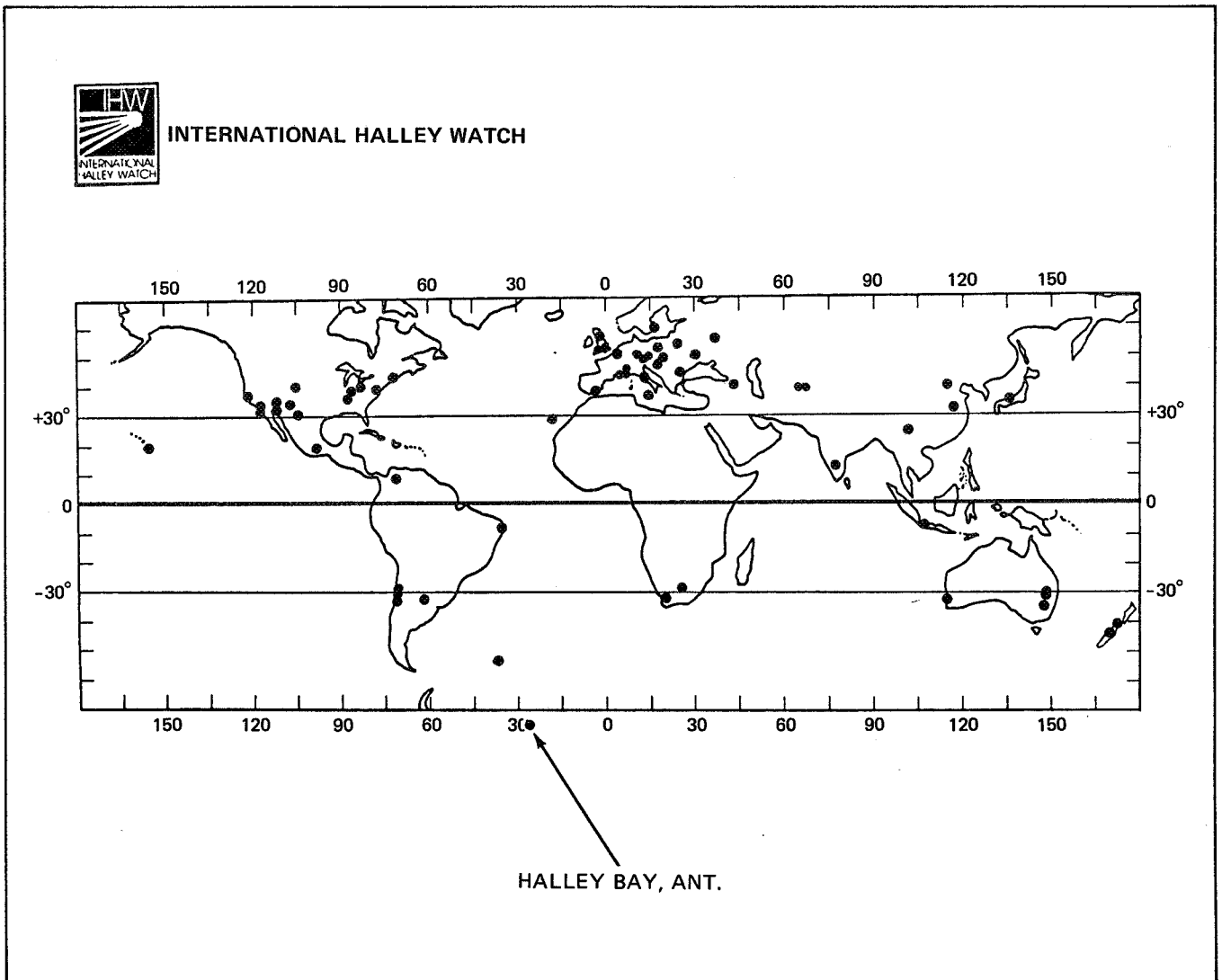

Figure 16. Observatories cooperating in the Large-Scale Phenomena Network of the International Halley Watch.

SELECTED READINGS

Brandt, John C.: *Comets: Readings from Scientific American*. San Francisco: W. H. Freeman and Company, 1981. This book is a compendium of articles about comets from Scientific American. It is appropriate for a well read high school student or above.

Brandt, John C., and Chapman, Robert D.: *Introduction to Comets*. New York: Cambridge University Press, 1981. This is a professional level book about comets aimed at advanced undergraduate students, professional astronomers, and advanced amateur astronomers.

Brown, Peter L.: *Comets, Meteorites and Men*. New York: Taplinger, 1974.

Calder, Nigel: *The Comet is Coming: The Feverish Legacy of Mr. Halley*. New York: Viking Press, 1981.

Chapman, Robert D., and Brandt, John C.: *The Comet Book*. Boston: Jones and Bartlett Publishers, 1984. This book, to be published in late 1984, is a popular level book that should be accessible by a wide range of readers.

Muirden, James: *The Amateur Astronomers Handbook*. New York: Harper and Row, 1983.

Norton, Arthur P.: *Norton's Star Atlas*. Cambridge, Mass.: Sky Publishing Corp., 1978.

Roth, G. D., ed.: *Astronomy Handbook*. New York: Springer-Verlag, 1975.

Wilkening, Laurel L., ed.: *Comets*. Tucson, AZ: U. of Arizona Press, 1982. This book is a compendium of technical articles on comets written by the experts in the field and skillfully edited by Wilkening.

Yeomans, Donald K.: *The Comet Halley Handbook: An Observers Guide*. Second Edition. Pasadena, CA: NASA Jet Propulsion Laboratory, 1983. This guide contains a wealth of information for the potential serious observer of the comet. Of special note is the extensive ephemeris for Comet Halley.

Part II

EDUCATIONAL ACTIVITIES

The first part of this book described the nature of comets, with particular emphasis on Comet Halley. The appearance of Comet Halley in the sky will offer a unique learning experience for students at all levels. In this part of the book, we will suggest a number of activities that you can use to take maximum advantage of the opportunity. The suggested activities cover a wide range of skills in science and mathematics. Some of the activities are quite appropriate for primary grades, and others require the skills learned in the secondary grades. Clearly, you the teacher will have to decide which of the activities is appropriate for your students. In some cases, it will be possible for you to adapt an exercise to your specific needs. The material is meant to serve as a guide and as a help to you. Be creative in its use.

Some of the activities can be done in the classroom. These activities are included to provide an understanding of the historical importance of the comet, and to enhance the student's understanding of these wonderful celestial objects. However, it is essential that the students be encouraged to get outdoors to observe the comet first hand, when it is visible. Several activities are included that will introduce the skills and knowledge required to locate and observe Comet Halley. Comet Halley is an ideal subject for bulletin board displays in schools, by the way.

IN THE CLASSROOM

During the span of almost 2100 years during which Comet Halley has been observed to return from the depths of space to pass by the sun, we have come a long way in our understanding of comets — from ancient times when comets were considered to be vapors burning in the upper atmosphere, to modern times with our capability to send space missions right up to the comet. The study of Comet Halley has given astronomers valuable insights in the past, and will continue to provide unique information about the nature of comets.

Every return of Comet Halley to the vicinity of earth has been recorded since 239 B.C., with one exception. We know of no records of the comet from the 163 B.C. return. Each time the comet passes the earth it finds the planet in a slightly different state; after all, great changes can take place in our civilized society in just 76 years. Just think about the tremendous technological changes that have taken place since Comet Halley's last visit in 1910. Comet Halley would find differences in the size of the population, advances in medicine and science, and additions to the great creations of music, art and literature. Table 1 lists the years

in which the comet has been observed during its pass near earth.

Table 1
List of Years when Comet Halley was Observed from Earth

B.C.				
239	86	11		
A.D.				
66	141	218	295	374
451	530	607	684	760
837	912	1066	1145	1222
1301	1378	1456	1531	1607
1682	1759	1835	1910	1986

As an activity, have your students be chroniclers of time. Either individually or as a group exercise, have the students imagine that they are reporters onboard Comet Halley. They should report the news of planet earth as viewed from the comet for one particular passage. The categories that can be included in the news account depends on the age group of the students. Some examples of the type of information that students might include are: the population of earth; explorations being made at the time; major modes of transportation; the geography of the known part of the planet; art, music and literature of the time period; scientific discoveries; wars and political issues; feelings about the comet; and other major issues of the time.

The students might report their news through the newspaper format, radio shows, or where equipment is available, over closed circuit television. When everything is complete, you might have a community open house to view and hear about the history of the earth as viewed from Comet Halley.

Newspaper Accounts

The newspapers of May 1910 contained a great deal of information about Comet Halley because that month the earth was supposed to fly through the comet's tail. Banner headlines at the time included such comments as this one from the May 18, 1910 *New York Times*.

CHICAGO IS TERRIFIED

Women are Stopping up Doors and
Windows to Keep Out Cyanogen

Have your students do a library search of hometown newspapers to find out local reaction to Comet Halley. It would be easiest to limit the search to May 1910, when a lot of comet activity occurred.

Oral History

There are still people alive today who saw Comet Halley during 1910. Have your students do oral history interviews with individuals who saw it. An announcement over the local radio or television stations or a request in the local newspaper will help the students locate possible resource persons to interview.

Have your students record their interviews on a tape recorder. It is important to prepare for the interview. Beforehand, make sure the students have their questions written out. Such questions as the following might be included: How old were you when you saw Comet Halley? Where were you living at the time? What are some of the things you remember about Comet Halley? Was there a lot of excitement associated with the return of Comet Halley? What were some of the reactions to it? How did people learn about Comet Halley since there was no radio or television to tell them about it? Were you afraid?

Time Capsule

After doing the exercises suggested to provide a historical perspective about Comet Halley, the students will be aware that changes occur very rapidly on earth. To get ready for the next passage, have your students prepare a time capsule. The time capsule might contain student predictions of happenings on earth during Comet Halley's next return in 2062. You might even plan to bury the time capsule on February 9, 1986, the date when the comet is at its perihelion point. The time capsule could then be opened on the perihelion date in 2062. Students could be guided to predict such things as: average life spans; the population of their city; science advances at the time; what we will be doing in space; and major concerns of the citizens of their city, the U.S., and the world in 2062.

As an alternative to the time capsule, your students could publish their predictions in the local newspaper so that some future student doing a literature search in 2062 will discover this information.

Comet Halley Artistically Speaking

In 1910 cameras were used for the first time to photograph Comet Halley. Before 1910, artists rendered Comet Halley on several different occasions. For instance, it was depicted on the famous Bayeux Tapestry that highlighted the victory of William the Conqueror in 1066 at the battle of Hastings. Art historians believe that Comet Halley served as the model for the Star of Bethlehem in Giotto's "The Adoration of the Magi." This spectacular work of art is one of the works in the fresco cycle executed by Giotto di Bondone in the Scrovegni Chapel in Padua. There have been

numerous poems and works of literature that mention Comet Halley.

Your students could follow in the path of the great masters of the past and compose works of art inspired by the comet. Have your students write a poem or compose a song about Comet Halley. Have them make a painting or drawing of the comet as they observe it. They could design a T-shirt with the comet on it, or sculpt a paper mache model of it. Perhaps you could even sponsor an art show to display various Comet Halley pieces created by your students.

Comets and Life Sciences

There are some articles in the literature today that speculate on the role of comets in spreading life throughout the universe. Some scientists have suggested that a rudimentary form of life might form in the nucleus of a comet, which would then collide with a planet planting the seeds for the formation of life. There have even been suggestions that a comet collided with the earth and led to the extinction of the dinosaurs. In this case, the collision would have produced a giant cloud of dust which would have blocked sunlight and cooled the earth, affecting the dinosaur's food supply. These ideas provide excellent research topics for your students. Have them survey the literature on the topic and decide for themselves if there might be any basis for the speculation. Have your students speculate on what would happen if a comet as large as Comet Halley were to collide with earth today. Such a collision is highly unlikely, but not impossible. What is the likelihood that such a collision would affect populated areas of the planet?

Comet Hall of Fame

Over the past 2100 years, there have been a number of individuals who have contributed significantly to our understanding of comets. Have your students do a "Comet Hall of Fame." When possible, students should include a picture of the person as well as a biographical sketch and a description of the contribution to comet science for each contributor. Some of the "Hall of Famers" might include: Aristotle, Isaac Newton, Johannes Kepler, Edmund Halley, Tycho Brahe, John Winthrop, Friedrich Wilhelm Bessel, Jan Oort, Fred Whipple, and E. E. Barnard.

OBSERVING THE COMET

As discussed earlier Comet Halley will not be nearly as spectacular in 1985-86 as it was in 1910. However, with patience and care the comet can be observed. It will be at its brightest around December 1985 and again in April 1986. It will not be easily visible from large cities particularly in the Northeastern U.S. If you live in that area of

the country, you will have to get out into the country away from city lights and air pollution. But the effort will be worth every bit of the effort. Figure 17 is a star chart showing the path among the stars. This chart, along with Figures 9, 10, and 11 should be sufficient to permit you to locate the comet in the sky.

Brightness

Everyone has noticed how some stars appear brighter than others. The brightnesses of stars are described by their apparent magnitudes. The magnitude scale used in astronomy has developed over the years into a well defined, but somewhat arbitrary scale. The brightest stars in the sky are more or less first magnitude, and the faintest stars visible to someone with good eyesight and ideal observing conditions (no clouds, city lights, or air pollution) is sixth magnitude. The brighter a star, the lower the numerical value of its magnitude. The brightest stars in the constellations Orion, Bootes, and Lyra (Rigel, Arcturus, and Vega) are extremely bright. These stars are zero magnitude objects. They are the first stars to be seen in the evening sunset and the last to be seen in the morning twilight. First magnitude stars are also very bright. The brightest stars in Scorpius, Cygnus, and Virgo (Antares, Deneb, and Spica) are a few examples. The second magnitude stars such as Polaris, the pole star, are moderately bright and can be easily identified. Third magnitude stars are still fainter. On a misty night these are usually the faintest stars that one can see. The fourth magnitude stars are visible on a moonlit or hazy night. Fifth and sixth magnitude stars are visible only under the most ideal conditions. If you are used to the kinds of skies you see around cities, you can be confused by a very clear sky. If you were to go to a high mountain-top in the Southwest on a superclear night there seem to be so many stars in the sky that it takes a minute or so to find the constellations. Figure 18 is a sketch of the Little Dipper, with the magnitudes of the stars indicated. Since the stars are magnitudes 2, 3, 4, and 5, it makes a good reference in the sky. You can also get a feeling for the viewing conditions on a given night by checking the Little Dipper. If you can see all the stars clearly, it is a fairly good night.

The following formulas will let your students predict the total magnitude of Comet Halley. Here we must be careful with our understanding of what magnitude means. The comet is not a point object like a star, but is spread out over a larger area. The total magnitude is the brightness the comet would have if the light were concentrated into a starlike image. You can imagine that if we were to spread out the light of a star over a comet sized area it would seem fainter. A comet that is third magnitude will be harder to see than a third magnitude star, for instance. The formulas were determined from the behavior of Comet Halley at its previous passes; that is, they are empirical formulas. The

same formula will not work for both pre-perihelion and post-perihelion magnitudes.

Pre-Perihelion:

$$\begin{aligned} & \text{Total Apparent Magnitude} \\ & = 5.47 + 5.0 \times \log(\Delta) + 11.1 \times \log(R) \end{aligned}$$

Post-Perihelion:

$$\begin{aligned} & \text{Total Apparent Magnitude} \\ & = 4.94 + 5.0 \times \log(\Delta) + 7.68 \times \log(R) \end{aligned}$$

In these formulas the symbol Δ stands for the distance from the earth to the comet, which we call the geocentric distance, and the symbol R stands for the distance from the sun to the comet, which we call the heliocentric distance. The magnitude depends on both distances for a simple reason. The distance from the sun determines how much light reaches the comet, and the distance from the earth to the comet determines how much of the light reflected by the comet reaches us. Hidden in the constants are assumptions about the reflectivity of the comet. Included in the 5.0 multiplying the logarithm of Δ and the constant multiplying the logarithm of R is the fact that the brightness of an object decreases with the inverse square of its distance.

In Table 2 we list the geocentric and heliocentric distances of Comet Halley at selected times. The following example for October 15, 1985, when $\Delta = 1.59$ and $R = 2.16$ shows how students can calculate total magnitudes for the comet.

$$\begin{aligned} & \text{Total Apparent Magnitude} \\ & = 5.47 + 5.0 \times \log(1.59) + 11.1 \times \log(2.16) \\ & = 5.47 + 5.0 \times 0.201 + 11.1 \times 0.344 \\ & = 5.47 + 1.005 + 3.707 \\ & = 10.2 \end{aligned}$$

The formulas are not sufficiently precise to permit us to calculate magnitudes to more than one figure after the decimal point. Have your students calculate some magnitudes from the data in Table 2. We have given magnitudes as checks for your students, or for you to use if this exercise is too advanced for your students.

From January through April, Comet Halley will have an apparent magnitude in the range 4 to 5. So beware of the fact that it will require ideal conditions to observe the comet. Have the students compare the apparent magnitude of Comet Halley with the stars in the Little Dipper. How can we compensate for the fact that the stars are points of light and the comet is an extended object? One way is to observe the stars with binoculars that have been purposely racked out of focus to give extended star images.

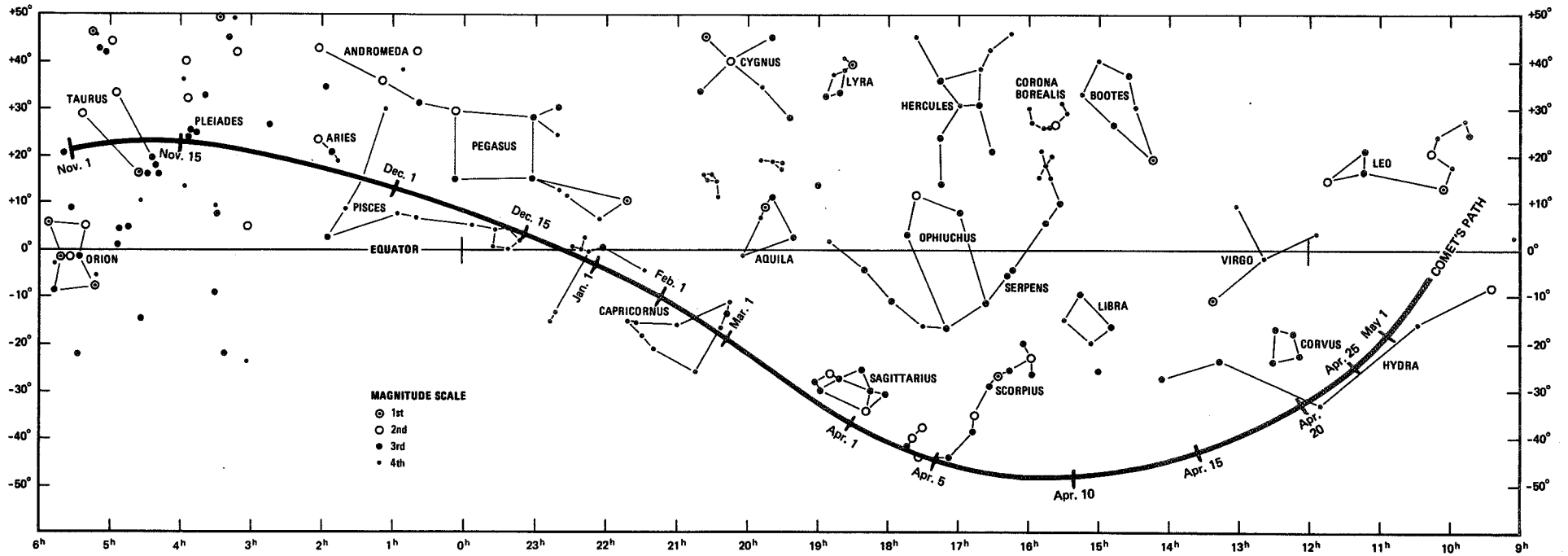

Figure 17. Path of Comet Halley between November 1985 and May 1986.

Table 2
Selected Ephemeris of Comet Halley

DATE		R.A.		DEC		Δ	R	MAG	θ	β
		H	M	°	'	A.U.	A.U.		°	°
1984	6 3	6	10	+13	53	7.99	7.06	—	21.9	3.1
	8 8	6	37	+13	49	7.31	6.53	—	37.5	5.4
	9 1	6	45	+13	27	6.81	6.34	—	58.2	7.8
	10 1	6	48	+12	50	6.07	6.09	—	86.1	9.4
	11 1	6	41	+12	14	5.29	5.81	—	118.0	8.7
	12 1	6	20	+11	54	4.67	5.56	—	151.7	4.8
1985	1 1	5	47	+12	03	4.33	5.28	—	162.3	3.2
	2 1	5	16	+12	41	4.35	4.77	—	126.2	9.2
	3 1	4	58	+13	39	4.55	4.73	—	94.3	12.1
	4 1	4	53	+14	55	4.79	4.42	16.0	62.8	11.6
	5 1	5	00	+16	12	4.89	4.12	15.7	35.5	8.2
1985	6 1	5	15	+17	22	4.78	3.79	15.3	10.5	2.8
	7 1	5	33	+18	15	4.44	3.47	14.7	15.3	4.5
	8 1	5	54	+18	53	3.81	3.10	13.8	40.3	12.2
	9 1	6	11	+19	21	2.98	2.73	12.7	66.1	19.8
	10 1	6	13	+20	00	2.04	2.34	11.1	94.6	25.2
1985	10 15	6	03	+20	38	1.59	2.16	10.2	110.8	25.6
	11 1	5	24	+21	50	1.07	1.92	8.8	136.8	20.7
	11 15	4	00	+22	02	0.74	1.72	7.4	170.1	5.7
	11 20	3	11	+20	50	0.66	1.65	7.0	172.8	4.3
	11 25	2	14	+18	20	0.62	1.57	6.6	154.5	15.7
1985	12 1	1	07	+13	51	0.63	1.48	6.4	131.7	29.7
	12 5	0	28	+10	34	0.67	1.42	6.3	117.6	37.9
	12 10	23	48	+06	51	0.73	1.35	6.2	102.1	45.7
	12 15	23	18	+03	49	0.82	1.27	6.2	88.8	50.8
	12 20	22	54	+01	26	0.92	1.19	6.1	77.5	53.7
	12 25	22	36	-00	24	1.02	1.11	6.0	67.6	54.7
1986	1 1	22	17	-02	23	1.16	1.01	5.8	55.3	53.4
	1 15	21	48	-05	13	1.50	0.80	5.1	33.7	43.0
	2 1	21	18	-08	27	1.56	0.62	4.1	10.2	16.5
	2 6	21	09	-09	34	1.56	0.59	3.9	6.5	10.9
	2 15	20	53	-11	51	1.50	0.60	4.1	14.7	24.8
1986	3 1	20	28	-16	12	1.27	0.72	4.4	34.7	51.3
	3 5	20	21	-17	42	1.18	0.77	4.4	40.7	56.6
	3 10	20	11	-19	52	1.06	0.84	4.5	48.4	61.6
	3 15	20	00	-22	30	0.94	0.92	4.5	56.6	64.8
	3 20	19	44	-25	51	0.81	0.99	4.5	65.8	66.1
1986	3 25	19	22	-30	15	0.69	1.07	4.3	76.5	65.0
	4 1	18	24	-38	45	0.53	1.18	4.1	96.0	57.5
	4 5	17	22	-44	14	0.46	1.24	4.0	110.6	49.1
	4 8	16	16	-47	06	0.43	1.29	3.9	123.1	40.7
	4 10	15	24	-47	32	0.42	1.32	4.0	131.5	34.8
1986	4 12	14	32	-46	24	0.42	1.35	4.0	139.2	29.1
	4 14	13	44	-43	53	0.43	1.38	4.2	145.2	24.6
	4 16	13	03	-40	28	0.45	1.41	4.4	148.7	21.7
	4 18	12	31	-36	43	0.48	1.44	4.6	149.3	20.9
	4 20	12	06	-33	00	0.52	1.47	4.8	147.7	21.4
1986	4 25	11	24	-25	06	0.64	1.54	5.4	139.3	25.1
	5 1	10	56	-18	31	0.80	1.63	6.1	128.5	28.9
	5 15	10	31	-10	32	1.24	1.84	7.4	108.7	31.4
	6 1	10	26	-06	45	1.80	2.08	8.7	90.5	29.3
	7 1	10	34	-05	10	2.74	2.47	10.2	64.5	21.7
1986	8 1	10	52	-06	03	3.57	2.86	11.2	39.9	13.1
	9 1	11	11	-08	00	4.17	3.23	12.0	18.2	5.6
	10 1	11	27	-10	21	4.52	3.57	12.5	16.7	4.6
	11 1	11	39	-12	54	4.62	3.91	12.8	40.0	9.4
	12 1	11	42	-15	06	4.50	4.22	13.0	67.4	12.5
1987	1 1	11	31	-16	30	4.27	4.53	13.1	99.4	12.4
	2 1	11	05	-16	07	4.10	4.83	13.3	133.9	8.5
	3 1	10	34	-13	48	4.16	5.10	13.5	158.1	4.2
	4 1	10	05	-10	03	4.57	5.38	13.8	141.2	6.7
	5 1	9	49	-06	53	5.21	5.65	14.3	110.8	9.6

NOTE: R.A. and DEC are the right ascension and declination of Comet Halley, using the equinox of the date. Δ is the distance from Comet Halley to the earth, the geocentric distance. R is the distance from Comet Halley to the sun, the heliocentric distance. MAG is the total magnitude. θ is the angle between the sun and the comet as seen from earth, and β is the angle between the sun and the earth as seen from the comet.

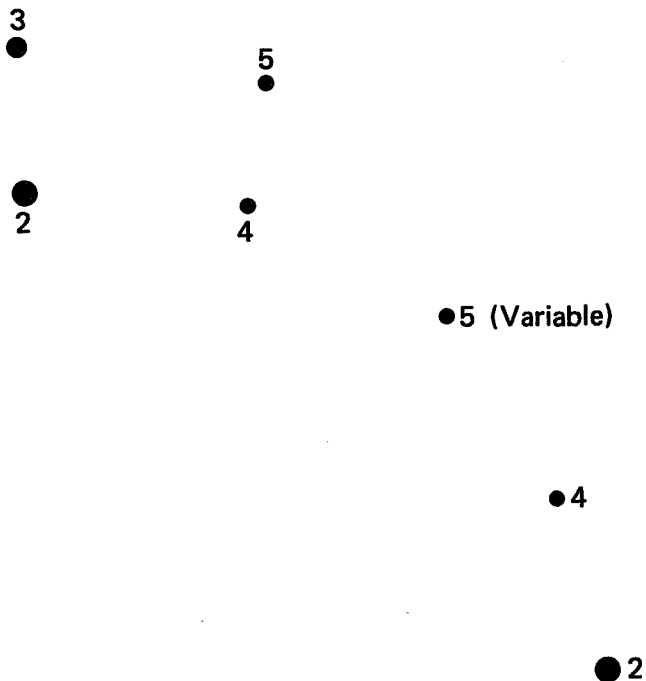

Figure 18. The Little Dipper showing the magnitudes of the stars.

With a wide angle telescope or a pair of binoculars, students will be able to see Comet Halley before it becomes visible to the unaided eye. Figure 19 is a graph of the limiting magnitude for various objective apertures (the diameter of the main lens of the telescope or binoculars), given in inches. A 7 X 50 pair of binoculars has an objective of 50 mm \div 25.4 mm/inch or 2 inches (rounded to the nearest whole

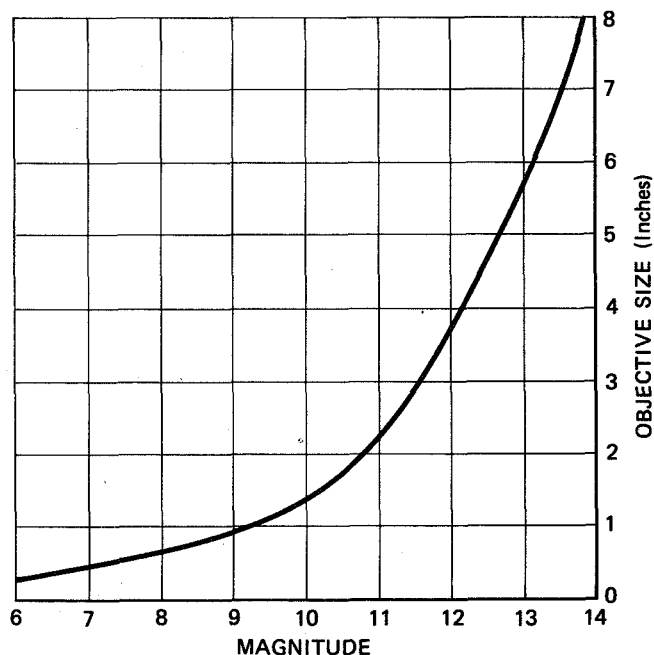

Figure 19. A graph of the limiting magnitude versus objective size in inches for telescopes or binoculars.

number). Under ideal conditions, a pair of 7 X 50 binoculars should let us observe Comet Halley when it has a magnitude of 10.8.

Length of Comet Halley's Tail in Miles

Measuring angles in the sky is not very difficult. There are several good angle reference points in the sky. For instance, the Moon is about one-half degree in diameter. The pointer stars in the Big Dipper are 5° apart, while the stars on the top of the bowl of the Dipper are 10° apart (see Figure 20). A paper clip held at arms length can be used like calipers to measure angles in the sky as shown in Figure 21. A cross staff can also be constructed to measure the length of the comet's tail (or other large angles on the sky) in degrees, with moderate precision. To construct a cross staff, carry out the following steps.

1. Select a straight length of 1" by 1" lumber, at least 36" long.
2. Decide on one of the 1" sides to be the top, then mark off 1" increments along each side of the stick. Starting at either end, number the marks 1", 2", 3", and so on.
3. Drive two nails into the top of the stick, one at each end to serve as sights.
4. Select a second piece of 1" by 1" lumber, at least 21" in length to be the cross piece. Carefully find and mark its center. Then mark 1" increments on the sides, beginning at the center. Number these increments 1", 2", and so on, beginning at the center and working outward toward each end.
5. Drive a nail at the 2" mark, the 5" mark, and the 10" mark at each side of the center.
6. Construct a slide mechanism for the cross piece. The simplest way is to drive a nail on the bottom of the cross piece 1-1/2" from the center on each side of the center. Bend the nails toward the center to serve as a slide.

Figure 22 shows a cross staff built to these specifications. Notice that it has a slightly better slide mechanism made from two blocks of 1" by 1" lumber. The cross staff is easy to use. Hold it just as the young lady is doing in the figure, and align the sight nails on the long piece with one end of the comet. Then slide the cross piece backward or forward until one of the nails (the 2", the 5", or the 10") on the cross piece is aligned with the other end of the comet. Read two numbers from the cross staff: the distance of the cross piece from your eye, and the distance from the center of the cross piece of the nail that you used for the other end of the comet. Table 3 can be used to convert these measurements to degrees.

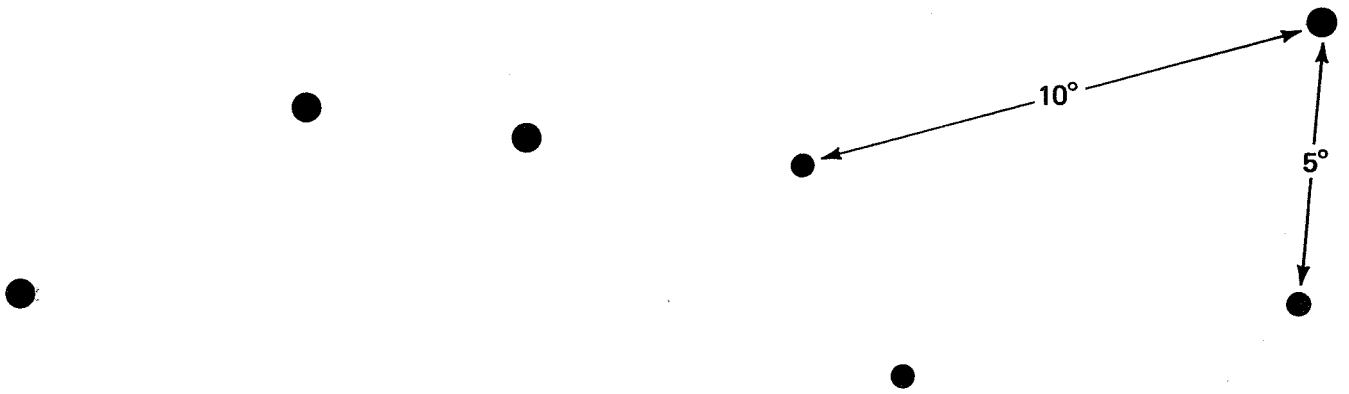

Figure 20. The Big Dipper showing angle scales.

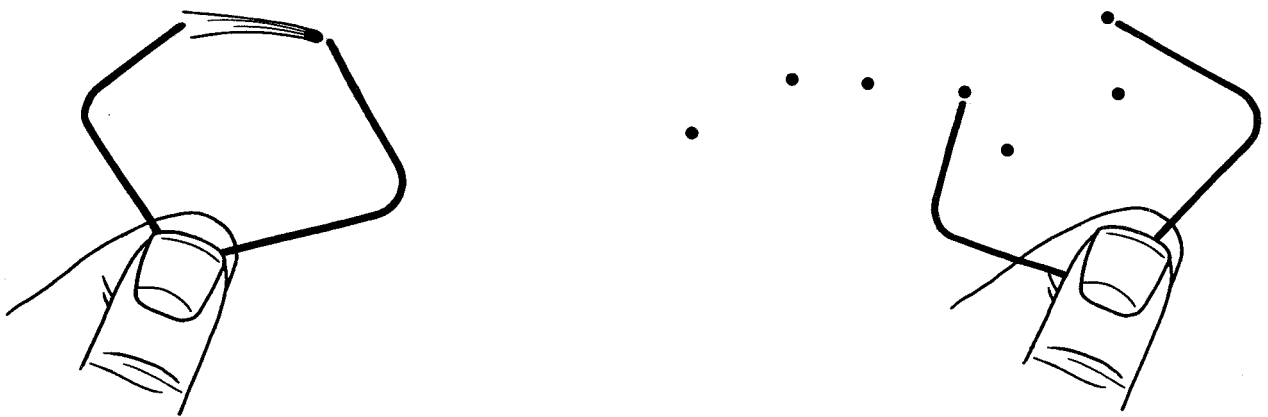

Figure 21. Using a paper clip held at arms length to compare known angular extents in the sky with unknown extents.



Aim the cross staff at the head and tail of the comet to determine the angular measurement of Comet Halley.

Figure 22. Using a well made cross staff to measure angles. The construction of the cross staff is reasonably clear in the photograph.

Table 3
Conversions for Cross Staff Measurements

Length (inches)	Width		
	2 inches	5 inches	10 inches
	Angle in Degrees		
2	45.0	68.2	78.7
3	33.7	59.0	73.3
5	21.8	45.0	63.4
8	14.0	32.0	51.3
12	9.5	22.6	39.8
15	7.6	18.4	33.7
18	6.3	15.5	29.1
21	5.4	13.4	25.5
24	4.8	11.8	22.6
27	4.2	10.5	20.3
30	3.8	9.5	18.4
33	3.5	8.6	16.9
36	3.2	7.9	15.5

Once the observed length of the tail is measured in degrees, its length in kilometers, miles or astronomical units can be calculated. Remember that one astronomical unit is 150,000,000 kilometers or 93,000,000 miles.

$$\begin{aligned} &\text{Length of tail} \\ &= \text{geocentric distance} \times \\ &\sin(\text{observed length in degrees}) \end{aligned}$$

Suppose that on January 15, 1986, your students observe Comet Halley to have a 5° tail. Look up the geocentric distance in Table 2, and find the sine of the tail length in a convenient trig table. Then

$$\begin{aligned} \text{Length} &= 1.50 \times \sin(5^\circ) \\ &= 1.50 \times 0.087 = 0.13 \text{ astronomical unit.} \end{aligned}$$

The tail of the comet does not lie exactly in the plane of the sky. It may also have extent toward or away from you. Have your students discuss the length you calculate in light of this fact. To compensate for the projection effect, you can divide the length calculated above by

$$\sin(\text{sun-comet-earth angle in degrees} - \text{observed comet tail length in degrees})$$

where the sun-comet-earth angle is the angle β in Table 2.

Recording Observations

It is very important for the students to record their observations. A suggested Comet Halley observation form is included. Careful recording of their observations will permit students to compare one observation with another.

The students should be encouraged to make drawings of the comet as accurately as possible. The nucleus (if one is visible), coma, and tail of the comet should be recorded for each observation. The other data required on the form should also be recorded. When possible, students should compare unaided eye views of the comet with those made through a telescope or binoculars. Have the students list advantages of viewing the comet with the telescope or binoculars. Have them determine some of the advantages of viewing the comet without use of a telescope or binoculars.

Students should be encouraged to photograph Comet Halley when they have the appropriate equipment. The camera with standard lens must be mounted on a tripod and fast color or black and white film must be used. The students should experiment with different exposure times. They might try a sequence of shots like 5, 20, 40, and 80 seconds. Longer exposures will smear the comet due to the earth's rotation.

If your school has a clock driven telescope, it might be used as a base for the camera. The camera should be fastened (tape will be fine) to the forward part of the telescope. With a clock driven telescope longer exposures can be made. If a black and white photograph is being made during a time when the moon is out or during twilight, a red filter might be used. Increase your exposure times by a factor of four to compensate for the filter. Try several exposures of different lengths. Use the photographs to determine the magnitude of Comet Halley from the stars. The magnitude of stars can be determined from various observer handbooks.

Plotting the Location of Comet Halley

A familiarity with the use of a star chart and knowledge of how to plot the locations of Comet Halley are needed to successfully "keep track" of Halley. A star chart is included to assist you in this activity. See center of booklet and Figure 17.

Notice on the star chart that the constellations are named. Constellations are "pictures" in the sky and are used to identify the different sky regions. The different sized dots represent the different magnitudes of the stars. (Refer to the magnitude key on the star chart.) Also, notice the line that runs through the center of the star chart in an east-west direction. This line is celestial equator. The celestial equator is nothing more than the earth's equator projected onto the plane of the sky.

To find a location on earth, one uses longitude and latitude; however, different terms are used in reference to analogous coordinates in the sky. In the sky, right ascension (RA) is the coordinator equivalent to longitude and declination is equivalent to latitude. Notice on the star chart that at the bottom are a series of numbers 6, 5, . . . , 0, 23, . . . 9. Each number is the right ascension of that area of

COMET HALLEY OBSERVATION FORM

Name _____

Date _____ Time of Observation _____

Observer Location _____

Weather Conditions _____

Moon Phase _____

Comet Halley's Location in Sky: _____

Degrees Above Horizon _____ Constellation Region _____

Sketch Area of Sky

PHYSICAL APPEARANCE OF COMET FORM

UNAIDED EYE VIEW	TELESCOPE/BINOCULAR VIEW
<p>Length of tail in degrees _____</p> <p>Color of Comet _____</p> <p>Estimated Magnitude _____</p> <p>Description of Nucleus, Coma, Tail _____</p> <p>_____</p> <p>_____</p> <p>Drawings (Comet shape, direction, length of tail)</p>	<p>Size of Objective _____</p> <p>Magnification _____</p> <p>Length of tail in degrees _____</p> <p>Color of Comet _____</p> <p>Estimated Magnitude _____</p> <p>Description of Nucleus, Coma, Tail _____</p> <p>_____</p> <p>_____</p> <p>Drawings (Comet shape, direction, length of tail)</p>

the sky. Right ascension is measured eastward from the Vernal Equinox along the celestial equator, in hours. Every degree moved eastward from the Vernal Equinox equals an addition of four minutes of right ascension. Therefore, 15° east of the Vernal Equinox is equal to one hour of RA; 30° east equals two hours of RA, etc.

On a star chart one uses a “+” sign to represent locations north of the celestial equator and a “-” sign for locations south of the celestial equator. An object with the declination of +15° is 15° north of the celestial equator, while -15° would place the object 15° south of the celestial equator. Table 2 lists selected RA and declination locations for Comet Halley from 1981-1987. A more inclusive list can be found in an ephemeris, such as that in the Comet Halley Handbook (see Bibliography). As an activity, have the students plot the positions for Comet Halley on a star chart. Generally, the planets and the moon move from west to east among the stars. This is not so for Comet Halley. Halley moves from east to west.

To plot Halley’s positions, the students are to put a point at the intersection of the RA and declination locations for each of the dates given. Notice that Halley’s motion among the stars is not a smooth line from east to west. Halley’s apparent motion appears to loop occasionally. This is a result of the earth passing Comet Halley during our orbit around the sun for that particular year. Again, a general astronomy textbook will provide a more detailed explanation of retrograde motion.

Once the plotting exercise is completed, students can use their star charts to assist them in locating Comet Halley either with an optical instrument or the naked eye. The star chart will be especially helpful from November 1985 through May 1986.

Comet Halley’s Orbit

Earlier we discussed the elements of the orbit of a comet. To supplement this information, have your students construct a model of Comet Halley’s orbit. Figure 23 gives an overview of the angular elements of Comet Halley’s orbit, near the earth’s orbit.

1. Construct the earth’s orbit. On a piece of poster board roughly 24” x 24” draw a circle with a diameter of 6 inches. In this case 3” equals one astronomical unit. The sun is located at the center of the circle. Then draw another circle with a diameter of 12 inches to provide a 2 A.U. scale, and a circle with an 18” diameter to provide a 3 A.U. scale. Next divide the earth’s orbit into 12 equal parts. Each part is to represent the earth’s location for one month of the year. Label the earth’s orbit as indicated in Figure 24. This is the view you would have if you were located above the earth’s orbit and were looking down on it. In the figure the Roman

numerals refer to hours of right ascension. Review the plotting exercise if necessary.

2. Draw a line from 58° through the center of the circle to 238°. At the 58° point in the earth’s orbit, Comet Halley will pass from south to north across the earth’s orbital plane. It will later pass from north to the south of the earth’s orbital plane at the 238° point.
3. A slit needs to be made in the earth’s orbit so that you can insert Comet Halley’s orbit later. Comet Halley’s orbit is positioned such that it extends 1.85 A.U. from the sun on the 58° side of the earth’s orbit and 0.85 A.U. on the 238° side. On our scale this corresponds to a distance of five and one-half inches and two and one-half inches. Using a single edged razor blade, make a slit in the earth’s orbit according to the instructions.
4. Comet Halley’s orbit is elliptical in shape. Refer to the drawings in Figure 25. Note the terms on the drawing: semimajor axis, semiminor axis, semilatus rectum, aphelion, and perihelion. Also, note the equations given to solve for the different part of Comet Halley’s orbit, if you would like to assign this as an exercise.

For Comet Halley, the length of the semimajor axis is equal to a distance of 17.945 A.U. The eccentricity is equal to 0.9672671. Have the students solve the different equations to get a better understanding of Comet Halley’s orbit, if they are at the appropriate level of mathematics.

$$\text{Let } a = \text{semimajor axis} = 17.945 \text{ A.U.}$$

$$\text{Let } e = \text{eccentricity} = 0.967281$$

Then:

$$\begin{aligned} \text{Perihelion Distance} &= a(1-e) \\ &= 17.945 \times (1.0 - 0.967281) \\ &= 17.945 \times 0.032719 = 0.587 \text{ A.U.} \end{aligned}$$

$$\begin{aligned} \text{Aphelion Distance} &= a(1+e) \\ &= 17.945 \times (1.0 + 0.967281) \\ &= 17.945 \times 1.967281 = 35.3029 \text{ A.U.} \end{aligned}$$

$$\begin{aligned} \text{Length of Semiminor axis} &= a(1-e^2)^{1/2} \\ &= 17.945 \times (1.0 - 0.967281^2)^{1/2} \\ &= 17.945 \times (0.06436746)^{1/2} \\ &= 17.945 \times 0.2537 \\ &= 4.552 \text{ A.U.} \end{aligned}$$

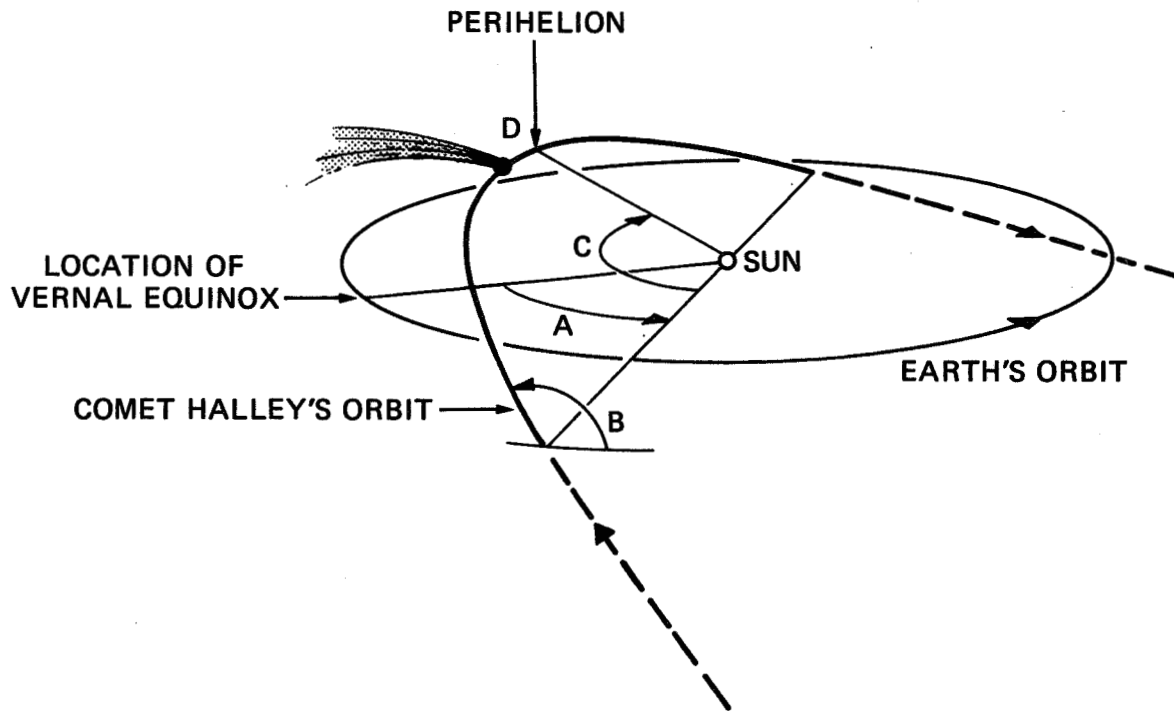

Figure 23. Angular elements of Comet Halley's orbit. The quantities are as follows: A is the longitude of the ascending node, with a value 58.15° . B is the inclination of the orbit to earth's orbital plane, with a value 162.24° . C is the argument of perihelion and D is the perihelion point.

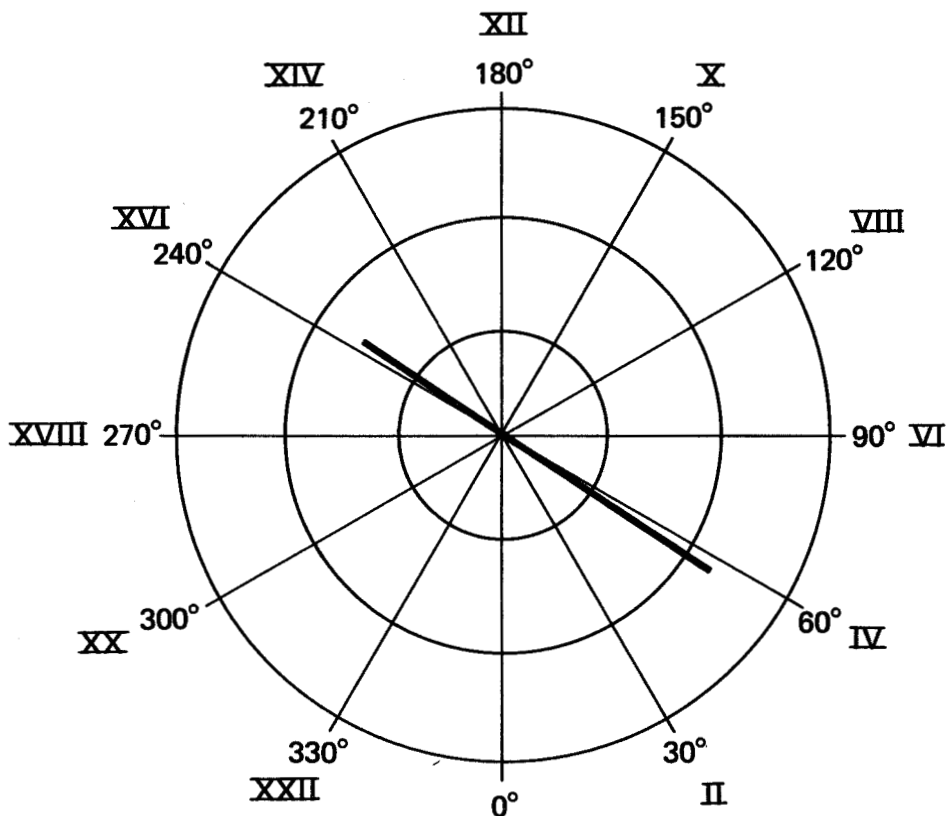

Figure 24. A view of the earth's orbit seen from above. The right ascension is marked both in hours (Roman numerals) and in degrees. The three circles represent the earth's orbit (1 A.U.) as well as a 2 A.U. and 3 A.U. scale. The heavy line marks the cut to insert the model of Comet Halley's orbit.

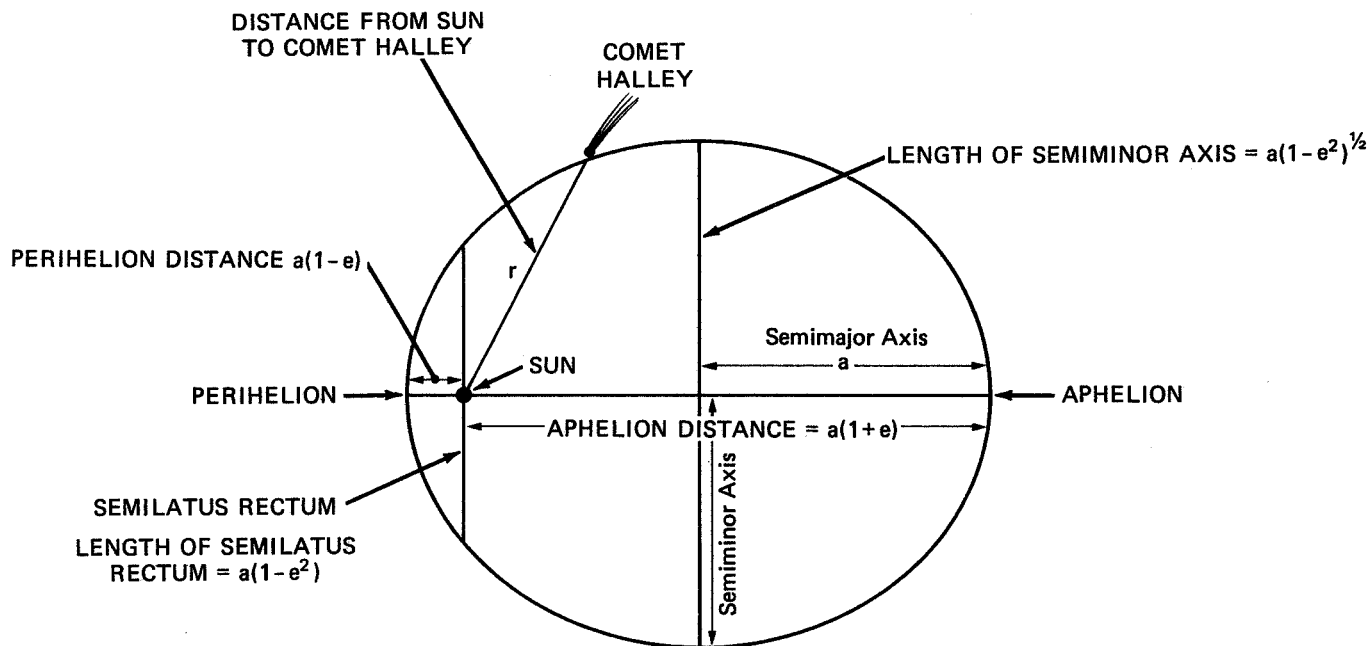

Figure 25. The geometry of Comet Halley's orbit. All relevant terms are defined on the figure.

$$\begin{aligned} \text{Length of Semilatus Rectum} &= a(1-e^2) \\ &= 17.945 \times (1.0 - 0.967278^2) \\ &= 17.945 \times 0.064367 = 1.155 \text{ A.U.} \end{aligned}$$

Have your students convert their answers to miles or kilometers.

- Draw Comet Halley's orbit to scale. Note that the distance of the semilatus rectum is 1.115 A.U. (you can have your students calculate this number, too). The total distance across the orbit at the sun is twice this distance or 2.230 A.U. Since we are using a scale of 3" equals one A.U., the latus rectum is $2.230 \times 3 = 6.69$ inches. To make matters easier, you can round this off to 6 and 3/4 inches. Similarly, calculate the perihelion distance in inches. In round numbers, it will be 1 and 3/4 inches. Draw an elliptical arc representing a portion of the orbit as shown in Figure 26a. We will not draw the entire orbit; it would be excessively large on our scale.
- Cut out the orbit and slide it through the slit from the underside of the earth's orbit. Use Figures 26b and 26c to properly orient the comet's orbit.

Places to Visit - Things To Do

Field trips to a planetarium or an observatory are a must during your study of Comet Halley. Resource persons from the community should be contacted to visit your classroom. Your local astronomy club

is a good resource to help you with your comet activities. Perhaps such a club could host a star party.

Work with your school librarian now to begin to gather books and articles for the study of comets. Watch for radio or television programs that could be of interest and value to your students. You might want to publicize your activities on the local media.

Computing an Ephemeris for Comet Halley

A table of positions of the comet at various times is called an ephemeris. If your school has a computer that operates in the BASIC language, your students can calculate an ephemeris for Comet Halley using the program starting on page 37, written by R. Chapman. It is not as sophisticated as programs written by astronomers who calculate the position of the comet to an accuracy of seconds of arc, but it will allow you to calculate its position to better than a few minutes of arc. It also prints out the position of the sun and the comet's magnitude. The X, Y, and Z coordinates of the sun and Comet are rectangular coordinates in a right handed system where the x-axis points toward the vernal equinox, and the xy-plane is the plane of the earth's equator. The right ascension, declination X, Y, and Z are referred to the vernal equinox at 1950. R is the heliocentric distance of the comet, and delta is its geocentric distance. The program also calculates the altitude and azimuth of the comet for a given time. These numbers are good for your latitude, and the time that you input. These numbers will help you locate the comet. An altitude larger than 90° means the comet is below the horizon. The details of the

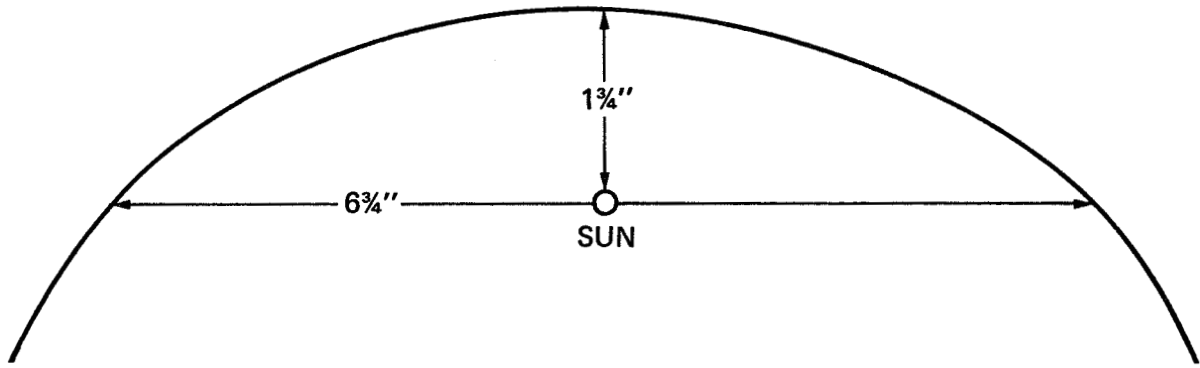

(a)

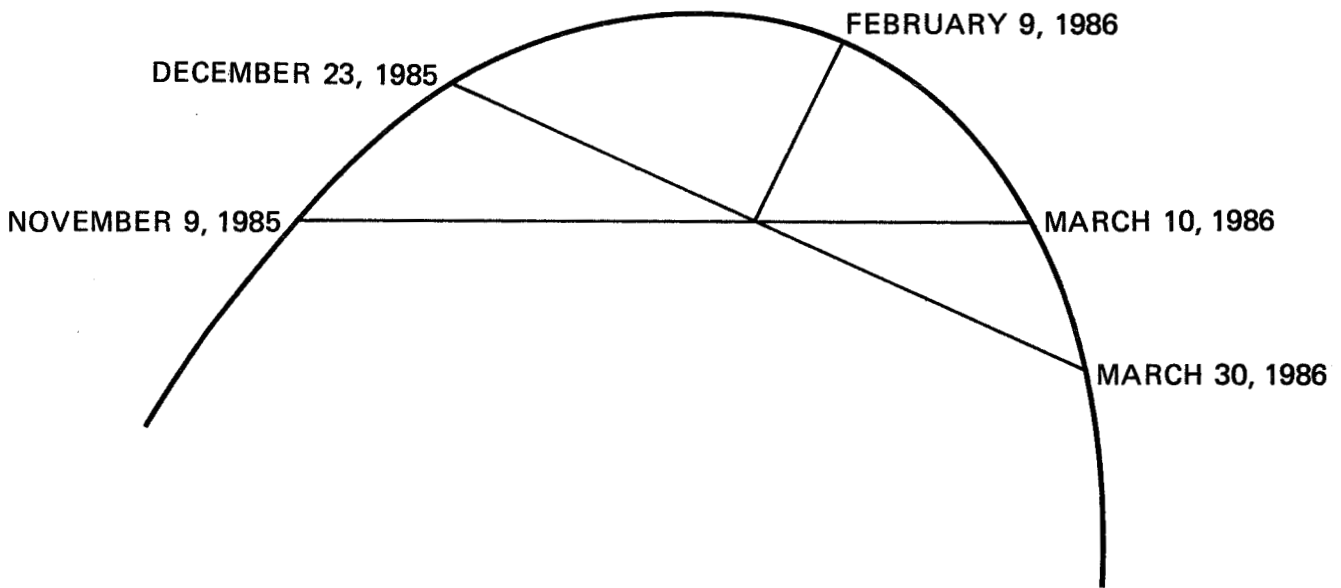

(b)

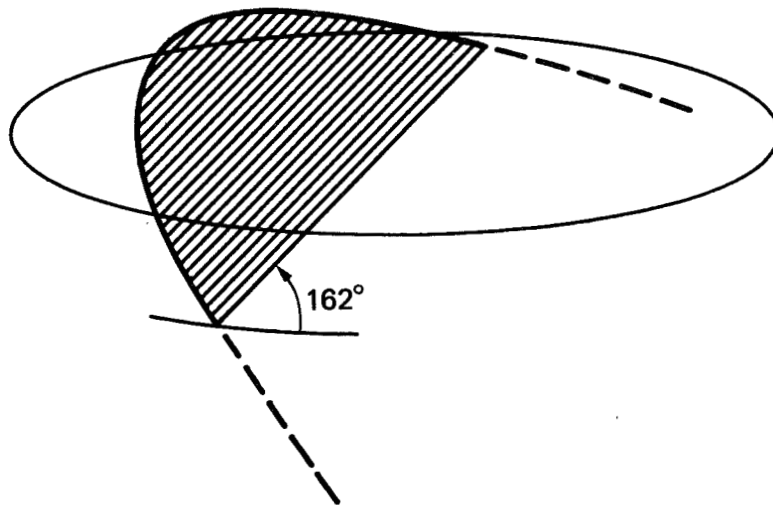

(c)

Figure 26. (a) Measurements for a portion of Comet Halley's orbit; (b) Location of Comet Halley on five dates, to be used in the model; (c) Tilt of Comet Halley's orbit to the earth's orbit.

program are beyond the scope of this booklet, and might be a good library project for your students. The program has been annotated with REM statements to help see what is going on. The author of the program wrote it and tested it on an

Apple IIe computer using BASIC, but it should work on other systems. We do not endorse any particular personal computer; we are merely providing a warning that the program has not been checked out on a variety of systems.

Even though Comet Halley will fade out of sight in the visible sky soon after April 1986, not to reappear for another 76 years, the young people that you have worked with will carry with them memories of Comet Halley all through their lives. In addition, they will gain the skills, understanding, and enthusiasm to look at the skies for their entire lives. Who can predict the total life-long impact of such a meeting with Comet Halley?

PROGRAM

```

10 REM *** INPUT NUMERICAL CONSTANTS ***
20 REM *** OB = OBLIQUITY
30 PI = 3.14159265:OB = 0.40914:RD = 57.2957795:TPI = 2.0 * PI
40 REM *** INPUT ORBITAL ELEMENTS--ANGLES IN RADIANS***
50 REM E=ECCENTRICITY; O1=NODE LONGITUDE; O2=PERIHELION LONGITUDE
60 REM IN=INCLINATION; A=SEMI-MAJOR AXIS; P=PERIOD IN YEARS
70 REM PD=JULIAN DAY OF PERIHELION; PH=ADDITIONAL DAY FRAC. AT PERI.
80 E = 0.9672760:O1 = 1.01482798:O2 = 1.95211743
90 IN = 2.83160961:A = 17.941104:P = 75.993
100 PD = 2446470.5:PH = 0.45174
110 GOSUB 6000
120 N = TP / P / 365.25: REM MEAN MOTION
121 HOME : VTAB 8: PRINT "THIS PROGRAM CALCULATES INFORMATION"
122 PRINT "OF INTEREST FOR COMET HALLEY FOR ANY"
123 PRINT "LOCATION ON EARTH. THE OPERATION"
124 PRINT "IS SELF EXPLANATORY.": PRINT
125 PRINT "SOME DEFINITIONS: ": PRINT "X,Y,Z ARE COORDINATES IN EQUATORI
AL"
126 PRINT "SYSTEM IN A.U. R IS DISTANCE FROM SUN."
127 PRINT "DELTA IS DISTANCE FROM EARTH.": PRINT
128 PRINT "INPUT YOUR LATITUDE IN DECIMAL DEGREES": INPUT " NEGATIVE IF
IN SOUTHERN HEMISPHERE ";LA
129 LA = LA / RD
130 INPUT "DATE OF INTEREST? (MM,DD,YYYY) ";MM,DD,YY:S = 1: GOSUB 5000
140 INPUT "TIME OF INTEREST? (HH,MM) ";HH,M1
150 JH = (HH + M1 / 60) / 24
160 M = ((JD - PD) + (JH - PH)) * N
165 GOSUB 7500: REM FIND POSITION OF SUN
170 KY = 0
180 GOSUB 7000: REM SOLVE KEPLER'S EQUATION
190 GOSUB 8000: REM FIND X,Y,Z OF COMET
195 REM SC=SUN-COMET DISTANCE
200 SC = SQR (XC * XC + YC * YC + ZC * ZC)
210 X = XC + XS:Y = YC + YS:Z = ZC + ZS
220 REM CALCULATE EC=EARTH-COMET DISTANCE
230 REM AC=RIGHT ASCENSION OF COMET; DC=DECLINATION OF COMET
240 EC = SQR (X * X + Y * Y + Z * Z)
245 IF KY = 1 THEN 250
248 DM = 0.005772 * EC * N:M = M - DM:KY = 1: GOTO 180
250 SA = Z / EC:CA = SQR (1.0 - SA * SA): GOSUB 8500
260 DC = A3:SA = Y / (EC * CA):CA = X / (EC * CA): GOSUB 8500
270 AC = A3
280 REM TH=ANGULAR SEPARATION SUN-COMET
290 CA = SIN (DC) * SIN (DS) + COS (AS - AC) * COS (DC) * COS (DS)

```

```

300 SA = SQR (1.0 - CA * CA): GOSUB 8500
310 TH = A3
320 GOSUB 9000: REM FIND SIDEREAL TIME
330 HA = ST - AC: REM HA=HOUR ANGLE
332 IF HA < 0 THEN HA = HA + TP
340 X = - COS (DC) * SIN (HA)
350 Y = SIN (DC) * COS (LA) - COS (DC) * COS (HA) * SIN (LA)
360 Z = SIN (DC) * SIN (LA) + COS (DC) * COS (HA) * COS (LA)
370 SA = Z:CA = SQR (1.0 - SA * SA): GOSUB 8500
380 EL = A3:SA = X / CA:CA = Y / CA: GOSUB 8500
385 IF EL > 4.72 THEN EL = EL - TP
390 AZ = A3
400 IF JD > 2446470.5 THEN 430
410 MT = 5.47 + (5.0 * LOG (EC) + 11.1 * LOG (SC)) / 2.3026
420 GOTO 440
430 MT = 4.94 + (5.0 * LOG (EC) + 7.68 * LOG (SC)) / 2.3026
440 MN = 14.1 + (5.0 * LOG (EC) + 5.0 * LOG (SC)) / 2.3026
2000 HOME : PRINT " POSITION OF COMET HALLEY ": PRINT
2010 PRINT "DATE: ";MM;"/";DD;"/";YY;" JULIAN DAY ";JD: PRINT
2020 RA = 3.81971863: REM CONVERT RADIANS TO HOURS
2022 ST = ST * RA:H = INT (ST):M2 = INT (60 * (ST - H))
2024 PRINT "LOCAL TIME: SOLAR=" ";HH;" ";M1;" SIDEREAL=" ";H;" ";M2
2026 PRINT
2028 PRINT "COORDINATES OF THE SUN: "
2029 XS = INT (10000 * XS) / 10000:YS = INT (10000 * YS) / 10000:ZS = INT
(10000 * ZS) / 10000
2030 PRINT " X=" ";XS;" Y=" ";YS;" Z=" ";ZS
2040 AS = AS * RA:H = INT (AS):M2 = INT (60 * (AS - H))
2050 DS = DS * RD:D = INT (DS):M3 = INT (60 * (DS - D)): IF D < = 90 THEN
2070
2060 D = D - 359:M3 = 60 - M3
2070 PRINT " R.A.=" ";H;" ";M2;" DEC=" ";D;" ";M3
2075 PRINT ; PRINT "COORDINATES OF THE COMET: "
2078 XC = INT (10000 * XC) / 10000:YC = INT (10000 * YC) / 10000:ZC = INT
(10000 * ZC) / 10000
2080 PRINT " X=" ";XC;" Y=" ";YC;" Z=" ";ZC
2090 AC = AC * RA:H = INT (AC):M2 = INT (60 * (AC - H))
2100 DC = DC * RD:D = INT (DC):M3 = INT (60 * (DC - D)): IF D < = 90 THEN
2120
2110 D = D - 359:M3 = 60 - M3
2120 PRINT " R.A.=" ";H;" ";M2;" DEC=" ";D;" ";M3
2130 PRINT " R=" "; INT (100 * SC + 0.5) / 100;
2140 PRINT " DELTA=" "; INT (100 * EC + 0.5) / 100
2145 TH = INT (100 * TH * RD + 0.5) / 100
2150 PRINT " SUN-COMET ANGLE=" ";TH
2160 HA = HA * RA:X = 0: IF HA > 12 THEN X = 1:HA = 24 - HA
2170 H = INT (HA):M2 = INT (60 * (HA - H))
2180 PRINT " HOUR ANGLE=" ";H;" ";M2;
2190 IF X = 0 THEN PRINT " WEST"
2200 IF X = 1 THEN PRINT " EAST"
2210 AZ = AZ * RD:D = INT (AZ):M3 = INT (60 * (AZ - D))
2220 PRINT " AZIMUTH=" ";D;" ";M3
2230 EL = EL * RD:D = INT (EL):M3 = INT (60 * (EL - D))
2240 PRINT " ELEVATION=" ";D;" ";M3
2250 MT = INT (10 * MT) / 10:MN = INT (10 * MN) / 10
2260 PRINT ; PRINT " NUCLEAR MAGNITUDE=" ";MN
2270 PRINT " TOTAL MAGNITUDE=" ";MT
2280 PRINT
4990 PRINT "DO YOU WANT ANOTHER DATE? (Y/N): "; GET C#
4992 IF C# = "Y" THEN 130
4993 HOME : VTAB 12: PRINT " SIGNING OFF"
4999 END
5000 REM **CALCULATES JULIAN DAY**
5010 IF MM < = 2 THEN X = 1

```

```

5020 IF MM > 2 THEN X = 0
5030 IF S = 0 THEN C = 2
5040 IF S = 1 THEN C = INT ((YY - X) / 100)
5050 A1 = INT ( INT (365.25 * (YY - X)) - 0.75 * C)
5060 B = INT (367 * ((MM - 2) / 12 + X))
5070 IF B < 0 THEN B = B + 1
5080 JD = 1721088.5 + DD + A1 + B
5090 RETURN
6000 REM
6005 REM *** SETS UP VECTORS TO CONVERT FROM ORBITAL ***
6010 REM *** TO ECLIPTIC COORDINATES ***
6015 REM
6020 PX = COS (O2) * COS (O1) - SIN (O2) * SIN (O1) * COS (IN)
6030 PY = COS (O2) * SIN (O1) + SIN (O2) * COS (O1) * COS (IN)
6040 PZ = SIN (O2) * SIN (IN)
6050 QX = - SIN (O2) * COS (O1) - COS (O2) * SIN (O1) * COS (IN)
6060 QY = - SIN (O2) * SIN (O1) + COS (O2) * COS (O1) * COS (IN)
6070 QZ = COS (O2) * SIN (IN)
6090 RETURN
7000 REM *****
7010 REM * ITERATIVE SOLUTION OF *
7020 REM * KEPLER'S EQUATION *
7030 REM *****
7050 TPI = 2.0 * PI
7060 X = M / TPI
7070 M = (X - INT (X)) * TPI
7080 EA = M
7090 EB = EA - (EA - M - E * SIN (EA)) / (1.0 - E * COS (EA))
7100 IF ABS (EB - EA) / EB < 1E - 8 THEN 7130
7110 EA = EB
7120 GOTO 7090
7130 RETURN
7500 REM POSITION OF THE SUN
7510 REM G1=MEAN ANOMALY; OP=PERIHELION LONG; L1=SUN'S LONGITUDE
7520 D1 = (JD - 2415020) + JH
7530 X1 = (358.4758 + 0.9856 * D1) / 360
7550 G1 = (X1 - INT (X1)) * 360 / RD
7560 OP = (281.2208 + 4.7E - 5 * D1) / RD
7570 L1 = G1 + 0.03344 * SIN (G1) + 3.49E - 4 * SIN (2 * G1) + OP
7580 X1 = L1 / TPI
7585 REM CALCULATE FINAL L1 AND PRECESS
7586 REM THEN SUN AND COMET ARE REFERRED TO SAME EPOCH
7590 L1 = (X1 - INT (X1)) * TPI + 2.437E - 4 * (2433282.5 - JD) / 365.25

7595 REM SE=SUN-EARTH DISTANCE;XS,YS,ZS=RECT. COORD. OF SUN
7600 SE = 0.99972 / (1.0 + 0.01675 * COS (L1 - OP))
7610 XS = SE * COS (L1)
7620 YS = SE * SIN (L1) * COS (OB)
7630 ZS = SE * SIN (L1) * SIN (OB)
7640 REM --- AS=RIGHT ASCENSION OF SUN ---
7645 REM --- DS=DECLINATION OF SUN ---
7650 SA = ZS / SE;CA = SQR (1.0 - SA * SA);GOSUB 8500
7660 DS = A3;SA = YS / (SE * CA);CA = XS / (SE * CA);GOSUB 8500
7670 AS = A3
7800 RETURN
8000 REM CALCULATES COORDINATES IN
8010 REM ECLIPTIC SYSTEM
8020 X1 = A * (COS (EA) - E)
8030 Y1 = A * SQR (1 - E * E) * SIN (EA)
8040 X = X1 * PX + Y1 * QX
8050 Y = X1 * PY + Y1 * QY
8060 Z = X1 * PZ + Y1 * QZ
8065 REM ***ROTATE TO EQUATORIAL SYSTEM
8070 XC = X;YC = Y * COS (OB) - Z * SIN (OB);ZC = Y * SIN (OB) + Z * COS
(OB)

```

```

8080 RETURN
8500 REM
8505 REM TWO ARGUMENT ARCTAN
8510 REM CA=cos(A);SA=sin(A); RETURNS A IN PROPER QUADRANT
8515 REM
8520 IF ABS (CA) < 1E - 8 THEN 8540
8530 A3 = ATN (SA / CA); GOTO 8560
8540 IF SA > 0 THEN A3 = 0.5 * PI
8550 IF SA < 0 THEN A3 = 1.5 * PI
8560 IF CA < 0 THEN 8590
8570 IF CA > 0 AND SA < 0 THEN 8600
8580 GOTO 8610
8590 A3 = A3 + PI; GOTO 8610
8600 A3 = A3 + 2.0 * PI
8610 RETURN
9000 REM CALCULATE SIDEREAL TIME
9010 T1 = (JD - 2415020) / 36525; REM CENTURIES SINCE 1900
9020 X1 = (18.64606 + 2400.0513 * T1) / 24 + 0.5 + JH
9030 ST = (X1 - INT (X1)) * TP; REM SIDEREAL TIME IN RADIANS
9040 RETURN
10000 T2 = ((1986 + YY) / 2 - 1900) / 100
10010 X3 = 3.07234 + (0.00186 * T2); Y3 = 20.0468 - (0.0085 * T2); Z3 = Y3 /
15
10020 T3 = (JD - PD) / 365.35
10030 X4 = 7.2722E - 5 * T3 * (X3 + (Z3 * SIN (AC) * TAN (DC)))
10049 X5 = 4.8481E - 6 * T3 * Y3 * COS (AC)
10050 AC = AC + X4; DC = DC + X5
10060 RETURN

```

INDEX

- amateur astronomers, 3
- ammonia, 10
- aphelion, 33, 35
- Aristotle, 1, 24
- Astro Mission, 19, 21
- BASIC program, 37-40
- Bayeux Tapestry, 24
- Chapman, R., 35
- comet,
 - brightness, 9, 18
 - collision with, 24
 - coma, 9, 10, 15
 - diameter, 9
 - composition, 10
 - discovery, 3-4
 - hall of fame, 24
 - head, 9
 - hydrogen cloud, 15
 - lifetime, 16, 18
 - naming, 3
 - nucleus, 9, 10, 15, 16, 21
 - nature, 10
 - orbit, 1, 5-9
 - parts, 9
 - tail, 9, 15, 23
 - dust, 15, 16
 - length, 9
 - orientation, 10, 16
 - plasma, 15, 16
- Comet Bennett, 15
- Comet Biela, 18
- Comet Donati, 18
- Comet Ensenior, 18
- Comet Halley, 1, 11, 19, 20, 29
 - appearance, 9-10
 - art, 24
 - brightness, 25, 29
 - classroom activities, 23-24
 - ephemeris, 27, 35-40
 - historical importance, 1-3
 - lifetime, 18
 - newspaper accounts, 23
 - observations, 30, 31, 32
 - orbit, 3, 33-35
 - path, 26
 - photography, 30
 - plans to observe, 19-21
 - position, 12, 13, 14, 26, 27, 30
 - recovery, 4
 - returns, 23
 - tail, 30
 - encounter with, 23
 - viewing, 10, 24-40
- Comet Honda-Mrkos-Pajdusakova, 5
- Comet Howard-Koomens-Michels, 19
- Comet Ikeya-Seki, 4, 19
- Comet Kohoutek, 5, 6, 10, 18, 19
- Comet IRAS-Araki, Alcock, 5, 9, 10
- Comet Schwassmann-Wachmann I, 5
- Comet Schwassmann-Wachmann II, 5
- Comet Tago-Sato-Kosaka, 15
- Comet West, 1, 16
- Comet Westphal, 18
- comets,
 - daylight, 10, 18
 - long-period, 8, 18
 - short-period, 8, 9, 18
 - sun-grazing, 18, 19
 - sun-hitting, 19
- comet seeker, 3
- conic section, 5, 7
 - circle, 7
 - ellipse, 5, 7
 - hyperbola, 5, 7
 - parabola, 1, 5, 7
- constellation, 25, 28, 30
- Copernicus, N., 1
- cross staff, 28-30
- cyanogen, 19, 23
- declination, 27, 30, 35
- dinosaur, 24
- direct motion, 8
- disconnection event, 19, 21
- eccentricity, 5
- ephemeris, 5, 27, 35-40
- field trips, 35
- Galileo, 1
- generatrix, 5, 7
- geocentric distance, 25, 27, 35
- Giotto, 19, 24
- Giotto Mission, 19
- gravity, 1, 19
- Halley, E., 1, 5, 24
- heliocentric distance, 25, 27, 35
- Herschel, C., 5
- horizon, 13, 14, 15, 35
- hydrogen cyanide, 10, 19, 23
- Ikeya, K., 4
- inclination, 5, 8
- International Halley Watch, 21
- interstellar space, 5
- Kepler, J., 1
- latitude, 35
- magnitude, 25, 26, 27, 28, 30, 32
 - limiting, 28
- meteor, 15
- meteor shower, 15, 16
- methane, 10
- methyl cyanide, 10
- Mitchell, M., 5
- molecules,
 - daughter, 10
 - parent, 10
- Newton, I., 1, 3
- Oort, J., 18
- Oort cloud, 18
- oral history, 24
- orbit, 1, 5, 8
 - elliptical, 1, 5
 - parabolic, 1, 5
 - hyperbolic, 5
- orbital elements, 5, 8, 34
- parallax, 1, 2
- perihelion, 3, 5, 10, 24, 33, 35
- Perrine, C., 4
- perturbation, 18
- photon, 15
- Pons, J., 4
- Ptolemy, C., 1
- radical, 15
- retrograde motion, 8, 9
- right ascension, 27, 30, 34, 35
- Seki, T., 4
- semimajor axis, 33, 35
- semiminor axis, 33, 35
- semilatus rectum, 33, 35
- Seneca, L., 1
- solar wind, 15
- sublimation, 10, 16, 18
- time capsule, 24
- Tycho Brahe, 1
- vernal equinox, 3, 8, 33, 34, 35
- water, 10
- Whipple, F., 10, 24

NASA

National Aeronautics and
Space Administration

Goddard Space Flight Center
Greenbelt, Maryland 20771

EP-197