

STRUCTURAL DYNAMICS ANALYSIS

J. Housner, M. Anderson, W. Belvin and G. Horner
NASA Langley Research Center
Hampton, Virginia

Large Space Antenna Systems Technology - 1984
December 4 - 6, 1984

DYNAMIC ANALYSIS CONSIDERATIONS

Dynamic analysis of large space antenna systems must treat the deployment as well as vibration and control of the deployed antenna. Candidate computer programs for deployment dynamics, and issues and needs for future program developments are reviewed in subsequent charts. Some results for mast and hoop deployment are also presented.

Modeling of complex antenna geometry with conventional finite element methods and with repetitive "exact elements" is considered. Analytical comparisons with experimental results for a 15 meter hoop/column antenna revealed the importance of accurate structural properties including nonlinear joints. Slackening of cables in this antenna is also a consideration. In addition, the maturing technology of designing actively damped structures through analytical optimization is discussed and results are presented.

● ANTENNA DEPLOYMENT DYNAMICS

- Candidate Programs
- Issues and Needs
- Mast and Hoop Deployment

● ANTENNA VIBRATION AND CONTROL

- Finite Element and Repetitive Models
- Important Effects
 - Nonlinear joints
 - Cable slackening
- Design of Actively Damped System

POTENTIAL BENEFITS FROM DEPLOYMENT DYNAMICS ANALYSIS

Deployment is a candidate mode for construction of structural antenna components. By its very nature, deployment is a dynamic event, possibly involving large angle unfolding of flexible beam members. Validation of proposed designs and conceptual deployment mechanisms is enhanced through analysis. Analysis may be used to determine member loads thus helping to establish deployment rates and deployment control requirements for a given concept. Furthermore, member flexibility, joint free-play, manufacturing tolerances and imperfections can affect the reliability of deployment. Analyses which include these effects can aid in reducing risks associated with a particular concept. Ground tests which can play a similar role to that of analysis are difficult and expensive to perform. Suspension systems just for vibration ground tests of large space structures in a 1 g environment present many challenges. Suspension of a structure which spatially expands is even more challenging. Analysis validation through experimental confirmation on relatively small simple models would permit analytical extrapolation to deployment of larger more complex space structures.

- **Deployment A Potential Candidate For Antenna System Construction**

- **Deployment Is a Dynamic Event**

- **Design And Concept Validation**
 - **Determination of Member Loads**
 - Deployment Rate**
 - Deployment Control**

 - **Reliability of Deployment Mechanism**
 - Flexible Members**
 - Joint Free-Play**
 - Tolerances and Imperfections**

 - **Ground Tests Difficult and Expensive**
 - Suspension System In 1 g Environment**
 - Size Limitations**

APPLICATIONS OF DEPLOYMENT ANALYSIS PROGRAMS

Deployment analysis programs find application in masts, truss type antenna surfaces and entire antenna structures. Deployment programs belong to a larger class of multi-body programs and as such are also applicable to mechanisms and robotics.

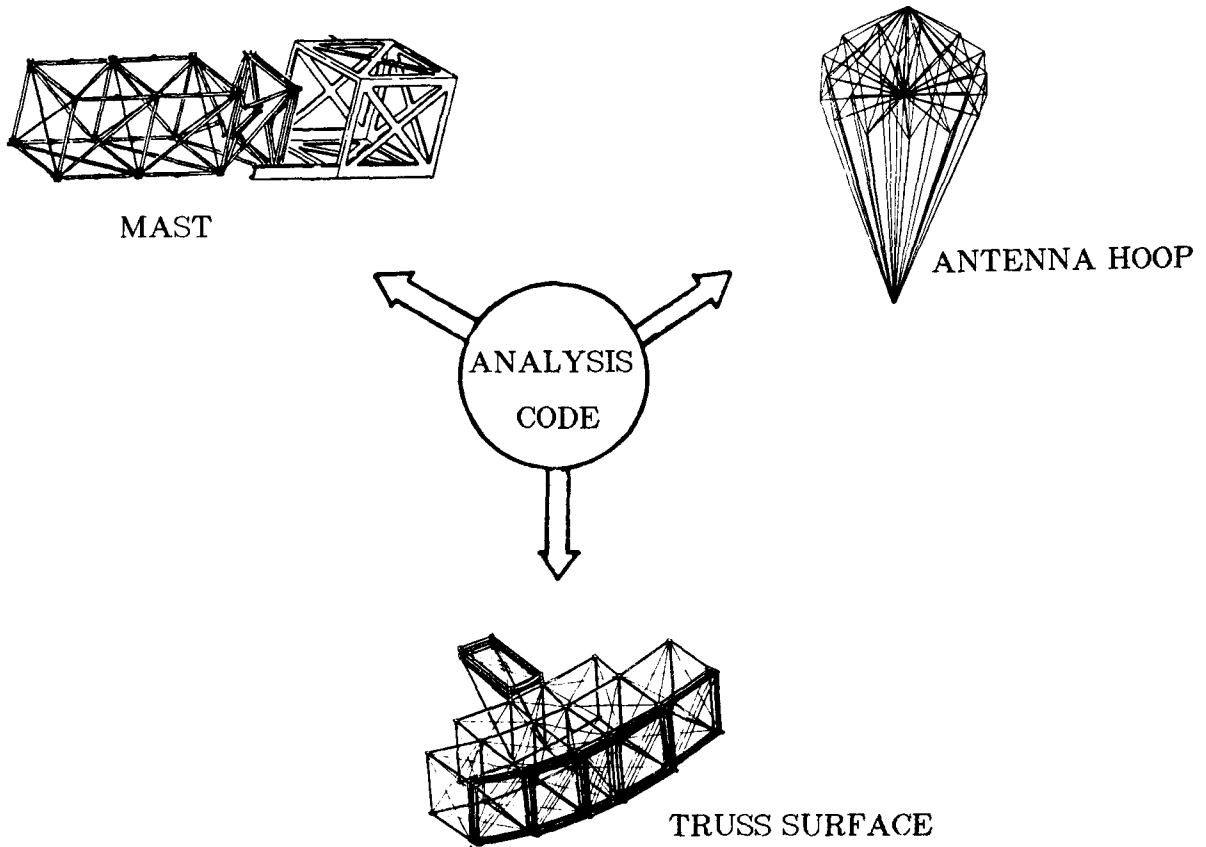

CANDIDATE MULTI-BODY PROGRAMS FOR DEPLOYMENT

Shown in this chart is a list of some of the existing U.S. computer multi-body programs which are candidates for performing deployment analyses. Some of these programs were originally designed for mechanisms, while others were designed for satellites with appendages. Most of these programs are in a constant state of improvement and most have or will soon have capability for treating flexible members and perhaps sophisticated joint behavior. However, efficient simulation of a deploying structure with a large number of components will require considerable further development. The next chart addresses some of the issues and developmental needs in this area.

ADAMS ----- Mechanical Dynamics

ALLFLEX ----- Lockheed Missiles and Space

CAPPS ----- TRW

DADS ----- U. of Iowa

DISCOS/NBOD - Martin Marietta

IMP ----- U. of Wisconsin

LATDYN ----- NASA (pilot code)

SNAP ----- General Dynamics

TREETOPS ----- Honeywell

ISSUES AND NEEDS IN DEVELOPMENT OF DEPLOYMENT PROGRAMS

One outstanding developmental need is in structural modeling. Member flexibility, joint free-play, joint lock-up and closed loop topologies are needed for proper deployment simulation. Recently progress has been made in adding these capabilities to those programs which were originally oriented or designed for rigid mechanisms. Usually member flexibility is accounted for by adding deformation modes of the members to their rigid body motion. Unfortunately, this addition greatly increases the size of the problem and consequently only those deployables with a small number of members can be treated in a reasonably efficient manner. In addition, as shown in the next chart, the problem formulation and modeling which had obvious advantages with rigid members no longer retains those advantages when member flexibility is added. It is then questionable as to whether an efficient program for flexible structures can be obtained by extending rigid member programs. One critical issue which stands as an obstacle to an efficient deployment simulation is one of integrating the nonlinear equations of motion in time subject to constraints. Concurrent processing which makes use of multiple processors is very promising in this area. The ground work in this area for multi-body problems is to be found in the CAPPS program listed in the previous chart. Use of concurrent processing and/or new time integration algorithms may require new formulations of the problem.

- **Modeling**
 - **Member Flexibility**
 - **Joints**
 - **Lock-up Constraints**
 - **Closed Loop Topologies**

- **Time Integration**

- **Concurrent Processing**

EFFECT OF FLEXIBILITY ON STRUCTURAL MODELING FOR DEPLOYMENT

In order to demonstrate the consequences of flexibility on the size of a multi-body problem, a planar N body pendulum is considered. For a pendulum composed of all rigid members, there are N independent degrees of freedom. Thus a minimum size kinematic model involves the solution of N equations of motion which are nonlinear when large angular excursions are permitted. An alternate modeling of the rigid member pendulum leads to 2N nonlinear equations plus N nonlinear length constraints when generalized orthogonal coordinates are selected at the pendulum pinned joints. Clearly the minimum kinematic modeling is preferable when the members are rigid. If the members are flexible and the minimum kinematic modeling is extended to account for flexibility, the usual approach is to add flexible modes to the set of kinematic or rigid body ones. In this example one extensional mode and M-1 flexible modes per member are added. The resulting problem is M+1 times bigger than in the rigid member case. If on the other hand the non-minimal modeling of the rigid member pendulum is similarly extended, an extensional mode does not need to be added since it is already accounted for by the superfluous generalized coordinates of the model and the length constraints are no longer appropriate. Consequently, the resulting number of equations is precisely the same and the modeling approach which is clearly preferable for rigid members has no clear advantage for flexible members. Since the resulting problem size is considerably larger with flexible members, extension of programs for rigid members may not lead to efficient programs.

PLANAR MULTI-BODY PENDULUM

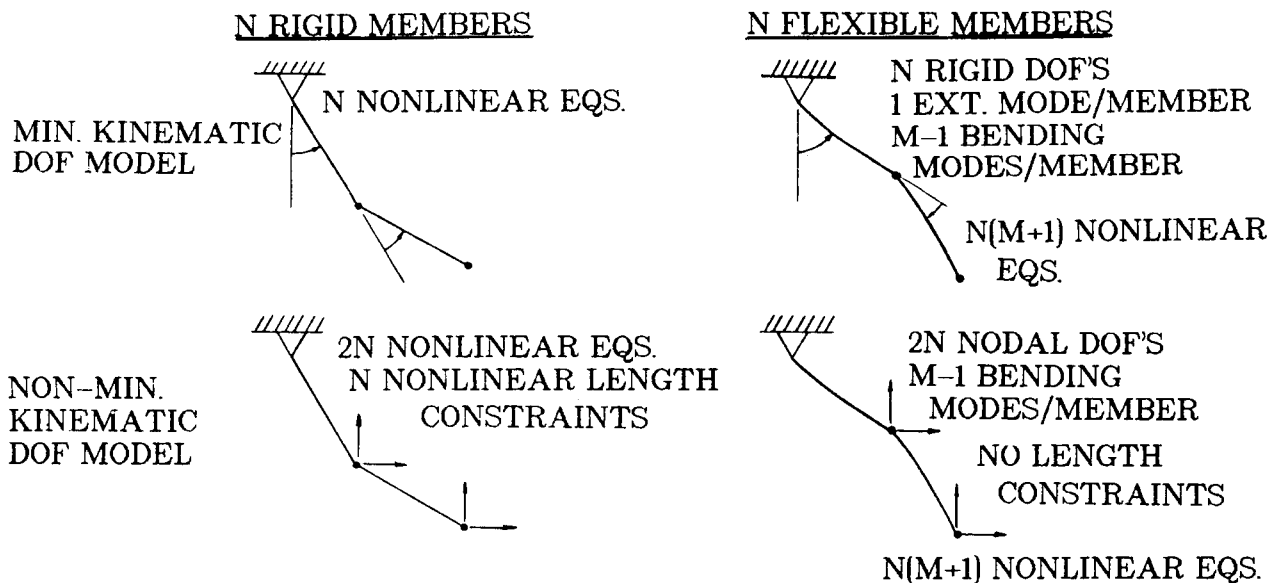

CONCLUSION: WHAT WAS IMPORTANT IN RIGID MEMBER SYSTEM MAY NOT BE IMPORTANT IN FLEXIBLE MEMBER SYSTEM

UNCONTROLLED DEPLOYMENT SEQUENCE OF FOUR BAY MAST

In this chart, the analytically simulated deployment of an uncontrolled four bay mast composed of flexible members is shown. (The analysis was performed using the NASA LATDYN computer program and involved 64 degrees of freedom.) The deployment involves unfolding of the longerons of each bay which have lockable joints mid way along their length. The diagonals are assumed to telescope out during the deployment and the deployment is driven by precompressed rotational springs at each lockable joint. Typically such masts are controlled to deploy sequentially, that is, one bay is permitted to deploy at a time. Nevertheless, an uncontrolled deployment sheds light on the natural deployment character of the design. Moreover, insight is gained into the simultaneous deployment which can occur in other deployables such as a tetrahedral trusses. The chart shows that the mast has a natural tendency to deploy nearly sequentially even in the absence of control. This appears to be due to the larger inertial mass which must be pushed by the inner bays and to the choice of the spring constants driving the deployment. Thus sequential deployment for a mast is a natural selection.

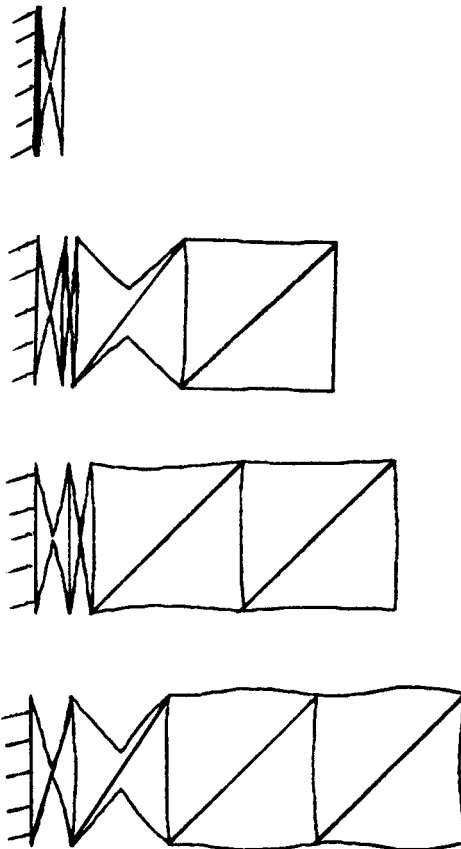

LUMPED MASS NECESSARY TO SIMULATE UNCONTROLLED MULTI-BAY DEPLOYMENT

Due to the large computational time requirements of the mast deployment in the previous chart, it becomes desirable to simulate the multi-bay deployment using only one bay with lumped masses representing the inertial effect of the remaining bays. The nonlinear curve indicates the amount of lumped mass which must be added to a single bay in order to simulate the deployment time of the multi-bay analysis. The linear curve indicates the consequences of assuming that the added mass is equal to that of the simulated bays. The linear representation becomes increasingly inaccurate as the number of bays to be simulated increases. The reason for this is probably traceable to the vibrations and some unfolding of the simulated bays during deployment.

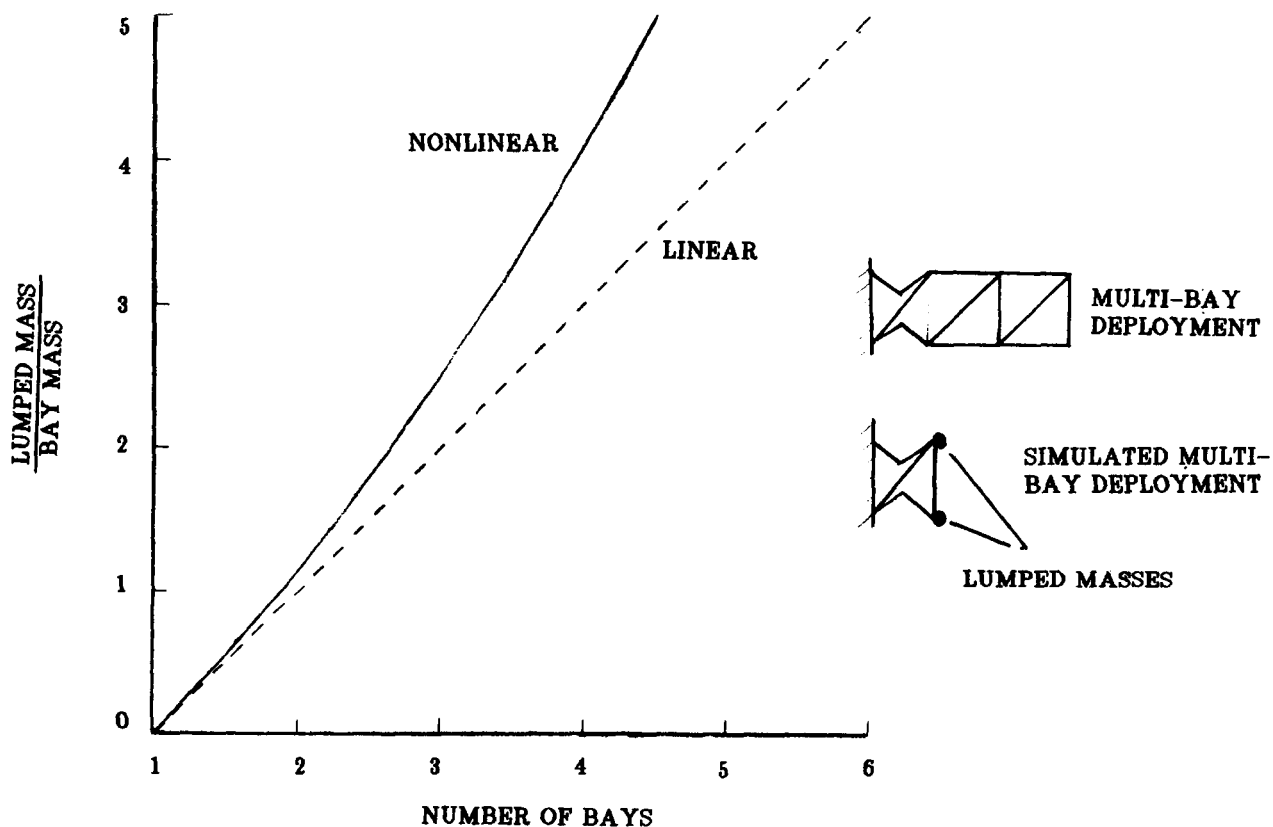

UNCONTROLLED DEPLOYMENT OF FLEXIBLE MEMBER HOOP

Deployment of hoops composed of a various number of flexible hinged members is considered in this chart. The left hand figures depict the deployment sequence of a 40 member hoop. Bending of the hoop members is observable during deployment and after lock-up. The right hand portion of the chart indicates the variation of hoop deployment time with number of hoop members. Two sets of curves are shown. In one set of curves, the length of the hoop members is fixed so that as the number of members increases, the hoop radius also increases. In the second case, the hoop radius is fixed so that as the number of members increases, the member length decreases. Effectively, in the second set of curves, the total weight of the hoop remains fixed. Deployment time is measured from the time the packaged hoop is released to the time all the joints lock up. The figure indicates that hoops composed of flexible members reach lock-up sooner.

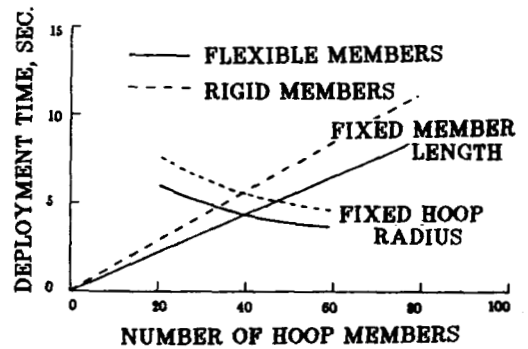
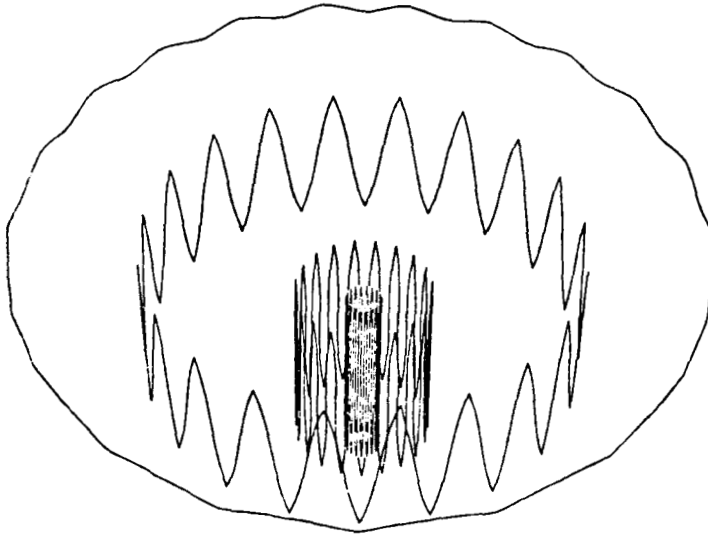

ANALYSIS OF REPETITIVE LATTICE STRUCTURES

A structure that has a nodal geometry that repeats in one or more coordinate directions may be analyzed for buckling or vibration by considering only one repeating element of the structure. If cylindrical coordinates are used, configurations such as the hoop-column antenna structure shown on the next figure may be treated. For lattice structures composed of beams and tensioned cables, it is possible to use "exact" member theory in developing member stiffnesses. This theory is based on the solution of the beam column or string equations to develop an exact relation between forces and displacements as a function of frequency and member axial load. There are no further approximations in the analysis and exact results for all frequencies are obtained with nodes located only at joints. A typical finite element equilibrium equation relates the displacement vector of the basic repeating element, D_0 , with the displacement vector of other repeating elements, D_j , to which it is connected. The key step is the assumption of a periodic mode shape which is exact for structures having rotational periodicity as do many antenna structures. For many structures that are repetitive in rectangular coordinates, such as booms or platforms, this assumption is exact for simple support boundary conditions for a wavelength twice the actual length of the structure. The D_j may be eliminated from the equilibrium equation by

$$D_j = D_0 \exp i\phi$$

where ϕ is a function of wavelength and harmonic of the mode and the connectivity of the structure. The equilibrium equation then can be written in terms of D_0 only and buckling or vibration is determined from the eigenvalues of a $6N \times 6N$ complex, Hermitian matrix where N is the number of nodes in one repeating element.

STIFFNESS FROM "EXACT" MEMBER THEORY

$$\text{EQUILIBRIUM EQUATION } K_0 D_0 + \sum K_j D_j = 0$$

$$\text{PERIODIC MODE SHAPE } D_j = D_0 \text{ EXP } i\phi$$

SOLUTION OF $6N \times 6N$ MATRIX

STRUCTURAL MODEL OF HOOP-COLUMN ANTENNA

The computer program incorporating the theory for repetitive lattice structures is quite general in its capability. Such things as eccentric connections at joints, spring connected members (including the limiting cases of pinned or sliding connections) and the ability to determine vibration of structures that are free in space make it especially useful for many antenna configurations.

The 15m hoop-column antenna being fabricated by the Harris corporation is shown in the figure. The variation in geometry necessary to produce the four side feed antennas is ignored so that only one gore is modeled for the vibration analysis of the complete antenna. It is believed the results for this simple model will be close to those for the actual geometry and can be used to study variations in the many structural parameters. There are 57 structural nodes in the repeating element which is the size of the model input to the computer program. If the repeating element is indexed in the circumferential direction 24 times, the complete model is obtained. For clarity, only one half the total model is shown in the figure. All the members except the hoop are tensioned cables so that most of the nodes have just three degrees of freedom. This model was generated for harmonic responses having two or more circumferential waves. The central compression mast does not participate in these modes and is not shown in the model. The final values of member stiffness and pretension are not known at present so that frequency results are not available.

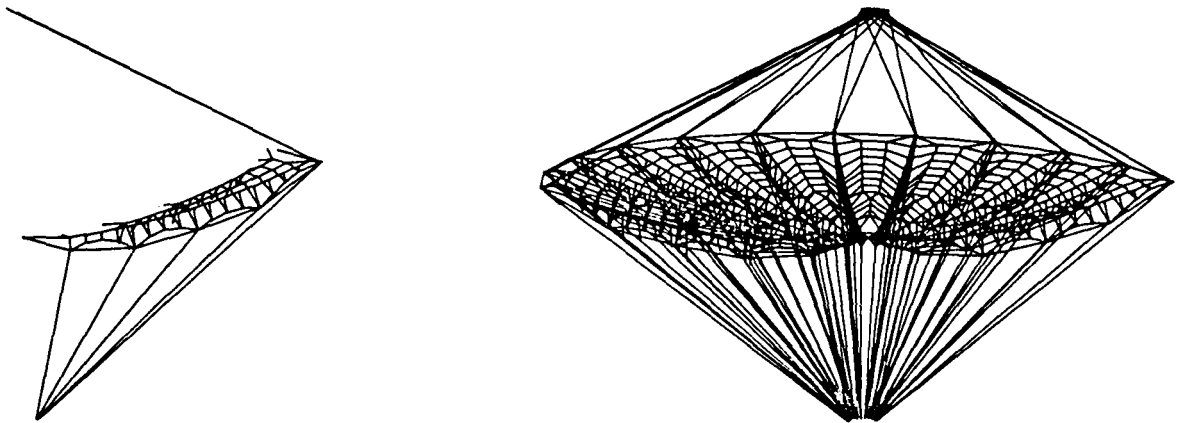

REPEATING ELEMENT

15 M HOOP COLUMN ANTENNA DYNAMIC CHARACTERIZATION WITHOUT SURFACE

The dynamic characterization of an antenna must be performed on both an experimental and analytical basis. Experimental data is invaluable in verifying analysis assumptions and in determining effective material properties when using composite structures. On the other hand, analysis can identify closely spaced modes that may otherwise be overlooked in a test program. Shown below is the 15 M hoop column antenna prior to surface installation. Also shown are the steps taken to characterize its vibration behavior. Prior to surface installation only the upper and lower hoop support cables are present. A tripod of six inch aluminum tubes was attached to the column to support the antenna. The flexibility of the tripod support was included in the analysis models. Since the BUNVIS analysis computer program may be unfamiliar to the reader, it is described briefly on the figure and the BUNVIS repeating element for the 15 M antenna is shown.

- PERFORMED IMPACT TEST FOR SYSTEM IDENTIFICATION
 - 48 MEASUREMENTS ON HOOP
 - 4 MEASUREMENTS ON COLUMN
- ANALYZED ANTENNA WITH TEST BOUNDARY CONDITIONS VIA
 - NASTRAN (525 DEGREES OF FREEDOM)
 - BUNVIS (84 DEGREES OF FREEDOM)
- BUNVIS USES REPEATING ELEMENTS TO MODEL THE ANTENNA

REPEATING ELEMENT

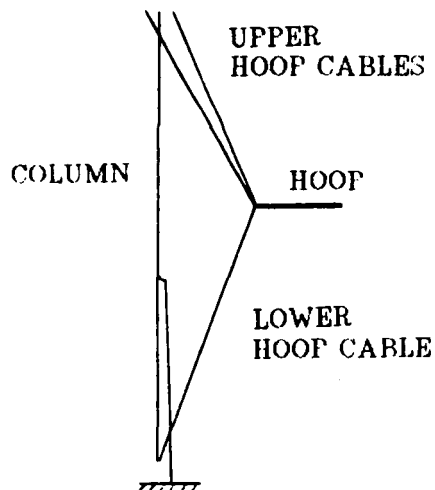

15 M ANTENNA

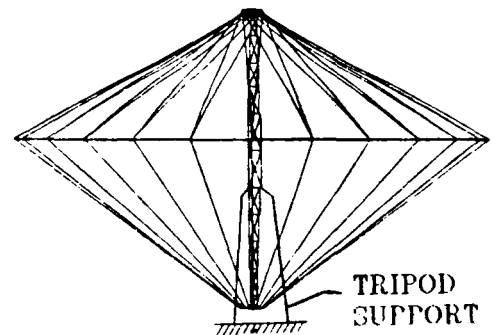

COMPARISON OF TEST AND ANALYSIS FREQUENCIES

Test data has been reduced and compared to both analytical models in the table shown below. Analysis consistently predicted higher frequencies than test data for the first three modes. Analysis predicts the fourth and fifth modes to occur at lower frequencies than test data indicates. Some possible reasons for the test and analysis discrepancies are discussed on the next chart. Note the damping data obtained from the test program is considerably higher than the one-half to one percent critical damping usually assumed for large space structures.

MODE SHAPE	FREQUENCY (HZ)			DAMPING (C/C CRITICAL)
	NASTRAN	BUNVIS	TEST	
HOOP TORSION	0.078	0.084	0.067	0.035
HOOP ROCKING/ COLUMN BENDING	0.969	1.39	0.785	0.12
HOOP INPLANE MOTION/ COLUMN BENDING	1.61	2.05	1.36	0.041
HOOP OUT-OF-PLANE TRANSLATION	7.24	7.10	7.50	UNKNOWN

POSSIBLE SOURCES OF ERROR BETWEEN ANALYSIS AND TEST

Three major sources of error are possible in dynamic models of structures such as the 15 M Hoop Column antenna. Composite material properties are sometimes difficult to model at low strain levels because the fibers are not stressed uniformly. This results in nonlinear EA properties as verified by tests of the hoop support cables. Another source of error involves modeling of inertial properties. Total mass is often available to the analyst, however mass moments of inertia of individual parts are rarely measured. This is believed to account for the error between test and analysis for the fourth mode. The last source of error described herein is the modeling of joints. Traditionally joints are modeled as rigid links in the analysis which accounts for the test frequencies usually being lower than analysis predictions. The following chart shows a new approach for modeling of joints to account for their stiffness and damping.

- MATERIAL PROPERTIES

 - EA, EI, GJ (LAMINATE ANALYSIS PERFORMED)
 - NONLINEARITIES (CABLE AE MEASURED)

- MASS AND ROTATIONAL INERTIAS

 - ACCURATE MODELING OF JOINT MASSES REQUIRED

- JOINT FLEXIBILITIES AND NONLINEARITIES

 - NEED JOINT MODELS TO CHARACTERIZE JOINT STIFFNESS AND DAMPING CONTRIBUTIONS

ANALYSIS OF JOINT STIFFNESS AND DAMPING

An approach for developing joint models is to measure the load deflection curves of a statistical sample of joints used in a structure. Then using the measured data an empirical model is developed such as the one shown below. The coefficients of the empirical model are determined such that the squared error is minimized over the operating load deflection range of the joint. This results in an empirical joint model which may be incorporated in the overall structure model for the prediction of stiffness and damping characteristics. Shown below is a load deflection curve obtained by identifying the coefficients of the model shown to minimize the squared error from simulated joint data.

EMPIRICAL MODELS DEVELOPED TO ACCOUNT FOR NONLINEAR STIFFNESS, COULOMB FRICTION AND VISCOUS DAMPING

COEFFICIENTS DETERMINED BY A LEAST SQUARES ERROR MINIMIZATION METHOD WITH MEASURED LOAD-DEFLECTION CURVES

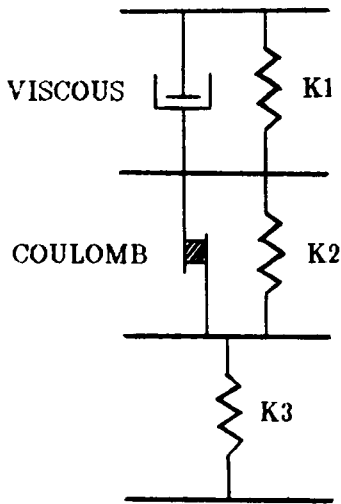

EMPIRICAL MODEL

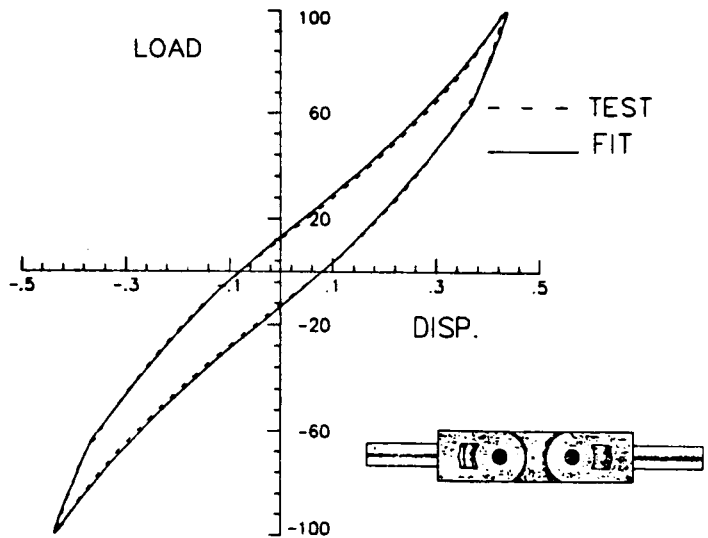

COMPARISON OF SIMULATED JOINT LOAD DEFLECTION WITH EMPIRICAL ANALYSIS MODEL

EFFECT OF CABLE SLACKENING ON SYSTEM FREQUENCY

Systems which depend on cables to provide stiffness can suffer stiffness and hence frequency reduction when the primary structure moves in such a fashion so as to allow a cable to go slack. Since cables are usually lightly loaded, slackening of cables is possible. This chart examines a simple spring/mass/damper system stiffened by a set of pretensioned cables. Frequency depends on the system response amplitude. The dash-dot curve indicates the decreasing system frequency as peak amplitude of motion increases. When the peak motion exceeds an amplitude at which the cable would slacken in a static environment, the system frequency starts to decrease even more rapidly. Also depicted on the figure is a second dash-dot curve which increases in frequency with increasing amplitude of dynamic motion. This frequency is associated with cable lateral motion and stiffens as the amplitude of the lateral motion increases.

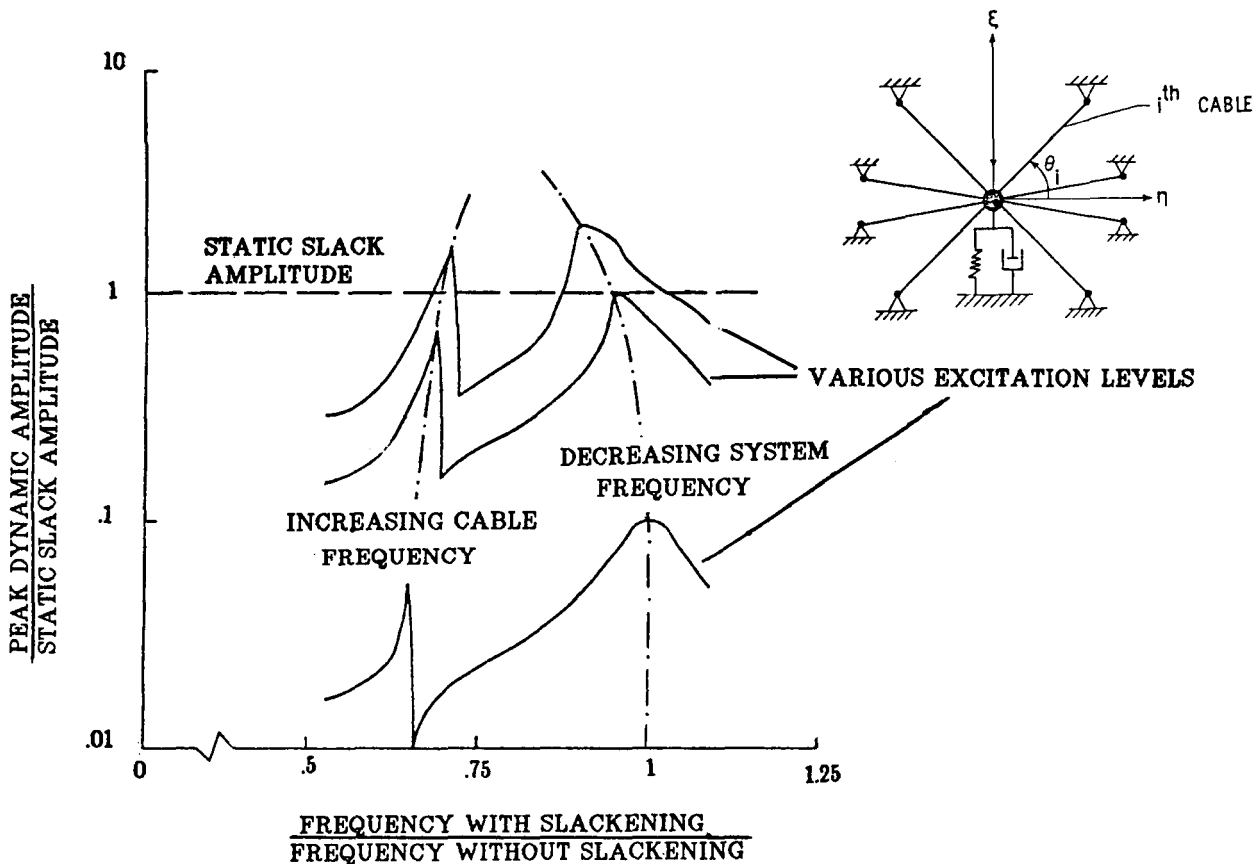

DISTRIBUTED ACTIVE DAMPING FOR FLEXIBLE STRUCTURES

A design technique for the distribution of damping on flexible structure will be formulated which includes the force/torque limitation of the actuators which will be used as active dampers. It is assumed that a large finite element model exists which describes the structure.

The design technique will first reduce the order of the finite element model. Next, active damping gains will be determined for a given disturbance while not allowing the actuators to saturate. The design problem is cast as an optimization problem to be solved by a nonlinear mathematical programming algorithm. Finally, the design results are put in the original finite element model and the performance requirements which are stated as part of the optimization problem are verified.

OBJECTIVE: TO DETERMINE ACTIVE DAMPING GAINS FOR FLEXIBLE STRUCTURES WHILE CONSIDERING DISTURBANCE MODELS, ACTUATOR LIMITS, AND STRUCTURAL PERFORMANCE CRITERIA

GIVEN: A LARGE FINITE ELEMENT MODEL OF A FLEXIBLE STRUCTURE, A DISTURBANCE MODEL, AND PERFORMANCE REQUIREMENTS

DEVELOP: REDUCED ORDER MODEL TO BE USED IN DAMPER DESIGN

ACTIVE DAMPING GAINS SUCH THAT ACTUATORS DO NOT SATURATE

OPTIMIZATION FORMULATION

VERIFIED DYNAMIC RESPONSES THAT SATISFY PERFORMANCE REQUIREMENTS

OPTIMIZATION FORMULATION

The goal of the design process is to determine the gains of the diagonal damping matrix, C. It is assumed that the mass and stiffness matrices of the structure are known via some finite element formulation. Also, it is assumed that the disturbance is known and that spacecraft performance requirements (i.e. line-of-sight error or minimum vibration amplitude) exist which mathematically define the conditions which must be achieved to ensure acceptable mission performance. At the same time it is recognized that actuators which will be used to damp the structure are limited in their force/torque output.

Starting with the undamped structure, the modes and frequencies are calculated and some smaller set of modes is used to then reduce the damped equations of motion to a small set of first order equations. The objective function used in the optimization algorithm minimizes the energy dissipated during the control cycle. Finally, the mission performance requirements which might be response limits are defined as inequality constraints in the optimization algorithm.

GIVEN: MASS AND STIFFNESS MATRICES, DISTURBANCE FORCE, AND PERFORMANCE REQUIREMENTS

DETERMINE: DIAGONAL DAMPING MATRIX, C

METHOD: $M\ddot{x} + Kx = 0$

$$\Downarrow$$
$$\lambda, \phi$$

$$x = \phi q$$

\Downarrow

$$\frac{d}{dt} \begin{pmatrix} \dot{q} \\ q \end{pmatrix} = \begin{bmatrix} 0 & I \\ -\Lambda & -\phi^T C \phi \end{bmatrix} \begin{pmatrix} \dot{q} \\ q \end{pmatrix} + \begin{pmatrix} 0 \\ \phi^T F \end{pmatrix}$$

REDUCED MODEL

OBJECTIVE FUNCTION: MINIMIZE DISSIPATION ENERGY

CONSTRAINTS: RESPONSE LIMITS

OPTIMIZATION RESULTS USING A GRILLAGE EXAMPLE

Results are obtained using a grillage as an example in the design process. A disturbance is applied to the center of the lower edge of the grillage. This disturbance is applied in the time interval from 0 to 0.5 seconds and is shown on the right of the slide. From 0.5 to 5.5 seconds the actuators are turned on and it is required that the response amplitude of the four corners of the grillage be less than 0.1 inches at the end of the control period. From 5.5 to 10 seconds there is no control but the response is monitored to ensure that no peak exists in this time period which exceeds the performance requirements.

The bars drawn normal to the surface of the grillage indicate the location of the actuators and the length of the bar is proportional to the gain at the particular location. Only force actuators are considered in this grillage example model.

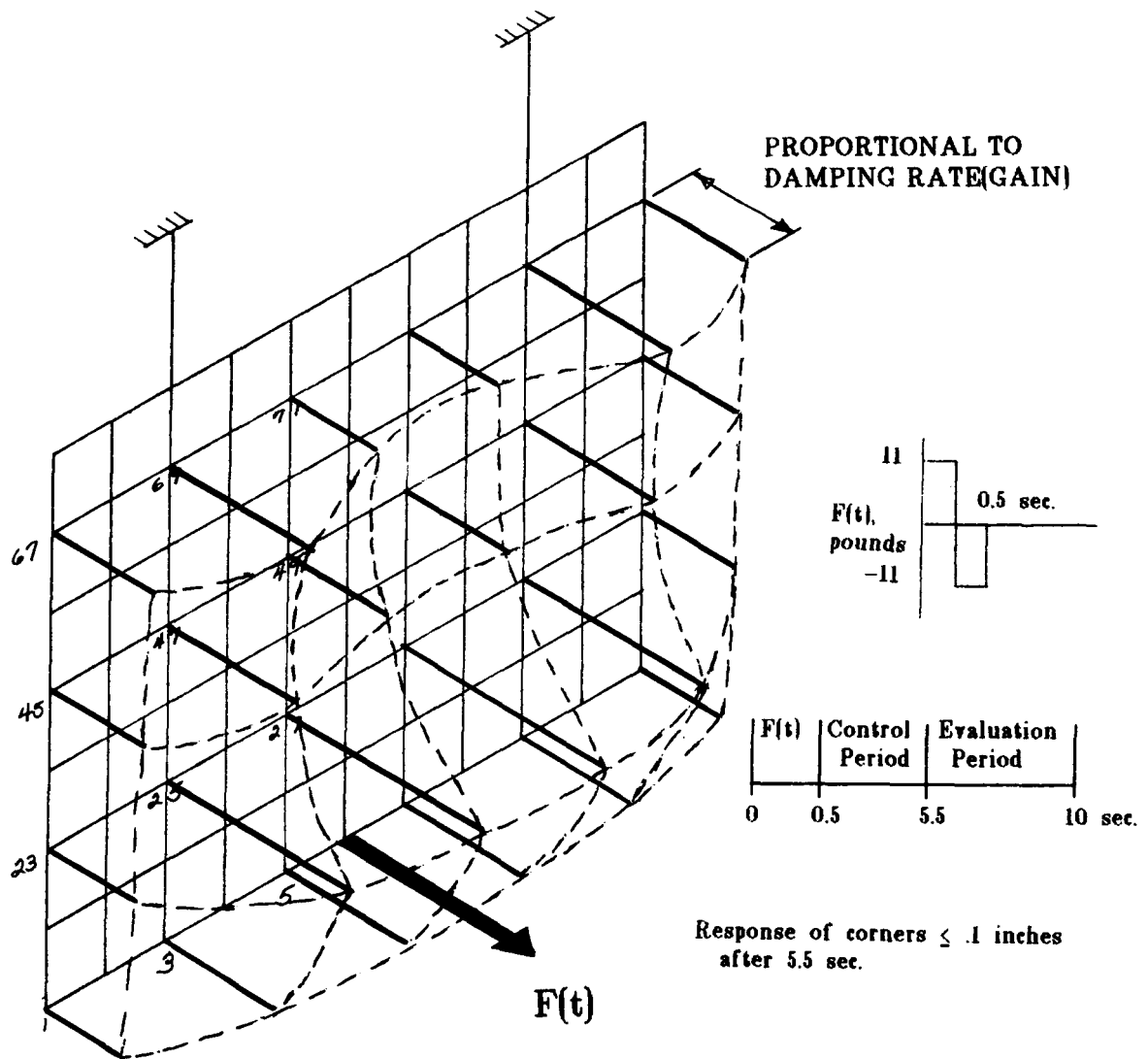

CLOSED-LOOP SIMULATION USING ORIGINAL FINITE ELEMENT MODEL

The displacement at grid point 1 (lower left corner) of the grillage model is shown below. These results were obtained using NASTRAN with the original finite element model, the damping forces simulated as a follower force calculated from the rate at the corresponding grid point location, and the disturbance applied to the model as shown in the previous slide. Note that the peak displacement from 5.5 to 10 seconds does not exceed the specified value of .1 inches.

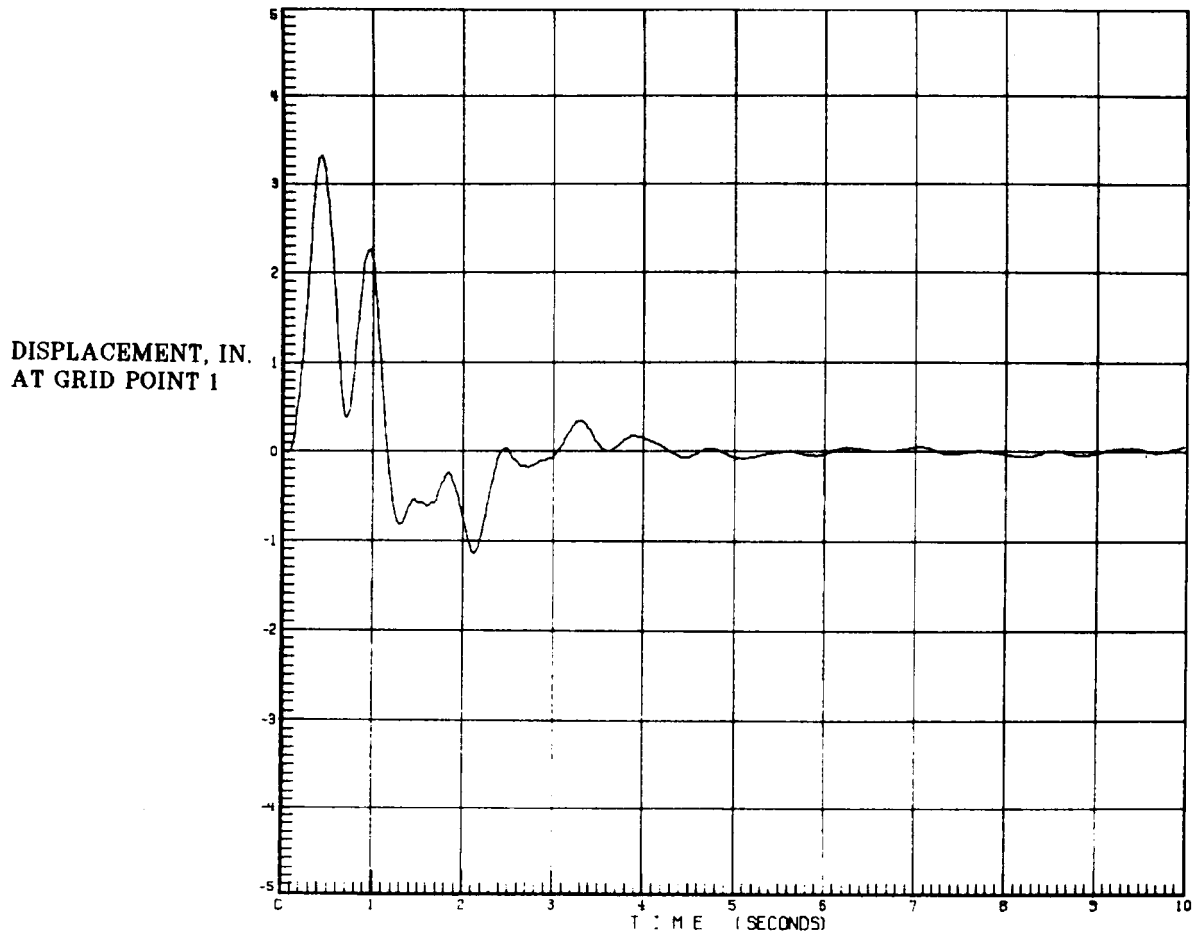

CLOSED-LOOP SIMULATION USING ORIGINAL FINITE ELEMENT MODEL

Saturation of the actuators is considered in the design algorithm and the damping force applied at grid point 1 is shown in the slide below. The saturation limit is assumed to be ± 1 pound force. From the plot it is seen that the saturation limit is not exceeded. Again, these results were obtained from NASTRAN with the closed loop model.

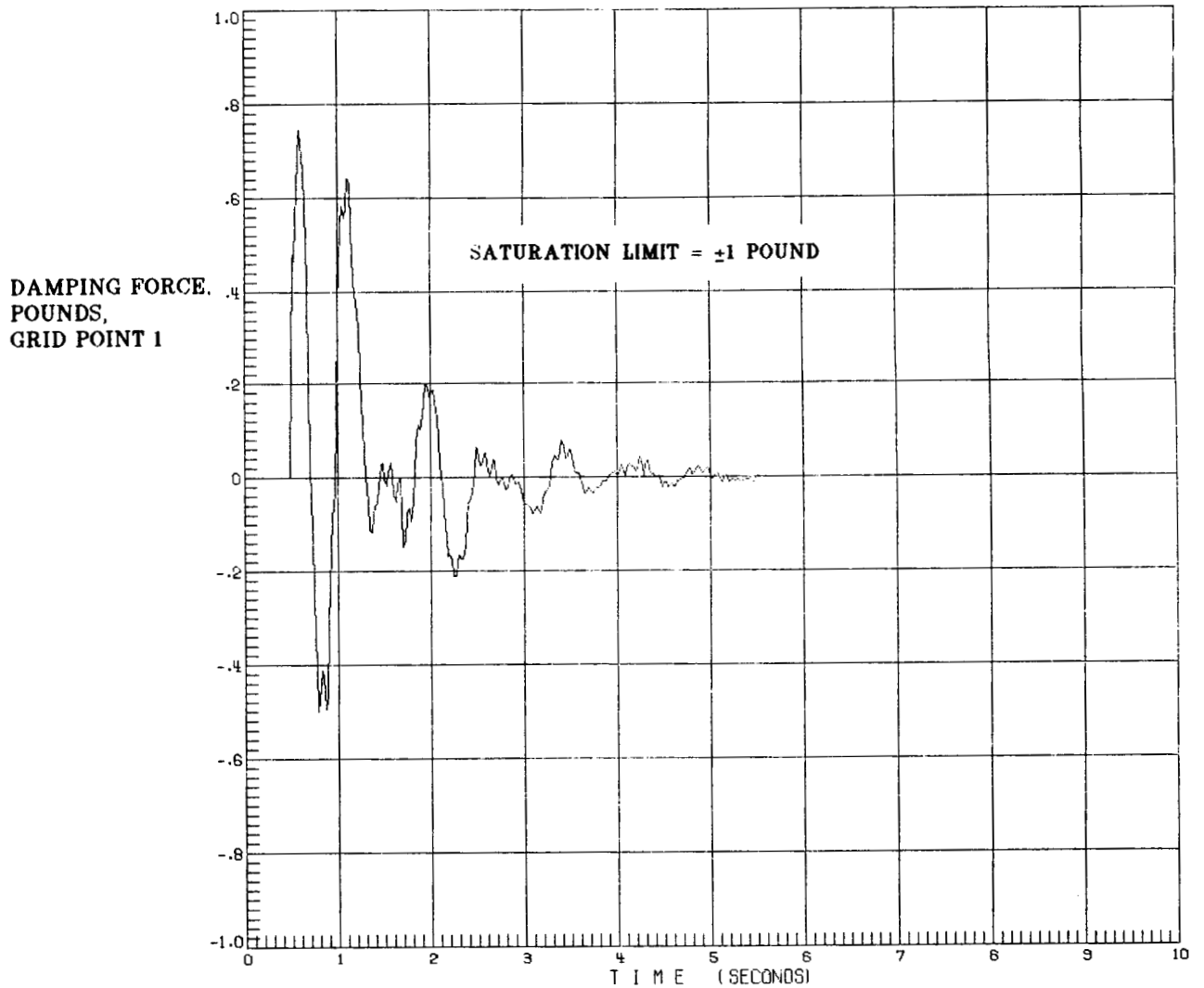

SUMMARY

Candidate computer programs for analytical deployment simulation exist, but until progress is made on improving the time integration of the equations for deployment simulation, problem size will be effectively limited by solution cost. Simulation costs can be reduced by either development of better time integration algorithms or use of concurrent processing computer hardware. For the deployed or erected antenna, repetitive analysis is a viable approach to reducing analysis effort in computing vibration modes and frequencies, but accurate properties of antenna components must be measured and used in the analysis if good correlation with test is to be accomplished. This includes improved modeling of joints especially in their nonlinear behavior. For cable stiffened antennas, it is imperative to also have the structure in equilibrium to a fine order of precision under the cable pretension loads used in the analysis. Vibration control studies need to include realistic constraints of actuator capability and such realism is now being added to such studies.

- **CANDIDATE COMPUTER PROGRAMS EXIST FOR DEPLOYMENT, BUT ARE LIMITED TO SMALL PROBLEMS ESPECIALLY IF MEMBERS ARE FLEXIBLE**
 - **NEW TIME INTEGRATION ALGORITHM AND PERHAPS ASSOCIATED FORMULATION**
 - **CONCURRENT PROCESSING MUST BE EXPLOITED**
- **REPETITIVE ANALYSIS GREATLY REDUCES COMPUTATIONAL EFFORT IN ANTENNA VIBRATIONS**
- **ACCURATE PROPERTIES OF ANTENNA COMPONENTS NEEDED TO ACHIEVE GOOD TEST/ANALYSIS CORRELATION**
- **NONLINEAR JOINT BEHAVIOR IMPORTANT TO FREQUENCY AND DAMPING PREDICTIONS**
- **ANALYTICAL STUDIES IN VIBRATION CONTROL NOW ACCOUNTING FOR SOME REALISTIC LIMITATIONS**