

43
N85-16940

SPACE SHUTTLE MAIN ENGINE - INTERACTIVE DESIGN CHALLENGES

John P. McCarty
National Aeronautics and Space Administration
George C. Marshall Space Flight Center, Alabama

and

Byron K. Wood
Rocketdyne Division
Rockwell International Corporation

ABSTRACT

The operating requirements established by NASA for the SSME were considerably more demanding than those for earlier rocket engines used in the military launch vehicles or Apollo program. The SSME, in order to achieve the high performance, low weight, long life, reusable objectives, embodied technical demands far in excess of its predecessor rocket engines.

The requirements dictated the use of high combustion pressure and the staged combustion cycle which maximizes performance through total use of all propellants in the main combustion process. This approach presented a myriad of technical challenges for maximization of performance within attainable state-of-the-art capabilities for operating pressures, operating temperatures and rotating machinery efficiencies. Controlling uniformity of the high pressure turbomachinery turbine temperature environment was a key challenge for thrust level and life capability demanding innovative engineering. New approaches in the design of the components were necessary to accommodate the multiple use, minimum maintenance objectives. Included were the use of line replaceable units to facilitate field maintenance, automatic checkout and internal inspection capabilities.

INTRODUCTION

The National Program to develop a Space Shuttle and replace the "one-shot" expendable rocket vehicles with a reusable Space Transportation System promises to be a turning point in liquid propellant rocket engine history.

The requirements for reuse with a minimum refurbishment and turnaround cycle introduced stage requirements such as reusable reentry thermal protection, wing surfaces and landing gears. These features, and others, contributed to a relatively high hardware weight when compared to non-reusable systems. In addition, reentry and landing flight characteristics put a premium on high engine thrust-to-weight and small engine envelopes. As a result the search for performance for the Shuttle Systems, i.e., more payload delivered to orbit at reduced cost, focused main engine performance requirements on increases in specific impulse, thrust-to-weight and thrust-to-engine exit area. Engine operational requirements consistent with reusable, low-cost transportation, included long life and low maintenance to reduce recurring cost and minimum development program to reduce non-recurring cost.

THE CHALLENGE

It can readily be seen that the search for performance can be pursued along two directions, more specific impulse and lower rocket engine weight.

The early history of the application of liquid propellant rockets has seen the succession of more energetic propellant combinations. The use of hydrogen/oxygen for the propellants of the Space Shuttle Main Engine (SSME) represents a propellant choice near the peak of readily available chemical propellant combinations. This succession of more energetic propellants has been accompanied by a drive to reduce rocket engine weight necessary to achieve a given installed performance level. Figure 1 shows that increased thrust-to-weight is accomplished by increasing the ratio of engine thrust to nozzle exit area. Increasing the engine thrust per unit exit area also has the effect of reducing the nozzle exit area at a given thrust, thereby reducing vehicle drag associated with the attendant base area.

Using this relationship and the theoretical performance characteristics shown in Figure 2 which are representative of LH_2/LO_2 , one can construct Figure 3 which displays the path necessary to achieve improvements in installed performance.

Figure 3 shows that to increase specific impulse at a given thrust-to-weight, or to increase thrust-to-weight at a given specific impulse, or to increase both requires an increase in the combustion pressure. This combustion pressure increase can be traced in the LO_2/LH_2 family of engines where

capability has progressed from the RL-10 at 400 psia, through the J-2 at 632 psia and the J-2S at 1200 psia to the current development of the SSME at 3000 psia. The J-2 and J-2S combustion pressures noted above result from these engines using the gas generator power cycle. In this cycle a small portion of the incoming propellant is used to power the turbopumps which feed propellant to the main thrust chamber, instead of producing thrust. If these engines had used the staged combustion or preburner cycle, in which all of the fuel powers the turbopumps before being used in the main thrust chamber, like the RL-10 and SSME, the combustion pressure would be close to that shown in the Figure.

These increases in combustion pressure have been accomplished through improvements in component technology, improved materials, higher speed and head rise pumps, higher turbine inlet temperatures, and improved cooling techniques for higher heat fluxes to name but a few. To place the SSME challenges in perspective it is appropriate to compare a few key operating characteristics to those of prior systems.

Increased combustion pressures require increased power to feed the propellants to the combustion chamber. The generation of these high power levels must employ a highly efficient working cycle to minimize, or preferably avoid any performance loss. The well developed gas generator cycle, which served adequately for most prior engines, is shown in a simplified schematic in Figure 4 along with the more efficient preburner cycle. Also shown is a comparison of the specific impulse and the lower value which results from the inefficient utilization of the turbine exhaust gases in producing thrust. On the other hand, the preburner cycle requires considerably higher pump discharge pressures, as shown in Figure 5, to accommodate the pressure drop which occurs in the turbines.

The need for very high pump discharge pressures must be met by increased head rises from the individual pump stages to minimize the number of stages and pump weight. Impeller tip speeds, as shown on Figure 6, increased substantially. In parallel, the focus on minimum weight pushed the design sophistication and speed, as shown in Figure 7, beyond levels then in use.

High chamber pressure has a significant impact on combustion chamber cooling. Gas side heat transfer coefficients increase with chamber pressure to approximately the 0.8 power. These high film coefficients increase the heat flux, as shown in Figure 8, which must be accommodated by the cooling system to meet the long life requirements.

One of the prime characteristics of the Space Shuttle, and consequently the SSME, is design for reusability and long life with minimum maintenance. These requirements must be achieved despite the extreme physical environments imposed upon the engine components and the demand that the hardware be fully utilized to just short of the point where safety and performance are impaired.

Basic to this concept of reusability is the extension of design life typically required for expendable engines - 10 starts and 3600 sec which is sufficient for acceptance tests and the single flight - to that required for the SSME - 55 starts and 27000 sec which should be sufficient for 50 to 55 missions after acceptance tests. Field maintenance with minimum between flight activity required advances relative to prior rocket engine experience and practices. Examples include the identification and design of line replaceable units that are interchangeable without system recalibration, establishing and verifying effective inspection and automatic checkout procedures to facilitate the short turnaround goals of the Shuttle system, and integration of development experience, field maintenance records and flight data analysis to extend the time between component replacements and engine overhaul.

Equally ambitious to the technical challenges outlined above was the programmatic challenge to accomplish the design, development and certification with the utilization of resources substantially less than required in previous, comparable development programs. A measure of the resources is represented by the engine test programs shown in Figure 9. As can be seen the projected number of tests and development engines were reduced by some 40%.

THE ENGINE

The SSME primary flow schematic is shown in Figure 10 and briefly described as follows:

The fuel flow enters the engine at the low-pressure turbopump inlet and pressure is increased to meet high-pressure pump inlet requirements. After the fuel leaves the high-pressure pump, the flow is divided and distributed to provide: preburner fuel, nozzle coolant, main combustion chamber coolant, low-pressure turbine drive gas and hot gas manifold coolant.

The oxidizer flow enters the engine at the low-pressure turbopump inlet. The low-pressure oxidizer pump increases the pressure to meet high pressure pump inlet requirements. From the high pressure pump discharge, the majority of the oxidizer is fed to the main injector. The remaining oxidizer is increased to preburner inlet pressure by the high-pressure boost stage of the oxidizer pump. Liquid oxygen from the high pressure pump discharge is used to drive the low pressure oxidizer turbine.

Individual preburners are used to supply power for the high pressure fuel and oxidizer turbines. Preburners provide the flexibility to adjust the power split between the two high pressure turbines by the control of valves which govern the oxidizer flow to the preburners.

The majority of the high pressure fuel is used in the turbine drive system. The remainder is used to cool components and power the low pressure fuel turbopump. A portion of the oxidizer flow also is used in the preburners; the remainder is routed directly to the main combustion chamber. The propellants combusted in the preburners power the high pressure turbopumps and are then routed to the main combustion chamber.

In the main combustion chamber, the gases from the preburners are burned with the propellants.

The major engine physical arrangement, Figure 11, provides for a central structural member called the powerhead wherein are located the main injector and respective fuel and oxidizer preburners. The main combustion chamber and the two high pressure turbopumps "plug in" and are bolted to the powerhead.

CONSTRAINING DESIGN CONSIDERATIONS

The significant system development challenges can be grouped around the central issue of how to develop sufficient turbomachinery horsepower to meet the high pressure performance demands and maintain turbine operating temperature both transient and steady state within life limit practicality.

In the preburner cycle hydrogen flow availability and pressure schedule are the prime design considerations. Unlike most prior operational systems which use a small percentage (10%) of the engine fuel flow to drive high pressure ratio turbines the SSME preburner cycle seeks to use 100% of the engine fuel flow to drive low pressure ratio turbines. In Figure 5 this directly dictates the pumping system required head, and therefore, the system pressure schedule.

The available power to produce these conditions is in turn limited by turbomachinery efficiency, turbine flowrate and turbine temperature. In very simplified terms the relationship can be represented by the following:

$$\eta (1 + MR) T C_p \left[1 - \left(\frac{P_c}{P_D} \right)^{\frac{\gamma-1}{\gamma}} \right] = P_D \left(\frac{1}{\rho_F} + \frac{MR}{\rho_o} \right)$$

η = Turbopump Efficiency

T = Turbine Gas Temperature

P_c = Chamber Pressure

P_D = Pump Discharge Pressure

ρ = Density

MR = Mixture Ratio

γ = Specific Heat Ratio.

Figure 12 illustrates the premium paid to maximize turbomachinery efficiency and design for high temperature operation. Taken all together the relationship between pressure (weight) and turbomachinery efficiency at a fixed structural temperature limit are depicted in Figure 13 by parametric solution of the above equation.

DEVELOPMENT

To drive the three stage centrifugal high pressure fuel turbopump with a demonstrated pump efficiency between 74 and 78 percent a maximum first stage turbine blade metal temperature of 1960 degrees R was selected or a gas temperature of approximately 2000 R. The material properties for the Mar-M-246-DS blades are shown in Figure 14 which for steady state stresses would provide essentially infinite life at 1960 degrees R.

SSME development testing at full thrust exhibited erosion of the first stage turbine blade platform leading edges with accelerating damage test-to-test and high maintenance. This precipitated the

removal of the turbopumps for replacement of the first stage blades. In addition, a number of blades exhibited transverse leading edge high cycle fatigue cracks above the blade root giving rise to concern for blade failure.

As a consequence a specially instrumented turbopump, Figure 15, was fabricated with circumferential inlet blade O.D. and I.D. temperature thermocouples. Testing with the special instruments revealed the problem to be both start transient and steady state mainstage oriented. Hot gas temperature spikes approaching 4000 degrees R were recorded as the preburner ignited. In addition, a radial temperature distribution was confirmed in which the inner core gases approach 3000 degrees R with the outer diameter gases near 1900 degrees R, Figure 16. The inner core gases by stream tube analysis would be the ones aggravating the blade root erosion problem as illustrated in Figure 17.

DESIGN INNOVATION

The Fuel Preburner is a fuel cooled, double walled chamber producing energy to drive the High Pressure Fuel Turbopump. The injector is a concentric element with 264 elements and three baffles to aid stability. The preburner is ignited by an augmented spark igniter (ASI) which is a small central combustion chamber with two spark igniters. The injector has a single pair of impinging oxidizer orifices surrounded tangentially by eight hydrogen orifices. The injection flow pattern creates an oxidizer-rich condition at the spark igniters for ignition. An oxidizer-rich core surrounded by fuel provides a high mixture ratio torch to ignite the preburner.

The resolution of the blade erosion challenge was approached in two ways. First the preburner face hot gas temperature distribution was modified to reduce the inner core temperature by raising the outer diameter temperature in a region where a higher allowable blade temperature can be tolerated, Figure 17. This assumes the blade stress to be a linear function of height. This was accomplished by enlarging the preburner baffle center coolant holes, providing a 20% increase in center core cooling, Figure 18. In addition, the preburner injector face coolant holes were modified by enlarging 132 existing holes and adding 36 holes in the inner zones of the injector face, Figure 19.

These modifications resulted in the reprogrammed temperature distribution shown in Figure 20 and a verified blade temperature distribution shown in Figure 21.

The second innovation addressed the ignition temperature spike. The ignition of the preburner is accomplished by regulation of the oxidizer flow to the preburner by the inlet valve. The resulting temperature at ignition directly correlates to the oxidizer accumulated up to the point of ignition. The SSME onboard control system provides the flexibility to adjust the scheduling of the engine control valves.

As a result a notch was added to the preburner oxidizer control opening, Figure 22. The notch was programmed to limit oxidizer flow at the time of ignition but subsequently increase flow at a time of higher fuel flow availability in order to not affect the total start time integrated oxidizer flow.

The effect of the modification on the resulting temperature transient is shown in Figure 22. This and the above modification were successful in adjusting the design on a simple but innovative basis to produce the desired environment. Since the modification, test and flight hardware have shown a marked improvement in observed erosion and cracking, thereby, significantly reducing required and projected maintenance.

REUSABILITY, LIFE AND MAINTENANCE

The preceding was just one example of many innovative concepts essential in the SSME design to meet the reusable Shuttle life challenge. Each component that experiences cyclic loading during operation was designed to have a minimum high cycle fatigue life of at least 10 times the number of cycles it will experience during service life. All components were designed to have a minimum low-cycle fatigue life of at least four times service life. A factor of 4 was also maintained on the time to rupture to account for creep effects. For those components experiencing both high and low cycle fatigue a generalized life equation is used to assess the accumulative damage capability versus time and thrust level.

The SSME has matured to a current 10-flight capability with a safety factor of 2. Testing will seek to keep pace with operational use and extend the operational life goal to 55 starts and 27,000 sec with a factor of 2, Figure 23. The testing will define components not capable of full life and spares requirements will be adjusted accordingly. The redesign of short-life components will be undertaken only if clearly economical to the program.

Test results will also become part of the mechanized information system developed to track critical hardware for operational exposure and life-limiting conditions. The system provides fingertip information with respect to component remaining available life by a system of interactive computer terminals located at key user sites.

As a consequence nearly all SSME components were designed as Line Replaceable Units (LRU's) to accommodate field maintenance for the operational phase of the program. Turbopumps, valves, ducts, instrumentation, igniters, nozzle and controller are considered normal LRU's. After manufacture or refurbishment, the performance characteristics of selected LRU's is determined by special "green run" tests. With the operating characteristics known, any LRU component can be replaced in the field and the pertinent controller software can be updated to reflect the new LRU component characteristics; assuring proper operation of the engine. Removed components are recycled through a depot maintenance program and made available as spares for future changeouts.

The high pressure turbopumps have the most demanding field maintenance requirements. The fuel pump turbine end sections must be inspected every other flight, and blade replacement is mandatory after eight flights. The oxidizer pump turbine end sections must be inspected and turbine blades replaced every eight flights. Current development testing is being focused on these areas to extend life and reduce operational maintenance.

Internal visual inspection of critical parts replaces the engine disassembly method used in past programs for routine inspection of parts. Routine maintenance tasks include automatic checkout, external inspection of engine hardware, turbomachinery torque checks and "life" inspections with internal inspection of key components using borescopes. Borecope ports, Figure 24, have been included in the design to permit internal visual inspection, by simply removing a plug and inserting the borescope. Routine use of the fibrous optic devices developed by the medical field is now common practice for SSME, Figure 25. These borescopes can be connected to still or TV cameras to record life data, Figure 26.

Maintenance data and flight data together are analyzed to determine if corrective maintenance or component replacement is required. Since corrective maintenance represents the largest single expenditure of time and resources during the turnaround cycle, full utilization of the service life available in each component is a necessary goal.

CONCLUSION

The quest for high performance, low weight and small envelopes through the use of more energetic propellants and increased combustion pressure has recorded a high level of refinement with the successful certification and flight of the SSME on Columbia and Challenger.

The next objective is to increase the operating life and reusability of these engines through repeated engine testing to extend the demonstrated basic ten flight usage. During this testing, life limits for specific LRU's will be determined and maintenance procedures will be developed to assure satisfactory flight performance. Should any new problems relating to life occur in the ground tests, they can then be defined and solutions developed to avoid similar problems in flight. Minor design improvements will be made to life-limiting parts.

As a companion effort, a product improvement study will address the complete engine in terms of design margins and ultimate life potential. NASA's supporting research and technology (SRT) program will continue to seek means to improve the life and reliability of launch vehicle engines such as the SSME. It includes for example work to increase the life of the turbine blades in the high-pressure pump and of heavily loaded bearings.

The Space Shuttle will be the backbone of this nation's space transportation for the remainder of this century and beyond. Use of the SSME should extend well into the next century. Other potential new vehicles will undoubtedly draw on the existing SSME capabilities. Through the planned improvements, and possibly uprated thrust, the SSME should meet the national requirements for launch-vehicle propulsion to space for decades.

REFERENCES

F. P. Klatt and V. J. Wheelock, "The Reusable Space Shuttle Main Engine Prepares for Long Life," presented at ASME Winter Annual Meeting, 14-19 November 1982.

J. P. McCarty and J. A. Lombardo, "Chemical Propulsion - The Old and the New Challenges," AIAA Student Journal, December 1973.

J. P. McCarty, "Space Shuttle Main Engine Concepts Technical Assessment", Unpublished Marshall Space Flight Center Presentation, July 1969.

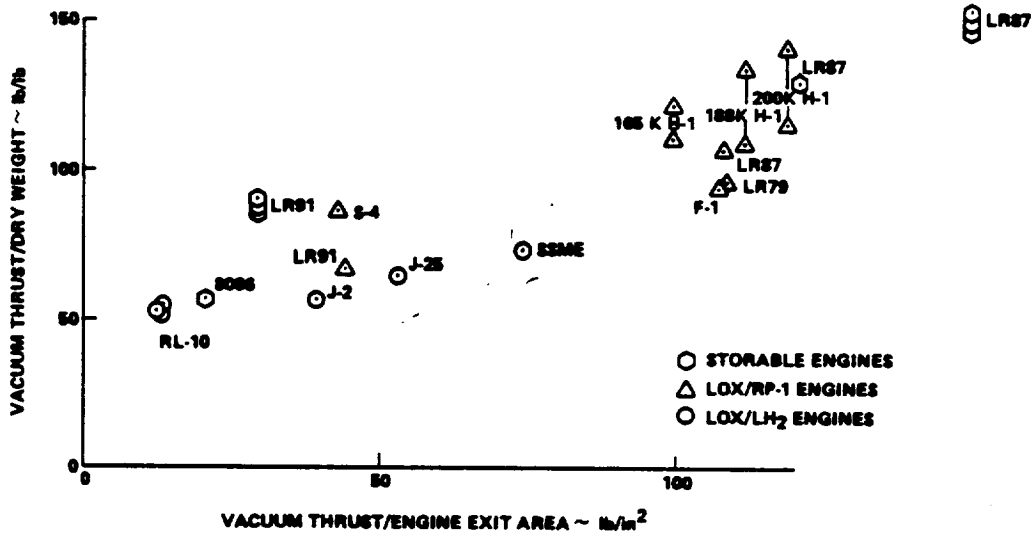

Figure 1. Engine System Weight.

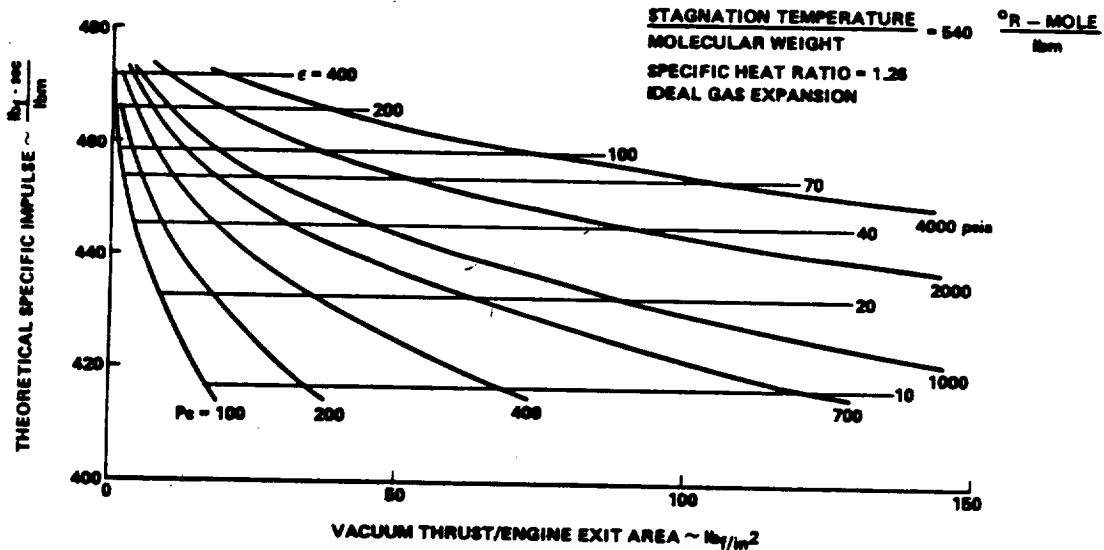

Figure 2. Theoretical LH₂/LO₂ Propellant Performance.

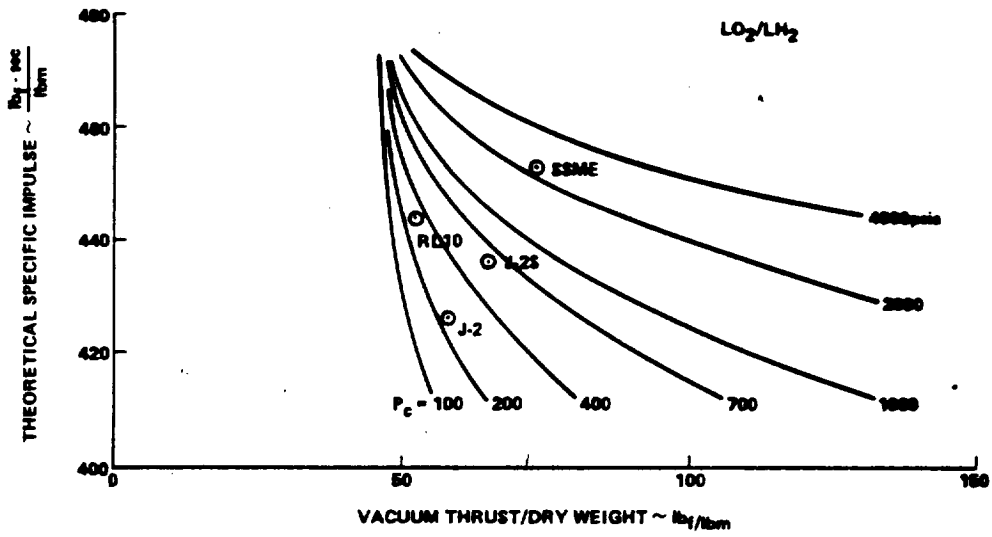

Figure 3. LH_2/LO_2 Rocket Engine Performance Characteristics.

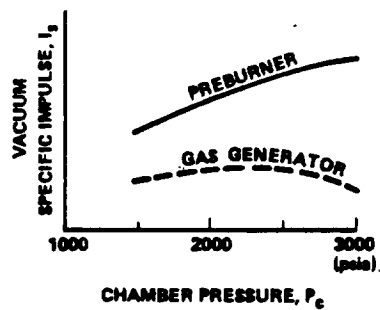
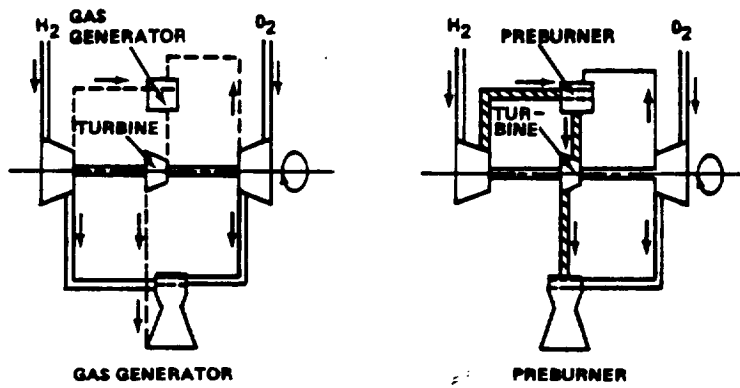

Figure 4. Gas Generator and Preburner Systems (Simplified).

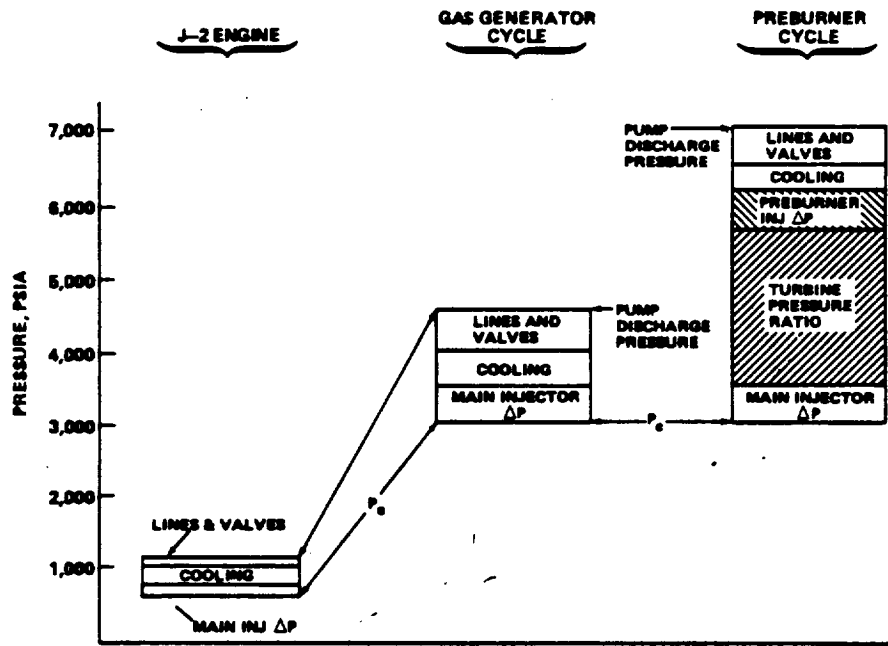

Figure 5. Rocket Engine Pressure Schedule.

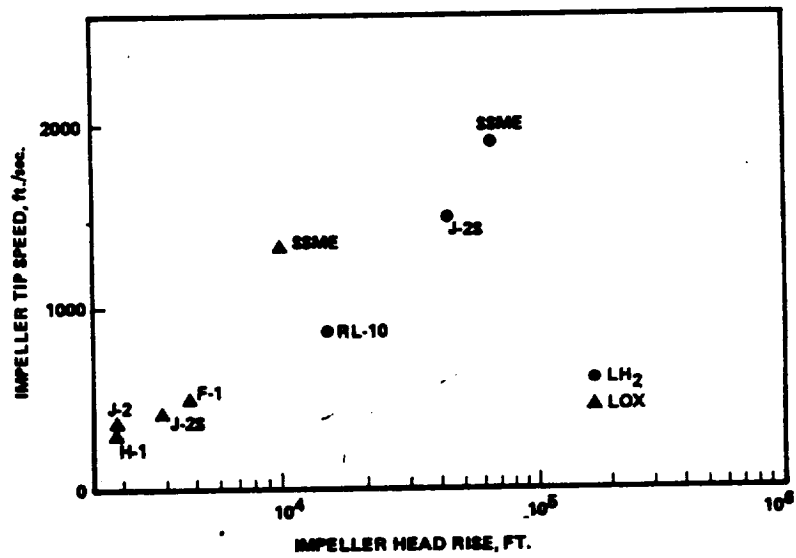

Figure 6. Impeller Design Experience.

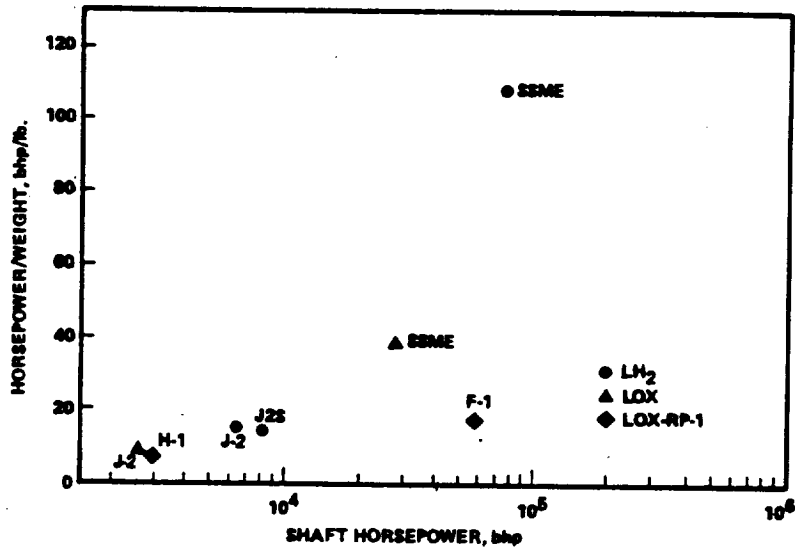

Figure 7. Turbopump Power/Weight Experience.

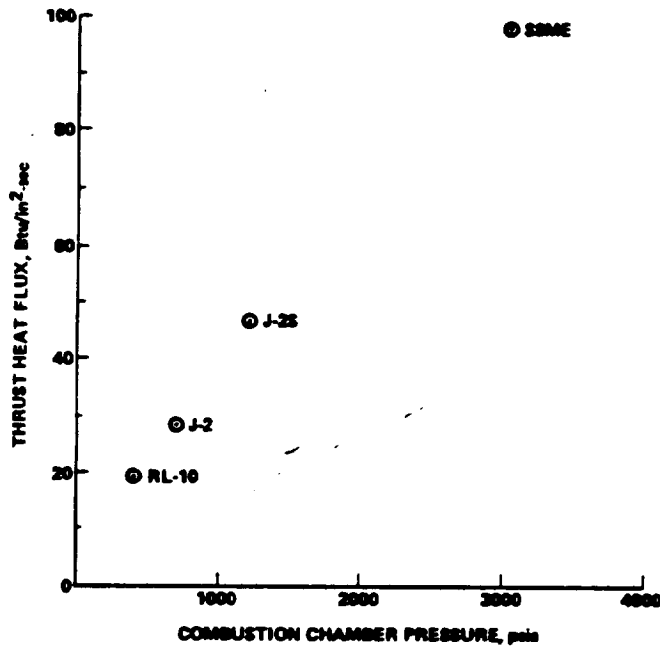

Figure 8. Combustion Chamber Heat Flux.

UNION PACIFIC
OF POOR QUALITY

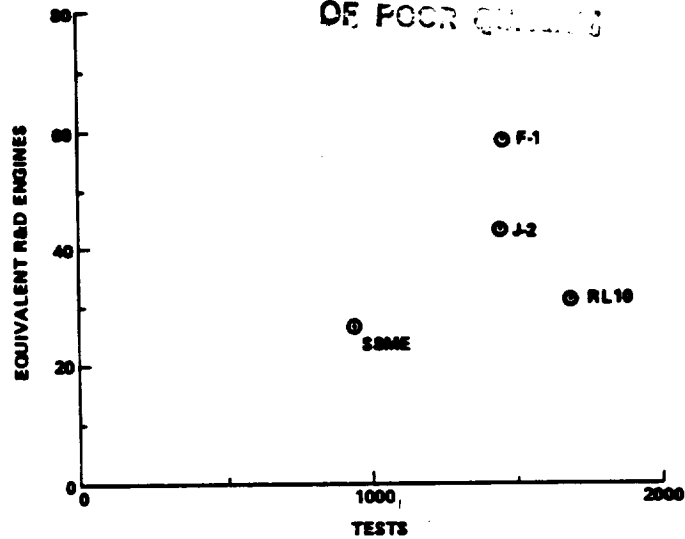

Figure 9. Development Resources.

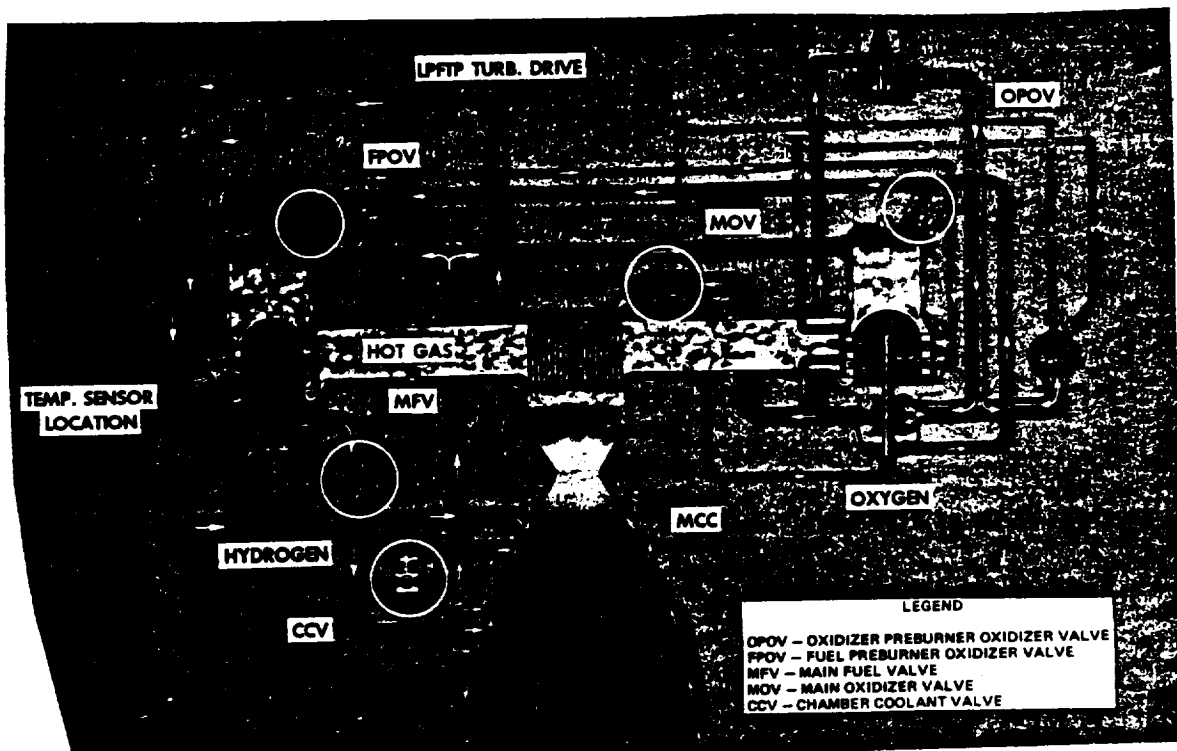

Figure 10. SSME Propellant Flow Schematic.

Reproduced from
best available copy.

ORIGINAL PARTS
OF POOR QUALITY

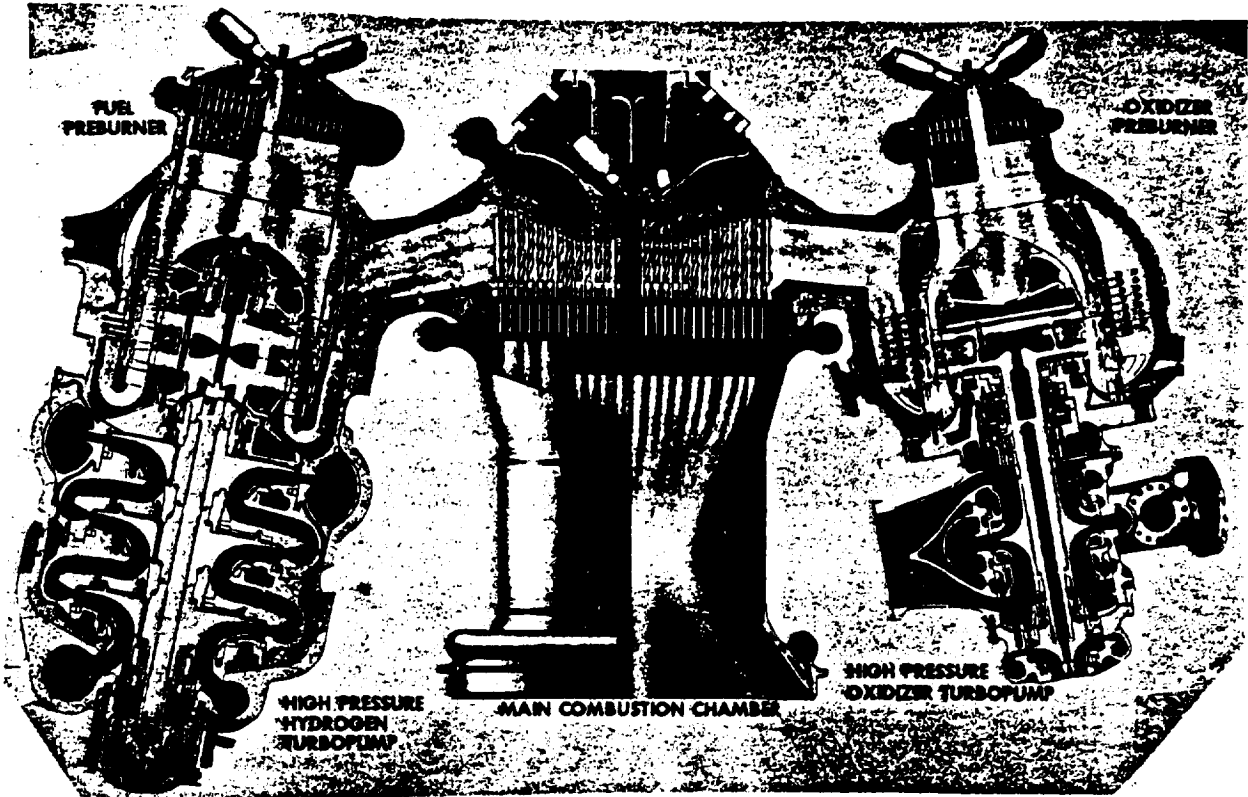

Figure 11. SSME Powerhead Component Arrangement.

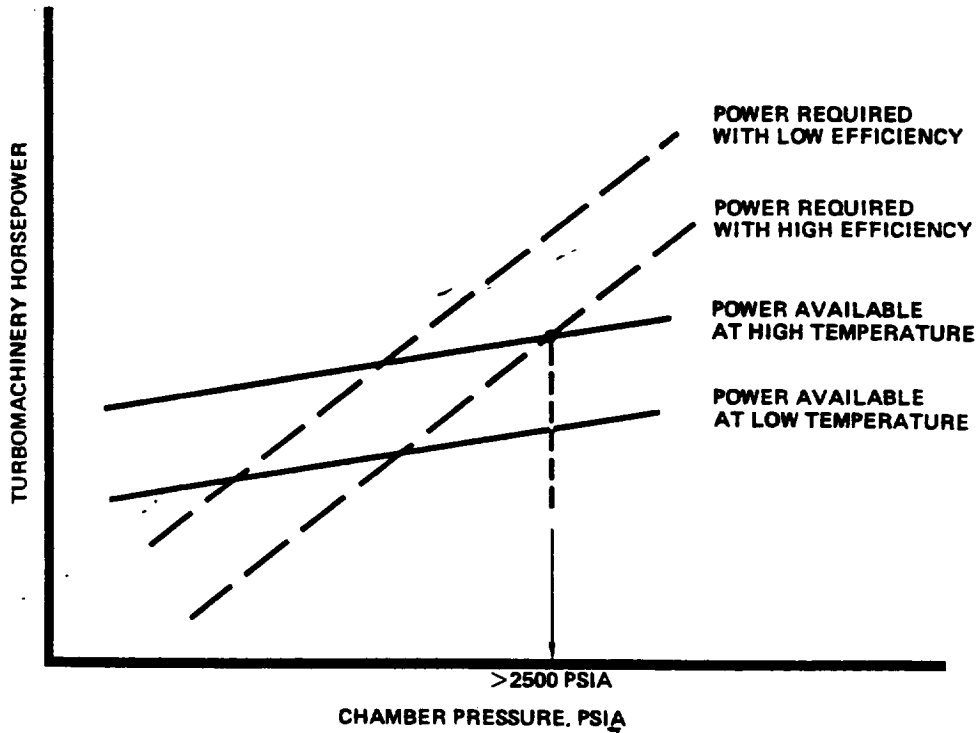

Figure 12. Staged Combustion Cycle.



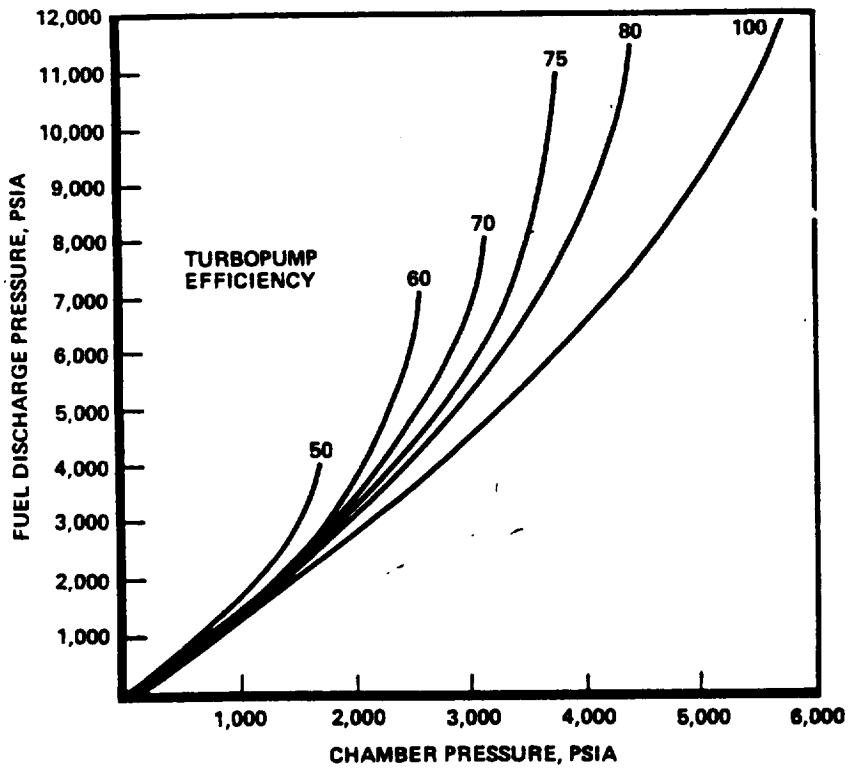

Figure 13. Staged Combustion Cycle.

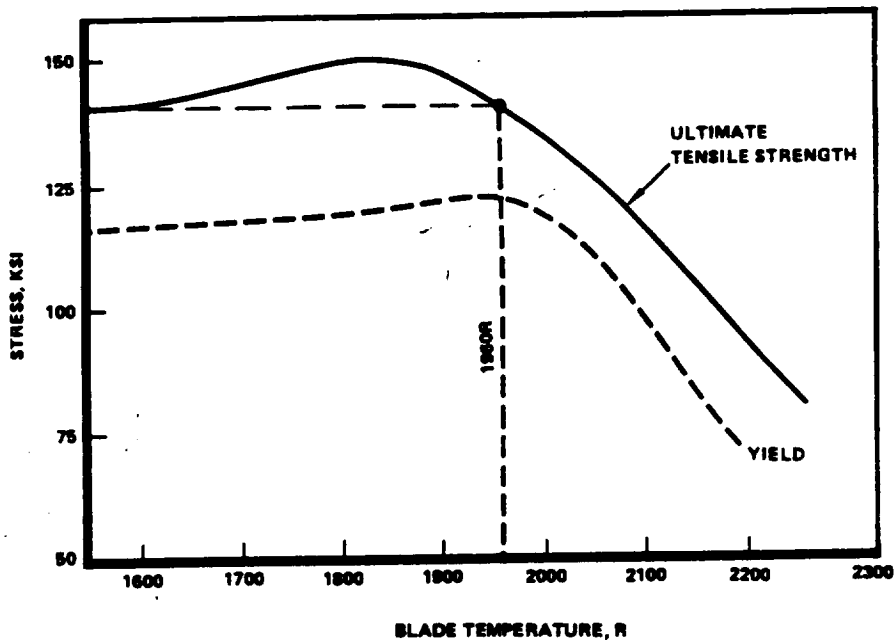

Figure 14. HPFTP Turbine Blade Metal Temperature (MM-246-DS).

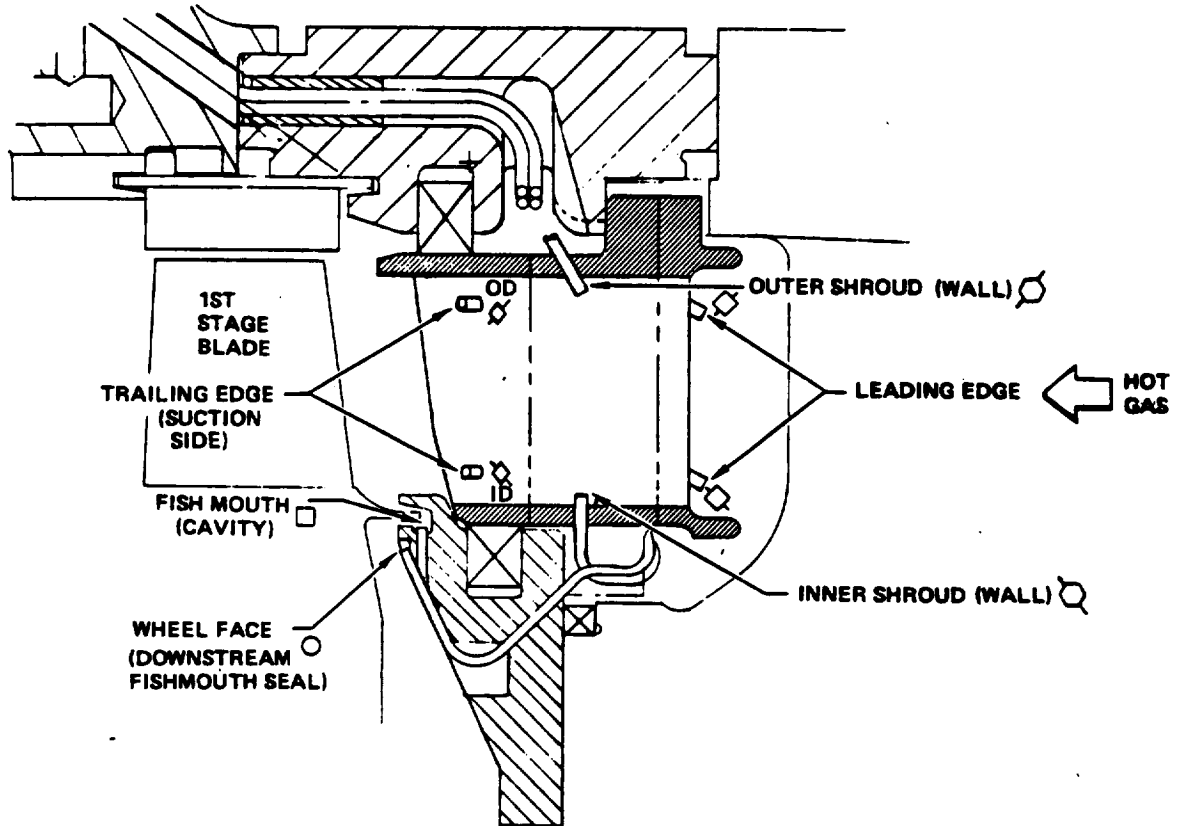

Figure 15. HPFTP Instrumented Nozzle.

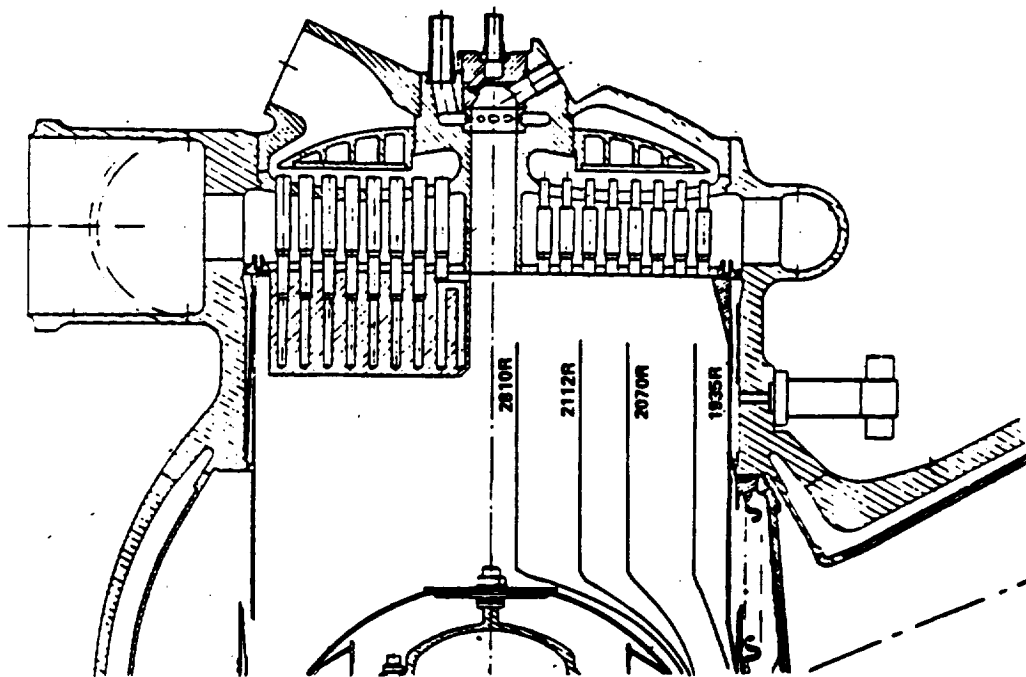

Figure 16. Fuel Preburner Temperature Distribution.

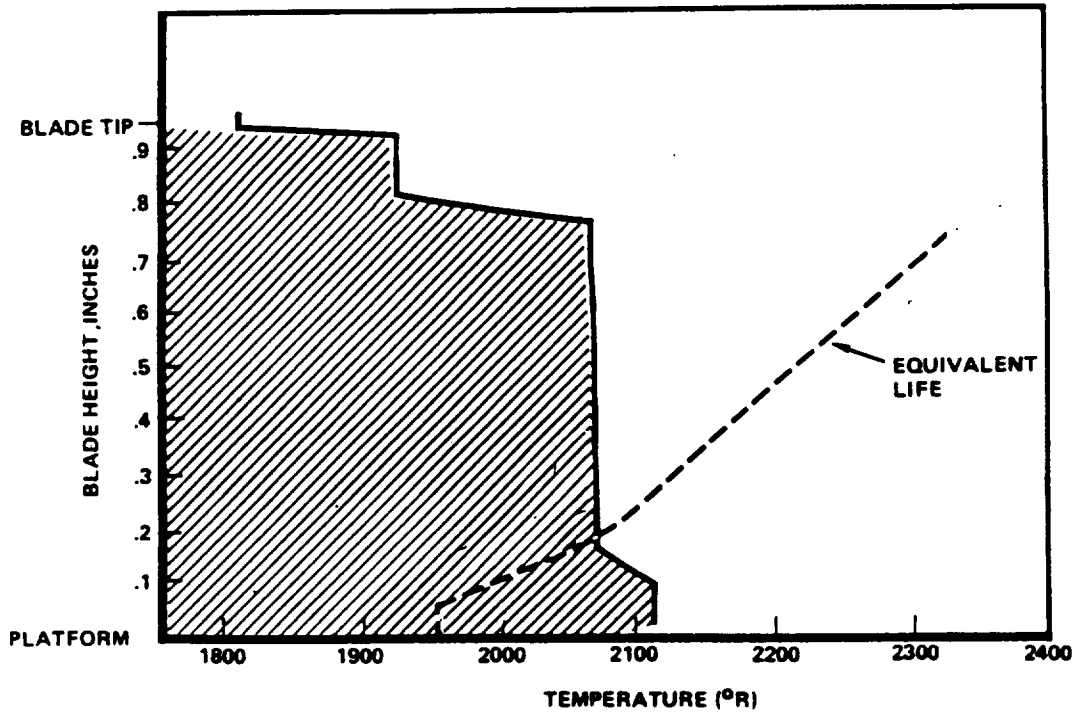

Figure 17. HPFTP First Stage Blade Temperature Profile.

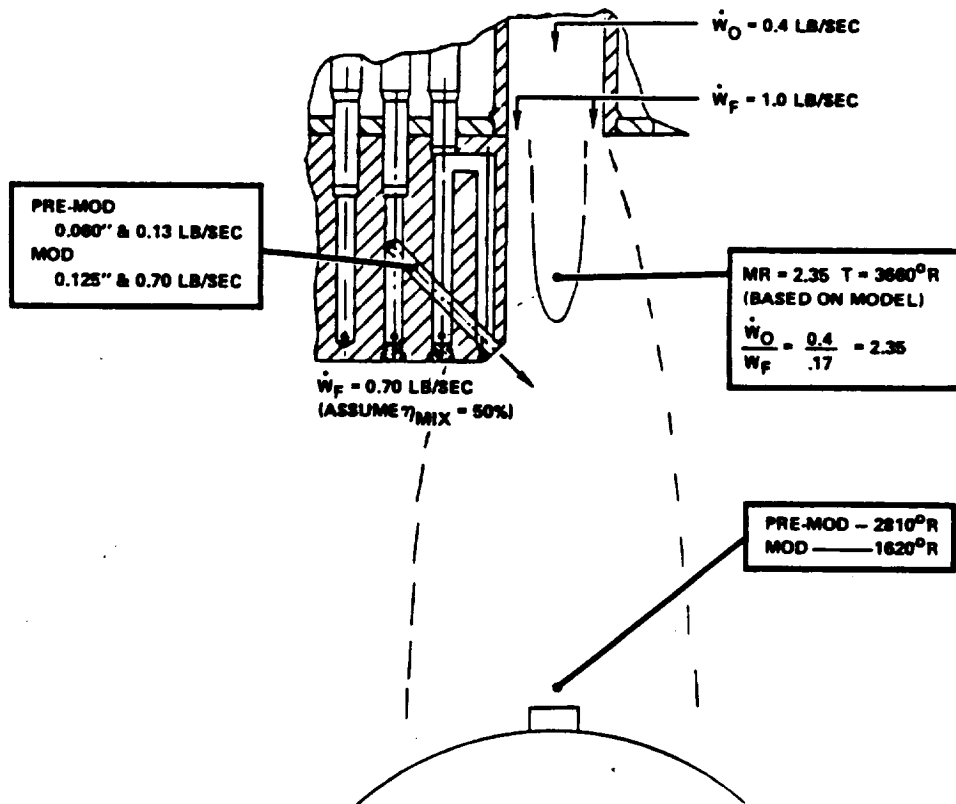

Figure 18. Fuel Preburner Baffle Modification (ASI Core Temp.).

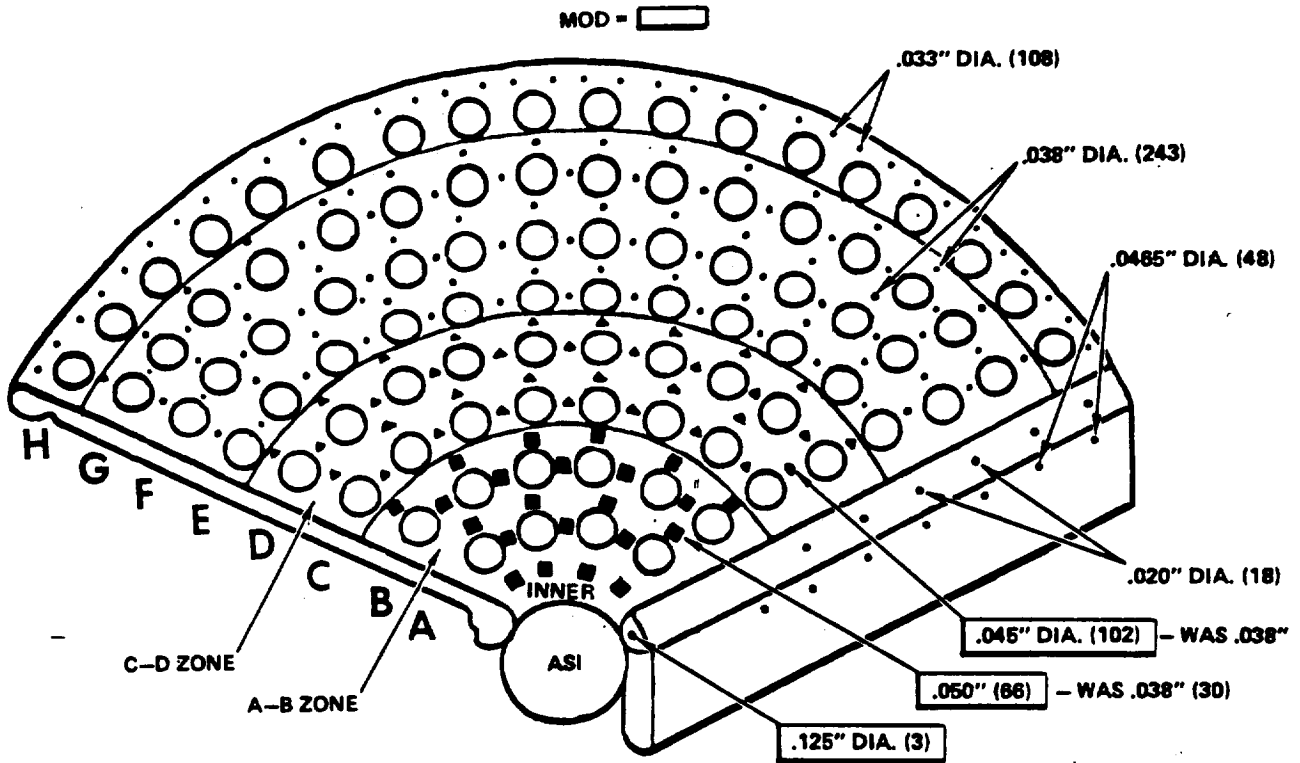

Figure 19. Fuel Preburner Injector Modification.

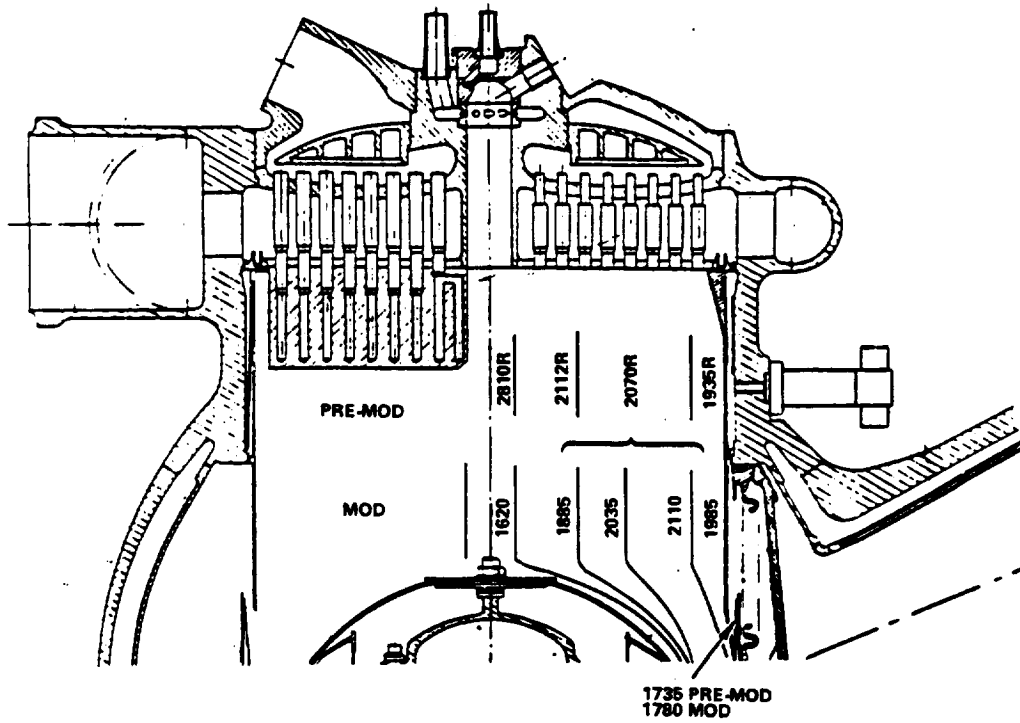

Figure 20. Fuel Preburner Temperature Comparisons Radial Distribution.

CRITICAL ANALYSIS
OF PERFORMANCE

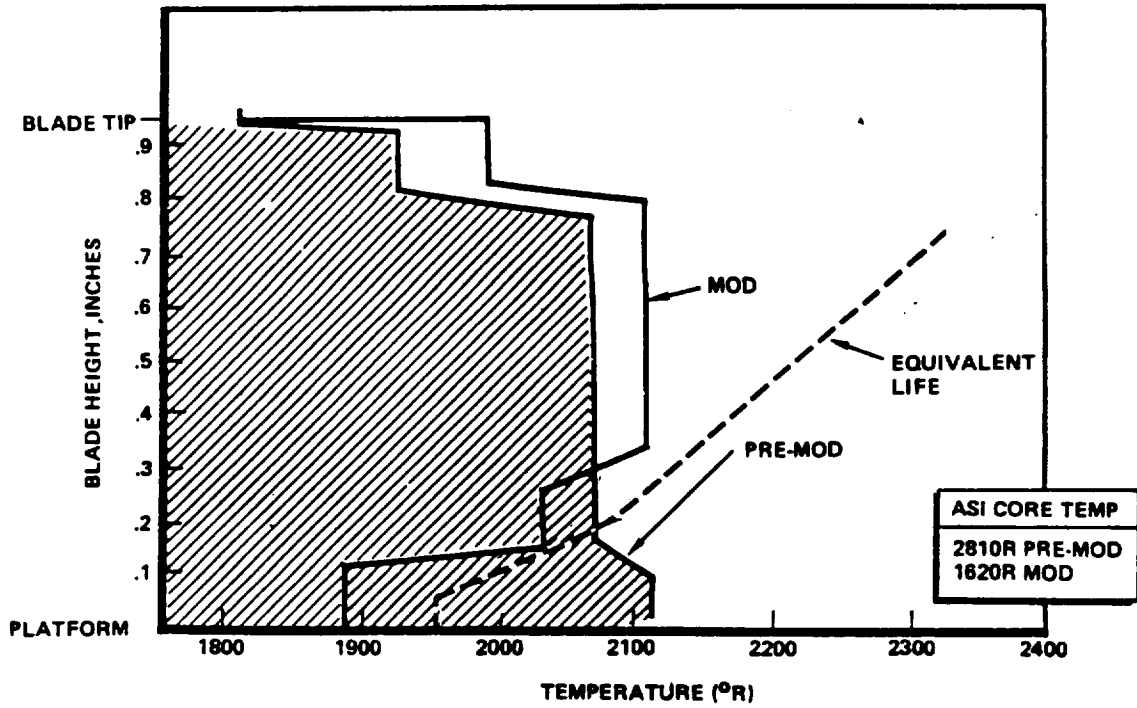

Figure 21. HPFTP First Stage Blade Temperature Profile.

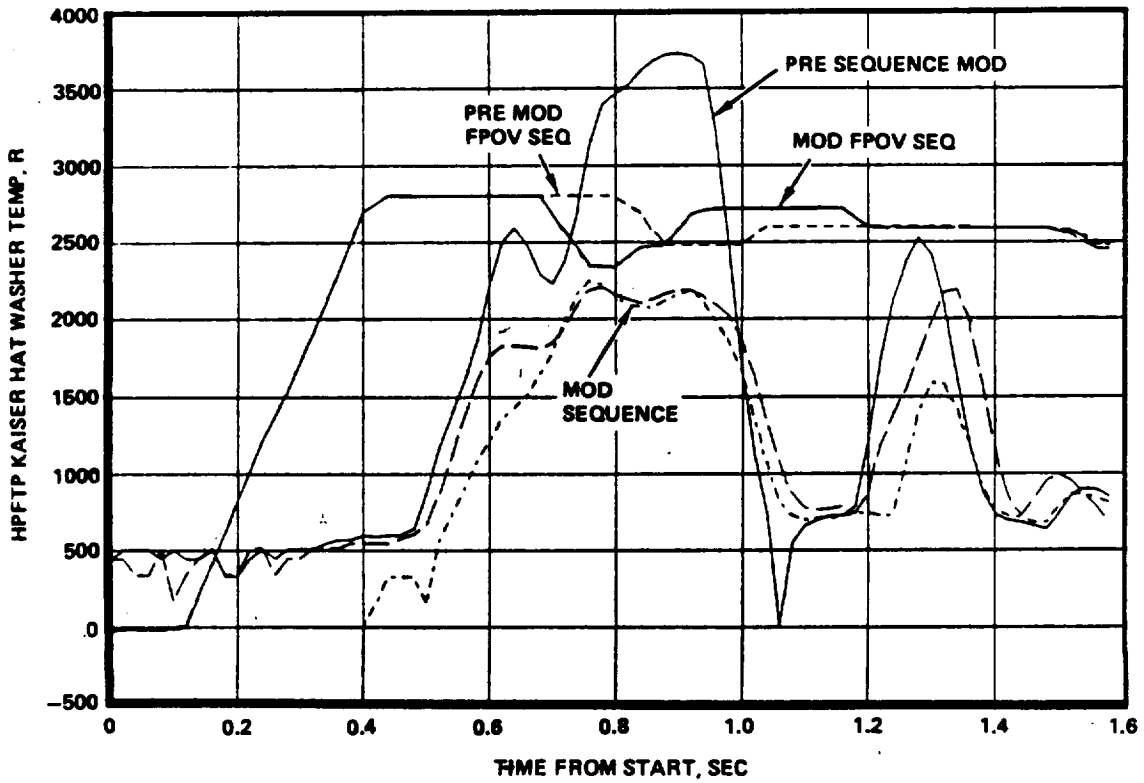

Figure 22. Ignition Temperature Spike Sequence Modification.

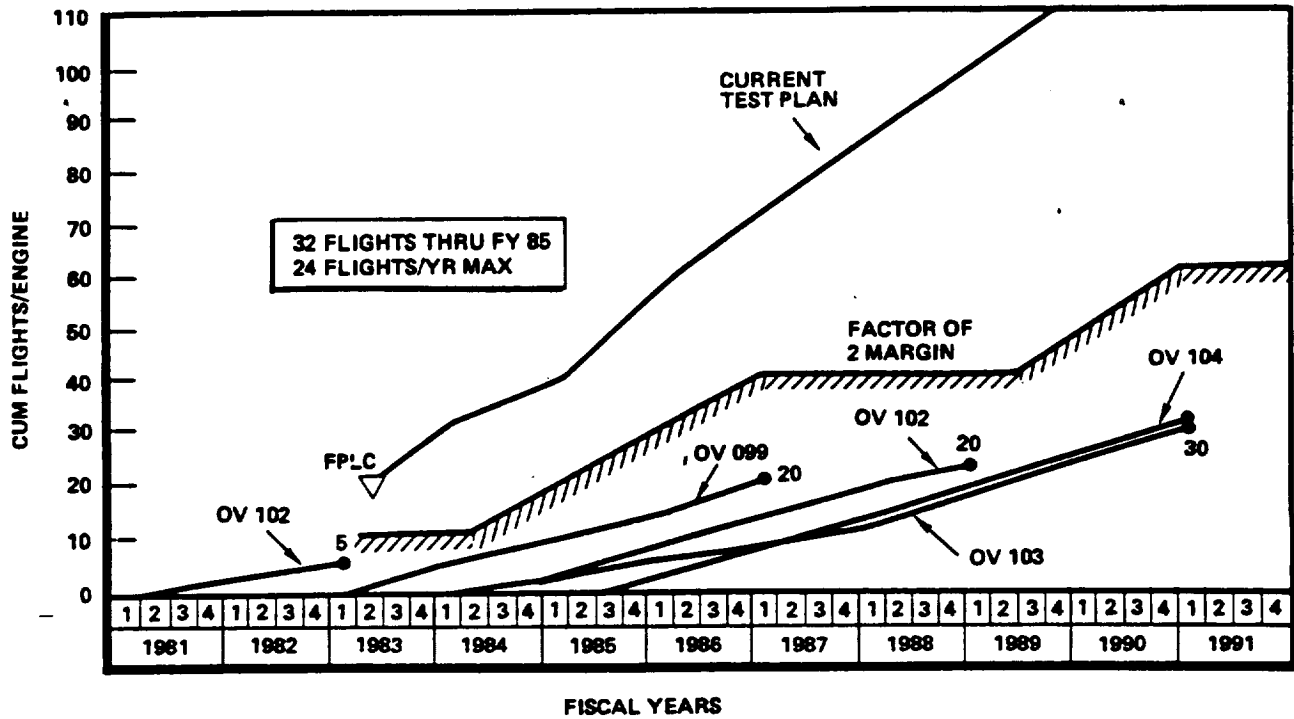

Figure 23. Flight Certification Extension Testing Plan Exceeds Factor of 2 Margin Requirements.

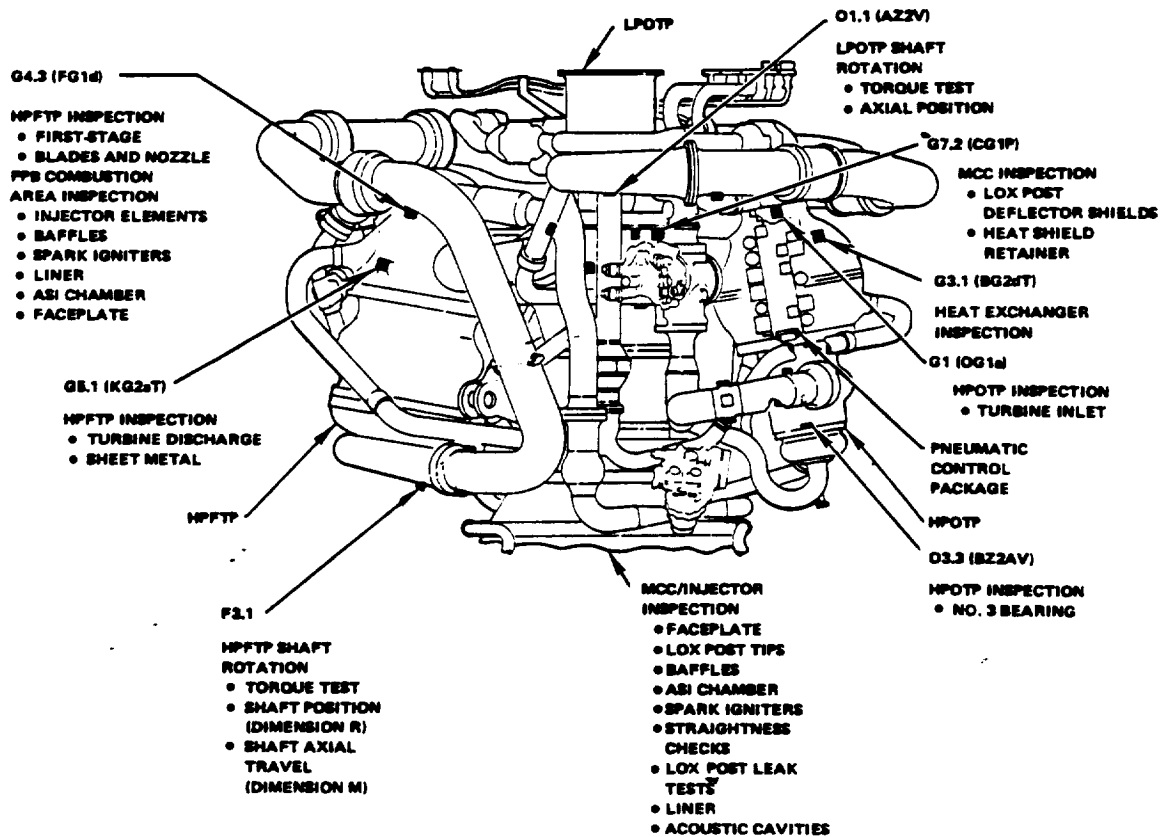

Figure 24. Internal Inspection and Shaft Rotation Access LPOTP Side of Engine.

ORIGINAL PAGE IS
OF POOR QUALITY

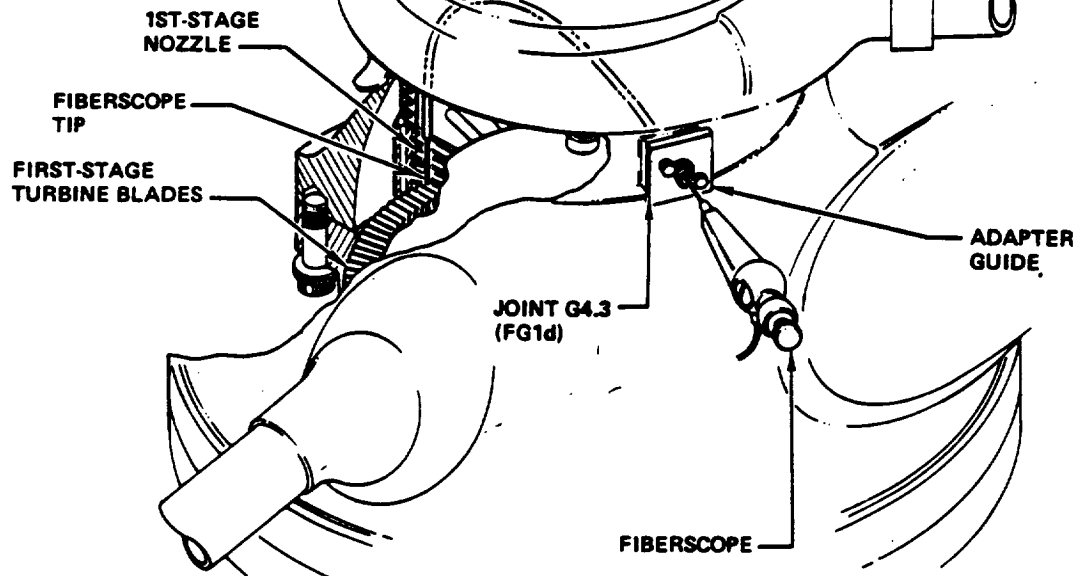

Figure 25. HPFTP First Stage Turbine Blades and Nozzle.

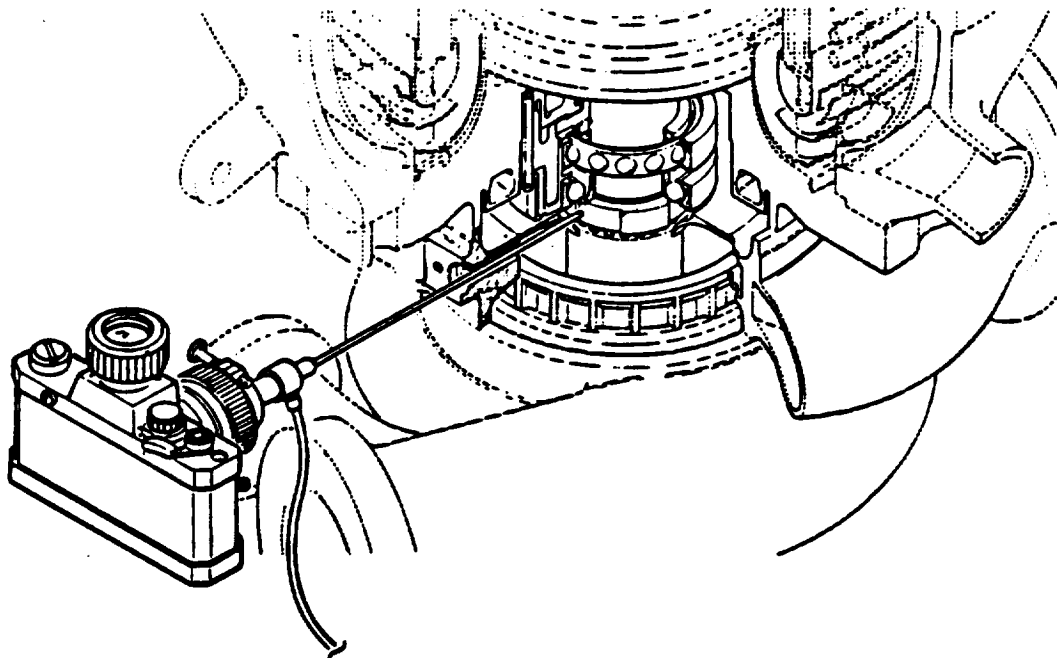

Figure 26. HPOTP No. 3 Bearing Photographic Condition Recording.