

SHUNT DIODE DESIGNS IN Li/CF SHUTTLE BATTERIES

David Miller and Robert Higgins
Eagle-Picher Industries, Inc.

ABSTRACT

Although Li/CF cells and batteries have an excellent safety record, they have been included with other battery systems that require additional safety precautions. One precaution that has been suggested is the inclusion of shunt diodes into these batteries. This paper explores the benefits of this addition.

INTRODUCTION

The LCFS-20 is a popular double-"D" size lithium carbon-monofluoride cell currently used in several different batteries. One such battery is the MAP-9036-5, the Range Safety Battery used in the Space Shuttle Program. In an attempt to further increase the safety of the battery, a contract was proposed that included the incorporation of a shunt diode board into the battery. The resulting battery is designated MAP-9036-7. The vital statistics on the MAP-9036-7 are as follows:

Height:	5.3 inches	Nominal OCV:	38.0 volts
Width:	6.6 inches	Nominal Working Voltage:	29.0 volts
Length:	8.0 inches	Nominal Capacity:	20.0 a.h.
Weight:	9.0 pounds	Nominal Discharge Rate:	0.5 amperes
Cells:	13 LCFS-20	Operating Temperature Range:	+20 ^o F to +140 ^o F

The diode designated to be used was the IN5550 silicon rectifier diode. The vital statistics for the diode are as follows:

Working Peak Reverse Voltage Rating:	200 volts
Maximum Average Forward Current:	3 amperes
Surge Current Rating at +55 ^o C:	150 peak amps maximum
D.C. Reverse Current at 100 ^o C I _r 200V:	0.025 mA dc maximum
Forward Voltage Drop at +55 ^o C at 3 amperes dc:	1.0 volts maximum

The diodes were included in the battery to act as a shunt in the event that any cell became overdischarged and began to reverse. The diode(s) would not allow the cell (or cells) to go into deep reversal and thereby would prevent any damage that this deep reversal might cause to the cell and the total battery voltage. A battery schematic is shown in Figure 1.

The battery was to be discharged at a constant rate of 0.50 amperes. This discharge was to be delivered anywhere within a temperature range of -25°F to $+155^{\circ}\text{F}$.

The customer was especially concerned about cells that had been discharged, allowed to stand for a period of approximately three months, and then driven into reversal. This situation had caused problems in different battery systems and there was concern about how the Li/CF cells would react. As a result, cells approximating this condition were tested as were freshly discharged cells.

TESTING

The LCFS-20 cells were tested to the following outline:

1. Hot Test ($165 + \text{ or } - 5^{\circ}\text{F}$)
 - A. Previously discharged cells
 1. Reversed with shunt diode
 2. Reversed without shunt diode
 - B. Recently discharged cells
 1. Reversed with shunt diode
 2. Reversed without shunt diode
2. Room Temperature Test (outdoor ambient)
 - A. Previously discharged cells
 1. Reversed with shunt diode
 2. Reversed without shunt diode
 - B. Recently discharged cells
 1. Reversed with shunt diode
 2. Reversed without shunt diode
3. Cold Test ($-25 + \text{ or } - 5^{\circ}\text{F}$)
 - A. Previously discharged cells
 1. Reversed with shunt diode
 2. Reversed without shunt diode
 - B. Recently discharged cells
 1. Reversed with shunt diode
 2. Reversed without shunt diode

Cells used in these tests were standard production cells that were used as lot acceptance cells. They were discharged at a constant current of 0.50 amperes to an end voltage of 200 volts. To successfully complete lot acceptance, the cells must deliver a minimum of 19.8 ampere-hours of capacity. The history of the cells used is as follows:

<u>Serial Number</u>	<u>Delivered Capacity (amp-hours)</u>	<u>Days from Capacity Test to Diode Test</u>
1322	24.68	56
1327	24.35	57
1335	24.41	64
1354	23.96	65
1366	24.23	51
1377	24.65	50
1386	24.35	44
1395	24.26	42
1419	23.91	31
1460	24.34	10
1463	23.86	9
1471	23.74	4
1485	25.53	13
1500	24.92	14

The cells were allowed to equilibrate in their test environments for between 20 and 48 hours prior to discharge and reversal. Elapsed time, currents, voltage, and cell skin temperatures were monitored using standard calibrated timers, ammeters, DVM's and trendicators. The current was kept constant through the use of a power supply and a five-ohm resistor. A typical discharge/reversal set-up is shown in Figure 2.

Figures 3 through 8 show the results of the test discharges/reversals. Figure 3 shows the results of the previously discharged cells discharged at approximately 165^oF. Cell Serial Number 1322 was discharged without a shunt diode. It reached a minimum voltage of -0.92 volts at approximately 2.5 hours. Shortly after this, the cell vented and the voltage began to rise. The test was discontinued at 2.75 hours. Cell Serial Number 1327 was discharged with a shunt diode and reached a minimum voltage of -0.12 volts at four hours. At this time, it also vented and the voltage began to rise. This test was terminated at 4.1 hours. The LCFS cells are vented by the placement of a downward-oriented sticker overlaying a thin diaphragm. As the pressure builds inside a cell, the diaphragm expands outward until it meets the sticker

and is pierced. The above-mentioned cell vents were this type of very passive vent. The only indication that a vent had occurred was the distinct aroma of the cells' electrolyte. There was no evidence of anything other than vapor leaving the cell.

Figure 4 shows the test results of more recently discharged cells run at 165°F. Cell Serial Number 1485 was discharged without a diode for approximately 24 hours. At one hour, the cell had vented at a voltage of -0.40 volts. The reversal was continued and at the 2.5 hour mark (-0.83 volt), the diode began to carry current. The voltage stabilized at -1.52 volts with the diode carrying 0.483 amperes.

Figure 5 shows the test results for previously and freshly discharged cells reversed at outdoor ambient temperatures (57 + or - 10°F) without diodes. Both previously discharged cells (Serial Numbers 1354 and 1386) reversed quickly, and by thirty minutes into the reversal, had reached their minimum voltages of -4.68 and -1.46 volts, respectively. However, by the two-hour mark, both cell voltages had stabilized at -0.20 volts and remained there for the remainder of the test. The freshly discharged cells (Serial Numbers 1463 and 1471) both reversed only to approximately -0.10 volts by the five-hour mark and remained there for the remainder of the test.

Figure 6 shows the test results of both previously (Serial Number 1335) and recently (Serial Number 1395) discharged cells discharged at outdoor ambient temperatures with diodes. Within the first hour of reversal, both cells had reached their minimum voltages of -1.04 and -0.81, respectively. By the third hour, both cells' voltages had risen and stabilized around -0.15 volts, where they stayed for the remainder of the discharge. In both tests, the diodes began to function when the cell voltage reached -0.60 volts. The diodes gradually began to carry more and more of the current until they carried approximately 0.250 amperes at both cells' minimum voltages. As the voltages began to rise, the currents through the diodes began to gradually fall until they were no longer functioning, with neither functioning by the two-hour mark.

Figure 7 shows the test results of the cold (-25 + or -5°F) discharge of both the previously (Serial Number 1377) and recently (Serial Number 1500) discharged cells, each without diodes. Each cell reversed quickly with Serial Number 1377 reaching a minimum voltage of -29.4 volts at the ten-minute mark, and Serial Number 1500 reaching its minimum of -9.4 volts at 16 minutes. Each cell began to recover soon after, with Serial Number 1500 reaching -0.30 volts by the five-hour mark and -0.10 by the test conclusion. Serial Number 1377, the previously discharged cell took longer to recover, being -2.5 volts by the five-hour mark and -0.6 volts by test conclusion.

Figure 8 shows the test results of the previously discharged cell (Serial Number 1366) and the recently discharged cell (Serial Number 1460) both with diodes. Cell Serial Number 1366 reversed immediately upon discharge to approximately -1.10 volts where it remained until near the end of the discharge when it rose to -0.40 volts by the 24-hour mark. Its diode began to function immediately, carrying 0.425 amperes at the one-minute mark and slowly

rising to 0.480 amperes by one hour. At the end of the discharge, when the cell voltage was -0.40 volts, the diode was not functioning. Cell Serial Number 1460 also reversed early in the discharge, having a voltage of -0.68 volts at the 19-minute mark where the diode began to function. By the two-hour mark, the voltage had reached its minimum of -1.28 volts and the diode was carrying its maximum load of 0.400 amperes. However, by the five-hour mark, the cell voltage had risen to -0.20 volts and the diode was no longer functioning.

EVALUATION AND RECOMMENDATIONS

All cells tested at the elevated temperatures vented regardless of length of time between being fully discharged and reversed or inclusion of the diode in the system. Cells discharged at ambient temperatures all show a relatively quick reversal, but by the two-hour mark, had stabilized at voltages that were high enough that the diodes were not functioning. Cells tested at depressed temperatures reversed the deepest of all cells tested, with the deepest reversal occurring very early in the test and voltages recovering to above -0.60 volts near the end of the tests.

These tests were conducted at only one rate of discharge. A higher rate of discharge may cause the diode to be used for longer periods of time instead of just the short transient periods observed. Conversely, at a lower rate of discharge, the diodes may not function at any time.

Historically, Li/CF cells have had no severe effects to reversal. Instead of any type of explosion or violent reaction, the passive vent is the worst observed response. This venting is generally attributed to the solvent reduction that occurs in this cathode-limited cell; however, preliminary testing has shown that anode-limited cells will eliminate the venting during hot reversal.

These observations are based on the testing of a small number of cells, and further cell testing as well as testing on the battery level is planned. Based on current information, the diodes would function as planned in a limited set of circumstances with limited benefit to the program.

We would like to acknowledge the support of the Marshall Space Flight Center in the conducting of this work.

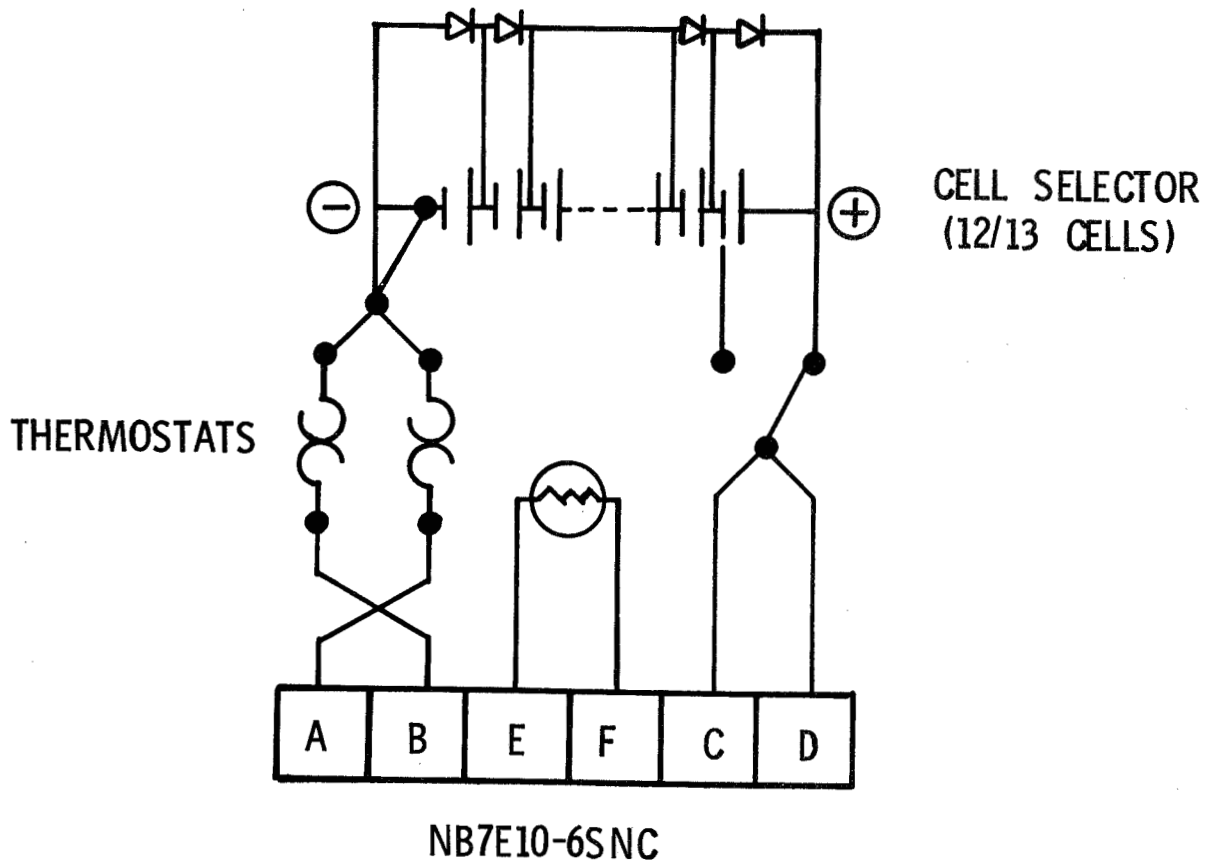

Figure 1

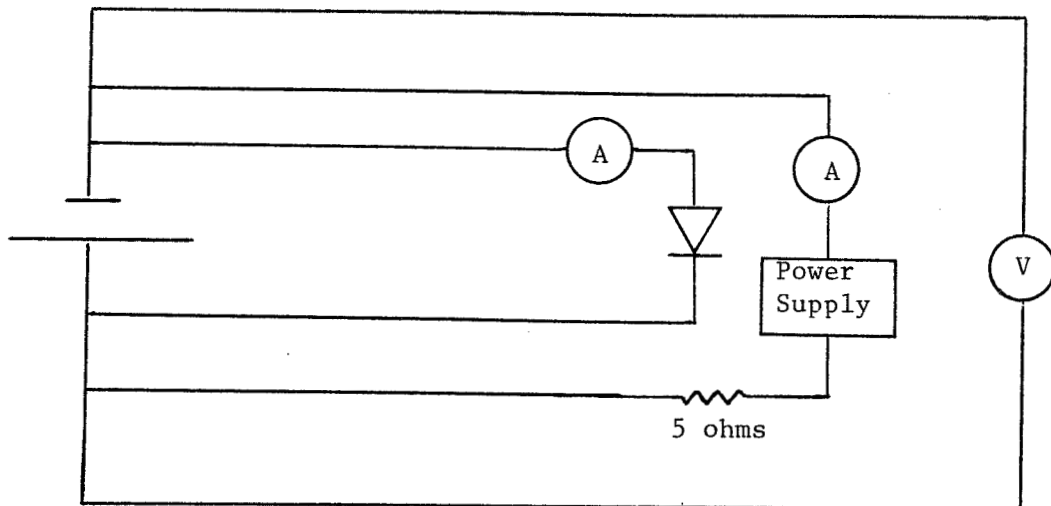

Figure 2. Typical test set-up.

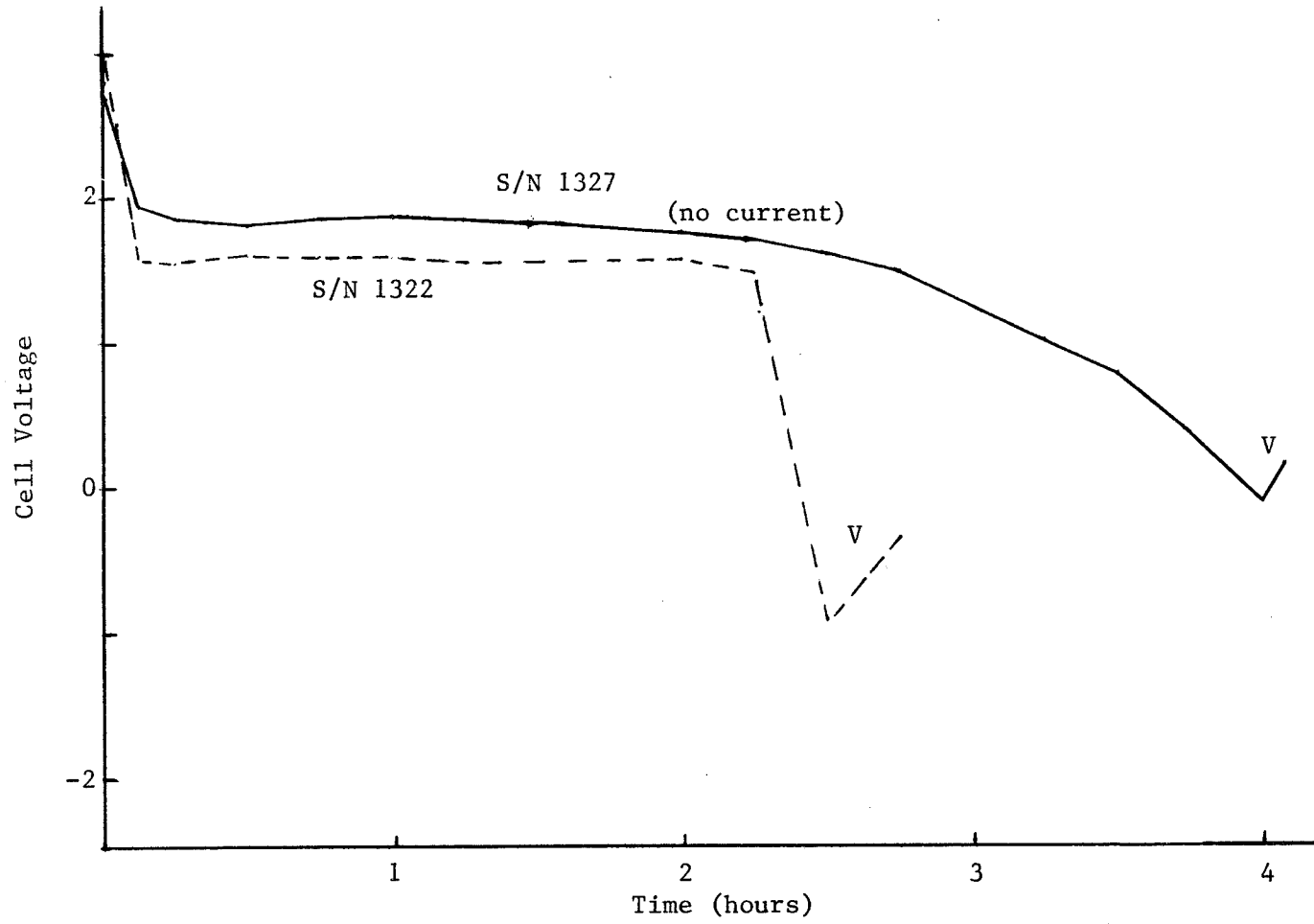

Figure 3. Hot test previous cells.

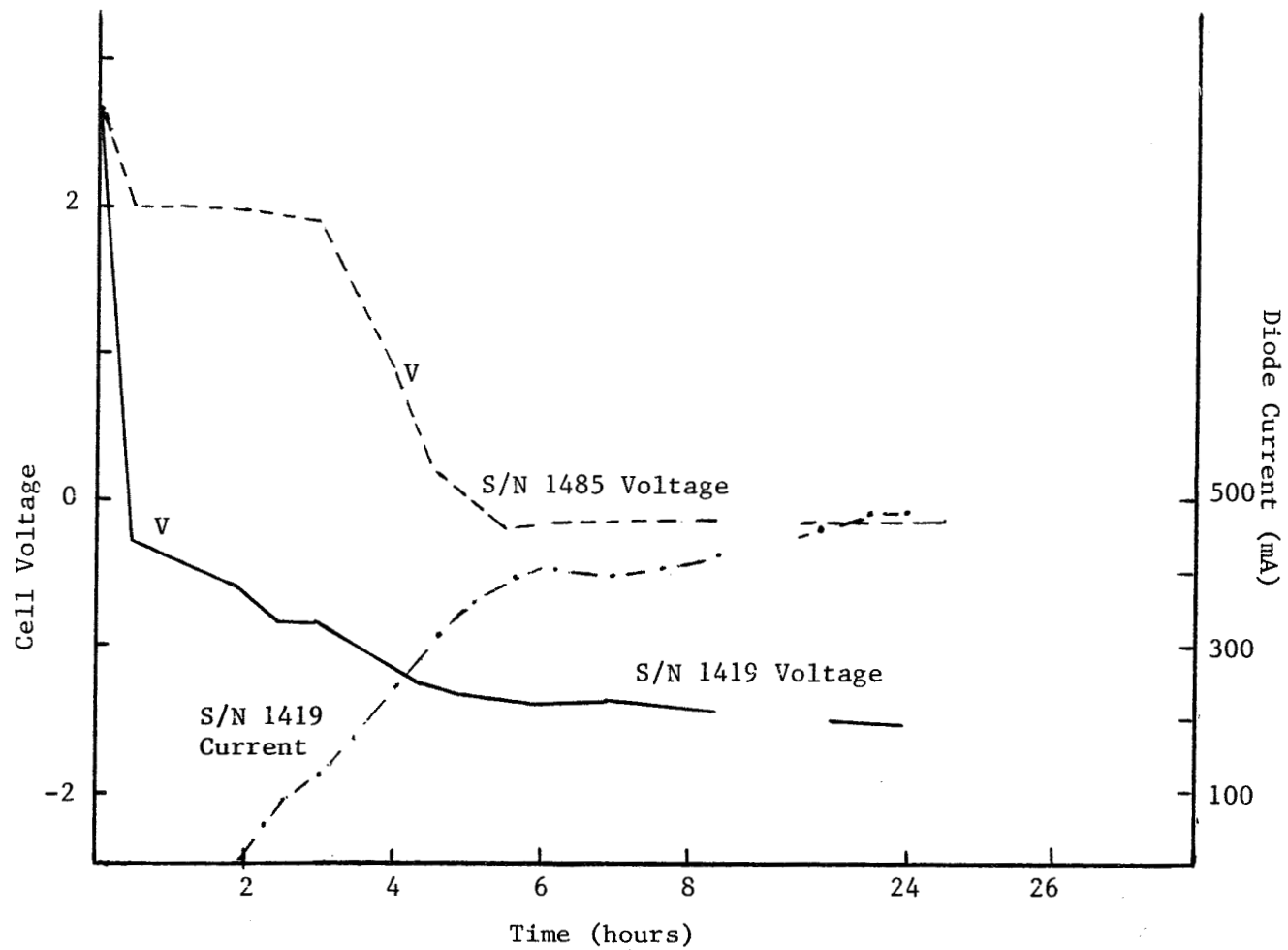

Figure 4. Hot test recent cells.

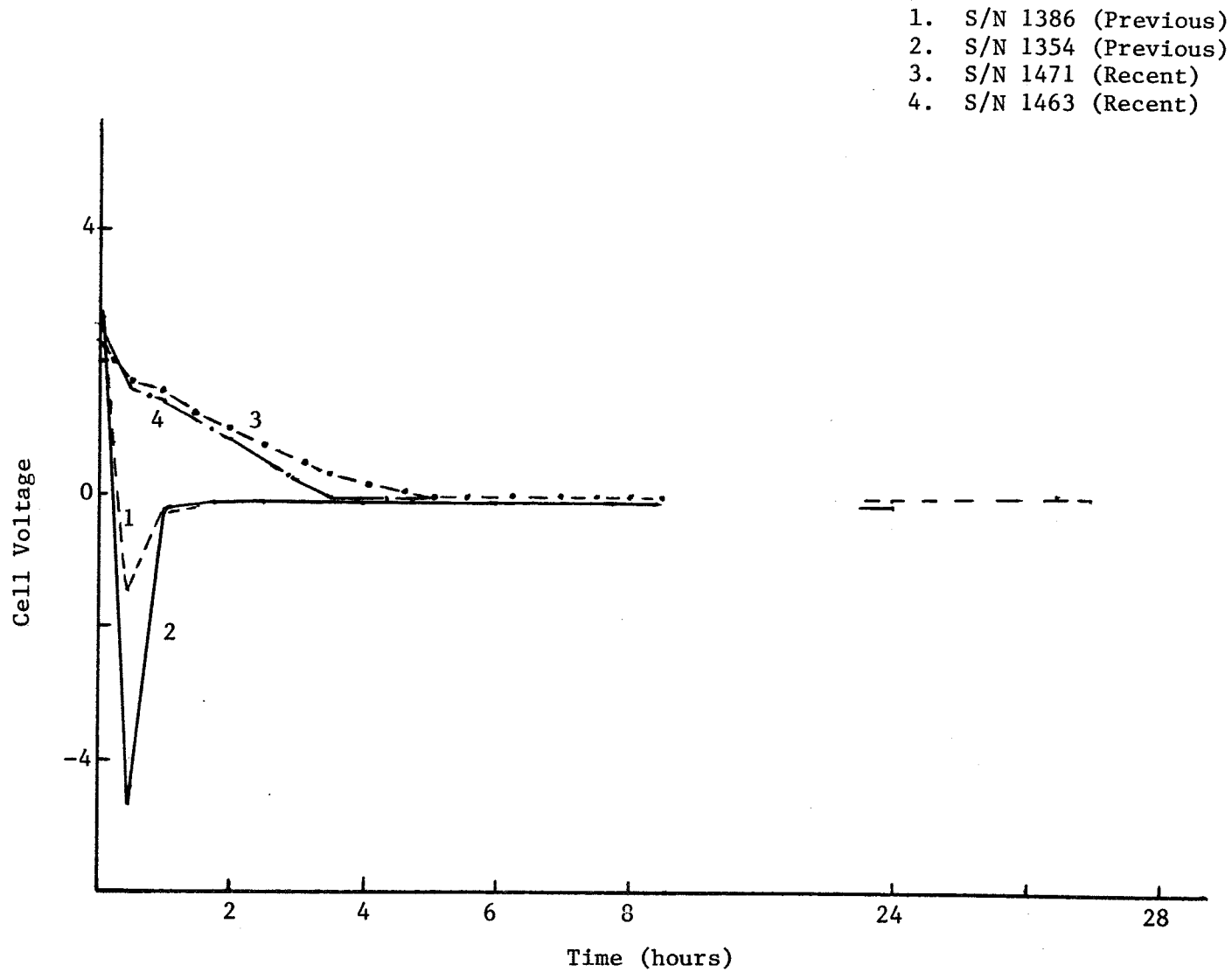

Figure 5. Ambient discharge without diodes.

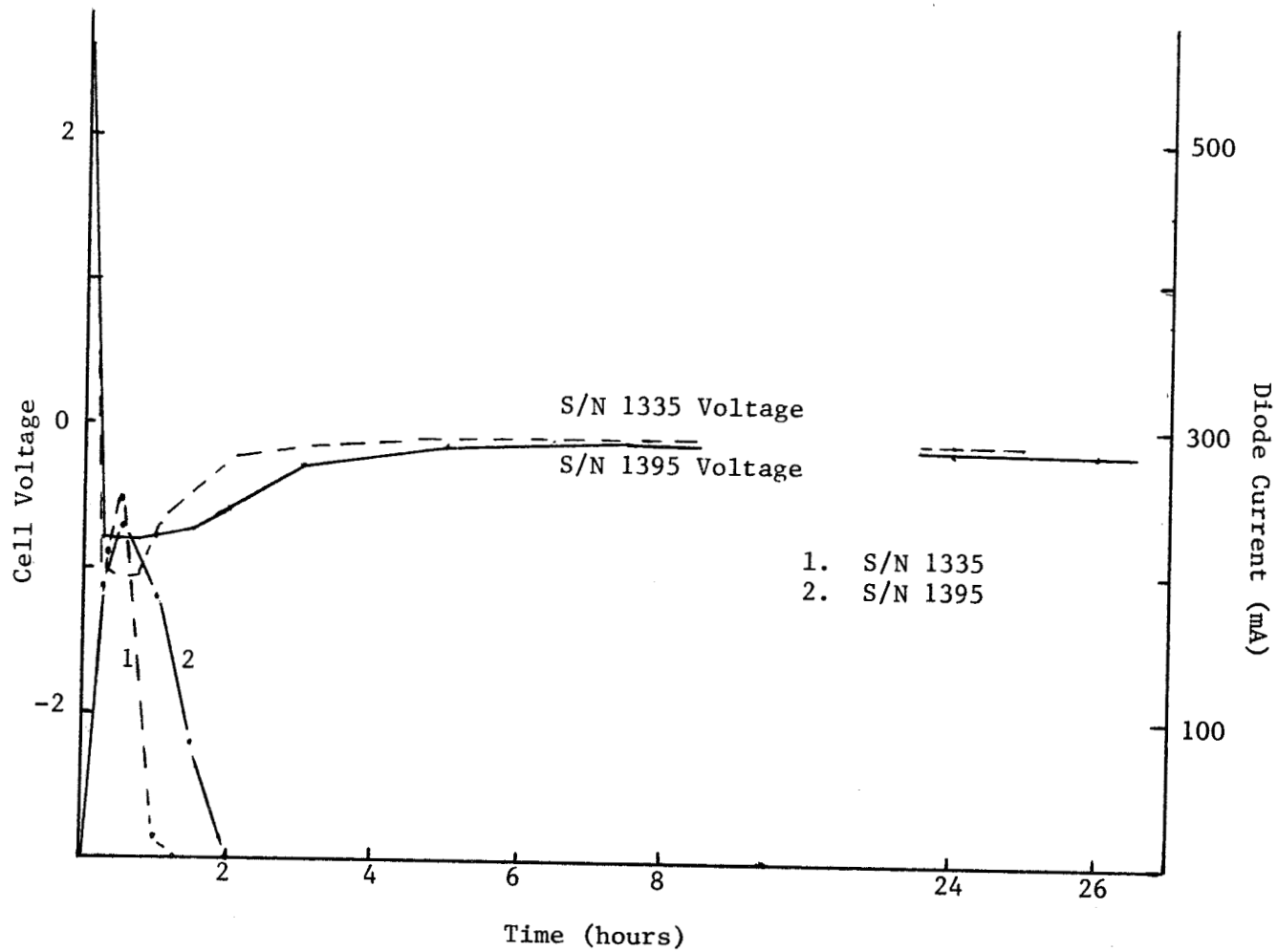

Figure 6. Ambient test with diodes (both previous).

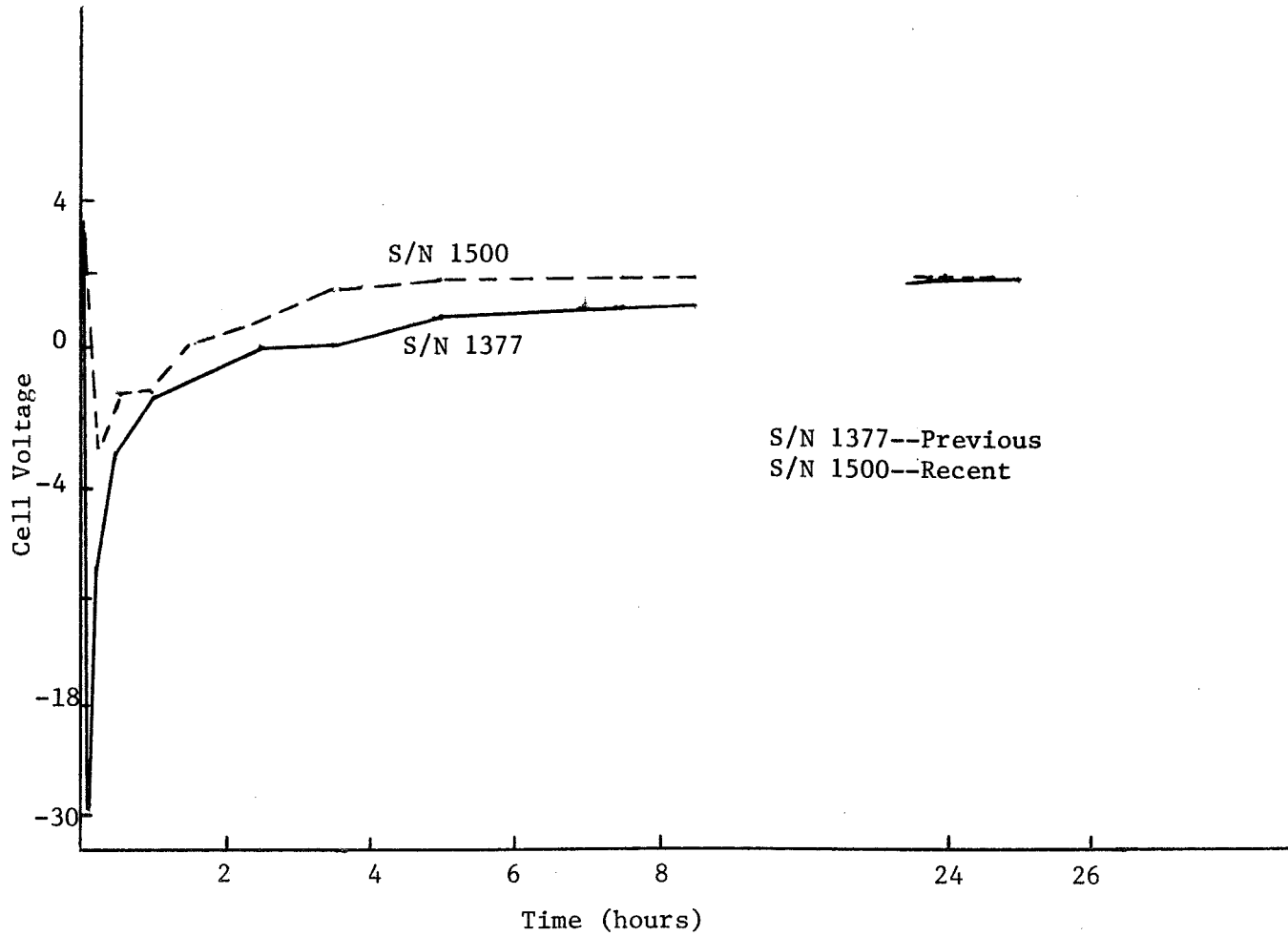

Figure 7. Cold test without diodes.

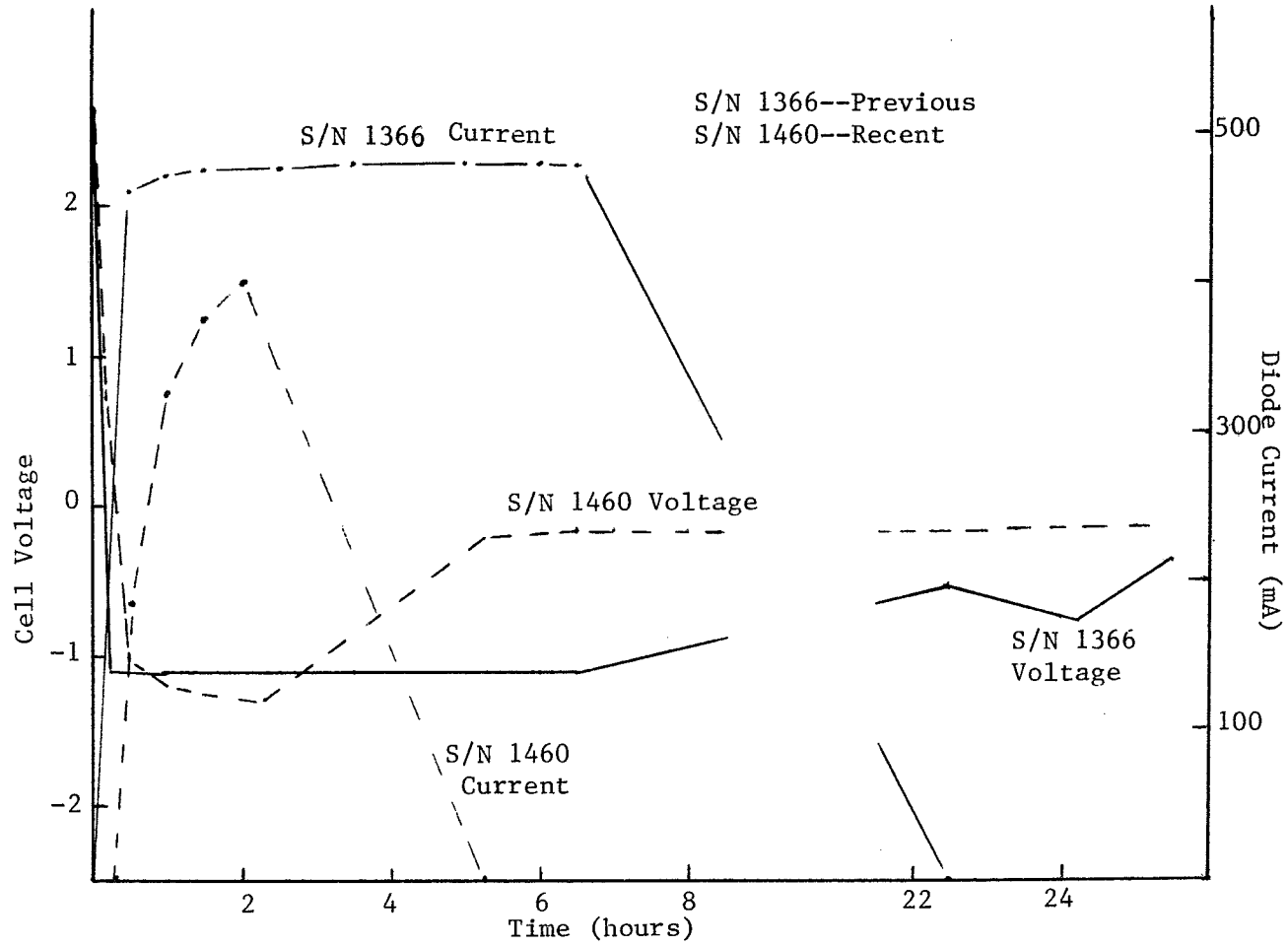

Figure 8. Cold test with diodes.