

L N 8 4 2 5 0 8 5

ORIGINAL PAGE IS  
OF POOR QUALITY

THE IMPORTANCE OF THERMAL-VACUUM TESTING IN ACHIEVING  
HIGH RELIABILITY OF SPACECRAFT MECHANISMS

K PARKER\*

ABSTRACT

This paper describes the work performed at the European Space Tribology Laboratory (ESTL) on thermal vacuum testing of complex mechanisms for the European Space Agency and several European customers. The objective of these tests is to assess the mechanism reliability by monitoring performance in an environment that closely resembles the environment that will occur during flight. To be both valid and cost effective, these tests must be performed in a detailed, formally controlled manner.

A review of the major test observations at ESTL over 10 years is given, during which time some totally unexpected failure modes have been detected. Full confidence now exists in many mechanism and component designs, and much valuable data have been obtained that are available to mechanism designers for improving reliability.

INTRODUCTION

The European Space Tribology Laboratory (ESTL) is operated by the National Centre of Tribology on behalf of the European Space Agency (ESA). This laboratory is dedicated to the study of all aspects of tribology, lubrication, and wear processes that are applicable to spacecraft technology.

An essential part of the work in ESTL is to carry out carefully controlled thermal vacuum tests on complete mechanisms or individual components, whereby the conditions anticipated to occur in flight are accurately simulated, particularly with regard to the presence of thermal gradients across a mechanism.

A recently available analysis† of 316 spacecraft from 46 United States programmes revealed 1600 separate anomalies of varying degrees of importance as regards their impact on the overall reliability. A significant proportion were attributable to electromechanical devices which had been assumed to be reliable under all possible operating conditions. Could some of these anomalies have been avoided by the application of more testing?

\*European Space Tribology Laboratory, Risley, Warrington, United Kingdom

†Briscoe, H.M., (1983), European Space Agency, private communication

**ORIGINAL PAGE IS  
OF POOR QUALITY**

The purpose of this paper is to emphasize the importance of selective thermal-vacuum testing for achieving high reliability and to review the work conducted at ESTL for the past 10 years. During this time period, over 70 thermal vacuum tests were performed for ESA and several European mechanisms manufacturers.

TESTING PHILOSOPHY

In the interest of a cost-effective demonstration of spacecraft mechanism reliability, ESA placed great emphasis on thermal-vacuum testing of complete assemblies, particularly those assemblies required to operate to within close tolerances throughout the lifetime of the satellite. This type of testing is often the most demanding of these tests done on a mechanism, combining the hostile vacuum environment with the subtle stresses produced by adverse temperatures and temperature gradients.

It is not always possible, even with elaborate thermal control systems, for a satellite mechanism to operate in a predictable isothermal environment. For example, a solar array drive mechanism will have its shaft exposed to a different environment than the housing, bearing and slipping unit. With geostationary satellites the system will be exposed to an eclipse cycle during which the shaft temperature is rapidly reduced and then restored to its normal level.

Despite comprehensive thermal analysis it is usually difficult to obtain accurate predictions of the temperature distribution in a mechanism. Also, when several components may be operating to different control sequences, resulting in variable power dissipation from motors, sliprings, and cables, thermal gradients can occur over small areas of a device.

Although the performance of individual components may have been separately assessed before assembly into a complex mechanism, unfortunately it is still the case that unpredictable behaviour and possibly failure of a component can occur in systems subjected to extreme temperatures and temperature gradients. Complete confidence in a particular design is only achieved when every possible failure mode has been identified and either designed out of the system or accepted with adequate demonstration of reliability.

The ESA insists that rigorous thermal-vacuum testing be applied to all critical mechanisms, with emphasis on the application of thermal gradients. The several categories of test are:

- To provide data for assisting in the design of new components or systems (Development Test)
- To verify that a mechanism, when built to a prescribed standard, will fulfill the operational requirements with an adequate safety margin (Qualification Test and Life Test)

**ORIGINAL PAGE IS  
OF POOR QUALITY.**

- To confirm that a particular flight unit will conform to the specific mission requirements (Acceptance Test and Refurbishment Test).

During testing of, for example, a solar array drive mechanism usually it is necessary to define two boundary interface temperatures to characterise the thermal environment and to act as control temperatures for the test. These are typically:

- T<sub>1</sub> - shaft/array interface temperature
- T<sub>2</sub> - housing/satellite interface temperature

Figure 1 shows<sup>1</sup> a typical envelope of qualification temperatures and the way in which the test temperatures are derived from the anticipated operational temperatures, which are determined from thermal transfer calculations and data obtained from actual flight experience. Four specific thermal vacuum test conditions are apparent: hot soak, cold soak, positive differential, and negative differential, allowing for a 15°C safety margin.

It has proved to be vital that the tests be formally controlled in accordance with a carefully constructed Test Procedure which is agreed with all interested parties before the start of the test. Formal Product Assurance supervision, applied at a mutually acceptable level, is an essential guarantee of test control. Of fundamental importance is the regulation of the amount of testing to achieve optimum efficiency and cost effectiveness and to avoid unnecessary procedures that could result in wasteful over testing. There must be no possibility of the test system introducing possible failure modes.

#### TEST EQUIPMENT

Figure 2 shows part of the ESTL. Certified clean-room conditions have proved to be essential in the success of thermal-vacuum testing, particularly with regard to the handling and inspection of mechanisms. Different areas conforming to Federal Standard 209B Class 100, Class 1000, and Class 10,000 cleanliness conditions are maintained.

Several different types of ultrahigh vacuum chambers are shown in Figure 3 and a simplified diagram of the internal components of a 1-meter diameter facility is shown in Figure 4. To conform to the ESA testing philosophy, emphasis is always placed on maintaining very clean test systems and for this reason the only types of pumps used on the vacuum chambers are high-reliability turbo-molecular, titanium sputter ion, and cryogenic pumps. environment is often determined by the amount of vapour outgassing from the mechanism under investigation. It is usually considered that a valid tribological test can be performed below  $10^{-7}$  mbar. Each system is fully instrumented with mass spectrometry facilities for residual gas analysis.

ORIGINAL PAGE 13  
OF POOR QUALITY

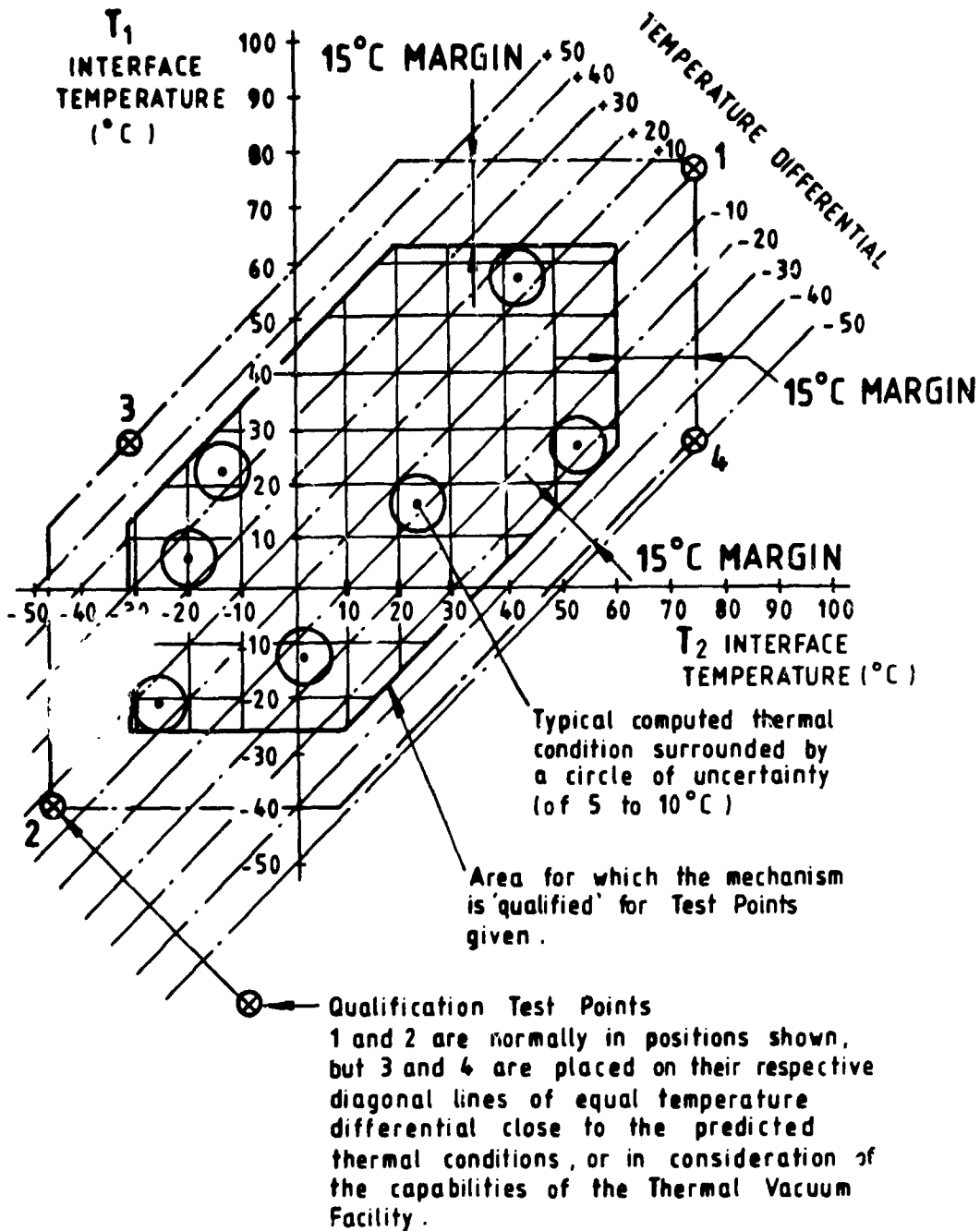

Figure 1. Example of System Used to Derive the Thermal-Gradient Test Temperatures

ORIGINAL PAGE IS  
OF POOR QUALITY

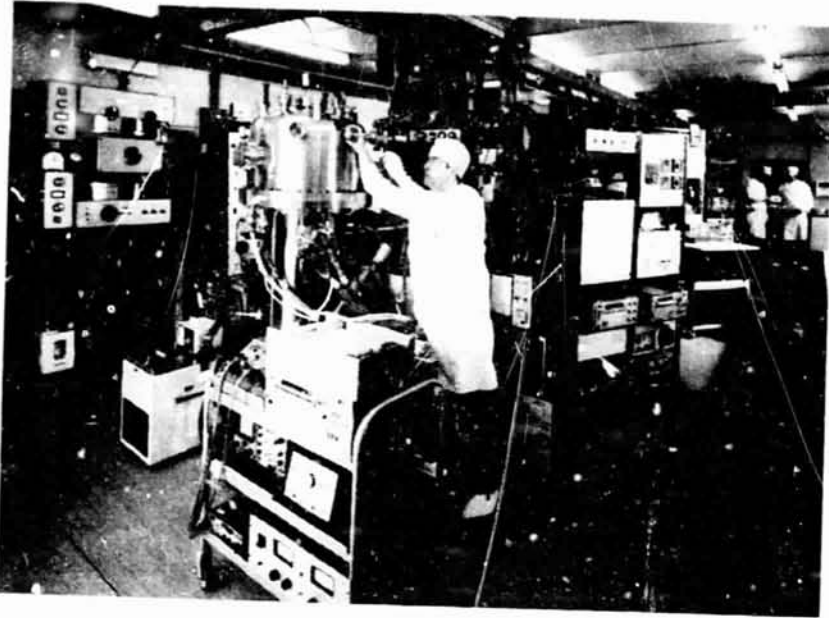

Figure 2. Part of the ESTL Clean Room Laboratory

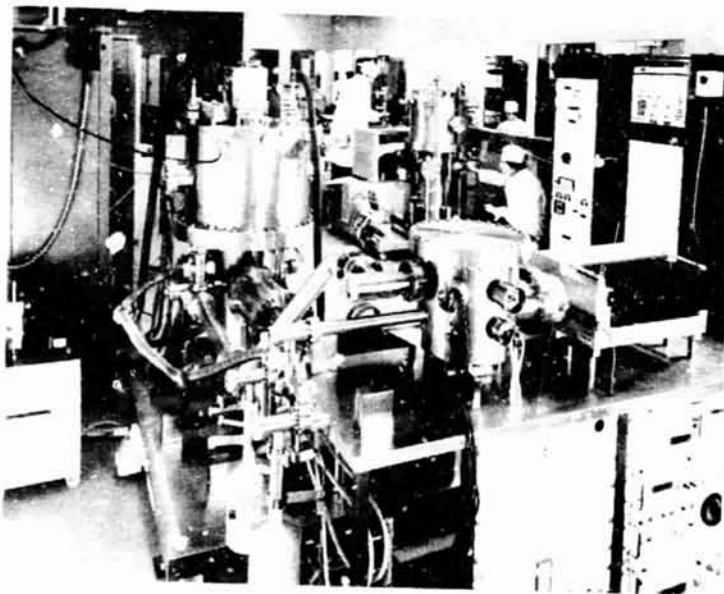

Figure 3. Some of the ESTL Thermal-Vacuum Test Facilities

ORIGINAL PAGE IS  
OF POOR QUALITY

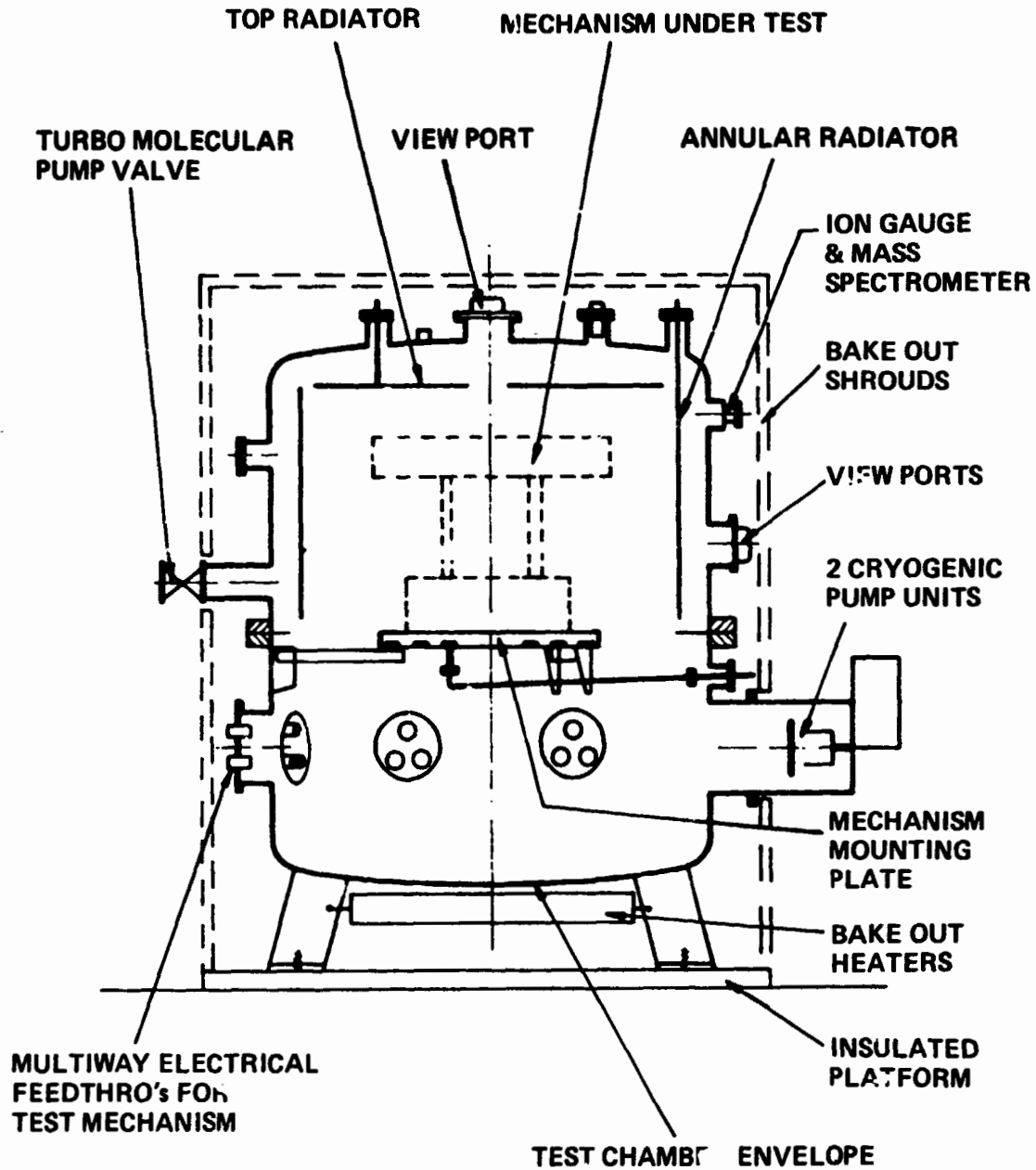

Figure 4. Main Features of a 1-Meter Diameter  
Test Chamber

**ORIGINAL PAGE 19  
OF POOR QUALITY**

This is very important as undesirable gas species such as oxygen and other active gases must be identified and, where possible, excluded. Usually, it is necessary to ensure that the partial pressure of oxygen, for example, is well below  $10^{-9}$  mbar.

A thermal interface enclosure is built around the mechanism in such a way that there are two independently controlled boundary interface temperatures. These two temperatures are determined by radiation to and from thermal shrouds whose temperatures are controlled in the range  $-90^{\circ}$  to  $+120^{\circ}\text{C}$  by high reliability fluid-circulation systems and electrical heating units. Space-approved materials of certified purity are used throughout the construction of the thermal-test environment.

Instrumentation systems are available to monitor to very fine limits such test parameters as thermal distribution, speed, torque, angular motion stability, and slipping electrical noise, as the thermal tests proceed. Data acquisition systems are of course necessary to deal with the information analysis. Selected parameters of the thermal control system, the pumping units, and the mechanism under test are linked to high-reliability, redundant protection systems so that any deviation from prescribed limits can be sensed and the appropriate corrective action can be automatically taken. This is vital to ensure that there is never any risk of the test itself causing the possibility of additional failure modes.

**REVIEW OF TEST OBSERVATIONS**

Seventy thermal-vacuum tests have been conducted over the past 10 years. In many of these, of course, the mechanisms operated within specified limits, which allowed confidence to be gained in the particular designs used. In some, valuable data were obtained, during dismantling operations, of the degree of wear and other changes that had occurred in the various components. In about 35 percent of the tests, however, some unacceptable deviation from the desired performance occurred, which enabled possible failure modes to be identified and provided valuable data feedback to manufacturers for making the necessary modifications.

Occasionally, total failure has occurred as a result of seizure of a shaft, bearing or lubrication failure, excessive friction, or excessive temperatures in a motor.

Solar Array Drive Mechanisms

The majority of this class of important mechanisms tested at ESTL have been intended for communications satellites in geostationary orbit where the mechanism is subjected to thermal gradients.

ORIGINAL PAGE IS  
OF POOR QUALITY

Typical test temperatures are:

	Shaft Interface	Housing Interface
Hot soak	+90°C	+55°C
Cold soak	-50°C	-25°C
Positive Differential	+50°C	0°C
Negative Differential	-35°C	+15°C

Additional tests may be necessary to simulate the extreme thermal conditions experienced in an eclipse, typically a drop of 60°C in the shaft temperature in 72 minutes followed by an increase of 60°C in 30 minutes. The mechanism must maintain solar alignment after the eclipse simulation.

Of fundamental importance is that the angular motion must be smooth, so as to avoid reaction torque disturbances to other systems. Often a brushed motor is used to give an impulse every 4 seconds or so. Ideally, each impulse should result in 0.0167° of rotation and an important part of the test is to measure any deviation from this value.

Many European solar array drive mechanisms use bearings of the highest available precision which have been lubricated by a thin film of lead deposited by an ESTL plasma ion-plating process.

The solar-generated power, typically 2 Kw, is transmitted by sliprings which are often fabricated from silver or copper with a gold plating. A common brush material is a composite of silver/copper/MoS<sub>2</sub> in volume ratio 82.5/2.5/15, respectively. Assessment of the electrical noise across the interface is necessary as this could result in unacceptable power loss and radiation interference.

Figure 5 shows a solar array drive being loaded into a vacuum chamber. In Figure 6, another type is shown being fitted with a thermal enclosure.

In 1975, ESTL commenced a 7-year real life test on such a mechanism, to fully quantify the time-dependent parameters and to obtain data that would enable us to assess the validity of accelerated life testing on systems using solid lubrication. Many thermal changes were made in this test, including 420 eclipse simulations. The test was very successful, only minor changes occurred in the measured parameters. Of significant interest was that the test chamber pressure took several years to stabilize at about  $1 \times 10^{-8}$  mbar because of continuous outgassing from the mechanism surfaces and cable looms. It is important to note that over a long period of time this outgassing can be a primary cause of failure due to degradation of materials. The rotational stability and motor power requirements were remarkably consistent, showing that the friction in the sliprings and brushes had remained



ORIGINAL PAGE 17  
OF POOR QUALITY

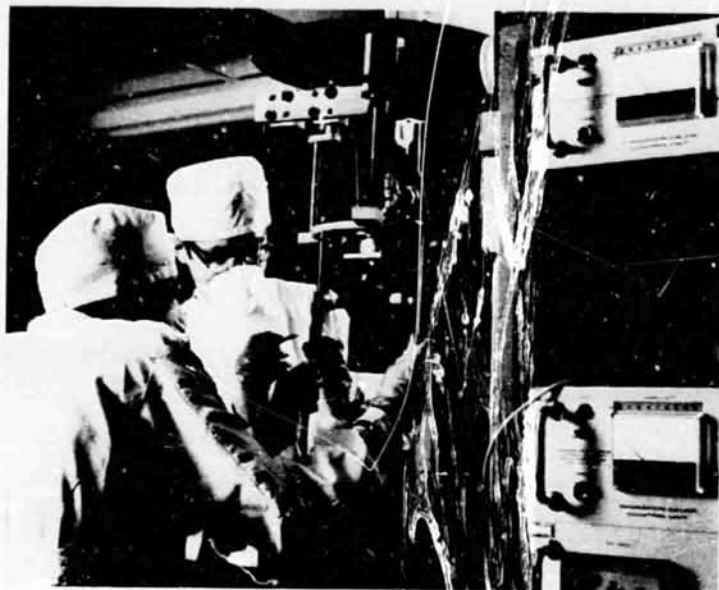

Figure 5. A Solar Array Drive Mechanism Being Loaded into a Test Chamber

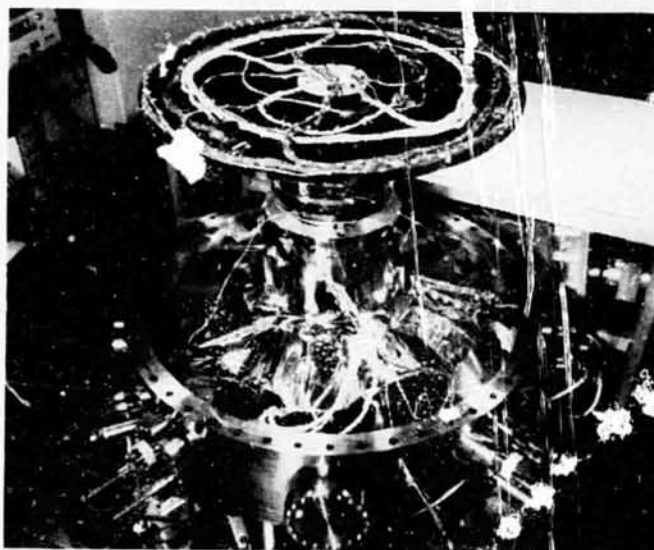

Figure 6. A Solar Array Drive Mechanism Being Fitted into a Thermal-Gradient Enclosure

**ORIGINAL PAGE IS  
OF POOR QUALITY**

substantially constant. The sliprings were tested with various current levels ranging from 100 mA to 7 Amp. Most gave variable amounts of electrical noise, within specification, but two circuits passing 500 mA produced intermittent noise pulses that were equivalent to a resistance change of 2 ohms. The characteristics of these transients were such that they could only have been caused by the presence of variable amounts of brush wear debris, and an inevitable conclusion is that some suspicion must fall on the use of MoS<sub>2</sub> as brush lubricant.

A second 7-year real life test on a different type of mechanism had to be abandoned after 4 years because of excessive deviation from the position control stability criterion. Subsequent examination revealed that time-dependent degradation of the efficiency of an optical encoder had occurred. This failure was completely unexpected.

Some other important observations during tests on various mechanisms were:

- Surprising variation in performance of nominally identical mechanisms, presumably due to minor changes of material specification and variations in fabrication tolerances.
- Seizure of shaft in a housing during a cold test at -50°C.
- In a cold test, a high torque was present over only about 1° of rotation due to unbalanced flexure of a diaphragm used to preload the bearings.
- An unusual thermal distribution was monitored within a mechanism, implying that a serious design fault was present. Subsequent investigation revealed that a thermistor bead had become detached from its cemented mounting.
- A very unusual fault on a thermistor, whereby it operated correctly below 30°C but was apparently open-circuit above 30.5°C.
- Excessive temperature (140°C) in a stepper motor in a hot test with the mechanism shaft controlled at +90°C. This was due to inadequate design of a heat sink.
- Complete failure of an actuator and lever system that was used to one two redundant motors in a gear drive device.
- Unexpected thermal distribution in a mechanism that invalidated previous theoretical analysis. This was due to the power dissipation from motors and slip rings being underestimated.
- Contamination of test environment by silicone compounds following rupturing of an overheated memory alloy element of a bearing off-load assembly. The heater current had been incorrectly specified.
- Unexpected variations in angular motion stability with temperature. This could only have been detected by thermal vacuum testing.
- Permanent set of a release cable of a bearing off-load device after a long period of storage under tension. When released, full retraction did not occur and the cable made contact with nearby components.
- Rubbing of insecure cable on rotating component.

**ORIGINAL PAGE IS  
OF POOR QUALITY**

- Excessive noise and power loss in slipping unit apparently due to changes in the slipping surface properties resulting from degradation of molybdenum disulphide lubricant.
- Microswitch failure at low temperature.
- Excessive outgassing from a mechanism that did not appear to have been manufactured to approved standards of cleanliness.

**Despin Mechanisms**

In 1975, ESTL commenced a unique real life test on a despin mechanism in which the bearings were lubricated by BP2110 grease with BP110 oil impregnated in the cages and in Nylasint reservoirs. At a speed of 60 rpm these were operating under conditions bordering on those of boundary lubrication. Assessment of the time-dependent properties of this system was necessary, one area of uncertainty being the effectiveness of oil-creep barriers and oil seals. If oil migration did occur it was essential to investigate the effect on the slippings. Rotation was by means of a two-phase brushless motor with the current being continuously adjusted to maintain a constant speed of 60  $\pm$  1 rpm. Modest thermal conditions were imposed on the device, with the shaft temperature at either -5° or +45°C.

Again, because of continuous outgassing, the test chamber pressure took several years to stabilize at about  $1 \times 10^{-8}$  mbar.

Although there was no significant overall deterioration in the performance of the slippings, there were large but temporary increases in interface resistance following a change of thermal conditions. This may have been a consequence of the presence of variable amounts of oil, or differential axial expansions causing the brushes to run on a slightly different track, several days of running-in being necessary before the resistance returned to normal.

There was a gradual increase in the motor current probably because of a continuous reduction in the field strength of the permanent magnets in the motor. This aging process is known to occur at about 7 percent per year for the magnetic materials available in 1973 when the mechanism was designed.

This unique and very successful mechanism has recently been dismantled and some very valuable information has been obtained from detailed component inspection. For example, the bearings were in very good condition with adequate reserves of clean oil. Although there was a significant amount of wear debris in the slipping unit this did not effect their operational efficiency.

It is important to note, however, that this device had originally failed quite dramatically when the shaft seized in a cold test due to neglect during manufacture of critical tolerances between stationary and rotating components. The failure was caused by a screw head projecting 1 mm too far above a housing flange.

**ORIGINAL PAGE IS  
OF POOR QUALITY**

Recently an accelerated life test was performed on a despun mechanism for the European Giotto (Halley Comet) mission. Validation of the system torque stability was essential for this very special satellite component which determines the antenna-pointing performance.

Motor Drive Systems

Many different types have been evaluated. Of particular interest are torque stability, power dissipation, bearing performance, brush stability, stability of potting compounds, generation of wear particle contamination, and magnetic circuit stability. Some major observations were:

- Unexpected torque characteristics in high-speed brushless motor at elevated temperatures - our test results did not agree with the manufacturer's predicted performance.
- Overheating due to inadequate thermal coupling between motor and a suitable heat sink. The rate of power dissipation and thermal transfer in vacuum had been underestimated.
- Failure of gold-surface coating on meshing teeth of a high resolution stepper motor, due to the substrate medium not being of sufficiently hard material.
- Inadequate radial stiffness in an experimental stepper motor.
- Degradation in performance of motor and gearbox unit due to inadequate grease lubrication and the effect of cumulative wear debris.
- Dry lubricant in gear systems can sometime result in compaction in the roots of teeth.
- High temperature in high-speed motor with oil-lubricated bearings. Too much oil resulted in high torque and power loss. To maintain constant speed, more current was demanded in the motor, leading to even higher power dissipation. It is always essential to use the correct amount of the recommended lubricant.

Slipring Assemblies

Slipring assemblies are present in several types of mechanism. See Figure 7 for a typical unit. Much valuable data have been obtained on reliability in terms of contact resistance variation, power loss, stability of materials, friction, wear, and distribution of wear particles. Some problems have been identified in units that have been widely used and assumed to be of high reliability under all conceivable operating conditions:

- Visible ring surface tarnishing does not necessarily indicate performance deterioration, but one such unit, stored for over 18 months after a successful test, was retested and found to have high contact resistances and increased operating temperature. In vacuum, the effect was temperature dependent but the anomaly disappeared completely on exposure to air again. This unit had brushes incorporating molybdenum disulphide as a lubricant. This phenomenon has been observed in other similar systems, and detailed observation reveals that high contact

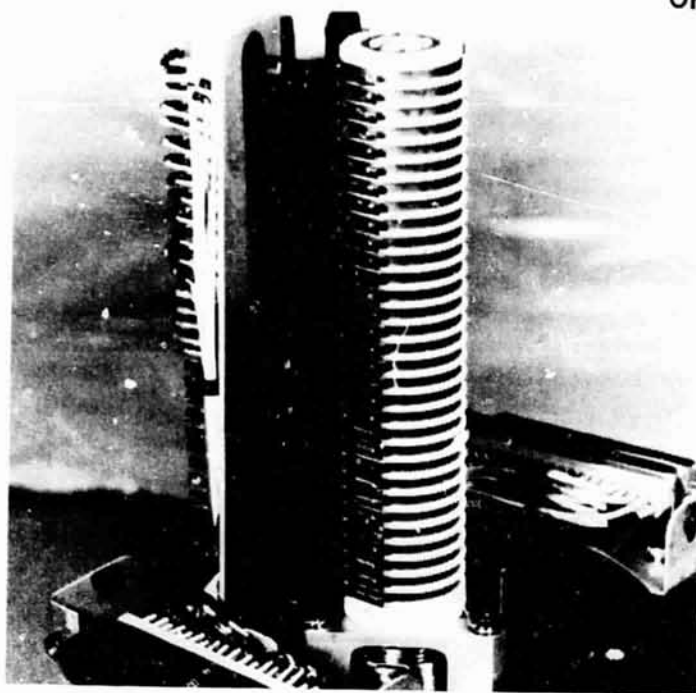

Figure 7. A Typical Slipring Assembly

resistances can be present over very small localized areas. Thus in very low-speed systems there is a very real danger of disturbance to slipring circuit currents.

- High contact resistance in a unit which, prior to delivery to ESTL, had inadvertently been operated for many unscheduled revolutions in air. Black deposits, originating from  $\text{MoS}_2$  brush lubricant, were removed from the sliprings before the test could be repeated satisfactorily.
- Thermal changes can provoke a significant, but temporary increase in contact resistance.
- Unexpected differences in performance among nominally identical units due to changes in brush spring pressure, surface condition, brush conformity and alignment, and distribution of wear debris.
- Often the effect of thermal dissipation distributed between the sliprings, brushes, cables and connectors has been underestimated, particularly in dense clusters of cables near anchorage points.

These test observations have resulted in ESTL embarking on a review of current slipring technology, particularly with regard to the reliability of molybdenum disulphide as brush lubricant. The presence of silver sulphide can have a significant effect on surface properties.<sup>3</sup>

### Antenna Pointing Mechanisms

One type of a two-axis controlled platform is shown in Figure 8. Tested over a wide temperature range, it was vital to assess the dimensional stability, the pointing accuracy, and the bearing torque of these complex mechanisms. Very stable pointing accuracies of better than  $+0.05^\circ$  were consistently measured but there was some temperature-dependent drift of the null-balance position. In one mechanism, the stability of a stepper motor was disturbed by an incompletely brazed flexure pivot, a device which some design engineers treat with caution as regards their long-term stability.

### Gimballed Momentum Wheels

A double-gimballed momentum wheel is shown in Figure 9. The complexity of these mechanisms demanded a test of the wheel motor, operating at 4000 rpm, the gimbal torquer motor, the angular position transducer, and the gimbal bearing which must have a very low, stable friction to avoid orthogonal precession torques affecting the overall stability. The large framework could be sensitive to dimensional change with temperature over the range  $+55^\circ$  to  $-40^\circ\text{C}$ . It is interesting to note that with this particular mechanism, oil-lubrication was preferable to lead lubrication in the gimbal bearings. This could only be found by doing a thermal-vacuum accelerated life test.

### Other Mechanisms

Several short but essential tests have been performed on various bearing assemblies, lubrication systems for air-lock cables, and scaled-down models of the Space Telescope roll-out array. Detailed assessment of many components of these items was necessary as the designs were new and very limited knowledge was available of possible failure modes.

Three faint-object-camera mechanisms (filter wheel, refocusing, and shutter mechanisms (Figure 10)) for the Space Telescope were subjected to simultaneous accelerated life tests, each performing in excess of 40,000 actuations. Many measurements have been made on a large number of critical items such as stepper motor, actuator motor, spring assembly, flexure pivots, lead-screw, lead-lubricated bearings, plastic gears, and electromagnetic position sensors. These mechanisms were typical examples of the dilemma often experienced by a mechanism designer, who must guarantee that the complete mechanisms will conform to the required specification but must use components that, although of the highest quality available, are not guaranteed by the various suppliers to fulfill the required specification.

### Miscellaneous Observations During Mechanism Inspection

An essential aspect of thermal-vacuum testing is that it demands an additional, independent inspection procedure before and after the test. Occasionally, it may be permissible to dismantle a mechanism for detailed post-test component evaluation.

ORIGINAL PAGE IS  
OF POOR QUALITY

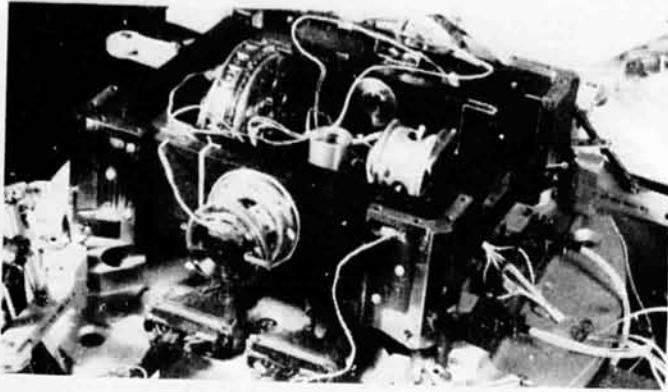

Figure 8. One Type of  
Antenna-Pointing Mechanism

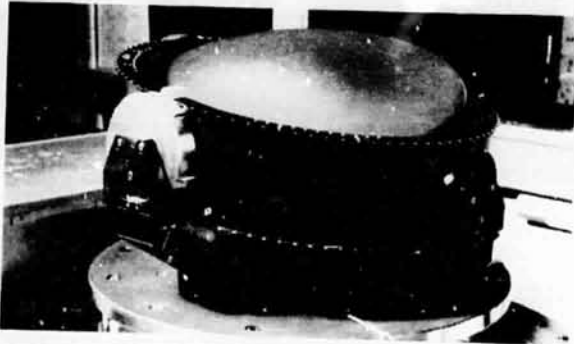

Figure 9. A Double-Gimballed  
Momentum Wheel Assembly



Figure 10. Three Mechanisms  
for the Faint-Object Camera  
of the Space Telescope

Much valuable data have been obtained on the reliability of many components and lubrication systems. Many minor, but certainly not trivial, problems have been encountered.

A secondary, but very important, advantage is that as a result of the work in ESTL it has been possible to advise manufacturers of improvements that must be made in component design, fabrication techniques, and handling procedures. It has been our experience that, however high are the standards which are achieved in organisations with elaborate inspection procedures, one limiting factor in achieving high reliability will always be the human factor, whereby occasional accidents, errors, poor judgement and lack of consistent attention to detail will inevitably occur, particularly when working within the constraints of tight budgets and time scales. Regrettably, there have been examples of defects which, although almost trivial in themselves, could, given the right set of circumstances, contribute to a failure mode. Some examples include: undesirable blemishes, scratches, poor surface finish, misalignment, and inadequate cleaning of critical components; poor soldering and cable insulation techniques, associated with contamination by splashes of solder, adhesives, and potting compounds; handling of bearings with bare hands can eventually cause small localized areas of corrosion; burrs, swarf, and damaged surface coatings on and near fasteners; particle contamination from many sources; and electrical cable rubbing on sharp edges of rotating components.

#### CONCLUSIONS

Thermal-vacuum testing has proved to be essential in providing a detailed assessment of the reliability of complex mechanisms by subjecting them to realistic simulations of the anticipated flight conditions, where lifetimes in excess of 10 years are now expected.

Of vital importance is that these tests have been proved to be cost-effective in avoiding delays and disturbances to a number of European projects, as several previously unknown failure modes have been detected. There is now complete confidence in many designs following independent, fully-documented performance assessment.

Much valuable data have been obtained on many mechanisms and components about their operational parameters, power dissipation, and wear processes. There is frequent evidence of how important it is to implement comprehensive inspection and product assurance systems at all stages of mechanism development and construction, to avoid the human factor of accidents, errors, and poor judgement.



#### ACKNOWLEDGEMENTS

The greatly appreciated help of Mr. Mervyn Briscoe, recently retired from ESA, in the preparation of this paper. This paper is published by permission of Dr. T. N. Marsham, Managing Director of the Northern Division, United Kingdom Atomic Energy Authority.

#### REFERENCES

1. Briscoe, H. M., A Rationale for the Testing of Space Mechanisms, Proceedings of First European Symposium on "Space Mechanisms and Tribology", ESA SP-196, 1983.
2. Roberts, E. W., Sliding Electrical Contacts in Space: Observations on Existing Technology and New Trends in Low-Speed Applications, Proceedings of First European Symposium on "Space Mechanisms and Tribology", ESA SP-196, 1983.