

N79-27079<sup>29</sup>

## ADVANCED COMPOSITES IN SAILPLANE STRUCTURES:

## APPLICATION AND MECHANICAL PROPERTIES

Dieter Muser

Research Center Stuttgart  
Deutsche Forschungs- und Versuchsanstalt  
für Luft- und Raumfahrt e.V.

## SUMMARY

Advanced Composites in Sailplanes mean the use of carbon and aramid fibers in an epoxy matrix. Weight savings are in the range of 8 to 18% in comparison with glass fiber structures. The laminates will be produced by hand-layup techniques and all material tests shown here have been done with these materials. These values may be used for calculation of strength and stiffness as well as for comparison of the materials to get a weight-optimum construction. Proposals for material-optimum construction are mentioned.

## TECHNICAL HISTORY

The first fiber-reinforced glider, a Phoenix developed by Prof. Eppler, made its maiden flight in 1957. Now, more than 4000 gliders with glass-fiber-reinforced structures are in the air all over the world. Increasing the wing loading permitted increases in maximum speed, but structural demands increased the weight also.

A large span enabled the constructors to build planes with lift to drag ratios of about 50 (ASW 17: 48.5, Nimbus 2: 49) and sinking speeds of 0.50 m/s (1.64 ft/s). But it was not possible to realize wing spans with more than 22 meters without a very soft wing structure. This was possible when carbon fibers were used in the center wing section of the Akaflieg Braunschweig SB 10 in 1972 (fig. 1). With a maximum wing span of 29 meters, this glider has the best glide ratio of 53 and a sinking speed of 0.41 m/s (1.35 ft/s). But the price of carbon fibers was very high at this time and so this material was used only in another prototype, the Akaflieg Stuttgart fs-29 in 1975. To realize the old dream to vary the span during flight, it was absolutely necessary to use carbon fibers in the outer moving part of the wing and in the spar of the inner wing section. When the Akaflieg Braunschweig built the first all-carbon glider in 1977/78, they used carbon fibers to reduce weight and to stiffen the wing, so that all flaps move only very slightly and the pilot is able to handle them. And this was the year when carbon fibers were used in a larger volume in different types of commercial gliders.

## WEIGHT SAVINGS

Weight and stiffness problems occur especially, and so it is not surprising that most of the new flap gliders use carbon fibers in the spar. The wings of some of the often-built gliders are shown in figure 2. All the planes use a spar with carbon-fiber-reinforced epoxy and the weight savings are in the range of about 11 to 14%. When carbon fabric is also used instead of some glass fiber fabric layers, weight savings increase up to 17.4% compared with the fully equipped wing or up to 24.3% compared with the wing structure itself.

In the matter of fuselages, weight saving rates are lower (fig. 3), because there is a higher weight percent of controls and of the landing gear. When carbon is only used in fuselage stringers, weight savings are about 8%. If some glass layers are replaced by aramid or carbon fabric, the range will increase to about 15%.

But these values are not the maximum weight savings which can be realized. Looking at specific tension strength of reinforced epoxy laminates in figure 4, mass reductions of 50% by substitution of aramid fibers and of 40% by substitution of carbon fibers are possible, when bare structures are considered.

## MATERIAL PROPERTIES

All material properties shown in the following figures are test results of hand-laminated systems. Most of the tests have been undertaken at room temperature and normal outdoor humidity.

Resins were of the epoxy type, such as Rütgers-Bakelite L02/SL or L20/SL or CIBA XB 2878. These resin systems are normally cured for glider purpose at room temperature for 24 hours and postcured at 60° C (140° F) for 15 to 20 hours. They have shown better interface characteristics with carbon and aramid fibers and also higher temperature stability than the older Shell Epikote systems.

The fiber types are mentioned in each figure. The carbon is usually untwisted T300 B produced by TORAY. Fabric types which have been used have the following characteristics:

Carbon-UD:	TORAY	2002	130 g/m <sup>2</sup>
Carbon fabric:	Interglas	03040	200 g/m <sup>2</sup> linen
Aramid-UD:	Interglas	98616	170 g/m <sup>2</sup>
Aramid fabric:	Interglas	98612	170 g/m <sup>2</sup> twill
Glass-UD:	Interglas	92145	220 g/m <sup>2</sup>
Glass fabric:	Interglas	92125	276 g/m <sup>2</sup> twill

Material tests have been done in a lot of different works (refs. 1 to 5). But all laminates have been prepared under the same conditions and have been tested at the same test facilities.

To use advanced composites - i.e., carbon- and aramid-fiber-reinforced epoxy laminates - in spar flanges for gliders and lightweight planes, tensile strength and modulus are the most important characteristics to consider. Figure 5 shows a small advantage of Kevlar 49 compared with carbon and E-glass especially when UD-laminates are intended to be used for a wet lamination process. For torsion shells, fabrics under diagonal orientation are normally used. Therefore Kevlar and carbon have the same qualities.

But as spar flanges may also be loaded under compression, aramid fibers are not usable for this purpose. Because of its chainlike molecular structure, this material has only about 20% of tension strength capacity under compression load (fig. 6).

In all highly loaded structures the shells are also carrying loads. To calculate the load distribution between the shell and spar, it is necessary to know the elastic moduli of the materials used (fig. 7).

A conventional structure has a carbon spar, laminated with rovings or UD-tapes and a  $\pm 45^\circ$  reinforced shell. So the very stiff spar will carry most of the bending loads, while the shell with only 10% stiffness in carbon or 3 to 4% in aramid or glass fiber fabric will carry only a small part of the bending forces. This is valid only when the laminate areas of the spar and the shell are in the same range. Due to the higher allowed stresses in carbon compared with glass, the cross sections of spars decrease while the shell area remains constant. So the load-carrying ratio is pushed to the side of the shell and the wing stiffness increases.

On the other hand, shear moduli of  $45^\circ$  laminates are higher than those of  $0^\circ$  or  $90^\circ$  laminates (fig. 8). As the shear area of the shell is much higher than the area of the spar, most of the torsion and shear loads are carried by the shell.

Figure 9 shows the shear strength of epoxy laminates found by tube-torsion tests. This test method generates the highest shear values, as there is no problem with force introduction into test specimens. Carbon laminates with  $\pm 45^\circ$  fiber orientation show the highest values compared with aramid or glass fibers. Woven materials also produce higher values than nonwoven unidirectional layers oriented under  $\pm 45^\circ$ . These layers are better to handle and to orient.

Interlaminar shear strength (fig. 10) of carbon laminates is higher than in glass or aramid fiber laminates. The epoxy resins used most in combination with aramid and carbon fibers in Germany are the Rütgers-Bakelite L20 and CIBA XB 2878. There are only small differences in material strength, not only in interlaminar shear strength, so that these resins may be substituted one for the other. Both resins have fulfilled the airworthiness requirements issued by the Luftfahrtbundesamt.

It is not necessary to use only laminate angles of  $0^\circ$ ,  $0^\circ/90^\circ$  or  $\pm 45^\circ$ , which are based on production experiences to save material and time during fabrication. When different angle-ply laminates are used, the tensile modulus can be calculated as shown in figure 11 for UD-tapes in a symmetric laminate.

For gliders, temperatures of 54° C (129° F) in structures with a white surface are normally not exceeded. But the coefficients of thermal expansion should be considered (fig. 12). Additional stresses may occur in some material combinations. This is also valid when carbon is bonded to aluminium or steel. In this matter there must be also anticorrosion coatings to provide corrosion protection without any adhesive system. Stainless steels should be used in this case.

As shown before, aramid fibers are not very useful for primary structures. Especially when weight savings are necessary in some parts of planes, aramid fibers in combination with carbon fibers can be used to increase the impact resistivity.

The low impact energy of pure carbon (fig. 13) can be improved by combination with aramid fibers (fig. 14). The highest gains can be reached with a 36% carbon fiber weight ratio in an aramid-carbon-hybrid laminate (ref. 4), where carbon is the surface material. Such a material combination may be used in fuselages, especially in the cabin area, to provide large impact resistance in case of an accident.

If such hybrid laminates should be subjected to high loadings too, Poisson's ratio of the combined materials must be considered (fig. 15). In case of large differences in Poisson's ratio, secondary stresses perpendicular to the loading direction will be generated.

The investigation of fatigue usually ends at  $10^6$  to  $10^7$  load cycles. In case of the hand-laminated, room-temperature-cured epoxy laminates normally used, there are only limited valid test results available. The published results are normally valid for prepreg systems (fig. 16). Larger differences between prepreg resin systems and room-temperature-curing systems at operation temperatures of planes are not expected and the test results can be extrapolated to these laminates. Fatigue strength of carbon epoxy (about 600 N/mm<sup>2</sup>) is much higher than of glass fiber epoxy (about 200 N/mm<sup>2</sup>). But more tests have to be run with the new resin systems, because the normally used Shell Epikote/Laromin has poorer quality in combination with carbon fibers.

Special tests on wing spars have been carried out with different fiber resin systems (fig. 17 and ref. 5). A loading spectrum of various operation loads has been run with about 6 million load cycles or 9000 hours flight simulation for glass fiber spars. As the lifetime of fiber-reinforced gliders is higher than expected, an increased program for carbon spars with a safe life simulation of 12 000 hours has been run. Residual strengths of different spars indicate the safe life value of 600 N/mm<sup>2</sup> at the maximum demanded operation temperature of 54° C (129° F) (refs. 6, 7).

A new problem appears when carbon fibers are used in airplane structures. Lightning damage may occur to unprotected carbon-fiber-reinforced plastic (CFRP) up to total failure of a 6-mm laminate in an area of 80 mm diameter, corresponding to a strike of 200 kA (fig. 18 and refs. 8 to 10). The whole carbon-reinforced area must be protected with an aluminium mesh. The weight gain is small, because mesh weight is only 100 g/m<sup>2</sup>. Damage is reduced to failure of the surface layers.

Different applications combining all material qualities are possible. For fuselage tubes, fiber winding technology is possible and has already been tested (figs. 19, 20, and ref. 11).

For wing structures a combination of carbon spars, carbon torsional shell, and aramid trailing edge box may be the weight optimal structure (fig. 21). In the cockpit region hybrid shells of aramid and carbon fabric may fulfill the accident requirements, while the carbon spars carry most of the bending loads.

Comparing prices, a decrease is still observed and a more severe decrease is expected when automotive industries start using these fibers or new production technologies are developed. Also new manufacturing methods, such as winding or prepreg application, have to be introduced to the sailplane industry to make the new materials cost-competitive with the "old" glass fiber.

#### ABBREVIATIONS

CFRP	carbon-fiber-reinforced plastic
GFRP	glass-fiber-reinforced plastic
SFRP	synthetic-fiber-reinforced plastic

#### REFERENCES

1. Hald, H.: Versuche zur Festigkeit von Gewebe - Laminaten. DFVLR Stuttgart, IB 454-79/4 (1979).
2. Schmid, T.: Biegefestigkeiten von Gewebe - Laminaten. DFVLR Stuttgart, IB 454-79/5 (1979).
3. Kensch, Chr.; Muser, D.: Neuere Werkstoffentwicklungen und Fertigungstechniken für den Segelflugzeugbau. DFVLR Stuttgart, IB 454-77/17 (1977).
4. Hector, B.: Untersuchungen symmetrischer Mischlamine. Studienarbeit Institut für Flugzeugbau, Universität Stuttgart, May 1976.
5. Hinz, B.: Statische und dynamische Biegeversuche an CFK-Holmen mit kastenförmigem Querschnitt. DFVLR Stuttgart, IB 454-78/2 (1978).
6. LBA: Richtlinien zur Führung des Festigkeitsnachweises für Bauteile aus Kohlenstofffaser verstärkten Kunststoffen von Segelflugzeugen und Motorseglern. Luftfahrtbundesamt (LBA) Braunschweig, March 1978.
7. Niederstadt, G.: Kriterien und Beispiele für die Wahl von Verbundwerkstoffen mit Fasern hoher spezifischer Eigenschaften. In: Kohlenstoff- und aramidfaserverstärkten Kunststoffen, VDI-Verlag, Düsseldorf 1977.
8. Molly, J. P.: Blitzschutzuntersuchungen und Auslegung des Blitzschutzsystems für das GROWIAN - Rotorblatt. DFVLR Stuttgart, IB 454-78/11 (1978).
9. Skouby, C. D.: Relative Behaviour of Graphite/Epoxy and Aluminium in a Lightning Environment. Annual Book of SAMPE, Volume 23, 1977.
10. Hendricks, C. L.: Lightning Protection Techniques for Graphite/Epoxy Aircraft Structures. Annual Book of SAMPE, Volume 23, 1977.
11. Speth, J. F.: Faserverbund-Rumpfröhre. Studienarbeit Institut für Flugzeugbau, Universität Stuttgart, January 1976.

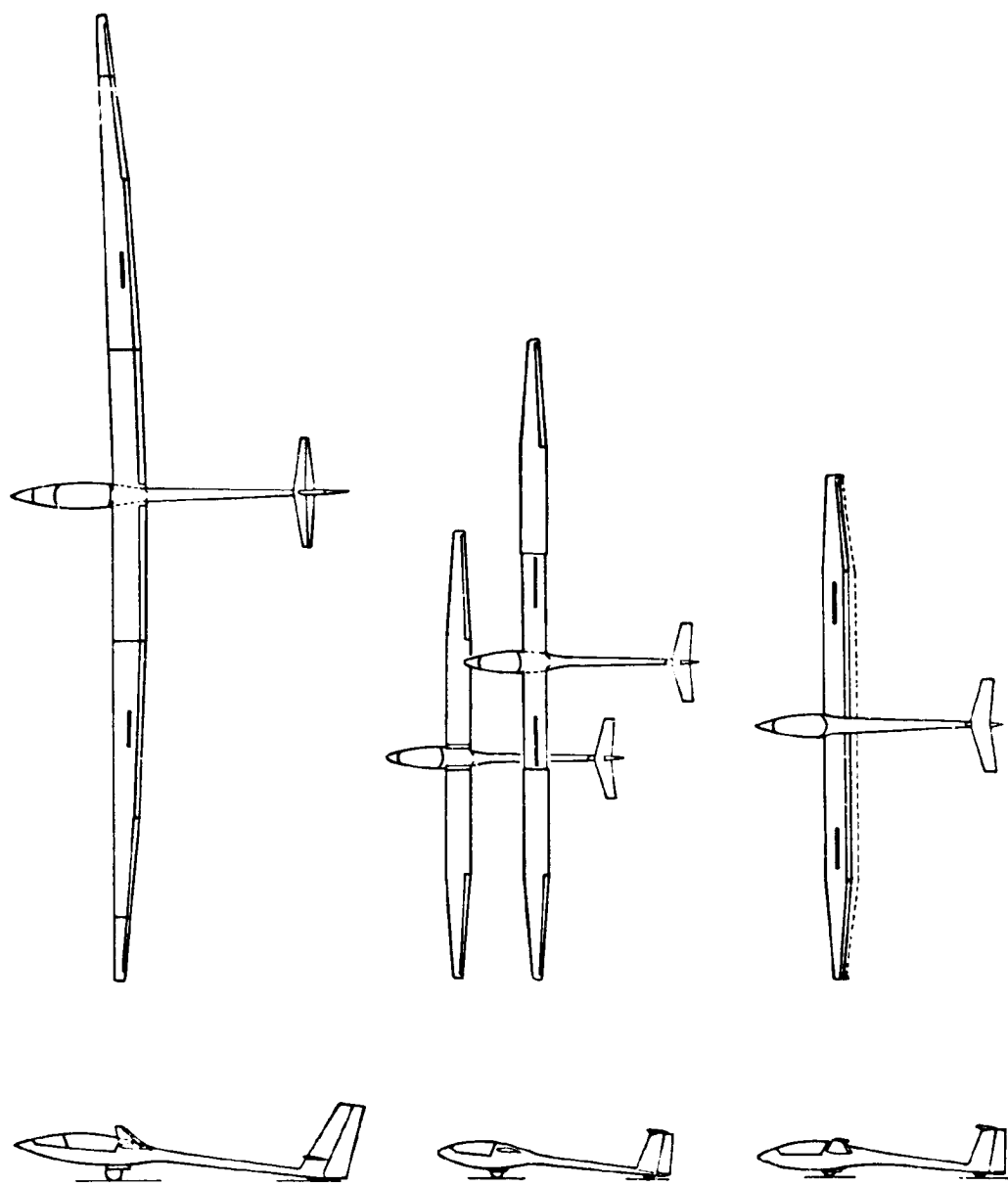

TYPE	SB 10	fs-29	SB 11
SPAN m	29	13 - 19	15
WEIGHT N	5800	3700	2600
1. FLIGHT	1972	1975	1978
FIBER	SIGRI	T 300	VARIOUS

Figure 1.- CFRP in prototypes.



980	860		12.2	Slingsby T59
1375	1225		10.9	ASW 17
1150 COMPLETE WING 820 STRUCTURE	950 620		17.4 26.3	Nimbus 2
650	540		16.9	Mini-Nimbus
700	600		14.3	PIK 20 D
GFRP WEIGHT [N]	CFRP		[%] WEIGHT- SAVING	

Figure 2.- Material substitution in sailplane wings.



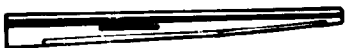
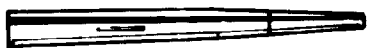
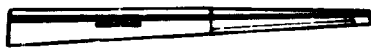

1250	1150	8	25	C		ASW 17
940	830	11.7	20	C/S		Mini-Nimbus
1020	905	11.2	50	C		ASW 19 SB 11
930	790	15.0	1	C/S		LS 3
GFRP WEIGHT	CFRP WEIGHT	WEIGHT SAVING	PRC C.P. TS			TYPE
[ N ]		[ % ]				

Figure 3.- Material substitution in fuselages.



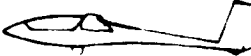
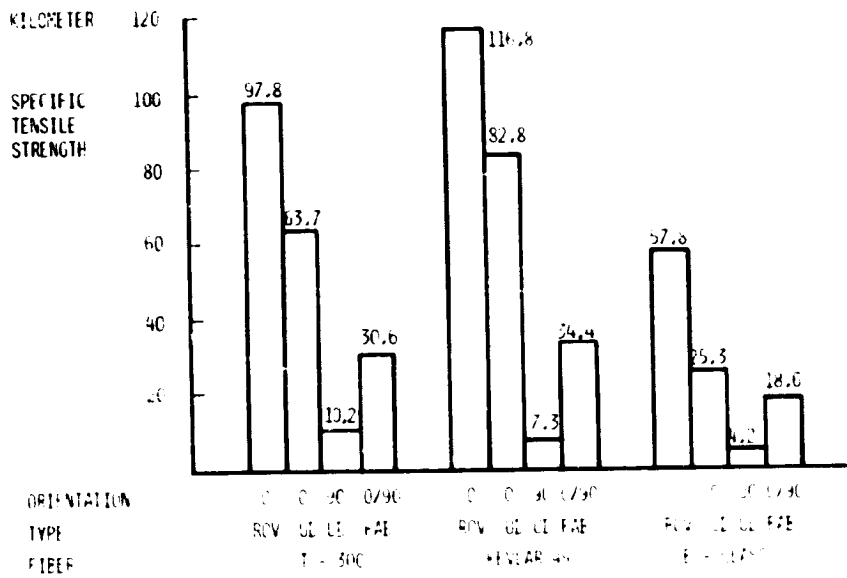

Figure 4.- Specific tension strength of epoxy laminates.

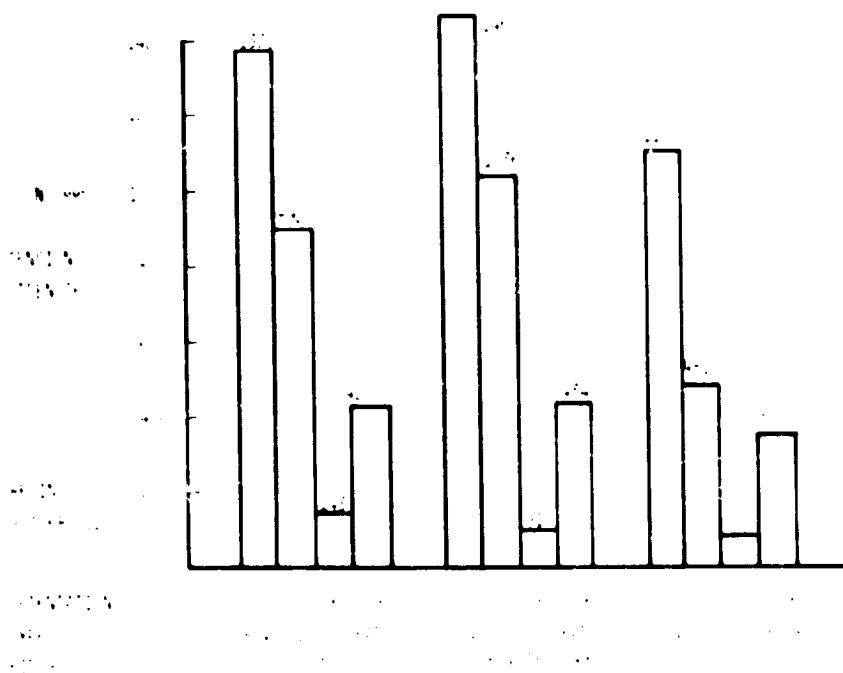

Figure 5.- Tension strength of epoxy laminates.

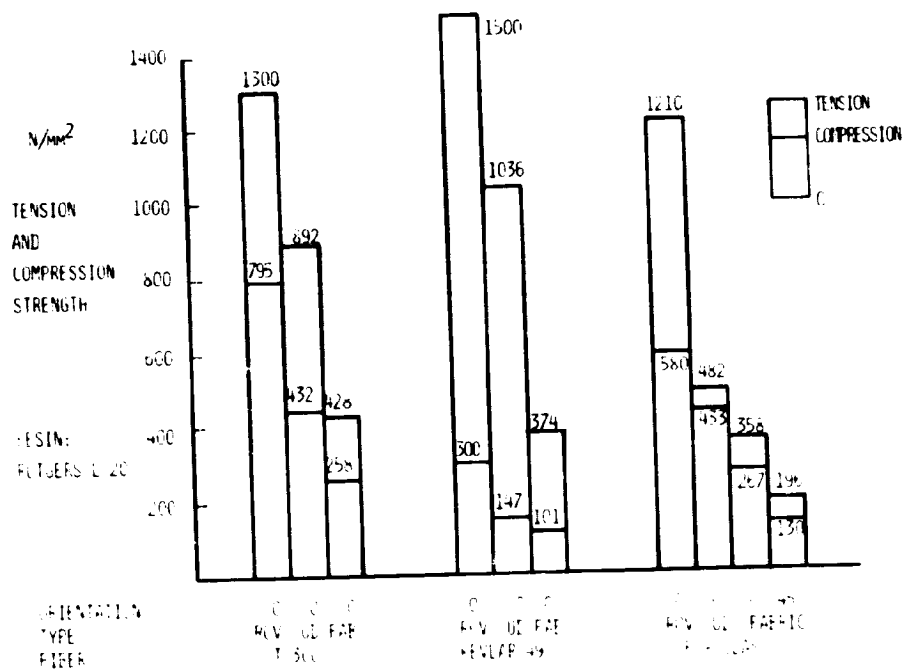

Figure 6.- Tension and compression strength.

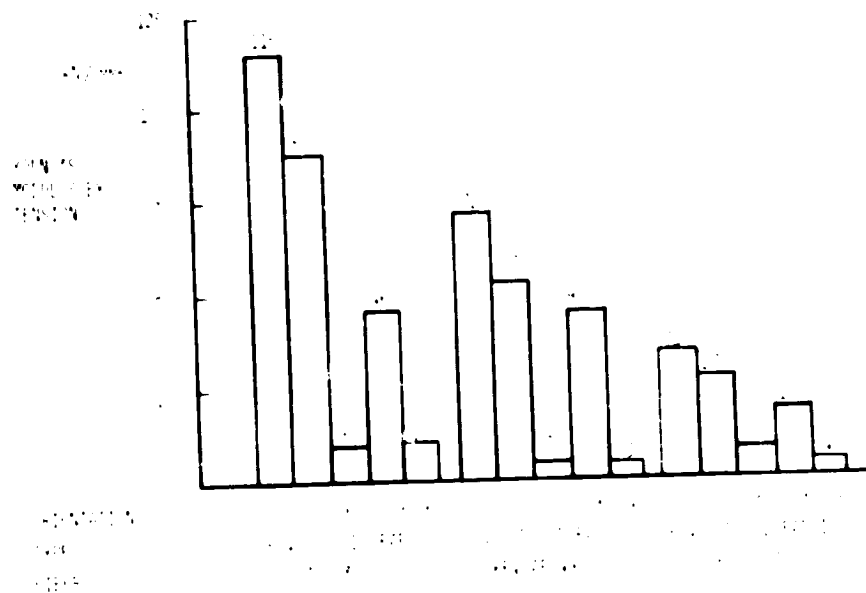

Figure 7.- Young's modulus of epoxy laminates.

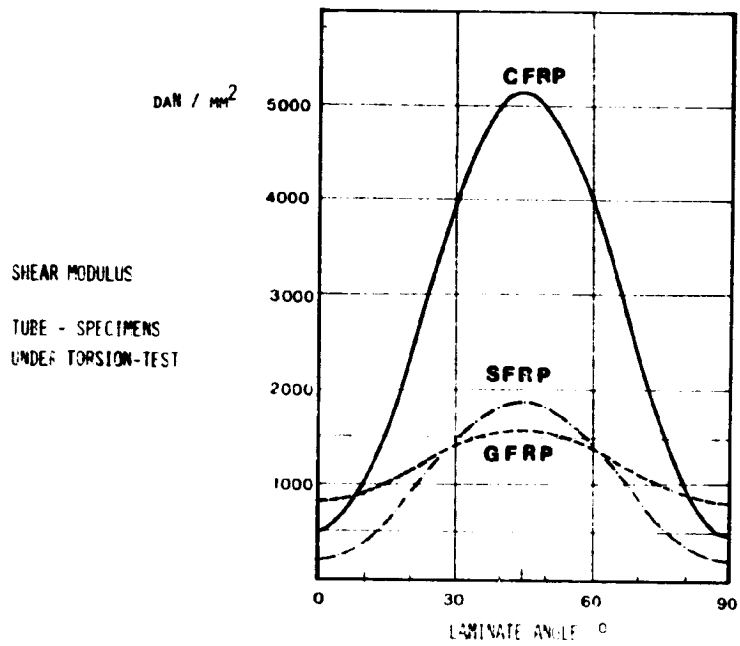

Figure 8.- Shear modulus of epoxy laminates.

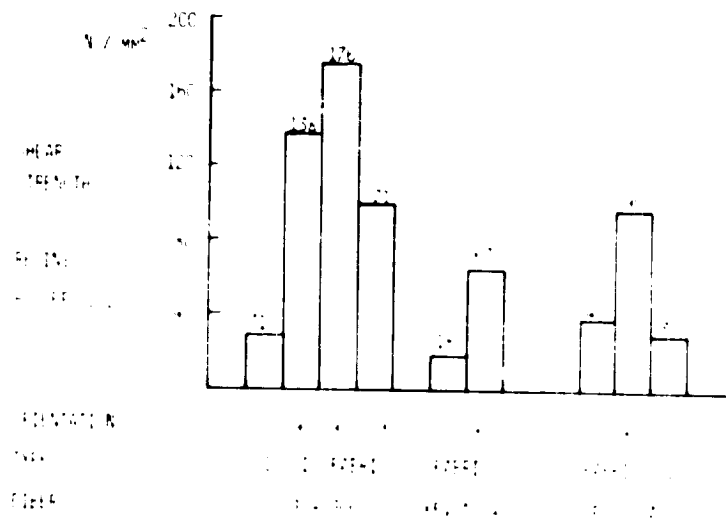

Figure 9.- Shear strength of epoxy laminates.

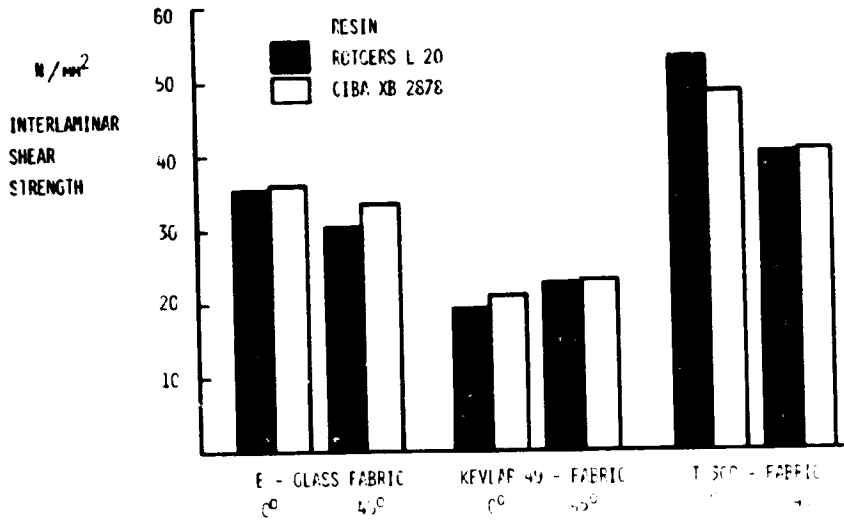

Figure 10.- Interlaminar shear strength.

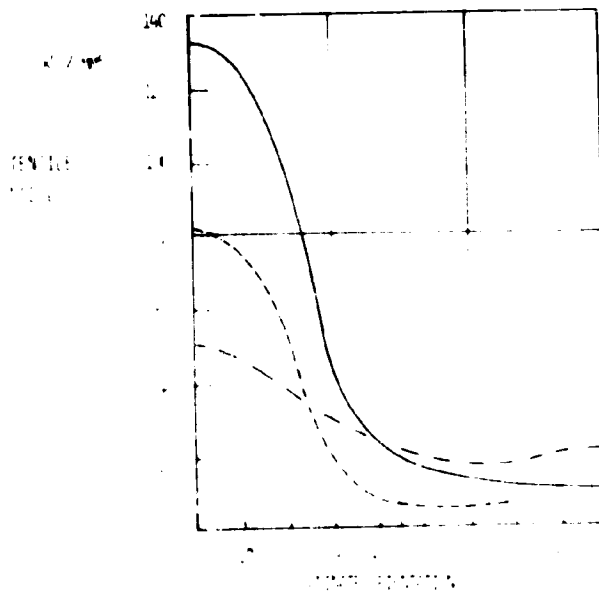

Figure 11.- Tensile modulus of angle-ply laminate.

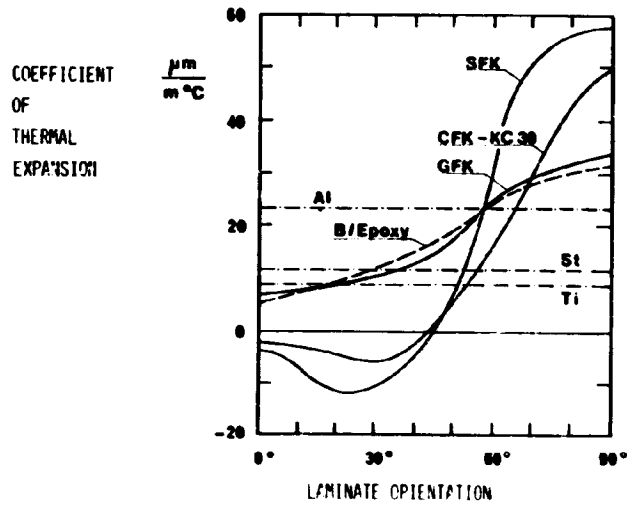

Figure 12.- Coefficient of thermal expansion.

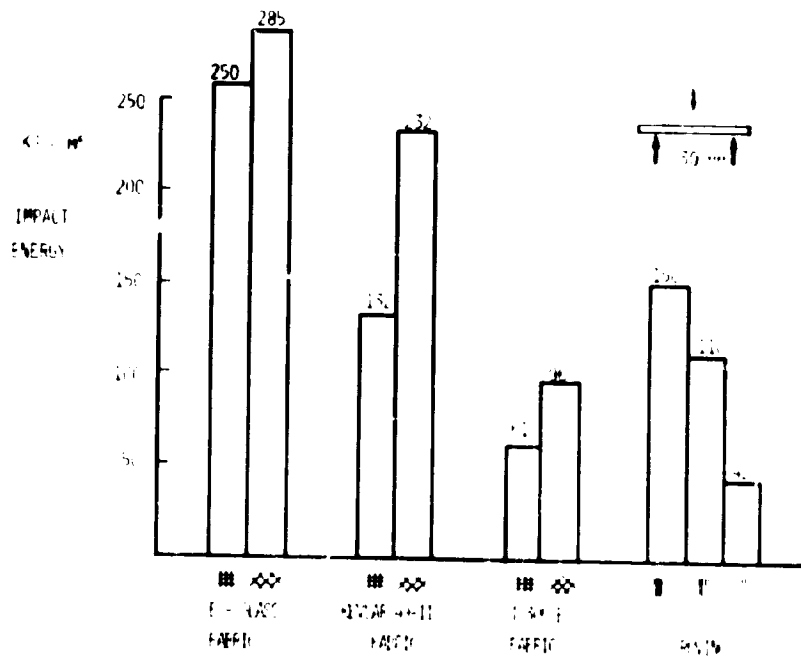

Figure 13.- Impact energy of epoxy laminates.

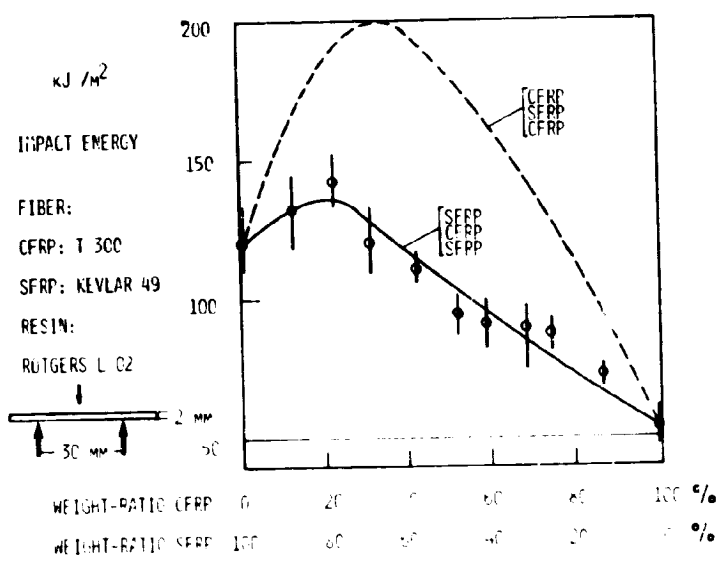

Figure 14.- Impact energy of hybrid laminates.

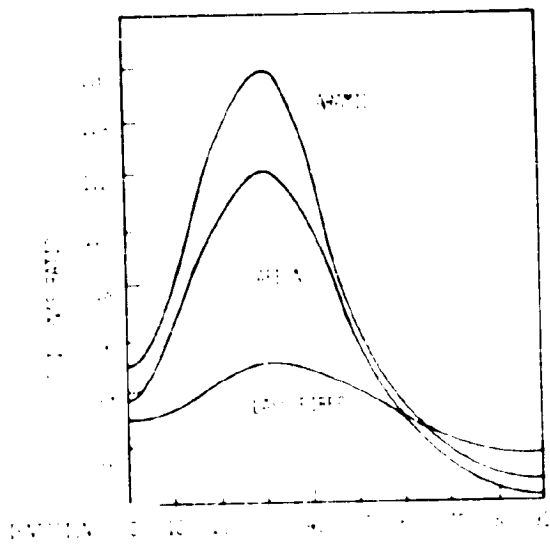

Figure 15.- Poisson's ratio of epoxy laminates.

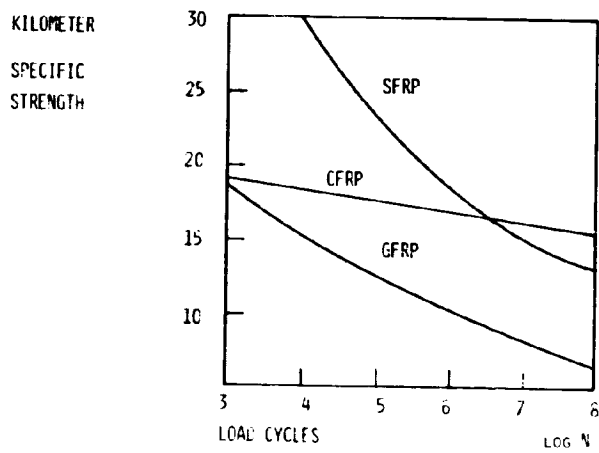

Figure 16.- Specific fatigue strength of 0° laminates.

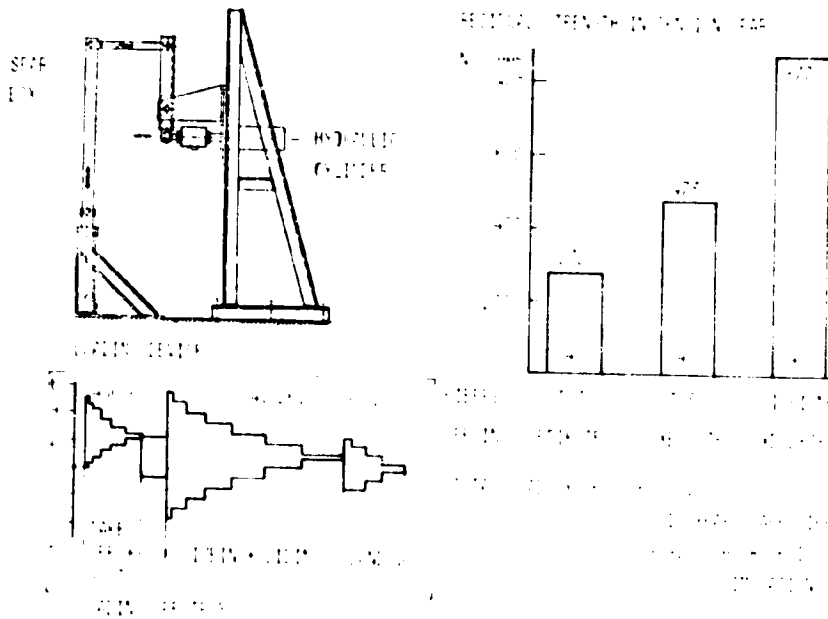

Figure 17.- Dynamic tests on CFRP glider spar box.



Figure 18.- Lightning damage of an unprotected carbon-reinforced wing structure.

REPRODUCIBILITY OF THE  
ORIGINAL PAGE IS POOR



Figure 19.- Carbon fiber winding of a fuselage tube with hybrid structure.



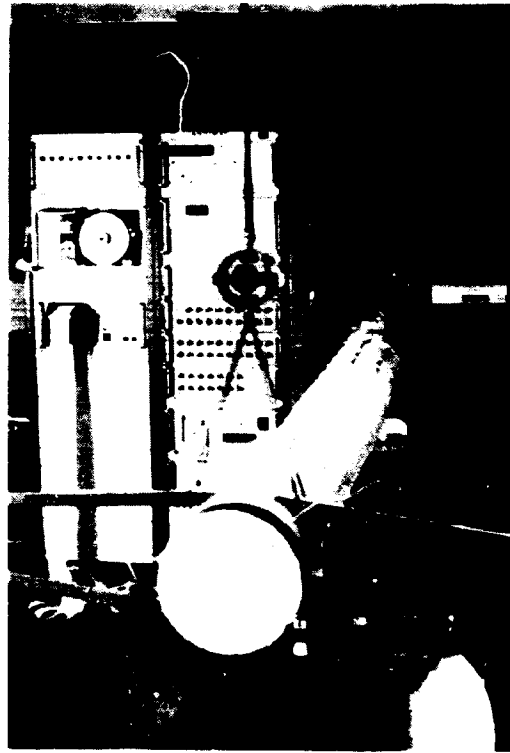
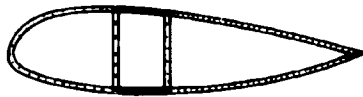

Figure 20.- Hybrid fuselage tube under bending load.

REPRODUCIBILITY OF THE  
ORIGINAL PAGE IS POOR



1. MAIN FUSELAGE
2. MAIN FUSELAGE
3. MAIN FUSELAGE
4. MAIN FUSELAGE
5. MAIN FUSELAGE
6. MAIN FUSELAGE
7. MAIN FUSELAGE
8. MAIN FUSELAGE
9. MAIN FUSELAGE
10. MAIN FUSELAGE

11. MAIN FUSELAGE
12. MAIN FUSELAGE
13. MAIN FUSELAGE
14. MAIN FUSELAGE
15. MAIN FUSELAGE
16. MAIN FUSELAGE
17. MAIN FUSELAGE
18. MAIN FUSELAGE
19. MAIN FUSELAGE
20. MAIN FUSELAGE

Figure 21.- Proposals for lightweight structures.

## THE ULTRALIGHT SAILPLANE

by

J. H. McMasters

Boeing Commercial Airplane Company

Seattle, Washington

## SUMMARY

The increasing cost of traditional soaring has led to a search for less expensive alternatives. During the past decade, the rise in the popularity of hang gliding, together with advances made in other branches of ultralight weight aircraft design (e.g., human powered aircraft), has demonstrated the possibility of development of a "new" category of soaring device - the "ultralight sailplane." As presently envisioned, the ultralight sailplane is intermediate in size, cost and performance between current hang gliders (defined here as a "sailplane" having a foot launch/landing capability) and the lower end of the traditional sailplane spectrum (as represented by the Schweizer 1-26, "Duster" and "Woodstock"). In the design of an ultralight sailplane, safety, low cost and operational simplicity are emphasized at the expense of absolute performance. The present paper presents an overview of the design requirements for an ultralight sailplane. It is concluded that by a judicious combination of the technologies of hang gliding, human powered flight, conventional soaring and motor gliding, an operationally and economically viable class of ultralight, self-launching sailplanes can be developed.

## INTRODUCTION

The purpose of the present paper is to summarize and place in context the technical design trade-offs, performance potential and operational characteristics of a category of ultralight sailplanes which would combine several desirable characteristics of present hang gliders, sailplanes and motorgliders into a viable, low-cost alternative or supplement to all three. There are few modern examples of the ultralight sailplane envisioned here, and a central purpose of this paper is to establish the existence of an "ecological niche" for such devices.

The remarkable rise in the popularity of hang gliding during the past decade has paralleled an increase in both cost and regulation of traditional sport aviation (powered and unpowered). This has led to a rebirth in interest in a range of ultra-light weight sport aircraft. The wretched safety record and generally low performance (by modern sailplane standards) of hang gliders has resulted in substantial controversy within organizations like the Soaring Society of America (SSA) regarding the wisdom and desirability of associating