

N79-21386

TORQUE-WHILE-TURNAROUND SCAN MIRROR ASSEMBLY

By Charles John Starkus

Hughes Aircraft Company

ABSTRACT

This paper reviews mechanical aspects in the development of an oscillating scan mirror mechanism that featured a remarkably low level of structural vibration for the impact energies involved in mirror oscillation. Another feature was that energy lost during impact was returned to the mirror by applying torque only during the instant of impact. Because the duration of impact was only about 0.010 second, it was critical that energy losses be minimal because there was not much time to restore them.

INTRODUCTION

Early in the space program, NASA recognized the importance of remote sensing for management of the earth's resources and human environment. This recognition led to the formation of a program, under the management of the Goddard Space Flight Center of NASA, with a purpose of sensing data for such diverse applications as agriculture and forestry inventories, hydrology, geology, and land use inventory. One versatile sensor that emerged for these purposes was the Hughes multispectral scanner, which was first launched July 23, 1972 and is still operating successfully. A breadboard study contract for a next generation system, called thematic mapper (TM), has been completed. This paper discusses mechanical aspects of the scan mirror assembly portion of the breadboard study contract.

DESCRIPTION OF MECHANISM

The scan mirror assembly is part of a TM system. This scanning system can give complete optical coverage of the earth from an altitude of 705 km. As a spacecraft progresses southbound in a near polar orbit, scanning is accomplished by a mechanical oscillating flat mirror that sweeps the optical line of sight (LOS) from side to side as illustrated in Figure 1. This enables a 185-km-wide swath of the earth to be viewed during each orbit. Since successive orbits cover adjacent swaths, a series of orbits can completely map the entire earth.

The sketch in Figure 2 shows the elements of a TM scanner in relation to the orbit. Reflective optics focuses infrared energy from the earth upon detectors that are sensitive to designated spectral bands. Earth is downward, and the spacecraft velocity vector, which is nominally southbound, is moving away from the reader. Oscillating the scan mirror $\pm 3.72^\circ$ causes the optical LOS to sweep back and forth across the 185-km swath of earth. The scan mirror will sweep first in one direction, then back in the other, imaging data during both passes.

Earlier systems imaged data during only one pass and were inactive during the retrace. Scanning bidirectionally improves scan efficiency.

The scan mirror assembly is a key element of this conceptual TM system (see Figure 3). It is an object space scanner, which scans the earth in a direction orthogonal to spacecraft motion and thereby enables the sensor to view a swath of the earth with each orbit. The scan mirror assembly illustrated in Figures 4 and 5 consists of a 16 x 20 inch flat elliptical scan mirror mounted by Bendix flexural pivots on a fixed frame, an electromagnetic torquer, leaf spring bumper assemblies, and a position sensor. The scan mirror oscillates by rebounding between springs in a bang-bang manner and scanning between rebounds at nearly constant angular velocity. During the 0.010-second duration of impact, the torquer adds the energy necessary to maintain a constant 7-Hz oscillation. Mapping accuracy as well as data transmission and processing dictate the need for a nearly constant scan rate. Since the effect of torque is to change scan rate, torque can be applied only during those moments of turnaround when data is not being taken. In earlier systems, energy was restored by torquing during the entire return pass; hence, bidirectional scan was not possible. Each bumper is a leaf spring preloaded against a rubber stop. When the mirror impacts the bumpers at turnaround, the spring is deflected away from the stop; after turnaround, the stop damps out spring vibration before the next turnaround.

DESIGN REQUIREMENTS

The driving mechanical design requirements were minimization of structural vibration and of energy loss during turnaround. Specifically, it was required that:

- The total angular vibration of the mirror be less than 2 μ rad peak-to-peak during operation at 7 Hz. This was a relatively small level of vibration for the impact energies involved in the mechanism. By comparison, angular vibration of the previous generation system, multispectral scanner, was 40 μ rad peak-to-peak. The most significant mode of vibration was that of the mirror vibrating as mass suspended on two springs, each spring representing the shear stiffness of the flexural pivots.
- The coefficient of restitution of the bumper springs be sufficiently high that energy losses could be restored by operating an electromagnetic torquer only during a portion of the 0.010-second duration of turnaround.

The angular vibration requirement arose from the rather exacting pointing and timing specifications. Unlike angular vibration, translational vibration did not cause significant pointing errors. However, it was important to reduce translational vibration for the following reasons:

- Translational vibration has a tendency to excite angular vibration of adjacent components.

- The angular vibration of a given component would be expected to increase as translational vibration increases.
- Both angular and translational vibration represented energy absorbed from the scan mirror and hence lost from the scanner.

Vibrational damage of delicate components was not an overriding concern because the level of vibration was very low.

Angular vibration was measured by a laser beam reflected off the scan mirror and onto a position sensitive diode 50 inches in front of the mirror. Angular vibration of the mirror caused the reflected laser beam to shift position while the position sensitive diode provided a signal proportional to the shift. Coefficient of restitution was measured by a variation of this technique in which two diodes and a clock were used to measure velocity into and out of a bumper.

DISCUSSION

Structural Vibration

Bumpers were located at each end of the scan mirror in order to cause the force on the flexural pivots during turnaround to be, in the ideal case, zero. Actually, of course, pivot forces could not be made perfectly zero. Nevertheless, it was important that pivot forces be minimized because they tended to excite vibrations of the mirror on the pivots; this meant that bumper stiffnesses and impact locations had to be carefully adjusted. The adjustments were monitored by observing signals from magnetic pickoffs that measured bumper spring velocities.

The center of gravity was carefully adjusted so that it was located on the axis of rotation midway between flexural pivots. A moveable mass at the center of the mirror provided the means of adjustment. This positioning of the center of gravity had the effect of straightening the mode shape so that for a given level of vibration, the angular component was less than before; however, mode straightening alone did not bring angular vibration to within the required level. It was also necessary to reduce the general level of vibration. This problem was attacked (1) by adjusting bumper forces to be nearly symmetrical (as explained previously) and (2) by designing the bumpers in such a way that the frequencies of the impact forces were compatible with natural frequencies of the system. The second method afforded by far the more significant results.

The vibration of a structure is a strong function of the frequencies of the excitation forces; the excitation frequencies in this mechanism were the result of the impact of the mirror with the bumper springs. Consequently, reducing the general level of vibration involved thoroughly understanding the impact dynamics and evolving a bumper spring design such that impact frequencies were safely distinct from all natural frequencies of the system.

Figure 6 shows a schematic of the scan mirror assembly along with a simplified mathematical model that is very useful for understanding the dynamics

of the impact forces. Measurements of spring velocity indicated that the approximation was very realistic to the first order.

At turnaround, the mirror impacted bumper springs, which possessed some small mass. Therefore, in addition to the fundamental turnaround frequency ω_t that would have existed had the springs been ideal and massless, a higher frequency, due to the two colliding masses, was introduced at the moment of impact. Before the collision, the spring mass was at rest, and the mirror was approaching at its scan velocity. After the collision, the spring tip rebounded off the mirror, floated away from the mirror, then floated back toward the mirror and collided again. The process repeated itself until after a series of collisions, the process was damped out by surface friction. The natural frequency of the collision ω_c was approximately equal to $\sqrt{K/m}$, which states that in the collision, the spring tip mass m rebounds off the mirror and relies upon deformation of the contacting surface stiffness K to store energy during the collision. This type of collision is similar to that of a plastic sphere dropped on a steel plate. The frequency at which the spring tip mass floats away from the mirror is the first natural frequency of the bumper spring. In the simplified model, this is $\omega_f = \sqrt{k/m}$ as indicated in Figure 6.

The net result of the impact dynamics was that during turnaround, a force as illustrated in Figure 7 was produced at each end of the mirror. This force was made up of essentially two kinds of components, viz., a low frequency component, which was due to the stiffness of the bumper springs, and a high frequency component, which was due to spring tip mass and which occurred at the start of turnaround. Although the high frequency component had the appearance of noise, it was extremely repeatable from impact to impact. The high frequency forces were at a frequency similar to the collision frequency ω_c and were a known and modeled function of ω_c although they were not generally equal to ω_c .

A basic conclusion drawn from the model was that impact frequencies were the result primarily of bumper spring properties, viz., leaf spring mass, leaf spring stiffness, and surface contact stiffness. Therefore, all those properties were varied during the program by testing several bumper designs until eventually one was developed in which all of the impact frequencies were distinct from the natural frequencies of the system. Table 1 lists the frequencies of the final breadboard design. Testing was very useful since the collision forces depended somewhat on some very sensitive microscopic surface phenomena such as friction, stiction, and wear.

Energy Losses

Energy was lost during turnaround in three ways, and it was critical that each loss be minimized. First, energy dissipated in structural vibration represented one energy loss. Second, energy was left in the bumper mass after turnaround because spring velocity was equal to mirror velocity at the completion of turnaround (since the spring and mirror had been in contact and had been moving together), and the velocity spring mass product constituted a momentum that the spring received during turnaround. Consequently, this energy was lost from the mirror. The third loss was caused by friction at the point of contact between the mirror and the spring. Minimizing energy lost to structural vibration was a function of frequencies and stiffnesses. Two means were used to

reduce momentum lost to the spring mass. First, the leaf spring bumpers were designed to operate at a safe but high stress level in order to store maximum energy in minimum spring mass. Second, the leaf springs were tapered to distribute stress more evenly over their length.

Friction losses were minimized by designing a contact surface having a particular radial shape. The tip of the leaf spring bumper had a tendency to rotate as it was deflected, and that rotation constituted a sliding motion between the contacting surfaces. The purpose of the radial shape was to cause the distance that the contact point traveled along one contacting surface during turnaround to equal the distance traveled along the other contacting surface. The result of this design was to minimize sliding and maximize rolling friction. Since rolling friction is generally less than sliding friction, it was expected that energy losses from friction would be reduced. It was also expected that structural vibrations excited by friction force frequencies would be reduced. The contacting surfaces consisted of a flat polished metal surface on the mirror and a Delrin AF (several other materials were also tested) radially shaped button bonded to the tip of the leaf spring.

CONCLUDING REMARKS

Two major mechanical problems were solved during the breadboard program.

- Structural vibration was reduced to a remarkably low level for the impact energies inherent in the mechanism (to less than 2 μ rad at 7 Hz, the primary mode of vibration occurring when pivots on the mirror deformed in shear).
- Mirror energy was conserved at each turnaround to ease the requirements of the torquer and control system, which input energy only during a portion of the 0.010-second bumper impact time.

The first problem was solved by understanding the collision frequencies that occurred when the mirror mass impacted the bumper mass and then designing the bumpers to have impact frequencies distinct from all natural frequencies of the system. The second problem was solved by using tapered leaf springs of very low mass and by making the contacting surface a rolling radius to maximize rolling and minimize sliding friction. The result was a high, 97% coefficient of restitution.

These very significant developments in scan mirror technology advanced the capability of optical scanning systems to provide high resolution and high scan efficiency.

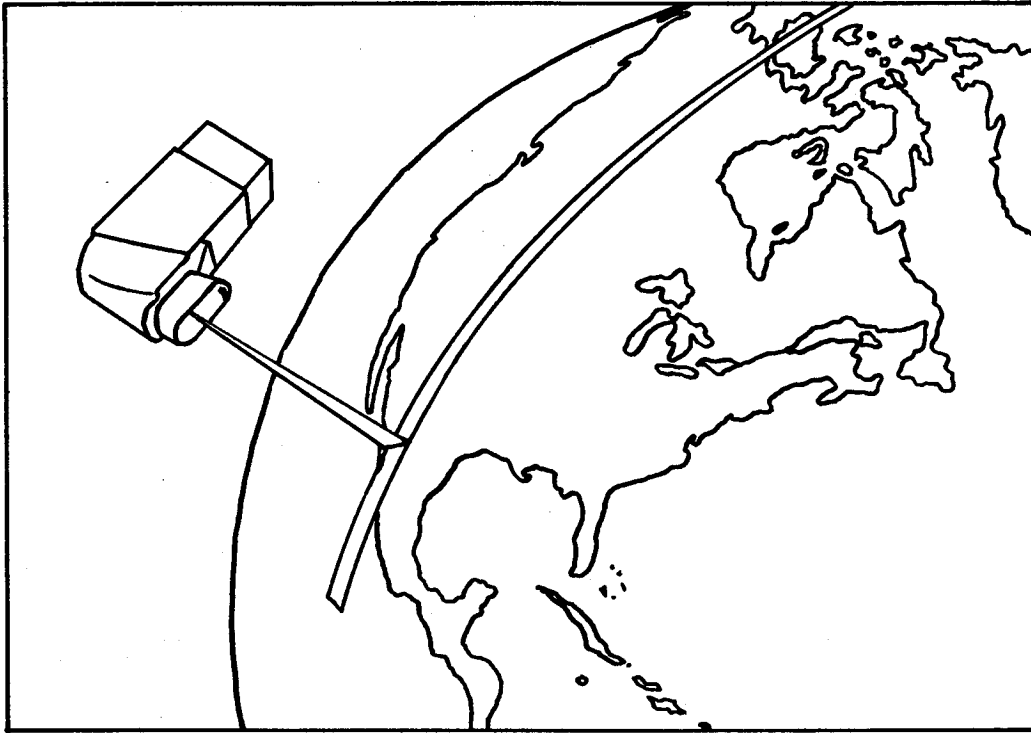

Figure 1. Conceptual TM in orbit showing scan pattern

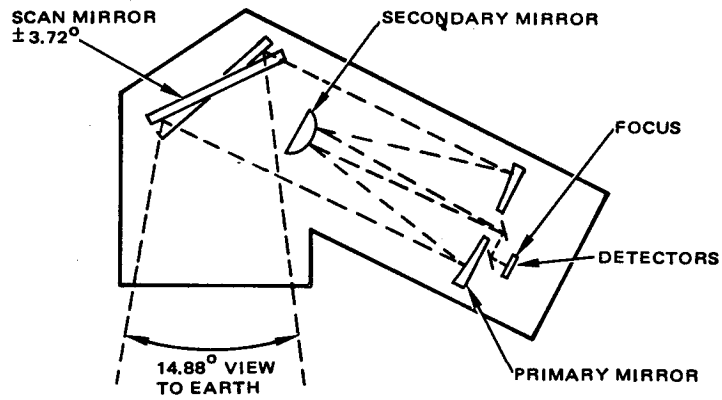

Figure 2. Configuration of conceptual TM scanner

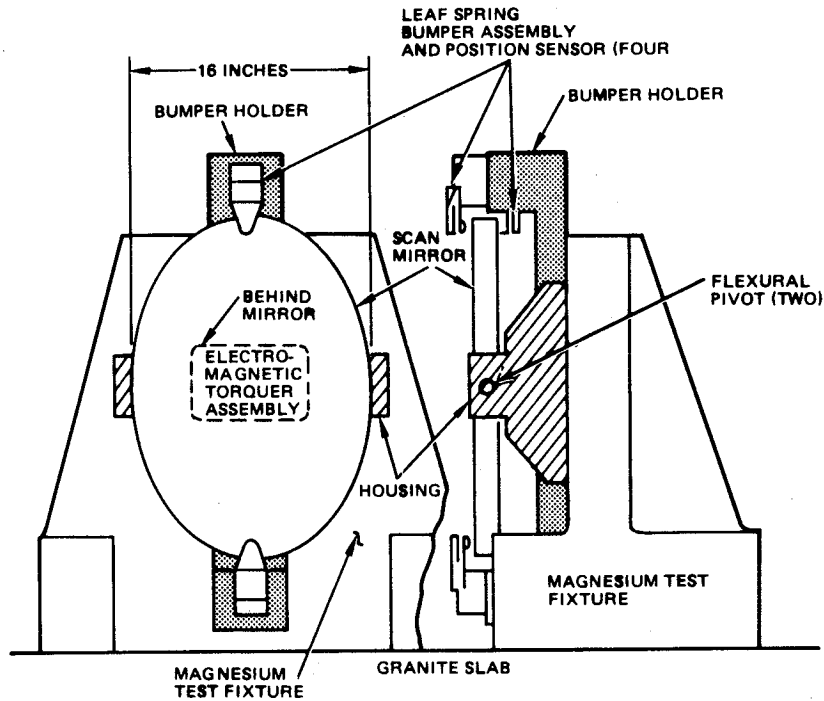

Figure 3. Cutaway view of conceptual TM system showing torque-while-turnaround scan mirror assembly

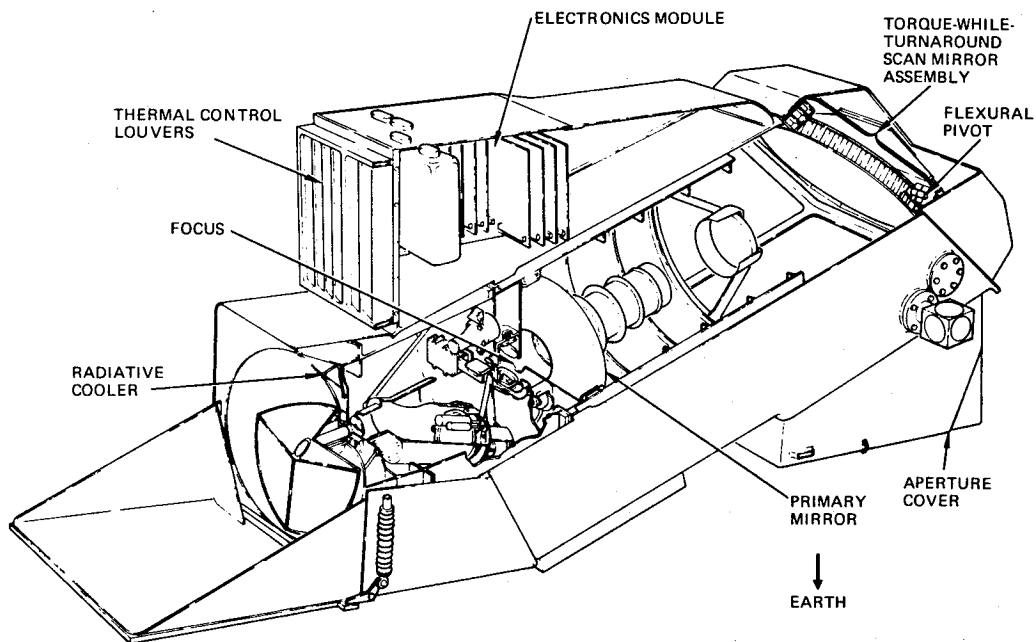
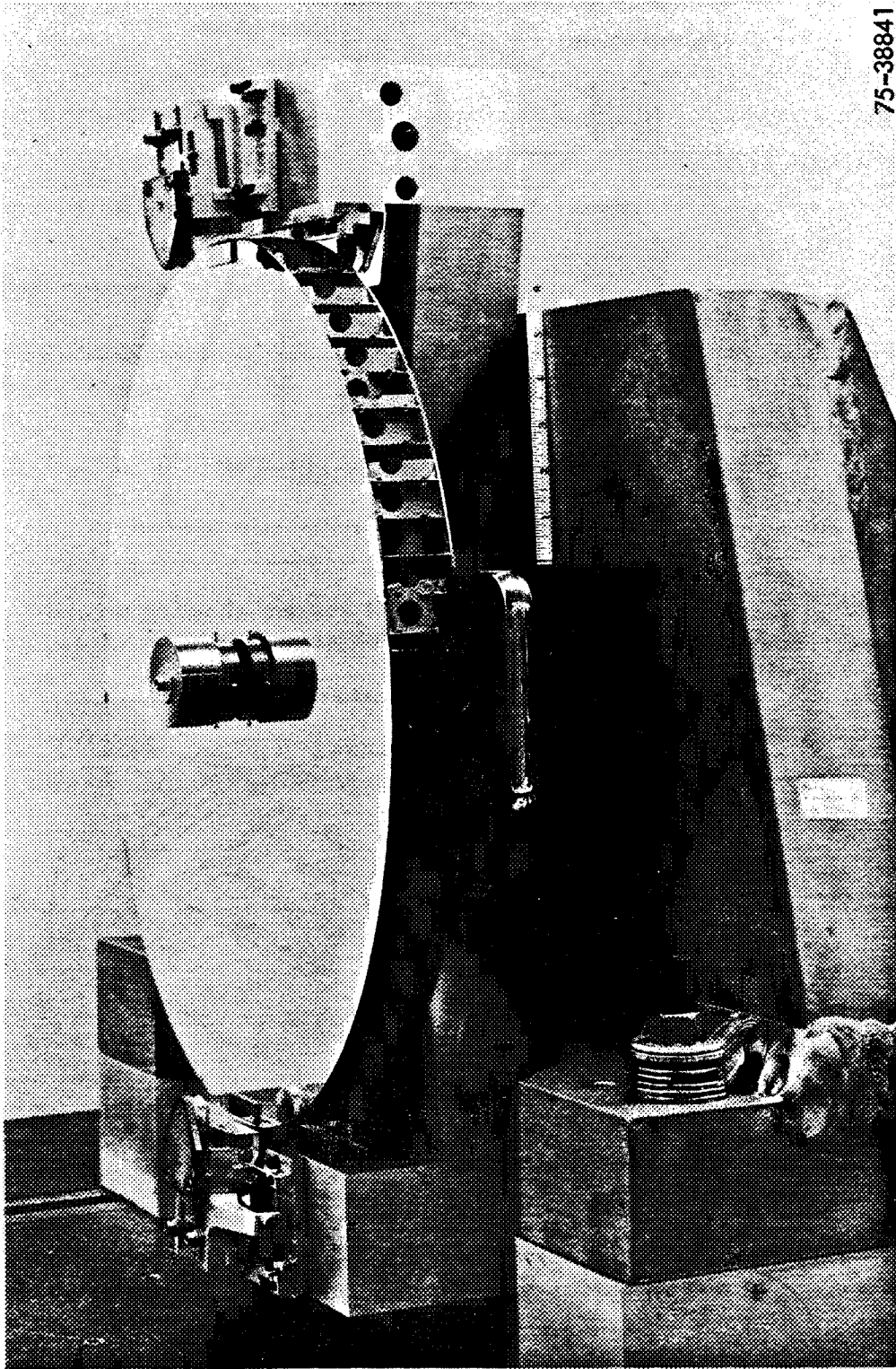

Figure 4. Sketch of breadboard scan mirror assembly showing major subassemblies and supports of torque-while-turnaround scan mirror assembly

60346-405



75-38841

Figure 5. Breadboard scan mirror assembly mounted on test fixture

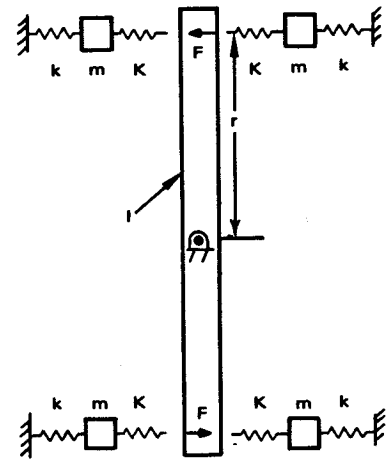
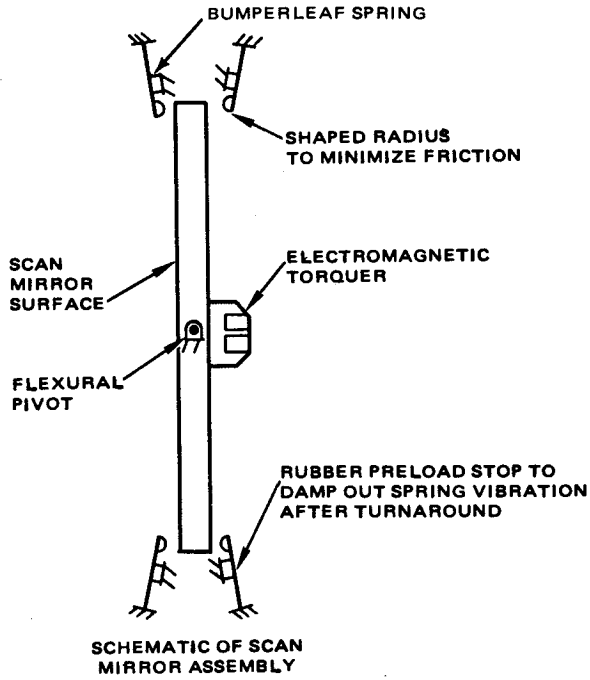

$\omega_t = \text{TURNAROUND NATURAL FREQUENCY} \approx \sqrt{\frac{2kr^2}{I}}$
 $\omega_c = \text{COLLISION NATURAL FREQUENCY} \approx \sqrt{\frac{K}{m}}$
 $\omega_f = \text{FLOATING FREQUENCY (FIRST NATURAL FREQUENCY OF BUMPER LEAF SPRING)} \approx \sqrt{\frac{k}{m}}$

- I = MIRROR INERTIA
- k = STIFFNESS OF LEAF SPRING
- m = EFFECTIVE MASS OF LEAF SPRING (m VERY SMALL COMPARED TO I)
- K = STIFFNESS OF CONTACTING SURFACES (K VERY LARGE COMPARED TO k)
- r = DISTANCE FROM AXIS OF ROTATION TO BUMPER SPRINGS
- F = IMPACT FORCE ON MIRROR

Figure 6. Impact dynamics

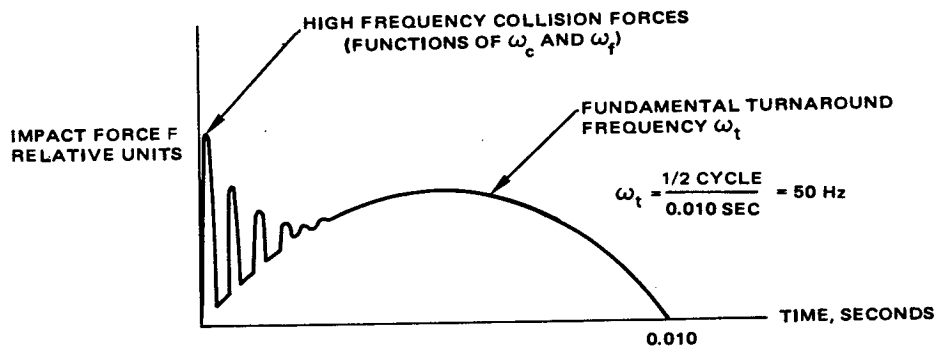

Figure 7. Impact force

Table 1. Impact Frequencies Versus Natural Frequencies

Impact Frequencies (Frequency of Half-Sine Impulse), Hz	Natural Frequencies of System, Hz	Mode	Comments
$\omega_t = 50$			Function of bumper spring stiffness and mirror inertia
	125	Support structure	Minimum excitation if $\geq 2.5 \omega_t$
	330	Mirror on pivots (first mode)	$< 2 \mu\text{rad}$ excited primarily by contact friction
	1000	Mirror on pivots (second mode)	$\ll 1 \mu\text{rad}$ with $\omega_c = 4 \text{ kHz}$; 10 to 20 μrad with bumper springs in which $\omega_c = 1 \text{ kHz}$
	2200 & Up	Plate frequencies of scan mirror	Strong functions of ω_c but always $< 1 \mu\text{rad}$
$\omega_c = 4000$			Function primarily of spring tip mass and material

REFERENCES

1. Harris, C.M., and Crede, C.E., Shock and Vibration Handbook, Vol. 1, Chapter 8, McGraw-Hill Book., Inc., New York (1961).
2. Chou, P.C. and Flis, W.J., Design Curves for Structural Response Due to Impact Loading, Proceedings AIAA/ASME/SAE 17th Structure, Structural Dynamics, and Materials Conference, King of Prussia, Pennsylvania, (May 5-7, 1976).