

D25

DISPLAY AIDS FOR REMOTE CONTROL OF UNTETHERED UNDERSEA VEHICLES*

W. L. Verplank

Man-Machine Systems Laboratory
Department of Mechanical Engineering
Massachusetts Institute of Technology
Cambridge, Massachusetts 02139

N79-15613

Abstract

A "predictor" display superimposed on slow-scan video or sonar data is proposed as a method to allow better remote manual control of an untethered submersible. Simulation experiments show good control under circumstances which otherwise make control practically impossible.

1. Introduction

Untethered, unmanned submersibles have been limited to automatic control on simple pre-programmed or target-seeking trajectories. More precise navigation and obstacle avoidance will require increasingly sophisticated automatic control and/or direct control from the surface. Direct human control through a sonic communication channel will be difficult because of the low bandwidth and the signal travel time. Probably the most productive approach will be a combination of elementary automatic control such as is possible with some present-day tethered submersibles (e.g., altitude or depth and heading control) plus display aids which make control easier for the operator. This paper proposes a display aid which is particularly applicable to the problems of time-delay and slow frame-rate.

2. The Problem

For remote control, there are two sources of difficulty with sonar communications: time-delay and slow-frame-rate. Round trip time-delay is the time for a command to travel to the vehicle and the first indication of response to travel back. At a minimum this will be two times the distance divided by the speed of propagation, $2T$. For example, $T = 1$ second at about 5,000 feet.

Pictorial information from television camera or obstacle avoidance sonar will be further delayed because of limited channel capacity. Assuming a low resolution picture of 80 K bits and a channel capacity of 10K bits/sec., there would be at most, one picture every 8 seconds ($S = 8$ seconds).

The effects of trying to navigate with just this pictorial information are illustrated in Figure 1.

* This work was supported in part by ONR Contract N00014-77-C-0256. The untethered vehicle control problem was suggested in discussions with the Harbor Branch Foundation and the M.I.T. Office of Sea Grant.

340
MADE INTENTIONALLY BLANK

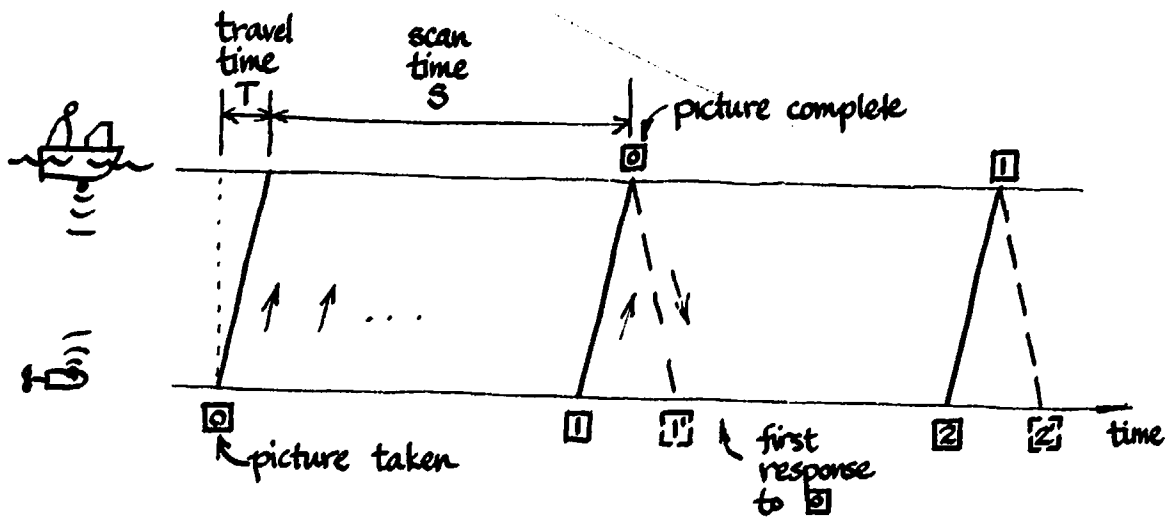

Figure 1a. Effect of delays from transport time (T) and scan time (S).

The picture from 0 is received $T + S$ seconds after it is taken; the first operator response is received by the vehicle at least T seconds later, for a total delay of $2T + S$ seconds. While the operator is looking at the still picture from 0 the commands he is sending are actually moving the vehicle from 1' to 2', as illustrated in Figure 1b.

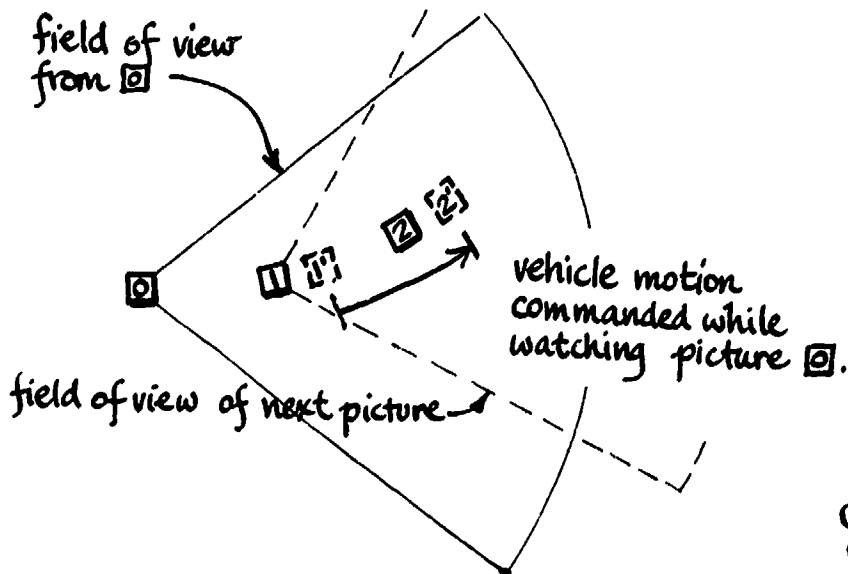

Figure 1b. Positions of vehicle at times in Figure 1a.

ORIGINAL PAGE IS
OF POOR QUALITY

ORIGINAL PAGE IS
OF POOR QUALITY

3. Predictor Display

Predictor displays were first used for submarine control (Kelley, 1968). NASA considered predictor displays for remote control of unmanned lunar roving vehicles (Arnold, 1963) but sent men instead.

The predictor display proposed here presents a symbol superimposed on the slow-frame-rate and time-delayed picture from the vehicle's television camera. The symbol responds instantaneously and continuously to the operator's commands predicting "future" positions of the vehicle. For example, referring to Figure 1b, when \square is complete the predictor symbol would show the position 1'. Before the next picture from \square arrives, the symbol will be moved, in response to the operator's commands, to position 2'.

The position of the vehicle is computed from a local model of the vehicle response and the operator's commands $u(t)$, as shown in Figure 2.

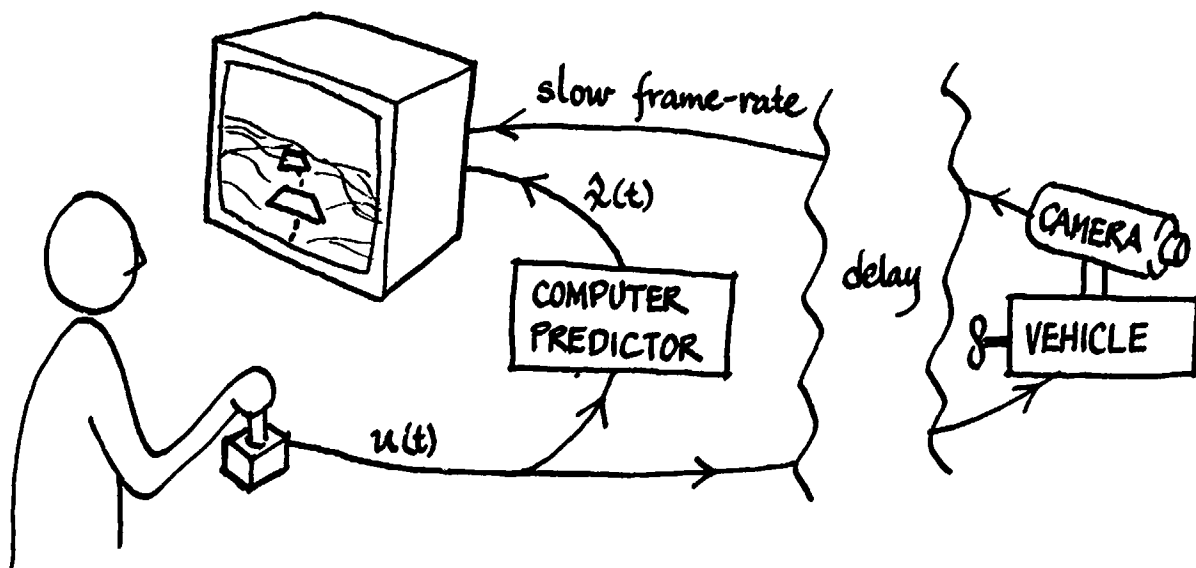

Figure 2. Predictor display superimposed on pictorial data

Pictorial or Map Displays

The predictor symbol may prove useful both on pictorial displays (superimposed on television or obstacle-avoidance sonar) and on map-like position displays. Map displays would avoid one difficulty of pictorial displays, which is losing the predictor symbol when it moves out of the field of view of the camera (for example, moving sideways or backward).

Auxiliary Position Data

If position data is available from transponders or locator beacons, it could be used to update the vehicle model. With just the pictorial data, the open-loop prediction would have to span an interval of (at least) $2T + S$ to (at most) $2T + 2S$ seconds. With auxiliary feedback the open-loop estimate will only need to span the delay of that auxiliary data (at minimum $2T$). The signals and corresponding delays are shown in Figure 3. ($u(\cdot)$, command vector; $x(\cdot)$, vehicle location data).

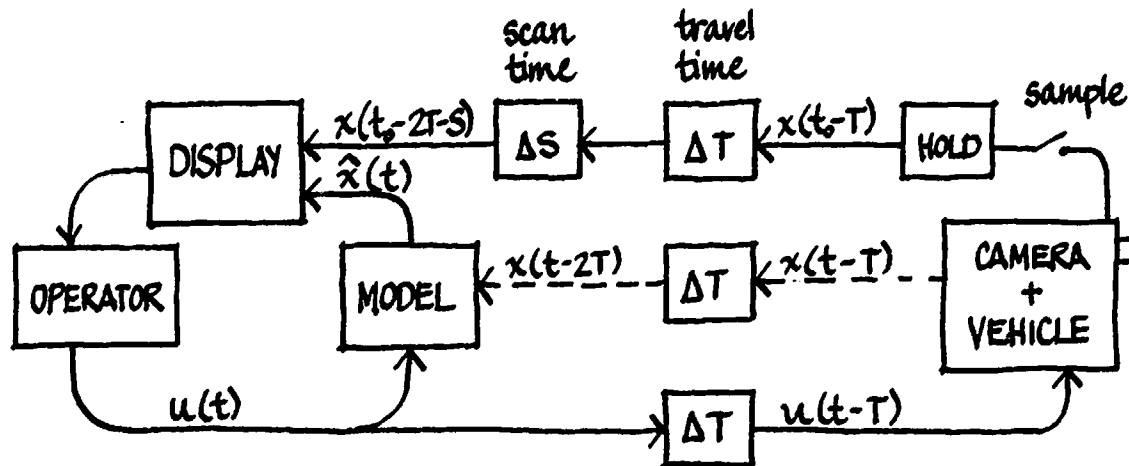

Figure 3. Delays associated with predictor calculation

Adaptive Estimation

Another feature that could be built into the local model of the vehicle is some estimate of the disturbances (such as current). The current model as well as the vehicle model could be updated on the basis of the mismatch between predicted and measured vehicle position.

4. A Demonstration Experiment

In order to explore the effects of the predictor display, an interactive simulation was written on an Interdata 70 computer and Imlac graphic display. A random terrain was generated and displayed in perspective, updated every 8 seconds, to simulate the pictorial information. A moving predictor symbol was generated representing the vehicle as a square in perspective. Two straight ridges were added to the random terrain to serve as a test course. (Figure 4).

ORIGINAL PAGE IS
OF POOR QUALITY

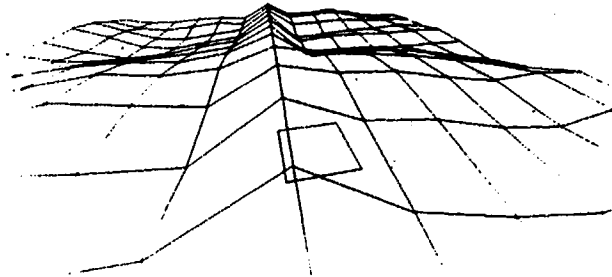

Figure 4. Computer-generated terrain with predictor symbol

The simulated vehicle was controlled by the operator with a spring-centered 2-degree-of-freedom joystick. The dynamic response of the vehicle was simple integration with forward speed proportional to forward-back position of the stick and turn-rate proportional to left-right position of the stick. The vehicle was always the same height above the terrain (simulating automatic altitude hold). No disturbances such as currents were simulated. Also, it was found important to have a good detent and dead-zone on the stick to avoid inadvertent commands.

A stationary "table" was drawn to indicate where the next picture was to come from while the "real-time" predictor continued to move in response to the operator's commands (Figure 5). Dotted lines were added to this table to indicate the field of view. This reduced the considerable confusion about how the picture was expected to change and served as a guide for keeping the vehicle within its own field of view, which is the best strategy for using this kind of predictor on the pictorial display.

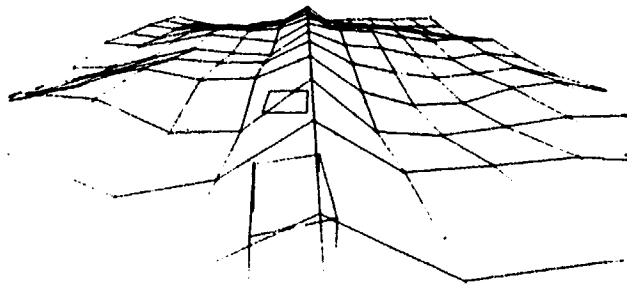

Figure 5. Predictor plus "table" showing from where next picture will come

Results

A typical path, without the predictor, is shown in Figure 6. The dotted lines represent \pm terrain-unit from the ridge. The circles represent the vehicle's position every 2 seconds. V's represent the field of view of each picture sent. Quite often there is no movement between successive dots (2 secs.) or successive pictures (8 seconds.)

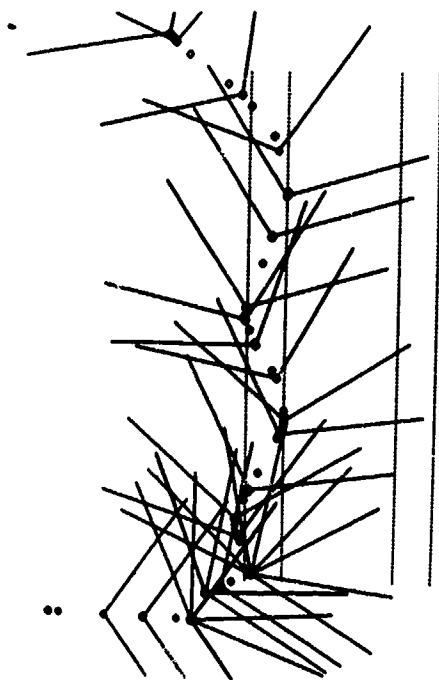

Figure 6. Typical path with no predictor

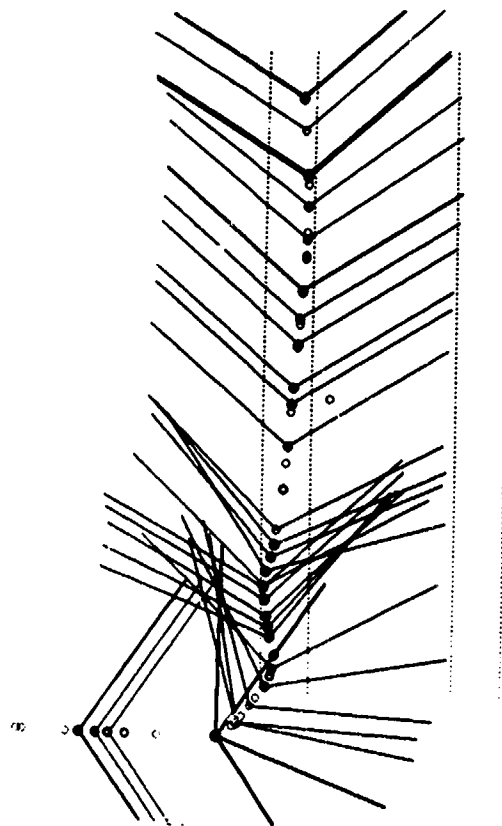

Figure 7. Success at slow speed with no predictor

Only with extremely slow speed was it possible to keep track of the ridge. Approximately five minutes and 40 pictures were required to traverse just one of the ridges (half the course) This is shown in Figure 7.

With the predictor symbol, practically continuous motion was possible. A typical path is shown in Figure 8. The course was completed in 3 minutes and 23 pictures.

ORIGINAL PAGE IS
OF POOR QUALITY

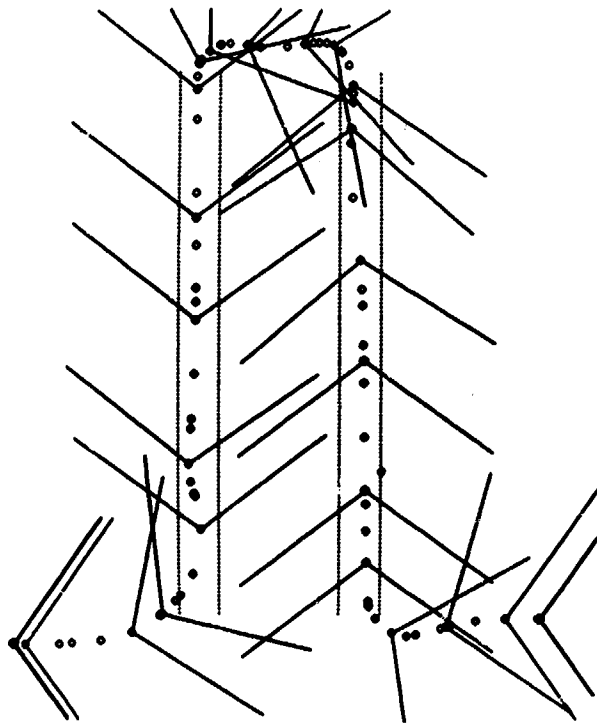

Figure 8. Path with predictor display

Request Mode

One unexpected finding from these experiments was that rather than sending the picture periodically every eight seconds, sending the picture only upon the operator's request reduces the total number of pictures necessary and encourages a "move and wait" strategy which avoids confusion. The difference is illustrated in Figure 9.

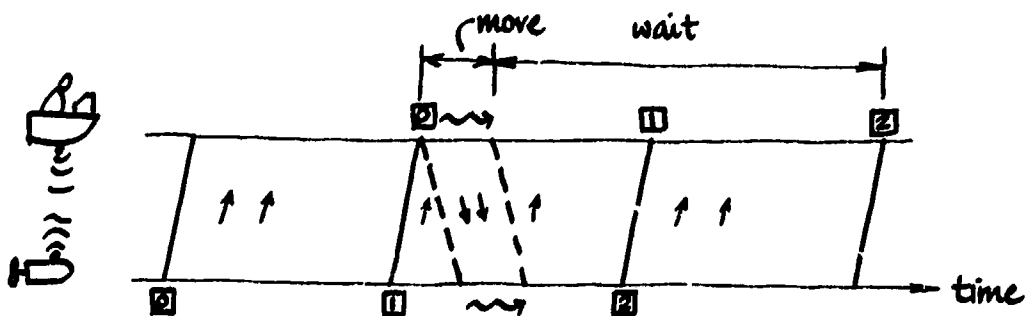

Figure 9a. New picture every 8 seconds: "periodic mode"

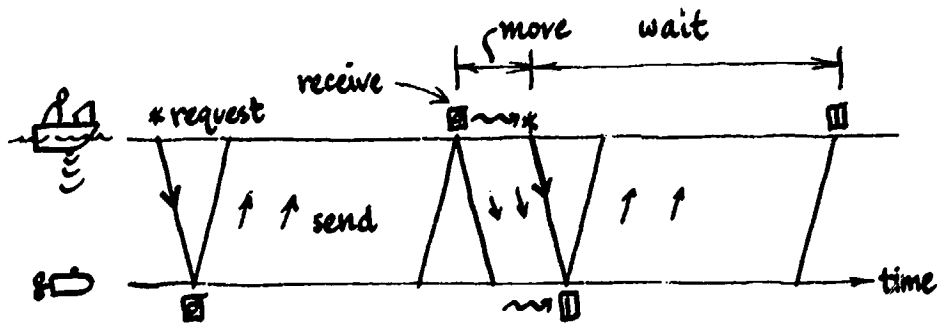

Figure 9b. New picture upon request: "request mode"

In the periodic mode (Figure 9a) a short move starting with the receipt of picture ② will not be reflected in the next picture, ①, as the operator might expect; instead he has to wait for ②. In request mode (Figure 9b), the wait for pictorial confirmation is minimized.

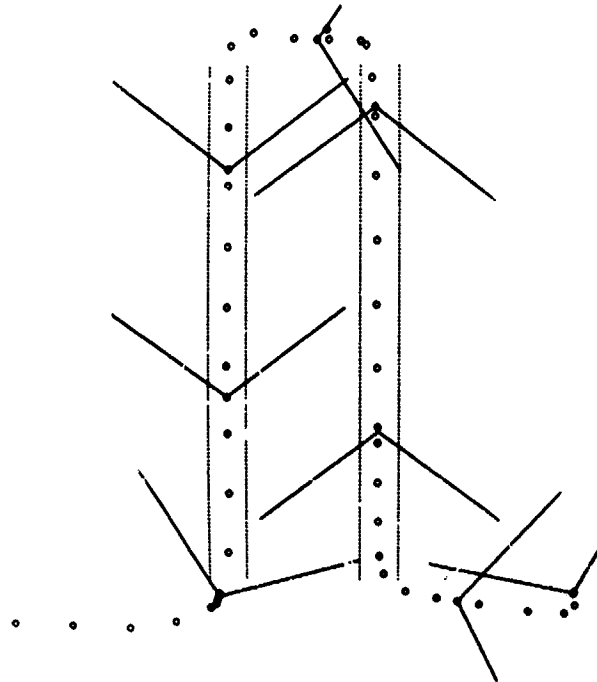

Figure 10. Typical path in the request mode

A typical path in request mode (using the predictor) is shown in Figure 10. Compared to periodic mode, the time is about the same but the number of pictures used is one-half to one-third; velocities are higher but there is a wait for 10 seconds as each picture is taken and sent.

On an actual vehicle, probably both modes should be available with the request mode used when move-and-wait strategy is appropriate (for precise positioning based on pictorial feed-back, and when environmental disturbances are small). Periodic mode is probably more appropriate for less precise navigation and continuous motion when the predictor symbol can be relied upon.

Another trade-off that should probably be built into the pictorial feed-back is variable frame-rate/resolution. In a more dynamic and uncertain environment (i.e., larger bandwidth disturbances or target motion) sampling rate will want to be higher at the expense of resolution.

6. Conclusions and Recommendations

For the conditions studied ($T = 1$ sec., $S = 8$ sec.) manual control is not feasible without display aids such as the predictor symbol. The request mode is preferred as it seems to avoid confusion and reduce the number of pictures necessary.

The present results are at best preliminary. We studied only very simple vehicle dynamics and only one set of delay conditions. Further study with laboratory simulation can investigate:

- 1) more realistic vehicle dynamics,
- 2) environmental uncertainties such as drift,
- 3) a broader range of delay conditions and
- 4) various degrees of partial automation.

Also, the predictor displays (both pictorial and map) could be used on existing tethered vehicles to simulate untethered operation and evaluate the potential for untethered operation.

References

- Kelley, C. R., Manual and Automatic Control, Wiley, New York, 1968.
- Arnold, J. E., and Braisted, P. W., Design and Evaluation of a Predictor for Remote Control Systems Operating with Signal Transmission Delays, NASA TN D2229, 1963.