

77-55

N78-13268

**SOME DEVELOPMENTS IN THE FEEDING OF
COAL TO FLUIDIZED BED COMBUSTORS**

L. G. Caldwell

**Ducon Fluid Transport Division
U. S. Filter Corp.
King of Prussia, Pennsylvania**

ABSTRACT

Currently, there is intense interest and considerable funding for the development of fluid bed combustors for high sulphur coal, using limestone or dolomite in the bed for removal of the sulphur. Operating units to date have proven the inadequacies of available material handling techniques for introduction and control of the coal and adsorbent to the beds. Larger units now being contemplated will pose formidable problems in this area. This paper illustrates and describes some of the techniques which have been developed for the existing pilot units and novel ideas under consideration for future, large production units.

Ducon Fluid Transport, with whom I am associated, is a unit of the U. S. Filter Corporation. We have been engaged in several aspects of the materials handling associated with fluid bed combustors, have provided designs and concepts, and have supplied some equipment in connection with units now being built. Although our prime field of interest is pneumatic conveying, we have developed, or are developing, ideas and devices which in some cases depart from this field.

Firms working in fluid bed combustion have come to us because of certain proprietary hardware which we had developed over many years in other abrasive applications such as mining, petroleum refining, fly ash, etc. The two principal hardware items were the FLUO/veyor pressure tank high density pneumatic conveying system, and the PERMA/flo abrasion-resistant rotary air lock. The former has been used for the high pressure injection of catalysts into fluid bed reactors and the latter for feeding, or as an air lock, in the handling of crushed ores, crushed limestone, and crushed coal in a variety of applications. With the experiences we had with these products, as a starting point, we became involved in fluid bed combustor activities, and we should like to share with you now several of the new ideas we have developed and then to consider a theoretical future utility-sized power generation boiler and to show how our current technology might be applied to the feeding of coal and adsorbent.

The first development is the "stream splitter" (fig. 1). The stream splitter accomplishes the dividing of a single pneumatically conveyed stream of solids into four streams, with each stream 25% of the original, plus or minus a very small tolerance. Experience to date shows that tolerances of less than 1% can be achieved and maintained.

Basically, the stream splitter is a system of branched pipes, with decreasing diameters to control velocity. The branches, however, are sharp tees rather than long radius direction changes, which have been traditional in pneumatic conveying. The use of sharp tees was pioneered by DUCON in catalyst operations many years ago. Properly designed and applied, they perform fully as well as long radius bends.

Figure 2 shows a typical long radius bend. Although the conveying air is presumed to generally follow the curvature of the pipe, we know that the solids follow a straight line path, impinging on a primary, secondary, and sometimes a tertiary point. Incidentally, we are discussing here conveying in the "stream flow" mode (usually referred to as "dilute phase"), and this is an essential requirement for operation of the stream splitter.

In the sharp tee (fig. 3) the approaching stream of material impacts into a pocket and thereafter impinges on itself instead of metal. It makes the direction change with no further impingements, and, surprisingly, with no more pressure drop than the long radius bend.

We experimented with a sharp cross (fig. 4) to see if a stream could be divided equally after a pocket impact and found that the division of flow was very sensitive to the location of the point of impact. We learned that the heaviest flow went to the outlet nearest the point of impact (fig. 5 and 6). Thus, if one could "steer" the approaching stream, one could adjust the split until he had a precise 50-50 division. We accomplished this by the use of flexible pipe joints and a means of changing the pipe geometry and locking its position. We have since added features for thermal expansion.

We found that, once set, the functioning of the device continued without change. In addition, we found that if each of the two legs is again branched, it is possible to achieve a 4-way split with the same close tolerance.

This 4-way splitter was supplied for the San Benito, Texas, fluid bed coal gasifier for the return of fines to the carbon burning cell. It is being designed into several other units on the drawing boards. Although we have not yet done the testing, we believe that the device can be further split into 8 and possibly 16 outlets with good results. The limitation would be that with

decreasing pipe diameter one will reach a point where no further reduction is possible (at about 3 times the diameter of the largest coal particle). We have been highly successful with this device on a 2:1 mixture of 1/4" coal and 1/8" limestone with surface moisture approaching 10%.

The second idea we should like to describe is a coal or coal/limestone feeder capable of introducing a continuous, precisely metered stream into a high pressure combustor or reactor. Fig. 7 shows the arrangement of one version using 2 pressure tanks side by side. These tanks are not simply lock hoppers which dump a charge into the combustor, but each is equipped with a rotary feeder driven by a controllable speed drive responsive to the demands of the process. Since the rotary feeder is completely housed in the pressure envelope, it feels no pressure differential across it. Its drive shaft is brought out through the envelope. Since this feeder must resist abrasion and be totally dependable, it would be well to look more closely at its construction. Fig. 8 is the PERMA/flo feeder as used for many years in highly abrasive applications. Fig. 9 shows a simplified section through the unit where we see the rotor and shoe construction. These two parts are of cast alloy iron with extremely high hardness and arranged so that they can be simply adjusted to one another without disassembly, to compensate for wear. We have taken these two essential parts and a number of others from the PERMA/flo air lock and integrated them into the bottom of a pressure tank.

Our experience over many years with our FLUO/vey r pressure tank conveying system has given us the necessary background to integrate the tank, the appropriate valving, controls, and weighing system into this arrangement that you see.

One tank is always discharging. Its discharge rate is controlled by the demands of the process. The tank is on load cells and we employ a "loss of weight" electronic weighing system which seeks the precise scale discharge rate which the process requires.

The other tank is filling from the atmospheric feed hopper above. When the tank is full, the material cut off valve is closed, the pressure seal valve is closed, and the line from the process vessel is opened to bring the pressure into balance with it. When the first tank is low, but not empty, its bottom discharge valve will be shut and its rotary reeder stopped and at the same instant the bottom discharge valve of the second tank will be opened and its feeder will start. Control of feed will transfer to the second tank.

Before the first tank can be refilled, its vent line must be opened to a dust collector and its pressure reduced to atmospheric. The cycle repeats.

It is possible to accomplish the same result with two pressure tanks, one above the other. In such an arrangement only the lower tank would have the rotary feeder and it would operate continuously. Only the lower tank would be mounted on a "loss of weight" scale. The upper tank would be a pressure vessel which is used to lock in a volumetrically measured batch whenever the lower tank is near empty and needs refilling. The weighing system we would use has a feature whereby the process feed rate is temporarily frozen during the approximately 1/4 minute that the lower tank is being refilled.

This system has been offered for a fluid bed gasifier being used to drive a gas turbine. The gasifier pressure is 90 PSIG.

The third development in which we are engaged is what we might call a "pulsed chute" feeder for fluid bed combustors (fig. 10). Assuming a regulated feed of coal/limestone mixture to the vicinity of the cell, we direct the feed into a small surge hopper which feeds an inclined pipe which terminates, after passing through the cell wall, in the fluid bed. The angle and diameter of the pipe are such that the pipe will remain choked with material, which will not flow without aid. Aid is provided in the form of one or more air ejectors through which bursts of high pressure air of extremely short duration and controllable frequency are discharged. Each air pulse discharges almost flat along the surface of the inner pipe wall and completely around the periphery,

surrounding the column of solids with a friction-breaking film of air for an instant. The column moves for a short distance downward. The rate of downward movement of the column is established by the duration and frequency of the air pulses, both of which are electronically controlled. Control of column movement is in response to the material level condition in the surge hopper. High and low level controls or a continuous electronic level control are used to provide the signals to the control system which are converted to the compressed air pulses.

We should like now to propose the possible feeding equipment requirements for a projected 600 megawatt utility sized, fluidized bed boiler such as is currently being studied. We have been asked to consider several possible configurations, but we shall consider one which, it is proposed, would have 35 cells, 7 cells long by 5 cells high (fig. 11). Each cell would be 12 feet wide by 18 feet long. We have been asked to provide for 24 feed pipes for a coal/limestone mixture and it is proposed that half of them feed mixture above the diffuser plate and half of them feed mixture through the diffuser plate from below (fig. 12). Each cell would require a maximum of approximately 11 tons per hour of mixture, made up of approximately 7 tons per hour of coal and 4 tons per hour of limestone.

We propose that at each end of each cell we provide 6 feed pipes from above and 6 feed pipes from below. We propose that each group of 6 pipes be fed from its own surge hopper grouping. For the 6 feeding above the diffuser plate we would use "pulsed chutes" as previously described and these would require 6 surge hoppers with level controls and the associated electricals. For the 6 feeding from below the diffuser, we propose the same except that they would terminate in 6 upwardly inclined pipes which pneumatically convey the feed material into the bed with air provided by small blowers.

We propose that each group of 6 surge hoppers in fact be a single 6 compartment circular hopper (fig. 13), which receives a regulated stream of mixture from a disengaging chamber and distributes it uniformly among the 6 compartments by means of a rotary distributor spout.

For each cell, therefore, there would be 4 disengaging chambers, each receiving 1/4 of the cell feed requirement.

The prepared mixture would be pneumatically conveyed from ground level, in the area of the coal and limestone bunkers, and would be lifted through a single pipeline to the elevation of the cell it is to feed (fig. 14). Using our "stream splitter" we would produce 4 streams to the disengaging chambers, each of which would be 1/4 of the total feed.

It is our belief that control requirements will dictate the need for a separate weighing, proportioning, and mixing unit for each cell. Such a unit might look like fig. 15. Individual bunkers would be provided for coal and limestone. Under each bunker a feed gate would control the flow of material into a scale hopper below. The scale hopper would be refilled whenever it was nearly empty, but would never be permitted to completely empty. A feeder under each scale, with controllable speed drive, would establish the solids feed rate required for the cell. The coal rate would be determined by boiler load and the limestone rate by stack gas composition. The scales would be "loss of weight" electronic with feed rate frozen momentarily during re-filling.

The coal feeder would be a rotary and the limestone feeder a screw, in order to bring both discharging streams close together for feed into a ribbon blender. The ribbon blender would be relatively short, only long enough to provide the desired coal/limestone blending. The discharge of the blender would be into an abrasion-resistant rotary air lock and thence into the conveying pipeline.

Since the arrangement proposed would require separate bunkers for each cell, we have considered what the bunker layout might be (fig. 16). We show an area 90 feet by 114 feet and a configuration under which the previously described weighing, proportioning, and mixing units would be arranged and the 35 pneumatic conveying systems would originate.

The selection of equipment and systems shown here takes into account the critical importance of reliable, uninterrupted feed, minimizing segregation of the mixture components, minimizing attrition of the coal, and minimizing wear of equipment.

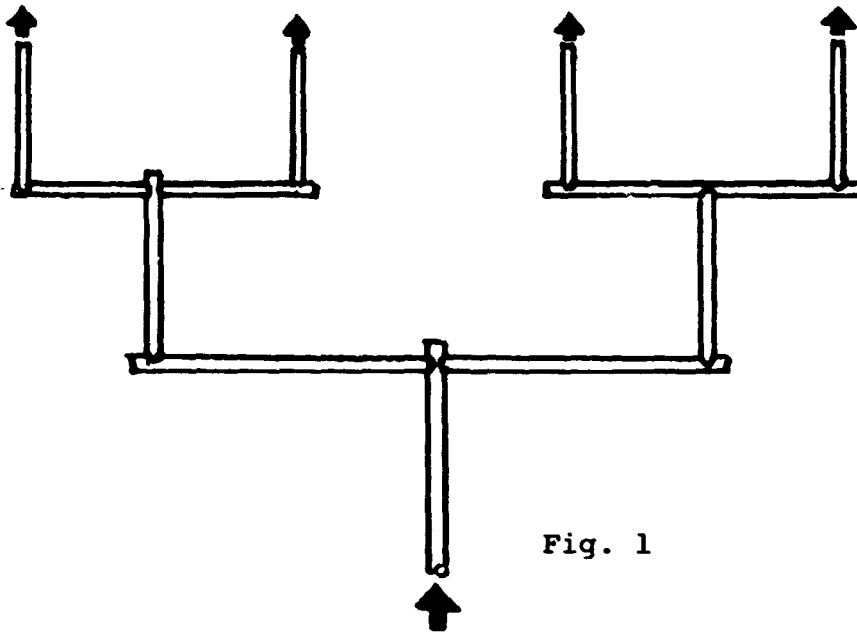

Fig. 1

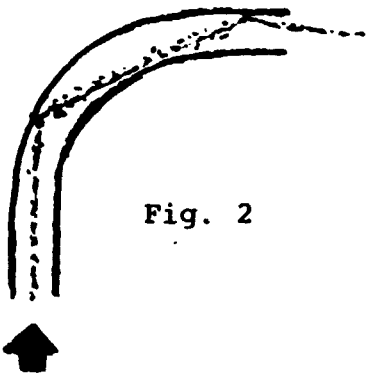

Fig. 2

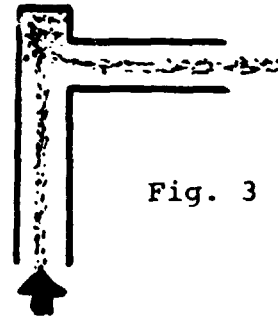

Fig. 3

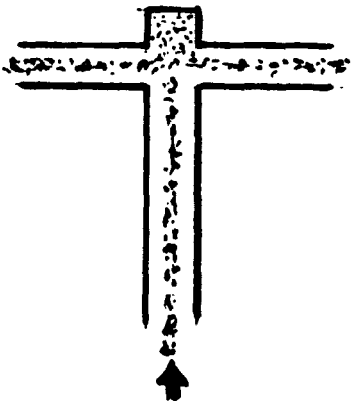

Fig. 4

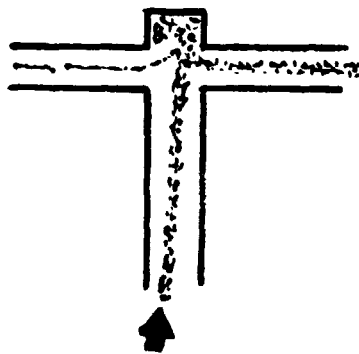

Fig. 5
665

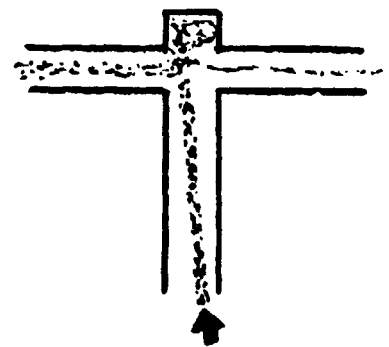

Fig. 6

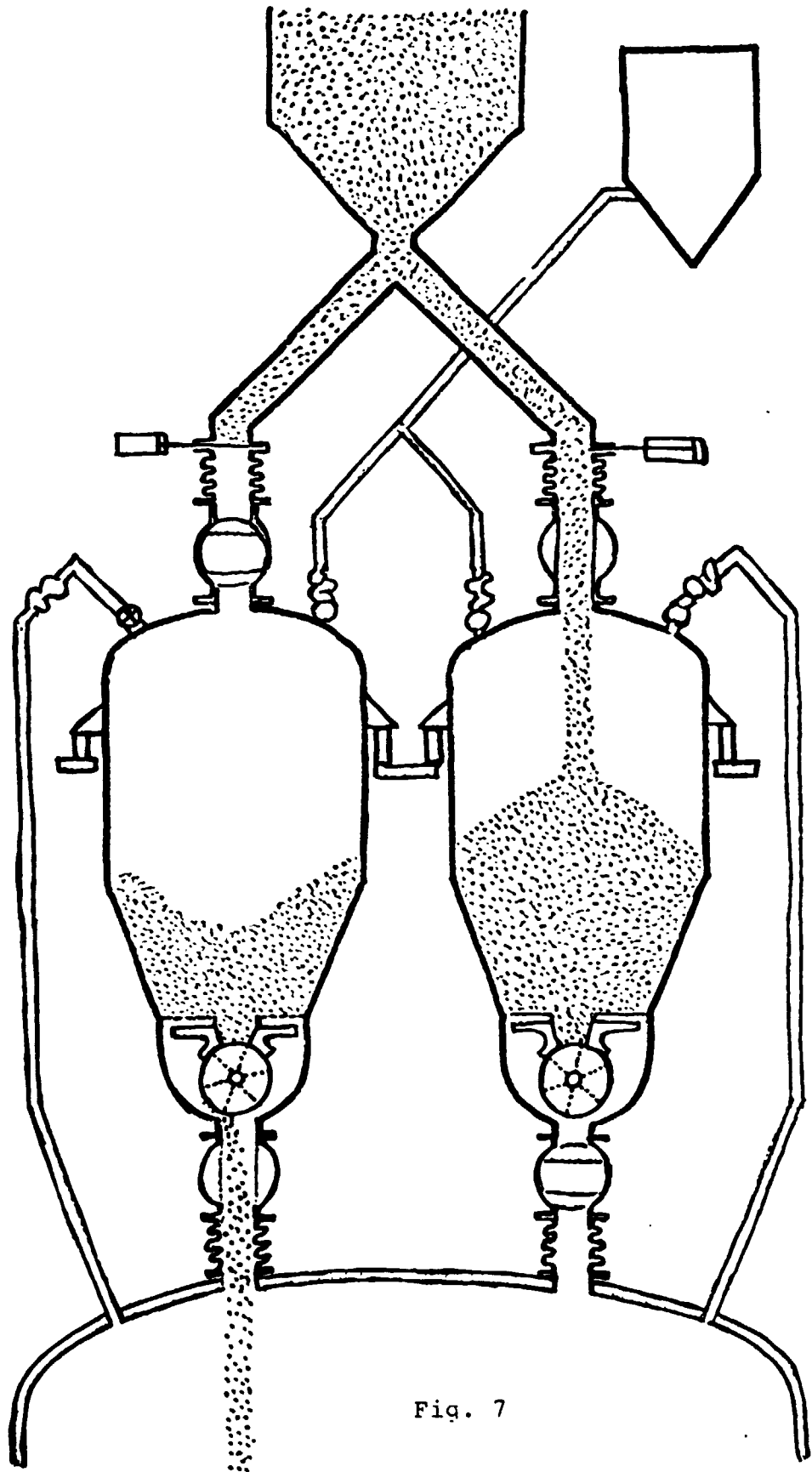

Fig. 7

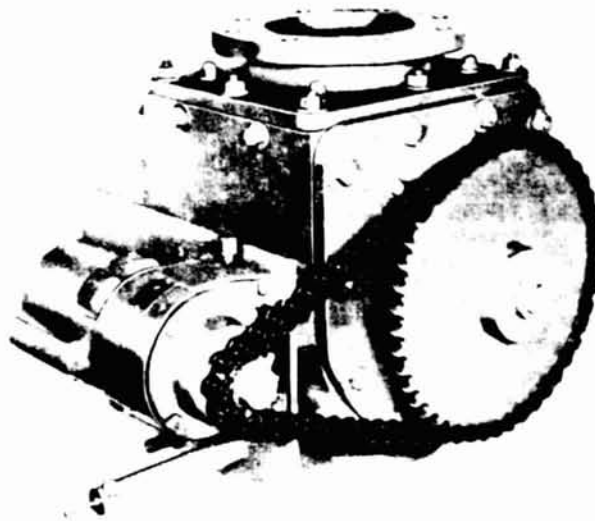

Fig. 8

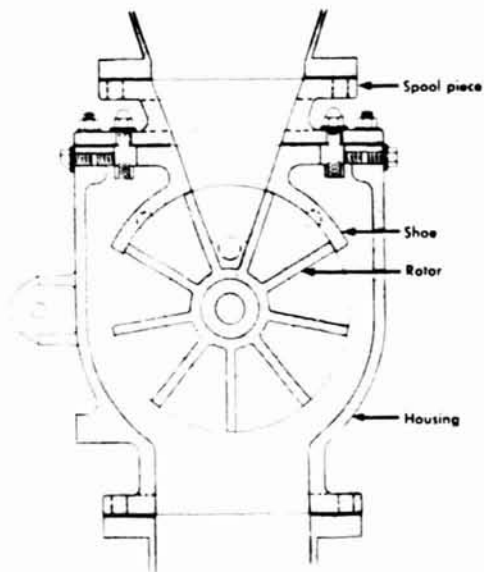

Fig. 9

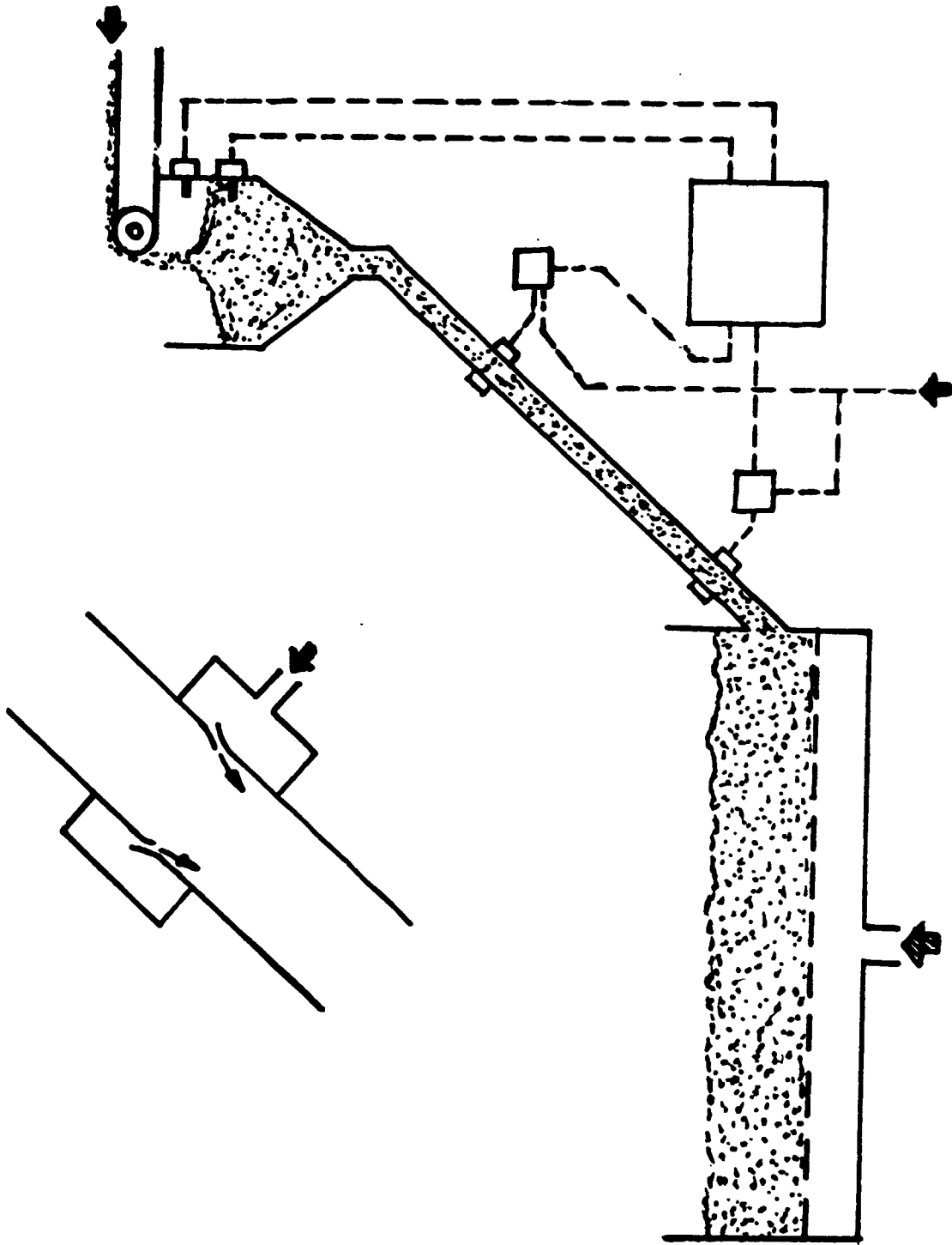

Fig. 10

77-55

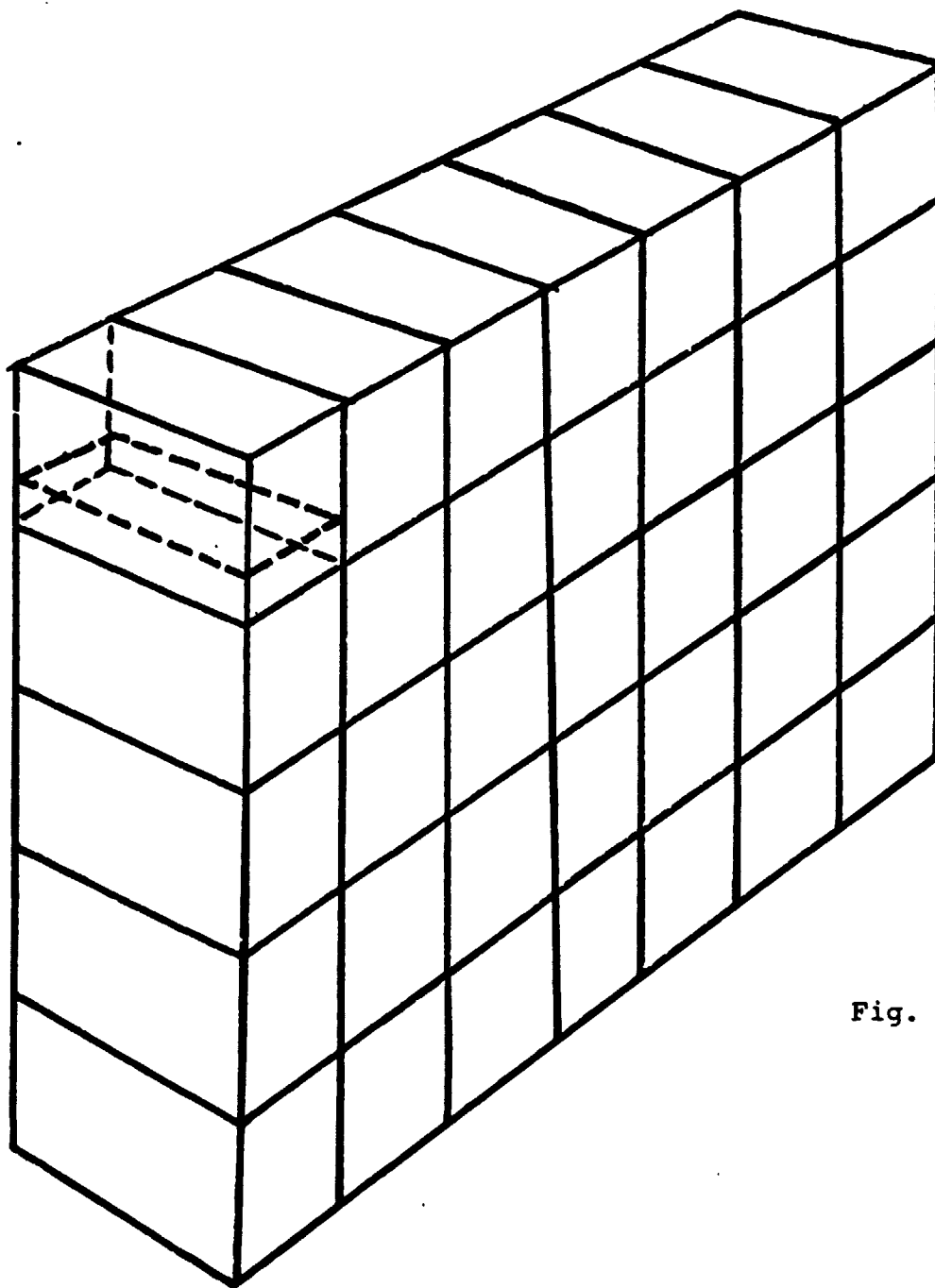

Fig. 11

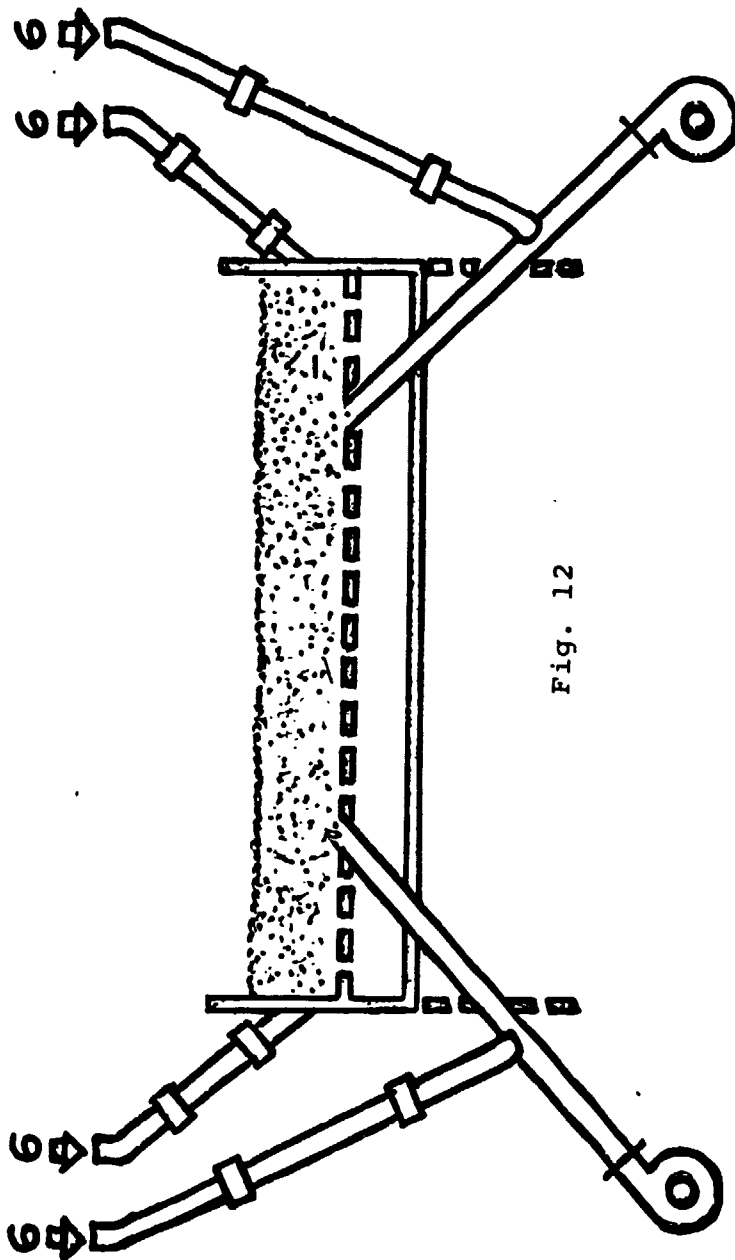

Fig. 12

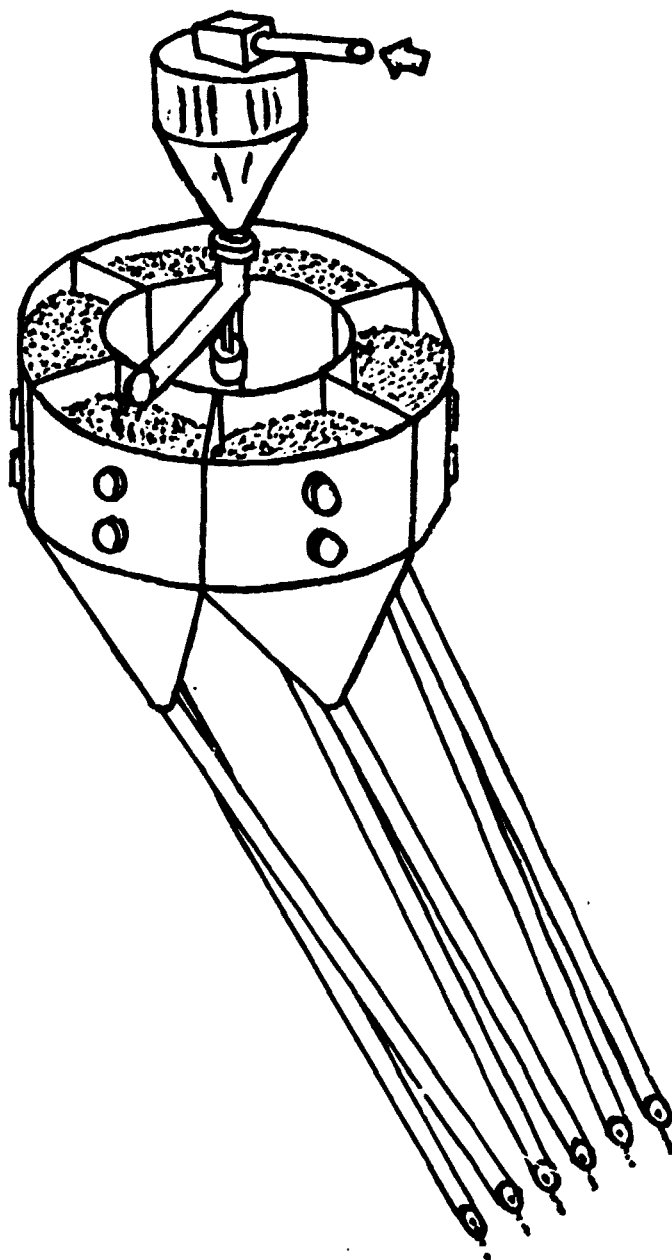

Fig. 13

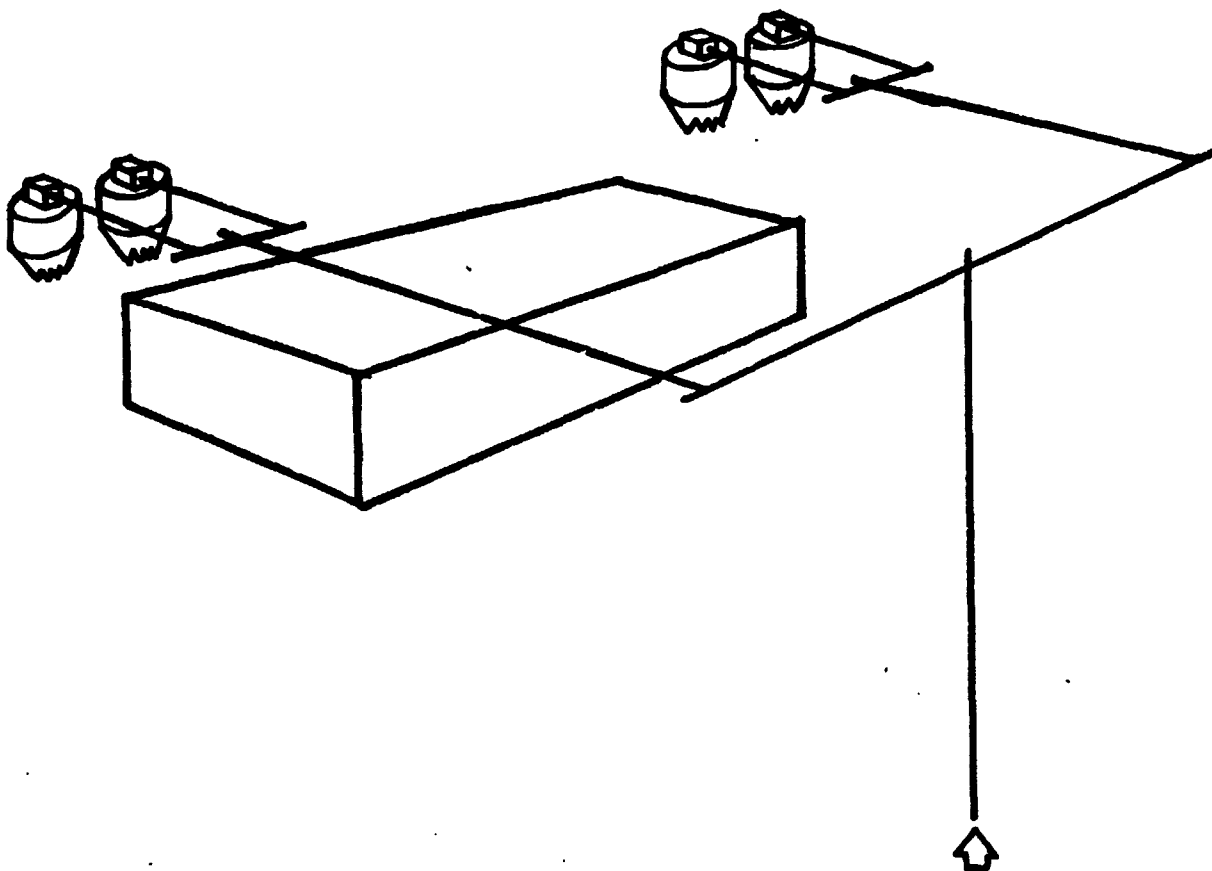

Fig. 14

77-55

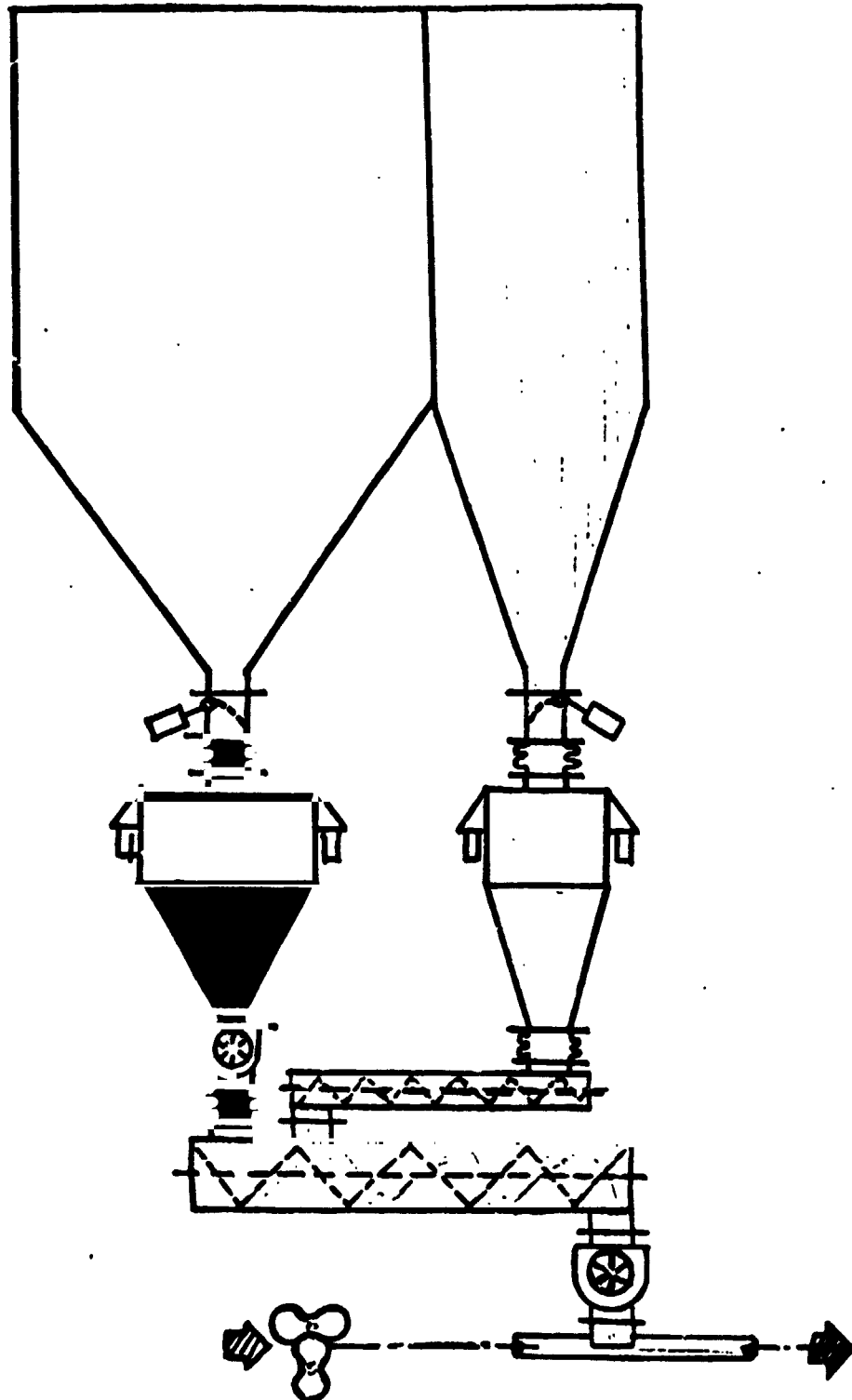

Fig. 15

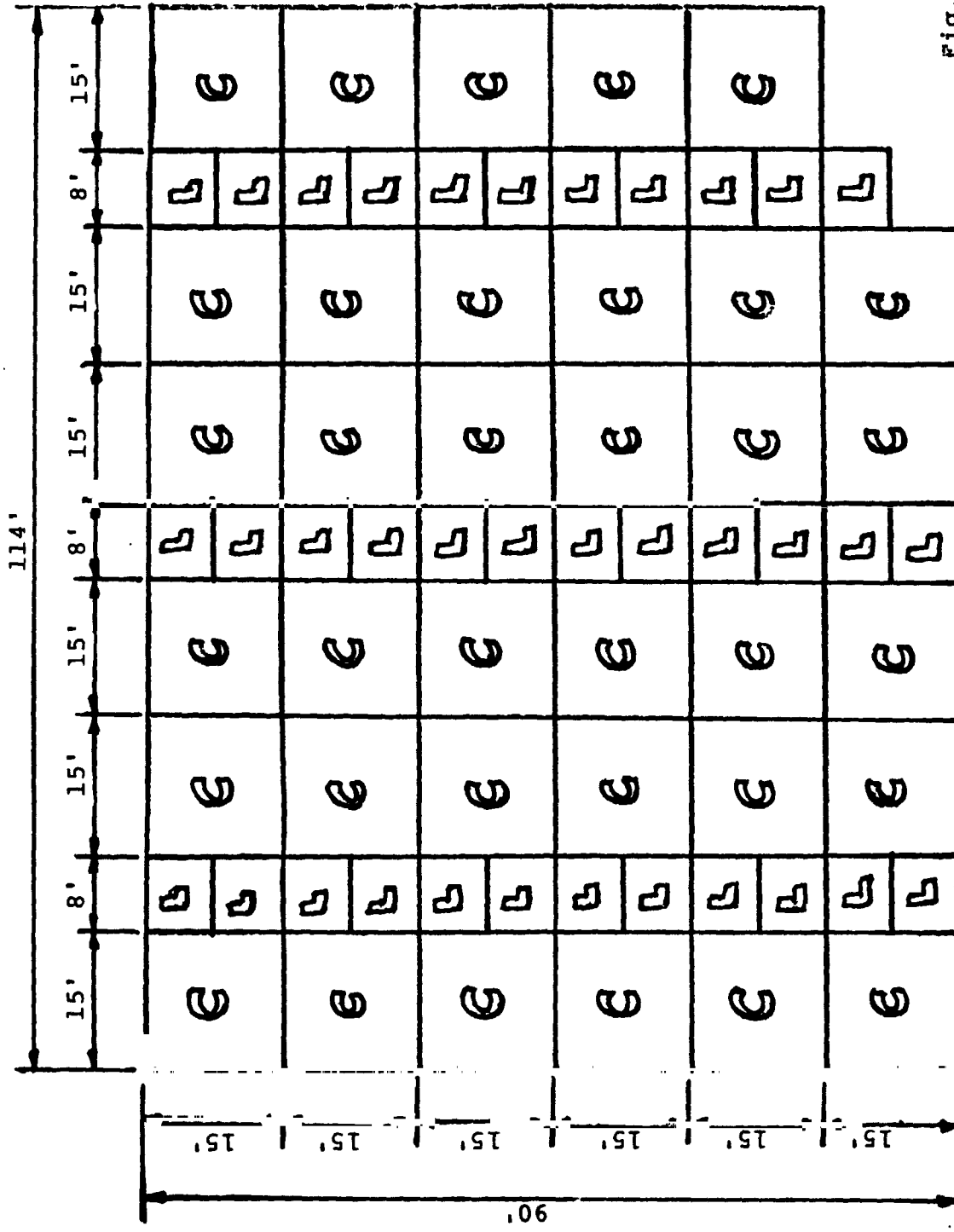

Fig. 16