

XIV. STRATOSPHERIC CRUISE EMISSION REDUCTION PROGRAM

Larry A. Diehl, Gregory M. Reck, Cecil J. Marek,
and Andrew J. Szaniszlo

National Aeronautics and Space Administration
Lewis Research Center

Previous papers focused on programs whose objectives were to develop technology to satisfy the Environmental Protection Agency (EPA) requirements to reduce aircraft pollution in the vicinity of airports. This paper discusses a recently implemented NASA effort called the Stratospheric Cruise Emission Reduction Program (SCERP). This program is specifically aimed at reducing cruise oxides of nitrogen from high-altitude aircraft.

The scope of this paper is as follows: First, the desired emission levels and the combustor technology that will be required to achieve them are discussed. Second, a brief overview of the SCERP operating plan is given. Next, lean premixed-prevaporized combustion and some of the potential difficulties that are associated with applying this technique to gas turbine combustors are examined. The first program phase of SCERP is then discussed in more detail. The objective of this first phase is to develop base technology in several key areas. These fundamental studies are viewed as a requirement for successful implementation of the lean premixed combustion technique.

Recent studies of the potential adverse impact of aircraft exhaust emissions have concluded that flights of high-altitude cruise aircraft could alter the stratospheric ozone concentration. These studies recommend that major reductions in the oxides of nitrogen (NO_x) be sought in future gas turbine engines for both subsonic and supersonic flight. For current-technology, subsonic, high-pressure-ratio engines, the Climatic Impact Assessment Program recommendation of a reduction to 1/6 to 1/10 of current levels would result in a desired cruise NO_x emission index of 2 to 3.

The National Academy of Science recommended reduction to 1/10 to 1/20 of current levels would result in an emission index of 1 to 2. Achieving these levels will require major modifications to conventional combustion systems. Of course, any new technology would have to satisfy EPA requirements for the landing/takeoff (LTO) cycle.

In assessing how to approach this problem, the designer has various types of combustion technology available to him. Figure XIV-1 shows NO_x emission level forecasts made for various combustion techniques. The conventional-technology emission index level of 20 represents a hypothetical 30:1-pressure-ratio engine at Mach 0.85 cruise at 35 000-foot altitude. All of the values shown are extrapolations from either rig test or engine test conditions. The extrapolations were made to the proper values of combustor pressure and temperature consistent with the hypothetical engine.

The application of clean combustor technology could reduce projected subsonic cruise NO_x emissions by a factor of 1/2 to 2/3. Achieving the recommended levels will require implementation of forced-circulation, lean premixing-prevaporizing, or catalytic combustion techniques. Forced-circulation technology incorporates elements of premixed-prevaporized combustion and flame stabilization provided by an intense recirculation zone. These concepts are being developed under contract to NASA by Solar Division of International Harvester and are discussed in more detail in a subsequent paper. Of these latter three techniques the forced-circulation technology is furthest along in the process of converting fundamentals to combustor hardware, but it also offers the least gains.

The emission levels shown for lean premixing-prevaporizing and catalytic devices in figure XIV-1 have been achieved only in flame-tube rigs. The actual achievable levels may be somewhat different when these emission control techniques are developed into operational engine hardware. Trade-offs between emissions, performance, altitude relight capability, durability, maintainability, and complexity are yet to be evaluated. The influence of the actual engine environment as opposed to the carefully controlled rig experiments will also have to be considered.

Similar projections can be made for supersonic cruise emissions as shown in figure XIV-2. In this case the projected values were based on an advanced-cycle study engine operating at Mach 2.32 cruise at 52 000-foot altitude. The engine is a duct-burning turbofan design. Projected emissions

have been presented for both the core and the total engine to indicate the controlling effect the core emissions play on the overall engine level. This is a result of the advanced-cycle engine having very severe core combustor inlet and outlet conditions from an NO_x formation point of view. On the other hand, the duct-burner inlet pressure and temperature are comparatively low. When conventional technology is applied to this cycle, an overall emission index of 60 can be expected. Recommended reductions to 1/6 to 1/20 of the current Concorde emissions would result in an emission index level of 1 to 3. Note that the application of clean combustor technology would be required just to maintain emission levels near their current value. Reductions to 1/6 or less of current levels will definitely require application of premixed-prevaporized or catalytic combustion. At present the Stratospheric Cruise Emission Reduction Program is pursuing lean premixed-prevaporized combustion for emission reduction. While this technique does not offer the reduction potential of the catalyst, the practical problems associated with its application are less severe. In general, all of the problem areas associated with premixed combustion also apply to the catalytic technique. In addition, there would be considerations of materials, degradation of catalyst activity with time, and catalyst poisoning.

The program plan for SCERP, shown in figure XIV-3, is broken into four successive phases culminating in engine testing. The activities associated with the latter three phases of the program closely parallel the structure of the Experimental Clean Combustor Program. The phase II activity, consisting of a competitive procurement with the large engine manufacturers, is scheduled for award early in 1979. Because of the risk and overall level of complexity associated with the adaptation of lean premixed combustion and because of the meager amount of data that exists in several key areas, an initial phase called concept assessment has been added.

The initial portion of phase I will consist of a number of fundamental studies. Both experimental and analytical efforts will be explored to help establish design criteria for lean premixing-prevaporizing combustors. Currently, we have under way, or planned, six contracted efforts with United Technologies Research Center, General Applied Science Laboratories, Solar Division of International Harvester, and others yet to be determined. Additional activities are planned for next year. Grants with the University

of California at Berkeley, MIT, Cornell, and Michigan support the NASA lean combustion efforts. Numerous in-house programs are also involved. Appropriate combustor conceptual designs will be formulated later in phase I. The probability for achieving the program goals must be assessed for each concept. An important consideration at the end of phase I is the potential of the various designs for application in existing engines. Whether the concept, or concepts, required to achieve the emission level goals can be adapted to an existing engine with reasonable modifications must be determined. If so, then as shown in figure XIV-3, in phase II a number of variations of each concept will be experimentally screened to identify the most promising. These designs will then be further developed in phase III to optimize off-design performance. The best design will be selected for full-scale engine verification in phase IV. If, however, it is concluded that the required concept cannot be adapted to an existing engine, the engine test phase will be abandoned. The candidate combustors will then be screened and developed to optimize emissions performance, and the best design will be used to define the characteristics of a compatible engine.

As noted by the schedule, efforts in phase I are not very far along. The earliest contracted and in-house projects are just entering their experimental test phases. The data presented in this paper are earlier data that were used to help formulate the approach SCERP is taking. This paper is directed toward giving the reader a better understanding of what NASA views as the key problem areas associated with premixed combustion.

In summary then, the objective of the SCERP program is to establish and demonstrate the technology necessary to make an environmentally acceptable aircraft over its entire operating regime. The emphasis in this program is on reduction of cruise NO_x emissions. To accomplish this objective, it will be necessary to achieve a minimum reduction to 1/6 to 1/10 of current levels in subsonic cruise NO_x . At the same time, it will be necessary to meet or exceed EPA standards for the LTO cycle.

LEAN PREMIXED-PREVAPORIZED COMBUSTION

The most significant factor in determining NO_x emissions is the flame temperature in the reaction zone, as illustrated in figure XIV-4. The curve

shown is derived from a well-stirred reactor model developed by the General Applied Science Laboratories. This model simulates a premixed situation since it assumes that the reactants are well stirred and that the combustion process is reaction rate limited. The data were obtained in premixed flame-tube experiments at the Lewis Research Center. These data as well as data from other experiments indicate that NO_x emissions vary exponentially with flame temperature.

This effect can be used to control NO_x emissions by reducing the combustion zone equivalence ratio, which lowers the flame temperature. The figure indicates that in a fundamental flame-tube experiment, emission index levels below 3 can be achieved. However, the combustor must be operated over a relatively narrow temperature range above the lean blowout limit but low enough for acceptable NO_x emissions.

An important factor in applying the technique of flame temperature control to aircraft engines is the wide range of operating conditions that the combustor experiences. In a conventional combustor as shown in figure XIV-5, the geometry is fixed so that only approximately 30 percent of the combustor airflow passes through the dome of the combustor and into the combustion zone. Consequently, as the fuel flow is increased, the equivalence ratio in the combustion zone also increases. Figure XIV-6 shows that the combustion zone equivalence ratio for a fixed-geometry combustor increases from 0.5 to over stoichiometric as the engine power level increases from idle to takeoff thrust. Also shown in the figure is the range of equivalence ratios that are required to achieve an NO_x emission index below the SCERP goal. The required equivalence ratios are between 0.5 and 0.6 except near the idle condition, where the low inlet temperature and pressure allow higher equivalence ratios. It is apparent that the fixed-geometry combustor exceeds the required range over much of the power spectrum. A potential solution to this problem is the application of variable geometry to control the combustion zone conditions.

In the second concept shown in figure XIV-5, a variable-geometry device is used to regulate the combustion zone airflow. Figure XIV-7 compares the percentage of airflow passing through the combustion zone of a fixed-geometry combustor with the range of airflow needed to maintain the combustion zone equivalence ratio in the required range for low NO_x emissions. To achieve the desired NO_x reduction, the variable geometry must

divert from 30 to 60 percent of the total airflow into the combustion zone. The use of variable geometry over this range represents an increase in combustor complexity; however, it will likely be a requirement for the application of lean combustion to reduce NO_x emissions.

Reducing the combustion zone equivalence ratio alone may not result in the lowest possible NO_x emissions unless several other factors indicated in table XIV-1 are considered. Since the local flame temperature is the most significant factor in controlling NO_x production, the fuel and air must be uniformly premixed throughout the combustion zone to avoid locally rich pockets of fuel and air. NO_x emissions vary exponentially with flame temperature, so locally hot regions could produce disproportionate increases in NO_x concentration. In addition, it may be necessary to prevaporize the fuel. Large fuel droplets in the combustion zone are consumed by a diffusion flame that surrounds the evaporating droplets. This process takes place at near-stoichiometric conditions, and the high temperatures can produce excessive NO_x emissions. Thus, combustors with provisions to prevaporize the fuel and premix the fuel and air may be necessary to realize the full NO_x reduction potential of the lean-burning technique.

Before lean premixed-prevaporized combustors can be applied to aircraft engines, more information is needed in a number of potential problem areas, as indicated in table XIV-2. More data are needed on the effects of such factors as flameholder geometry and operating conditions on NO_x formation. Lean stability and altitude relight capability need special attention with these systems. Techniques for augmenting lean stability may be necessary to provide adequate operating margins. More information is needed on techniques for predicting and achieving the required fuel distribution and vaporization. Autoignition and flashback data are needed over the range of engine conditions, including transients. Combustor inlet airflow characteristics must be known to assure uniform fuel-air distributions. Engine transient characteristics must be identified and studied to avoid incipient autoignition or flashback. And finally, practical schemes for varying the combustor geometry and controlling the operation of the combustion system must be studied.

Many of these problem areas represent formidable obstacles to the application of lean premixing combustors. These combustors will be considerably more complex than conventional combustors and represent a high

development risk in terms of success. However, it does appear that a significant departure from conventional combustor design will be necessary if cruise emissions goals are to be achieved.

As a convenience for organizing these problem areas in the first phase of the SCERP activity, they have been grouped into the four elements shown in table XIV-2: lean combustion, fuel-air preparation, autoignition and flashback, and engine interfaces. Again, the objective of the first phase of SCERP is to provide a data base and design criteria to develop and assess lean premixing-prevaporizing combustors. The phase I elements will now be discussed in more detail.

PHASE I PROGRAM ELEMENTS

Lean Combustion

Minimum NO_x levels. - The low levels of nitrogen oxide emissions obtainable by premixing and prevaporizing were demonstrated in a simple flame-tube apparatus, as illustrated in figure XIV-8. A single pressure-atomizing nozzle, spraying upstream, was placed 24 inches upstream of a 75-percent-blockage, perforated-plate flameholder. The vaporization mixer passage was 24 inches long, which provided sufficient time for complete vaporization. A single-port, traversing gas-sample probe that could move axially, radially, and circumferentially was used to measure the emission levels. The initial fuel distribution was determined to be uniform at the flameholder.

Representative emission levels obtained in such an experiment are shown in figure XIV-9. The upper figure shows the combustion efficiency versus axial distance along the centerline of the combustor. Also shown as an abscissa is the combustor mean residence time at these conditions. The lower figure shows the NO_x emission index, with both NO and NO₂ added together. The combustion efficiency rises rapidly; at a distance of 4.5 inches from the plate or at a residence time of 2 milliseconds, over 99.9-percent combustion efficiency is obtained. At this point, the NO_x emission index is 0.6 g NO₂/kg fuel. At the lean equivalence ratio of 0.48, the NO_x increases slowly with time so that increasing the residence time to 3 milliseconds would increase the NO_x only 16 percent.

The NO_x and CO emissions are shown as a function of equivalence ratio in figure XIV-10 for a 2-millisecond residence time. NO_x levels as low as 0.3 g NO_2 /kg fuel are achieved at an equivalence ratio of 0.4 with greater than 99-percent combustion efficiency. However, this equivalence ratio is very close to blowout. (For carbon monoxide, an emission index of 42.5 represents an inefficiency of 1 percent.) Also shown on the CO figure are the thermodynamic levels of carbon monoxide in equilibrium with combustion products. Below an equivalence ratio of 0.5, the CO emission rose rapidly as the equivalence ratio was decreased. Above 0.5, the CO levels approach equilibrium values. Carbon monoxide levels below equilibrium values are achieved in a combustor by secondary dilution. The minimum CO level achieved in the simple flame-tube experiment was 1.5 g CO/kg fuel at 980° F.

The NO_x emissions agreed well with the well-stirred reactor predictions computed for 2-millisecond residence time. Above an equivalence ratio of 0.57, autoignition occurred in the premixing duct. It was deduced to be autoignition rather than flashback because the premixing passage temperature would suddenly increase during a startup cycle without the ignitor on or the combustor burning when the fuel flow exceeded an equivalence ratio of 0.57.

The operating range for this premixing-prevaporizing combustor is narrow, from the blowout condition of 0.37 to the autoignition point of 0.57. Techniques for lowering the equivalence ratio at lean blowout are discussed later in this paper. Autoignition occurred because the residence time in the vaporization passage was too long in this experiment.

In the lean combustion element, it has been shown that low NO_x levels are possible with good combustion efficiency at a pressure of 5.5 atmospheres in a simple flame-tube apparatus. But to utilize the concept in a practical combustor, it is necessary to know the effects of operating pressure, as well as flameholder geometry. Data are needed on methods for reducing the equivalence ratio at lean blowout. In addition, it is necessary to know the effects of fuel-air nonuniformities.

Pressure effect on NO_x emissions. - Engine compressor ratio, or the resulting combustor inlet pressure, has been found to affect the NO_x formation rate. The theoretical NO_x emission index variation with respect to combustor inlet pressure is shown in figure XIV-11 for Jet A. The residence time used in well-stirred-reactor model calculations is 2 milliseconds,

which can be considered typical for gas turbine combustion chambers. For an equivalence ratio of 0.7, the NO_x emission index increases approximately with the square root of pressure. For a leaner equivalence ratio of 0.5, NO_x level increases with pressure to only the 0.12 power. Furthermore, at 30 atmospheres, the theoretical NO_x emission index for an equivalence ratio of 0.5 is only 4 percent of the index for an equivalence ratio of 0.7. As can be seen, not only are the theoretical NO_x emission levels lower at the lean equivalence ratio of 0.5, but so is the rate of change with respect to pressure. Consequently, this behavior at lean equivalence ratios demonstrates the possibility of achieving the low NO_x goal for the lean, premixing-prevaporizing combustor operating at high pressure ratios.

Figure XIV-12 compares the prediction from the well-stirred-reactor model with the limited data taken at the General Applied Science Laboratories (GASL). Behavior was inconsistent with respect to pressure for the three different equivalence ratios. This behavior illustrates the difficulty in accurately measuring very low NO_x values and points out the need for further work in this area. No data exist beyond the 12-atmosphere pressure level due to autoignition in the test facility, which resulted in damage to the flameholder and liners.

The test facility, figure XIV-13, has now been redesigned to obtain NO_x emissions at pressure levels greater than 12 atmospheres. Good mixing will be achieved by using a multiple-tube injector supported on a honeycomb matrix. Emissions at various axial locations will be measured with a single-point traversing gas-sample probe. Flameholder damage due to autoignition will be minimized by water cooling. Ultimately, data will be obtained at a pressure level of 40 atmospheres and a temperature level of 1340° F.

Flameholder geometry effect on NO_x emissions. - The variation of NO_x emissions with equivalence ratio for Jet A is shown in figure XIV-14 for three different flameholder geometries - a 12-bladed, 60° swirler; a 60° cone; and a perforated plate. The blowout limits are sensitive to geometry. Swirl-stabilized combustion has the benefit of an enhanced blowout limit. This is seen by the swirler having a better blowout limit than the 60° cone limit, which is better than the perforated-plate blowout limit. However, near each of these limits, the NO_x emissions for the 60° cone and the swirler are greater than the perforated-plate emissions.

It is interesting to compare the NO_x levels obtained at a constant equivalence ratio (e. g., 0.58) for each flameholder geometry and its corresponding recirculation zone. The perforated plate has numerous recirculation zones with small residence times, as depicted in figure XIV-15. And the perforated-plate data agree quite well with the well-stirred-reactor predictions, as shown. Contrast this result with the 12-bladed, 60° swirler performance. The swirler has a recirculation zone with a large mean residence time. A longer time permits more complete reactions along with a slight increase in flame temperature. As a result, the NO_x emissions are high. This visual comparison shows that flame stability, blowout, and NO_x emissions do vary with the characteristics of the flameholder geometry. From the test results, the perforated plate has the lowest NO_x emissions, agrees best with the well-stirred reactor predictions, and is free from flashback.

The flameholder geometry effects on NO_x emissions for lean, premixed-prevaporized conditions are being studied. A number of different geometries are being tested to determine the effect of such items as blockage, wetted perimeter, and entrainment on the emissions levels and on the combustion efficiency.

Lean stability augmentation. - Three methods for augmenting the lean stability limit are shown schematically in figure XIV-16. In this sense, augmentation means techniques for lowering the equivalence ratio at blowout. The methods include the use of piloting, catalytic surfaces, and heat recirculation. Each of these techniques involves an addition to the combustor. Each method is discussed separately.

The well-stirred-reactor predictions of NO_x emissions are cross plotted as a function of inlet temperature for various equivalence ratios in figure XIV-17. The SCERP goal is shown as an emission index of 3. From this figure we can determine what equivalence ratio or fuel-air ratio is needed in the primary zone to meet the SCERP goal. Also shown in this figure is the experimental blowout curve for the perforated-plate flameholders. As the inlet temperature is increased, the combustor can be operated at leaner equivalence ratios and lower NO_x levels. The difference between the equivalence ratio at the SCERP goal and the equivalence ratio at blowout gives the operating margin for the combustor at a particular inlet temperature.

It is desired to operate with as wide margin as possible while still meeting the goals. Using pilots, as shown in figure XIV-18, can increase

the operating margin. The pilot burning say 10 percent of the total fuel can be operated above the goal. The main premixing combustor can be operated at an equivalence ratio at or below blowout since the pilot provides a continuous high-temperature ignition source. In this example, if 10 percent of the fuel was consumed by the pilot at an emission index of 6, the contribution to the total emissions would be 0.6. Then, if the main premixing combustor burning 90 percent of the fuel were operated at an emission index of 0.2, the total NO_x emissions would be 0.78. The pilot is contributing more emissions than the main premixing combustor so that care must be taken in its design.

The use of catalytic materials such as platinum or palladium impregnated on the flameholder surfaces can provide ignition sources. This effect is shown in figure XIV-19. The net effect of catalytic surfaces is to lower the blowout limit of the combustor. This can widen the operating margin without increasing the NO_x emissions. The propagation rate of the flame through the mixture still must be high enough so that high values of hydrocarbons and CO are not produced.

Finally, shown in figure XIV-20, heat recirculation by using either a heat exchanger, a recuperator, or heat pipes can improve the lean stability limit by raising the combustor inlet air temperature. This technique would require extensive additions to the engine and may not be practical. Also as the inlet air temperature increases, the ignition delay time decreases and the flashback velocity increases, so that autoignition or flashback may become a problem.

The three methods will be investigated under contract to assess the overall requirements and effectiveness of each concept.

Mixedness. - A uniform mixture of fuel and air is desirable for NO_x emission reduction; however, the degree of mixture uniformity, or "mixedness," needed to meet the SCERP emissions goal is not clearly known. The effect of mixedness is illustrated in figure XIV-21, which presents flame-tube data obtained at the Lewis Research Center. The fuel mixedness was varied by first injecting the fuel in the downstream direction and then turning the fuel injector upstream to improve mixing. Oxides of nitrogen emissions are definitely lower with upstream injection; however, a significant change in operating margin is also evident. The lean blowout limit increases from an equivalence ratio of 0.47 to 0.55 as the mixing im-

proves, which reduces the operating margin. The nonuniform fuel-air mixture apparently promotes lean stability, which introduces a trade-off between NO_x emissions and the lean stability limit.

Fuel mixedness can also influence combustion efficiency. This effect is illustrated in figure XIV-22, which contains data from three high-velocity premixing flame-tube configurations tested by the General Applied Science Laboratories. The three configurations differed only in the technique of fuel injection, with the single nozzle giving the worst fuel distribution and the wall injectors giving the best. The wall injectors consisted of 12 orifices flush mounted in the premixing tube wall and injecting transverse to the stream. The figure shows the trade-off between combustion inefficiency and NO_x emission index for each combustor. It is evident from the figure that increasing fuel-air mixedness can improve NO_x emissions without significant sacrifices in combustion efficiency.

These data indicate that fuel mixedness can be an extremely significant factor in achieving the emission, stability, and efficiency goals of the combustor. However, achieving the desired fuel-air distribution over a wide range of conditions is a complex problem.

Summary of lean combustion element. - Data have been presented that show that the SCERP goals can be reached at cruise conditions, but the data taken at cruise have been at low pressures and usually with uniform fuel-air distributions. To apply the premixing-prevaporizing technique to the LTO cycle, higher pressure data must be obtained to validate the trends predicted by the well-stirred-reactor model. The effect of flameholder geometry on emissions is being pursued to determine the trade-off between stability and NO_x emissions. Augmentation techniques for improving lean stability are being investigated to assess the overall effectiveness of various concepts. When fuel and air are not uniformly mixed, stability is improved, but NO_x levels are also increased. These variables can all affect the NO_x emissions and have to be optimized in the overall design.

Fuel-Air Preparation

To avoid problems with mixedness and with incomplete vaporization, the fuel-air preparation section must be very carefully designed. The sec-

ond phase I element addresses this problem area. It will be illustrated later that the high pressure and temperature typical of engine takeoff conditions may lead to autoignition of the fuel-air mixture before the largest droplets have time to vaporize. On the other hand, a spray composed entirely of small droplets is very difficult to distribute uniformly.

The difficulty of satisfying these conflicting demands can be illustrated by the simplistic example shown in figure XIV-23. Here are shown calculated trajectories for droplets of various diameters with inlet air velocities of 400 and 100 feet per second. The question to be answered is, Can the fuel be mixed and vaporized within this 10-inch by 2-inch passage? The fuel has been injected perpendicular to the airflow. The pressure and temperature condition shown is representative of the flame-tube rigs previously discussed. In mixing sections where high-velocity air (400 ft/sec) has been used to minimize difficulties with autoignition and flashback, small droplets exhibit little penetration, while the larger droplets require significantly longer than the 10-inch length illustrated here. The 100-micrometer drop would have required 54 inches and the 50-micrometer drop would have required 15 inches to completely vaporize. Such vaporization lengths are not feasible. If the air velocity is decreased to 100 feet per second, vaporization length is decreased. However, penetration of the smallest droplets is still poor, while large droplet penetration may be excessive.

The whole process of fuel-air preparation is obviously more complicated than illustrated in this example. NASA is currently in the process of preparing a unified model of droplet vaporization and mixing as an aid to designing this portion of the combustor. An indication of the large number of factors involved in this problem is illustrated in figure XIV-24. The pressure, which affects penetration; the temperature, which affects vaporization; and velocity, as just illustrated, are of obvious importance. The level of turbulence and the degree of swirl must also be considered. The fuel type and the facts that it consists of multicomponents and that it may be injected above its critical pressure are all involved. Potential injectors include pressure-atomizing, air-blast, and air-assist types; and their number and location must also be considered. After injection, the dynamics of the spray itself include jet breakup, penetration, shattering, acceleration of the spray, and its initial drop size distribution. As the droplets proceed down the duct, they will be subjected to heating and evaporation; will spread

and mix throughout the duct; and, in some cases, may be subject to coalescence. If conditions are appropriate, significant cool-flame reactions may also be occurring. It is desired to be able to predict the degree of vaporization, the drop size distribution, and the fuel-air distribution at the plane of the flameholder.

A series of in-house flame-tube experiments to evaluate the effect of the degree of vaporization and the drop size distribution on NO_x formation have recently been initiated. Following these studies, deliberate attempts to distort the fuel-air profile and the subsequent effect on NO_x emissions will be evaluated.

Autoignition and Flashback

Autoignition and flashback can seriously impede the implementation of premixing-prevaporizing combustors if their limits are not adequately defined for avoidance and control.

The lean-reaction combustors under discussion will require a finite length for the premixing and the prevaporizing processes. This premixing length is a compromise between providing sufficient residence time for the degree of vaporization required for low NO_x emissions and minimizing the fuel-air residence time to prevent autoignition. There exist currently within the operating map of today's advanced compressors regions of high pressures, along with high temperatures, where self-ignition of the fuel-air mixture is possible in the premixing length shown by the shaded area in figure XIV-25. For a typical example, at sea-level takeoff the pressure is approximately 28 atmospheres with a temperature of 1040° F. Self-ignition (or autoignition) occurs when the autoignition delay time is less than the fuel-air residence time. Autoignition delay time is a measure of the time elapsed from fuel injection to autoignition.

The dependence of autoignition delay time and droplet evaporation times upon the compressor exit pressure is shown in figure XIV-26 for Jet A fuel. The ignition delay times would be different for fuels other than Jet A since autoignition delay time varies greatly with the molecular structure of the fuel.

Time in milliseconds is plotted against compressor exit pressure, which also accounts for compressor exit temperature. The autoignition delay time shown by the crosshatched curve and the droplet evaporation times shown by the solid curves decrease with increasing pressure, but at different rates. The ignition delay variation is represented as a cross-hatched curve because it is based upon an extrapolation of data over a narrow range of pressures. The crosshatched curve also indicates the lack of meaningful and accurate autoignition data.

Looking at the 100-micrometer-drop evaporation curve, and comparing the drop evaporation time to residence time, it can be seen that the desired range of completely prevaporized operation is achieved for pressures less than 18 atmospheres. At a compressor exit pressure of 30 atmospheres, the required residence time for evaporation is greater than the autoignition delay time. This is obviously unacceptable for compressors operating at 30:1 pressure ratios. The 25-micrometer-drop evaporation curve does not intersect the ignition delay curve over the combustor operating regime of interest. From these observations, it is concluded that fuel-drop diameters should not only be as small as practicable, but also the fuel-air residence time should be less than the autoignition delay time.

This illustration of autoignition has led to the conclusion that the needs of the lean, premixing-prevaporizing combustor are for smaller fuel drop sizes and lower residence times for prevaporization without autoignition. The drop size and residence time will be determined, in part, by the behavior of the ignition delay curve for the fuel of interest. The objective established, therefore, is to accurately define the behavior of the ignition delay time for various fuels over the operating regime of premixing-prevaporizing combustor systems. Autoignition delay data reported in the literature require careful interpretation with respect to the test apparatus and measurement method used. Some results are contradictory. All experimenters had difficulty in rapidly obtaining a uniform fuel-air mixture and in determining the extent of fuel vaporization. This objective is being fulfilled through a contract with United Technologies Research Center. The approach is to develop an experiment for determining the autoignition characteristics

of aircraft fuels for pressures up to 30 atmospheres and temperatures up to 1160° F. Autoignition delay times will then be determined by using injectors with efficient atomization and rapid mixing that produce a minimum flow disturbance.

Flashback is another performance constraint on the premixing-
prevaporizing combustor. For the combustor system shown in figure XIV-25, there are two different regions of flashback. The first is the region where the flame propagates upstream through the free-stream fuel-air mixture. This propagation can occur in a combustible mixture where the flame velocity is greater than the free-stream velocity. Such a condition might occur during engine transient operation. The second flashback region is the boundary layer. At some point in the boundary layer, the gas velocity is less than the flame speed and the wall quenching effects are minor. Such conditions are provided by thick boundary layers and regions of incipient flow separation containing a combustible fuel-air mixture. Obviously, these conditions should be designed out of the combustor.

In describing the two flashback regions some of the variables that influence flashback - gas velocity, flame velocity, and fuel-air ratio - have already been discussed. The number of influencing variables are increased once the entire range of combustor operating conditions is considered. These influencing or controlling variables have been identified and tabulated for the boundary-layer region and the free-stream region in table XIV-3. This table is for a given fuel type, fuel temperature, and fuel-injector design. For each flashback region, the listed variables control the heat transfer, mass transfer, and reaction rates. For example, when the heat and mass transfer rates greatly exceed the reaction rate, the flame is quenched. In the boundary-layer flashback region, the premixing-length surface temperature may increase the tendency for flashback if it is high or decrease the tendency for flashback if it is low.

As previously discussed, the influence of the controlling variables, shown in the table, on flashback are qualitatively known. However, there is an inadequate amount of data on the quantitative effect these variables have on flashback for aircraft fuels over the operating regime of the lean, premixing-
prevaporizing combustor. A need exists, therefore, to acquire data on the quantitative effect these variables have on flashback sensitivity. At present, this need is being satisfied by work under way at the Lewis Research Center.

An in-house facility that will add to and extend these data not only for two-dimensional and axisymmetric geometry effects, but also for surface temperature effects, on flashback within the boundary layer is being designed and fabricated.

Engine Interfaces

Engine interfacing covers a wide range of topics and generally includes those problems resulting from the integration of the combustor with the engine. Several problem areas have been identified in table XIV-4 where more information or study is required.

The first problem area identified deals with the interface with the compressor at the combustor inlet. A study was conducted by Pratt & Whitney under contract to Lewis Research Center to characterize the airflow distribution at the exit of several compressors. As part of the study, the steady-state exit airflow distribution of a J-58 compressor was measured over a range of conditions. An airflow contour map derived from the study is shown in figure XIV-27. The data were taken with an undistorted compressor inlet flow at sea-level-takeoff conditions. Substantial airflow variations of ± 30 percent of the average airflow can be seen. The distortion decreased as the power level was reduced; however, the position of the four high-flow regions was observed to rotate. Variations in airflow of this magnitude complicate the problem of uniformly premixing and may require design features to improve the airflow distribution before fuel is introduced.

In addition to data on uniformity, more data are needed to identify the turbulence characteristics of inlet airflow. Turbulence intensity and scale can influence fuel-air distribution and mixing.

A traditional combustor requirement is an exit temperature profile specially tailored for the turbine. Typically, lower temperatures are desirable at the turbine hub and tip, with peak temperatures near 60 percent of span. In the lean premixing combustor, more airflow is passed through the combustion zone at high-power conditions, leaving less airflow for cooling and dilution. This complicates the problem of achieving the desired exit temperature profile. More information is needed on the effect of nonideal profiles on turbine life and performance. In addition, more study is re-

quired on dilution jet mixing as well as on liner cooling techniques in order to optimize liner design. One advantage of a lean premixing combustor may be reduced flame radiation.

Digital engine controls will likely be required for the additional complexity of variable geometry. It is anticipated that full-authority digital control technology will be available in the future. However, additional study is needed to examine the control aspects of variable-geometry combustors and to establish transient response requirements.

The last problem area identified in the table is the effects of engine transients on the combustor. More data are needed on the time variation of the combustor flow parameters during acceleration, deceleration, ignition, and relight operations. These transient operations affect not only the control aspects of the combustion system, but ultimately the survivability of the combustor hardware. Flow perturbations can lead to flashback or autoignition upstream of the combustor. Adequate safety margins and safe failure modes must be incorporated into the combustor and control system design in order to prevent damage during transient operations.

Compressor stall presents a particularly difficult transient problem. Because of the various possible modes of compressor stall, characterization of combustor flow parameters is difficult. Existing data are limited; however, it is apparent that pressure, flow, and velocity excursions can be extreme over periods ranging from 10 to 100 milliseconds or longer. Frequently, flow reversal may occur in the combustor, driving combustion gases upstream into the compressor. Electronic engine controls can detect and respond to abrupt compressor stall within 100 milliseconds; nonetheless, the combustor will be required to tolerate extreme flow excursions.

More work is needed on each of the engine interface problems discussed. Unfortunately, actual engine data relating to many of these problems are limited and additional data will be difficult and expensive to obtain. Regardless, before the lean premixing concept can be applied, the interface conditions must be identified and incorporated into the combustor design.

SUMMARY

Results from a variety of projects currently being conducted and sponsored by NASA have indicated that substantial reductions in cruise NO_x should be possible. Reductions to 1/6 or more will require the application of higher risk technology such as the lean premixed-prevaporized combustion concept. The NASA Stratospheric Cruise Emission Reduction Program is undertaking a careful and systematic approach to answer the inconsistencies and to fill in the gaps in fundamental knowledge associated with this combustion technique. Determining the ability to convert this fundamental knowledge into practical engine hardware will require several additional years of intensive effort on the part of NASA and the engine manufacturers.

Success will depend on the development of new technology in several areas, notably the compromises involved in producing uniform, lean, premixed-prevaporized fuel-air mixtures over the range of pressures and temperatures encountered in an engine. Associated with this problem is the added real possibility of autoignition of the fuel-air mixture, particularly at pressures and temperatures associated with high-power engine operation. The ability to avoid or survive flashback during engine transients will be required. The workability of variable geometry and the more complex controls associated with it must be demonstrated. The degree to which these problems are solved will help determine the ability of future high-altitude cruise aircraft engines to meet the emissions levels recommended by environmental studies.

**LEAN PREMIXED PREVAPORIZED COMBUSTION
FOR NO_x EMISSION CONTROL**

TECHNIQUE	MECHANISM
LEAN COMBUSTION UNIFORMLY PREMIX FUEL & AIR PREVAPORIZE FUEL	REDUCE OVERALL FLAME TEMP ELIMINATE LOCALLY HIGH FLAME TEMPS ELIMINATE DIFFUSION FLAMES (STOICHIOMETRIC FLAME TEMPS) SURROUNDING DROPS

CS-77-516

Table XIV-1.

**APPLICATIONS PROBLEMS FOR LEAN PREMIXING
PREVAPORIZING COMBUSTORS**

PROBLEM AREA	PHASE I ELEMENT
FACTORS AFFECTING NO _x FORMATION LEAN STABILITY & RELIGHT	LEAN COMBUSTION
FUEL-AIR DISTRIBUTION FUEL VAPORIZATION	FUEL PREPARATION
FACTORS AFFECTING AUTOIGNITION FLAME FLASHBACK DURING TRANSIENTS	AUTOIGNITION & FLASHBACK
INLET AIRFLOW CHARACTERISTICS ENGINE TRANSIENTS VARIABLE GEOMETRY CONTROLS	ENGINE INTERFACES

CS-77-529

Table XIV-2.

**FLASHBACK REGIONS IN PREMIXING-PREVAPORIZING
LENGTH AND CONTROLLING VARIABLES**

FLASHBACK REGIONS	CONTROLLING VARIABLES
BOUNDARY LAYER	FUEL-AIR MIXTURE: TEMP PRESSURE VELOCITY GRADIENT TURBULENCE INTENSITY PREMIXING LENGTH: SURFACE TEMP SURFACE TYPE
FREE STREAM	FUEL-AIR MIXTURE: TEMP PRESSURE VELOCITY TURBULENCE INTENSITY DISTRIBUTION TRANSVERSE TO MIXING LENGTH

CS-77-535

Table XIV-3.

ENGINE INTERFACE PROBLEM AREAS

INTERFACE	PROBLEM AREAS
COMPRESSOR EXIT	AIRFLOW UNIFORMITY TURBULENCE CHARACTERISTICS
TURBINE INLET	TEMP PROFILES
ENGINE CONTROLS	VARIABLE GEOMETRY
ENGINE TRANSIENTS	TRANSIENT CHARACTERISTICS ACCELERATION/DECELERATION IGNITION/RELIGHT COMPRESSOR STALL

CS-77-518

Table XIV-4.

SUBSONIC CRUISE NO_x EMISSION OUTLOOK

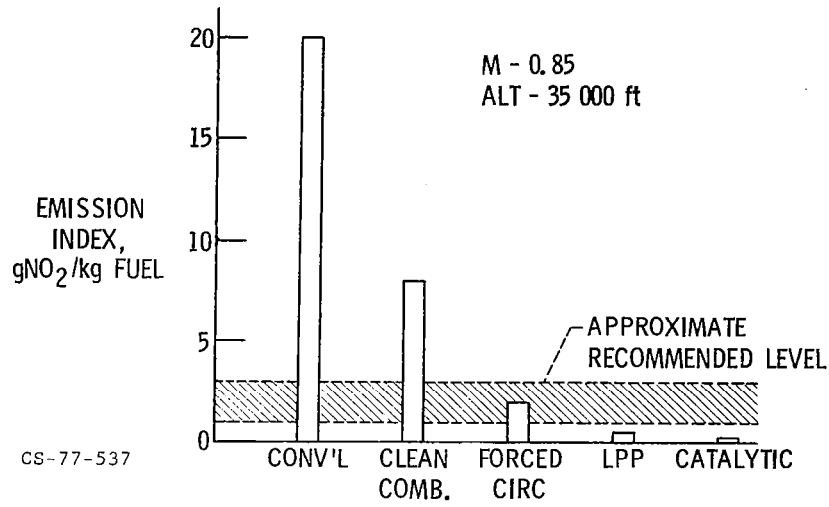

Figure XIV-1.

SUPERSONIC CRUISE NO_x EMISSION OUTLOOK

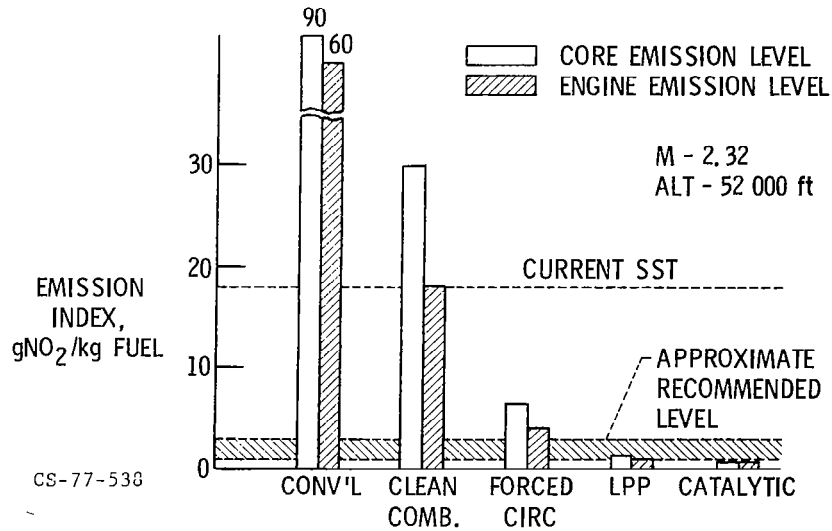

Figure XIV-2.

SCERP PROGRAM PLAN

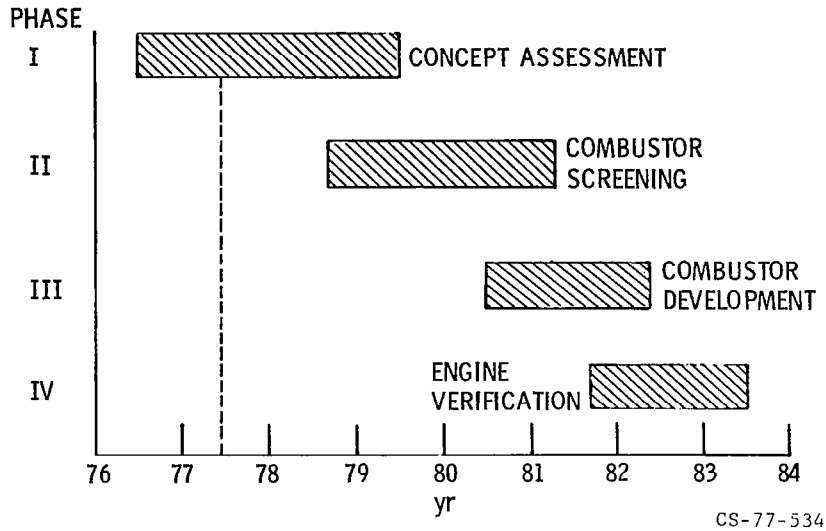

Figure XIV-3.

EFFECT OF FLAME TEMPERATURE ON NO_x EMISSION INDEX

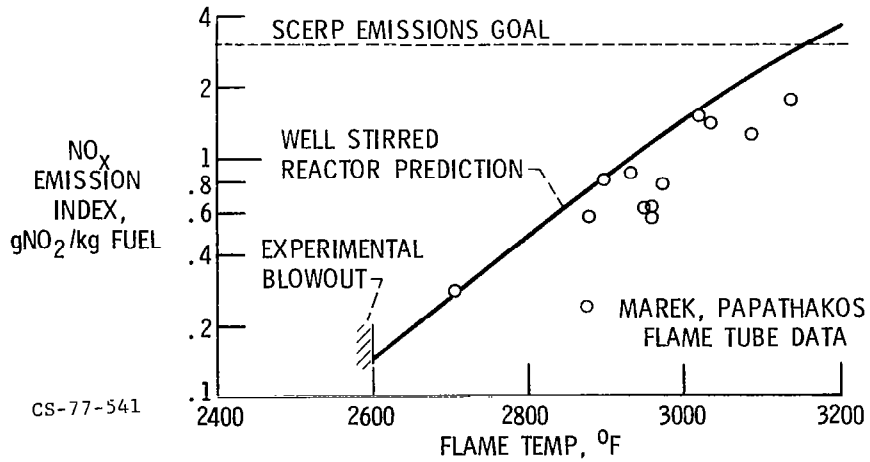
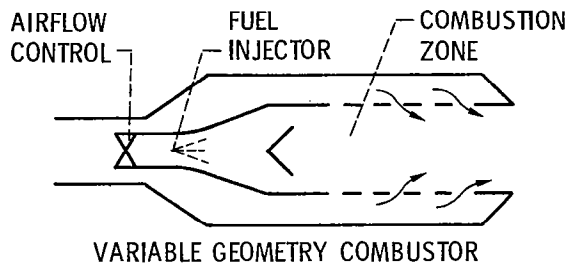
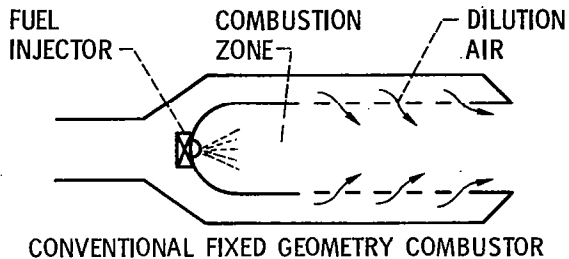

Figure XIV-4.

COMBUSTOR GEOMETRY CONCEPTS



CS-77-532

Figure XIV-5.

COMBUSTION ZONE EQUIVALENCE RATIO

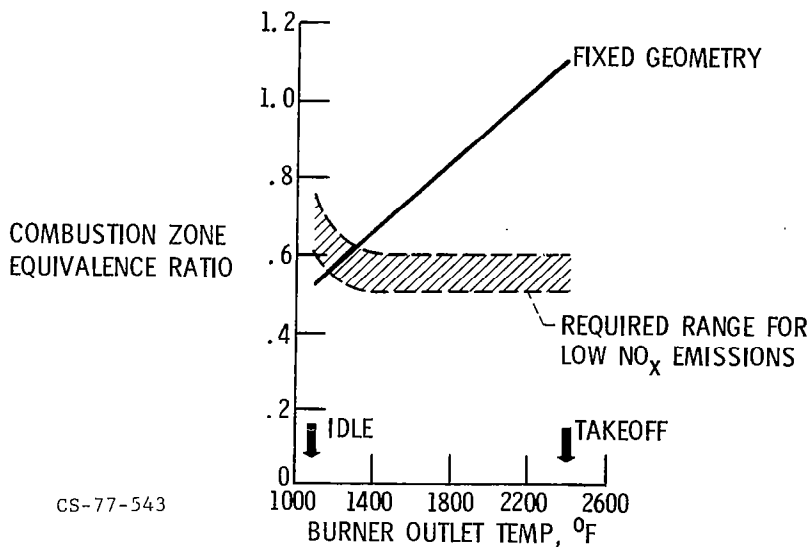

CS-77-543

Figure XIV-6.

VARIABLE GEOMETRY REQUIREMENT

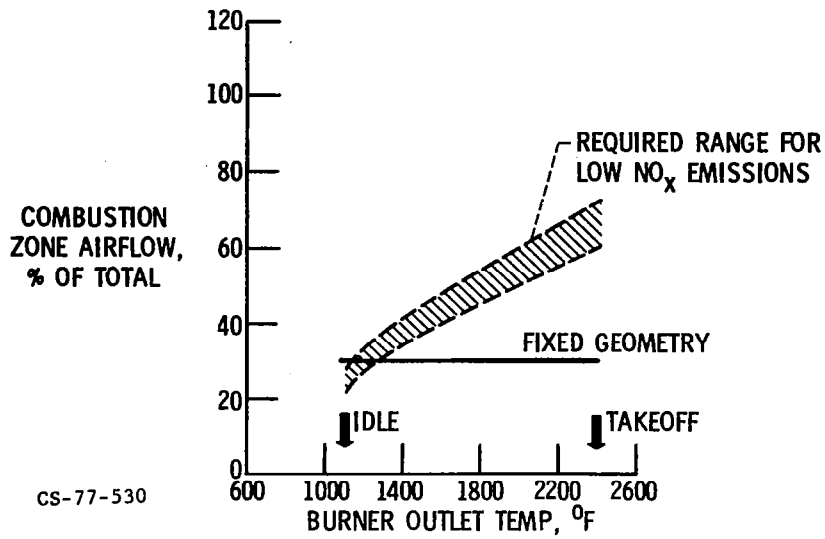

Figure XIV-7.

NASA-PREMIX EXPERIMENT

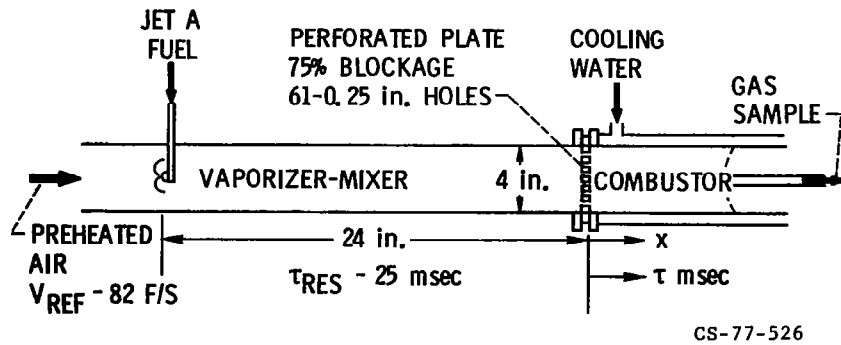

Figure XIV-8.

FLAME TUBE EMISSION PROFILES

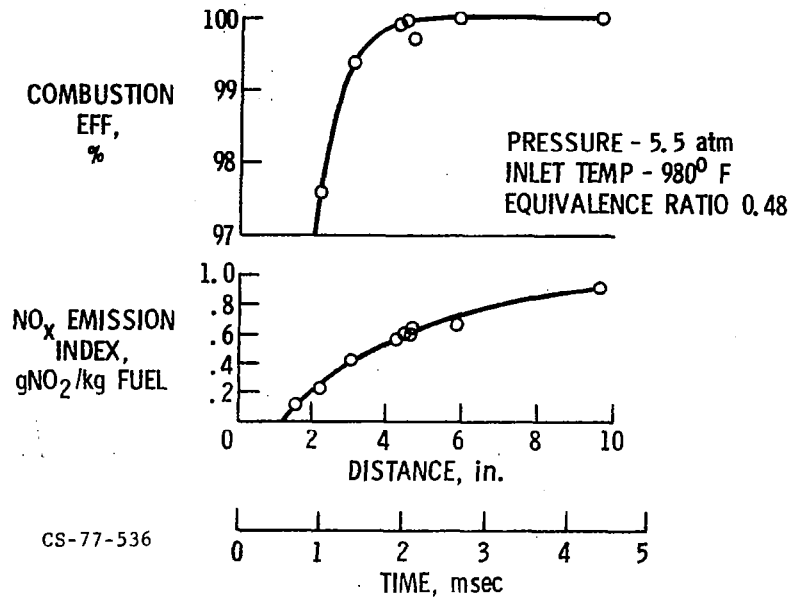

Figure XIV-9.

FLAME TUBE EMISSIONS

5.5 atm, 980° F

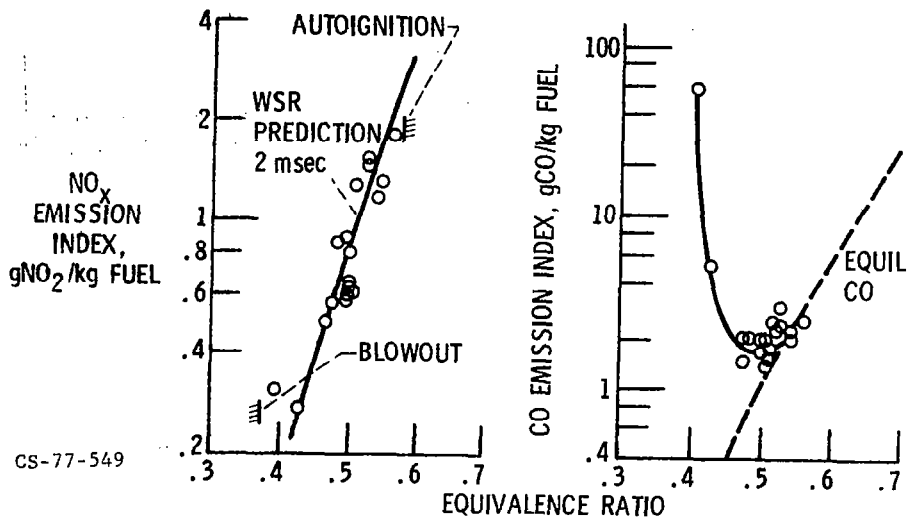

Figure XIV-10.

CALCULATED PRESSURE EFFECT
ON NO_x EMISSIONS FOR JET A

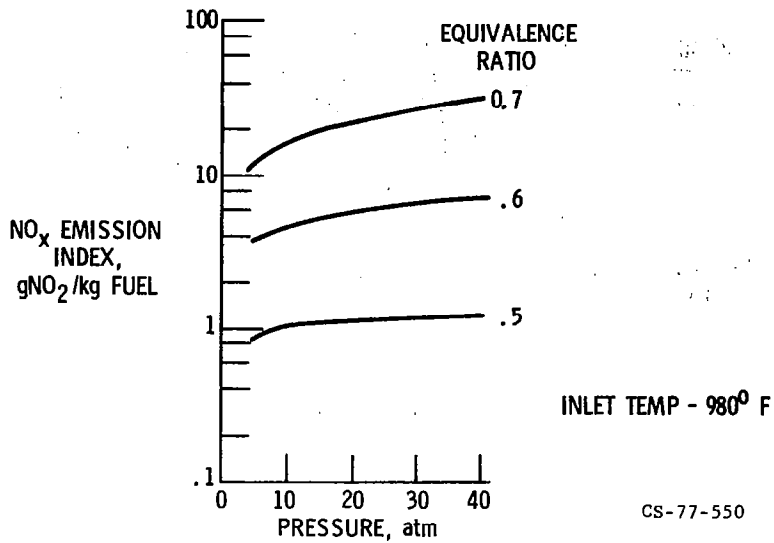

Figure XIV-11.

PRESSURE EFFECT ON NO_x EMISSIONS FOR JET A

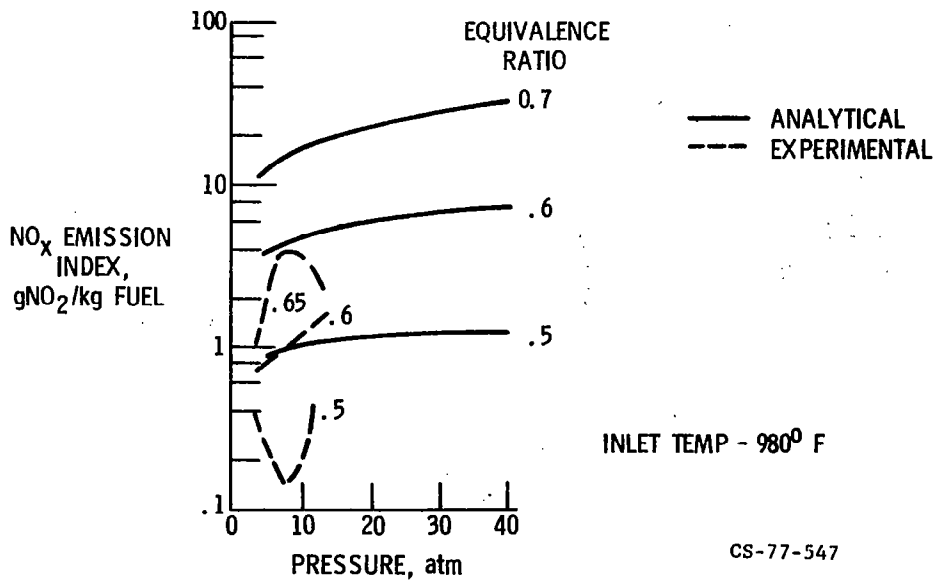

Figure XIV-12.

GASL HIGH-PRESSURE EMISSIONS TEST RIG

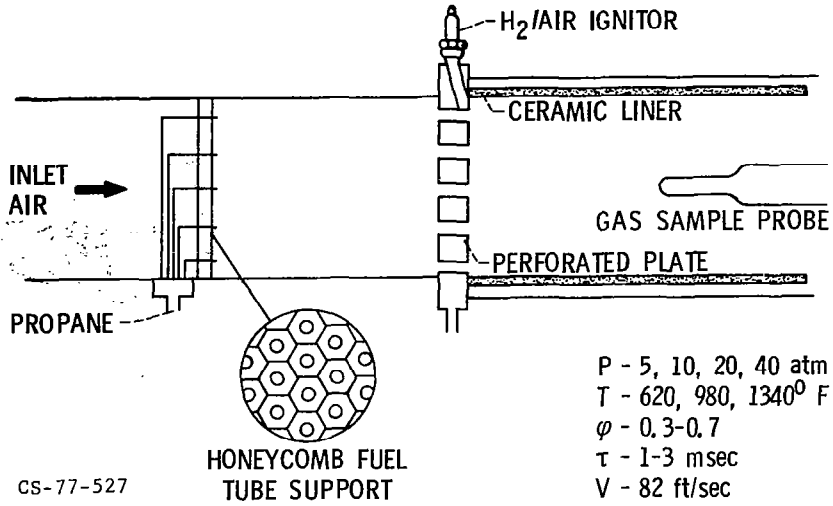

Figure XIV-13.

FLAMEHOLDER GEOMETRY EFFECT ON NO_x EMISSIONS

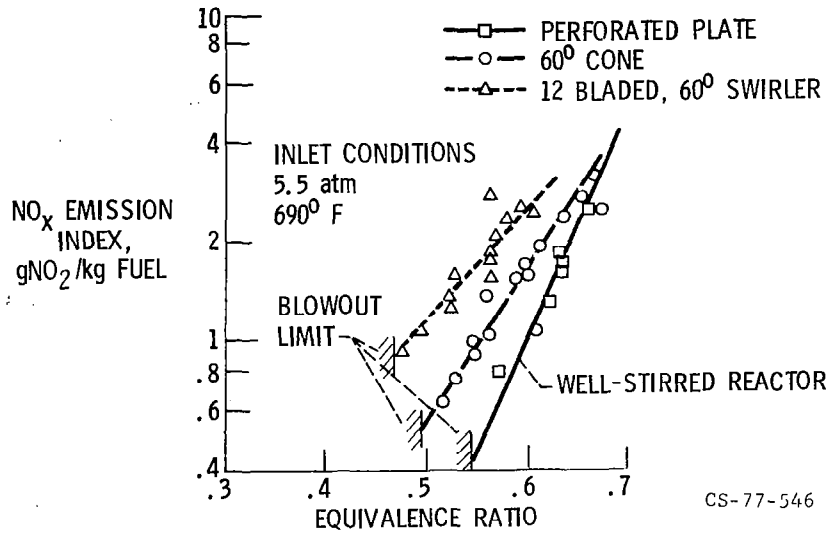

Figure XIV-14.

FLAME STABILIZER RECIRCULATION ZONES

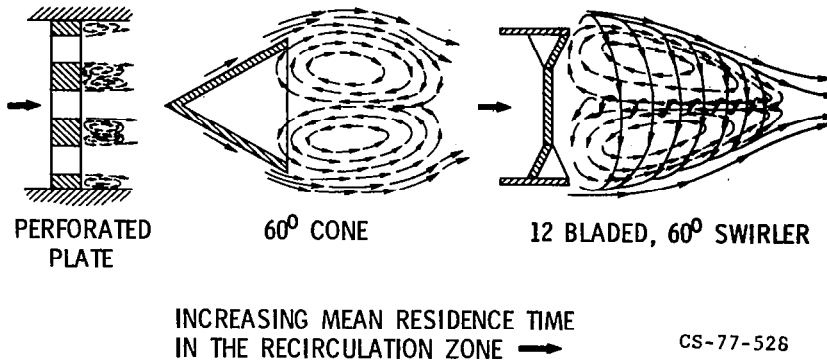

Figure XIV-15.

AUGMENTATION

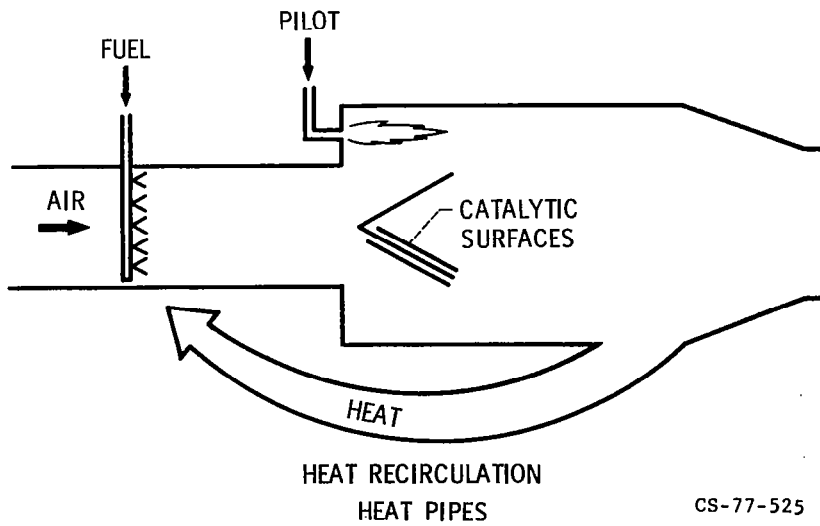

Figure XIV-16.

PERFORATED PLATE STABILITY MARGIN

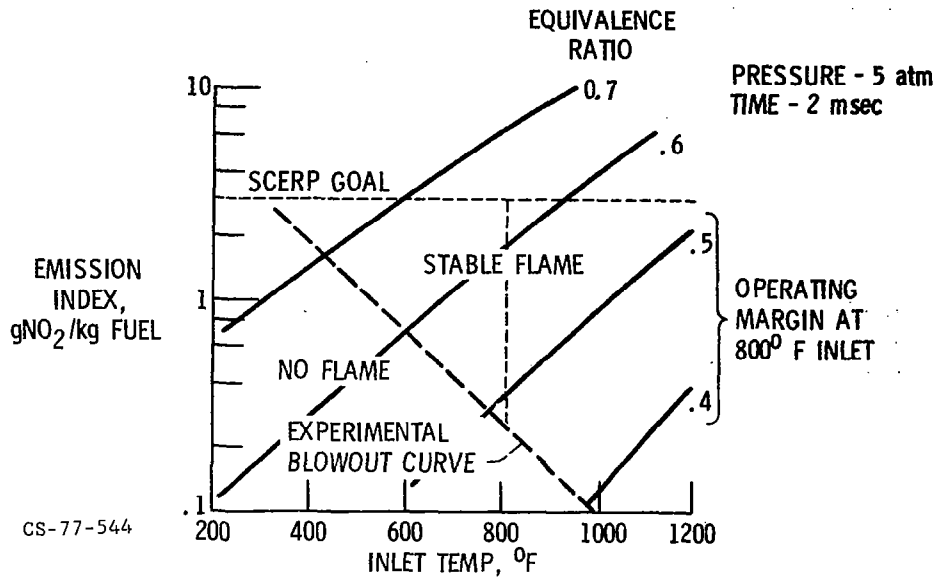

Figure XIV-17.

AUGMENTATION BY PILOTING

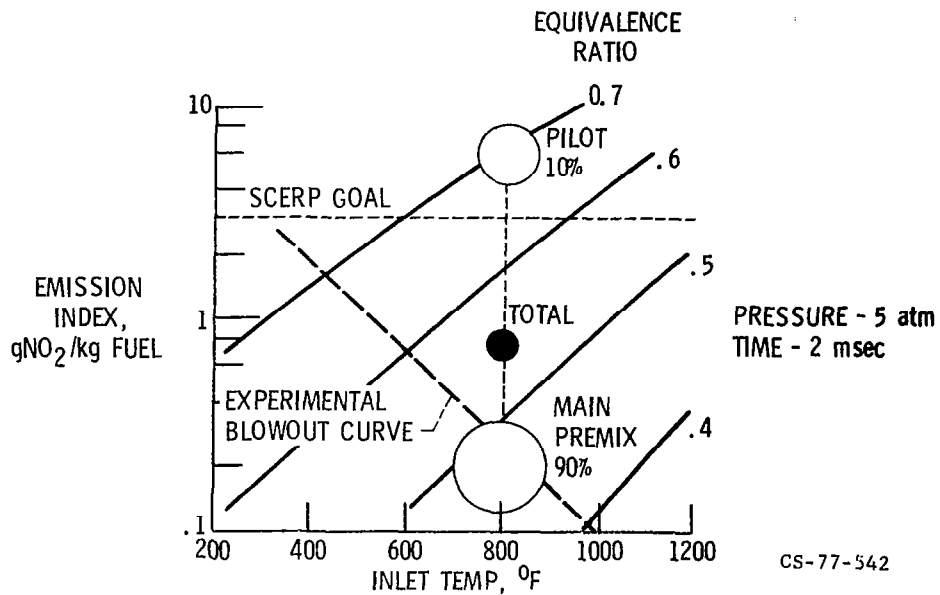

Figure XIV-18.

AUGMENTATION BY CATALYTIC SURFACES

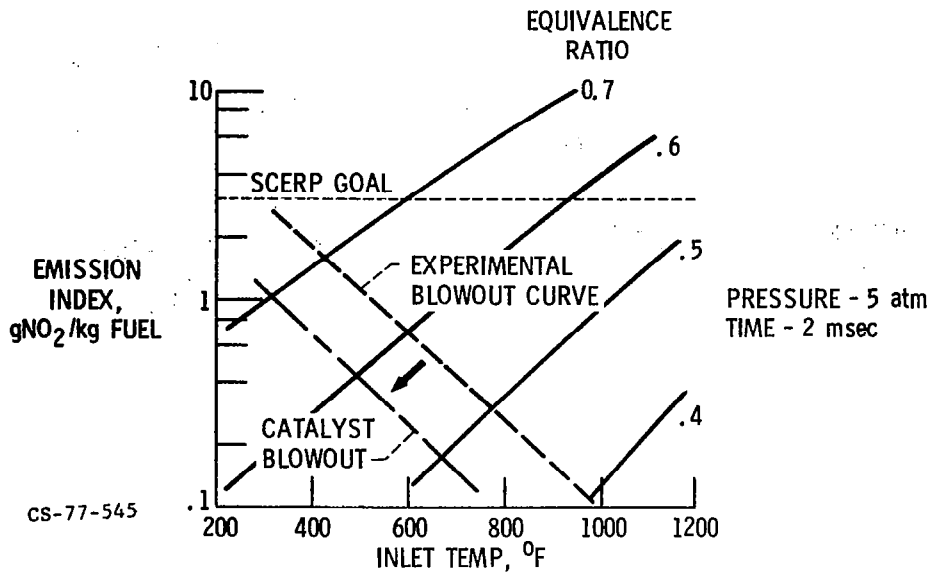

Figure XIV-19.

AUGMENTATION BY HEAT RECIRCULATION

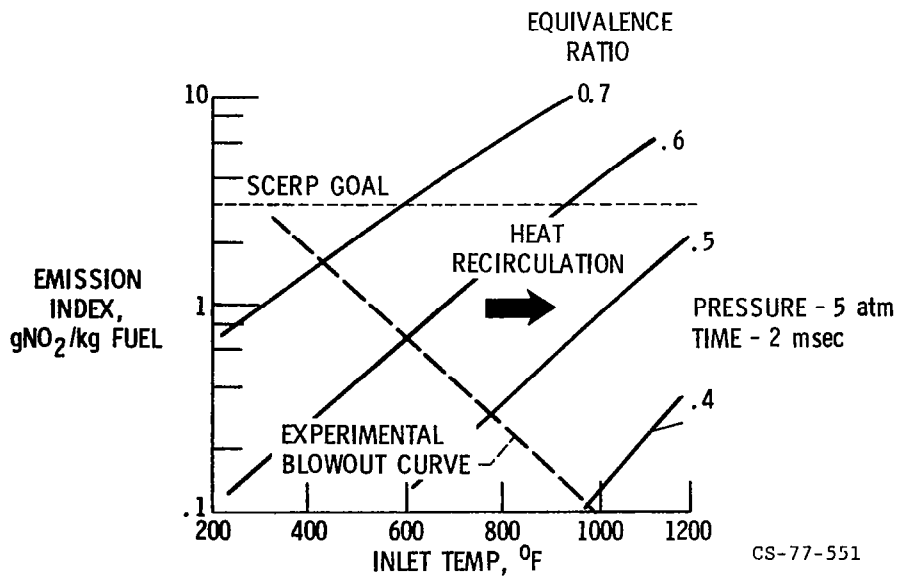

Figure XIV-20.

EFFECT OF FUEL MIXEDNESS ON NO_x EMISSIONS AND BLOWOUT

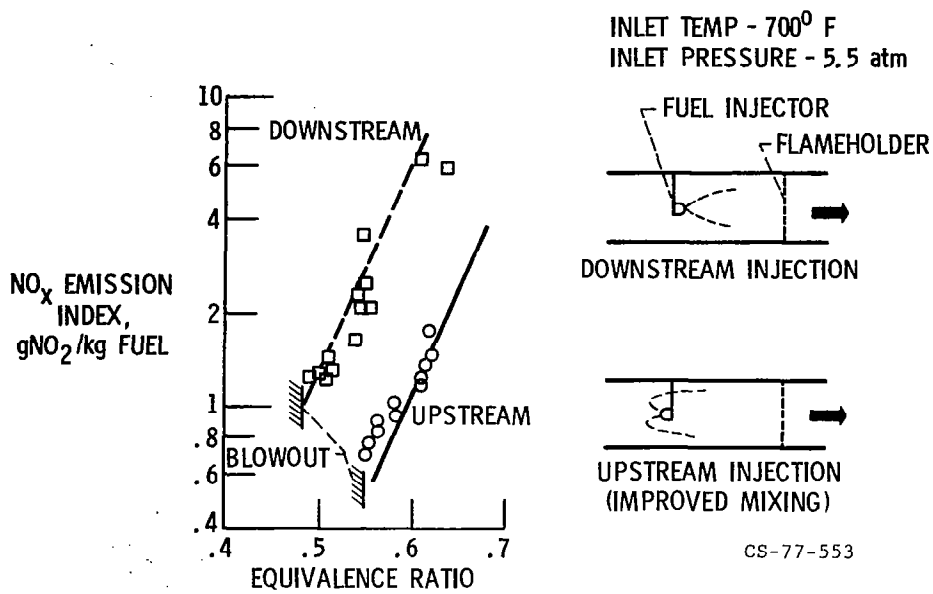

Figure XIV-21.

EFFECT OF FUEL MIXEDNESS ON NO_x EMISSION AND COMBUSTION INEFFICIENCY

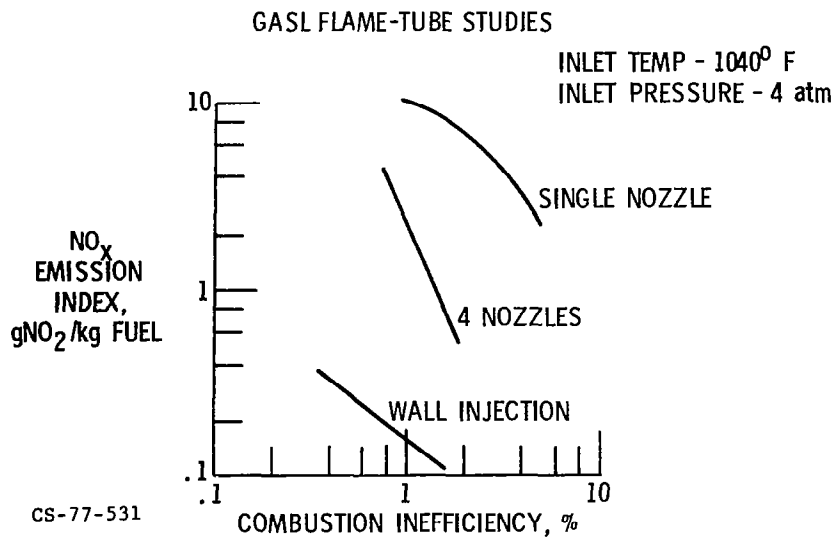
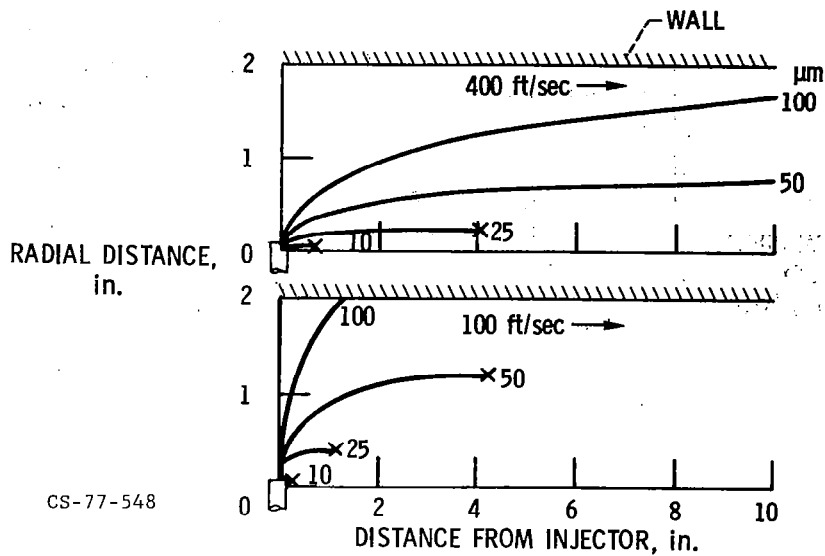

Figure XIV-22.

DROPLET TRAJECTORIES

90° INJECTION; 800° F; 5 atm



CS-77-548

Figure XIV-23.

FUEL PREPARATION

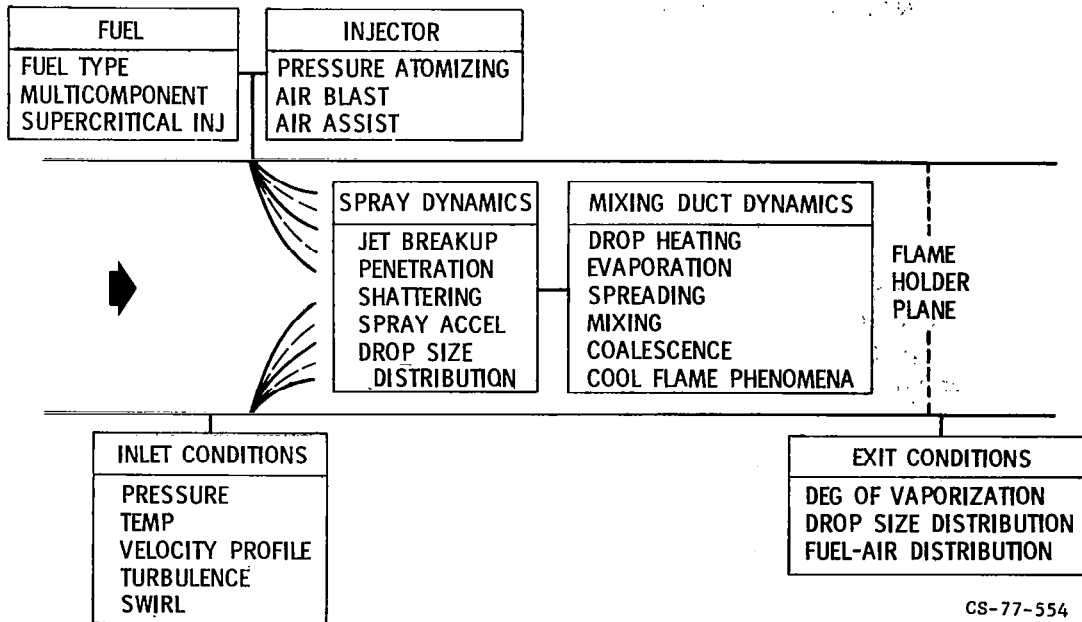

CS-77-554

Figure XIV-24.

COMBUSTOR SCHEMATIC

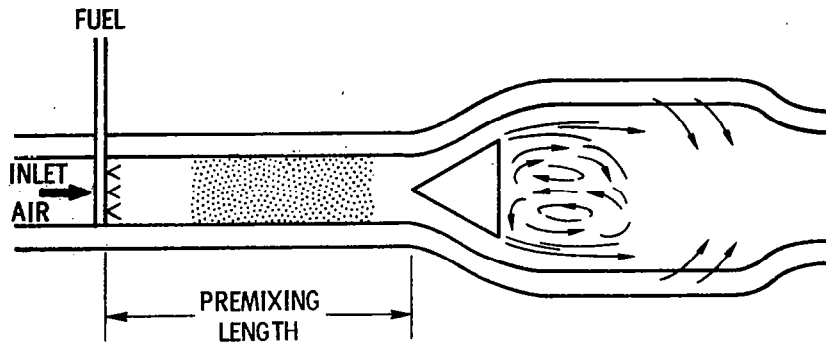

CS-77-524

Figure XIV-25.

JET A AUTOIGNITION DELAY AND DROPLET EVAPORATION TIMES

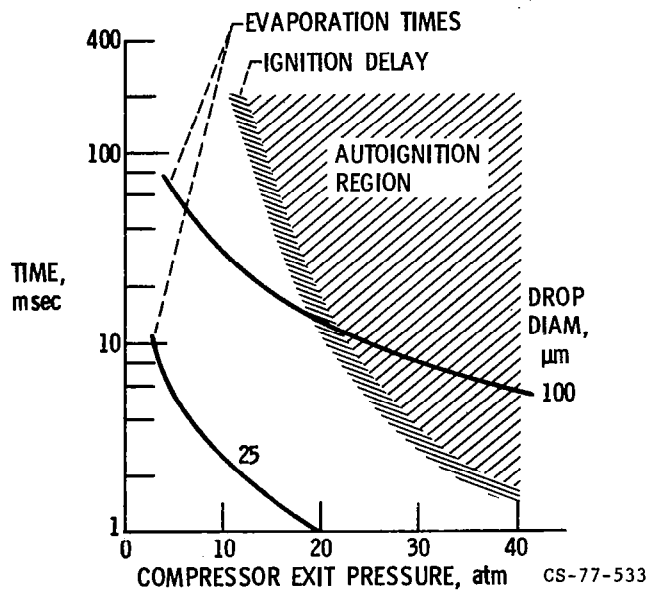

CS-77-533

Figure XIV-26.

J-58 COMPRESSOR DISCHARGE FLOW CONTOURS
AT SEA-LEVEL TAKEOFF

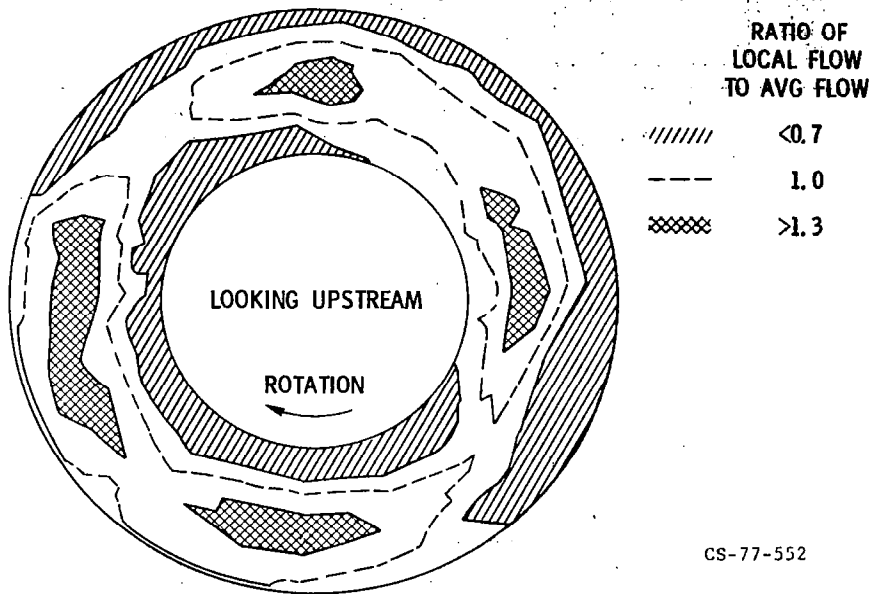

CS-77-552

Figure XIV-27.