

3. MEASUREMENT AND TESTING PROBLEMS EXPERIENCED DURING FAA'S EMISSIONS TESTING OF GENERAL AVIATION PISTON ENGINES

Robert F. Salmon and Steven Imbrogno

Federal Aviation Administration
Department of Transportation
Washington, D.C.

INTRODUCTION

One of the objectives of the FAA program was to establish an accurate, reliable method of determining exhaust emissions from piston engines. The words accurate and reliable are inexact and should be defined. The EPA has touched upon this requirement. In writing the standards, the EPA requires that the exhaust pollutants be measured with sufficient precision so that a carbon balance can be determined within an accuracy of ± 5 percent. Thus, there are two areas of investigation which require precision to meet this standard. The engine performance or input side of the equation and the emission measurements or output side of the equation. This paper will emphasize the importance of measuring accurate air and fuel flows as well as the importance of obtaining accurate exhaust pollutant measurements. During the past 2 years of testing general aviation piston engines at NAFEC and at Avco Lycoming, Teledyne Continental Motors, and the University of Michigan, numerous problems have been identified in the emissions measuring equipment. This paper will identify some of the problems and the corrective actions taken to incorporate fixes and/or modifications.

DESCRIPTION OF NAFEC'S AIR AND FUEL FLOW MEASURING SYSTEMS

Air Flow

The first area to be discussed is the airflow measuring method(s). There is a great deal of information available on airflow measuring techniques. These techniques go back many years and the precision of the methods can be reliably estimated. The major points to be discussed are: (1) type of instrumentation, (2) sizing, (3) calibration and accuracy, and (4) redundancy.

Type of instrumentation. - In assessing the requirements of the program, it was determined to use two types of instruments to measure the airflow, sharp-edged orifices, and flow transducers. There are advantages to be realized in using either of these devices. The orifice is reliable and not subject to wear and deterioration. A permanent record of a test is assured by a photographic record of the manometry to which the instrumentation is connected. The flow transducer is very convenient since it can display information digitally and data handling can be expedited by connecting instrument input to a computer. Each measurement method operates independently of the other and therefore can be used as either a primary or a backup measuring system. Figure 3-1 is a schematic of the NAFEC airflow measuring system.

Sizing. - It is very important that the range of airflows to be measured is in the upper half of the maximum range of the measuring device. For instance, the piston engines have an idle airflow as low as 40 pounds per hour and a takeoff airflow as high as 2000 (or more) pounds per hour. This is a range of 50 to 1. If only one size device is used across this range, the error at the low end can be very large as shown in figure 3-2. To illustrate this point with both an orifice and a flow transducer, the following example is shown:

Orifice	Power	P in, in. H ₂ O	Air flow (std day)
3.792 in. in 8 in. pipe	Takeoff	4.00	1775 pph
3.792 in. in 8 in. pipe	Idle	.10	115 pph

If it is assumed that the ΔP observed can be read accurately to within ± 0.05 inch of H₂O, the error at takeoff is ± 10 pph or ± 0.5 percent. At idle, however, an error of 0.05 inch is ± 45 pph and results in an airflow tolerance of ± 39 percent. The same problem arises using flow transducers. This particular point is most graphically demonstrated when referring to an Autoronics 750S transducer calibrated by the manufacturer. This device has an upper flow limit of 600 CFM. Seven calibration points were made from 100 to 600 CFM. In addition, seven calibration points were made from 0 to 100 CFM (the low end of the instruments range). A calibration curve from 0 to 600 CFM was drawn by the factory and all the points fell very close to the straight line calibration. However, when reading the tabulated calibration data (fig. 3-3) for the low end of the instrument range, it shows the following:

CPS	Measured, CFM	Calibrated curve, CFM	Percent differ- ence
20	10	15	+50
25	25	25	0
57	40	44	+10

The previous discussion indicates the necessity of proper sizing for the airflow measuring system. This is true whether using orifices, laminar flow meters, or flow transducers.

Calibration. - The two types of instruments used at NAFEC for airflow measurements were orifices and flow transducers. The orifices were fabricated at NAFEC in accordance with ASME standards. No calibrations were made of this equipment until about 6 months after it was in use. This sounds very imprecise; however, there was such an abundance of information on flow coefficients, sizing, pressure measurement location, and accuracies that it was not critical. In addition, it was possible, with the airflow system used, for a cross-check of the flow to be made by comparing orifice results with a calibrated flow transducer, and small orifices operating simultaneously. Thus, confidence in the system was high. Later, an orifice and attendant hardware were built, used at NAFEC, and then shipped to each of the other facilities to compare results and to develop a correlation between the various air measuring systems in the program. Conservatively, it is estimated that airflow at the takeoff, climb, and approach powers is measured accurately to within ± 2 percent. At taxi and idle, the accuracy is within ± 3 percent. The flow transducers were calibrated at the time of procurement and recalibrated 1 year later. The large transducer (750S) showed a shift in calibration of approximately 7 percent; the low flow unit showed no change. The shift in the large unit did not effect the program data because at the time of the shift (it appeared to be a step change) it was detected from data taken with the orifice. Inspection of the orifice showed no damage and the large transducer was removed and sent out for calibration. Inspection at the factory showed that the bearing lubricant had changed due to cycling from hot to cold and this temperature cycling had affected the calibration. The lubricant temperature sensitivity is no longer a problem with this equipment.

Redundancy. - In the earlier paragraphs it has been implied several times that there is a redundancy to the airflow measuring system used at NAFEC. It was planned to have this redundancy in the system to obtain a continuing check on the information obtained during the tests. It is much easier to detect bad data and run again while the engine is available than to come back months later, reinstall an engine and rerun the tests. A reference to the airflow schematic shows the redundancy

(and, incidentally, the instrument sizing technique) which was employed from the beginning in the NAFEC tests. The value of redundancy is the saving in time and money obtained by pinpointing the moment when instrument errors arise. All the engine performance data collected at NAFEC have been manually recorded. Due to human error mistakes are inevitable, but in almost all cases, they can be overcome by comparison of the various systems used during a test and referring to the photographed manometry data used at NAFEC as a backup and a double check of the manual readings. It is felt that the use of independent systems for measuring airflow has been of great value to NAFEC in all its tests.

The emphasis placed on airflow measurement accuracy at NAFEC might be considered to be overdone, but there is no question that an effort of this type must be made if satisfactory results are to be obtained from the tests.

Engine Cooling Air

The cooling air system used in all tests in the laboratory consisted of a high volume blower, ducting, airflow measuring station, and engine cooling hood. The quantity of cooling air supplied to the engine during the three power runs (takeoff, climb, and approach) was usually set by measuring a nominal pressure drop across the engine of 3 inches of water. At idle and taxi, no cooling air was supplied to the engine. It was felt that the quantity of engine cooling air would be of considerable importance to the program when determining the effect of fuel leanout mixture on emissions and the possible introduction of engine overtemperature problems. For this reason, a series of tests were run with each engine wherein the ΔP across the engine was related to the quantity of cooling air for that condition. Detailed information on the cooling air quantity was obtained for each engine by holding a constant power and varying the cooling air ΔP from 1.5 to 7 inches of water. There is a unique relationship between ΔP and pounds per hour of cooling air for each engine tested in the laboratory. This information could prove useful in relating the aircraft installation cooling airflows to those obtained on the test stand. The test stand cooling hood is not identical to the aircraft installation, but a relationship might be developed between the two.

Fuel Flow

The second major parameter to be measured on the input side of the equation is fuel flow. This, too, has a long history of techniques and methods. The measurement of fuel flow in some ways is easier than measuring airflow. For one thing, it can be physically weighed quite readily. This characteristic lends itself to easier calibrations of the

measuring instrument. As in airflow measurement, the major points to be covered are (1) type of instrumentation, (2) calibration and accuracy, and (3) redundancy.

Type of instrumentation. - It was decided at the outset of the program to use two types of instruments. A schematic of the full flow system is shown in figure 3-4. In measuring idle and taxi fuel flow, it was determined that some sort of dead weight or known volume technique would have to be used. This resulted from the nonsteadiness of engine operation found in the low power region. At NAFEC all idle and taxi fuel flows were measured with the use of a 250 ML burette and a timer. The amount of fuel, by volume, consumed during a fixed time period was found to be the most accurate and consistent method available. By making the time period of sufficient length, a good average value of fuel flow at low powers was obtained. In the same fuel line were low flow turbine meters and rotameters. But due to the manner in which fuel is brought into the engine, there were very large fluctuations in fuel flow readings at the idle power settings which would result in extremely large errors in fuel measurement if an insufficient time period for averaging the readings is not used.

Calibration. - At the start of the tests all the flowmeters were calibrated using AVGAS as the medium. The rotameter was not calibrated since it was felt that very little could go wrong with it and it would have delayed the start of the program. This was a poor assumption since later in the program discrepancies in fuel measurement developed and when the rotameter was calibrated it was found to be reading high by about 6 percent. All the data previously obtained from the rotameter were then corrected for this error. Since that time there has not appeared to be any problem associated with either the rotameters or the turbine meters.

Redundancy. - As in the case of airflow measurement, the fuel flow system had redundant instrumentation for both taxi-idle and high power tests. The taxi-idle redundancy was ineffective at idle in most cases. But at taxi where the engine operated more consistently, the agreement between the burette measurement and the turbine flowmeter was usually very good. The schematic of the overall fuel system is helpful in understanding the sizing and redundancy incorporated in the system.

The accuracy for fuel flow measurement which was obtained in the NAFEC tests is ± 1.0 percent at high powers and ± 2 percent at taxi and idle.

AIR AND FUEL FLOW MEASUREMENT RECOMMENDATIONS

As a result of the experience at NAFEC, the recommendations are as follows:

(1) Air and fuel flow measurements should be made with instrumentation which considers the factors of instrument accuracy, proper sizing, and redundancy of measurements during all tests.

(2) The target accuracies should be at least ± 1 percent at high powers, ± 2 percent at idle and taxi for fuel flows, and ± 2 percent and ± 3 percent for airflow at high powers and taxi/idle, respectively.

(3) A relationship between actual cooling airflow and pressure drop across the engine for all engine test stand configurations should be developed. This would be useful in relating aircraft installed cooling to test stand cooling.

DESCRIPTION OF NAFEC'S EMISSIONS MEASURING SYSTEM

Emission Analyzers

The instrumentation used to monitor the exhaust emissions from general aviation piston engines was basically the same as that recommended by EPA but with a number of modifications and additions to enhance the reliability and accuracy of the system. A schematic of the emissions measurement system is shown in figure 3-5. The basic analysis instrumentation utilized for this system, which is summarized in figure 3-6, is as follows:

Carbon dioxide. - The carbon dioxide subsystem is constructed around a Beckman Model 864-23-2-4 Nondispersive infrared analyzer (NDIR). This analyzer has a specified repeatability of ± 1 percent of full scale for each operating range. The calibration ranges on this particular unit are as follows: range 1, 0 to 20 percent; range 3, 0 to 5 percent. Stated accuracy for each range is therefore ± 0.2 percent CO_2 and ± 0.05 percent CO_2 , respectively.

Carbon monoxide. - The subsystem used to measure carbon monoxide is constructed around a Beckman Model 865-x-4-4-4 NDIR. This analyzer has a specified repeatability of ± 1 percent of full scale for ranges 1 and 2 and ± 2 percent of full scale for range 3.

Range 1 has been calibrated for 0 to 20 percent by volume, range 2 for 0 to 1000 ppm and range 3 for 0 to 100 ppm. The wide range capability of this analyzer is made possible by using stacked sample cells which in effect give this analyzer six usable ranges when completely calibrated.

Effects of interfering gases, such as CO_2 and water vapor, were determined and reported by the factory. Interferences from 10 percent CO_2 were determined to be 12 ppm equivalent CO and interferences from 4 percent water vapor were determined to be 6 ppm CO equivalent. Even though the interference from water vapor is negligible, a condenser is

used in the CO/CO₂ subsystem to eliminate condensed water in the lines, analyzers, and flowmeters. This condensation would have decreased analyzer sensitivity and necessitated more frequent maintenance if it had not been eliminated.

Total hydrocarbons. - The system that is used to measure total hydrocarbons is a modified Beckman Model 402 heated flame ionization detector. This analyzer has a full-scale sensitivity that is adjustable to 150 000 ppm carbon with intermediate range multipliers of 0.5, 0.1, 0.05, 0.01, 0.005, and 0.001 times full scale.

Repeatability for this analyzer is specified to be ± 1 percent of full scale for each range. In addition, this modified analyzer is linear to the full-scale limit of 150 000 ppm carbon when properly adjusted. The two major modifications to this analyzer were the installation of a very fine metering valve in the sample capillary tube and the installation of an accurate pressure transducer and digital readout to monitor sample pressure. Both of these modifications are necessary because this analyzer is extremely pressure sensitive as shown in figures 3-7, 3-8, and 3-9. Correct instrument response depends on the amount of sample passing through a capillary tube. If there is too high a sample flow the analyzer response becomes nonlinear when a high concentration gas is encountered. Sample flow may be controlled by varying the pressure on this capillary or increasing the length of the capillary. On this particular analyzer, linearity to 50 000 ppm carbon was obtained by reducing the sample pressure to 1.5 psig. However, the need for linearity to 120 000 ppm carbon was anticipated. Further reduction of the sample pressure increased the noise level of the analyzer to an unacceptable level. In order to reduce the flow through the capillary without using a lower pressure, either the length or the resistance of the capillary had to be increased. The standard modification for this analyzer to limit flow is the installation of an additional length of capillary tubing. This procedure requires trial and error determination of proper capillary length and is a permanent modification that limits sensitivity at low hydrocarbon levels. By installing a metering valve in the capillary, flow could be selectively set at either low flow for linearity at high concentrations or high flow for greater sensitivity at low concentrations. Installation time was reduced by eliminating the cut-and-try procedure for determining capillary length.

The addition of a sensitive pressure transducer and digital readout to monitor sample pressure was needed since the pressure regulator and gage supplied with the analyzer would not maintain the pressure setting accurately at low pressures. Using the digital pressure readout, the sample pressure could be monitored and easily maintained to within 0.05 in. H₂O.

Oxides of nitrogen. - Oxides of nitrogen are measured by a modified Beckman Model 951H atmospheric pressure, heated, chemiluminescent ana-

lyzer (CL). This analyzer has a full-scale range of 10 000 ppm with six intermediate ranges. Nominal minimum sensitivity is 0.1 ppm on the 10 ppm full-scale range.

The atmospheric pressure analyzer was chosen because of its simplicity, ease of maintenance, and compactness. Anticipated water vapor problems in the atmospheric pressure unit were to be handled by the heating of the internal sample train. Interference from carbon dioxide quenching, common in the atmospheric pressure type CL analyzers, was checked and found to be nonexistent.

A series of major modifications were performed by the manufacturer on this analyzer to insure compliance with specifications. One such modification was installed in order to maintain the temperature of the sample stream above the dew point of the sample gas. Originally this analyzer was specified to maintain a temperature of 140° F at all points in contact with the sample. After a survey of the 951H analyzers in use on FAA projects it was determined that this temperature was not being achieved because the method used to heat the components was inadequate. A recommendation was made to the manufacturer to install a positive method of heating the sample tube compartment and reaction chamber that would be thermostatically controlled. In time the modification was made and this problem was eliminated. Increasing the temperature of the internal sample components eliminated the condensed water problem; however, the elevated temperature caused an instability in the photomultiplier tube output. Another recommendation was made to thermostatically control the temperature of this tube. This was accomplished by installing an electronic cooling jacket designed to maintain the photomultiplier tube at a constant temperature below the internal case temperature.

A further modification required on this analyzer was the addition of a flow control valve to adjust and balance the flow rate through the NO and NO_x legs. This valve replaced a restrictor clamp that was used by the manufacturer to set the NO to NO_x flow balance. The problem that was encountered with this clamp was that it was not a positive method of adjusting the restriction on the capillary. The clamp compression was affected by the flexible material on which the clamp was mounted and the variable flexibility of the teflon capillary as it was heated. This caused the restriction on the capillary to change with time after it was set and caused permanent deformation of the capillary allowing only adjustment that would increase the restriction.

Oxygen measurement. - Oxygen is being measured by a Beckman Model OM-11 oxygen analyzer. This analyzer uses a polarographic type sensor unit to measure oxygen concentration. An advanced sensor and amplification system combine to give this analyzer an extremely fast response and high accuracy. Specified response for 90 percent of final reading is less than 200 ms with an accuracy of less than ±0.1 percent O₂. Ranging on this unit is a fixed 0 to 100 percent O₂ concentration.

Description of Sample Handling System

Exhaust samples are transported to the analysis instrumentation under pressure through a 35-foot-long, 3/8-inch o.d., heated, stainless steel sample line. The gas is first filtered and then pumped through this line by a heated Metal Bellows Model MB-158 high temperature stainless steel sample pump. The pump, filter, and line are maintained at a temperature of $300^{\circ}\pm 4^{\circ}$ F to prevent condensation of water vapor and hydrocarbons. At the instrumentation console, the sample is split to feed the hydrocarbon, oxides of nitrogen, and CO/CO₂/O₂ subsystems which require different temperature conditioning. The sample gas to the total hydrocarbon subsystem is maintained at 300° F while the temperature of remaining sample gas to the NO_x and CO/CO₂/O₂ system is allowed to drop to 150° F. Gas routed to the oxides of nitrogen subsystem is then maintained at 150° F, while the gas to the CO/CO₂/O₂ subsystem is passed through a 32° F condenser to remove any water vapor present in the sample. Flow rates to each analyzer are controlled by a fine metering valve and are maintained at predetermined values to minimize sample transport and system response time. Flow is monitored at the exhaust of each analyzer by three 15-centimeter rotameters. Two system bypasses are incorporated into the system to keep sample transport time through the lines and condenser to a minimum without causing adverse pressure effects in the analyzers.

Filtration

Particulates are removed from the sample stream at three locations in the system (fig. 3-5). Upstream of the main sample pump is a heated clamshell-type stainless steel filter body fitted with a Whatman GF/C Glass Fibre paper filter element capable of retaining particles in the 0.1 micron range. A similar filter is located in the total hydrocarbon analyzer upstream of the sample capillary. An MSA Type H Ultra Filter capable of retaining 0.3 micron particles is located at the inlet to the oxides of nitrogen and CO/CO₂/O₂ subsystems. Filters located at these three locations allow the entire sample transport and analysis system to be free of particulate contamination, thereby minimizing downtime due to contaminated sample lines and analyzers.

IDENTIFICATION OF PROBLEM AREAS

Gas Analyzers

The analysis instrumentation that is available from the manufacturer for most gases will perform reliably once this equipment is properly assembled and checked out. However, the majority of instrumentation purchased by the FAA and its contractors for exhaust gas

analysis was not in operating condition when received from the factory. In most instances, the problems that were encountered with the analysis instrumentation were due to the lack of adequate quality control and inspection on the part of the individual instrument suppliers. For example:

(1) Amplifier board missing on the Model 402 Total Hydrocarbon analyzer.

(2) Malfunctioning temperature control board on the Model 864 CO₂ analyzer.

(3) Damaged sample capillary, NO₂ to NO converter temperature set 200° too low, and photomultiplier tube voltage set too low on the Model 951H NO_x analyzer.

(4) Jammed interrupter blade and loose power supply assembly in the Model 315B CO analyzer.

All of these problems were corrected by the manufacturer's field service technician at no cost. However, all of these problems resulted in delays in the FAA test program.

Other problems with the basic instruments, not related to quality control, were encountered and to varying degrees corrected in the course of emissions research and testing at NAFEC. Use of the high temperature version of the hydrocarbon analyzer as recommended by the EPA led to a problem of linearity at high hydrocarbon levels. This high temperature flame ionization detector was originally intended to measure heavy molecular weight hydrocarbons which could possibly condense in an unheated sample system. Generally, internal combustion engines which emit these heavier hydrocarbon exhaust products do so at concentrations less than 10 000 ppm carbon (or ppmc). The burner characteristics of this heated analyzer as supplied from the manufacturer prevent linear operation above 10 000 ppmc using the sample pressures and flows specified in the operating instructions. Aircraft piston engines at certain power modes emit hydrocarbons above this 10 000 ppmc linear cutoff point. The response of the flame ionization detector above 10 000 ppmc is such that operation in this range through the use of a calibration curve would be extremely insensitive. The modification made to the Beckman flame ionization detector used at NAFEC was described in the section on that instrument. The Scott Model 215 total hydrocarbon analyzer used by one FAA contractor was also modified to produce more linear results at high concentrations. Flows were reduced in this analyzer by inserting a fine wire into the sample capillary tube thereby increasing the restriction imposed by the capillary and in turn lowering the sample flow rate to the burner. Both modified analyzers now produce linear results to approximately 125 000 ppmc.

The use of the Chemiluminescent (CL) analyzer to monitor oxides of nitrogen emission is specified by the EPA. This type of instrumentation has just recently been recommended for the measurement of turbine engine exhaust where the concentration of known interfering gases are low. The vacuum chemiluminescent analyzer was well able to handle water condensation problems in the low water environment of turbine engine exhaust. Also, interference of other gases, such as hydrocarbons and carbon monoxide, in thermal NO_2 to NO converter operation did not present a problem because of their relatively low concentrations. Water vapor contamination in the atmospheric pressure CL analyzer during turbine testing was handled satisfactorily by line heating although frequent cleaning of the reaction chamber assembly was required.

Many major problems were encountered when attempting to adopt this turbine instrumentation to the more severe environment encountered in direct exhaust sampling from piston engines.

At NAFEC, instrumentation that was used to measure emissions from turbine engines was adapted and modified for use in piston engine measurements. The original unheated CL analyzer was unable to function properly in the presence of high exhaust water vapor. Initially, a permeable membrane-type dryer was used to precondition the exhaust sample before entering the CL analyzer. Generally, the use of dryers in the oxides of nitrogen system is not recommended. However, the use of a membrane dryer avoided the possible loss of the sample usually found when using conventional water traps, condensers, or desiccants and therefore was considered satisfactory. Preliminary tests of this dryer indicate that there is little or no loss of NO or NO_2 gas in the sample after being dried in this manner. To eliminate a continued need for a drying system, a heated chemiluminescent analyzer was purchased. This analyzer was designed to maintain the temperature of the incoming sample gas above the dew point of the sample gas. All internal components that came in contact with the sample were enclosed in a heated chamber which was heated by the NO_x thermal converter boot. This method of heating proved totally unsatisfactory. After undergoing the major modifications described earlier, this instrument now satisfactorily analyzes wet exhaust samples.

Another problem encountered in other CL analyzers which was not encountered in the Beckman unit used at NAFEC was the inability of the NO_2 to NO thermal converter to operate efficiently in the low oxygen, high carbon monoxide environment of piston engine exhaust. Early in the program, the heated stainless steel tube type converter exhibited a tendency to eliminate any NO in the sample when passed through the converter in the presence of high concentrations of CO and low concentrations of O_2 . This deficiency in the early stainless steel converter was never eliminated; however, other types of converters, particularly the molybdenum alloy type have been used with varying degrees of success. To date the proprietary material used in the Beckman converter seems to pose little or no problems in the measurement of oxides of nitrogen.

Sampling System

The majority of problems affecting the analysis instrumentation were found to be in the sample handling systems. Systems that were purchased assembled from the vendor were found to have many tubing connections loose and leaking. A leak in the sample system may affect the performance of the system in one of two ways. If a large leak was located downstream of a sample pump, it would cause a loss of sample pressure to the analyzers, affecting response and instrument performance. If the leak was located upstream of a sample pump, it would tend to dilute the sample and give erroneous emissions readings. The result of even a small leak upstream of a pump could possibly go undetected for some time and cause incorrect data to be collected. Once again, many of the problems of sample leakage could have been prevented during system assembly had adequate quality control procedures been in effect.

Assuming that the system had been carefully assembled, small leaks may still develop during continuous operation of the equipment. Installation of a large capacity sample pump as near the sample probe as possible would prevent any leakage from diluting the sample.

To avoid problems of water vapor condensation, sample lines upstream of the water trap should be heated. The recommended sampling system as outlined by the EPA specifies that all lines upstream of the water trap should be heated to 300° F. This requirement has caused problems with the ability of the water trap to remove water vapor in the CO/CO₂/O₂ subsystems. At the flow rates required to keep sample transport time below 2 seconds, gas at a temperature of 300° F is unable to be cooled sufficiently in the condenser to remove enough water; consequently, the remainder of the water vapor will condense out in the CO or CO₂ analyzers or flowmeters. It has been found that maintaining a sample line temperature of 150° F in the section of sample line between the total hydrocarbon analyzer and the oxides of nitrogen analyzer and the water trap gives the sample gas enough time to chill while passing through the water trap, and yet maintain the sample gas above its dew point ahead of the oxides of nitrogen analyzer. Care must be taken to insure that any flowmeters that are in a heated leg of the system are either heated or well insulated. Unheated flowmeters on the exhaust ports of both the total hydrocarbon and oxides of nitrogen analyzers will cause erroneous readings due to back pressure on the analyzers from the condensed water.

Calibration Gases

The most troublesome problem encountered in the use of emissions measurement equipment is finding calibration gas standards reliable enough to accurately calibrate the instrumentation. This problem is

especially evident when dealing with low concentrations of unstable gases such as oxides of nitrogen and carbon monoxide. These gases, when used in concentrations below 1000 ppm, have a tendency to be very sensitive to changes in cylinder pressure and ambient temperature, and, when stored over a period of time, they tend to change concentration unpredictably (fig. 3-10). The effect of cylinder type on stability of NO₂ is shown in figure 3-11. However, the impact of this stability problem on piston engine emissions measurements is limited to the analysis of oxides of nitrogen since concentrations of carbon monoxide which are used in these measurements are much above the unstable 1000 ppm level. Instability and mixing problems associated with the other gases (CO, CO₂, O₂, and C₃H₈) do not present a problem in the higher concentrations used in calibrating for piston engine tests. Problems in these gases arise because of poor quality control while analyzing these gas mixtures at the supplier's laboratory. Therefore, accuracy levels claimed on the analysis certificates should be used with caution.

An in-house calibration gas acceptance program should be instituted to insure repeatability of data throughout a test series. This program would insure that no major shifts in instrument calibration occur because of improperly certified calibration gases. By using in-stock calibration gases to verify new gases as they are purchased, a new gas which deviates from the certified concentration by more than the manufacturer's tolerance would be discovered and then should be returned to the supplier for reanalysis. A gas that is within the manufacturer's tolerance should be labeled as to the exact in-house analyzed concentration and used as that concentration from the on. This method insures that data from one system always will be repeatable. However, this method does not insure that the data will be consistent between laboratories.

One method of insuring consistency among laboratories is to participate in a calibration cross reference service. This service statistically compares the results of each laboratory's analysis of a referee gas. To be of real value, this service should coincide with the required monthly instrumentation calibration and should provide for immediate feedback as to the accuracy of each laboratory's analysis.

Accuracy of Emission Systems

Accuracy of emissions data depends on many parameters, least of all published instrument accuracy. When surveying the published instrument specifications, it is clearly evident that most instrumentation designed to be used for exhaust emission measurements meets the requirements set forth by EPA. However, whether or not this instrumentation lives up to its design specifications during actual field use is more a function of calibration accuracy and system reliability. Assuming that the gases used to calibrate the analysis instrumentation have all been verified

and the instrumentation is functioning properly, the method used to obtain the analyzer calibration curves is critical. Analyzer specifications claim repeatability of ± 1 percent of full scale. This repeatability can be translated to instrument accuracy only at the exact points of calibration. At any other point within the range of the analyzer, the reading is only an estimate based on a best fit curve drawn through these calibration points. This, therefore, means that the accuracy of the data is dependent on how well this best fit curve follows the actual behavior of the analyzer.

Determining the proper calibration curve for each analyzer requires that the basic shape of the curve be known. The total hydrocarbon analyzer (FID), oxides of nitrogen (CL) analyzer, and oxygen analyzer are known to be linear up to a predetermined limit. Therefore, a best fit curve based on a linear regression should be used to determine the calibration curve for these analyzers. A minimum of three verified calibration gas standards must be used to determine these curves. The infrared analyzers used to measure carbon monoxide and carbon dioxide are known to be nonlinear. By using a third degree polynomial regression, a best fit curve for these two analyzers may be found that very closely approximates the behavior of these analyzers. A minimum of five verified calibration gas standards should be used to determine these curves.

Both regression methods generate calibration curves which fall within the ± 1 percent accuracy levels of the analyzers.

EMISSIONS MEASUREMENT SUMMARY

Emission measurement instrumentation commercially available will reliably and accurately measure exhaust from piston engines provided the instruments are functioning according to design specifications, are properly calibrated, and used on a regular basis. Care must be taken when purchasing this equipment to specify exactly the operating conditions under which the instrumentation is to be used and the performance expected of the system. Each system or component should be checked thoroughly for compliance with specifications prior to being accepted from the vendor. Calibration gas standards should be verified prior to being used to calibrate the instrument. A sufficient number of calibration points must be used to insure that the calibration curves determined for each analyzer accurately predict the behavior of each analyzer. Also, a periodic interlaboratory calibration cross reference check should be made to insure that data collected are compatible from laboratory to laboratory. Reliability and accuracy of analysis instrumentation is greatly enhanced if the instrument is calibrated and operated on a regular basis. A preventative maintenance and calibration schedule could be established if the instrument is used in this manner. The possibility of further simplifying the analysis system and determining the cause of variability in piston engine emis-

sion measurements should be investigated. The cumulative effect of individual measurement uncertainties on final emissions data accumulated should also be determined.

TEST PROCEDURES

To understand the tests it is necessary to describe the EPA cycle. In the cycle, EPA specifies an idle-taxi operation of 12 minutes duration at startup, a 0.3-minute operation at takeoff power, a 5-minute climb, a 6-minute approach, and a 4-minute idle/taxi operation coming in. At the outset of the program, it was decided to run at both idle and taxi in order to develop information at both powers. The idle power was selected at 600 rpm and taxi at 1200 rpm with the time in modes at 1 and 11 minutes, respectively, when going out and a 3-minute taxi and 1-minute idle coming in.

The 7-mode baseline shown in figure 3-12 is conducted in sequence, but the time in mode for computing emissions is a calculated value. The actual test time in mode for any run is about 5 minutes. This is because it takes about that long to set the power conditions, stabilize the engine, and record the values of engine performance and emissions. In conducting the 7-mode tests it has been observed that idle and taxi going out are not necessarily identical with taxi and idle in. This is attributed to the fact that at start up the preconditioning of the engine consists only of starting and running the engine until the oil is heated up to a specified temperature. During this warmup period, some buildup of carbon, oil past the rings, etc., will occur and this will be reflected in the emissions measured. After the idle run, the taxi condition is set with no clear-out of the engine and this too will have an impact on the measured emissions. However, at taxi in, which follows a sequence of high power runs which have cleared the engine out, the emissions usually are lower than those measured at taxi out. The same is usually true for idle in.

The previous observations indicate that the level of emissions can be changed by varying the procedure used during the testing. It also should be recognized that the impact of the idle-taxi modes in the 7-mode baseline is quite significant. The total time for the cycle is 27.3 minutes. Admittedly, the rate of emission production is low at idle and taxi, but the time in mode is sufficiently long to have a considerable impact on the overall emissions level.

In the course of the tests it became apparent that the yardstick for determining whether data were acceptable or unacceptable was rather broad at the three high powers. The data at takeoff, climb, and approach were usually consistent for all the engines tested and agreement between measured and calculated fuel-air ratio was high (i.e., probably 90 percent or more of these tests produced acceptable data). At idle

and taxi, the degree of acceptability was considerably lower with idle power providing the lowest percentage of acceptable data. This can be attributed to a variety of causes: (1) the engine is not running in a true steady-state condition at idle power where rpm fluctuations are rather wide while data are being collected, (2) the combustion process is not consistent and wide fluctuations in emissions are recorded during a test, and (3) the effect of cylinder-to-cylinder variations is more pronounced and these variations are reflected in the wide band of emissions recorded. The same comments which are made for idle power can be cited for taxi, but on a reduced level. The acceptability of data at taxi is much higher than that at idle, probably there are only 50 percent as many unacceptable test points run at taxi as at idle.

Recognizing these limitations of the 7-mode cycles, it has been suggested by the various participants in the program that a 5-mode cycle be used as the basic measuring medium for pollution tests. What is being suggested is the use of a 5-mode cycle (fig. 3-13) which eliminates idle tests at the beginning and end and adds 1 minute to both taxi modes. The results obtained from this type of test are slightly more conservative (i.e., the emissions are slightly higher) than those obtained when computed from a 7-mode cycle. However, the degree of accuracy of data obtained, the repeatability of the data, and the capability of setting the conditions at taxi are considerably greater. A comparison of a typical 7-mode and 5-mode cycle (fig. 3-14) using the same data results in agreement between the two types of cycles within 5 percent. With all the problems which occur in attempting to measure emissions accurately at idle, it would seem that this effort offers only a very slight increase in information about emissions. This is true especially when it is realized that the degree of accuracy suffers a sharp decline when going from taxi to idle power. This modification to the basic cycle emission calculation should be considered in the light of the previous comments. At any rate, all the tests at NAFEC are being run with the 7-mode cycle and can readily be modified to a 5-mode cycle in the computation procedure.

The tests conducted at NAFEC and at the engine manufacturers have all been of two types, 7-mode baselines and lean-out runs at all powers. The lean-out runs are conducted by setting the power at full rich and taking a reading of emissions. The next test is set at an incrementally reduced fuel flow. Usually a series of four tests is made at each power (i.e., from full-rich to 12 or 15 lb lean). The information gained from these tests is quite useful in that acceptable data produce smooth curves when they are plotted with F/A ratio versus pollutant in pounds per hour. Unacceptable data become very apparent when plotted in this way. In addition, when such tests are run under different ambient conditions, the curves produced can be useful in determining the impact of temperature and humidity on the emissions. For purposes of correlating data from different facilities, the use of lean-out runs is a necessity. A 7-mode baseline yields information which is

unique to the conditions under which it was run.

It is difficult to compare baseline bargraphs with any degree of accuracy unless identical ambient conditions prevail for the tests under comparison. The use of lean-out tests, however, provides a more convenient mechanism for comparison or analysis of the data. Tests at different ambient conditions can generate lines of pollutant against F/A ratio which can serve as guidelines for interpolation or extrapolation to other ambient conditions. In this way data can be compared and evaluated.

Lean-out tests can be used to generate 7-mode or 5-mode baselines and bargraph presentations can be made from these curves. The use of lean-out testing in this way can yield more consistent information on the cycle emissions, since the curves themselves eliminate the randomness which occurs in any individual test point. The accumulated tolerances of the emission measurements instrumentation and the fuel and air measurements alone could render all data unacceptable. On a statistical basis, however, this result does not occur. However, some of this randomness of data can be eliminated by the use of lean-out tests in developing total cycle emission values.

The lean-out curves are also useful in constructing hypothetical flight profiles for an engine. Thus, at takeoff, climb, approach, and taxi, specific F/A ratios can be selected, and the emissions from this cycle can be determined without actually trying to set the engine conditions on the stand. Application of this principle is also very useful in comparing data from facility to facility. Assuming that the data on the engine are taken over a range of ambient conditions, which can be used for interpolation or extrapolation, a direct comparison of cycle emissions can be developed for purposes of comparison. The lean-out tests therefore can be extremely useful and should also prove to be quite valuable in assessing emissions when corrected to an agreed upon standard. It is felt, therefore, that a very significant contribution to accurate and usable data on emissions can be obtained by the use of lean-out tests at the various powers.

DISCUSSION

- Q - G. Kittredge: Your arguments and recommendation for deletion of the idle power setting were very persuasive and certainly the data seem to be unharmed by such a change. We do owe you a response to that recommendation. Is there someone here today with aircraft design orientation that can comment on Bob's recommendation and say whether the idle power setting is a realistic power setting in the context of the way such aircraft are really operated?
- A - L. Helms: The 1 minute of time allocated to idle is not particularly significant one way or the other. There is the more far reaching impact, however, of eliminating that 1 minute of idle per se and trying to build an automatic mixture control system to take into account all of those conditions. We'll see later the possibility of taking perhaps the worst, which might be climb or maybe takeoff, and scheduling a mixture control approach to reduce all of the pollutants and certainly CO. Our problem would be dramatically easier if we would eliminate just one mode, which in this case is the idle with only 1 minute. I would certainly encourage it - particularly in view of the fact that I noticed on your chart you could tell no difference between the 5 and 7 modes. From our viewpoint it could only help us significantly and certainly would reduce the magnitude of the complexity of the problem.
- Q - M. Steele to S. Imbrogno: I was very impressed with the magnitude of the errors that you could get from the Beckman instruments. Since most of us use these same instruments, at what point were the improvements made in the Beckman instruments? In particular, if you go back to the pre-1973 era, are we dealing with instruments that were grossly inaccurate or did I misunderstand some of the comments that were made?
- A - S. Imbrogno: You are speaking of which analyzer in particular? The errors in the CO and CO₂ are very small. The modifications we made in the hydrocarbon analyzer really only affected the very high emission levels. At the lower emission levels, such as approach and possibly takeoff and climbout, the modifications we made didn't affect the measurements at all.
- Q - M. Steele: What about the variations in NO_x measurements?
- A - S. Imbrogno: The problem with the analyzer was more of an operational problem. The operation of the analyzer would degrade and we'd have to stop testing and repair the analyzer. It didn't particularly affect the data once the analyzer was operating properly.
- Q - B. Westfield to S. Imbrogno: In the automotive field they use a bag collection system. Do you feel that there would be any benefit for aircraft systems to go to that same type of a system; and, secondly, could the manufacturers give me their comments on the same point?
- A - S. Imbrogno: Using the constant volume sample with the bags would be adding another piece of instrumentation; however, it would

eliminate problems with high concentrations that are measured for piston engines. You'd be bringing the concentrations down in the ppm range and would be eliminating the problem of nonlinearity in the hydrocarbon measurements at the high end. Also, it would possibly be eliminating the water problem in the chemiluminescence analyzer.

COMMENT - T. Cackette: One problem with the CVS system is that you don't get a heated hydrocarbon measurement. It's going to be difficult to heat a flow to 300° F that's diluted with 300 CFM of dilution air - which is what happens in an automotive system.

COMMENT - L. Duke: Initially we are against a bag collection system because we trade one problem for another. We do have high hydrocarbon concentrations and water problems with exhaust emissions in the NO_x detector. When we look at the magnitude of these problems as far as we have refined the instrumentation today, we have reduced them so that those problems are not a factor in trying to pass the Federal Standards. If we go to the bag system then we have a new set of problems. Instead of looking at high concentrations we are now looking at low concentrations as we stated in the ppm range with a new set of problems to define. What you are saying is let's throw out all the work we've done to date and start fresh. We aren't in the position to do that and my first response would be to say no for that reason and also for increased complexity in the test cycle and test procedures which we'd have to start working with now.

COMMENT - K. Stuckas: First of all, I'd have to concur with Steven Imbrogno's remarks about the equipment, and second, at this time we feel we have the equipment in shape and are on top of the situation to the point of where we feel we can produce accurate results within the constraints of the exhaust emission standards as written in the Federal register. I don't feel there is any benefit or value in going to a bag system at this time, although we have tried it with very little success.

Q - H. Nay: This question is directed to those who have done emissions testing relative to fuels composition. There is a fairly broad range of content of aviation gasoline. For instance, the 100 octane low lead fuel contains a high content of aromatics relative to the regular 100 octane leaded fuel. Has there been any experience in regard to emissions measurements, analysis results, or that type of thing relative to the actual composition of the fuel? And is the a standard test fuel used in conjunction with emission measurements?

A - P. Kempke: NASA-Lewis has used the standard aviation reference fuel throughout our program. Although we have not made any experimental comparative tests, as a general comment in comparing our data to that generated by the industry for similar engines, there does not seem to be any difference that I would attribute to fuel differences. I believe the industry did not use the reference fuel but instead used the commercially available aviation fuel.

COMMENT - L. Duke: We did not use a standard reference fuel. We buy a commercially available fuel and each time analyze it for aromatic content, olefin lead content, and other things that would influence the hydrocarbon ratio in the calculation procedure. We did not use different fuels to try to characterize the effects on emissions.

COMMENT - W. Mirsky: If you look at the effect of hydrocarbons on the environment, you get into a very difficult situation when looking at the reactivity of the hydrocarbon exhaust. You measure total quantity of hydrocarbons but the type of hydrocarbons has a large effect on how they each affect the atmosphere. This requires a very elaborate analysis. A lot of this work has been done and supported by EPA. Dick Hurn of Bartlesville, Oklahoma, has done a lot of work and it was found that there may be as many as 200 different types of hydrocarbons in the exhaust as was shown in some of their early work. Methane and the single bond hydrocarbons are not very reactive and do not affect the atmosphere. The olefinic type of double bond hydrocarbons are reactive so you get into a complex situation if you start to analyze the affect of individual hydrocarbons. I think the major problem with aircraft engines is not so much the hydrocarbons as the CO and that's a much simpler problem.

INDUCTION AIR SCHEMATIC FOR 10-360B TESTS AT NAFEC

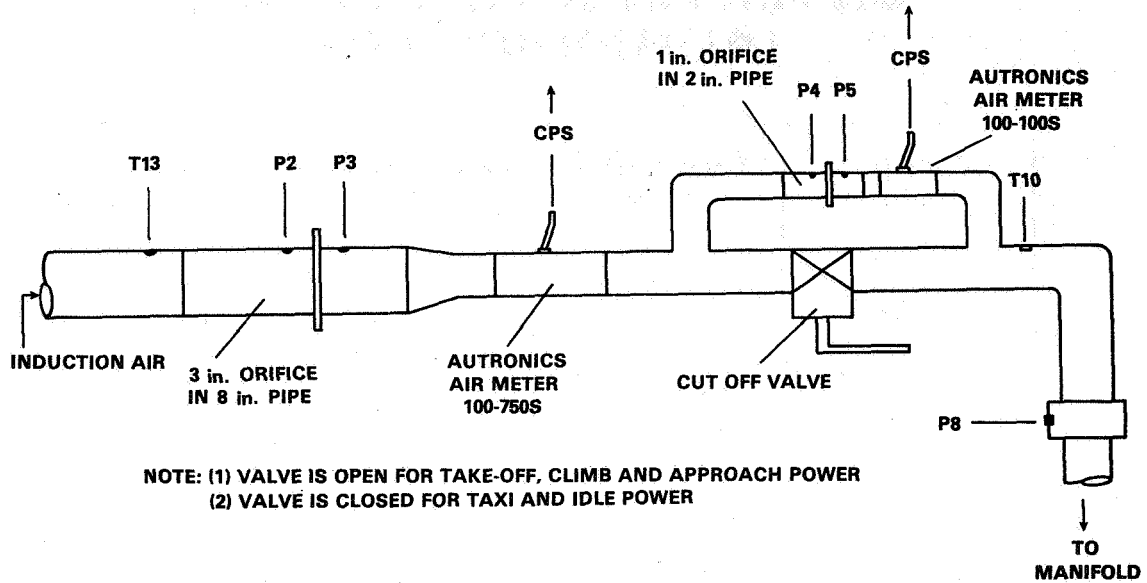

Figure 3-1

SIZING EFFECTS ON 3.8 in. ORIFICE IN 8 in. PIPE

<u>POWER SETTING</u>	<u>ΔP (in. H₂O)</u>	<u>AIR FLOW (lb/hr)</u>	<u>ΔP TOLER. (in. H₂O)</u>	<u>AIR FLOW TOLER. (lb/hr)</u>	<u>ACCURACY (%)</u>
TAKEOFF	4.0	1775	±0.05	±10	±0.5
IDLE	0.1	115	±0.05	±45	±39.1

INSTRUMENT RANGE: 0-2000 lb/hr WITH + 3 in. H₂O BLOWER PRESSURE

Figure 3-2

SIZING EFFECTS ON AIR FLOW TRANSDUCER (AUTRONICS 750S)

CPS	MEASURED CFM	CALIBRATION CURVE CFM	PERCENT DIFFERENCE
20	10	15	+ 50
57	40	44	+ 10
661	500	503	+ .6

INSTRUMENT RANGE: 0-600 CFM

Figure 3-3

FUEL FLOW SYSTEM PRIOR TO TIARA 6-285-B

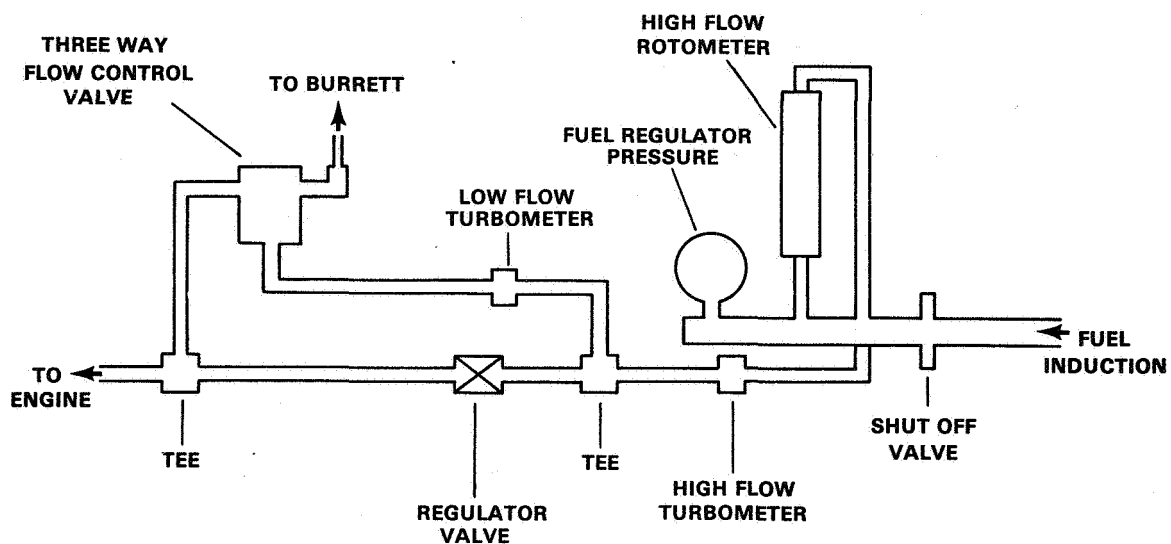

Figure 3-4

SCHEMATIC OF EMISSIONS MEASUREMENT SYSTEM

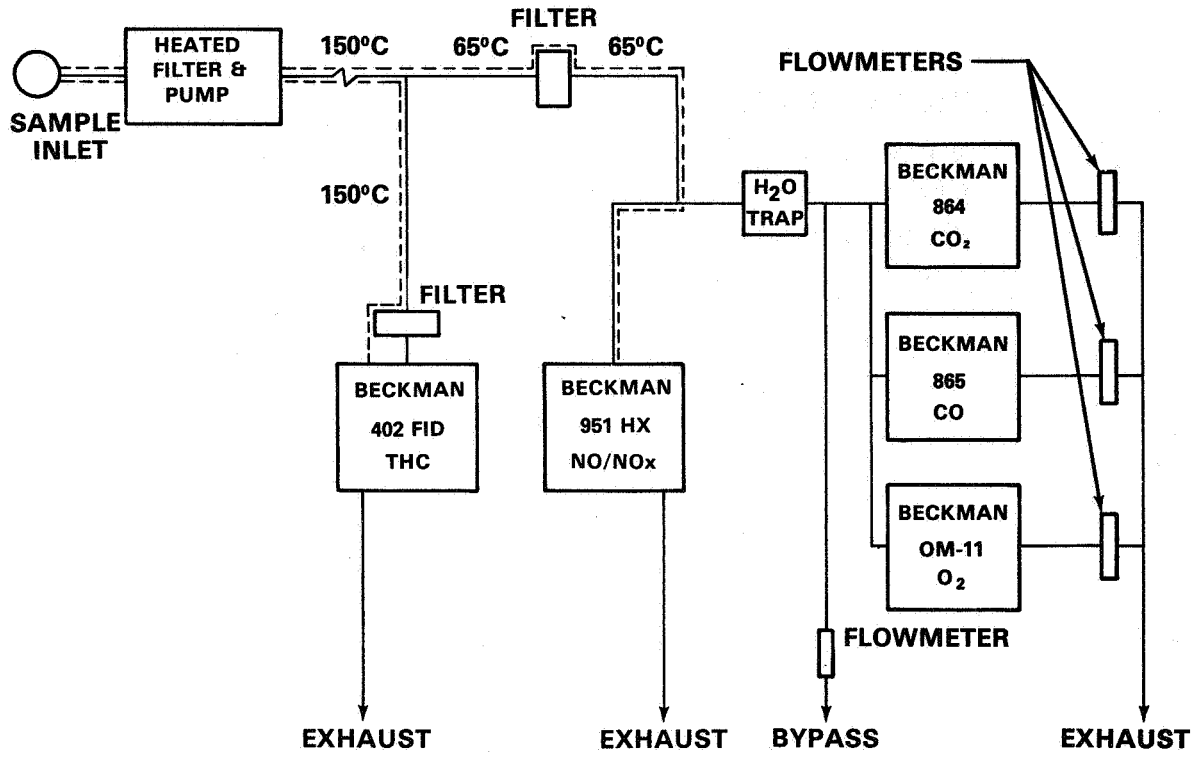

Figure 3-5

NAFEC EMISSION MEASUREMENT SYSTEM

- **CARBON DIOXIDE—CO₂**
 - NONDISPERSIVE INFRARED (NDIR)
 - RANGE 0-20%
 - REPEATABILITY ± 0.2% CO₂

- **CARBON MONOXIDE—CO**
 - NDIR
 - RANGE 0-20%
 - REPEATABILITY ± 0.2% CO

- **TOTAL HYDROCARBONS—THC**
 - FLAME IONIZATION DETECTOR (FID)
 - RANGE 0-150,000 ppm_c
 - MINIMUM SENSITIVITY 1.5 ppm_c
 - LINEAR TO 150,000 ppm_c

- **OXIDES OF NITROGEN—NO_x**
 - CHEMILUMINESCENT (CL)
 - RANGE 0-10,000 ppm
 - MINIMUM SENSITIVITY 0.1 ppm

- **OXYGEN—O₂**
 - POLARAGRAPHIC
 - RANGE 0-100%
 - REPEATABILITY 0.1% O₂
 - RESPONSE 200 ms

Figure 3-6

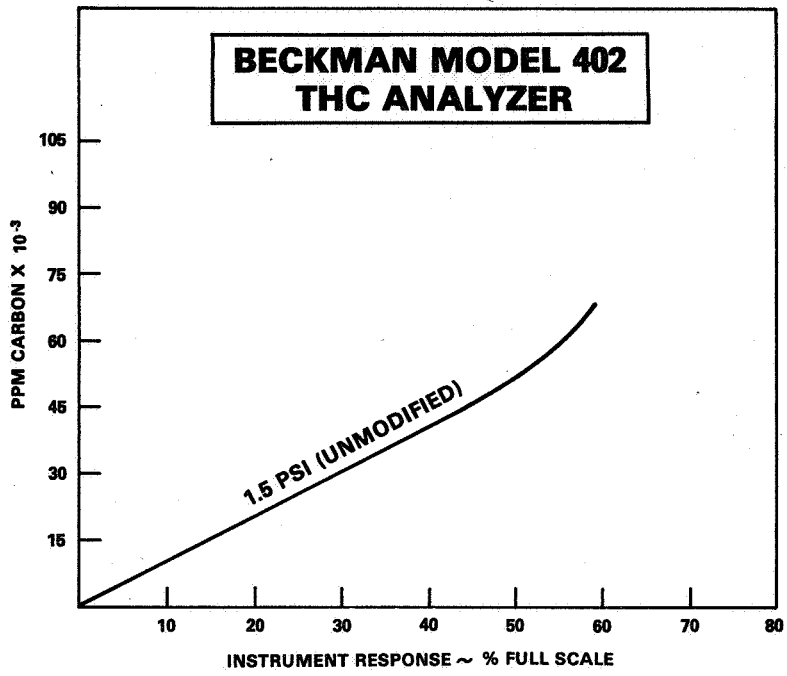

Figure 3-7

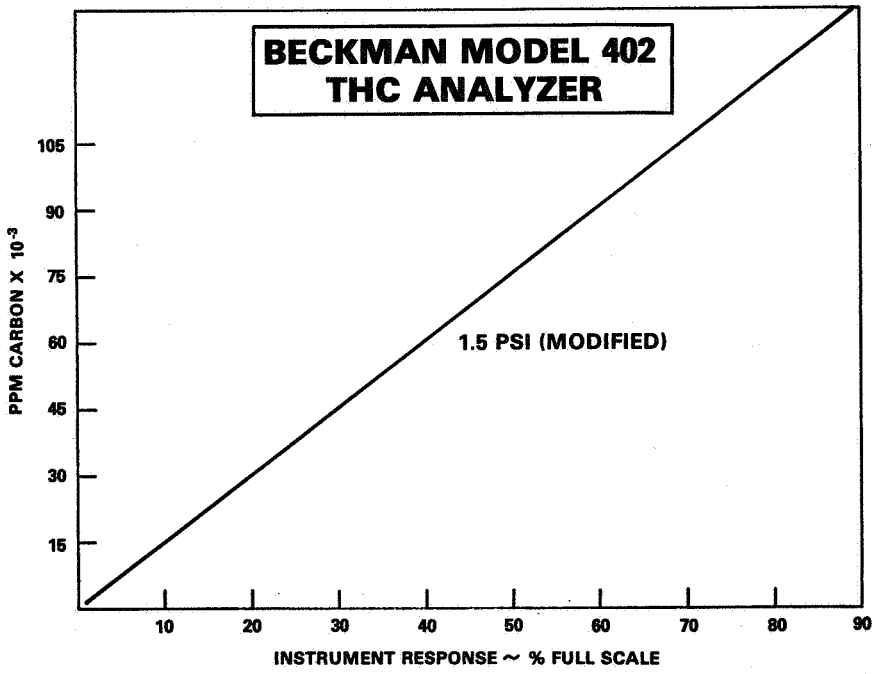

Figure 3-8

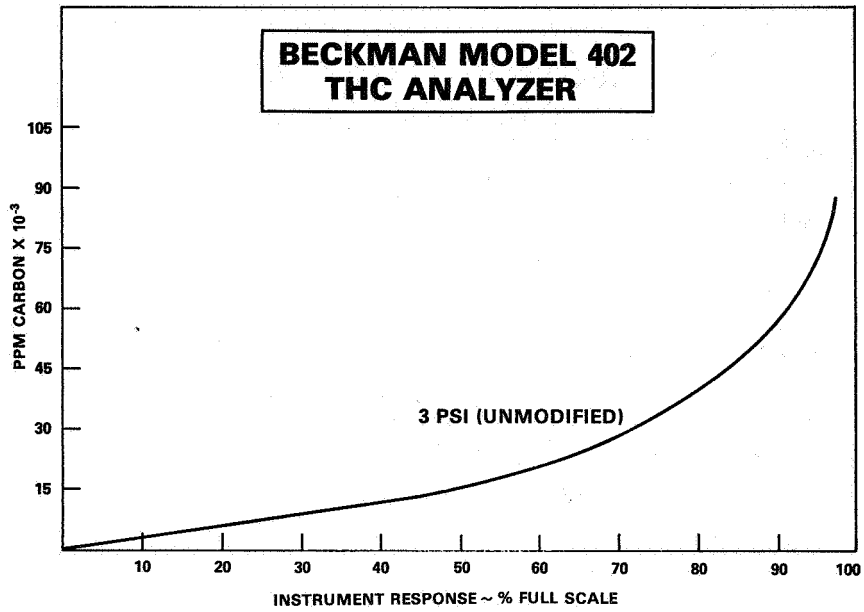

Figure 3-9

**STABILITY OF NITRIC OXIDE MIXTURES
(SOURCE-NBS)**

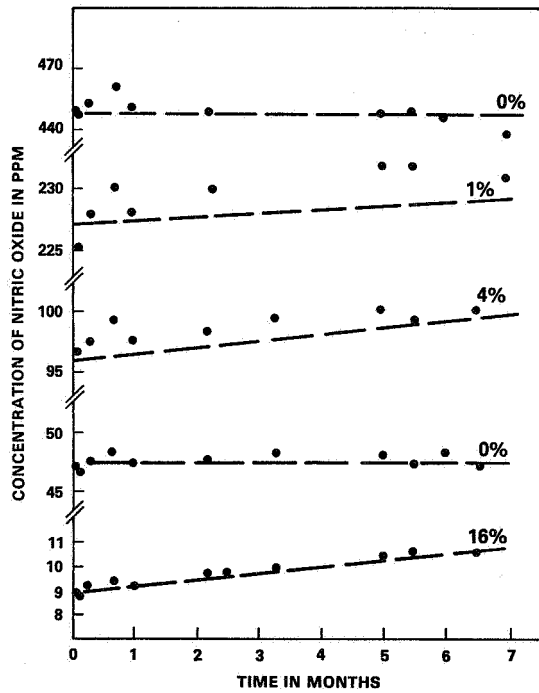

Figure 3-10

EFFECT OF CYLINDER TYPE ON STABILITY OF NO₂

<u>CYLINDER TYPE</u>	<u>ANALYSIS 2 MONTHS</u>	<u>ANALYSIS 2 YEARS</u>
WAX LINED	135 ppm	1 ppm
STEEL (Cr-Mo)	179 ppm	151 ppm
TREATED ALUMINUM	197 ppm	200 ppm

FILLED TO BE 200 PPM NO₂ IN N₂
(SOURCE—AIRCO INDUSTRIAL GASES)

Figure 3-11

DESCRIPTION OF 7 MODE BASELINE TEST FOR EMISSIONS

<u>TIME IN MODE</u>	<u>RPM</u>	<u>POWER</u>
1 MINUTE	600	IDLE OUT
11 MINUTES	1200	TAXI OUT
.3 MINUTE	2700*	TAKEOFF
5 MINUTES	2430*	CLIMB
6 MINUTES	2350*	APPROACH
3 MINUTES	1200	TAXI IN
1 MINUTE	600	IDLE IN

*NOMINAL RPM'S FOR MOST ENGINES TESTED

Figure 3-12

DESCRIPTION OF 5 MODE BASELINE TEST FOR EMISSIONS

<u>TIME IN MODE</u>	<u>RPM</u>	<u>POWER</u>
12 MINUTES	1200	TAXI OUT
.3 MINUTE	2700*	TAKEOFF
5 MINUTES	2430*	CLIMB
6 MINUTES	2350*	APPROACH
4 MINUTES	1200	TAXI IN

*NOMINAL RPM'S FOR MOST ENGINES TESTED

Figure 3-13

EFFECT OF DELETION OF THE IDLE MODE ON CYCLE EMISSION CALCULATION

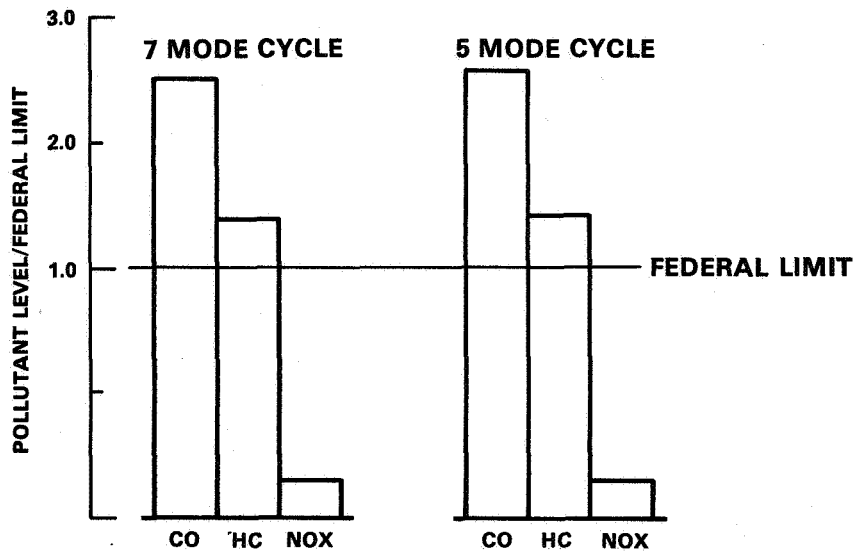

Figure 3-14