

Skylab Experiments

Volume 4 Life Sciences

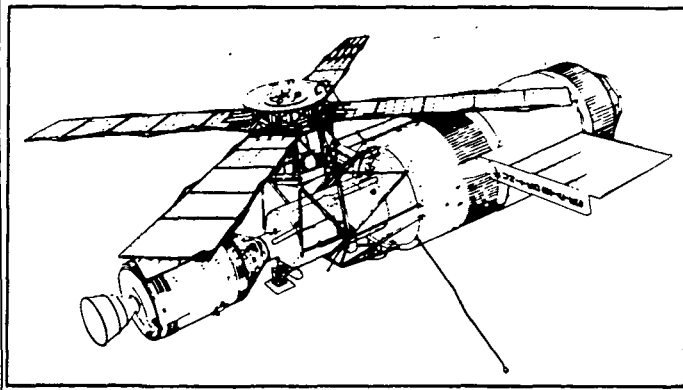

N74-10098
Unclas 19338
G3/05
CSCI 06B
(NASA-EP-113) SKYLAB EXPERIMENTS.
VOLUME 4: LIFE SCIENCES (NASA) 99 p
MF \$1.45; SOD HC \$2.60 Domestic Postpaid

Information for Teachers, Including Suggestions
on Relevance to School Curricula.

NATIONAL AERONAUTICS AND SPACE ADMINISTRATION

Skylab Experiments

Volume 4 Life Sciences

Produced by the Skylab Program and NASA's Education Programs
Division in Cooperation with the University of Colorado

NATIONAL AERONAUTICS AND SPACE ADMINISTRATION
Washington, D.C. 20546, May 1973

\$2.60 mail
\$2.25 bookstore

PREFACE

Characteristically, new scientific knowledge reaches general application in classrooms years after it has been obtained. This long delay stems, to a large extent, from a lack of awareness that information is available and that it has relevance to secondary school curricula. To accelerate this process, the National Aeronautics and Space Administration has prepared a series of documents concerning Skylab experiments to apprise the educational community in detail of the investigations being conducted in the Skylab Program, and the types of information being produced.

The objective is not to introduce the Skylab Program as a subject in the classroom, but rather to make certain that the educational community is aware of the information being generated and that it will be available for use. Readers are urged to use these books as an aid in planning development of future curriculum supplement material to make the most appropriate use of this source of scientific knowledge.

National Aeronautics and Space Administration
Washington, D.C. 20546
May 1973

CONTENTS

| | |
|---|-----------|
| SECTION 1—INTRODUCTION | 1 |
| SECTION 2—MINERAL AND HORMONAL BALANCE | 5 |
| Skylab Experiment M071, Mineral Balance | 11 |
| Skylab Experiment M073, Bioassay of Body Fluids | 13 |
| Skylab Experiment M078, Bone Mineral Measurement | 15 |
| SECTION 3—HEMATOLOGY AND IMMUNOLOGY | 17 |
| Skylab Experiment M111, Cytogenic Studies of the Blood | 23 |
| Skylab Experiment M112, Man's Immunity, <i>in vitro</i> Aspects | 25 |
| Skylab Experiment M113, Blood Volume and Red Cell Life Span | 27 |
| Skylab Experiment M114, Red Blood Cell-Metabolism | 29 |
| Skylab Experiment M115, Special Hematologic Effect | 31 |
| SECTION 4—CARDIOVASCULAR STATUS | 35 |
| Skylab Experiment M092, Inflight Lower Body Negative Pressure (LBNP) | 41 |
| Skylab Experiment M093, Vectorcardiogram | 43 |
| SECTION 5—ENERGY EXPENDITURE | 47 |
| Skylab Experiment M171, Metabolic Activity | 49 |
| SECTION 6—NEUROPHYSIOLOGY | 53 |
| Skylab Experiment M131, Human Vestibular Function | 53 |
| Skylab Experiment, Sleep Monitoring | 59 |
| SECTION 7—BIOLOGY | 65 |
| Skylab Experiment S015, Effects of Zero Gravity on Single Human Cells | 66 |
| Skylab Experiment S071, Circadian Rhythm—Pocket Mice | 69 |
| Circadian Rhythm—Vinegar Gnats | 72 |
| SECTION 8—CLASSROOM ACTIVITIES | 77 |
| SECTION 9—GLOSSARY OF TERMS | 87 |

INTRODUCTION

The Skylab Education Program

This year the United States' first manned scientific space station, Skylab, was launched into orbit to be the facility in which successive crews of astronauts can perform more than 270 scientific investigations in a variety of fields of interest. These investigations can be divided into four categories: physical sciences, biomedical sciences, earth applications, and space applications.

The Skylab Program will produce information that will enhance present scientific knowledge and perhaps extend the frontiers of knowledge on subjects ranging from the nature of the universe to the structure of the single human cell. It is the objective of the National Aeronautics and Space Administration that the knowledge derived from the Skylab Program's investigations be made available to the educational community for applications to high school education at the earliest possible date.

For this reason, the Skylab Education Program was created to assure that maximum educational benefits are obtained from the Skylab effort, documentation of Skylab activities is adequately conducted, and understanding of scientific developments is enhanced.

This document, one of several volumes prepared as part of the Skylab Education Program, has the dual purpose of (1) informing high school teachers about the scientific investigations performed in Skylab, and (2) enabling teachers to evaluate the educational benefits the Skylab Program can provide.

These books will define the objectives of each experiment, describe the scientific background on which the experiment is based, outline the experimental procedures, and indicate the types of data anticipated.

In preparing these documents an attempt has been made to illustrate relationships between the planned Skylab investigations and high school science topics. Concepts for classroom activities have been included that use specific elements of Skylab science as focal points for demonstrations of selected subjects. In some areas these address current curriculum topics by providing practical applications of relatively familiar, but sometimes abstract principles; in other areas the goal is to provide an introduction to phenomena rarely addressed in high school science curricula.

It is the hope of the National Aeronautics and Space Administration that these volumes will assist the high school teacher in recognizing the educational value of the information resulting from the Skylab Program which is available to all who desire to make use of it.

Application

Readers are asked to evaluate the investigations described herein in terms of the scientific subjects taught in secondary schools. The related curriculum topics identified should serve as suggestions for the application of Skylab Program-generated information to classroom activities. As information becomes available from the Skylab Program, announcements will be distributed to members of the educational community on the NASA Educational Programs Division mailing list. To obtain these announcements send name, title, and full school mailing list (including zip code) to:

National Aeronautics and Space Administration
Washington, D.C. 20546
Mail Code FE

This volume covers a broad spectrum of scientific investigations on Skylab that have been designed to improve man's understanding of himself and his physiological functions and needs. Additionally, a small group of related studies on the biochemical and biophysical behavior of lower organisms and single human cells in the weightless environment of space is included.

So that the reader will have a better understanding of the timing, setting, and scope of the total scientific endeavor on Skylab, a brief description of the Skylab Program has been included.

Acknowledgments

Valuable guidance was provided in the area of relevance to high school curricula by Dr. James R. Wailes, Professor of Science Education, School of Education, University of Colorado; assisted by Mr. Kenneth C. Jacknicke, Research Associate on leave from the University of Alberta, Edmonton, Alberta, Canada; Mr. Russel Yeany, Jr., Research Associate, on leave from the Armstrong School District, Pennsylvania; and Dr. Harry Herzer and Mr. Duane Houston, Education and Research Foundation, Oklahoma State University.

The Skylab Program

The Skylab orbiting space station will serve as a workshop and living quarters for astronauts as they perform investigations in the following broad categories: physical sciences, biomedical sciences, Earth applications, and space applications.

The spacecraft will remain operational for an eight-month period, manned on three occasions and unmanned during intervening periods of operation. Each manned flight will have a crew of three different astronauts. The three flights are planned for durations of one month, two months, and two months, respectively.

A summary of objectives of each of the categories of investigation follows.

Physical Science

Observations free of filtering and obscuring effects of the Earth's atmosphere will be performed to increase man's knowledge of (1) the sun and of its importance to Earth and mankind, and (2) the radiation and particulate environment in near-Earth space and the sources from which these phenomena emanate.

Biomedical Science

Observations under conditions different from those on Earth will be made to increase man's knowledge of the biological functions of living organisms, and of the capabilities of man to live and work for prolonged periods in the orbital environment.

Earth Applications

Techniques will be developed for observing from space and interpreting (1) Earth phenomena in the areas of agriculture, forestry, geology, geography, air and water pollution, land use and meteorology, and (2) the influence of man on these elements.

Space Applications

Techniques for adapting to and using the unique properties of space flight will be developed.

The Skylab Spacecraft

The Skylab cluster contains five modules (see illustration).

- 1) The *orbital workshop* is the prime living and working area for the Skylab crews. It contains living and sleeping quarters, food preparation and eating areas, and personal hygiene equipment. It also contains the equipment for the biomedical science experiments and for some of the physical science and space applications experiments. Solar arrays for generation of electrical power are mounted outside this module.
- 2) The *airlock module* contains the airlock through which suited astronauts emerge to perform activities outside the cluster. It also contains equipment used to control the cluster's internal environment and the workshop electrical power and communications systems.
- 3) The *multiple docking adapter* provides the docking port for the arriving and departing command and service modules, and contains the control center for the telescope mount experiments and systems. It also houses the Earth applications experiments and materials science and technology experiments.
- 4) The *Apollo telescope mount* houses a sophisticated solar observatory having eight telescopes observing varying wavelengths from visible, through near and far ultraviolet, to X-ray. It contains the gyroscopes and computers by which the flight attitude of Skylab is controlled. Solar arrays mounted on this module generate about half of the electrical power available to the cluster.
- 5) The *command and service module* is the vehicle in which the crew travels from Earth to Skylab and back to Earth, and in which supplies are conveyed to Skylab, and experiment specimens and film are returned to Earth.

Skylab will fly in a circular orbit about 436 kilometers (235 nautical miles) above the surface of the Earth, and is planned to pass over any given point within latitudes 50° north and 50° south of the equator every five days. In its orbital configuration, Skylab will weigh over 91,000 kilograms (200,000 pounds) and will contain nearly 370 cubic meters (13,000 cubic feet) for work and living space (about the size of a three bedroom house).

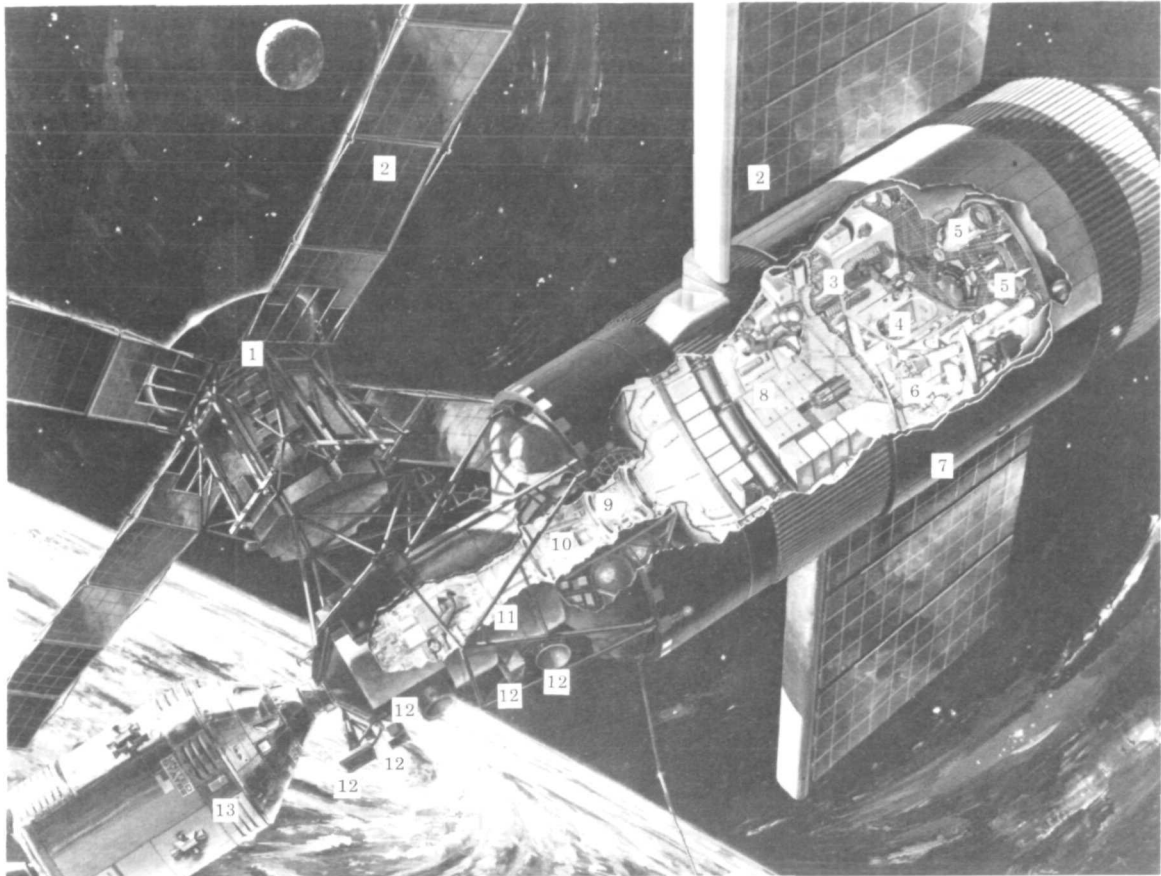

- | | | |
|---------------------------------|--------------------------|--------------------------------|
| 1 Apollo telescope mount | 6 Ward room | 10 Airlock module |
| 2 Solar arrays | 7 Orbital workshop | 11 Multiple docking adapter |
| 3 Sleeping quarters | 8 Experiment compartment | 12 Earth resources experiments |
| 4 Personal hygiene | 9 Airlock external hatch | 13 Command and service module |
| 5 Biomedical science experiment | | |

Figure 1 Skylab Orbiting Station

Skylab Life Science Investigations

Major study emphasis in the Skylab Program is on life sciences as summarized in Figure 2.

The human body incorporates a large number of interdependent body systems in homeostatic balance, which is essential to the proper functioning and well being of the body as a whole. Therefore, the program shown in figure 2 recognizes that measurement of change in a single body system or function is not a final answer in itself. Ultimate answers require a considerable amount of cross correlation among the six principal study areas.

The six areas of scientific investigations being emphasized in Skylab appear on the left side of the figure. The investigative program for these areas includes measurement of individual events and subsequent integration of all data to establish the effects of interactions.

The inquiring reader of this book can discover that the educational potential of the program of investigations discussed is not limited to the specific scientific thrust of the experiment but has a broader association which cuts across many elements of the high school curriculum. Thus, the general subject area of this book, life sciences, can provide source material in such diverse fields as physics, biology, and chemistry.

Table 1 is a cross index of general curriculum elements to specific investigations within the Skylab Life Sciences Experiment program.

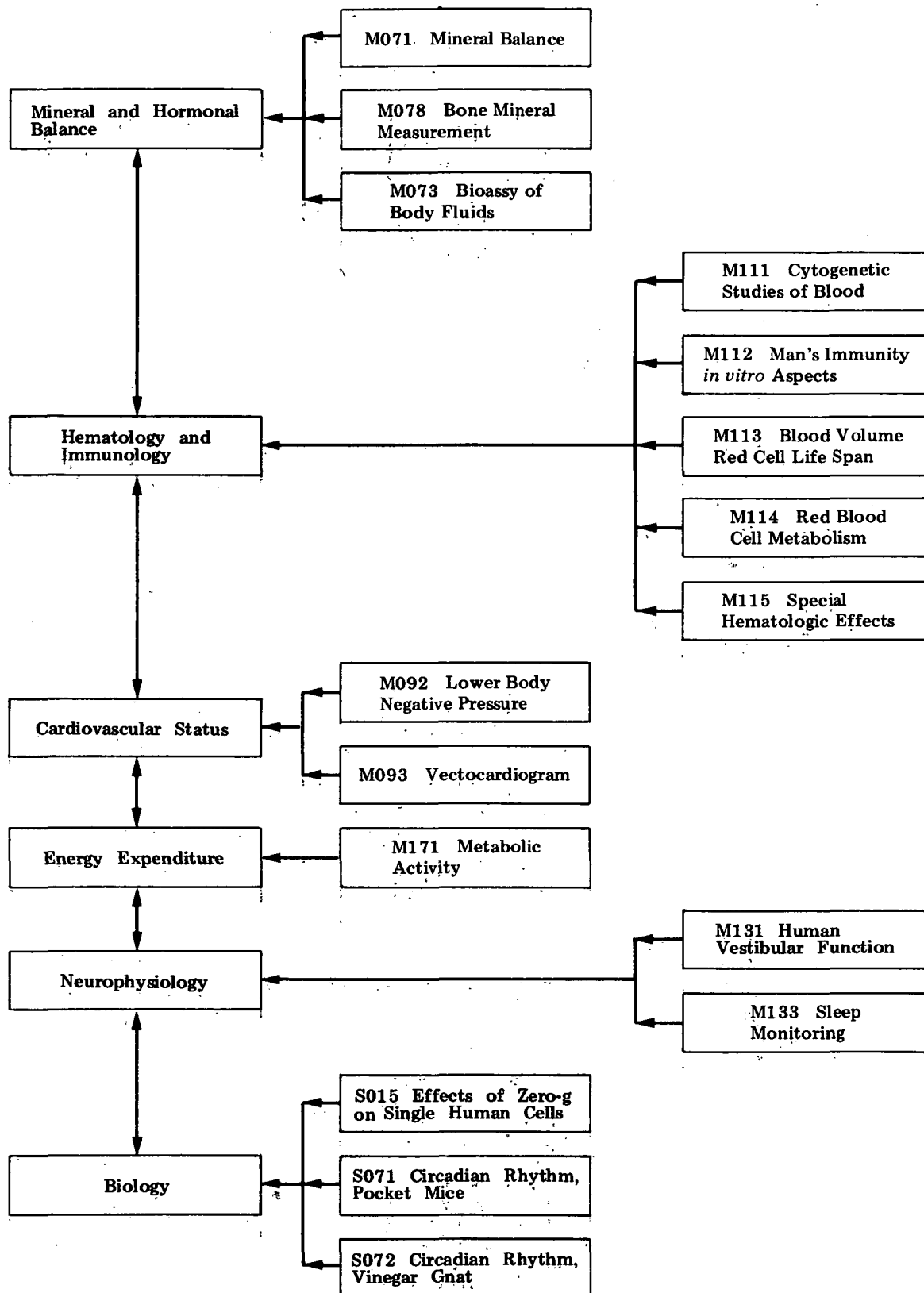

Figure 2. Experimental Program

Table 1 Related Curriculum Topics

| EXPERIMENTS / SUBJECT | CHEMISTRY | HOME ECONOMICS | PHYSICS | PHYSIOLOGY | GENERAL BIOLOGY BIOCHEMISTRY | ENGINEERING |
|---|---|--|--|---|--|---|
| SECTION 2 MINERAL AND HORMONAL BALANCE | Calcium exchange in equilibrium, analysis of mineral constituents, electrophoretic analysis of protein, waste processing osmotic pressures, calcium replacement by Sr^{90} in bones | Cyclic menus, nutrient parameters, food preparation and consumption in a unique environment, dietary deficiencies, effect of diet in bone development; caloric content of food | X-ray techniques, mass measurement in zero gravity, radioisotopes, calorimetry | Nutrition, metabolism, mineral and hormonal balance, relationship of bones and blood, digestive tract, role of hormones, structure and function of nephron units, bone development | Techniques of blood, urine, vomitus and fecal analysis | |
| SECTION 3 HEMATOLOGY AND IMMUNOLOGY | Protein analysis, DNA and RNA analysis, blood analysis, enzyme structure, ATP cycle bonding in biochemical cycles, O_2 and CO_2 transport in blood | | | Production of serums, meiosis studies, body defense against disease, vaccines; function of blood cells, cell production and destruction; function of enzymes, examination of bone marrow | | |
| SECTION 4 CARDIOVASCULAR | Gas laws, partial pressures, equilibrium, location and function of chemoreceptors in the body | | Fluid dynamics of cardiovascular system, dynamics of zero gravity; mechanical failures of the circulatory systems; hydrostatics, acoustics; thermal dynamics | Role of gravity in circulatory system, blood pressure, respiration rate, effect of CO_2 on respiration, hyperventilation, orthostatism, shock integration of cardiovascular systems | | Electronics, electrode design, positive and negative feedback, mechanics. |
| SECTION 5 ENERGY EXPENDITURE | Measurement of O_2 intake vs CO_2 output, caloric determination of nutrients, gas laws | Caloric content of foods, determining energy requirements | Work output and gas flow rate determinations | Toxic substances and effect on respiration, vital capacity, metabolism of plants, breathing rate after exercise, CO_2/O_2 ratio effects on heart beat | | Electronics, system design and integration of engineering and scientific disciplines |
| SECTION 6 NEUROPHYSIOLOGY | | | Electrode design, sound in low pressure atmosphere; inertia, acceleration, spatial localization, fluid dynamics | Exercise related to touch, vision, smell; hearing, balance, taste, motion sickness; sense functions of brain, sleep habits; vestibular functions, nerve transmission, electroculographic study, electroencephalograph | Studies of motion, touch, smell, hearing balance; taste, vision; integration of senses, electrochemical nature of nerve impulses; ion transfer across a membrane, ionic potential of an axon | System design, feedback servo systems, digital logic, integration of engineering and scientific disciplines, space station design |
| SECTION 7 | Analysis of body fluids | | | Rhythmic cycles of temperature, blood pressure, manual dexterity; drug effectiveness, circadian rhythm of mice; fruit flies, etc. | <i>Drosophila</i> genetics, mitosis and cell structure, chromosome aberrations, acne linkage, gene mapping, blood diseases | Study design |

Section 1

Introduction

EXPERIMENTS PROGRAM BACKGROUND

Manned Spaceflight

Since the beginning of manned spaceflight in the United States, there has been a continuing concern regarding man's ability to live and operate efficiently while on extended flights in space. Answers to this concern can be obtained only through a careful quantitative assessment of the crews' performance and physiological well being while working in the space environment. The study must develop data on trends and rates of adjustments while providing an instantaneous assessment of the crewmen's status and performance at critical points during the flight. Equally important is the ability of the crew to readjust to life on Earth after return from orbit. Interpretation of data depends on comparing flight results with a data base obtained in ground laboratories. Such a combination of ground and inflight experimentation forms the basic plan for the Skylab biomedical program.

Missions up to 14 days have produced changes in the astronaut's body tissues and systems as expected. Although the vector of these changes has been in the expected direction, individual changes have often differed from the predicted value. While these earlier missions have shown that man's gross capabilities to operate in the space environment continue at or near Earth equivalence, new techniques for performing a given task on orbit have sometimes been required to reflect the unique character of the space environment.

The Skylab Program and the life science experiments that are to be performed offer an opportunity to increase man's knowledge of the biological and physiological functions of living organisms. This will be achieved by making scientific observations of living organisms in an environment different from that on Earth, and evaluating the transitional effects as the organism responds and hopefully adapts to these new conditions.

Specifically, the Skylab biomedical experiments provide information on man's ability to--

Data requirements for long
duration spaceflight planning

- 1) perform effectively while in near weightless flight up to 56 days,
- 2) identify natural biological cycles,
- 3) identify the adequacy of or need for additional life-support provisions to control changes in body chemistry within acceptable bounds,
- 4) confirm or refine the habitability design criteria for future long-duration manned systems.

In addition, information will be developed to aid in understanding crew psychological reactions to long-duration confinement; evaluating the problems associated with food, water, and waste management; and for developing criteria for designing better crew-monitoring systems for future missions. The Skylab Program should provide these data at a sufficiently early date to affect the next major manned systems.

Physiologic
and
Psychologic
Changes

In terms of life-science research, Skylab aims primarily at identifying and defining physiologic and psychologic adaptive changes and establishing whether these will be progressive or self-limiting. If progressive, they could necessitate returning a crew back to Earth before the scheduled time. If self-limiting, the crew should pass through a period of adjustment followed by stabilization appropriate to the new environment. It is well known that when man travels to a high-altitude city or works in an undersea environment for long periods, the body processes pass through an initial adjustment followed by stabilization at new levels appropriate to survival in the new environment. This transient adjustment is also expected for the Skylab crew. The new stable levels of accommodation are expected to be adequate for the normal health and function of man during continued orbital flight. Upon return to the terrestrial environment the space-stabilized levels of accommodation may become significant factors in the crews' well being; that is, the acclimatization to space which has occurred may require specialized assistance to help the crewmen readapt to Earth following long duration space flight. Based on shorter duration past missions, the predicted course of events is encouraging for these longer manned spaceflights.

Acclimatable and accommodative reflexes trigger transitional adjustments in body systems.

The experiments selected for Skylab reflect a synthesis of the observations made during previous flights. Body systems which have shown changes and which could present a problem for the crewmen have received priority in this continuing research.

These studies have been organized for the purposes of this document in the following order:

Section 2, Mineral and Hormonal Balance

Section 3, Hematology and Immunology

Section 4, Cardiovascular Status

Section 5, Energy Expenditure

Section 6, Neurophysiology

Section 7, Biology

In each section a general introductory background is included. The purpose of this background is to establish a fundamental relationship between the experimental program and basic classroom science. This background is oriented towards establishing a broad scientific link between the Skylab experimental program and classroom science curricula. Hence, this approach emphasizes the general scientific background of the experimental program and separates the Skylab technological goals from the broader teaching aspects. Other subsections describe the specific technical objectives, equipment, and expected data output from each experiment.

Section 2

Mineral and Hormonal Balance

Mineral Balance
Skylab Experiment M071

Bioassay of Body Fluids
Skylab Experiment M073

Bone Mineral Measurement
Skylab Experiment M078

Man's
Communication
System

In order to maintain life, an organism must be able to coordinate a wide variety of different functions. For this purpose, animals, including man, have developed two important communication systems. The nervous system has the form of an elaborate telegraph (neural) network in which communications paths are reasonably well defined by anatomical connections which, in many cases, provide very specific routing of transmitted messages to discrete anatomical sites. The other communication system is the endocrine system consisting of many ductless glands (Figure 2-1). In it, messages are carried in the bloodstream in the form of complex chemical substances (hormones) that interact with special cells to receive the hormone and to react to it in a specific way. These "target cells" may be limited to one particular type of cell, e.g., the gonadal cells that respond to the gonadotrophic hormone, or the renal tubular cells that respond to aldosterone. However, some hormones, such as insulin, act upon many different types of cells.

Hormones—any of various internally secreted compounds formed in endocrine organs that affect the functions of receptive organs when carried to them by body fluids.

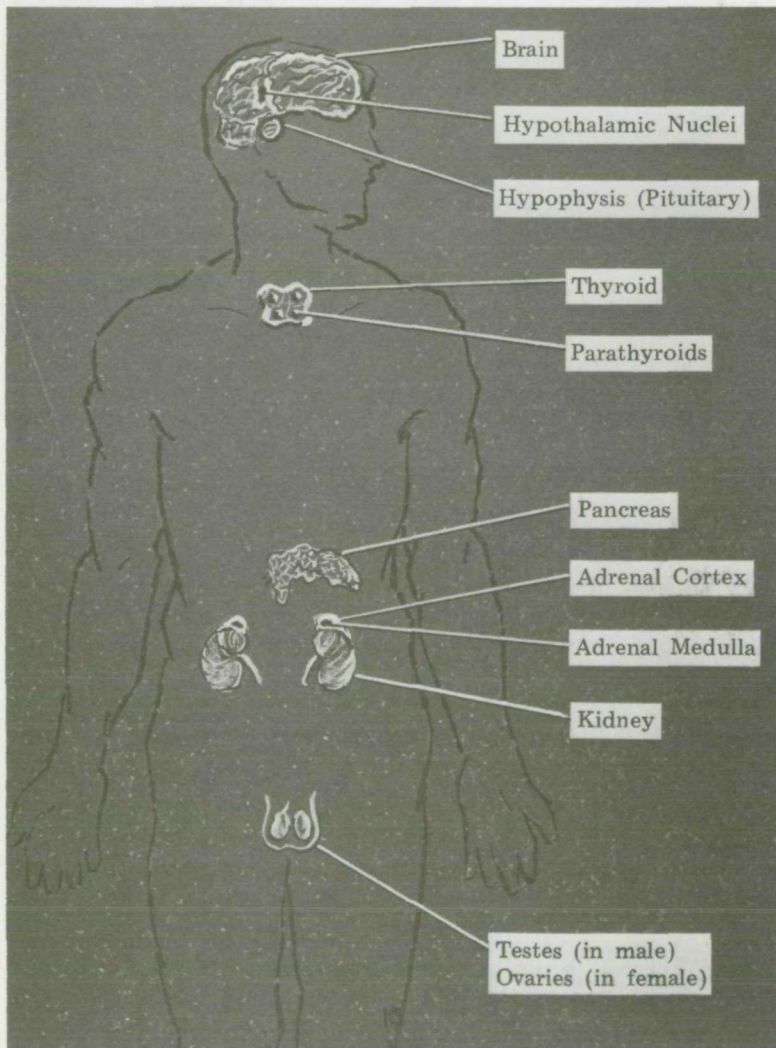

Figure 2-1 Major Endocrine Glands in Man

There are many interactions between the nervous and endocrine systems, so that they are sometimes considered collectively as the neuroendocrine system. For example, transmission between neurones in the sympathetic nervous system occurs via adrenergic hormones. These hormones are also produced by the adrenal medulla, an organ which functions as an endocrine gland, but is embryologically derived from neural tissue. Another example of the close relationship between the neural and endocrine systems is the requirement that certain hormones be present for the normal development and functioning of nerve tissue. It is known, for instance, that lack of thyroid hormone in infancy results in mental retardation, and in adults in the slowing of conduction in the nerves. The complex systems which control some physiological variables such as body water content are known to include both neural and endocrine elements. The type of action which hormones may elicit from target cells is shown in Table 2-1. The extent of interactions between the neurohormonal processes and the basic behavior of target cells is shown in Figure 2-2.

Adrenergic—activated or transmitted by epinephrine.

Table 2-1 Hormone Elicited Control

| |
|--|
| <ul style="list-style-type: none"> ● Altered blood flow to cells, e.g., nearly all tropic hormones on target glands. ● Altered membrane properties of <i>specific cells</i>. <ol style="list-style-type: none"> 1) ADH: renal loop of Henle and H₂O transport. 2) Aldosterone: renal proximal tubule and Na⁺ transport. 3) Various hormones and amino acid transport, e.g., 178-estradiol increases transport by uterus. 4) Insulin: glucose transport; K⁺ transport; Pi transport; and transport into muscles but not liver. ● Altered rates of protein metabolism. <ol style="list-style-type: none"> 1) Anabolism—increased protein synthesis e.g., <ol style="list-style-type: none"> a) GH: bone, muscle, liver b) TSH: thyroid; ACTH; adrenal cortex, etc. c) Thyroxin: many cells d) Cortisol: liver 2) Catabolism—increased protein degradation <ol style="list-style-type: none"> a) Cortisol: muscle, bone b) Thyroxin (large doses): many cells ● Altered enzymatic activity <ol style="list-style-type: none"> 1) CHO Metabolism e.g., <ol style="list-style-type: none"> a) Epinephrine: liver, muscle phosphorylase and glycogenolysis b) Insulin: muscle and glycogen synthesis 2) Lipid metabolism <ol style="list-style-type: none"> a) Many hormones: lipolysis in adipose tissue. b) Insulin: antilipolysis in adipose tissue. ● Mineral, water and electrolyte metabolism Effects may be secondary to those listed in categories above, e.g., PTH and Ca⁺⁺ mobilization may be secondary to increased catabolism of bone protein, or altered membrane changes. |
|--|

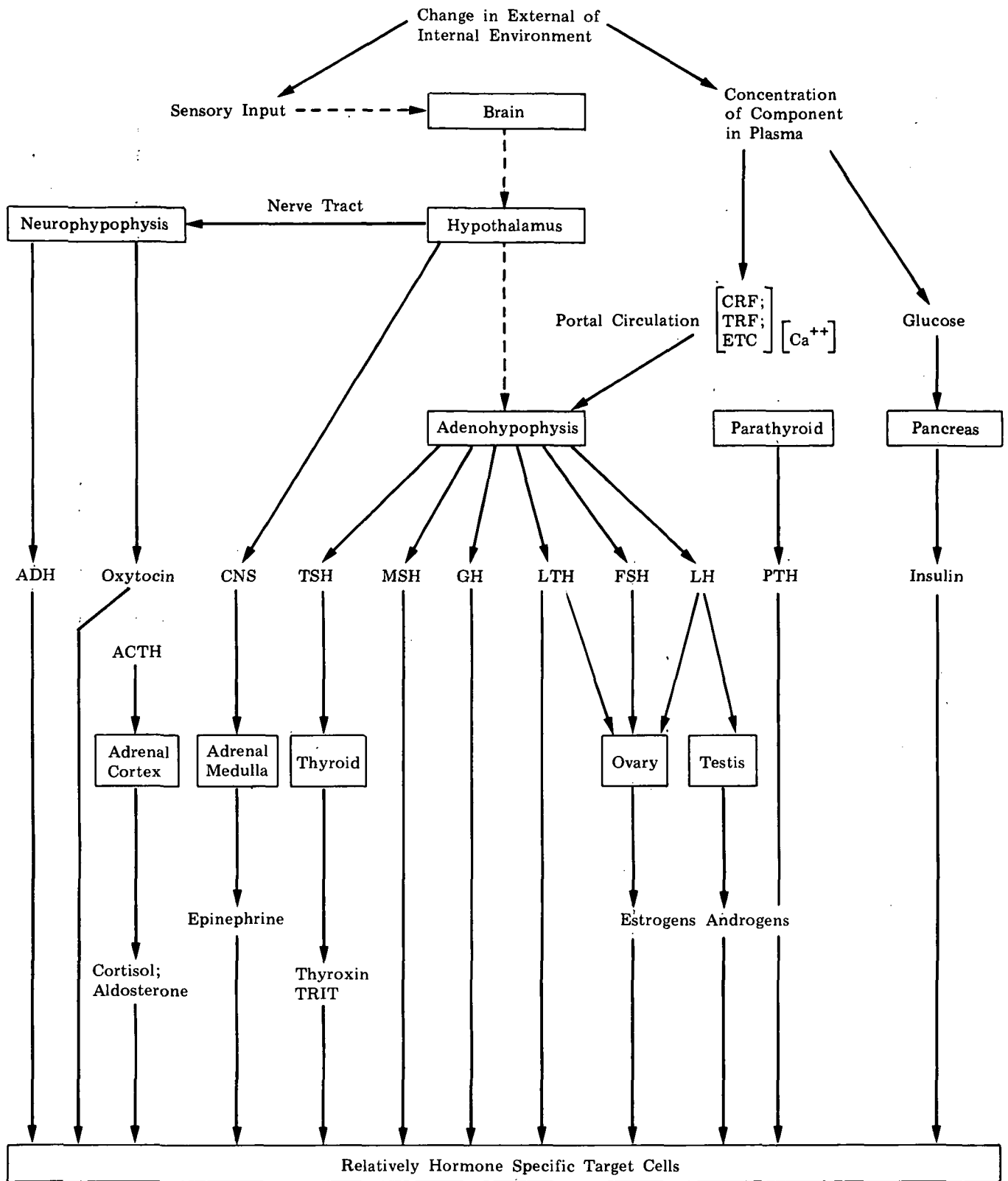

Output = Alteration in Metabolic Behavior of Target Cells

Figure 2-2 Neurohumoral Interactive Processes Influencing Metabolic Activity of Specific Cells

Referring to Figure 2-2, it is apparent that the interactions are many and complex and further that these actions can be triggered by outside environmental influences that can affect component concentration in the plasma, the portal circulation, and even the brain through sensory organ inputs. During the evolution of man, gravitational forces have unquestionably played a major role in his physiological development. The significance of this force in the health and growth of man is of uncertain limits today.

Composition
of Bone

One rather interesting aspect of this is demonstrated by the influence which such external forces may have on the growth of bone in the body.

Bone is a unique tissue comprising a very special body organ system. Living bone requires the same nutrients, controls, and environments as other living tissue in the body. In contrast, however, to other body tissue and because of its calcified nature, bone provides a semipermanent biological record. Hence, like the growing tree, the structure of bone records the anomalies of its past including irregularities of diet, disease, and environment.

Bone shows many levels of organization (Fig. 2-3). Typically, bones are composed of two basic types of material: compact (lamellar) bone and spongy (cancellous) bone. Compact bone makes up the wall of the central portion (diaphysis) as well as the outer shell of the flared ends (metaphysis). The interior of the metaphysis is composed of spongy bone which in time is built up of a collection of plates and bars called trabeculae (little beams). There is little difference in the bony material in these two types of bone although the porosity of each type is quite different.

Cancellous— of a reticular, spongy, or lattice-like structure: used mainly of bony tissue.

Diaphysis—the shaft of a long bone.

Metaphysis—the wider part at the extremity of the shaft of a long bone, adjacent to the epiphysical disc.

The outer surface of the bone is covered by a membrane known as the periosteum; the inner surface is covered by a membrane known as the endosteum. The volume that is contained within the wall of the diaphysis is called the medullary cavity and it is filled with marrow as are the spaces between the trabeculae of spongy bone. Yellow marrow is found in the large cavities of the long bones. It consists for the most part of fat cells. It may be replaced by red marrow in anemia. Red marrow is the site for production of the granular leucocytes and the erythrocytes (red blood cells). Red marrow is found in the flat and short bones, the articular ends of the bones, the bones of the vertebrae, the cranial dipole and the ribs. Both types of marrow have a supporting connective tissue and numerous blood vessels.

Bone is formed by cells called osteoblasts, and destroyed or resorbed by other cells called osteoclasts. These two cell types are formed from undifferentiated mesenchymal cells lying on the surface and in the spaces of the bones. When a

Bone Structure

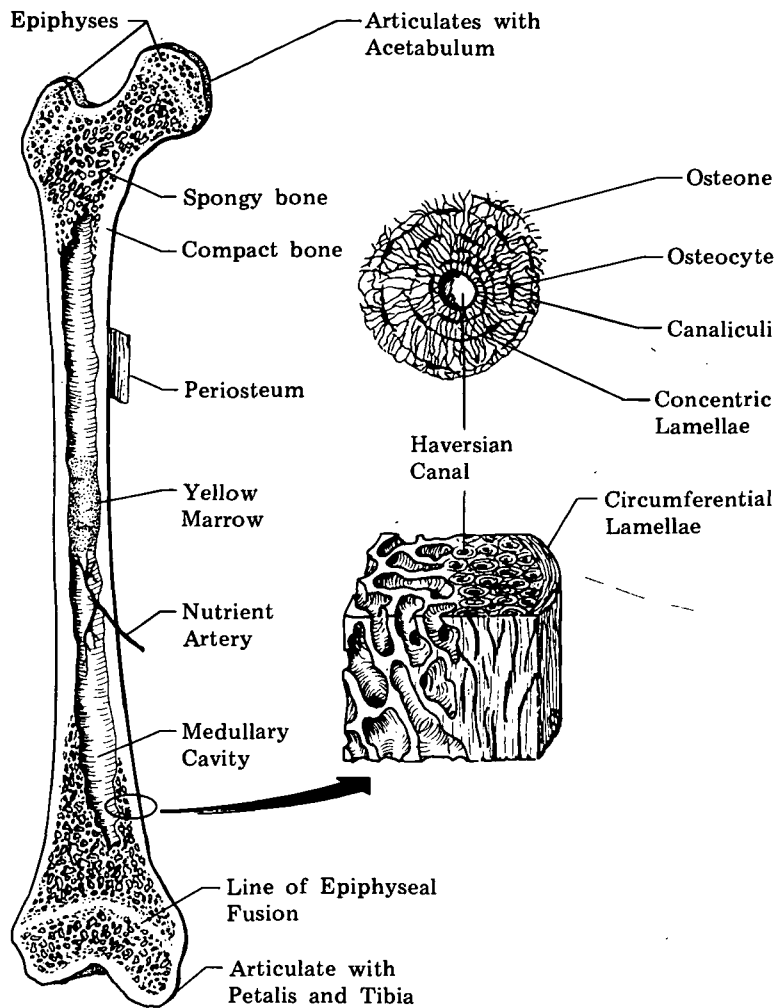

Figure 2-3 Structure of Human Femur

certain stimulus is received, these mesenchymal cells begin functional and morphologic transitions which terminate in the formation of specialized osteoblasts and osteoclasts as appropriate to the stimulus. The deposition or mobilization of calcium under the influence of structural loads on the bone completes the growth of new adult bone. Bone cells (osteocytes) were originally osteoblasts which became included in the bone matrix. They are the living elements of bone tissue and their function is to maintain the chemical environment of the surrounding nonliving tissue. In lamellar bone, there are about 20,000 osteocytes per cubic millimeter, residing in the same number of lacunae (spaces) and they are about 10 x 15 x 25 microns in size. Osteocytes die for a variety of reasons; after death they are absorbed and leave empty lacunae behind. Human osteocytes live an average of 25 years.

There are a wide variety of observations that indicate that the growth system, whose function is to penetrate and remodel

Osteoblast—a cell that arises from a fibroblast and which, as it matures, is associated with the production of bone.

Fibroblast—a connective tissue cell.

Osteocytes—an osteoblast that has become imbedded within the bone matrix, which connects to other osteocytes to form bone.

bone, is somehow responsive to the local state of stress; that is, physical loads of various kinds alter the growth rate, shape, and structure of bone.

Bone
Measurement

Measurements of bone weight show that inactivity through confinement, immobilization, or paralysis causes a significant reduction in both the amount and quality of bone. Several studies of this phenomena involving patients immobilized in pelvic girdle and leg casts have been made. During the confinement period, significant levels of calcium, phosphorus, and nitrogen were found in urinary and fecal excretions. Animal experiments indicate that immobilization of a limb invariably leads to disuse atrophy and a reduction in muscle and bone weight.

Long bones with an angulation caused by a poorly set but healed fracture have been observed in children to gradually straighten. These changes and adjustments in shape require bone to be resorbed on the tension or minimum compression side and deposited on the more heavily loaded side. Thus, it can be observed that the bone cross section drifts in a direction to minimize loading eccentricity so that bone appears to possess a stress directed growth regulating mechanism which adjusts the bone architecture in response to external loads.

Angulation—the formation of a sharp obstructive angle

Generally, it can be said that usage in the young growing skeleton leads to changes of shape and structure while in older, fully grown bones usage leads mainly to changes in structure. It is as if the growing bone would grow into a new pattern, determined by mechanical forces, while fully grown bone has become more rigid in its outer shape, but can adapt to changed forces by a new orientation of its internal structural elements.

The skeleton during man's daily activities is exposed to a wide range of loads varying in magnitude and direction. The growth stimulus will therefore also vary in both intensity and direction. Thus, bone organization in the adult is finally determined by those activity patterns most frequent in the lifetime of the individual, superimposed, of course, on the genetically controlled pattern unique to the species. Activity patterns not characteristic of the species would therefore be expected to stimulate growth contrary to genetically carried traits, and result in a bone weakened for characteristic activities of the species.

The Skylab Program affords a unique near-weightless environment in which to test many of the theories that have been advanced as to the manner in which body health and growth are influenced by the environment, and specifically to evaluate the role of mineral balance and neurohumoral influence on this growth.

SKYLAB EXPERIMENT MO71

Mineral Balance

Bed rest immobilization studies have shown that in healthy young adults urinary calcium increases to 2-3 times the control level within 5 weeks after confinement. X-ray studies of the bones have demonstrated demineralization as early as 2-3 weeks after immobilization. Gemini pre- and postflight x-rays have suggested a similar loss of mineral from peripheral bones; the Gemini 7 mineral balance experiment has demonstrated a trend toward negative mineral balance. Continuous losses of calcium and nitrogen, such as those during long duration missions, might result in impairment of skeletal and muscle integrity and the formation of kidney stones. Identification of the rates of actual deterioration will allow specific countermeasures to be taken on later flights, such as the institution of exercise routines and the manipulation of dietary constituents.

The principal method of assessing the effect of a stressor on the biochemical integrity of the skeletal and muscular systems is to determine whether the stressor promotes a catabolic response that is greater than the anabolic capabilities of the tissues. The change in equilibrium may be reflected in an imbalance between the nutrient intake of the constituent in question and the output of it and/or its metabolites. A state of negative nitrogen or calcium balance is not itself detrimental unless it is of an extent and duration that results in compromise of the integrity of muscle or bone with resultant increases in susceptibility to disease or actual pathology. Prior to the onset of recognizable disease, however, minor changes in function suggesting later deterioration can be demonstrated.

Stressor—a stimulus, such as pain or fear, that disturbs or interferes with the normal physiological equilibrium of an organism.

Anabolism—any constructive process by which simple substances are converted into more complex compounds, constructive metabolism.

Catabolism—any destructive process by which complex substances are converted by living cells into more simple compounds; destructive metabolism.

SCIENTIFIC OBJECTIVES

The objective of this experiment is to determine the effects of space flight on the muscle and skeletal body systems by quantitative assessment of the gains and losses of biochemical constituents of metabolic importance. These constituents are water, calcium, phosphorus, magnesium, sodium, potassium, nitrogen, urea, hydroxyproline, creatinine and chloride.

EQUIPMENT

The Mineral Balance and Bioassay of Body Fluids experiment data were obtained from a detailed, daily inventory of food and water intake, of body mass, and of output of waste products. Waste products, feces, urine and vomitus are measured, processed, and stored onboard for return to Earth with the crew, and subjected to detailed analysis. Equipment designed to perform the specimen and body mass measurement, MO74 and MO172, respectively, is used to support this experiment.

PERFORMANCE

Experiment Investigations

The performance of the Mineral Balance Investigations starts 21 days before flight and continues throughout the flight and for 18 consecutive days after return to Earth. Each day of the observing period, the following functions will be performed by the crew:

- 1) Body weight (or mass) will be measured immediately after the first urine voiding following the sleep period.
- 2) A predetermined diet will be used since the composition of the crewman's diet must be known and carefully controlled. In the preflight period, each crewman will use this diet to allow the establishment of individual metabolic equilibrium. Every effort will be made to make the diet palatable. The premeasured menu for each meal will be prepared and the mass of any leftover food will be measured and recorded.
- 3) Fluid can be taken as desired, but all intake will be recorded. This includes fluid used for food reconstitution.
- 4) All urine, feces, and vomitus will be collected pre- and postflight and preserved for analysis. Inflight, the amount of daily urine output from each crewman will be determined, and a measured homogeneous sample of at least 45 milliliters (2 for tracer method volume determination) taken, frozen, and stored for analysis. All feces and vomitus passed will be collected, the mass will be measured, and the specimens will be dried and stored for postflight analysis.
- 5) Periodic blood samples will be taken and the concentration of selected constituents determined. Inflight blood samples will be processed and frozen for postflight analysis.

DATA

During the Skylab Program, three crews (three men in each) will occupy the orbital workshop on three separate occasions. The initial mission will last up to 28 days and the other two for up to 56 days each. The Mineral Balance Experiment will be performed on all three missions so that by the end of the Skylab Program a continuous quantitative assessment of the muscle and skeletal body systems for nine different individuals will have been obtained. For each individual, a preflight baseline will be followed by a day-by-day profile of his physiological reaction to the space environment, and postflight, his readaptation to Earth's normal conditions. Specifically, the following data on a daily basis will be obtained preflight, inflight and postflight:

- 1) food consumption—nutritional, mineral, and caloric content;
- 2) fluid consumption;
- 3) feces—mass and concentration of biochemical constituents;
- 4) urine—total voids volume and concentration of the biochemical constituents;
- 5) vomitus—mass and concentration of the biochemical constituents;
- 6) body mass.

In addition, blood samples will be taken periodically pre-, in- and postflight. These samples will be analyzed to determine alkaline phosphates, total protein, electrophoresis pattern, sugar, calcium, phosphorus, magnesium, sodium, potassium, hydroxyproline, chloride, and creatinine.

SKYLAB EXPERIMENT MO73

Bioassay of Body Fluids

Although many external influences contribute to the environment of the human organism as a whole, the environment of its basic unit, the living cell, is wholly internal. Since changes in extracellular fluid produce changes in the composition of the intracellular fluid, it is essential to the normal function of cells that the constancy of this fluid be maintained. This is achieved by the close interaction of several organ systems, the kidney holding a predominant role. The kidney is thus viewed as an organ which not only removes metabolic wastes, but actually performs highly important homeostatic functions by adjusting plasma volume and composition.

The necessity of elucidating the homeostatic control mechanisms that govern plasma volume and composition is evident when one realizes the complex and, as yet, unexplained interactions of these metabolic and endocrine controls. In the changing external environment, there is a narrow margin within which man's physiological well-being can be accommodated by these functions. Evidence exists to suggest that these mechanisms may play a significant role in man's adaptation to stress, including gravity.

Homeostatic—uniformity or stability in the normal body states of an organism.

SCIENTIFIC OBJECTIVES

The objective of the Bioassay of Body Fluids Experiment is to evaluate the endocrinological adaptation resulting from exposure to the spaceflight environment for periods up to 56 days and to readaptation to the Earth environment. Specifically, the following elements in blood and/or urine will be evaluated: adrenocorticotrophic hormone (ACTH), 17-hydroxy-corticosterone (Cortisol), angiotensin II, renin,

aldosterone, antidiuretic hormone (ADH), epinephrine, norepinephrine, urine electrolytes (sodium and potassium), urine and plasma osmolality, extracellular fluid volume, total body water, serum thyrocalcitonin parathyroid hormone, serum thyroxine, hydrocortisone, renin activity, total and fractional ketosteroids, insulin, human growth hormone, and thyroid stimulating hormone.

EQUIPMENT

The Mineral Balance and Bioassay of Body Fluids data is obtained from a detailed, daily inventory of food and water intake, of body mass, and of output of waste products. Waste products, feces, urine, and vomitus are measured, processed, and stored onboard for return to Earth with the crew, and subjected to detailed analysis in the postflight period. Equipment for performing the specimen and body mass measurements, MO74 and MO172, respectively, is used to support this experiment.

Bioassay—determination of the active power of a substance by testing its effect in an organism.

PERFORMANCE

Experiment Investigations

The experiments will be accomplished in three phases: (1) preflight, for 21 days, (2) inflight, and (3) postflight until readaptation has been established, beginning immediately after flight.

The following functions will be performed each day of the observing period:

- 1) Body weight (or mass) will be measured immediately after the first urine voiding following the sleep period.
- 2) A predetermined diet will be used since the composition of the crewman's diet must be known and carefully controlled. In the preflight period each crewman will use this diet to establish individual metabolic equilibrium. Every effort will be made to make the diet palatable. The premeasured menu for each meal will be prepared and the mass of any leftover food will be measured and recorded.
- 3) Fluid can be taken as desired, but all intake will be recorded. This includes fluid used for food reconstitution.
- 4) All urine, feces, and vomitus will be collected pre- and postflight and preserved for analysis. Inflight, the amount of daily urine output from each crewman will be determined, and a measured homogeneous sample of at least 75 milliliters for bioassay of body fluids experiments taken, frozen, and stored for analysis. All feces and vomitus passed will be collected; the mass will be measured; the specimens will be dried and stored for postflight analysis.

- 5) Periodic blood samples will be taken and the concentration of selected constituents determined. Inflight blood samples will be processed and frozen for postflight analysis.

DATA

The Bioassay of Body Fluids Experiment will occur on all three missions so that by the end of the Skylab Program, a continuous quantitative assessment of the endocrinological adaptation for nine different individuals will have been obtained. For each individual, a preflight baseline will be obtained, followed by a day-by-day profile of his physiological reaction to the space environment, and after flight, his readaptation to Earth normal conditions. Specifically, the following data on a daily basis will be obtained preflight, inflight, and postflight:

- 1) Data obtained from Mineral Balance, Experiment MO71
- 2) Urine—concentration of the biochemical constituents specified in the Objectives.

Biochemical--dealing with living matter.

In addition, blood samples will be taken periodically pre-, in- and postflight and those parameters specified in the Objectives will be determined.

SKYLAB EXPERIMENT MO78

Bone Mineral Measurement

Stimulus of bone metabolism is a function of the forces exerted on the bone by the attached muscles and the force exerted along the longitudinal axis of the skeletal system by gravity. Both forces are altered during complete bed rest and absence of gravity. Consequently, bone mineral losses have been associated with long-term bed rest and were anticipated as a potential problem for the crews of long-term space flights.

In both Gemini and early Apollo flights, small but significant losses have been measured in astronaut bone mass. In contrast to the Gemini and early Apollo studies, which used a radiographic densitometry technique, the bone mineral studies performed on Apollo 14, using the gamma ray absorption technique, revealed no significant losses in bone mineral content. More data from both ground based and inflight studies are necessary to resolve the issue before committing man to extended space travel.

SCIENTIFIC OBJECTIVES

The objective of the Bone Mineral Measurement experiment is to determine, by a photon absorptiometric technique, the

occurrence and degree of bone mineral changes in the Skylab crewmen that might result from exposure to the weightless condition.

EQUIPMENT

The Bone Mineral Measurement experiment consists of preflight and postflight measurement of the condition of two bones in each astronaut. The ground based equipment for this experiment is a photon scanning device in which an iodine-125 photon source is mounted in opposition to an x-ray detector. The astronaut's limb containing the bone to be measured is firmly held in the required position within the scanning device. Foot molds and restraining equipment are used for accurate positioning of the subject for the scan.

Photon--a quantum of electromagnetic radiation.

PERFORMANCE

Experiment Investigations

The Bone Mineral Measurement performance using the photon scanner starts 30 days before flight. The bones to be measured are the heel bone (os-calcis) in the left foot and one of the bones (radius) in the right forearm. (See Fig. 2-3.) X-rays of the heel will be made seven days before the first photon scanner observation.

Preflight scans of the left os-calcis and right radius will be accomplished on the flight crew, backup crew, and on a control group 30, 14 and 3 days before the launch of the flight crew.

Postflight measurements will be made on the flight crew and on the control group within 10 hours after splashdown and at the following intervals: 2 to 3 days, 5 to 10 days, and 30 to 45 days if baseline values have not been reached in the 5- to 10-day period.

The measurement on recovery day should be made at the earliest time possible (within 10 hours) after crew recovery to minimize the effect of weight bearing by the os-calcis and maximize the data accuracy on the extent of the bone mineral losses under zero gravity conditions.

Additional postflight measurements will be required if the flight crewmembers have not reestablished their baseline values by the third measurement.

DATA

The data returned by this experiment will be the pre- and postflight bone density measurements of the os-calcis and radius of each Skylab crewmember (three from the 28-day mission and six from the 56-day mission) and nine control group members. The data will be used to determine the impact of the spaceflight environment on the degree and occurrence of the bone mineral changes.

Section 3

Hematology and Immunology

**Cytogenetic Studies of the Blood,
Skylab Experiment M111**

**Man's Immunity, In Vitro Aspects,
Skylab Experiment M112**

**Blood Volume and Red Cell Life Span,
Skylab Experiment M113**

**Red Blood Cell Metabolism,
Skylab Experiment M114**

**Special Hematologic Effect,
Skylab Experiment M115**

Hematology, the study of the form and function of blood, in large part is concerned with changes in the concentration of the functional elements of the blood. These changes can come about as the result of disease processes and environmental changes, or they may be induced as a purposeful experiment.

Regardless of how these changes are precipitated, if they exceed relatively narrow physiological limits they will be accompanied by dramatic changes in the effectiveness of the individual even to the extent of causing death. The following discussion is intended to provide a brief resume of the functions and functional elements that form the basis for our present understanding of the role of blood in health and disease.

FUNCTIONS OF BLOOD

Every living organism, simple or complex, requires for its survival, the ability to exchange materials with its environment, extracting from the environment those materials which it can metabolize for its energy requirements and rejecting to the environment those materials which would poison it. In the case of single cell and other relatively simple organisms, the process of transmembrane diffusion provides an effective mechanism for satisfying this need. Larger, more complex (multicellular) organisms must provide sophisticated organ systems to accomplish this function since the external environment makes intimate contact with the organism's body only at its surface. For example, the skin surface of the average adult human amounts to only about 1.7 m² resulting in a surface to volume ratio of about 0.02 mm²/mm³. Furthermore, this surface is relatively impervious to most materials, and serves only as a means for eliminating excess heat and a small amount of water. Hence, the exchange of materials between the cells of the body and the external environment must be carried on by specialized systems such as the lung, kidney, gastrointestinal (GI) tract, blood, and interstitial fluid.

These specialized systems are related as shown in the diagram of Figure 3-1. Reference to this diagram shows that while the lung, kidney, and GI tract interface with the external environment, they do not interface directly with the cells of the body. The materials upon which the body is dependent pass through two intermediate mechanisms, the circulatory system, and the interstitial fluid. The interstitial fluid, which bathes all cells in the body, provides a uniform environment from which the cells extract their material needs and to which they reject waste products. The circulatory system provides a transport mechanism that assures physical and chemical uniformity (within relatively narrow physiological

Interstitial Fluid—that portion of the body water outside of the cells and outside of the plasma volume.

limits) of the interstitial fluid. The circulatory system so permeates the interstitial compartment that in the heart, for instance, no cell is further than about 0.008 mm from a capillary.

**Vital
Transport
Functions**

In addition to the transport of gases, material, and waste products, blood has other equally vital functions. These functions include carrying the heat generated by the cells' metabolic activity to the surface for easy transfer to the surrounding environment, and certain defense mechanisms by which bacteria and foreign particles are removed from the body.

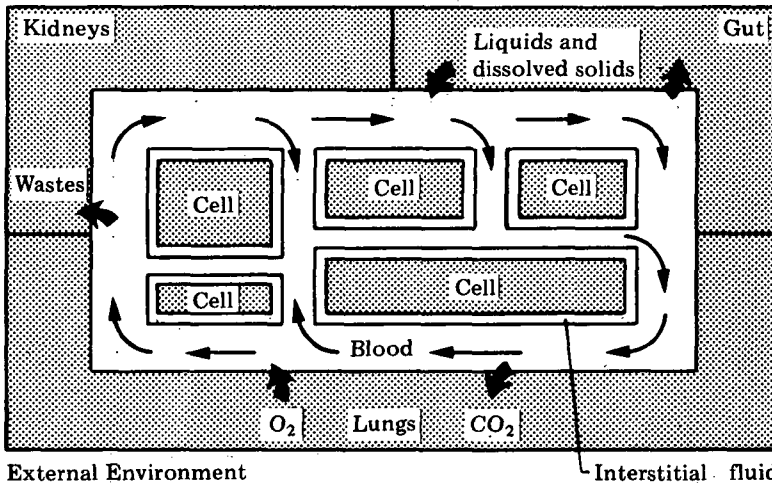

Figure 3-1 Transport Functions of Blood

COMPOSITION OF BLOOD

Because of the significant part which blood plays in maintaining a suitable environment for other tissue in the body essentially free of foreign matter and infectious agents, it is inconceivable that changes in the blood would not effect these other tissues. In recent times we have therefore come to understand that, in addition to quantity, the quality of blood is also significant. In order to understand how blood quality can vary, it is necessary to know something about the composition of blood.

The blood, which fills the vascular pathways of the circulatory system, is a truly unique substance. Even primitive man probably suspected the vital role that blood plays and recognized that survival from the hazards of the hunt and combat were in direct proportion to any loss of blood. We have already indicated that blood performs many vital functions which suggests that blood is more than a simple fluid. Indeed if blood is examined even casually it can be seen to be composed of two phases, a fluid phase and a cellular phase. This can be easily demonstrated; for example,

if a fresh sample of blood is rapidly cooled and centrifuged for, say, five minutes, it can be separated into a collection of heavy particles in the bottom of the sample tube leaving a clear fluid on top (supernatant). This clear fluid (about 55% of the sample volume) can be poured off leaving the separated sediment in the bottom half of the tube. The supernatant fluid will be noted after a short while to exhibit a unique property, that is, it will congeal into a jelly like mass. This liquid phase of the blood which is capable of congealing is called plasma. If fresh plasma is continuously stirred with a glass rod, it will be found after awhile that congealing will not occur. Instead, it will be noted that a pale yellow material (fibrin) will collect on the stirring rod. The remaining fluid in the tube, which will now not congeal, is called serum.

Returning to the red sediment that was collected, a careful microscopic examination will reveal that a variety of formed elements (cells) have been collected.

Cell Types

Many studies of these cells have been performed and it is known that the cells in the blood include a least three families of cell types as shown in the tabulation.

- | |
|--|
| A. ERYTHROCYTES |
| B. LEUCOCYTES |
| 1) Granular Polymorphonuclear Leucocytes (Granulocytes) |
| a) Neutrophils |
| b) Eosinophils |
| c) Basophils |
| 2) Lymphocytes |
| 3) Monocytes |
| C. PLATELETS |

Hence, it seems that whole blood consists of at least four functional elements: plasma, erythrocytes, leucocytes, and platelets.

Blood Plasma

The plasma has been demonstrated above to include several components, since fibrin could be isolated by stirring. Actually, plasma is a complex solution of electrolytes and proteins. The concentration of these plasma constituents as found in normal blood is tabulated.

Fibrin—a whitish insoluble protein that forms the essential portion of the blood clot.

| | | | |
|------------------|----------|-------------------------------|----------|
| Na ⁺ | 140 | HCO ₃ ⁻ | 27 |
| K ⁺ | 4 | Cl ⁻ | 103 |
| Ca ⁺⁺ | 4 | Proteins | 15 |
| Mg ⁺⁺ | <u>2</u> | Misc | <u>5</u> |
| | 150 | | 150 |

Function of
Plasma

For the specific roles of each component of plasma, the reader is referred to the abundant literature on hematology. Some of the generalizations which we can note here ascribe specific roles for plasma in (1) neutralizing the acid end products of metabolism, (2) regulation of heat loss from the body, (3) regulation of the proportions of water in the vascular and interstitial compartments, (4) prevention of excessive hemorrhage from wounds, and (5) immunological defense against invading viruses and foreign protein.

The formed cells identified previously are also specialized with respect to their function in the overall role of blood. The erythrocytes, responsible for the transport of gases, are specialized with respect to form and also chemically by the presence of the protein hemoglobin. The special shape of erythrocytes, a sort of flattened sphere with a central depression (Figure 3-2) results in a cell having a large surface area to volume ratio, which improves the efficiency with which gases diffuse across the cell membrane. Simultaneously this innovative form achieves a low viscosity for efficient pumping by the heart. The presence of hemoglobin in erythrocytes is principally responsible for the gas transport efficiency of blood. Analysis indicates that at sea level pressures the oxygen dissolved in blood would be approximately 3 ml per liter of plasma. Under similar conditions the presence of hemoglobin increases the oxygen concentration to approximately 200 ml. The actual manner by which gases are taken up by the red cells is not nearly as simple as this discussion may imply and the reader is referred to the many good texts for an in-depth treatment of this subject.

H e m o g l o b i n — t h e
oxygen-carrying pigment of the
erythrocytes

Plasma—the fluid portion of the
blood in which the corpuscles
are suspended.

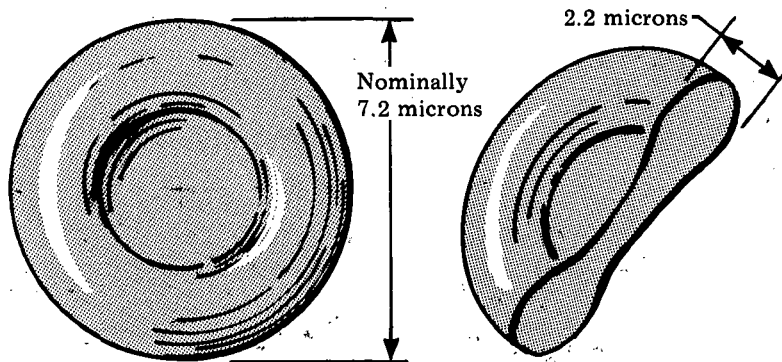

Figure 3-2 Erythrocyte

The leucocytes, as noted previously, comprise a spectrum of cell types. Observations made with blood suggest that these cells have been specialized to remove bacteria and foreign particles from the blood. Other evidence suggests that the bulk of the activity of leucocytes, however, takes place outside of the vascular pathways. The leucocytes therefore

are transient residents of the blood stream on their way to some location in the tissue where they may be needed to destroy invading bacteria or particulate matter. Leucocytes perform their function by a process of phagocytosis (ingestion and digestion).

No one knows with any certainty the origins of each of the cell types nor is the exact role of each in the body's defense known. Some generalizations that can be made, however, are that the three varieties of granulocytes are transported by the blood to tissue sites where they disintegrate releasing active enzymes, (1) the neutrophils that are specifically active in phagocytosis of bacteria, (2) the lymphocytes that circulate continuously between the tissue and bloodstream and are active in immune responses, and (3) the monocytes that are circulating phagocytes active in phagocytizing nonliving particulate matter.

Phagocyte —any cell that ingests microorganisms or other cells and foreign particles.

The platelets are very small and can be easily overlooked in the blood. They are known to be cell fragments originating in bone marrow and tend to disintegrate readily. Platelets carry substantial amounts of serotonin, a vasoconstrictor which is active in reducing blood loss from severed vessels. Additionally, platelets are believed to play a significant role in the maintenance of the endothelial lining of the vascular pathways.

ENVIRONMENTAL INFLUENCES ON BLOOD PHYSIOLOGY

Environmental Conditions

Most of us would have little difficulty accepting the premise that disease can influence the form and function of blood. Most are even vaguely aware that the external environment, particularly radiation in the form of x-rays, can cause dysfunction of blood. Many, however, will not recognize that environmental changes considered to be physically tolerable may stress the circulatory system, including the hematopoietic (related to blood forming) process and the immunological mechanism, beyond acceptable physiological limits.

A commonly recognized physiological response to changed environmental conditions is found in the deeper and more rapid breathing which is experienced when we go to unaccustomed high altitudes. This accommodative reflex is the body's response to the hypoxic (low oxygen) atmosphere of the new environment. If this stress persists for a long enough period of time, compensating changes will be made in the functional elements of the blood; that is, the body will generate more erythrocytes (red blood cells) so as to increase the oxygen-carrying capacity of the blood. This latter change is an acclimatizing change which minimizes the energy expended in maintaining an adequate level of oxygen in the

blood. This acclimating process, however, is not without penalty since the resulting "higher hematocrit" (increased red cell content of the blood) increases the viscosity of the blood and imposes added pumping loads on the heart. If large environmental changes of this type were permanently endured, serious consequences might result. It is to be expected that even more subtle changes in the blood may be provoked by other environmental changes. Since some of these changes could produce irreversible damage to the body, it is essential to understand how these changes may occur and what physiological limits may be endured without harm.

Hematocrit—the volume percentage of erythrocytes in whole blood

Orbital flight in a spacecraft such as Skylab provides a laboratory having an artificially maintained atmosphere, near weightlessness, and nearly closed ecological environment. Studies conducted here may provide new information relating to man's ability to acclimate safely to spaceflight and may also provide valuable insight into the underlying mechanisms by which these changes are accommodated.

The Skylab Hematology and Immunology experiments described on the following pages include five investigations to evaluate specific aspects of man's immunologic and hematologic systems that might be altered by or respond to the spaceflight environment. The biochemical functions investigated with these experiments include (1) cytogenetic damage to blood cells, (2) immune resistance to disease, (3) regulation of plasma and red cell volumes, (4) metabolic processes of the red blood cell, and (5) physical-chemical aspects of red blood cell functions.

**Biochemical
Functions
Investigations**

The investigations being conducted are not meant to provide an all inclusive coverage of immunohematologic functions, but are expected to serve as sensitive indicators of stress-induced changes in these functions in man. Selection of these specific protocols has been based upon experience gained from previous manned spaceflight missions and associated ground based studies. The specific goals of these experiments are to determine—

- 1) environmental factors responsible for the loss of red cell mass noted during the Gemini Program;
- 2) relative roles of the 100% oxygen environment, nitrogen in small amounts, weightlessness, duration of exposure, diminished red cell production versus increased destruction, ambient total pressure, vibration, ambient temperature, and dietary factors;
- 3) spaceflight factors responsible for changes in plasma volume;

- 4) influence of long-duration spaceflight on the coagulation process, platelet function, and vascular friability, and to assess the environmental factors responsible for such changes;
- 5) any alterations in inflammatory response that may occur as a result of long-duration spaceflight, and evaluate;
- 6) extent to which spaceflight may influence mitosis (cell division) and/or chromosomal composition, and which environmental factors are responsible and what preventive action can be taken if such changes do occur.

Cytogenetic
Studies of
the Blood

SKYLAB EXPERIMENT M111

EXPERIMENT BACKGROUND

Because chromosome aberration yields in peripheral blood leucocytes have been found to be sensitive indicators of exposure to radiation, such measurements can be employed as *in vivo* dosimeters.

In mitosis (cell reproduction), each chromosome duplicates itself with the duplicates being separated from each other at cell division. One duplicate chromosome goes into the nucleus of one daughter cell and the other duplicate goes into the nucleus of the second daughter cell. The end product of this process is cell division which involves several phases. Each phase is characterized by a particular pattern of chromosome behavior. It is during one of these phases (the metaphase) that chromosomal aberrations may be microscopically observed.

Metaphase—the middle stage of mitosis during which the lengthwise separation of the chromosomes in the equatorial plate occurs.

Chromosome analyses were done for all of the Gemini missions (with the exception of Gemini VIII which was terminated early) under the operational medical program. Significant, though slight, increases in some types of chromosomal aberrations were seen following some of the missions. This effect could not be correlated with mission duration, extravehicular activities, isotope injection of the crews or other obvious flight parameters. Observations on the Skylab crewmembers can assist in elucidating the mechanism of this phenomenon.

Measurement of the number of chromosome aberrations has been demonstrated by ground based studies to be a sensitive method of biological radiation dose estimation. Ambient radiation encountered during long duration missions or unexpected solar flare events could produce significant increases in aberration levels. Even if no detectable increases in aberration levels are observed in the Skylab missions, the experiment will have served the useful purpose of demonstrating the lack of a detectable genetic hazard associated with these missions.

Standard
Statistical
Procedures

The method of detecting chromosomal aberration will be visual analysis that involves counting the chromosomes, the number of breaks, and types where possible, and then making a comparison between the identifiable chromosome forms with groups of chromosomes that compose the normal human complement.

Standard statistical procedures will be used to determine if a significant increase in aberrations appears postflight. This analysis will include comparisons of preflight aberration levels in normal individuals of the general population. "Predicted" aberration levels for postflight samples will be calculated by using inflight physical dose radiation measurements (available from Experiment D008, Radiation in Spacecraft, and other sources) and existing experimentally determined chromosomal aberration production coefficients. The effects of any other operational or experimental procedure likely to produce chromosomal aberration (such as radioisotope injections) will be measured on normal control subjects. These control subjects will be similar in age and physical attributes to the crewmembers. The control subjects will participate in all tests and medical procedures that are undertaken by the flight crewmembers. Examination will be made of the chromosomes of the control members and the flight crew before initiation of preflight procedures and tests to detect any chromosomal aberrations already present.

By allowing for predicted aberration yields and the yields due to experimental or operational procedures, any aberration frequency difference evident from comparisons of preflight and postflight samples can be ascribable to radiation or other space parameters.

SCIENTIFIC OBJECTIVES

The objectives of this experiment are to make preflight and postflight determinations of chromosome aberration frequencies in the peripheral leucocytes of the Skylab flight crewmembers and to provide *in vivo* dosimetry. These data will add to the findings of other Skylab cytologic and metabolic experiments to determine the genetic consequences of long-duration space travel on man.

Dosimetry—the accurate and systematic determination of doses.

EQUIPMENT

No inflight hardware is required since the experiment uses blood samples taken pre- and postflight beginning one month before launch and ending three weeks after recovery.

PERFORMANCE

The leucocytes will be placed in a short-term tissue culture. During the first cycle of mitotic activity in the *in vitro* cultures, standard chromosome preparations of the leucocytes will be prepared.

The leucocytes from the cell culture will be removed during metaphase and "fixed." A visual analysis will be performed which involves counting the chromosomes, the number of breaks and types where possible, and then making a comparison between the identifiable chromosome forms with groups of chromosomes comprising the normal human complement.

DATA

The data from this experiment will consist of the chromosome aberration frequencies that appear after flight for nine men, three of whom will have experienced 28 days in Earth orbit and the rest 56 days each. An estimate of the radiation dose experienced by each man will be made based on the number of chromosome breaks.

Man's
Immunity,
in vitro
Aspects

SKYLAB EXPERIMENT M112

EXPERIMENT BACKGROUND

Information on man's humoral and cellular immunity and coagulation phenomena during and following exposure to space flight is essential before flight crews can be committed to extended missions. Significant alterations of the immunity mechanisms will produce prejudicial effects upon this inherent defense system, thereby seriously compromising the crewman's operational status. The cellular immunity system is exquisitely sensitive to radiation, and the coagulation status is affected by man's activity.

The experimental program measures items which contribute to man's ability to combat infections and repair traumatized (injured) tissues after exposure to weightlessness, spacecraft atmosphere, sublethal ionizing radiation, the monotonous immunologic stimulation of a closed environment, and the unusual orientation and physical activity. Significant alterations of the extracellular or cellular immune-mechanisms may produce detrimental effects upon normal physiological functions, may result in increased susceptibility to infections, and conceivably can induce the onset of autoimmune diseases.

SCIENTIFIC OBJECTIVES

The objective of this experiment is to assay changes in humoral and cellular immunity as reflected by the concentrations of plasma and blood cell proteins, blastoid transformations, and the synthesis of ribonucleic acid (RNA), and deoxyribonucleic acids (DNA) by the lymphocytes (white cells in lymph).

Autoimmunization—the production in an organism of reactivity to its own tissues

EQUIPMENT

The inflight blood collection system will draw venous blood and centrifuge the samples for preservation. Onboard freezing will be used to preserve the samples during the mission and maintain them in a frozen state. They will be returned in the frozen state in a urine-return container for postflight analysis. This inflight blood collection system and allied facilities will be used to obtain, process, preserve, and return hematology samples for Experiments M071, M073, M112, M113, M114, and M115. (See M115 for more details on this equipment.)

PERFORMANCE

Experiment Investigations

The experiment will obtain preflight baselines, which will be indications of normal metabolism, from the crewmembers and a control group composed of three men physically similar to the crewmembers who will serve as controls while the crewmembers are in spaceflight. Inflight blood samples will be taken four times from each crewman during the 28-day mission and eight times from each crewman during the 56-day missions. Upon recovery after the spaceflight, information will be again obtained from the crewmembers before body functions "normalize," and compared with the preflight baselines, inflight profiles, and with the data being obtained from the ground control group (GCG) to detect any significant deviations. An extensive battery of analyses will be performed using appropriate laboratory techniques to detect qualitative and/or quantitative changes. Periodic examinations will be made of the blood proteins and lymphocytes until the possible altered concentrations are likely to have stabilized. Protocols for the experiment are given in the section on Experiment M115.

DATA

Data will be gathered from blood samples taken preflight, inflight and postflight. These samples will be analyzed for the following constituents:

- 1) total plasma proteins;
- 2) plasma protein fractions (albumins, alpha globulins, beta globulins, gamma globulins);
- 3) lymphocyte morphology;
- 4) ribonucleic acid (RNA) and deoxyribonucleic acid (DNA) synthesis rates in lymphocytes;
- 5) kinetics of lymphocyte RNA and DNA;
- 6) observation of blastoid formation;
- 7) lymphocyte functional response to antigen;
- 8) quantification of 4.5s, 7s, and 19s.

Antigen—a substance that stimulates antibodies

SKYLAB EXPERIMENT M113
EXPERIMENT BACKGROUND

Environmental factors encountered during spaceflight may affect the red cell mass and plasma volume. These include near weightlessness, the spacecraft breathing atmosphere, and ionizing radiation environments.

Weightlessness may cause a redistribution of the total blood volume between the arterial and venous segments and by reducing the quantity of blood in the limbs. In the weightless state, a redistribution of pulmonary blood volume may occur with relatively greater perfusion in the apex of the lungs. In this condition, ventilation and perfusion ratios might be expected to be similar to those produced when the subject is lying down in zero gravity. Results from previous missions suggest that these changes have not produced pathological changes in the blood vessels. It is not known, however, whether long-duration missions could predispose to changes including thrombosis (blood clot). Previous missions have also led to changes in circulating plasma volume at recovery. Analysis has suggested that these changes are of a magnitude similar to those found in bed rest. The rate at which this change occurs and whether the plasma volume decreases or is augmented during the stress of reentry is unknown. It is believed that plasma volume changes may have contributed to the temporary orthostatic hypotension and to the decrease in exercise tolerance that crewmembers experienced soon after recovery.

The site of red blood cell (RBC) production in the mature adult is the marrow of membranous bones (e.g., sternum and vertebrae). The rate of production is dependent on metabolic demands and the current red cell population. The rate of RBC production can be measured quantitatively by injection of a known quantity of a radioactive iron tracer. The radioiron, combined with globulin, is transported to other parts of the body. That part of the iron which reaches the membranous bones is incorporated into the heme portion of hemoglobin by the bone marrow. Since not all the iron appearing in the plasma is used for erythrocyte production but is instead taken up by the iron pools of the body, a fraction of the injected radioiron will be unavailable for incorporation into developing RBCs. This can be determined by measuring the concentration of radioiron in the circulating RBC after seven days and comparing it with the initial concentration of radioiron in the plasma.

Heme—the nonprotein, insoluble, iron protoporphyrin constituent of hemoglobin

Since the rate of RBC production acts with RBC loss to increase or decrease the total RBC mass present at a given time, any changes in the rates of RBC production and destruction will be necessarily reflected in the red cell mass.

Such changes in red cell mass can be measured and analyzed by injection of radioactive chromium (in the form of sodium chromate) tagged red cells. The sodium chromate diffuses through the cell membrane where it is converted to chromium chloride and, in this form, bound to hemoglobin. The volume of RBCs is then calculated by allowing the chromium-tagged cells to disperse through the circulatory system and measuring the extent to which the chromium has become diluted. The fact that chromium does not reenter the red cell makes it a good tracer for RBC mass determinations. Chromium incorporated into the hemoglobin structure of the circulating red cell also provides a means for estimating the rate of random cell destruction by monitoring the rate at which chromium disappears from the red cell mass.

Red Cell Life
Span

To determine selective age dependent erythrocyte destruction and mean red cell life span, carbon 14 labeled glycine will be injected into a superficial arm vein of each crewmember and control subject. The radioactively labeled glycine, by its incorporation into the heme portion of hemoglobin, labels the erythrocytes produced on that day. Sequential blood sampling will then give the percentage of labeled erythrocytes in the blood at any given time (days), and by plotting this data, survival and destruction curves can be obtained. The resultant curves can then be analyzed mathematically and a mean life span for the cells determined. Since only a small portion of the carbon 14 is reutilized in erythropoiesis, it is an ideal RBC label.

Erythropoiesis—the production of erythrocytes

Finally, plasma volume changes can be measured by adding a known amount of radioiodinated human serum albumin to each crewmember's blood. Albumin is a major constituent of the plasma and is the protein most responsible for maintaining the osmotic pressure at the capillary membrane. It acts to prevent plasma fluid from leaking out of the capillaries into interstitial space.

The Skylab life support system provides a combination of breathing gases which because of the lower than normal nitrogen partial pressure will be hypobaric. The partial pressure of oxygen in the breathing atmosphere will be slightly increased at least during extravehicular activity by the crew. Additionally, the atmosphere will contain trace amounts of other gases released from onboard equipment and supplies. Small amounts of other gases may also be released as a result of the crew's metabolic activity and from bacteria and molds which may be present.

Hypobaric—characterized by less than normal pressure or weight

In the Gemini flight, red cell mass decreases were found that were generally greater than the red cell mass decreases found in Apollo flight crewmembers. Total pressure of the atmospheres in the Gemini and Apollo missions were quite similar while partial pressures of oxygen and nitrogen were

different—more oxygen and no nitrogen present in the Gemini missions. It is probable that there were also differences in the trace gases respired during the missions.

The red cell mass differences in these previous missions were probably related to the above factors although other factors might have been important also. As an example, red cell mass changes are expected as a result of changes in the amount of physical activity performed during the mission. Athletic conditioning is associated with an increase in red cell mass. Conversely, red cell mass declines have been found in certain bed rest studies, although in the studies to date the amount of blood drawn for research testing may have been a factor in the decreased red cell mass.

Since a number of inflight environmental conditions have been found capable of affecting the total blood volume and its constituents, delineation of inflight effects on hematopoiesis is necessary in order to predict the course and consequences of long duration spaceflights on future flight crewmembers.

Hematopoiesis—the formation of blood cells

SCIENTIFIC OBJECTIVES

The objective of this experiment is to determine the effect of Earth orbital missions on plasma volume and red blood cell populations with particular attention paid to changes in red cell mass, red cell destruction rate, red cell life span, and red cell production rate.

PERFORMANCE

Blood samples will be collected preflight, postflight, and inflight, and processed in accordance with the protocol shown in M115.

DATA

The data to be collected in support of this experiment include the following variables:

- 1) red cell life span;
- 2) red cell production, distribution, and destruction rates;
- 3) plasma volume.

Red
Blood Cell-
Metabolism

SKYLAB EXPERIMENT M114

EXPERIMENT BACKGROUND

At one time, the red blood cell was believed to be an inert particle composed of water and hemoglobin. We now know,

of course, that the erythrocytes are living cells, doing work, and requiring energy just as other tissues in the body do. The average life span of the human red blood cell is estimated to be 120 days. During this period, it is estimated that the average erythrocyte travels 100 miles between the heart and the tissue that it serves. In order to remain functional, the red corpuscle must (1) maintain an internal environment against a steep ionic gradient across the cell membrane, (2) resist forces that try to change its characteristic bi-concave shape to spherical, (3) maintain active transport mechanisms that support the metabolic requirements of the cell. Interruption to these processes would render the red blood cell ineffectual and would be fatal in a matter of days.

**Influence of
Spacecraft
Environment**

This experiment will assess the influence of the spaceflight environment on the metabolic processes of red cells. The red blood cell requires for its energy source a continuous supply of glucose. The process by which the glucose penetrates the red blood cell's membrane is not known; however, it is believed to involve an active transport process rather than simple diffusion. It is suspected that the membrane's framework, in particular the fatty (lipid) fraction of the framework, is functional in this process. Because the membrane is the dynamic component in the active transport process, its chemical composition and structural integrity will be examined by this experiment.

Through the metabolic breakdown of glucose, particularly ADP (adenosine diphosphate) to ATP (adenosine triphosphate) energy is stored in chemical bonds. Changes in the glucose metabolic pathway, which may occur as a result of spaceflight, will be analyzed by examination of several key intracellular enzymes found in preflight and postflight blood samples.

Enzyme—organic substance capable of presenting chemical changes in organic substances by catalytic action, such as in digestion

SCIENTIFIC OBJECTIVES

The objective of this experiment is to determine if any metabolic and/or membrane changes occur in the human red blood cell as a result of exposure to the spaceflight environment.

EQUIPMENT (See M115.)

PERFORMANCE (See M115.)

DATA

The data that will be taken in support of this experiment will be the preflight, inflight, and postflight values of the following variables:

- 1) methemoglobin;

- 2) reduced glutathione;
- 3) glyceraldehyde-6-phosphate dehydrogenase;
- 4) pyruvate kinase;
- 5) glyceraldehyde-3-phosphate dehydrogenase;
- 6) phosphofructokinase;
- 7) hexokinase;
- 8) phosphoglyceric acid kinase;
- 9) acetylcholinesterase;
- 10) lipid peroxide levels;
- 11) adenosinetriphosphate;
- 12) 2,3-diphosphoglycerate.

Special
Hematologic
Effect

SKYLAB EXPERIMENT M115

EXPERIMENT BACKGROUND

Data collected from pre-Skylab spaceflights indicate that the spaceflight environment may induce a loss of red blood cells in the crew. These earlier investigations have suggested that this loss may result from a self-limiting hemolysis which appears to be related to alterations in mean corpuscular volume and increased osmotic fragility. Since reticulocyte (an early form of the red blood cell) counts which indicate bone marrow activity have not revealed depression of the bone marrow activity due to such flights, and since reticulocytosis (above normal reticulocyte count) did not appear until the fourth day, it is likely that red cell loss resulted from a reduced need for red cells for the transport of oxygen.

Hemolysis—the liberation of hemoglobin

Similar data gathered during Apollo missions provided a basis for comparison with the data derived from the Gemini program. Comparison of these data suggested that a causative factor in the reduced RBC was the Gemini atmospheric composition—specifically, the high oxygen concentration. Data obtained from the later Apollo flights have also indicated alteration of fluid and electrolyte balance, while examination of red cell electrolytes by electron probe analysis indicates similar shifts.

A “bestfit” hypothesis based on these previous data would have it that the hyperoxic atmosphere in spacecraft (and possibly other environmental parameters such as

weightlessness) induces chemical changes in the red blood cell membrane. These changes directly or indirectly disrupt the active transport mechanisms leading to increased osmotic pressures and eventual lysis (destruction) of the cell either through membrane swelling and rupture or through lipid breakdown and fragmentation.

SCIENTIFIC OBJECTIVES

The objectives of this experiment are to examine critical physiochemical hematological parameters relative to the maintenance of homeostasis, and to evaluate the effects of spaceflight on these parameters.

EQUIPMENT

Inflight Blood Collection

The inflight blood collection system that supports this related series of studies is designed to collect and process blood samples without coagulation or contamination. The inflight blood collection system contains the following major components:

- 1) syringes capable of extracting approximately 11 milliliters of venous blood from each crewman under sterile procedures;
- 2) small blood sampling vials, into which the crewman places a few drops of whole blood already containing a fixative;
- 3) automatic sample processors, two-chamber spring-loaded containers, used to process and separate the blood cells from the plasma by centrifugation;
- 4) a two-speed centrifuge used to receive the automatic sample processors and separate the blood into red cells and plasma, and to maintain this separation in the weightless environment.

Venous—relating to a vein.

PERFORMANCE

The blood samples for the group of Hematology and Immunology Experiments will be collected in accordance with Figure 3-3. Specific handling and processing procedures will be followed to obtain the data for each of the experiments.

Records will be maintained that include sampling times and the time, name, and quantity of any injections taken (including x-rays), plus any illness of a subject. A record will be maintained during the flight of the following events: flight duration, extravehicular activity, solar events, any abnormal exposure to radiation, infectious diseases, symptoms of

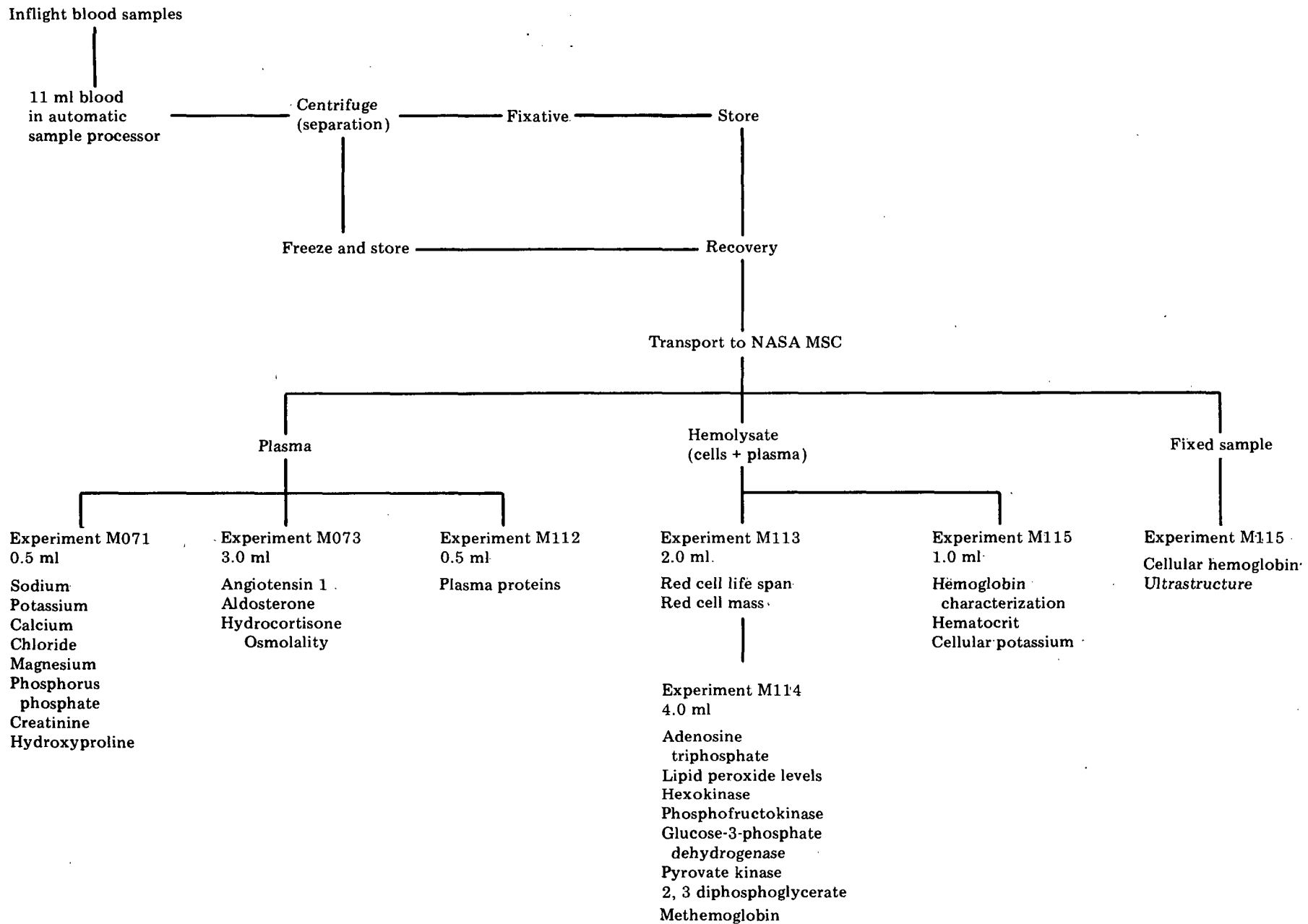

33 Figure 3-3 Inflight Blood Processing Flow Chart for Hematology and Immunology Series Experiment

illness, use of medication and types of drugs used, with dosage and duration of usage. Also any deviation from the expected orbital workshop atmospheric total pressure or partial pressure of its constituents will be recorded.

Blood samples will be taken inflight four times from each crewman during the 28-day mission and eight times from each crewman during the 56-day mission.

DATA

Supporting Data

Data in support of Experiment M115 will be taken preflight and postflight only and will consist of information about the following variables of routine hematology:

- 1) red cell count;
- 2) hematocrit;
- 3) hemoglobin;
- 4) red cell indexes;
- 5) reticulocyte count;
- 6) white cell count;
- 7) differential and morphology;
- 8) platelet count;
- 9) acid and osmotic fragilities.

and special hematology:

- 1) red cell critical volume and red cell volume distribution;
- 2) hemoglobin characterization;
- 3) single cell hemoglobin distribution;
- 4) membrane and cellular ultrastructure;
- 5) intraerythrocytic electrolytes;
- 6) red cell electrophoretic mobility;
- 7) red cell density separation;
- 8) cellular RNA, protein distribution.

Section 4

Cardiovascular Status

Lower Body Negative Pressure,
Skylab Experiment M092

Vectorcardiogram,
Skylab Experiment M093

GENERAL BACKGROUND

The cardiovascular system, one of the vital systems of the body, functions as a transport media linking man's internal environment (the interstitial fluid surrounding all cells) with the three large surface areas exposed to his external environment (lungs, gastrointestinal tract and kidneys). In essence, it consists of a very large number of very small tubular vessels (capillaries) which permeate all regions of the interstitial fluid and the externally exposed areas of the lungs, etc. The extensive capillaries are joined by larger vessels (arteries and veins) to a pump (the heart), thus forming a closed system through which the transporting fluid (the blood) is kept flowing at an adequate rate.

Blood Flow

The circular nature of the blood flow is demonstrated in the schematic diagram of the cardiovascular system of Figure 4-1. The system consists of two capillary networks connected in series with two pumps to form a closed loop. The two pumps, the right and left ventricles of the heart, shown physically separated in the diagram, actually comprise a single organ. The blood leaving the right ventricle flows to the capillary bed of the lungs while that leaving the left ventricle flows to capillaries distributed throughout the rest of the body. Each ventricle is preceded by a supporting atrium, a chamber of the heart, which acts as a receiving reservoir and auxiliary pump to fill the associated ventricle.

Blood leaves the right ventricle through a single, large vessel, the pulmonary artery, and enters the left atrium from the

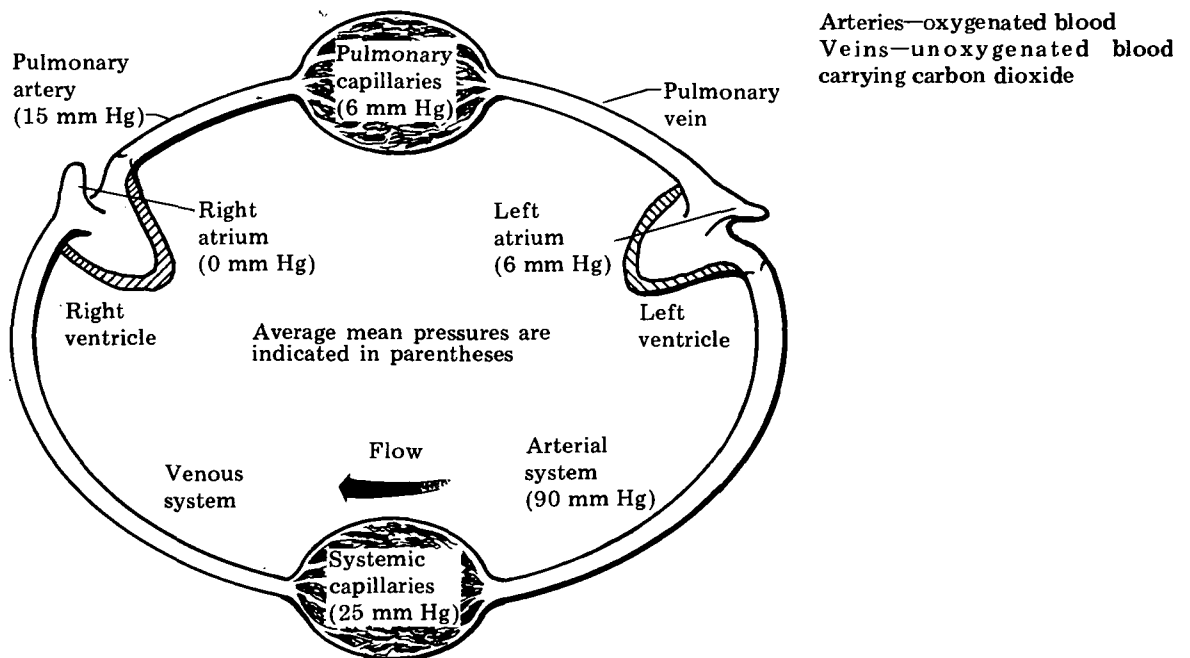

Figure 4-1 Schematic Diagram of the Circulatory System

lungs by way of four pulmonary veins; it leaves the left ventricle through the large aorta, and returns from all parts of the body by way of two large veins, the superior and inferior venae cavae. All vessels carrying blood from the heart to capillaries are arteries, and those conveying blood from capillaries back to the heart are veins. The circulating blood volume in man is about 76 ml/kg of body weight, about 5.3 liters in an average man weighing 70 kilograms.

Systemic Circuits

The part of the vascular system traversed by the blood in going from the left ventricle to the right atrium is called the systemic circuit. It includes the capillary beds of all parts of the body except the lungs. The pumping force that moves blood through this circuit comes from contractions of the left ventricle. The large number of capillary networks that supply the organs and tissue of the body constitute many circuits connected in parallel and supplied by the extensively branched arterial system that begins with the aorta. Blood leaving the capillaries enters small veins that join together to form larger and larger veins. This arrangement continues until all the systemic blood returns to the right atrium through the two large venae cavae. The systemic circuit contains about 80% of the total circulating blood volume, approximately 4240 milliliters for the 70-kilogram average man.

Capillaries

The capillaries, which have very thin and permeable walls, exchange water and dissolved materials (including gases) with the interstitial fluid. This two-way passage (in and out) of fluid has been estimated to exceed 200 liters per minute.

The capillaries are very small but their number is so large that the total area available for diffusion is very large, approaching 100 square meters. The number of capillaries in tissue can be correlated with the metabolism of the tissue; for example, in a heart muscle where oxygen use is high, microscopic studies show as many as 6000 capillaries in each square millimeter of tissue cross section. Since many capillaries may "close down," especially in the skeletal muscle except during exercise or work, the volume of blood present in the systemic capillaries is variable. It has been estimated that in an average adult this volume may range between 60 and 200 milliliters.

The systemic arteries act as conduits to distribute blood to the systemic capillary beds. The aorta at its beginning (the ascending aorta) has an outer diameter of about 2.5 centimeters and a wall thickness of nearly 2 millimeters. At each branch point, the cross sectional area of each branch is smaller than the parent vessel while the total cross sectional area of the branches is greater. The arteries do not contribute significantly by diffusion to the exchange of materials with the interstitial fluid. The volume of blood contained within all the systemic arteries under normal circumstances is estimated to be about 20% (~one liter) of the total blood volume.

Total Blood Volume—~5 liters
Volume in Systemic Arteries—~1 liter

The smallest branches of the arterial system are called arterioles. Arterioles are different from small arteries in that their walls are thick in relation to their internal diameter. This extra wall thickness consists of circumferentially oriented smooth muscle fibers. The cross sectional area of the arteriolar lumen varies with contractions of the smooth muscle which are controlled by neurohumoral factors. These changes control resistance to blood flow in the systemic circuit and distribution of the blood flow to the capillary beds.

The veins form an extensive recovery system for conveying the blood returning from capillary beds to the right atrium. Although their walls are much thinner than those of the arteries, they also permit no significant diffusion of substances through them. The distinctive feature of the venous system is its large volume. The volume of blood contained within the veins is about 75% of the volume in the whole systemic circuit or about 3200 milliliters. Veins, unlike other vessels, are equipped with one-way valves that permit blood flow only toward the heart.

Pulmonary Circuit

The pulmonary circuit, which is sometimes called "the lesser circulation," extends from the pulmonary artery as it leaves the right ventricle to the pulmonary veins as they enter the left atrium. The pulmonary circuit carries venous blood (i.e., blood which has come from systemic capillaries and is therefore low in oxygen content and high in carbon dioxide content) to the lungs, where it is converted to arterial blood (blood which is freshly oxygenated and has had much of the carbon dioxide removed). The pulmonary artery is the only artery that carries venous blood, and the pulmonary veins are the only veins that carry arterial blood. The pulmonary circuit, like the systemic, is composed of arteries, capillaries, and veins, but all vessels are generally shorter and larger in diameter than corresponding systemic vessels. In the pulmonary circuit thick-walled arterioles are absent and the very small arteries (<100 microns in diameter) show little or no smooth muscle in their walls.

In the human lungs, air is conducted via the trachea, bronchi, and their branches to about 300 million small air sacs or alveoli, which are honeycomb-like structures about 200 to 250 microns in diameter. The pulmonary capillaries, which are 10 to 14 microns in length, and 7 to 9 microns in diameter, extend as a dense network within the thin, membranous partitions separating adjacent alveoli. Calculations have shown the surface area of capillary wall exposed to the alveolar air averages to be from 50 to 70 square meters in the average adult. The total volume of blood within the capillaries of the pulmonary circuit is of the order of 100 milliliters.

Micron—a millionth part of a meter

DYNAMICS OF THE CARDIOVASCULAR SYSTEM

Much of our knowledge of the dynamic characteristics of the cardiovascular system, and the mechanisms governing its response to changes in activity, environment, and disease has come from observations on animals, chiefly dogs. In recent years, great technological advances in bioinstrumentation have made it possible to confirm and extend these observations on man. It is still true, however, that many measurements can be made only on anesthetized animals, some can be made as well on unanesthetized animals but not on man, and some on both animals and man in the conscious state. Under all conditions, the method of measurement used will disturb, to some extent, the cardiovascular system of the subject, and influence the variable being measured. It is always important to minimize this disturbance, to assess its significance, and to take it into account, when possible, in interpreting the results.

Hemodynamically, the circulatory parameters of most interest are pressures and flows in various parts of the cardiovascular system. Because of the rhythmical contractions of the heart, the input of blood into both pulmonary and systemic circuits is intermittent. Consequently, the blood flow in all the systemic arteries, the systemic veins close to the heart, and probably all of the pulmonary vessels is pulsatile rather than steady. In the systemic capillaries and peripheral veins, the flow is essentially steady because of the low-pass filtering action of arterial compliance and arteriolar resistance. Pressures, therefore, are pulsatile in all four chambers of the heart and in all parts of the vascular system with the exception of systemic capillaries and peripheral veins.

Mechanically, the heart is a muscular organ consisting of two major pumping chambers, the right and left ventricles, each of which receives blood from a contractile antechamber, right and left atria, respectively. Backflow of blood from ventricle to atrium is prevented by the valve on the right side (tricuspid) and the valve on the left side (mitral). The right ventricle ejects blood into the pulmonary artery from which backflow is prevented by a semilunar pulmonary valve. Backflow of blood into the left ventricle from its outflow vessel, the aorta, is prevented by a similar semilunar aortic valve.

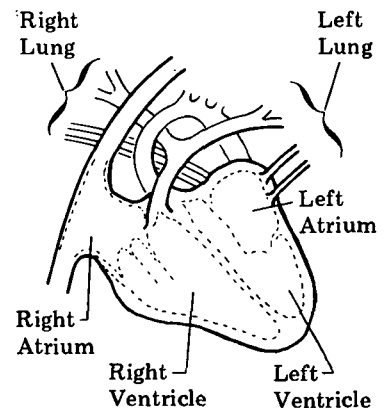

Diagram of Human Heart

Heart Automaticity

An outstanding characteristic of cardiac activity is the fact that the heart continues to contract rhythmically when all of its connections with the nervous system are severed, or even when it is removed completely from the body. This indicates that, unlike skeletal muscle, cardiac muscle is not dependent upon impulses coming to it from the nervous system for its activation. It has the property of automaticity.

Automaticity—occurring spontaneously, unvoluntarily

Normally, the rhythmically occurring stimuli responsible for cardiac contraction arise in the sinus node. This "built-in stimulator" or pacemaker of the heart has the property of automatically discharging rhythmical stimuli which activate the heart. This wave of excitation, beginning in the sinus node and traveling in all directions through the atrial muscle, is known as the cardiac impulse. It consists of electrical (action currents), chemical and thermal changes, and is followed closely by mechanical contraction. As in the case of a nerve impulse traveling along a nerve fiber, or in impulse traversing a single skeletal muscle fiber, the cardiac impulse also involves a progressive depolarization of cell membranes.

Depolarization—the act of neutralizing polarity

Contraction Sequence

The normal sequence of contraction of the heart chambers results from the spread of the cardiac impulse. This impulse arises in the sinus node, located in the wall of the right atrium; hence this chamber contracts first. Because the rate of conduction of the impulse through atrial muscle is quite rapid, the left atrium contracts only a very short time after the right. Practically, the two atria contract almost simultaneously. The impulse is slowed down considerably, however, while traveling between the interatrial septum and the ventricular muscle mass. This is because conduction between atria and ventricles can only occur by way of the

A-V (atrio-ventricular) node and "bundle" (a specialized conducting tissue). The only other tissue normally connecting auricles with ventricles is connective tissue, which does not have the property of conducting an impulse. This results in the completion of atrial contraction before ventricular contraction begins. During the period of contraction and depolarization, action currents similar to those in all muscles of the body can be sensed at the surface of the body.

ENVIRONMENTAL INFLUENCE ON CARDIOVASCULAR FUNCTION

During routine daily activities, the force of gravity influences the distribution of blood in the cardiovascular system and, consequently, changes the nature of blood flow regulation. Thus, the function of this system is dependent upon the effects exerted by the Earth's gravitational pull.

Problems Due to Lack of Gravity

The effects of null or diminished gravitational forces that are experienced during space flight have not been fully elucidated by past studies. However, flight observations coupled with analyses of the cardiovascular system have indicated the following potential problem areas when the forces of gravity are altered.

Cardiac Contractility—Reduction in work performed by antigravity muscles reduces the nutritive and waste removal

requirements imposed upon the cardiovascular system; hence, the heart leads a more sedentary existence. One mechanism by which it can decrease its total output is to reduce the forcefulness of each contraction.

Vascular Responsiveness—Alterations in the responses of the vascular smooth muscle, which occur with decreased stimulation (hormonal, nervous, mechanical) with changes in the contractile properties of smooth muscle cells, and with alterations in vessel geometry caused by change in intravascular volume, will result in qualitative and quantitative changes in the cardiovascular function. In particular, the vascular neural reflexes that compensate for drainage of intravascular fluid away from the heart when a man assumes an upright position in a gravitational field become less effective. This situation, called orthostatic hypotension, can develop after a few days in a weightless state and upon return to Earth could lead to temporary bouts of fainting because of inadequate brain circulation.

Capillary Exchange—Alteration in the transcapillary pressure gradients or the properties of the capillary walls change the quantity and the composition of the fluid that moves from the intravascular into the extravascular spaces.

Viscoelastic Characteristics of Vessels—Changes in vascular distensibility, especially that of the capacitance vessels (located principally in the venous circulation), markedly alter the quantity of blood returned to the heart as well as the time-dependent characteristics of venous blood return, and thence, alter the output of the heart.

Decreased Endocrine Activity—Depletion of vasoactive hormone stores (e.g., norepinephrine) or decreases in their rates of synthesis effectively limit or alter the ability of the vascular system to respond to stress when the need arises. Smooth muscle responses to given concentrations of vasoactive hormones may also assume different patterns as adaptation to a new environment occurs.

Vasoactive—exerting an effect upon the blood vessels

Decreased Vascularity—Both an enriched oxygen atmosphere and a decrease in oxygen demands of tissues associated with decreased work will reduce the oxygen transport requirements placed upon the cardiovascular system. The rate of oxygen diffusion through the tissue spaces to meet cellular oxygen needs will become lower. Thus, the diffusion paths can be lengthened without compromising these needs. Under these circumstances, tissues become less vascular through a relatively slow process of acclimatization.

Shifts of Intravascular Fluid Volumes—Volume receptors that respond to vessel or heart chamber wall stretch are stimulated by shifts of fluid within the vascular spaces when

gravitational forces are removed or decreased. Through neuroendocrine pathways, a diuresis is initiated and the total water content of the body is reduced. This results in partial dehydration of body tissues and reduces the capacity to respond to stress.

Nonspace Related Conditions—Consideration must also be given to debilitating cardiovascular diseases and to other Earth environmental conditions not unique to weightlessness. The occurrences of these are not precluded by weightlessness; hence, long term comprehensive longitudinal studies on flight crews and improved prediction models are required to establish probability tables to assist medical support of long duration missions.

The Skylab program incorporates two experiments that provide information on the performance of the cardiovascular system in the near weightless environment of space. This information will aid in establishing the relative importance of the above problems for long-duration spaceflight.

Inflight Lower
Body Negative
Pressure
(LBNP)

SKYLAB EXPERIMENT M092

EXPERIMENT BACKGROUND

Reduced orthostatic tolerance can be demonstrated by provocative (stimulating) testing during weightless flight. One method of provocative testing involves the application of lower body negative pressure (subambient pressure to the body surface below the diaphragm). The equipment to apply this negative pressure is the lower body negative pressure device (LBNPD). Physiological indicators are heart electrical activity, pulse pressure, blood pressure, heart rate and limb volume.

Orthostatic—pertaining to or caused by standing erect.

The body stresses produced by LBNP on the cardiovascular system of a supine subject in 1-g in certain respects closely resembles the effects produced by a normal upright posture. These stresses are an effective decrease in resistance to blood flow to dependent portions of the body, and increase in the level of venous pressure in dependent veins required to return blood to the heart. LBNP results in pooling of blood in the lower body hindering its return to the heart, and therefore elicits a similar cardiovascular response to that experienced during upright posture on Earth. LBNP thus provides an objective means of provoking cardiovascular responses that can be used to determine the extent of cardiovascular deconditioning. The technique could conceivably serve as a countermeasure to deconditioning due to the near weightless environment, by providing periodic calibrated stresses that may minimize the effects of spaceflight.

Supine—lying on the back in a relaxed position

SCIENTIFIC OBJECTIVES

Cardiovascular Deconditioning

The objective of this experiment is to provide information concerning the time course of cardiovascular deconditioning during flight and to provide inflight data for predicting the degree of orthostatic intolerance and impairment of physical capacity which is expected following Earth return.

EQUIPMENT

The major components of the experiment equipment used are—

- 1) lower body negative pressure device (LBNPD),
- 2) leg volume measuring system (LVMS),
- 3) blood pressure measuring system (BPMS),
- 4) body temperature measuring system (BTMS) (M171 experiment equipment),
- 5) vectorcardiograph (VCG) (M093 experiment equipment).

The LBNPD consists of a cylindrical tank with a waist seal that provides positive isolation of the inner volume and lower limbs from the ambient atmosphere. An inner crotch support prevents the crewman from being pulled into the device by the reduced internal pressure during operation. This device can be evacuated to a controllable pressure of 0-50 mm Hg below the ambient cabin pressure.

The LVMS senses the changes in the circumference of the leg at the level of the calf muscle by a capacitive type detector leg band. Data signals from the leg band are then conditioned and displayed on a console panel as percent volume change.

The BPMS includes an inflatable arm cuff and a microphone for detecting the Korotkoff sounds characterizing blood flow using the auscultatory method. These pressures can be displayed and/or recorded for transmission to the ground.

Korotkoff Method—to determine blood pressure

The auscultatory method—listening for sounds in the body to ascertain the condition of the lungs, heart, etc

PERFORMANCE

Each of the crewmen will participate in the LBNP tests at approximately the same time each day, every third day during the mission. A LBNP test will consist of a 5-minute period of rest at 15 minutes of progressively decreasing pressure on the lower limbs until 50 mm Hg (1 psi) below cabin pressure is reached. This is followed by 5 minutes of rest. Physiologic measurements are made throughout the test program.

A minimum of five measurement sessions are planned for each flight crew at approximate intervals as follows: selection of the crew, 60 days, 21 days, 10 days, and 2 days before launch. These data will serve as both the experimental control and the baseline reference for postflight data.

Postflight measurements will be made beginning as soon as possible after recovery, at recovery plus 24 hours, and at each 24-hour interval thereafter until normal preflight values are obtained.

DATA

The principal measurements taken during the experiment are as follows:

- 1) pressure differential (ΔP across the chamber),
- 2) leg circumference (correlatable with leg volume),
- 3) blood pressure,
- 4) internal temperature (LBNPD chamber temperature),
- 5) cabin temperature (ambient temperature to the subject's head, shoulders, and upper torso),
- 6) subject's body temperature,
- 7) vectorcardiogram,
- 8) heart rate.

Vectorcardiogram—a graphic record of the magnitude and direction of the electrical forces of the heart

Vectorcardiogram

SKYLAB EXPERIMENT M093

EXPERIMENT BACKGROUND

The excitation process in cardiac muscle is similar to that in skeletal muscle and in nerves. It results in a propagated depolarization of cell membranes described below and is made evident by action currents. The electrocardiogram is a graphic record of the action currents from the heart muscle.

These action currents may be recorded by placing pickup electrodes at two locations on the surface of the body. At any instant during the cardiac cycle the heart may be considered as a battery with the depolarized region of the heart (through which the impulse has already passed at that instant) acting as a negative pole, and the inactive region of the heart (through which the impulse has not yet passed) acting as the positive pole. This battery is immersed in an electrically conducting medium, the body. Consequently, action currents will flow, not only within the heart, but through all the tissues of the body, including those at the surface. Hence, surface electrodes may be used to lead off and record these potential differences as an index of cardiac action currents.

Electrocardiogram

As the cardiac impulse spreads through the heart during each heart cycle, the spatial and electrical relationships between active and inactive regions of the heart are constantly changing, thus causing the surface potentials to change from moment to moment, both in magnitude and direction. These changing potential differences between lead-off points on the body surface, when graphically recorded, constitute the electrocardiogram.

Electrical Axis of the Heart

The electrical condition of the heart at any instant may be represented by a vector whose direction indicates the orientation of the negative or depolarized portion of the heart with respect to the positive or inactive region of the heart at that instant. The magnitude of this vector is proportional to the instantaneous potential difference between the positive and negative portions of the heart. This vector, which undergoes cyclical changes in magnitude and direction in space during each heart cycle, is known as the electrical axis of the heart. The instantaneous potential difference recorded between any two surface lead-off points is proportional to the projection of the electrical axis upon the line joining these two points.

Electrocardiogram—a graphic tracing of the electric current produced by the contraction of the heart muscle

Measurement Points

Thus, a record taken from two points on the surface of the body will provide information concerning the cyclical variations of the electrical axis of the heart. More information can be obtained by recording from several pairs of surface points than can be obtained by recording from only one pair. Hence, it is customary to record, in turn, from three pairs of lead-off points known as the three standard limb leads. Lead I is taken from the two arms, lead II from the right arm and left leg, and lead III from the left arm and left leg. (See Figure 4-2.)

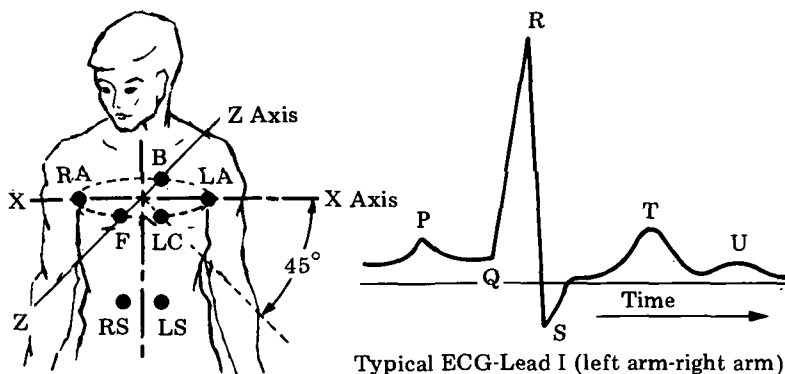

| Standard ECG Limb Leads | | Legend: | |
|-------------------------|-------------------|-------------------|---------------|
| Lead | Positive Terminal | Negative Terminal | |
| I | Left Arm (LA) | Right Arm (RA) | F Front |
| II | Left Leg | Right Arm | B Back |
| III | Left Leg | Left Arm | RS Right Side |
| | | | LS Left Side |
| | | | LC Left Chest |

Figure 4-2 Standard ECG Connections

If some portion of the heart is injured as the result of inadequate blood supply or some disease process, injury currents will flow. These injury currents may appear in the standard limb leads, but sometimes, if the injured area is small, or if it is located in particular regions of the heart, the injury current can be recorded only by applying one electrode to the surface of the body as close to the heart as possible, i.e., on the chest. Consequently, it is customary to

record, in addition to the limb leads, two or more chest leads in which one electrode is placed on the chest and the other electrode on an arm or leg. Additional leads are often taken from the chest and sacral regions.

The form of the electrocardiogram recorded from any lead is determined by the site of origin of the cardiac impulse, its pathway of spread through the heart, the position of the heart within the chest, and the presence or absence of injury currents. This is simply another way of saying that the form of the electrocardiogram is determined by the cyclical variations in direction and amplitude of the electrical axis of the heart and the point of attachment of the leads.

Cardiac Impulse—the impulse or beat of the heart at the fifth intercostal space at the left side of the sternum

The form of the electrocardiogram for a typical normal heart cycle is indicated in Figure 4-2. This curve is typical for the limb leads; minor variations are seen in the chest leads. The important characteristics of the curve are the P wave, the QRS complex, the S-T segment, and the T wave. Important time intervals are the P-R interval and the duration of the QRS complex.

Reading the ECG Wave

The P wave results from the activation of the auricles. The QRS complex results from the activation or depolarization of the ventricles. The S-T segment occurs during the time in which the ventricles are in the completely depolarized state, and the T wave represents ventricular repolarization. No significance is attached to the U wave which is sometimes seen.

Vectorcardiogram

A specialized form of the electrocardiogram called vectorcardiogram (VCG) can be obtained by plotting one channel against the other. Figure 4-3 shows a typical arrangement for generation of VCGs. A cardiologist trained in interpretation of VCGs can tell much about the activities of the heart from such a display.

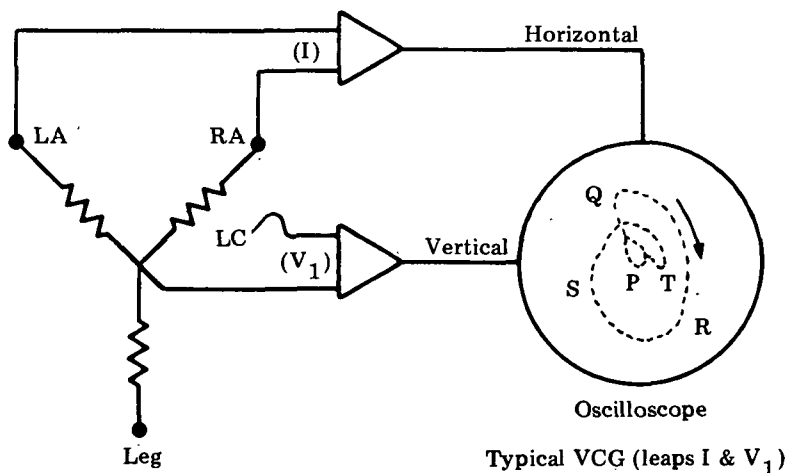

Figure 4-3 VCG Connections

Actually experiment M093 will analyze the three channels of information on a computer to get the information needed. Among the things that can be determined by an analysis of VCG are the electrical orientation of the heart and its movements. This experiment will analyze the VCG taken on each of the nine astronauts who fly in Skylab both preflight, inflight, and postflight. VCGs obtained while the astronaut is at rest and at a number of exercise levels on the ergometer will also be analyzed.

Ergometer—an instrument for measuring the force of muscular contraction

SCIENTIFIC OBJECTIVES

The objective of this experiment is to measure the vectorcardiographic potentials of each astronaut periodically throughout the mission so that flight-induced changes in heart function can be detected and compared with a baseline established preflight.

EQUIPMENT

The equipment consists of the various electrodes and wires for "picking up" the voltages from the astronaut's body and the electronics equipment for amplifying the voltages, protecting the astronaut from electrical shock, and conditioning the voltages into the three channels of information.

PERFORMANCE

The experiment is scheduled to be performed every three days on each astronaut. The subject crew member attaches the VCG electrodes, rests on the ergometer for five minutes, then pedals for two minutes at a set work rate of 150 watts. He then rests for 10 minutes.

DATA

The data, recorded on tape to be telemetered to the nearest ground tracking station, consist of the three standard vectorcardiogram voltage signals and a heart rate channel, along with voice identification of the conditions of recording.

Section 5

Energy Expenditure

Metabolic Activity,
Skylab Experiment M171

GENERAL BACKGROUND

The most basic process of living systems is production of energy by metabolism. The energy derived from these processes is used for physiological and biochemical functions, permitting the organism to perform work.

When an individual is not moving or working and has not recently eaten, all of the energy appears as heat. During this condition, energy production can be directly measured by direct calorimetry. However, this covers only a small portion of the time when total energy measurements are required.

Energy Production

Energy production can also be calculated using indirect calorimetry which measures the oxygen consumed. Since oxygen is not stored (except for about one liter as oxyhemoglobin and myoglobin in the blood and tissues), its consumption keeps pace with immediate needs and is proportionate to the total energy produced. One problem with using only oxygen consumption as a measure of energy production is the fact that the energy released per mol of oxygen is dependent upon the food being oxidized. Although an estimate of 4.82 k cal/mol oxygen is accurate enough for most purposes, the actual values can be determined from an analysis of the respiratory quotient (RQ), which requires that carbon dioxide production (during steady state conditions) be measured simultaneously with oxygen consumption.

The measurement of energy production through the use of indirect calorimetry has been accomplished clinically and in the laboratory using two general methods—closed circuit and open circuit. Excellent discussions of these two types of measurement can be found (Consolazio, et al. 1963; Best and Taylor, 1961; Bard, 1961; Bartels, 1963.) In the closed system the subject rebreathes from a container of 100% oxygen and a carbon dioxide absorber. The oxygen consumption is then determined by the decrease in volume of the system or by the amount of oxygen added to keep the volume constant. If carbon dioxide production is desired, the carbon dioxide absorber must be weighed or analyzed, or be assessed by a system that determines volumes before and after carbon dioxide absorption. Luft (1958) has reviewed spirometric methods which have been used for closed circuit indirect calorimetry.

Calorimetry—measurements of the amounts of heat absorbed or given out

The standard open circuit method of determining metabolic rate is based on minute volumes and gas concentrations. Usually only expired volume (collected in a spirometer - Tissot method; in a bag - Douglas method; or measured with a dry gas meter with a portion of gas being saved for analysis - Kofranyi-Michaelis respirometer) is measured and analyzed for its oxygen, carbon dioxide, and nitrogen content. From these values it is possible to calculate inspired volume and therefore V_{O_2} , V_{CO_2} , and RQ.

If man is to be qualified for long duration missions, it is imperative that energy metabolism data be collected in flight. This is needed because of logistics and life support requirements, as well as the possible physiological degradation of work performance.

Until inflight data can be collected, it is also required that energy metabolism and work performance, as well as pulmonary function, be evaluated pre- and postflight. Should a physiological degradation of ability to do work be evident, an acceptable limit of this degradation will have to be established. These limits will be determined by required activities for the successful completion of a mission, considerations relating to the mechanism behind the degradation, and whether countermeasures are possible.

Life Support

The life support systems both in the spacecraft and the suits for EVA operations must be adequate to accommodate the functional work capacity (both sustained and transient thermal loads) of the typical astronaut. While the work capacity in the spacecraft is not likely to exceed that of an aircraft pilot in the geogravitational environment, this cannot be said of EVA operations, where an emergency may raise the metabolic level to that experienced during heavy exertion on Earth. Fletcher (1964) has compiled data from several sources (Figure 5-1), to show metabolic curves for first class athletes and healthy men engaged in exerting activities (running, rowing, cycling, etc) under normal atmospheric conditions. The design criteria for the life support systems for EVA operations should be such as to permit the levels of activity shown by Fletcher, thus providing for those emergencies which call for these higher metabolic levels.

EVA—extravehicular activity

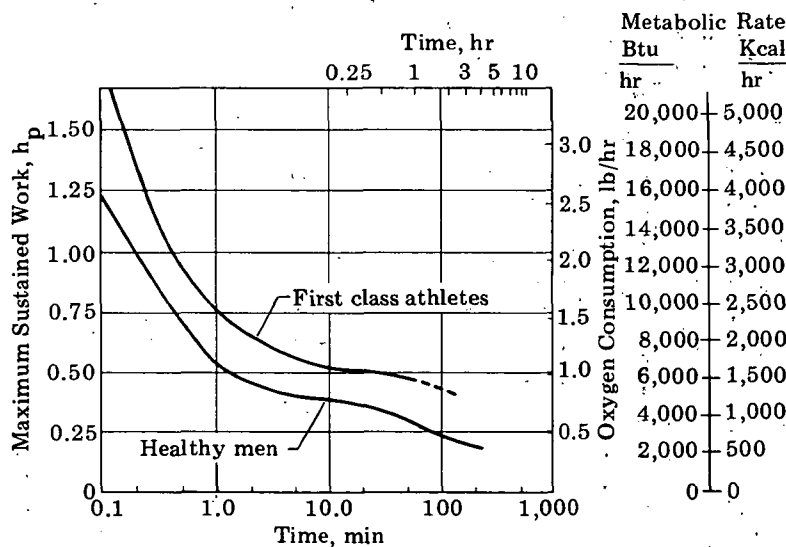

Figure 5-1 - Maximum Sustained Work Capacity

SKYLAB EXPERIMENT M171

EXPERIMENT BACKGROUND

Metabolism has been an area of investigation from the first manned missions. During the Gemini Program in the mid 60s, a number of the medical investigations were concerned with metabolism. Many tests were performed to determine whether the crew would become fatigued doing the types of activities that had been planned, and whether the life support system in the spacecraft and in the space suit would be able to meet the astronauts' requirements. During these early missions, it was learned that there were some significant problems. The astronauts became much more fatigued than had been expected, tasks were much harder to perform, and the possibility arose that under certain conditions the carbon dioxide levels in the space suit rose to higher than desirable levels. Problems with the design of equipment and the work regimens specified for the astronauts were discussed. These concerns and investigations continued into the Apollo Program, and still many questions remain to be answered.

Metabolism—the sum of all the physical and chemical processes by which living organized substance is produced and maintained.

Of particular interest is the relationship between the metabolic requirements of certain physical tasks in space compared to the requirements for the same tasks on Earth. A common means of determining these requirements is to ascertain the oxygen consumption and carbon dioxide production of the body during the performance of the specified task.

These consumption and production rates cannot be measured directly at the cellular level where the demand exists. Measuring intake and output for the body as a whole is considered to represent the aggregate demand for all cellular activity. Consumption and production are usually called oxygen uptake and carbon dioxide output. The former is determined by measuring the amount of oxygen that a person breathes in over a given period of time and subtracting from it the amount of oxygen that he breathes out over the same period of time. The latter is determined similarly: the volume of carbon dioxide breathed in over the period is subtracted from the volume of carbon dioxide breathed out over that same period. For certain types of exercise, the oxygen uptake is equal to oxygen consumption and carbon dioxide output is equal to carbon dioxide production. By properly planning an experiment, the oxygen consumption and carbon dioxide production can be determined from the oxygen uptake and carbon dioxide output measurements (along with other supportive measurements and information).

By doing such determinations while a subject is performing a measured amount of physical work, the relationship between metabolic activity and the physical work can be determined.

Such measurements are commonly done in the laboratory taking the measurements while the subject is performing work on a treadmill or an ergometer, each of which is a means of providing known amounts of physical work for the individual to do.

SCIENTIFIC OBJECTIVES

The objectives of this experiment are to determine if man's metabolic effectiveness in doing mechanical work is progressively altered by exposure to the space environment, and to evaluate the bicycle ergometer as an exerciser for long duration missions.

EQUIPMENT

Measurements Five major pieces of equipment are used for this experiment.

- 1) Metabolic Analyzer determines the oxygen uptake for one minute and five minute periods; carbon dioxide output for one minute and five minute periods; minute volume, the total gas expired by the subject during a one-minute period; respiratory exchange ratio, the ratio of carbon dioxide output to oxygen uptake; and vital capacity, the measurement of the maximum amount of gas that a person expires after a full inspiration.
- 2) Ergometer, a controllable workload pedal device, having a workload selector and tachometer. The pedals connect to the workload which offers mechanical resistance set to a desired level. The ergometer measures work rate, the actual work rate which the astronaut performs on the ergometer; revolutions per minute, the rate at which the astronaut pedals the ergometer; and total work performed during a given period.
- 3) Body Temperature Measuring System electrically measures the temperature in the subject's mouth using an oral thermistor.
- 4) Vectorcardiograph senses three channels of electrical signals from the heart and permits heart rate to be determined.
- 5) Blood Pressure Measuring System comprises a microphone and inflatable arm cuff.

Thermistor—a special type of resistance thermometer that measures extremely small changes in temperature

PERFORMANCE

The metabolic activity experiment will begin 12 months before flight. The experiment will be repeated at one-month intervals from 6 months before launch and also 5 days before flight. Inflight the experiment will be repeated five times by

each crewman during the 28-day flight, and eight times during the 56-day flight. After recovery the exercise capacity test will be performed on each crewman as soon as possible after recovery and again after 24 hours. If there are any significant changes in metabolic performance during the course of the mission, these changes will be followed until baseline levels are reached.

Work profiles for this experiment include (1) the subject remains relaxed and motionless for 5 minutes, (2) he then pedals for five minutes with an energy output fixed at 25% of his preflight determined maximum capacity; (3) the work rate is changed to 50% of his preflight maximum capacity, and the subject operates the ergometer at this rate without interruption for another five minutes; (6) the work rate is changed to 75% of the preflight determined maximum capacity and operated at this rate for five minutes; (7) the subject stops the ergometer, relaxes, and remains motionless for 5 minutes.

DATA

The data return from this experiment will consist of the profiles that occur during a prescribed exercise regime in zero gravity for the following variables: blood pressure, heart rate, vectorcardiogram, and metabolic rate. The metabolic rate is computed from measurements of oxygen consumption and carbon dioxide production. The data derived from this experiment are recorded on the spacecraft tape recorder and transmitted to ground. Manual data recording is available as a backup mode. Voice comments are also recorded. Motion picture data will be obtained using a 16mm camera.

Section 6

Neurophysiology

**Human Vestibular Function,
Skylab Experiment M131**

**Sleep Monitoring,
Skylab Experiment M133**

GENERAL BACKGROUND

The physiology of the nervous system in man is complex, ranging from the sensing and processing of input information via the afferent nervous system, to the higher order neurological functions having a poorly understood neurophysiological basis, e.g., language, learning, and states of consciousness.

Two investigations being conducted on Skylab will evaluate aspects of the central nervous system and the impact of weightlessness. The first, an experiment involving the human vestibular apparatus, will investigate the effects of weightlessness on the crewman's ability to maintain perceptual acuity and orientation in space. This experiment will identify changes in the normal functioning of the vestibular apparatus after long periods of weightlessness.

The second investigation will use the electroencephalogram (EEG) in an attempt to evaluate the sleep patterns derived from the brainwaves in the space environment. This experiment should establish whether there are changes in the sleep quality or quantity associated with extended flights.

Human
Vestibular
Function

SKYLAB EXPERIMENT M131

EXPERIMENT BACKGROUND

Body position and movement is perceived principally by specialized sense organs in the inner ear, collectively termed the vestibular apparatus or the labyrinthine receptors. These organs are the otoliths and the semicircular canals. The otoliths are stimulated by linear accelerations (including gravity) and are the specialized organs for the sensory perception of head tilt relative to the direction of the local force field. The semicircular canals sense the magnitude and direction of angular accelerations. The brain integrates these sensory data inputs to determine and maintain the body's posture and orientation.

The importance of the vestibular organs in day to day activities becomes apparent if one considers their neuroanatomical connections to the--

- 1) reticular system, dealing with alertness and attention,
- 2) eye muscles,
- 3) autonomic nervous system, dealing with regulation of respiration, heart rate, GI tract motility, etc,
- 4) voluntary and anti-gravity body muscles, and
- 5) cerebral cortex.

Cerebral Cortex—the convoluted layer of gray substance that covers each cerebral hemisphere

Experimentally produced discrepancy between visual, vestibular, and tactile-kinesthetic spatial perceptions have been shown to cause a stressful sensory conflict which, depending on the individual, produces symptoms ranging from disorientation to nausea and vomiting.

Reaction of
Astronauts on
Previous
Flights

Varying degrees of discomfort and disorientation have also been noted under conditions of near weightless spaceflight. During the first American orbital flight (MA-6, February 20, 1962) Astronaut Glenn in his pilot report noted that he had experienced an illusion of tumbling forward after cessation of the initial acceleration of his vehicle and entry into the weightless environment. He also noted a false sensation of accelerating in a direction opposite to retrorocket firing before reentry.

Astronaut Cooper, referring to his Mercury Flight (MA-9, May 15, 1963), has been quoted as having felt "... somewhat strange for the first few minutes..." after which he "readily adapted" and felt "completely at ease." Later in the mission, following a short nap, he is quoted as awaking "with no idea where I was and it took me several seconds to orient myself." He also stated that, with respect to sleep, "you have trouble regrouping yourself for a short while when you come out of it." He had an experience, similar to Astronaut Carpenter's on an earlier flight (MA-7, May 24, 1962), when the cockpit seemed to be "somewhat differently located in respect to myself," upon onset of the weightless state. He felt, during the early part of the first orbit, a moving forward in the seat in spite of tightly fastened restraint straps, and the equipment storage kit on his right seemed at a different angle relative to him than when on the launch pad. He felt that he was sitting upright although he later described a feeling of hanging upside down because of pressures against his shoulder straps.

The sensation of hanging upside down from their restraint straps was also noted by Russian Cosmonauts Yegorov and Feoktistov (VOSKHOD 1, October 12, 1964) but were similarly brief and always disappeared upon the onset of reentry acceleration. Cosmonauts Gagarin (VOSTOK 1, April 12, 1961), Titov (VOSTOK 2, August 6, 1961) and Popovich (VOSTOK 4, August 12, 1962) also briefly experienced this inversion illusion during their space flights but the phenomenon was reported to have had no effect on their performance.

A more significant feature of early Russian spaceflight experience was the apparent motion sickness syndrome reported by Titov during VOSTOK 2. After five or six orbits he noted symptoms of decreased appetite, giddiness, and nausea which were aggravated by sharp head movements and reduced by keeping his head still. In spite of the fact that the

vehicle was probably rotating slowly and that repeated head movements combined with anxiety and the initial inversion experiences could theoretically account for the problem, the results were interpreted as from a direct "otolithic-vegetative" disorder. Subsequently, a great deal more investigation and training was devoted to the labyrinthine and proprioceptive systems in the Soviet space effort with somewhat ambiguous results. Symptoms as dramatic as Titov's were not again reported until the flights of Apollo 8 and 9, although temporary motion sickness was apparently experienced in a milder form by both Feoktistov and Yegorov. The eight and fourteen days of Gemini V (August 21, 1965) and Gemini VII (December 4, 1965), respectively, produced no such symptoms in the four U. S. astronauts involved, although they experienced an increased gravity sensitivity during retrofire and reentry. This apparent form of increased vestibular sensitivity disappeared postflight.

Labyrinth—a system of intercommunicating systems or canals, such as the inner ear

Proprioceptive—receiving stimulations within the tissues of the body

Finally, the nausea and vomiting that occurred during the Apollo 8 and 9 flights was almost certainly caused by vestibular system malfunctions. The relationship between these symptoms and the greater freedom of intravehicular movement in the Apollo CM deserves careful attention.

**Vestibular
Areas of In-
vestigation**

Because of the inability to produce conditions of prolonged weightlessness on Earth, at least two major areas of vestibular investigation are necessary for the qualification of man in long duration space flight:

- 1) Ensure that permanent otolithic changes attributable to spaceflight conditions do not occur;
- 2) Ensure that temporary vestibular disturbances will not occur inflight that will interfere with crew safety and mission success.

These areas are also significant to the study of man's adaptation to rotating space vehicles and artificial gravity techniques.

The experimental approach in Skylab uses a healthy, well-trained subject adapted somewhat to the unusual vestibular stimuli he has experienced as an aviator in the flight phase. Control groups have been selected so as to include some known vestibular defectives. In one test, the measurement of angular acceleration threshold, a rotating chair device will be used to provide the subject stimuli of physiological character, at best unusual in a subgravity environment, and a test goggle to measure oculogyral illusion. Oculogyral illusion, the most sensitive indicator of threshold, is a form of apparent motion that has its genesis in the cupula-endolymph mechanism and may be viewed under many different circumstances. The test goggle used provides

the favorable conditions of dimly lighted three-dimensional target viewed in darkness and fixed with respect to the subject. The expected apparent motion of the target is in the direction of acceleration.

Reflex
Vestibular
Disturbances

In another part of the experiment, provocative tests will serve to evaluate the subject's susceptibility to reflex vestibular disturbances and to motion sickness and may, in addition, measure his ability to cope with such disturbances. These tests will measure the coriolis sickness susceptibility index using, again, the rotating chair but with the subject making standardized head motions out of the plane of rotation.

A unique feature of this test is the method of scoring the investigators have developed. This highly effective method yields a single value, the index, enabling the investigator to make comparisons within and among test subjects. The level of severity of acute motion sickness will, therefore, be absolutely controlled to a definite end point defined as Malaise IIA. (See Table 6-1). The test end point will be fixed, while the level of stresses required to reach that end point will be measured (number of sequence of head motions and rotational velocity).

Table 6-1 Diagnostic Categorization of Different Levels of Severity of Acute Motion Sickness

| Category | Pathog- nomic 16 Points | Major 8 Points | Minor 4 Points | Minimal 2 Points | AOS* 1 Point | |
|---------------------------------------|--|-----------------------|-----------------------|---------------------------------|---|--|
| Nausea syndrome | Vomiting or retch- ing | Nausea+ II, III | Nausea I | Epigas- tric dis- comfort | Epigastric awareness | |
| Skin | | Pallor III | Pallor II | Palor I | Flushing/sub- jective warmth ≥ II | |
| Cold sweating | | III | II | I | | |
| Increased salivation | | III | II | I | | |
| Drowsi- ness | | III | II | I | | |
| Pain | | | | | | Headache ≥ II |
| Central nervous system | | | | | | Dizziness, eyes closed ≥ II, eyes open III |
| | Levels of Severity Identified by Total Points Scored | | | | | |
| Frank Sickness | Severe Malaise | Moderate Malaise A | Moderate Malaise B | Sight Malaise | | |
| (S) | (M III) | (M IIA) | (M IIB) | (M I) | | |
| ≥ 16 points | 8-15 points | 5-7 points | 3-4 points | 1-2 points | | |
| *AOS = Additional qualifying symptoms | | | | I = moderate, | | |
| +III = severe or marked, | | | | II = slight, | | |

Epigastric—pertaining to the upper middle region of the abdomen, located within the sternal angle

The spatial localization experiment uses the rotating litter chair in the static tilt and litter modes, together with the otolith test goggles, blindfold, and a reference sphere and magnetic pointer. The astronaut's capability to determine his orientation is tested with the chair upright as well as tilted.

The subject is first tilted to various positions relative to the spacecraft with his eyes closed and is asked to indicate both his perceived direction of gravity and body orientation. He indicates this both by setting the direction of an illuminated line in the test goggles and by lining up a magnetic indicator rod on a handheld sphere.

In the litter mode, the reference sphere and magnetic pointer and blindfold are used. Tests will investigate orientation based upon a sensed g-vector provided by external reference cues and internal reference cues. The chair is converted to a litter and the subject attempts to align the magnetic pointer to an external reference while blindfolded. Settings are made with the litter in a horizontal position and with the litter in a tilted position.

SCIENTIFIC OBJECTIVES

The objectives of this experiment are to acquire data to validate measurements of specific behavioral and physiological responses as influenced by vestibular activity under Earth gravity and in free-fall conditions. These studies are also expected to determine the crewman's adaptability to unusual vestibular conditions, and to predict habitability requirements for future spacecraft which may be rotated to generate an artificial gravity force leading to unusual coriolis forces. Another objective is to measure the accuracy and variability in the crewman's judgment of spatial coordinates based upon abnormal receptor cues and inadequate visual cues.

Coriolis Forces—a fictitious force used to describe motion (aircraft or cloud formation) relative to a noninertial, uniformly rotating frame of reference

EQUIPMENT

The equipment for this experiment consists of--

- 1) rotating litter chair,
- 2) proximity device,
- 3) blindfold,
- 4) otolith test goggle (with a biteboard mounting),
- 5) reference sphere with a magnetic pointer.

The rotating litter chair is a precision motor-driven servocontrolled, rotating chair which can be tilted in two directions or converted to a litter; however, it is only rotated in the upright position.

The right eyepiece of the otolith test goggles contains a self-illuminated target with pitch and roll adjustment. The target is a slit of light that can be rotated to indicate a roll position; a break in the middle indicates the pitch position; and a second small break at one end indicates polarity. The target, the only thing visible to the subject, is illuminated by a radioactive source in the goggles.

The otolith test goggle is fastened to the chair so that when the subject bites on a biteboard and the goggles are properly adjusted, the head will be held in the correct position for the test.

The reference sphere with magnetic pointer is a device for measuring spatial localization using nonvisual clues. A magnetic pointer is held against the reference sphere and moved by the subject. The subject's judgments are measured by a three dimensional readout device that allows free translational movement.

PERFORMANCE

Motion
Sensitivity

Each of two crewmen will participate in dynamic vestibular tests consisting of motion sensitivity tests using the rotation chair in the rotating mode to determine susceptibility to coriolis forces as a function of time in weightlessness, and to measure semicircular canal response thresholds by conducting oculogyral illusion (OGI) threshold tests. This sequence will be done on 5 equally spaced occasions during the first 28-day mission. Each test sequence requires approximately 30 minutes per crewman.

Oculogyral—pertaining to movement of the eye about the anteroposterior axis

Each of three crewmen will participate in spatial localization tests using the otolith test goggles and the rod and sphere device. These tests will be performed once early in the mission, once in the middle of the mission, and once late in the mission.

DATA

During motion sensitivity tests:

- 1) test subject symptomatology in accordance with Figure 6-1 for determination of time course of symptom development to the test end point;
- 2) experiment data pertaining to chair velocity, direction, head motion characteristics, and experimental equipment performance.

During oculogyral illusion tests:

- 1) oculogyral illusion response;

- 2) stimulus characteristics—chair acceleration, velocity and deceleration;
- 3) experimental equipment performance data.

During spatial localization tests:

- 1) accuracy of subjects spatial localization and test conditions (subjects actual orientation relative to the space labs spatial coordinates).

Motion picture films of the experiment performance in all modes will be obtained.

Sleep
Monitoring

SKYLAB EXPERIMENT M133

EXPERIMENT BACKGROUND

One of the most dramatic and fundamental ways in which the behavior of a mammal can change is in its state of consciousness. There is a spectrum of changes from alertness through quiet resting to drowsiness to various kinds of sleep. These changes in states of consciousness affect the activity of the nervous system in many ways. In the last few years our understanding of states of consciousness has increased (and changed) markedly.

One way of examining what is going on in the brain is by means of an EEG (electroencephalograph). The EEG is a recording of the electrical activity from the cerebral cortex. It is clear, that the EEG is not just due to action potentials in cells, although these probably contribute. Synaptic currents play the largest part. There are good correlations between the EEG and states of consciousness.

Synaptic—pertaining to the anatomical relation of one nerve cell to another

During alert, attentive activity the EEG is "low voltage, fast" i.e., waves of less than 100 microwatts recorded from the surface of cortex with frequencies mostly greater than 15 Hz. When the subject is in a relaxed state, conscious but not attentive to anything, the EEG has an alpha rhythm. The alpha rhythm has a frequency of 8 Hz and amplitude of up to 400 microwatts. As the subject becomes more drowsy, the frequency becomes slower. This is mixed with bursts of electrical activity at 10 to 14 Hz lasting a few seconds. In some kinds of sleep, the EEG waves are 2 to 3 Hz and about 400 microwatts. However, in another kind of sleep, the EEG is low voltage, fast, almost exactly as in the alert state. All mammals demonstrate this same pattern although the exact frequency is somewhat different from animal to animal.

The arousal mechanism subserves attentive alert behavior and the associated EEG pattern. There is an anatomical site that

governs this activity, the reticular formation of the mesencephalon (in the upper brain stem) and the adjacent posterior parts of the hypothalamus. This is sometimes called the reticular activating center. Electrical stimulation of this site causes the animal to become alert, a response that will last longer than the duration of the stimulus. Destruction of this center produces coma. Among the normal inputs to this center are those from all the sensory systems. A single cell in this center may be fired by a flash of light, a ringing bell, a touch on the skin, or a smell. It is polysensory. This makes sense in terms of the function of the center, for any kind of sensory stimulation, if sufficiently intense, will cause an animal to become alert.

There are many aspects of arousal. The musculature increases its tone, and the cardiovascular system is affected. With arousal the sensitivity of most aspects of sensory systems is decreased. This may seem paradoxical, but this eliminates irrelevant inputs and presumably allows greater attention toward specific sensory inputs. There is no simple interpretation of the effects of arousal on the activity of the cerebral cortex. Some cells fire more, some less; some are more excitable, some are less excitable.

Musculature—the muscular apparatus of the body, or any part of it

There are two kinds of sleep. One kind, which we will call slow wave sleep, comprises about 75% of sleeping time. The other kind of sleep, which we will call paradoxical sleep, in humans comes in episodes of 10 to 20 minutes duration every 30 to 90 minutes and comprises about 25% of sleep. (Paradoxical sleep is also called rapid eye movement sleep or REM sleep.) Paradoxical sleep can only be reached by going through slow wave sleep.

Paradoxical Sleep

Paradoxical sleep is very stereotyped. It starts abruptly, it involves a loss of tone in muscles, except those of the face and eyes. The facial muscles twitch and there are rapid movements of the eyes. The blood pressure decreases. The EEG is low voltage fast frequency. If a human is awakened, especially during the early stages of deep sleep, he will usually report a dream. If an animal is awakened as soon as an episode of paradoxical sleep begins, another episode of deep sleep cannot start again for at least 30 minutes. If animals are awakened whenever they begin to have an episode of deep sleep, because of this “refractory period,” they can be prevented from spending much time in paradoxical sleep, although their total sleeping time remains normal. All animals, after being deprived of paradoxical sleep, show an increased proportion of paradoxical sleep the next time they sleep.

A center for paradoxical sleep has been found in the pons (part of the brain stem). Stimulation of this site initiates paradoxical sleep; destruction of the site prevents paradoxical

sleep. Norepinephrine, which is presumed to be a synaptic transmitter substance, is concentrated in these areas and appears to be very much involved in paradoxical sleep.

Slow Wave
Sleep

Slow wave sleep (non REM or NREM) can be initiated by stimulation of many parts of the brain. Many other sites initiate slow wave sleep if stimulated at about 8 Hz, even a peripheral nerve. Slow wave sleep, unlike arousal and paradoxical sleep, seems to require that the cerebral cortex be present. However, a major contribution to slow wave sleep comes from the medulla (part of the brain stem). Serotonin, which is presumed to be a synaptic transmitter substance, is concentrated in these areas and appears to be very much involved with slow wave sleep. If a barbiturate general anesthetic is injected into the blood going to the posterior brain's stem (i.e., to the pons and medulla) the animal will wake up. If the anesthetic is allowed to go to the more anterior part of the brain the animal will be anesthetized, which is similar to slow wave sleep in many ways. Slow wave sleep and alert behavior are part of a continuum. There are many intermediate stages. Paradoxical sleep, however, is all or none, with no intermediate stages.

Serotonin—a constituent of
blood platelets

It would appear that there are three active mechanisms involved in states of consciousness. Sleep is not just the absence of consciousness.

The blood flow and oxygen consumption of the brain is the same in arousal and slow wave sleep, but is increased in paradoxical sleep. There have been a few experiments in which recordings have been made from the same nerve cell while the animal was spontaneously awake, and then asleep. Some neurons fire more during sleep, some less. Most neurons fire more during paradoxical sleep. Therefore, the brain does not rest in sleep. In fact, it is most active in paradoxical sleep, and it is resting when it is awake. The common sense view and the scientific view until about 1963 was that the function of sleep was to rest the brain. Today we are not certain as to what the function of sleep is, but we do know that it is essential to physical and psychological well being.

From the beginning of the space program there has been considerable interest in whether the astronaut was getting adequate sleep. In order to answer this question NASA has been investigating the use of the EEG for inflight monitoring of sleep. These investigations include determination of the minimum number of brain areas from which signals that yield useful information are picked up, and whether an onboard computer can be used for performing the analysis, thus reducing the complexity of the telemetry system that is needed to return data to Earth. A preliminary approach to

the problem was undertaken to 1965 and continues to the present time under the direction of the Principal Investigator for this experiment.

SCIENTIFIC OBJECTIVES

Monitoring Sleep of Astronauts

The primary goal will be to monitor the sleep status of a spacecraft crewmember during selected periods throughout an extended space mission, utilizing automatic onboard analysis of electroencephalogram (EEG) and electro-oculograph (EOG) with telemetry of results. Sleep profiles will thus be available in the Mission Control Center and may be readily evaluated in order to detect any alterations in sleep quantity or quality.

EQUIPMENT

The major components of the experiment equipment are:

- 1) cap assembly,
- 2) preamplifier and accelerometer assembly, and
- 3) control panel assembly.

The cap assembly precisely fits the astronaut's head and correctly positions seven electrodes, which are part of it. The electrodes are funnel-shaped, soft "rubbery" devices containing electrolyte soaked sponges. The lower portion of each electrode is cut off by scissors just before the crewman puts on the cap, thus exposing the electrolyte for proper contact with the scalp. A new cap will be supplied for each experiment sleep period.

PERFORMANCE

Three consecutive nights of sleep recording will be required of the prime and backup crewmember within 60 days before launch, plus a one-hour session in the Principal Investigator's laboratory.

A total of 15 selected sleep periods shall be recorded during the first (28-day) mission, and 21 sleep periods during the second mission (56 days).

Three nights of sleep recording are desired on postflight days 1, 3, and 5, using the same procedures and basic equipment.

The procedure for this experiment is quite simple. On the specified nights, before retiring, the astronaut takes a cap assembly, cuts the tips off of the electrodes, connects the cap assembly to the rest of the equipment, dons the cap, and secures himself in the sleep restraint. After checking the operation of the equipment he goes to sleep in a normal

manner. As he sleeps the equipment automatically performs the analyses and provides data to the telemetry system. Upon awaking he disconnects the equipment, throws away the cap, and makes any comments needed in the log and to the voice data system.

DATA

- 1) Copies of all data tapes obtained during preflight and postflight baseline testing will be provided to the Principal Investigator for analysis.
- 2) A log entry is required after each monitored sleep period, preflight, inflight, and postflight. This entry, made by voice recording, will contain information on the duration of sleep, quality of the sleep, and any medication used by the subject with 24 hours before the beginning of the monitored sleep period.

Section 7

Biology

Effects of Zero Gravity on Single Human Cells,
Skylab Experiment S015

Circadian Rhythm-Pocket Mice,
Skylab Experiment S071

Circadian Rhythm-Vinegar Gnats,
Skylab Experiment S072

GENERAL BACKGROUND

Biological Processes

Many biological processes of living organisms are periodic in nature. The most well known of these are the circadian (daily) rhythms of sleep, body temperature, flower petal movements, etc, but there are many other biological oscillatory frequencies as well. These rhythms are believed to be evolutionary in origin and responsive to terrestrial cues such as light/dark cycles. During manned space travel beyond his evolutionary environment, temporal factors will have to be included as part of the provided environment to avoid breakdown of periodicities. Although work/rest schedules may be the governing input, there are basic biological questions related to circadian rhythms that may be of importance.

It is possible to divide circadian rhythm research into four categories: (1) occurrence and general characteristics, (2) environmental phase-setting, (3) the basic mechanism, and (4) the importance of these rhythms to the organism.

Circadian—pertaining to a period of about 24 hours

To summarize briefly: (1) from unicellular organisms to man, there are few biological processes that do not demonstrate periodicity; and (2) circadian processes have a labile temporal relationship with the environment and can be phase-set (entrained) with appropriate light or temperature stimuli.

The latter two aspects, however, have evaded scientific inquiry, although many investigators are attempting to determine the mechanism of circadian rhythms and the physiological consequence of their disruption.

Circadian rhythms, rather than being direct biological responses to the immediate temporal environment, may serve a more basic role in the functioning of living systems. Processes must occur not only at the proper place and in sufficient quantity, but must also occur at the proper time. Thus, the circadian mechanism permits interval synchronization of an organism's processes and at the same time synchronizes the total organism to its environment.

A review of the literature on human circadian rhythms shows over 50 physiological variables with significant circadian variations. Although this variation is only a small percentage of the total change for a function such as vital capacity, it accounts for the majority of the variation in others such as electrolyte excretion. The circadian changes observed are often caused by variations in other processes. Thus, it is not always possible to determine the direct relationship between the observed rhythm and the basic causal mechanism.

Changes in circadian rhythms may occur during certain pathological conditions. In addition, there may be decreased

psychological performance associated with changes (dysrhythmia or desynchronization) in circadian rhythms. This phenomena is becoming a well-known effect of rapid travel across several time zones.

Dysrhythmia—disturbance of rhythm

Circadian Rhythm Theories

There are two theories regarding the basic mechanism of circadian rhythms: (1) they are the result of a completely endogenous mechanism (biochemical or biophysical oscillator) with other environmental factors, such as light or temperature, acting as phase-setters; and (2) they represent an organism's response to subtle geophysical fluctuations (such as magnetic fields) with light and temperature again acting as phase-setters between the basic mechanism and the environment.

The majority of investigators subscribe to the first theory; however, the required critical evidence has not been collected. The Skylab Program offers an environment in which the two hypotheses can be tested, since during orbital flight the geophysical variations are no longer available to the organism on a 24-hour basis, and during interplanetary flight they should be completely absent or greatly distorted.

At present, there is only suggestive evidence of detrimental effects due to disruption of normal rhythms in abnormal temporal environments. To date, it has not been possible to completely abolish circadian rhythms, only to perturb them. If the second hypothesis proves to be true, a completely new factor will have to be considered during long duration flights, i.e., the lack of a basic temporal coordination mechanism.

Effects of Zero Gravity on Single Human Cells

SKYLAB EXPERIMENT S015

EXPERIMENT BACKGROUND

A great deal is known about the behavior of human cells in a 1-g environment; both normal and abnormal behavior is well understood. However, virtually no information exists on the behavior of cells in a near weightless environment.

This experiment to study the influence of weightlessness on living human cells is designed to obtain information on cell development and propagation by using two different and separate methods.

Observation of Cells

The first method will be through observation of two living cells using microscopes and cameras. These cells will be kept alive for the entire mission and returned alive. The cell behavior will be periodically recorded during the mission. This technique, using phase contrast microscopes (specimen does not have to be stained) and time-lapse photographs will allow postflight study of the visible portions of a cell.

Examples of this will be changes in cell size, cell division (mitosis), and changes in size and movement of specific particles in the cell (organelle). Kidney cells will be used because they flatten out in the specimen chamber so that the nucleus and other particles are easily seen under a low power microscope.

**Chemical
Properties
of Cells**

The second method will deal with the chemical properties of cells and will be conducted during periods of rapid growth rate. This portion of the experiment will be completed on the fourth and tenth days of the mission, at which time the cells are fixed and will be held in that condition until they are returned for ground analysis.

The cell chemical study will use 24 separate embryonic lung cell cultures. The cells will be allowed to grow for four days and ten days, respectively, after the start of the mission. On these days various radioactive materials that can be assimilated by the cell will be introduced into some of the specimen chambers at specific times and for specific durations. This will mark or label various functions of the cells at that particular time. After the cells have been labeled, excess radioactive material will be rinsed from the chamber and all of the cells preserved with a fixative that will hold them in that state until they are returned for ground analysis.

The information that will be gained from this portion of the experiment will be (1) the distribution of chemical components in the cell (histochemical), (2) the amounts and rates of synthesis of various chemical constituents, and (3) the ultra structure, or arrangement of the very smallest elements of a cell.

**Histochemical—chemistry of
tissues**

SCIENTIFIC OBJECTIVES

This experiment will determine effects of near weightlessness on living human cells in a tissue culture.

EQUIPMENT

The experiment package consists of two major subsystems both enclosed in a single hermetically sealed package—the microscope-camera subsystem and the biopack subsystem. See Figure 7-1 for a simplified block diagram showing the functions of the experiment.

The biopacks and the microscope-camera subsystems are contained in a hermetically sealed experiment package which also includes two clocks that control the automatic operations. The two biopacks are enclosed in another hermetically sealed container within the experiment package.

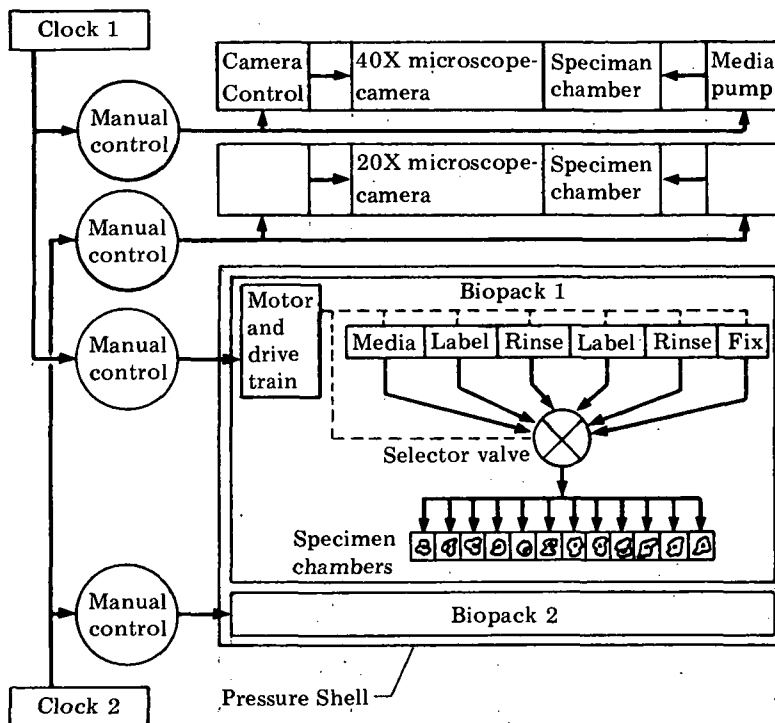

Figure 7-1 Simplified Schematic of Human Cell Experiment

The 20X and 40X power microscopes shown in Figure 7-1 have exposure lamp assemblies that project an image down a light-tight tube to a mirror and film gate assembly. The image is reflected on the film or in a viewport for ground checkout when the mirror is manually rotated 90 degrees. The viewing mechanism is used only for ground checkout and is spring-loaded to prevent the mirror from being inadvertently left in the viewport position after ground checkout. No further adjustments are made in flight.

Each camera assembly operates independently and is controlled by separate internal clocks. Both cameras use 16mm film for recording microscope images of the cells.

The two camera assemblies operate identically. One camera photographs time-lapse motion pictures of images from the 40X magnification microscope. The second camera photographs images from the 20X microscope. A removable film pack is used to contain the 16mm film that is required for each camera. The two films travel in opposite directions, thereby maintaining a constant center of gravity.

Time-Lapse Photography—a slow and continuous process at regular intervals

Two separate specimen chambers, one for each microscope, will provide a temperature-controlled environment in which the cells can live.

Each specimen chamber has an independent media exchange assembly to provide fresh nutrients to the living cells. Twice

each day (not concurrently with the photographing period) fresh nutrients are forced into the specimen chamber and waste removed.

Each of the two specimen chambers contain two thin glass coverslips with a molded rubber gasket held between them. The specimens are attached to the inside of the coverslip nearest the objective lens. Two tubes are attached to the coverslip for supplying nutrients, and removing waste material from the space between the coverslips. Each specimen chamber has a media pump assembly. This pump consists of a cylinder, a piston and a lead screw. Twice daily the lead screw is turned one revolution to advance the piston a short distance into the cylinder. This action forces fresh media into the specimen chamber and waste media to the return side of the pump.

The biopack subsystem consists of two independent assemblies enclosed in a sealed container inside the experiment package. Each assembly controls 12-cell chemistry experiments and each assembly contains 12 cell chambers, a motor drive assembly, a pump for providing fresh nutrients and removing waste from the cells, and provisions for labeling, rinsing, and fixing the cell cultures whenever commanded by a crewmember.

PERFORMANCE

The filming of the living cells is performed automatically. The crewman has to check only for the proper operation of the camera indicator lamp for the first 10 days. In the other part (chemical properties) of the experiment, the crewman will operate the experiment manually at the 4- and 10-day points to perform the radioactive fluid labeling activities.

During the mission, the experiment package must not be subjected to temperatures above 95°F or below 50°F, or to radiation x-ray sources strong enough to damage the film.

DATA

Time-lapse motion pictures of the cell activity, as seen through the 20X and 40X magnification microscope, will be made and the results of the cell chemical analyses will be published in study reports, possibly early in 1975.

SKYLAB EXPERIMENT S071

EXPERIMENT BACKGROUND

If the stability (precision) or the period of physiological rhythms of small mammals change significantly during flight, then there is a strong indication that biorhythms of animals

on Earth are timed by some factor (or environmental force) which is absent or significantly altered in space. This change in the behavior of pocket mice, along with similar evidence from the vinegar gnat circadian rhythm experiment, would imply that weightless spaceflight alters the functioning of basic control mechanisms for metabolic activity. The maintenance of normal biological rhythms in man during spaceflight is important to his well-being and effectiveness in space. Insofar as we can assume a common response in mammalian function, if the pocket mice in space continue their terrestrial biorhythms, then we can conclude that space conditions impose no stress on the basic biological clock mechanism and that man's performance will not be degraded because of rhythm disturbances.

SCIENTIFIC OBJECTIVES

Body Temperature and Activity

The objective of this experiment is to study the circadian rhythms of body temperature and activity in pocket mice (genus, *Perognathus*) in an environment of constant temperature, pressure, and total darkness, and in the absence of geophysical variables within a 24-hour period.

EQUIPMENT

The experiment consists of a sealed animal enclosure coupled to an environmental control system. The animal enclosure contains six isolated mouse cages, the biotelemetry receivers, and monitoring detector circuitry. The environmental control system maintains the mice in a controlled environment of constant temperature, pressure, and darkness.

The cages are cylindrical tanks with porous sealed covers and have an internal height of 1.5 inches and a floor area of 18 square inches. Each cage contains food for the mice. All the cages receive equal ventilation from a common air supply. Figure 7-2 shows a cross section of the cages. The inside of the cage except for the fiberglass tubing is covered with a layer of porous material.

The environmental control system is illustrated in Figure 7-3. The environmental control system tank houses a fan to circulate the air, a charcoal-lithium hydroxide absorption canister to remove carbon dioxide and ammonia, a dew-point control heat exchanger, a moisture separator, and temperature control heater. The accessories mounted on the tank include an oxygen supply tank and regulators, the fluid pump control elements and plumbing for connecting the heat exchanger to an external cold plate. The entire experiment package is surrounded by a multilayered blanket of aluminized Mylar.

A biotelemeter with a self-contained power source is implanted in each mouse to monitor and transmit body

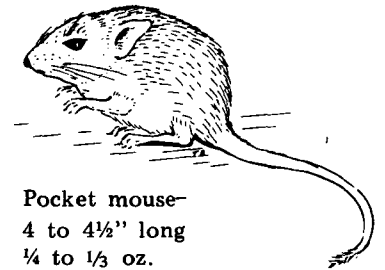

Pocket mouse—
4 to 4½" long
¼ to ⅓ oz.

Biotelemetry—the recording and measuring of certain vital phenomena of living organisms, occurring at a distance from the measuring device

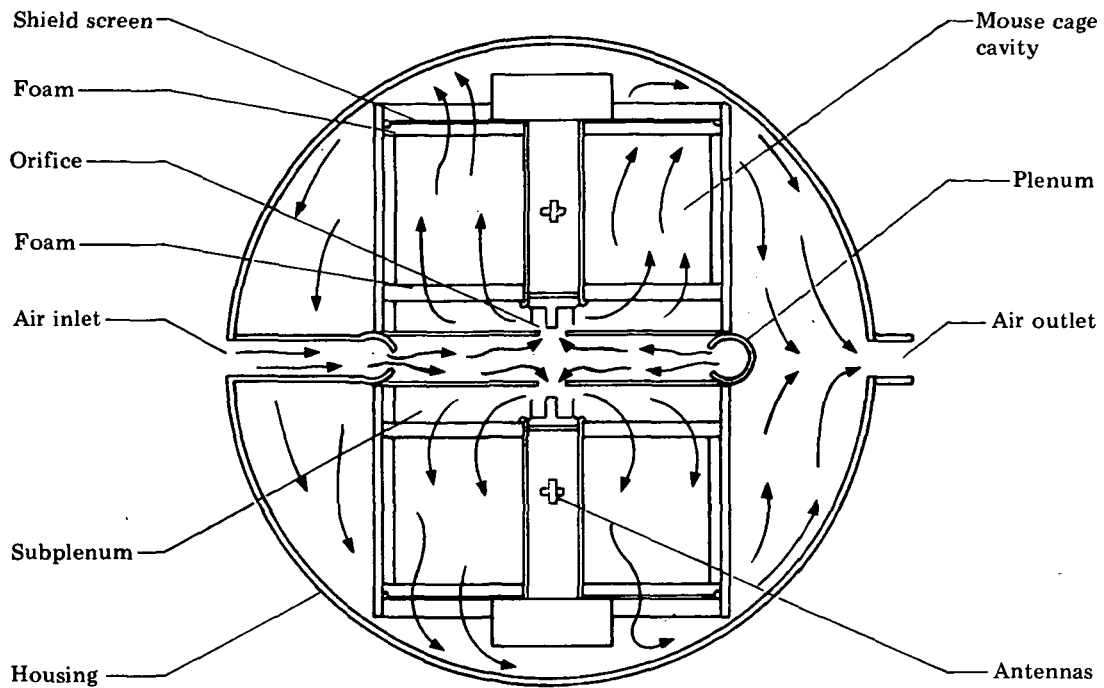

Figure 7-2 Cross Section of Cage

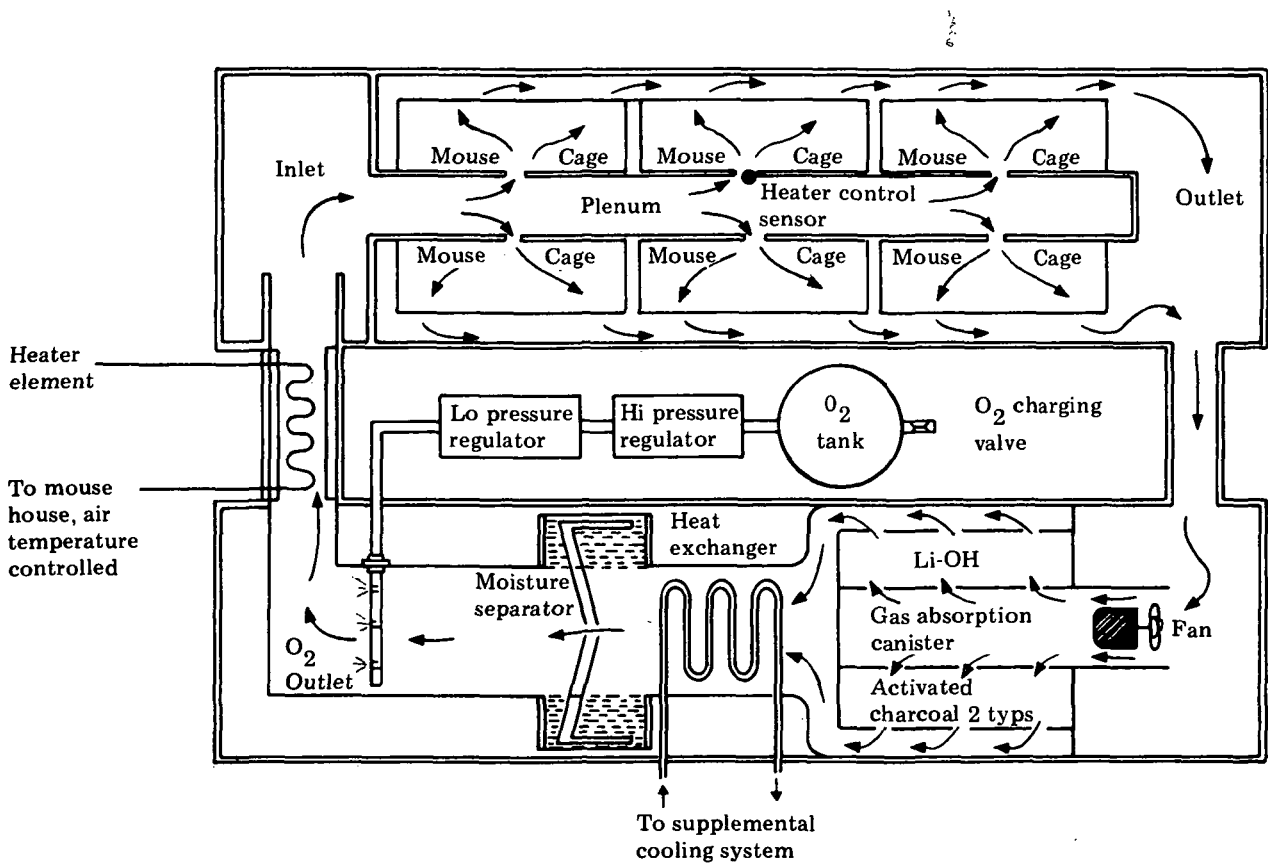

Figure 7-3 Environmental Control System

temperature information. The animal activity is determined from variations in the signal strength as the mouse changes position with respect to a receiving antenna in the center of each cage. The data acquisition and processing is done by the electronics data system.

PERFORMANCE

The experiment is performed during 28 days of the mission. Before launch, 24 pocket mice are placed in a simulated flight hardware environment and maintained in a constant environment for at least three weeks to document the "free running" circadian periods of body temperatures and activity of each mouse. Two groups of six mice are selected from the 24 and placed into the two flight units following the baseline run. One of the flight units is placed into the launch vehicle while the remaining flight unit is used as a ground control. The circadian rhythms of each mouse are continuously monitored from launch for 28 days minimum while continuously maintaining the constant internal environment of the flight hardware.

Additional groups (those remaining from the 24) of pocket mice are maintained in a constant environment at the launch site, and monitored simultaneously with the flight group for body temperature and activity.

DATA

The measurements from this experiment are taken for the duration of the mission. Data will be transmitted to the ground data stations every 8 hours. Analyses of the data from the flight and ground control mice will be reported in a science report published about a year after the mission.

SKYLAB EXPERIMENT S072

EXPERIMENT BACKGROUND

The first formal record of biological rhythms was probably made by the astronomer, De Mairan, who in 1729 described diurnally periodic leaf movements in plants held in the dark. The literature is now replete with evidence of diurnal periodicity in many forms of life at many levels of organization. Present day research emphasizes on one hand, the mechanisms of the so-called "biological clock," and on the other, the coupling of the clock to environmental stimuli. Whether control of the period of the clock is predominantly a physiological or environmental phenomenon is debatable on the basis of existing data. Theoretically, the study of biorhythms in space would permit resolution of the question as to whether terrestrial stimuli indeed set the period or simply determine its phase.

Periodicity—tendency to recur at regular intervals

Circadian
Rhythm
Vinegar
Gnats

The principal evidence for external stimuli setting the period of the circadian rhythm is the (1) remarkable persistence and precision of the rhythm in organisms kept in constant environments apparently free of stimuli that are capable of entraining a self-sustaining oscillation, and (2) the remarkable insensitivity of the free running period to the level of temperature (temperature compensation). If the control of the period were truly endogenous (metabolic), changes in temperature should have produced pronounced changes in period in poikilothermic organisms. On the basis of these observations, Dr. Frank Brown of Northwestern University has postulated a precise 24-hour component in the circadian rhythm resulting from entrainment to some "pervasive geophysical force."

Effect of Zero Gravity on Circadian Rhythm

Most workers, however, believe circadian periodicity to be primarily inherent in the organism. Recent evidence implicates a role of genetic structure in setting the period, loci having been found which can effect an aperiodicity. The Skylab experiment is an effort not so much to provide a definitive answer to the opposing contentions as to shed light on the effect of zero gravity and removal from the Earth's immediate geophysical parameter on a precisely measured biological phenomenon.

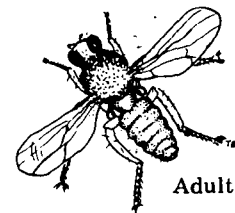

Drosophila eclosion rhythm is the best studied circadian system of any organism. Techniques fully developed at Princeton University permit the selection of a pupal population that would emerge in, e.g., three or four successive peaks of activity separated by a precise circadian period. Methods of assaying the emergence of the adults in the weightless state and providing the environmental control which the experiment requires have been under study at Northrop Corporate Laboratories.

Drosophila—the fruit fly, used extensively in experiment genetics

SCIENTIFIC OBJECTIVES

The objective of this experiment is to study the circadian rhythms of vinegar gnat pupae (genus, drosophila) under conditions of weightlessness and in the absence of geophysical variables within a 24-hour period associated with the Earth's rotation.

EQUIPMENT

The equipment consists of four pupae compartments, the circadian data system and power supply, and the control electronics.

Each cylindrical scaled pupae compartment consists essentially of a control post that supports 180 pupae on a plate, scanning lamps, photosensors, a stimulus light, a

Photosensor—a device sensitive to light

solution of potassium hydroxide, and environmental controls. The pupae plate contains 12 beds equally spaced around its periphery. Each bed contains 16 holes. Pupae are glued over 15 of the holes so that they completely obscure the holes; the 16th is uncovered to monitor the scanning light. One hundred ninety-two photosensors are mounted under the pupae plate, one for each hole. Twelve of these photosensors monitor the scanning lights.

Each of the 12 beds has an overhead red scanning light that transmits through the pupae onto their individual photosensors. The detection system can discriminate between an empty pupae case and developing pupae which exhibit various degrees of transparency during development, but only after eclosion is sufficient light transmitted through the empty pupae case to activate the detection system. The beds are scanned sequentially for 0.5 seconds every 10 minutes.

The sealed compartments are charged with air of specified composition to maintain the pupae throughout the experiment. The initial charging pressure is adjusted so that when the compartments are heated to their experiment level, the pressure will rise to sea level pressure. The carbon dioxide concentration and humidity in the compartments are controlled by a potassium hydroxide solution. The internal temperature is regulated to automatically supply or remove heat.

A white light provides a stimulus with a wavelength between 400 to 700 nanometers to the pupae to determine the phase of the biological clock controlling eclosion.

PERFORMANCE

Experiment Investigation

The experiment is performed during the first 20 days of the mission. All crew operations are to be performed only upon direction from the ground flight controllers.

In the circadian rhythm-vinegar gnat experiment, a population of 720 vinegar gnat pupae divided into 4 groups is placed in Earth orbit in a dormant state. When in orbit, the pupae are warmed to approximately 20°C to allow development. Sometime after the temperatures are stabilized, the pupae are exposed to a single 2-minute pulse of white light. The light pulse sets the phase of the circadian rhythms and establishes the baseline from which the circadian rhythms are determined.

The eclosion of pupae (emerging from puparia) in each of the compartments is continuously monitored until experiment termination.

Puparia—pupal cases formed of the cuticula of preceding larval instars

In addition to the inflight pupae, an equal population of pupae will be housed at the launch site. These pupae will be

stimulated simultaneously with the flight group, exposed to the same controlled environment, and monitored for the same data.

The data acquired from the experiments will be analyzed to determine any variance among the circadian rhythms observed in the flight group while in orbit and the circadian rhythms observed during the baseline run and those observed in the ground control groups. A significant digression of either the precision or length of the free-running circadian periods measured in space from those periods measured on Earth would constitute evidence of dependency of circadian organization upon conditions of spaceflight. Conversely, continuance in space of the precise free-running circadian periods measured on the ground would constitute evidence in favor of the independence of circadian organization of spaceflight conditions, including weightlessness.

DATA

The data from this experiment are recorded from prelaunch until deactivation of the experiment. Data will be transmitted to the ground data stations every 8 hours. Results of the analysis of this data will be published in a science report possibly early in 1975.

Section 8

Classroom Activities

In preceding sections a fundamental tie has been established between the Skylab experimental program and the science that guides and disciplines man's quest for knowledge about himself. In this section, a few classroom activities, discussion topics and student experiments which the teacher may employ to demonstrate the principles and techniques of scientific inquiry are suggested. These simple qualitative classroom activities can be coupled with more precise and quantitative data and aids from Skylab to enhance the educational process. The suggested demonstrations that represent only a very small sample of those which might be performed, have been included only to show the scope of relevant experimental techniques.

CLASSROOM ACTIVITIES

Body Mass

The evolution of the mammalian skeleton has been significantly influenced by factors such as gravity, which is the primary discussion topic of this section.

The weight of an animal is proportional to the gravitational attraction and the mass of the body. The relative mass of a body is directly proportional to its volume. A very large sphere has much less surface in proportion to its volume than a very small sphere. If the radius of a sphere is increased, its surface increases by the square ($A = 4\pi r^2$), but its volume increases by the cube ($V = 4/3\pi r^3$).

The following discussion is adapted from DuBrul*

The operation of the principle that volume of a sphere increases by the cube may be applied in different ways in the animal world. Suppose we pretend that the body of an animal is like a sphere and that four legs support this sphere. The four legs are subjected to pressure from the weight of the body. What is the relationship of the thickness of an animal's legs to volume of its body? A horse has long thin legs. A moose is larger than a horse, but its legs seem to be only a little thicker. An elephant is still larger, but its legs are enormously thicker. Now we are near the upper limit of size for living land animals. Not only is the proportion of legs to body of these three animals different, but the locomotion is also different. The horse has a rapid gallop; the moose a slower pace; the elephant a steady plod.

The African elephant can weigh as much as 6½ tons. With its bone structure this elephant is near the limit of its size, while still retaining its mobility. However, a whale, the largest of all mammals may weigh forty times as much as an elephant. The

*DuBrul, E. Lloyd: *Biomechanics of the Body*, BSCS Pamphlet #5, January, 1963, American Institute of Biological Sciences, pp 2, 3

whale's bones are not proportionately thickened, but they are strong enough because the whale is supported by water. Many of the dinosaurs approached whale-like size. How were they adapted for survival?

A discussion of one of the problems that would arise with the increase in size of an organism follows.

If an organism were to double in size, could it retain the same structural makeup under Earth gravity conditions? By doubling its size, an organism would increase eight times in volume (weight) with only an increase of four times in strength of the skeleton. (The strength of a bone is proportional to the diameter squared. This scaling restraint is discussed more fully in *Physics*, D.C. Heath & Company, 1960 edition, p 45 ff, or in the 1965 edition on page 48 ff. Reading these pages could lead to an interesting discussion on evaluation of organisms under varying gravitational conditions.

Other interesting problems that could be posed for discussion purposes are:

- Are animals possessing no skeletons (invertebrates) subjected to the same limitations as vertebrates?
- How much increase in size or mass would be possible before additional skeletal strength would be necessary if an organism were transferred to gravity conditions on the Moon (gravity 1/6 Earth's)?
- The leg bones of one animal are twice as strong as those of another closely related animal of similar shape. What would you expect to be the ratios of the animals' heights and weights?

The Concept of Cause

Because of the problems associated with conducting experiments involving the use of hormones, the following Invitations to Inquiry are submitted for discussion topics. The source of these Invitations is the *Biology Teacher's Handbook* (John Wiley, 1970), prepared in cooperation with the Biological Sciences Curriculum Study. "The teacher presents the background of the invitations orally and when necessary at the blackboard.* He then poses the problem of the invitation and invites student reaction. Thereafter he deals with student responses as they arise, asking diagnostic questions which help students see what is wrong with poor answers, reviewing the logic that justifies good responses.

Physics, D.C. Heath & Company, 1965 p 48

*BSCS has developed inquiry slides which relate to these topics and are related to these invitations.

Sound responses to early problems of an invitation then lead naturally to the next problem in the invitation and the procedure of diagnostic and analytical questioning continues.”

INVITATION #17

Subject: Thyroid Action (p 108)

Topic: Unit Causes

‘One of the easiest of complications to understand is the fact that we can always try to break big causes into little ones. A whole gland, such as the adrenal, for example, can be treated as a cause. We remove it and note the consequences of removal. Then we interpret these consequences as indications of the normal effects of the adrenal gland. There is nothing erroneous about such an experiment and interpretation, but it is certainly incomplete, for we can go on to divide the gland into parts, such as medulla and cortex, and redo our experiment using one such part at a time. Later, we may analyze still further. Perhaps we would proceed by distinguishing different kinds of cells in the cortex and trying to remove one kind of cell at a time—and so on down to molecules.

‘Back of this progressive analysis of causes into finer and finer parts is the idea that somewhere we will arrive at irreducible unit causes, or causal *elements*. However, the possibility of such elemental causes does not mean that grosser, composite causes, such as whole organs or tissue components of organs, are “wrong” or useless. On the contrary, they may be very useful, not only in applied biology, as in medicine, but also in research.

‘Hence, what we want to convey to students is not that one level of analysis is better or more “scientific” than another, but only that there are many levels.’ (p 108)

Invitation #17 uses this procedure to investigate the action of the thyroid gland.

INVITATION #21

Subject: Parathyroid Action (p 116)

Topic: Multiple Causation

This Invitation illustrates that a given effect may be evoked by what appears to be several different causes.

‘This is sometimes referred to as *multiple causation*, but the term is something of a misnomer. It suggests that several

genuinely different things or events can cause precisely the same effect. This *could* be the case in nature. However, the concept of causation underlying much biological research into causes includes the idea that, ultimately, if several instances of an effect are identical, the cause will also be found to be the same.

'It follows from this concept that when we think we have a case of *different* causes leading to the same effect, we proceed to make finer analyses (either spatial or sequential) in order to find what is common to the apparently different causes.

'Thus, multiple causation is a complication of enquiry at two levels. First, it involves the simple possibility that an event may have "several causes." Second, it involves the more abstruse notion that several causes may really be one—though, of course, the common factor, the "true" cause may be located in several places or react in several different circumstances, or be involved in several different sequences.

'In this Invitation we deal with "multiple causation" in its simplest form: the idea of the same causal source lying in several different locations. We do not introduce the complication of an underlying common cause acting in different circumstances or through different sequences.' (p 117)

INVITATION #24

Subject: Control of Thyroid Secretion (p 128)

Topic: Inhibiting Causes

Invitations 17 and 21 have treated causal factors as being positive, leading to the appearance or the increase of something. This Invitation illustrates the fact that a causal factor may be negative and lead to the inhibition of something.

INVITATION #25

Subject: Pituitary—Gonad Mechanisms

Topic: Feedback Mechanisms

'This Invitation has two major points. First, it exemplifies the fact that experimental tests of hypotheses *cannot*, as a rule, verify them. As a rule we can demonstrate only that the hypothesis is not possible or that it *might* be the case. Only when *all* the possible alternative hypotheses are known can experimental test, by eliminating all but one alternative, verify that one. This situation is sometimes referred to as

“the falsifiability, but not the verifiability of hypotheses.”
The point is that we are rarely in a position to say with certainty that we know all the possible alternatives.

‘The second function of the Invitation is to add a last item to our understanding of cause-effect enquiry: the existence of complex *‘interactions of causes.*

‘The Invitation is based on a real case—the sexual cycle in the mammalian female. However, it refers to organs and materials only by code letters, A, B, C, and so on. This is done for two reasons. First, it makes it possible to use the Invitation at any time, since background information is not required. Second, it permits us to put our emphasis on the general pattern of interaction, rather than on the specific case.’ (p 130)

The previous Invitations are examples of how students can investigate the:

- function of various glands,
- relationship among gland organs and the hormones produced,
- feedback mechanism as a regulator of hormone secretion.

They stress the role of critical observation and involve students in designing experiments, interpreting data, formulating hypotheses, identifying problems, and performing other tasks related to the investigative nature of science.

Caloric
Content
of Food

Students may determine the relative caloric content of food by using a standard calorimeter or the homemade one shown in the sketch.

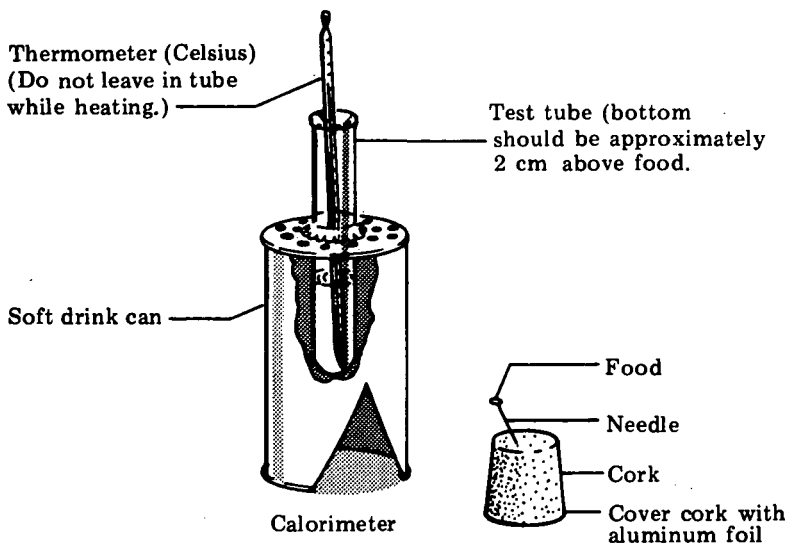

Diagram from BSCS *Patterns and Processes* 1966 p. 78

When using a homemade calorimeter, satisfactory results can be obtained by following these procedures:

- 1) Measure 2/10 gram of food to be tested and place on the needle;
- 2) Place 10 ml of water in the test tube and record the temperature of the the water;
- 3) After the initial reading, remove the thermometer from the test tube;
- 4) Ignite the food and place calorimeter over burning food with flame directly under the test tube. Burn food to an ash. If flame goes out, repeat steps 1, 2, 3, and 4.
- 5) Immediately measure the resulting increase of water temperature;

Note: If water should boil, the amount of water should be increased in multiples of ten; or decrease the amount of food. If the water boils, most of the heat energy is being used as heat of vaporization of the water (540 calories per gram);

- 6) The caloric content of the food is calculated as follows:
 $\text{change in temperature (Celsius)} \times \text{number of ml of water} = \text{calories present in the amount of food burned.}$

Note: This procedure provides a caloric content in small calories (c). (c is the heat necessary to raise the temperature of 1 ml of water 1°C.) There is a larger unit, the kilocalorie or calorie with a capital C, which is 1000 times as big as the small c calories and is the unit commonly used today in specifying caloric content of food.

Foods that provide particularly good results include nuts, cereals, sugar, and dried bread.

Students working in pairs can gather data on heart rate and breathing rate using amount of activity as a variable. One student can record the pulse rate and breathing rate of another student lying at rest, standing, after mild activity, and after more strenuous activity. The data gathered can be tabulated in the following form.

| | Heart Rate | Breathing Rate |
|--------------------|------------|----------------|
| Lying down | | |
| Standing at rest | | |
| Mild activity | | |
| Strenuous activity | | |

Class results can be graphed on each activity to illustrate individual differences within the class. Average results for all activities can be graphed to illustrate the effects of the amount of activity on these two body functions.

The heart of a double pithed frog can be attached to a kymograph for observation of amplitude and rate of heart beat. (For pithing instructions, see Follansbee Harper *Animal Behavior*, BSCS Laboratory Block, D. C. Heath & Company, p 27)

Kymograph—an instrument for recording variations or undulations, arterial or other

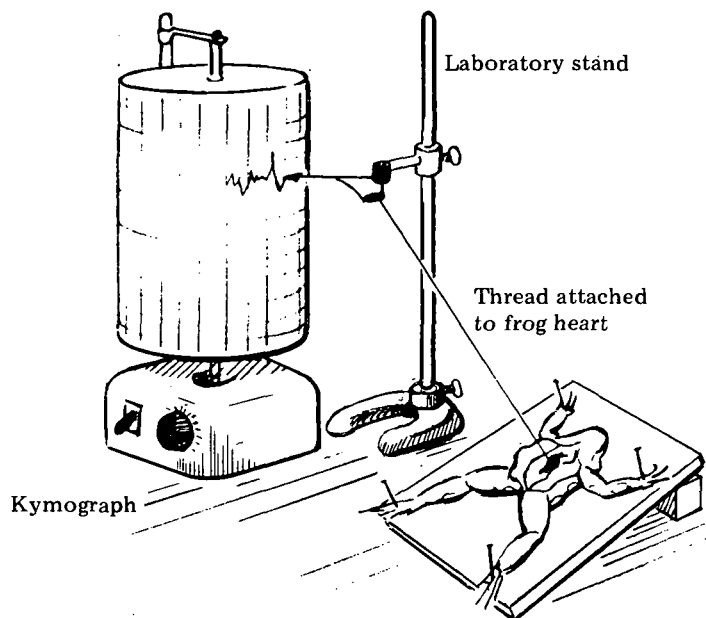

The heart can be cooled using iced Ringer's solution (a solution of salts comparable in composition to the frog's body fluid) to slow it down and a chemical, such as adrenalin (1 in 10,000), to speed up heart action.

Physical stimulation, i.e., poking with a pin or small electrical stimulation, will also alter the rate.

Lung Capacity

To study the relative lung capacities, the setup shown in the sketch can be used. Have students, using a normal breath, blow into the rubber tubing and measure the amount of water displaced.

After refilling the jar a second student may repeat the experiment. For comparative purposes students may wish to repeat the experiment after filling lungs to capacity and exhaling all the air in the lungs to displace the water.

For more accurate volume measurements, mark the water level with a grease pencil, remove the jar, empty it completely, and with jar in upright position measure the amount of water necessary to fill the jar to the pencil mark.

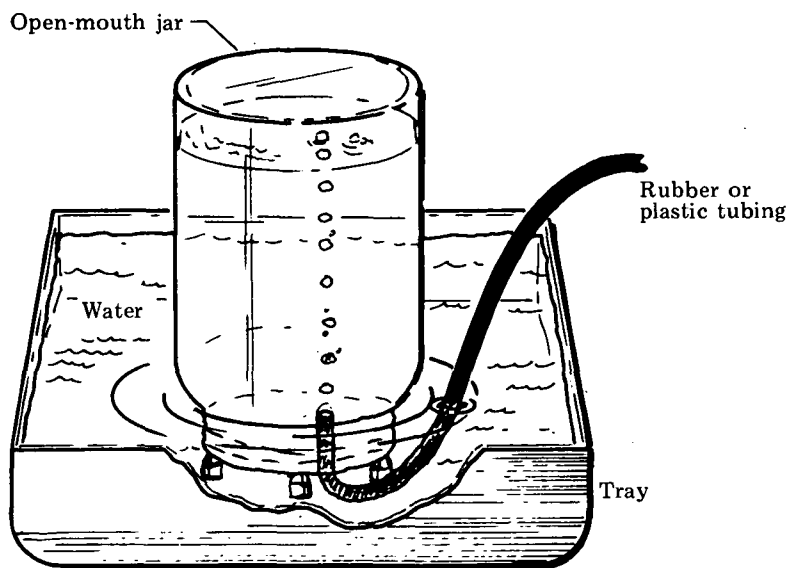

Carbon
Dioxide
Related to
Physical
Activity

This experiment demonstrates the amount of CO_2 produced under different levels of physical activity.

Measure 100 ml of water and test for CO_2 by adding 5 drops of a 1% solution of phenolphthalein. If a pink color appears in the water and remains for at least fifteen seconds, it can be assumed there is no acid in the water. If the water remains clear, there is acid present and it must be neutralized before the amount of CO_2 added can be determined. To neutralize the water add dilute sodium hydroxide (NaOH) solution drop by drop until the water turns slightly pink. Be sure to count and record the number of drops required. Save the sample of water and use it as a control reference.

- 1) Have a student lie on his back inhaling through the nose and exhaling through a tube which is inserted in a flask with 100 ml of water containing 5 drops of phenolphthalein for one minute.
- 2) Add sodium hydroxide (NaOH) drop by drop as before until the pink color appears as in the control solution. The difference in the number of drops of NaOH required to color the control solution and experimental solution is an indication of the amount of CO_2 added.
- 3) For comparison purposes, the experiment can be repeated after exercising vigorously for one minute, e.g., deep hand bends, running in place, etc.
- 4) Additional activity: have the student undergo some physical activity such as running up a flight of stairs. (The work required to run up the stairs can be calculated if so desired.) Then have the student breathe into the

phenolphthalein solution for the same length of time as before. Note the number of drops of NaOH added to indicate a change.

If phenolphthalein is not available, the same relative measures may be obtained by blowing into limewater and comparing the amount of precipitate formed when CO_2 reacts with the calcium hydroxide to form calcium carbonate.

Visual
Illusions

Students may want to investigate some of the visual illusions that are discussed in most high school psychology textbooks.

Other sense investigations can also be used, i.e., have students make a 1-inch grid of washable ink on the palm of the hand, back of the hand, and on the forearm. The grid should be made up of 1/8-inch squares. By using 3 inch nails, some of which have been placed in ice water and some in hot water, the students can attempt to map the heat and cold receptors in the grids. Note: one student should place the nails for another student who is blindfolded. Students must take care not to push too hard on the nails or the pain or pressure receptors will be stimulated, confusing the experimental outcome.

By comparing the location and number of receptors in the three grids, students can get an indication of the more sensitive areas to heat and cold.

Vestibular
Apparatus

The student may perform experiments that provide a measure of the role and function of the vestibular apparatus in maintaining balance and posture. In order to stress this body system, the student can be seated in a swivel chair and spun "X" number of times. The effect of this stress can be qualitatively observed by assignment of selected tasks such as walking a straight line, picking up small objects, tossing coins into a small bucket, etc.

Photoperiod
Effects

English sparrows may be captured during the winter months when the photoperiod is approximately nine hours. The birds must be sacrificed in order that the gonads may be examined. (A painless way to kill the birds is to dip their beaks into the fumes of carbon tetrachloride. Hold the birds beak into the opening of a bottle of CCL_4 . Students should avoid breathing the fumes.)

Measure the weight and size of the gonads of a male and female. This serves as a control.

The remaining birds are to be placed in covered cages with a light and timing device to increase the photoperiod to 13 or 14 hours. Birds should be exposed to the lengthened photoperiod for three weeks. One pair should be kept under the 9-hour photoperiod to serve as additional control.

At the end of the three-week period, the size of the gonads of the control and experimental birds may be examined.

Circadian
Rhythms

Circadian periods such as photoperiodicity can be investigated in the laboratory or classroom. Mice can be placed in a cage with an activity wheel. A 24-hour recording device attached to the wheel can be used to record the number of revolutions and time of day. By using timers to control artificial lighting, the photoperiod can be set to cover a wide range of light-dark cycles. Analysis of activity patterns, light-dark cycles, food consumption, and body weight will reveal the influence of photoperiod.

Section 9

Glossary of Terms

GLOSSARY OF TERMS

| | |
|-----------------------|--|
| Aberration | Any deviation from the normal number. |
| Blastoid | Pertaining to embryonic cell forms |
| Biorhythm | A biologically inherent cyclic variation or recurrence of an event or state, such as the sleep cycle, circadian rhythms. |
| Cation | An ion carrying a charge of positive electricity; therefore going to the negatively charged cathode. |
| Chromosomal | Pertaining to the body in the cell nucleus that is the bearer of genes. |
| Circadian | Relating to biologic variations or rhythms with a cycle of about 24 hours. |
| Colchicine | An alkaloid obtained from colchicum. |
| Cytogenetics | Study of heredity—cytology and genetics. |
| Diastolic | Relating to the dilation of the heart cavities, during which they fill with blood. |
| Diuresis | Increased discharge of urine. |
| Diurnal | Pertaining to day or daylight. |
| Endocrine | The internal secretion of a gland. |
| Endogenous | Originating or produced within the organism or one of its parts. |
| Epinephrine | The chief hormone of the normal adrenal medulla, adrenaline. |
| Erythropoiesis | The formation of red blood cells. |
| Exogenous | Originating or produced outside. |
| Friability | Easily crumbled or reduced to powder. |
| Globulin | A simple protein found in blood, milk, muscle and seeds. |
| Hematopoietic | Blood forming. |
| Hemolysis | The alteration or destruction of red blood cells in such a manner that hemoglobin is liberated into the medium in which the cells are suspended. |
| Hemostatic | Arresting the flow of blood within the vessels. |
| Histochemical | Chemistry of the tissues. |
| Homeostatic | The state of equilibrium in the living body with respect to various functions and to the chemical composition of fluids and tissues. |

| | |
|---------------------|---|
| Homeothermic | Denoting the warm blooded animals. |
| Humoral | Relating to the extracellular fluids of the body. |
| Hyperbaric | Pertaining to pressure of ambient gases greater than 1 atmosphere. |
| Hypobaric | Characterized by low atmospheric pressure. |
| Hypodynamia | Diminished power. |
| Hypotension | Subnormal arterial blood pressure. |
| Leukocyte | Any one of the white blood cells. |
| Lysis | Destruction, as of cells by a specific substance (lysin). |
| Mesenchymal | A pluripotential cell form found between the ectoderm and entoderm of young embryos. These cells give rise to any of the connective or supporting tissue. |
| Microflora | Microscopic forms of bacterial life. |
| Mitosis | The usual process of cell reproduction consisting of a sequence of modifications of the nucleus that result in the formation of two daughter cells with exactly the same chromosome and deoxyribonucleic acid (DNA) content as that of the original cell. |
| Morphologic | Relating to the science which treats of the configuration or the structure of animals and plants. |
| Myocardium | Heart muscle. |
| Neutrophil | A mature white blood cell in the granulocytic series. |
| Oculogyria | The limits of rotation of the eyeballs. |
| Orthostatic | Relating to or caused by the erect posture. |
| Organelle | One of the specialized part of a protozoan or tissue cell serving for the performance of some individual function. |
| Osteoblastic | Relating to a bone forming cell. |
| Osteoclastic | Relating to the activity in the absorption and removal of osseous (bony) tissue. |
| Otolith | Part of the vestibular apparatus (ear stone). |
| Parenchymal | The distinguishing tissue of a gland. |
| Pathologic | Diseased. |
| Phagocytosis | Engulfing of microorganisms, other cells, and foreign particles by phagocytes. |

| | |
|-----------------------|---|
| Poikilothermic | Denoting the so-called cold blooded animals and the plants. |
| Reticulocyte | A young red blood cell. |
| Spatial | Relating to space, or a space. |
| Steroid | Hormone of the adrenal cortex. |
| Stressor | Any force which stresses the body, organ, or system. |
| Systolic | Relating to the rhythmical contraction of the heart. |
| Venous | Relating to a vein or to the veins. |

* U. S. GOVERNMENT PRINTING OFFICE : 1973 729-816/948