

FATIGUE DESIGN PROCEDURE FOR THE AMERICAN SST PROTOTYPE

By Ralph J. Doty
The Boeing Company, Seattle, Washington, U.S.A.

SUMMARY

For supersonic airline operations, significantly higher environmental temperature is the primary new factor affecting structural service life. Methods for incorporating the influence of temperature in detailed fatigue analyses are shown along with current test indications. Thermal effects investigated include real-time compared with short-time testing, long-time temperature exposure, and stress-temperature cycle phasing.

A method which allows designers and stress analyzers to check fatigue resistance of structural design details is the primary theme of this paper. A more communicative rating system is presented which defines the relative fatigue quality of the detail so that the analyst can define cyclic-load capability of the design detail by entering constant-life charts for varying detail quality. If necessary then, this system allows him to determine ways to improve the fatigue quality for better life or to determine the operating stresses which will provide the required service life.

A supersonic vehicle structure, which is subject to major airload center-of-pressure shifts as well as to the addition of thermal-gradient stresses to mechanical stresses, experiences a relatively large percentage of damage from ground-air-ground (GAG) cycles. In studying the 1g thermal-gradient history of a design detail, the analyst will produce a 1g stress history. Application of simple factors to this history allows determination of dynamically instantaneous maximum and minimum stresses statistically realized once per flight which represent the GAG cycle. The relationship of GAG damage to total damage on various parts of the vehicle is used to facilitate a quick fatigue-resistance check.

A quick fatigue-check method for designers and stress analysts benefits the design by making designers and stress analysts more cognizant of fatigue problems throughout the detail design phase of an aircraft development.

THE PROTOTYPE TASK

At the 1967 ICAF meeting in Melbourne, Australia, the philosophy and scope of an integrated program of analysis, development testing, and verification testing for the American supersonic transport (SST) were presented. Since that time the program has developed to the point where the prototype configuration is being designed and fabricated. Figure 1 shows the SST in take-off and cruise configuration and figure 2 gives an idea of

the structural configuration. Attention to fatigue and fail-safe requirements in the detail design of the prototype will assure a structure representative of the 50 000 flight hour and 20-year service life design goal for a production SST.

If a total SST program schedule is reviewed, the significant location of the prototype job becomes apparent. Figure 3 presents the essential schedule elements. A 30- to 40-year time span is needed to include a 20-year operating period. The prototype design release, which is labeled NOW on figure, comes fairly early in the program after a company study period, a research and competition period, and a prototype design development period. Careful planning and implementation of investigation programs with extensive testing will provide the required structural confidence for the production design. For the prototype, fatigue resistance representative of production design must be engineered into the structure with a strictly fundamental analysis without a great depth of titanium structural component tests. This paper presents the basic tools used along with discussion of the significant factors affecting fatigue and how they are accounted for in the prototype design.

Good fatigue design is most effectively accomplished when both designers and design analysts understand and implement fatigue requirements in the drawing release process. Design analysts on the SST prototype are required to check their designs for production requirements specifying 50 000 flight hours of normal usage. The projected composite airplane usage includes 49 250 hours of revenue service used in 22 000 flights and 750 hours of training containing 1500 full-stop landings and 2600 touch-and-go landings. Application of these service life requirements in addition to other loads criteria truly makes the prototype design an exercise in production design.

The fatigue analysis procedure, made available to the design analyst in handbook form, allows him to determine the service life capability quickly. A rating system which gives the relative fatigue quality of a design detail so that the analyst can determine cyclic-load capability by entering constant-life charts for varying detail quality is presented. Consequently, he can determine whether to improve quality for known life improvement or to establish operating stress levels which will provide satisfactory service life. With a minimum of experience with different details, an engineering understanding of relative fatigue values is developed.

THE SUPERSONIC TRANSPORT FATIGUE PROBLEM

In the transition from subsonic to supersonic transport operations, the major new parameter influencing structural fatigue resistance is elevated-temperature exposure. There are many other more subtle influences in this operational transition, but the thermal environment necessitates development of new tools for fatigue-performance evaluations.

Figure 4 shows schematically a comparison of equidistant subsonic and supersonic transport operations. The supersonic mission is clearly a high-speed high-altitude type of operation with a lower percent of time spent in cruise operation. High-altitude operation puts the SST in a less damaging gust environment during cruise. Also, because the SST must be designed for efficient high-speed supersonic cruise, the effects of relatively large center-of-pressure shifts between the subsonic and supersonic operation are apparent on this type of vehicle. When the relative parts of the damage resulting from gust, maneuver, taxi, take-off, landing, and ground-air-ground (GAG) operation are considered, it is apparent that a large part of fatigue damage will be due to the GAG cycle on critical parts of the primary wing and body structure. This conclusion is used to advantage in developing a simple fatigue-check procedure.

The subsonic operation produces no significant thermal environment but supersonic operation at Mach 2.7 subjects the airplane to a stagnation temperature of 500° F. Figure 5 shows the stabilized temperatures existing during cruise. Realizing that the mission requires climb and acceleration into and finally descent and deceleration from such a condition, the design analyst knows that fatigue analysis must account for many thermal effects. For convenience in the development of analytical procedures, the total thermal effect will be evaluated as thermal-gradient loading, long-time temperature exposure, and an interrelated cyclic exposure of stress and temperature.

After analysis of projected operational SST route structures, a mean mission was selected to establish representative fatigue damage for the SST prototype structural design. Figure 6 shows the details of this mission. The consequences of this operation on a structural detail are illustrated in figures 7 to 9. Figure 7 shows a typical 1g stress and external temperature history at a wing lower surface location. Figure 8 shows the thermal-gradient stress and temperature history as it will develop on two types of typical wing surface structures. Figure 9 shows a combined total stress and temperature history for the structural detail being analyzed. The design analyst studying the load and temperature effects on any structural detail will prepare these histories to understand his problem. These histories provide him with the initial tool leading into the fatigue-check procedure.

The first step in the analysis procedure is to define the stress level of a primary GAG cycle from the data obtained in producing figure 9. It is not the intent of this report to discuss in detail the criteria loadings for gust, maneuver, taxi, take-off, and landing. However, with a clear definition of a GAG cycle, a statistical factor can be determined to apply to the maximum and minimum stresses of figure 9 to establish dynamically instantaneous maximum and minimum stresses that are realized 1000 times in 1000 flights. These factors, indicated in figure 9, are used by the design analyst to establish the stress limits of a primary GAG cycle.

From the general aspect of fatigue analysis the analyst now has viewed the effects of the thermal cycle associated with supersonic flight and has established the GAG stresses for his design detail. It is now important to again realize that temperature is the primary new factor affecting fatigue and that the balance of the factors affecting fatigue are handled in the same manner as those on subsonic transports. Consideration of the primary factors affecting service life will point out how they are evaluated and how the effect of the thermal cycle is included in the analysis.

FACTORS AFFECTING SERVICE LIFE

Based on broad scope categories, the primary factors influencing service life of an operational vehicle are

- (1) Selection of structural material
- (2) Type of design and fabrication
- (3) Service reliability
- (4) Operational environment

Each of these categories is handled in a particular manner to facilitate the application of a fatigue-check procedure at the point of drawing release.

All factors associated with the SST mission, service life, and vehicle production are considered in selecting the structural material. Annealed Ti-6Al-4V was selected as the primary structural material because good fracture and fatigue properties are combined with a good strength-weight ratio, particularly in the SST operating environment. High-strength steels, as applicable, augment the primary structural material. For analysis purposes, after the selection decision, the material is represented by S-N curves for varying quality of structure. In addition, when considering service reliability, the level of backup test and service knowledge for the material and type of detail application influence the selection of reliability factors.

Type of design and fabrication with its many facets is controlled in this procedure by establishing a detail fatigue rating (DFR) number. Effectively, the DFR of a design will direct the analyst to the correct quality of S-N data for determining the service life. Surface finish, fabrication techniques, geometric design details, fastener installations, and design assembly patterns are typical influencing factors determined by the type of design and fabrication. Based on test data and service experience, DFR values are determined with formulas or established in charts.

Service reliability must account for the variability of fleet statistics, loading environment, test representation, and structural material properties. In a well defined loading environment on a fail-safe design detail with good test and service background,

the analyst can consider going as low as 2.0 for a fatigue reliability factor (FRF) to be applied to specified life for analytical life requirements. As background data becomes minimum in the design of a good fail-safe structure, FRF values of 4 to 6 are required. In cases where fail-safe design is difficult or impossible, safe-life design must be developed with FRF values twice those that would be required for fail-safe design. For the analysis procedure, FRF values are specified in general terms and the design analyst consults with fatigue specialists if further refinement is necessary.

The operational environment is usually well defined at the current state of development of specifications and investigation studies. Gust, maneuver, taxi, take-off and landing criteria for the SST are very much like that required for subsonic vehicles with fairly well defined adjustments to account for SST operation. The airline operation effects are included by developing a pattern of missions to represent the total scope of SST operation. The means of including all these effects in determining service life are practically the same for subsonic and supersonic operation and have been developed from a history of subsonic transport operation. The new influence on service life not significantly present in subsonic operation, is the thermal cycle associated with a Mach 2.7 transport. The effects of this thermal cycle require special attention to assure a proper accounting in analytical procedures.

ENGINEERING THE TEMPERATURE EFFECTS

Investigations of thermal cycle considerations required for Ti-6Al-4V structure in environments in the region of 500° F indicated that developing the following areas of influence will properly account for the thermal cycle: real-time and short-time test correlation, long-time temperature exposure, and phase-cycle relationship of temperature and stress. As indicated in figure 9, the mechanical stress and thermal-gradient stress are added directly when studying the history of stress with temperature on a design detail. Consideration of these factors shall provide the corrections necessary to account for thermal effects.

Temperature and time have always been two variables strongly related in establishing material properties. Some indication of real-time and short-time test correlation is shown in figure 10. Initial testing reported under this Department of Transportation contract began in 1963 and is continuing at this date. The program data shown here was designed to compare a 65-minute flight cycle with three accelerated tests. An accelerated load spectrum was run at 90° F constant temperature, 500° F constant temperature, and a 90° F to 500° F cyclic temperature. The accelerated tests on sheet and extrusion material both showed a deterioration in life at higher constant temperature and also showed deterioration at cyclic temperature, although not as great as at 500° F constant temperature. Real-time tests have completed in excess of 36 000 flight cycles, only one

sheet specimen out of a total of 12 sheet and extrusion specimens failing. These test results encourage further analyses with a hope that accelerated tests may correlate with real-time tests somewhere near a factor of one. Testing is continuing and other tests are underway to augment this data.

The effect of long-time temperature exposure was conveniently included in the basic S-N data by developing the data with specimens previously exposed to 500° F for 500 hours. This procedure is justified by data shown in figures 11 to 13. Figure 11 shows the ratio of exposed to unexposed cyclic maximum stresses and gives 10^5 cycles of life at a stress ratio $R = 0.06$ for Ti-6Al-4V baseline specimens heat soaked for the indicated hours and then tested at room temperature. Figure 12 shows the same ratio for Ti-6Al-4V lap joints with varying fastener installations exposed to both load and temperature for 500 hours and 1000 hours. These data demonstrate a reduction in allowable stress for equivalent life with temperature exposure for 500 hours. Further exposure produces little change. Figure 13 shows results of similar more extensive testing conducted in Ti-8Al-1Mo-1V center-notched specimens exposed to both steady-state and cyclic load and temperature. In this case subsequent fatigue testing is at 500° F after the specified exposure. With varying exposure up to 20 000 hours cyclic and 30 000 hours steady state, all data, independent of how much exposure, falls into a reasonable scatter band. For analysis of the SST prototype, this type of data justified a convenient, 500° F, 500 hours (3 weeks) exposure before life testing. Thus, the effect of long-time temperature exposure is included in the S-N curves used for fatigue-check analysis.

In the accelerated test data of figure 10 with the same maximum temperature, there is an indication that fatigue life improved over that at constant temperature when temperature and stress were both cycled. From many sources the data of figure 14 establishes a life ratio curve for life at constant elevated temperature. A comparison in figure 15 of this curve with data from tests wherein temperatures were cycled in phase with stress, shows an improvement in fatigue life for the 0° phase difference stress-temperature cycle. Extending this basic idea through all phase-angle differences develops the life ratio factor η of figure 16 as a means to correct service life computations for variations of the phase angle between stress cycles and temperature cycles. The design analyst reviewing his temperature and stress history, in addition to determining GAG stress limits, must determine the maximum temperature and the significant phase-angle difference between his stress and temperature flight cycle.

In order to engineer temperature effects into a simplified fatigue-check procedure for prototype design, the following guidelines are offered:

- (1) Accelerated test procedures can be established to assure real-time and short-time test correlation near a factor of one.

(2) Long-term temperature exposure is accounted for by exposing test specimens for S-N data to 500° F for 500 hours and then testing at room temperature.

(3) The stress-temperature cycle phasing correction factor η of figure 16 will account for the balance of temperature effects.

TOTAL DAMAGE RELATED TO GAG DAMAGE

Since a method has been provided for the design analyst to define the primary GAG stress cycle, one key to establishing a quick fatigue-check procedure is to relate total damage to GAG damage on the elements of primary structure. By extensive use of computer programs to define internal load distribution and conduct fatigue analysis on discrete parts of typical primary structure, the ratio δ of GAG fatigue damage to total fatigue damage can be determined. Typical plots of the GAG damage ratio developed for handbook use are shown for the wing lower surface in figure 17 and for the body sections in figure 18. It is now possible to set up a simple formula which determines a number of GAG cycles N_{GAG} which will produce equivalent total fatigue damage.

$$N_{GAG} = n_{GAG} \frac{(FRF)}{\eta \delta}$$

where

N_{GAG} number of cycles to produce equivalent total fatigue damage

n_{GAG} the number of flights in which the primary GAG cycle is determined for a 50 000 flight hour service life, or where a primary GAG cycle is not apparent, a number of primary load cycles in a 50 000 flight hour service life for which the damage ratio δ is known or can be estimated

FRF fatigue reliability factor defined in handbook tables

η ratio of fatigue life at stress-temperature cycle phasing to room-temperature fatigue life

δ ratio of GAG fatigue damage to total fatigue damage

Since N_{GAG} , $GAG \sigma_{MAX}$, and $GAG \sigma_{MIN}$ are known, it is now necessary to determine the proper quality level of S-N data which can be used to determine service life.

RATING OF STRUCTURAL DETAILS

It has been common practice to rate structural details by determining apparent stress concentration factors K_T and using S-N curves with the same apparent stress concentration factor to determine fatigue life of that detail. Many textbook and handbook sources are available to determine apparent stress concentration factors. For communication to the design analyst, who likes to do his thinking with loads, load paths, and stresses, K_T gives some feel for fatigue quality but does not necessarily provide good communication. High values of apparent stress concentration K_T give low values of service life. The quantity K_T defines some local magnification of stresses that reduce life. Although for calculation purposes the detail fatigue ratings (DFR) defined in this report depend on values of K_T , DFR values are a more useful communication term with an engineering feel closer to the design analyst's pattern of thinking.

The DFR number found useful in this report is defined as the maximum cyclic stress σ_{MAX} in a constant-amplitude loading cycle at which the design detail will withstand 10^5 cycles at a stress ratio R of 0.06. This stress ratio is a convenient testing ratio and 10^5 cycles represents a reliability factor of 4 on 25 000 flights, which is near the fatigue life range of significance on the SST prototype. Figures 19 and 20 show ranges of value of the DFR number for various detail coupon tests and for various lap joint tests, respectively. If this DFR number is plotted against $1/K_T$ for variations in a type of structural detail, it will develop, within test scatter, as a straight line, as shown in figure 21. Consequently, for the convenience of the design analysts, tables can be produced with governing constants specified for various design details. Somewhat more convenient, as more test data and experience develops, charts similar to figure 22 are prepared and added to the analysis handbook.

For communication purposes the DFR number communicates a stress number; the greater it is, the better the fatigue quality. A value of 65 ksi is high quality in Ti-6Al-4V structure and is achieved in basic skin-stringer structure with high-quality fastener installations. Low-quality values can go below 20 ksi in the low-quality joint installations.

The significance of the DFR number in specifying S-N data is illustrated in figures 23 and 24. Figure 23 is a set of S-N curves for a DFR of 30 ksi and figure 24 is for a DFR of 45 ksi. In each case this rating number establishes the relative quality of each set of curves by being the σ_{MAX} giving 10^5 cycles at $R = 0.06$. If on each plot the design analyst considers a design detail for which he has determined $GAG \sigma_{MAX} = 50$ ksi and $GAG \sigma_{MIN} = 20$ ksi, the service life variation is apparent. (σ_{MIN} is the minimum cyclic stress.) At DFR = 30 ksi, the fatigue life is about 5×10^4 cycles; at DFR = 45 ksi, the fatigue life is about 2×10^5 cycles. The higher quality provides four times the fatigue life.

CONSTANT-LIFE CHECK CHARTS

After development of a family of S-N curves for a range of design quality, it is a simple procedure to prepare detail fatigue-check charts for a range of constant-life values. As shown for $N = 10^5$ cycles in figure 25, this procedure allows a plot of the two variables, GAG σ_{MAX} and DFR, in a form most useful to the design analyst. These two variables plot as a family of lines for different values of stress ratio. With a family of these detail fatigue-check charts covering the range of cyclic interest, interpolation can be conducted for a design detail at any N_{GAG} to establish the required relationship of DFR and GAG σ_{MAX} at a known value of R .

The design analyst can enter the fatigue-check charts with either σ_{MAX} or DFR and determine important design trades. Entering the chart with a calculated cyclic σ_{MAX} might represent a case where a desired level of working stress is apparent from other design considerations. Figure 26 illustrates this case and points out the design terms established for the case where $N = 200\ 000$ cycles. The ordinate value defines a minimum detail quality required for this σ_{MAX} . If DFR is actually higher or lower, the design analyst moves up or down the R value line to determine an appropriate allowable σ_{MAX} . Entering the chart with a trial DFR is illustrated in figure 27. In either case the design analyst can quickly determine the value of improving his design quality or of changing his cyclic stress level.

FATIGUE ANALYSIS PROCEDURE

The fatigue-check procedure is made available to each design analyst on the SST prototype by a structural fatigue handbook. By management directive, a design has not been structurally reviewed unless it has been checked for its repeated load environment as well as for its strength and stiffness requirements. Unless a specific exception can be justified for prototype only, the prototype design details shall qualify for the specified production service life of 50 000 flight hours.

To illustrate the fatigue-check procedure, assume the design analyst is looking at a wing lower surface skin-stringer detail forward of the rear spar at buttock line (BL) 550. (See fig. 17.) He would like to use standard rivet installations in order to minimize assembly costs. The procedure would be

(1) Following through the segmented sections of the mean mission of figure 6, computations of internal load distribution and the gradient effects of the thermal cycle will produce a normal operating stress and temperature history similar to that of figure 9. From such data the primary GAG stress cycle is determined as

$$\sigma_{MAX} = 25 \text{ ksi } (R = -0.5)$$

Also from a plot similar to figure 9 it appears that the stress-temperature phase relationship is near 90° with a maximum temperature of 430° F.

(2) It is now necessary to determine the number of GAG cycles N_{GAG} that will produce equivalent total fatigue damage. By referring to figure 16, the stress-temperature cycle phasing correction is

$$\eta = 0.85$$

By referring to figure 17, the GAG damage ratio is

$$\delta = 0.80$$

From handbook tables and test data considerations, the fatigue reliability factor for this detail in Ti-6Al-4V is

$$FRF = 5.8$$

Conservatively, including full-stop landings in the number of required flights,

$$n_{GAG} = 23\ 500 \text{ cycles}$$

Consequently,

$$N_{GAG} = n_{GAG} \frac{FRF}{\eta\delta} = 200\ 000 \text{ cycles}$$

(3) With N_{GAG} and σ_{MAX} at $R = -0.5$ known, the design analyst enters figure 26 and determines the minimum DFR required to provide 50 000 flight hours of service life; that is, a required DFR of 40 ksi.

(4) With the geometric, fabrication, and installation details, the design analyst must determine the actual DFR. From figure 22,

$$\text{Actual DFR of } 56 \text{ ksi} > \text{Required DFR of } 40 \text{ ksi}$$

Therefore the installation provides more than satisfactory service life. If surrounding installations are compatible, weight may be removed from the installation by increasing stress levels to match the actual DFR. The weight reduction is only possible if static strength and stiffness requirements will permit.

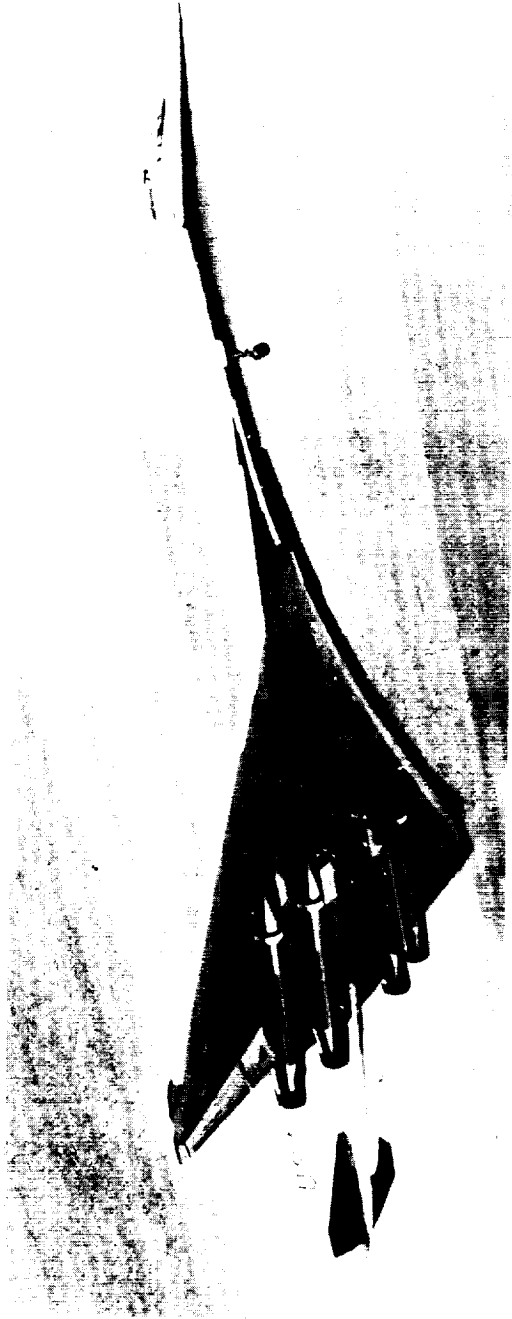
If testing or previous experience had not provided a chart of DFR values for this installation, the structural fatigue handbook would have provided the constants needed in figure 21 to calculate an actual DFR. By the use of this procedure the design analyst can develop an understanding of the stress or detail quality modifications necessary to qualify for service life.

CONCLUDING REMARKS

A fatigue-check procedure requiring minimum additional effort is proposed for use by design analysts who must review structure and "firm up" design details before drawing release. The concept presented here satisfies part of the need of having the designer of structural details cognizant of the good and bad points of design for service life.

As compared with subsonic transports the primary new environment variable influencing fatigue design on the American SST is the thermal cycle associated with a Mach 2.7 cruise speed. The effects of this thermal cycle can be included in fatigue-check procedures by accounting for real-time and short-time test correlation, long-time temperature exposure, and phase cycle relationship of temperature and stress. Because of the SST type of operation, relatively large parts of fatigue damage develop on wing and body primary structure from ground-air-ground (GAG) cycles. By determining the relationship of GAG damage to total fatigue damage on typical primary structures, fatigue-check procedures can be greatly simplified.

By using a detail fatigue rating (DFR) designated by a maximum cyclic stress instead of using the apparent stress concentration factor directly, a better communication term is available to evaluate relative fatigue quality of design details.



TAKE-OFF



CRUISE

Figure 1.- The American supersonic transport.

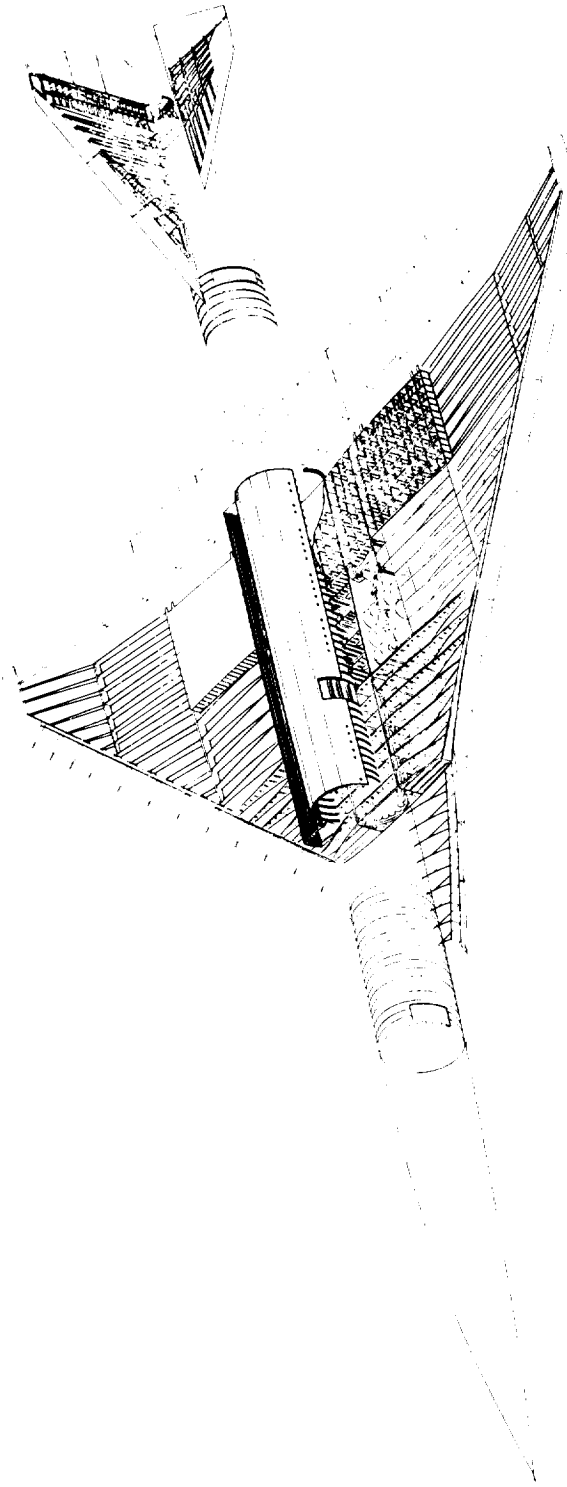


Figure 2.- Structural arrangement.

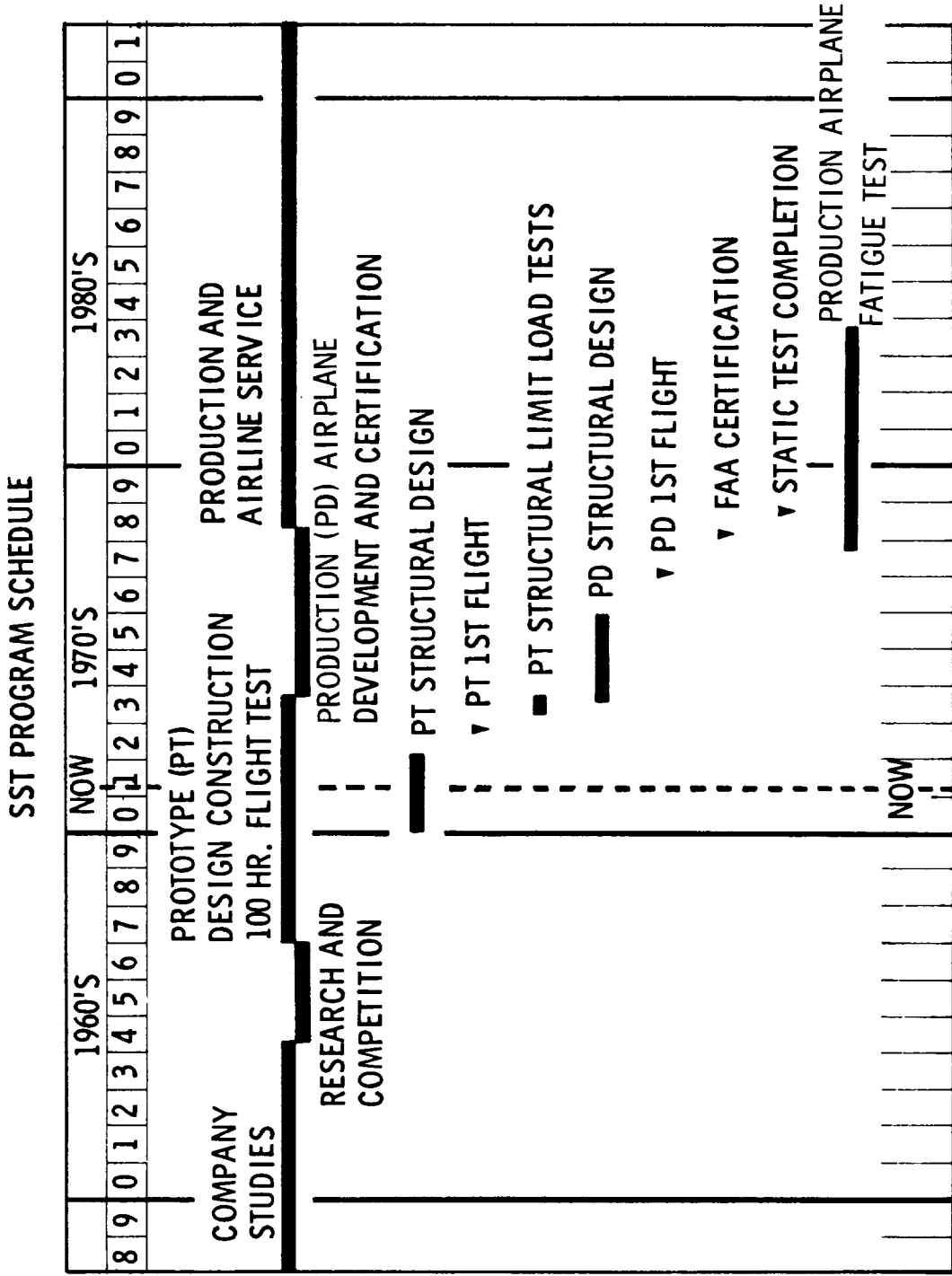


Figure 3 - SST program schedule.

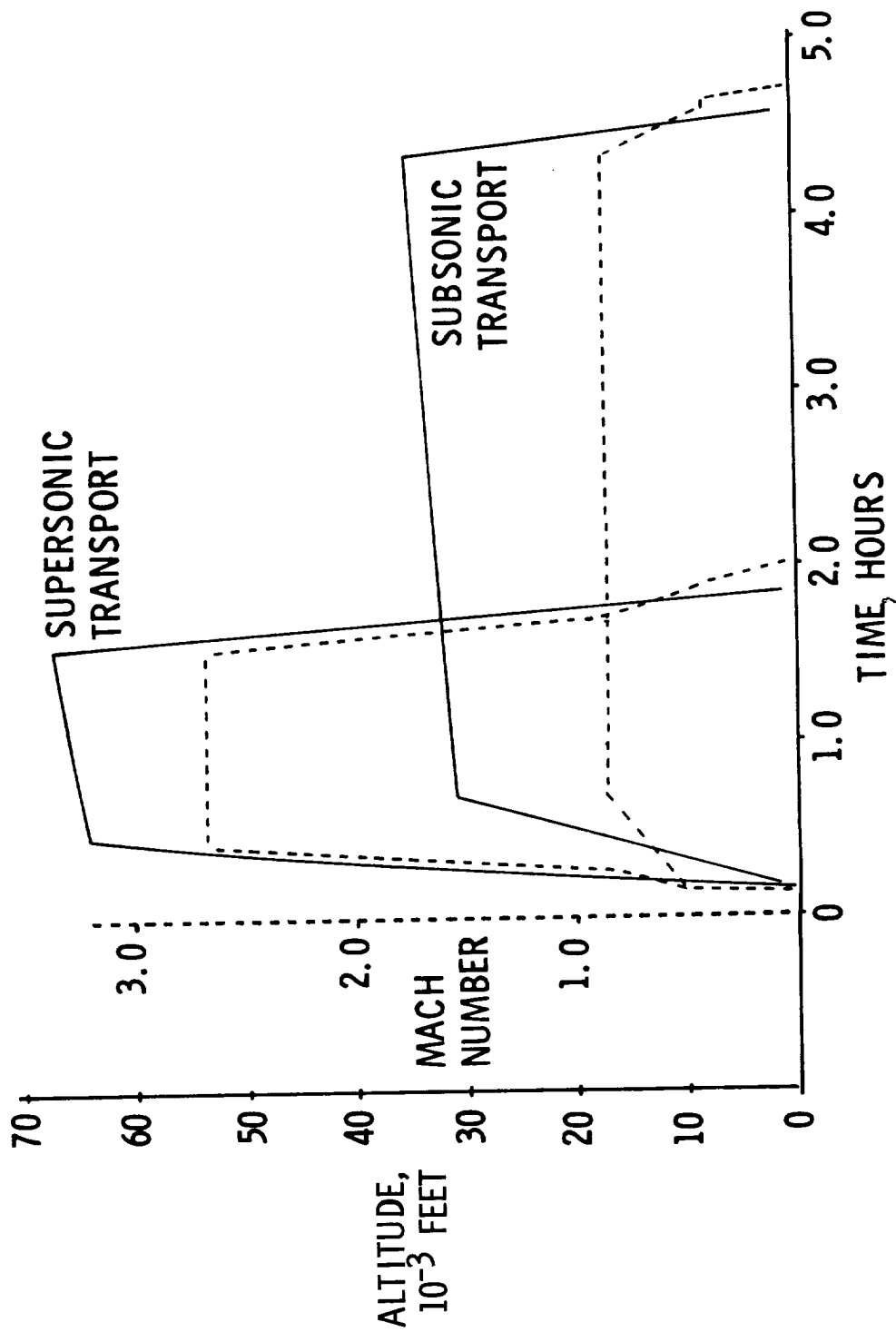


Figure 4.- Equidistant mission comparison.

M = 2.7
 U S STANDARD DAY
 STAGNATION TEMP = 500°F
 NO INTERNAL EFFECTS
 UNPAINTED AIRPLANE
 ALL TITANIUM SKIN SURFACES

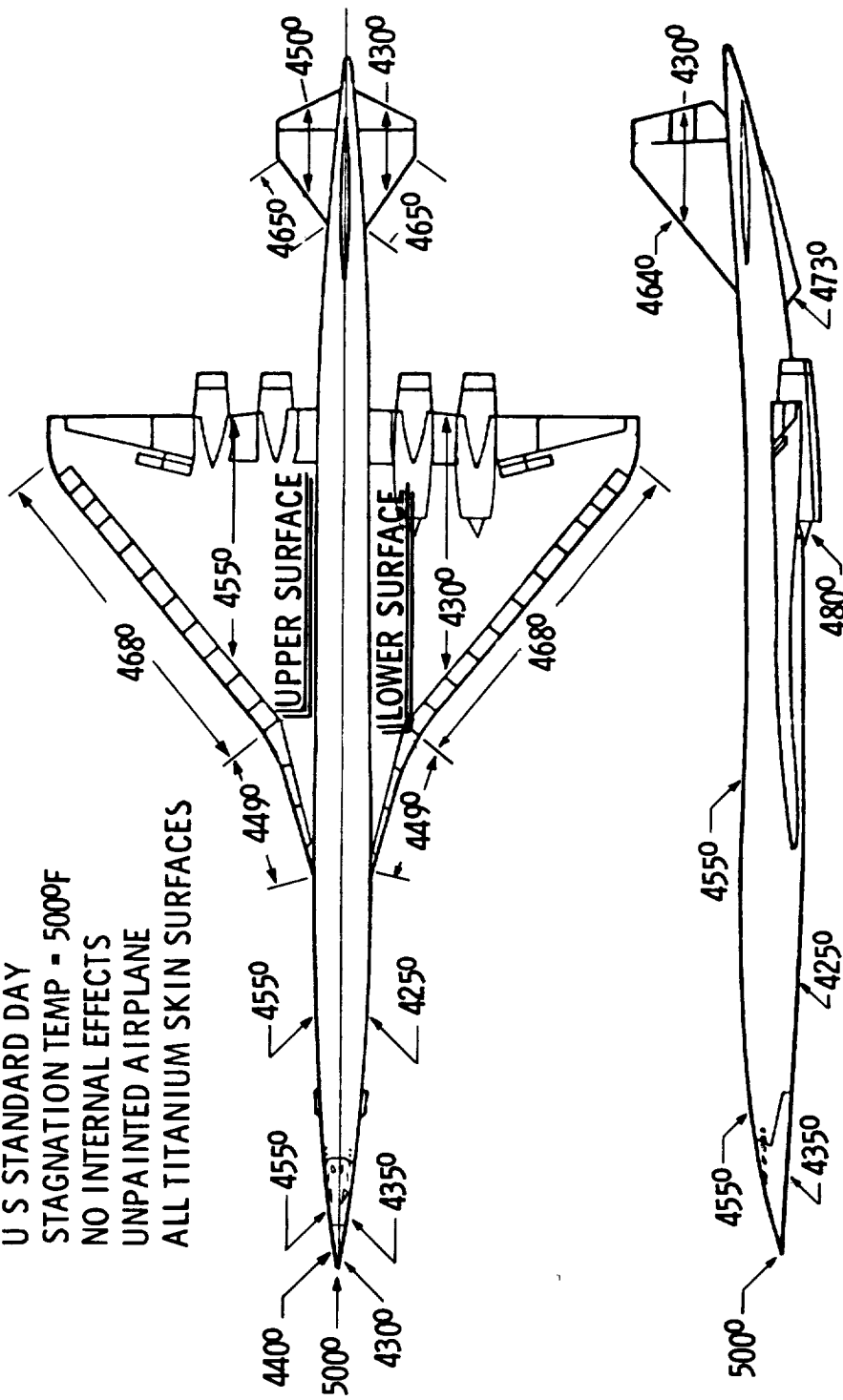


Figure 5.- Stabilized cruise temperatures.

Mission 4
 Take-off gross weight, 555 kips
 Range, 2150 n. mi.
 Payload, 30 kips (23 + 7)

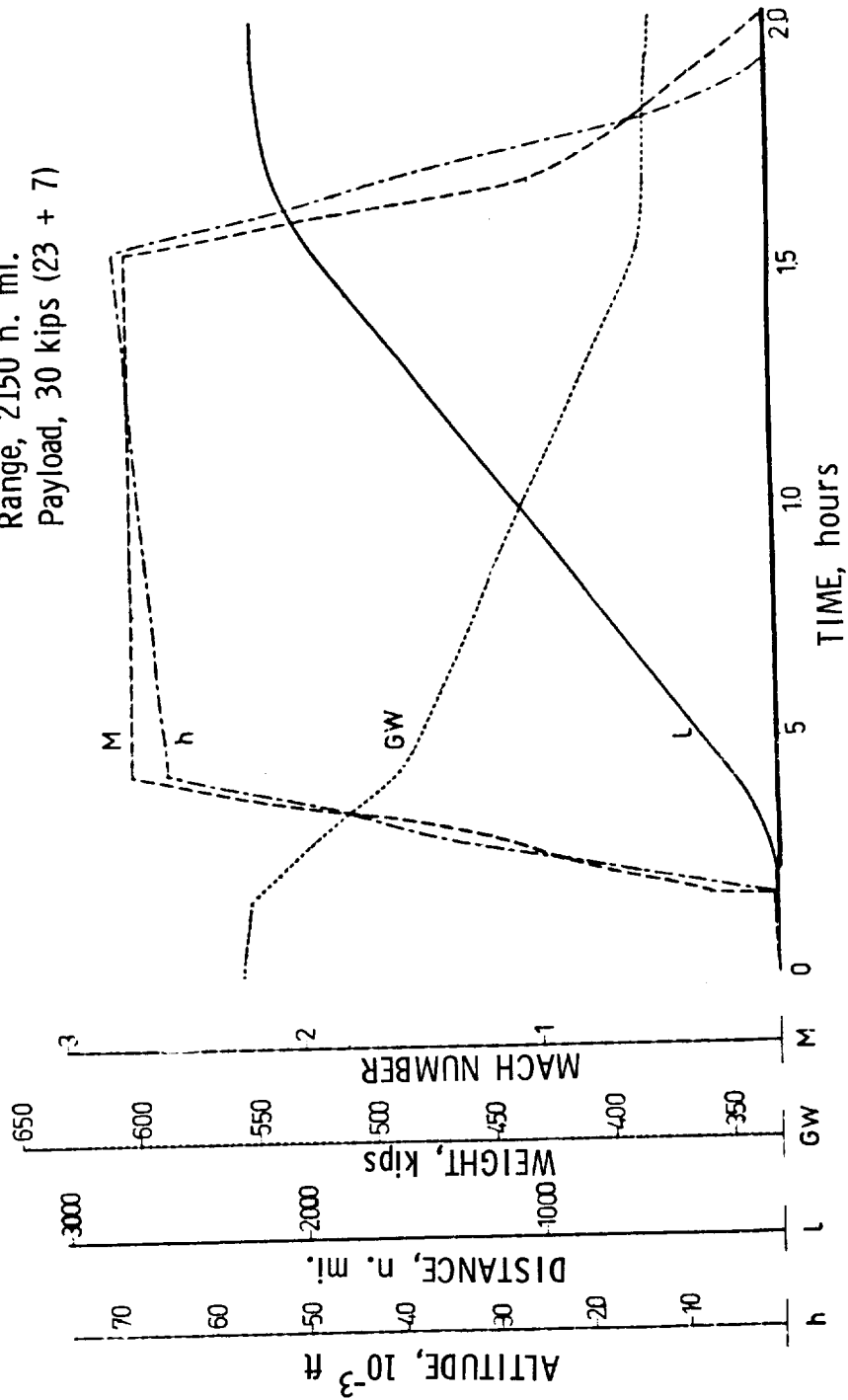


Figure 6.- Mean mission flight profile.

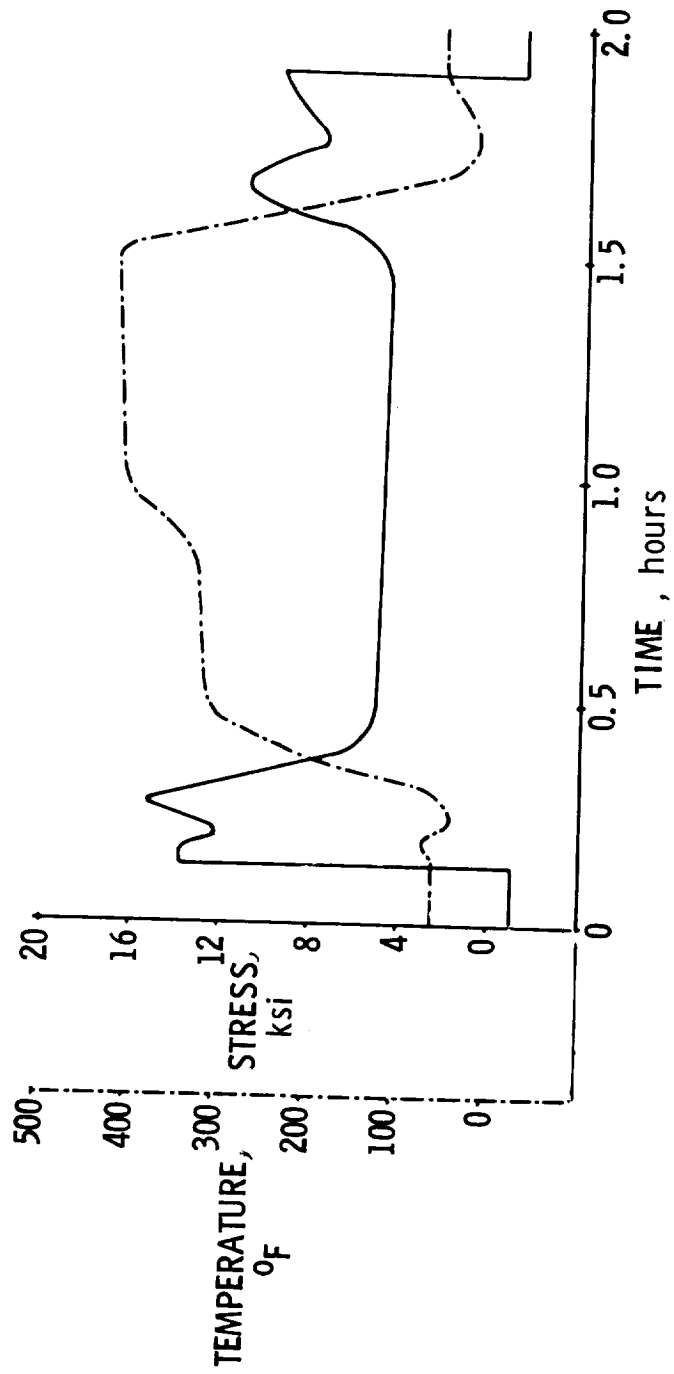


Figure 7.- Wing lower surface skin temperature and Ig stress.

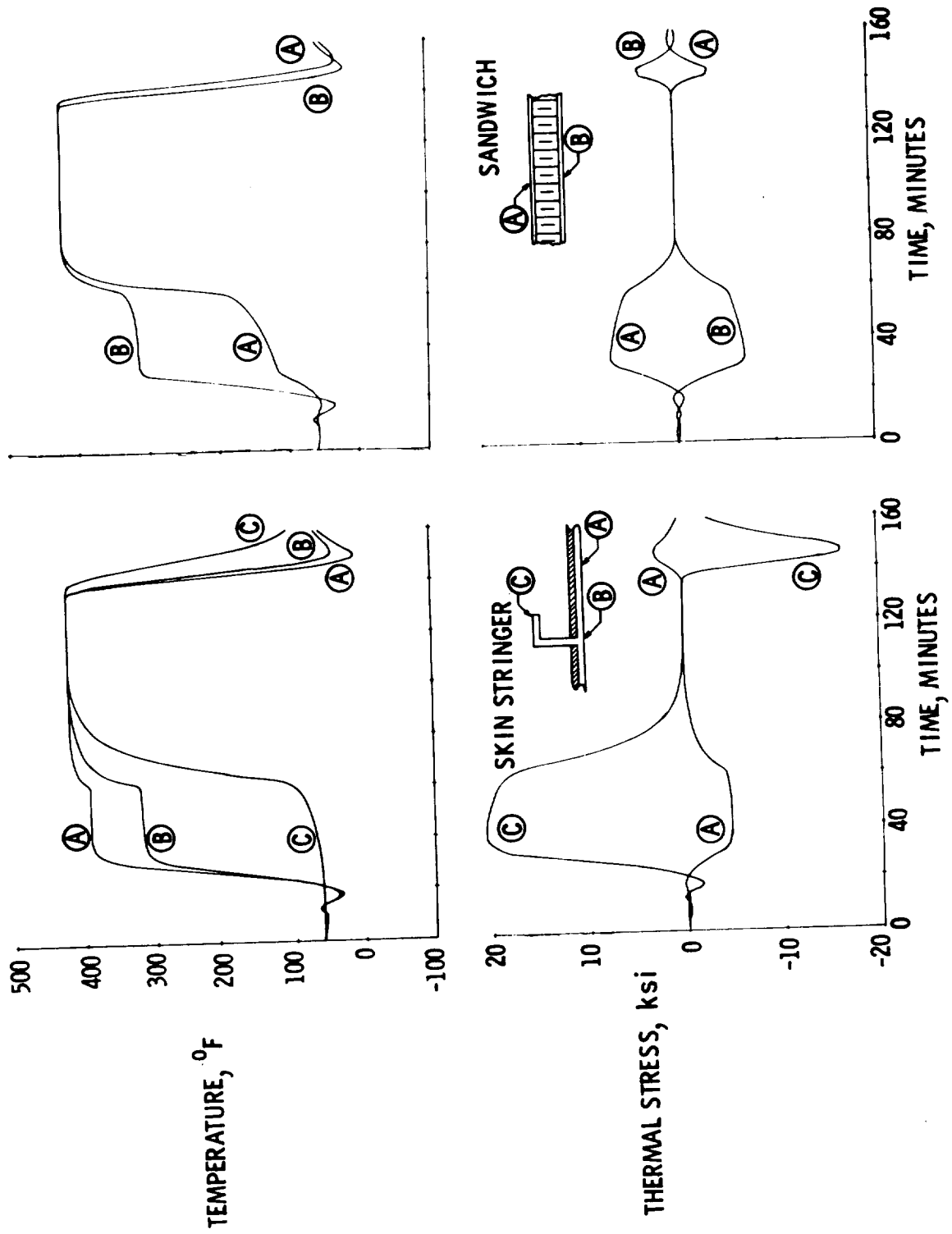


Figure 8.- Typical thermal gradient effects.

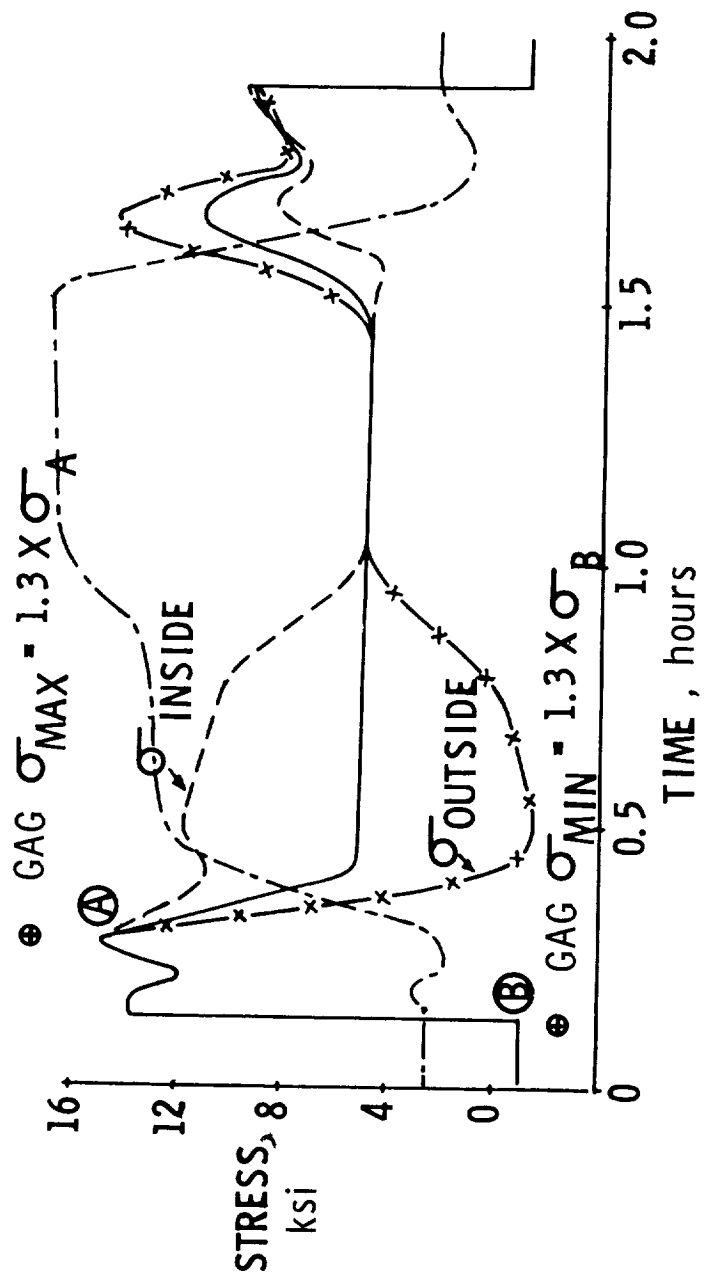


Figure 9.- Normal operation stress time history as influenced by thermal stress.

o Mean value; number denotes number of tests
 x Failure
 | Current test status

MATERIAL DATA	SPECTRUM		NUMBER OF FLIGHTS UNTIL INITIAL CRACKING				
	TEMPERATURE	LENGTH	2 x 10 ⁴	5 x 10 ⁴	10 ⁵		
6-4 SHEET .050" MILL- ANNEALED	90° F CONSTANT	19 SEC.	o 4				
	500° F CONSTANT	19 SEC.	o 4				
	90-500° F CYCLIC	19 SEC	o 4				
	90-500° F CYCLIC	1 HOUR	x				
6-4 EXTRUSION .050" S.T.A.	90° F CONSTANT	19 SEC		o 4			
	500° F CONSTANT	19 SEC		o 4			
	90-500° F CYCLIC	19 SEC		o 4			
	90-500° F CYCLIC	1 HOUR			o 4		

(d) Current status of real-time and accelerated testing.

Figure 10.- Concluded.

- RIVET, HI-SQUEEZE INSTALLATION
- BOLT, "HI-LOK"
- ▽ BOLT, "TAPER-LOK"

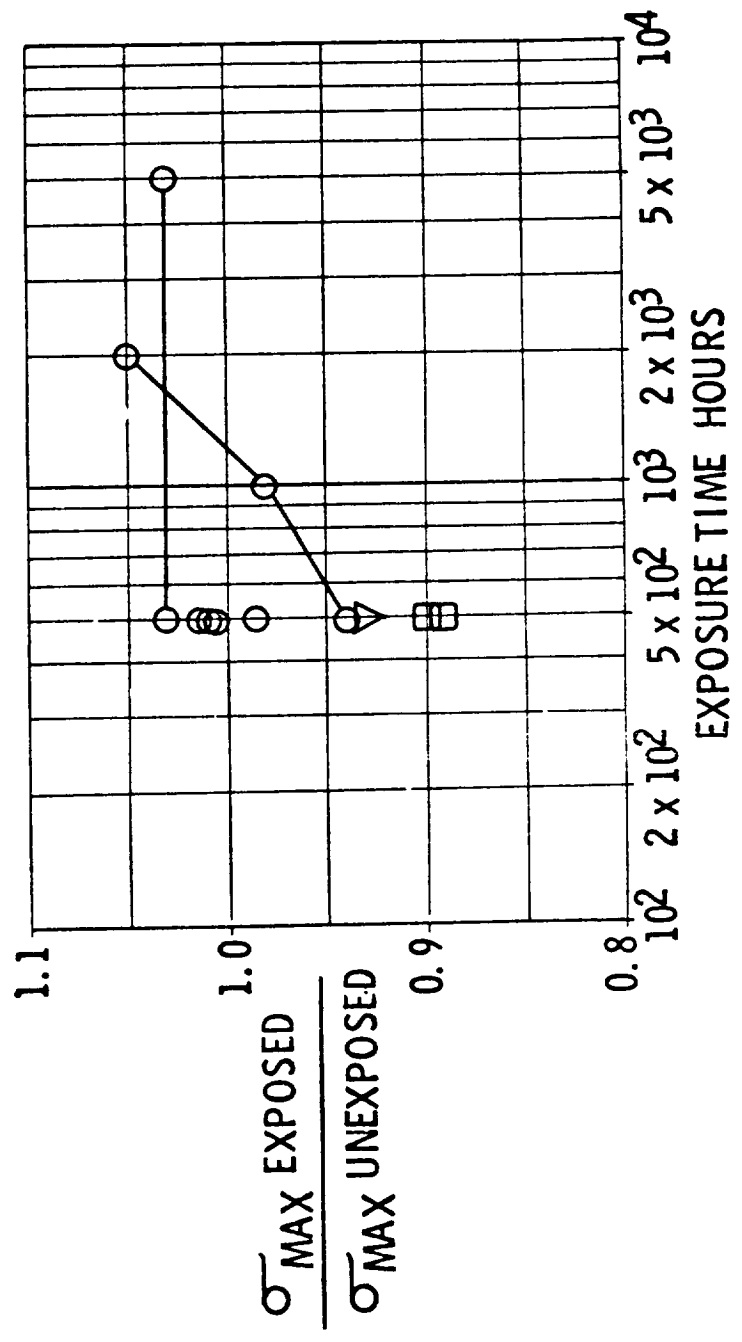


Figure 11. - Effect of temperature exposure. σ_{MAX} at $R = 0.06$ for 10^5 cycles life. Ti-6Al-4V baseline specimens exposed to 500° F temperature.

OPEN SYMBOLS INDICATE EXPOSURE AT 5500F
 DARK SYMBOLS INDICATE EXPOSURE AT 4500F
 ▽ RIVET, A-286 MATERIAL, GUN DRIVEN INSTALLATION
 ○ RIVET, A-286 MATERIAL, SQUEEZE INSTALLATION
 □ RIVET, Ti-6Al-4V MATERIAL, SQUEEZE INSTALLATION

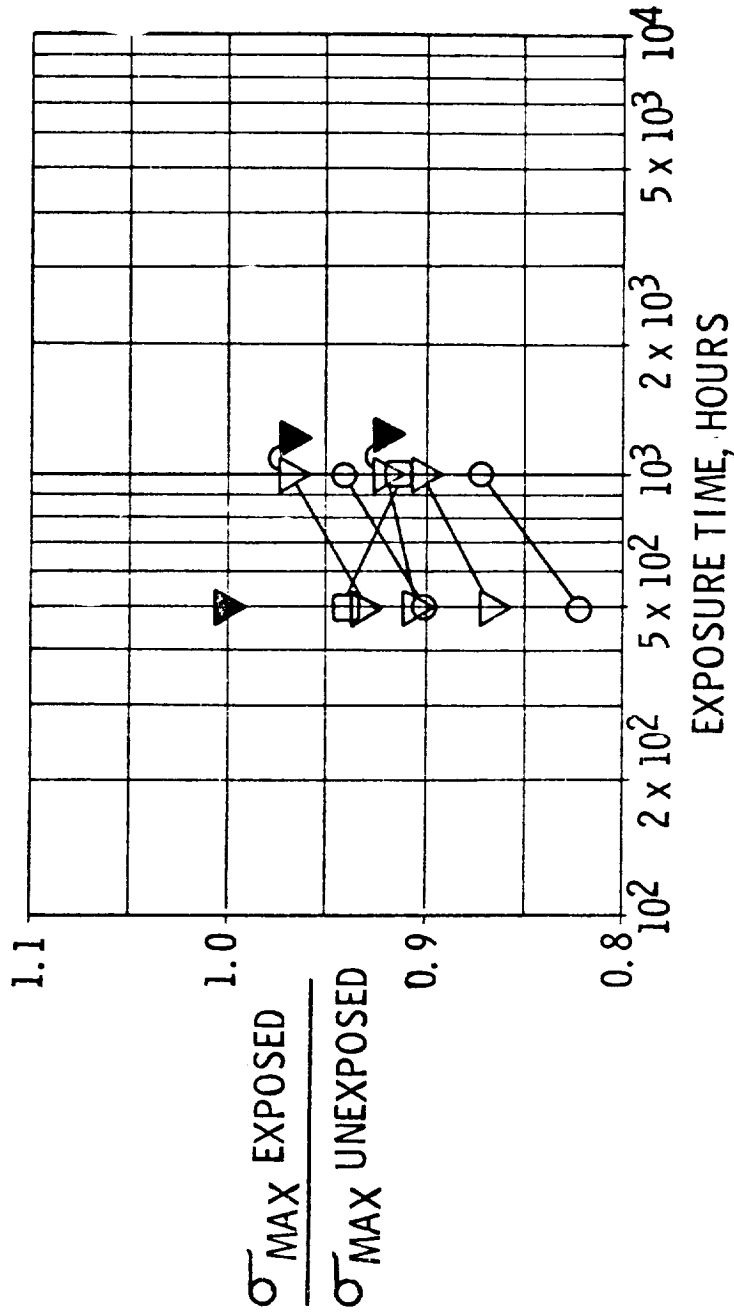


Figure 12.- Effect of load and temperature exposure lap shear joints. σ_{MAX} at $R = 0.06$ for 10^5 cycles life. Ti-6Al-4V lap shear joint specimens exposed to temperature and 30 ksi stress.

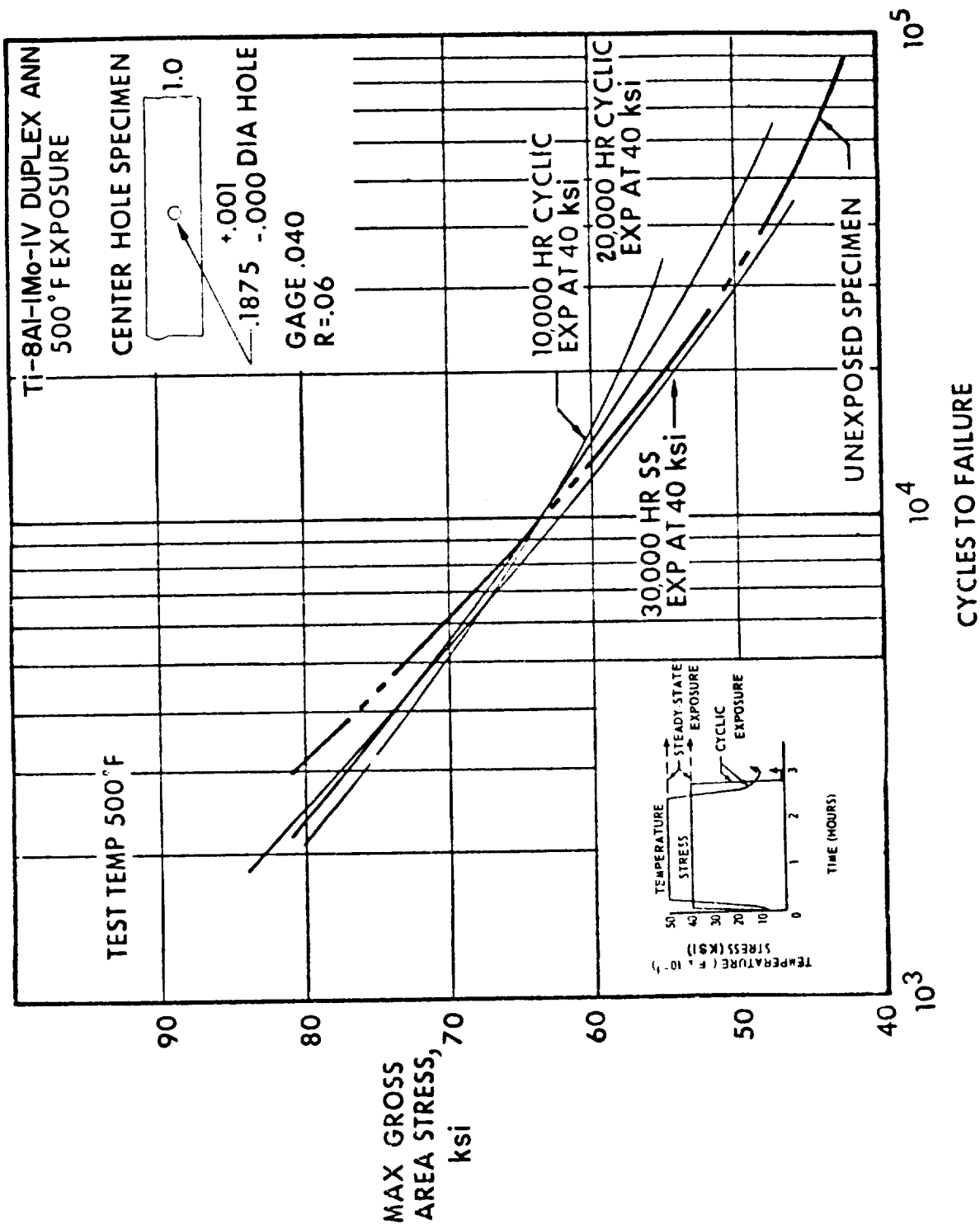


Figure 13.- Effect of load and temperature, steady-state and cyclic, on center-notched Ti-8Al-1Mo-IV duplex annealed specimens.

- + H/C FACES, R = .06, AL-BRAZED, COND. IC
 - ◇ OPEN HOLE, R = .06, COND. IV
 - OPEN HOLE, R = .06, COND. I
 - ◇ OPEN HOLE, R = 0, S.T. & A.
 - OPEN HOLE, R = -1, S.T. & A.
 - ◇ OPEN HOLE, R = .54, S.T. & A.
 - △ OPEN HOLE, R = -.47, MILL ANN.
 - OPEN HOLE, R = -.47, S.T. & A.
 - BASELINE, R = .06, H. SQ. RIV., COND. IV
 - ◇ RIVETED DOUBLER, R = .06, COND IV,
- CONSTANT AMPLITUDE TESTS (OPEN SYMBOLS)
SPECTRUM LOADING (CLOSED SYMBOLS)

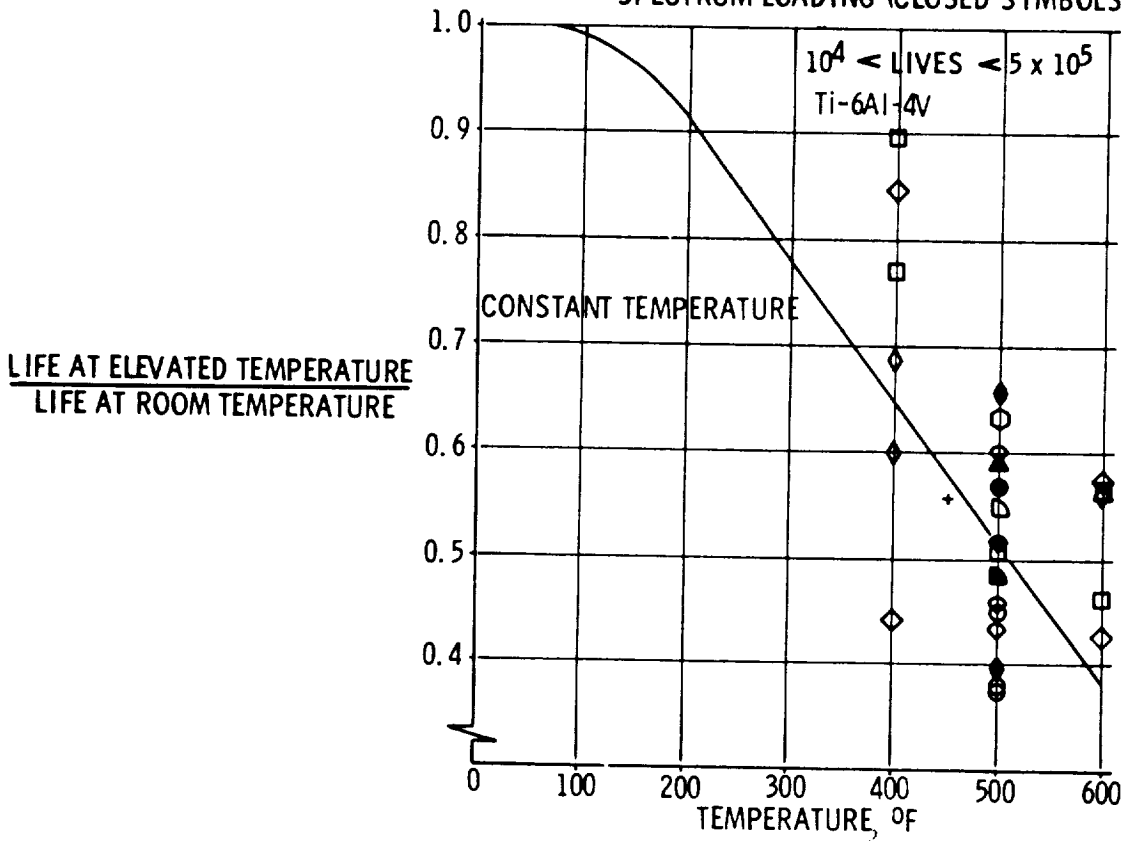


Figure 14.- Life at constant elevated temperature.

- △ OPEN HOLE, R = -.47, MIL. ANN.
- OPEN HOLE, R = -.47, S.T. & A.

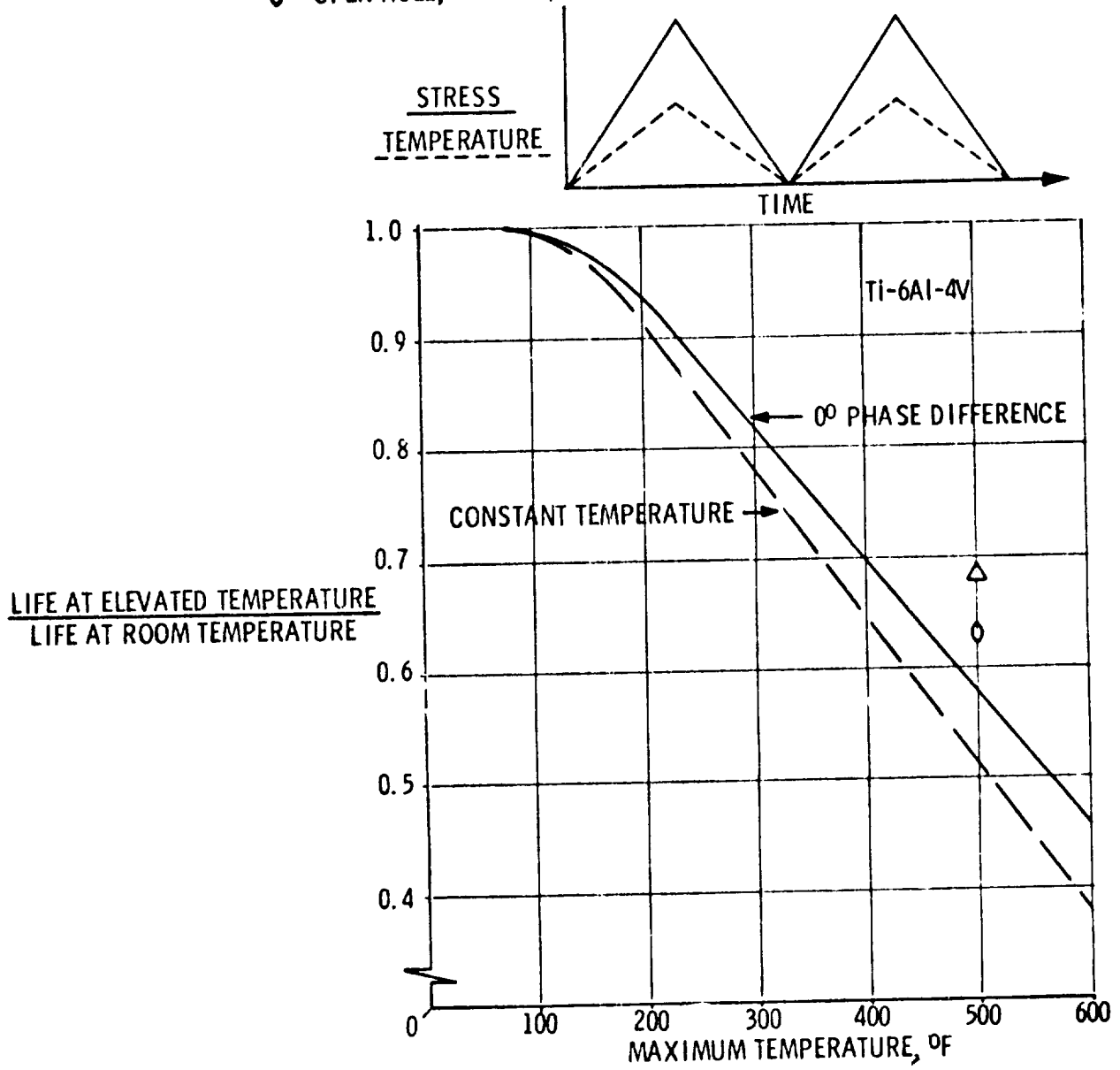


Figure 15.- Life at stress-temperature phase angle of 0°.

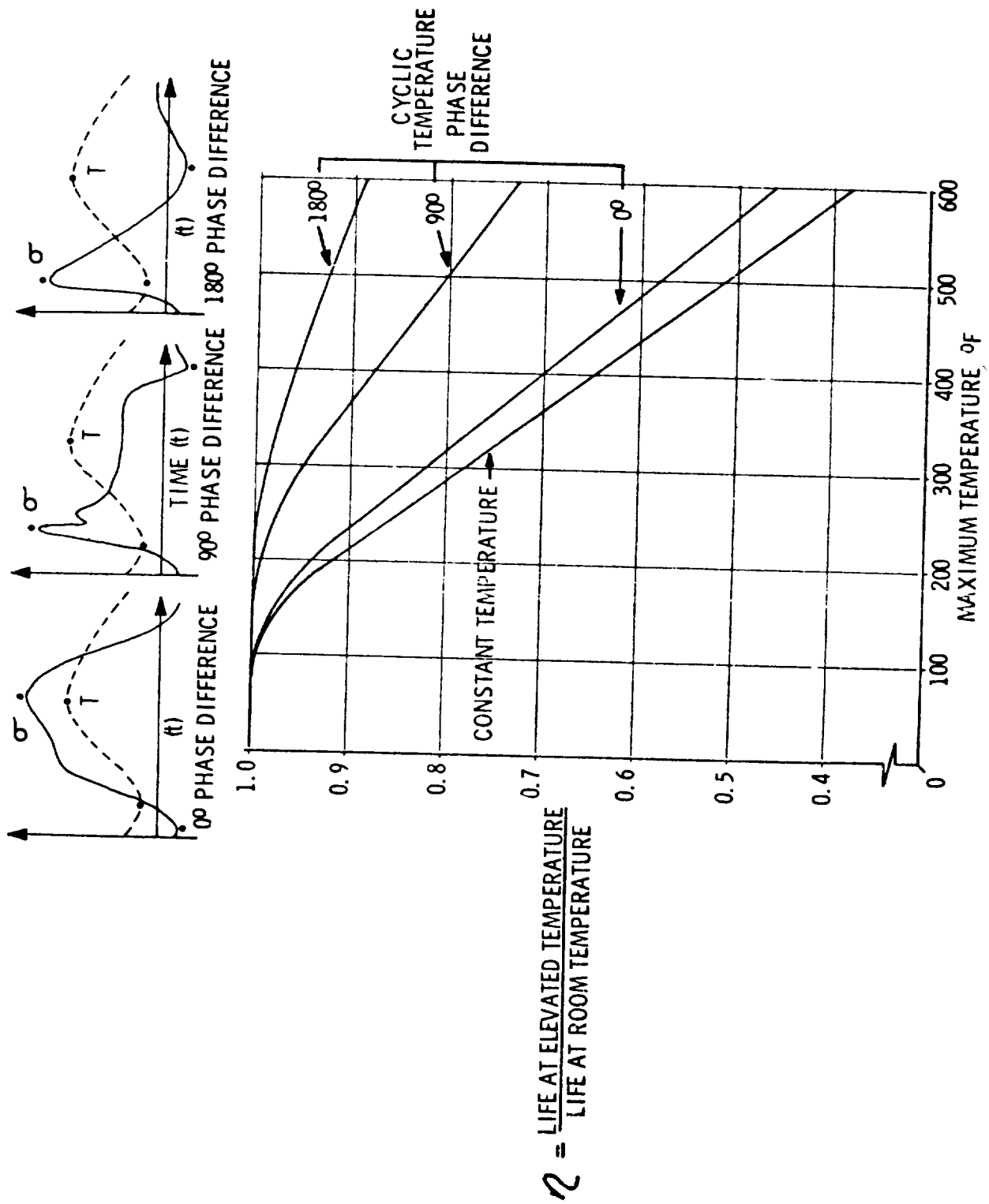


Figure 16.- Fatigue life ratio for the effect of stress-temperature cycle. σ, peak stress; T, peak temperature.

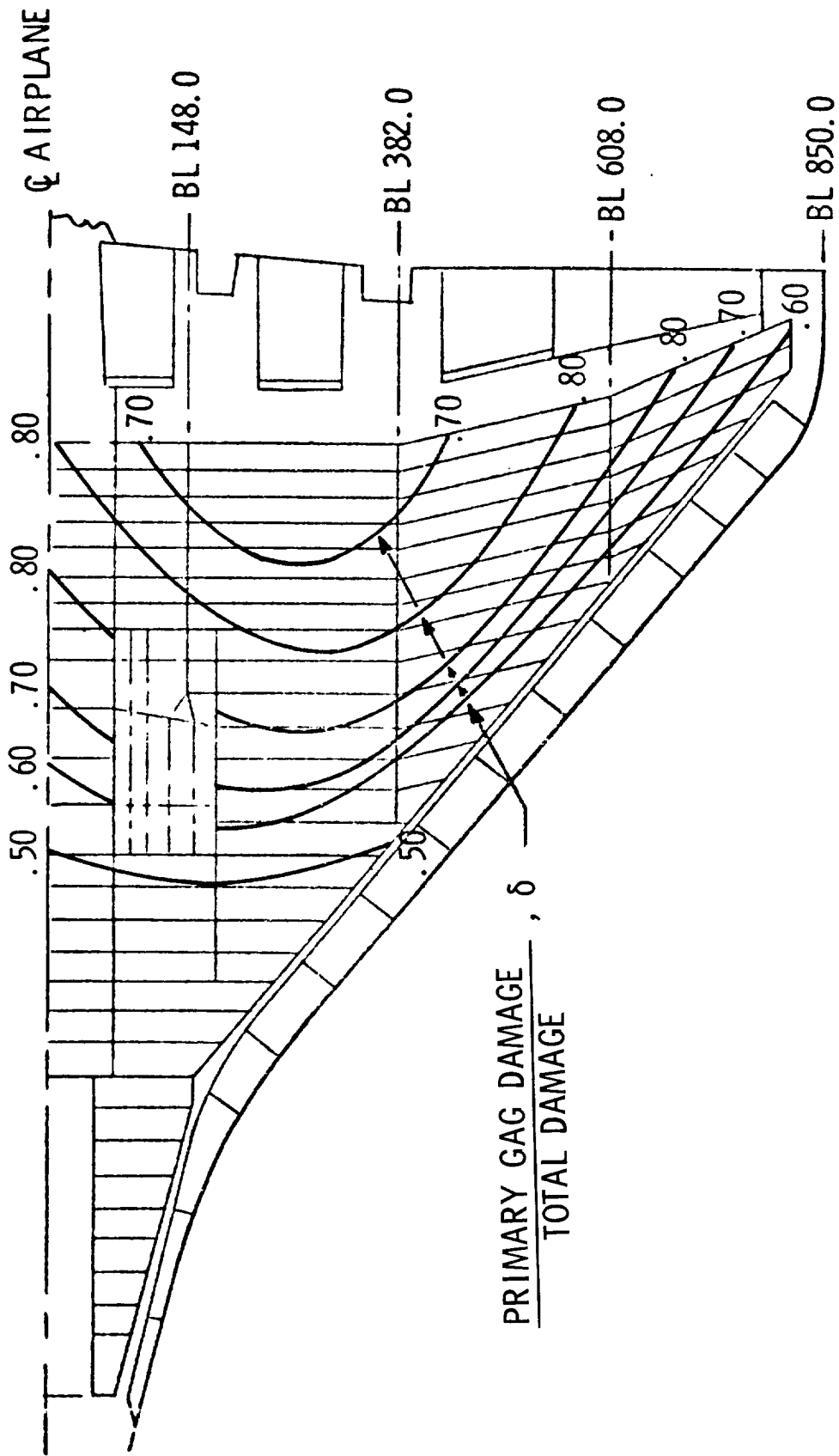


Figure 17.- Wing lower surface inner element primary GAG damage ratio.

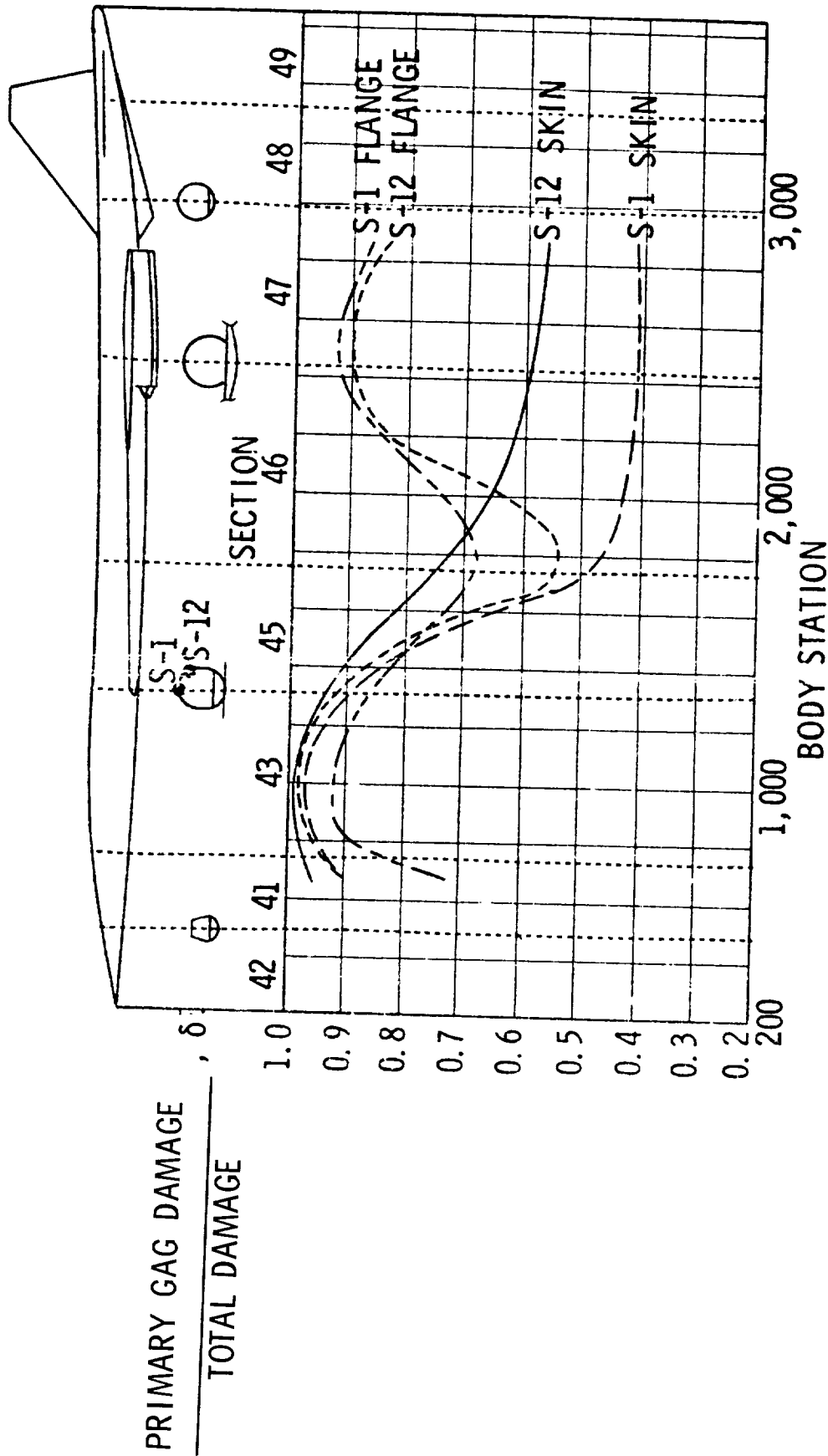


Figure 18.- Fuselage primary GAG fatigue damage ratio.

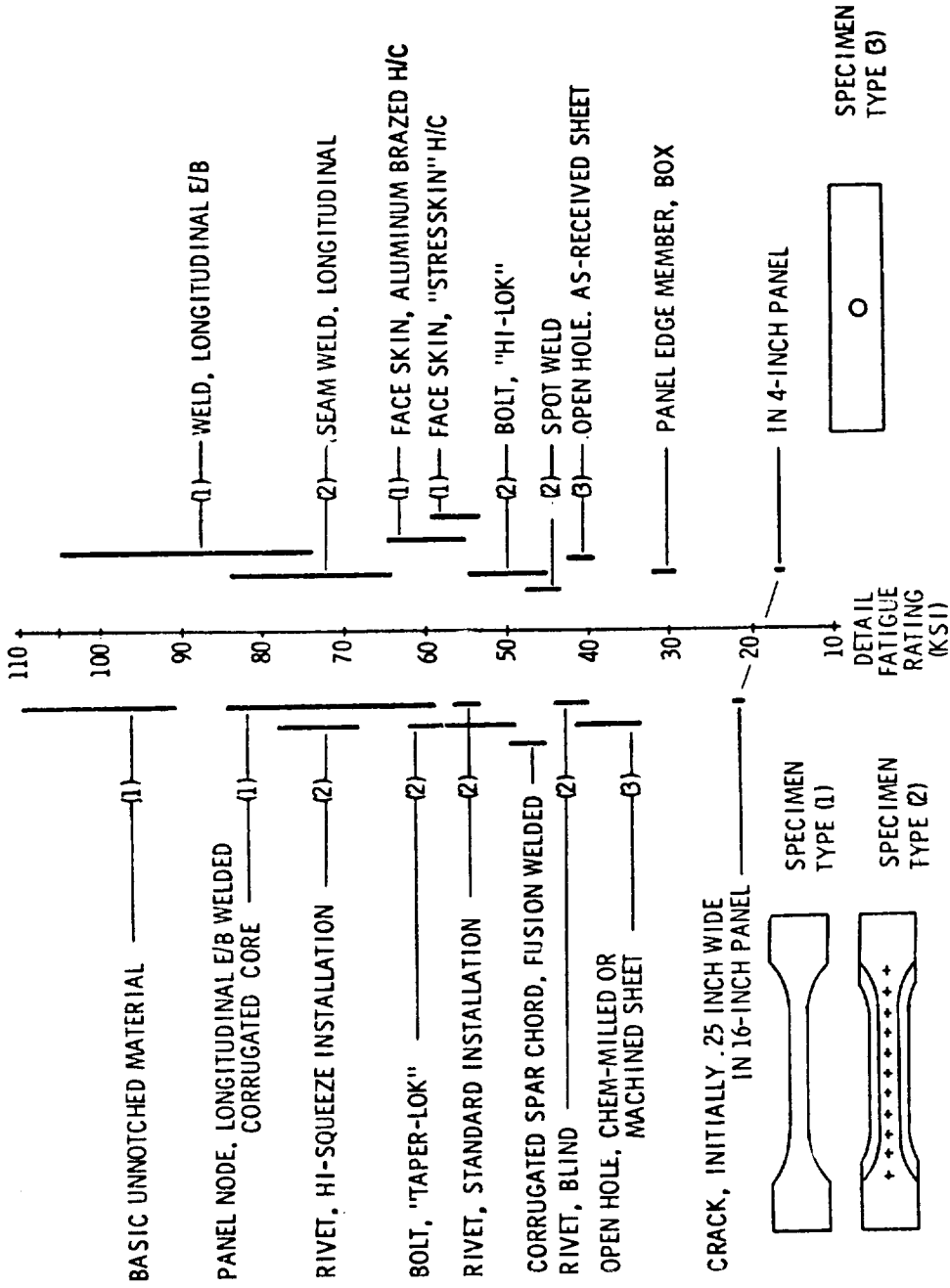


Figure 19.- Ti-6Al-4V basic structure detail fatigue rating. σ_{MAX} at $R = 0.06$ at 10^5 cycles life.

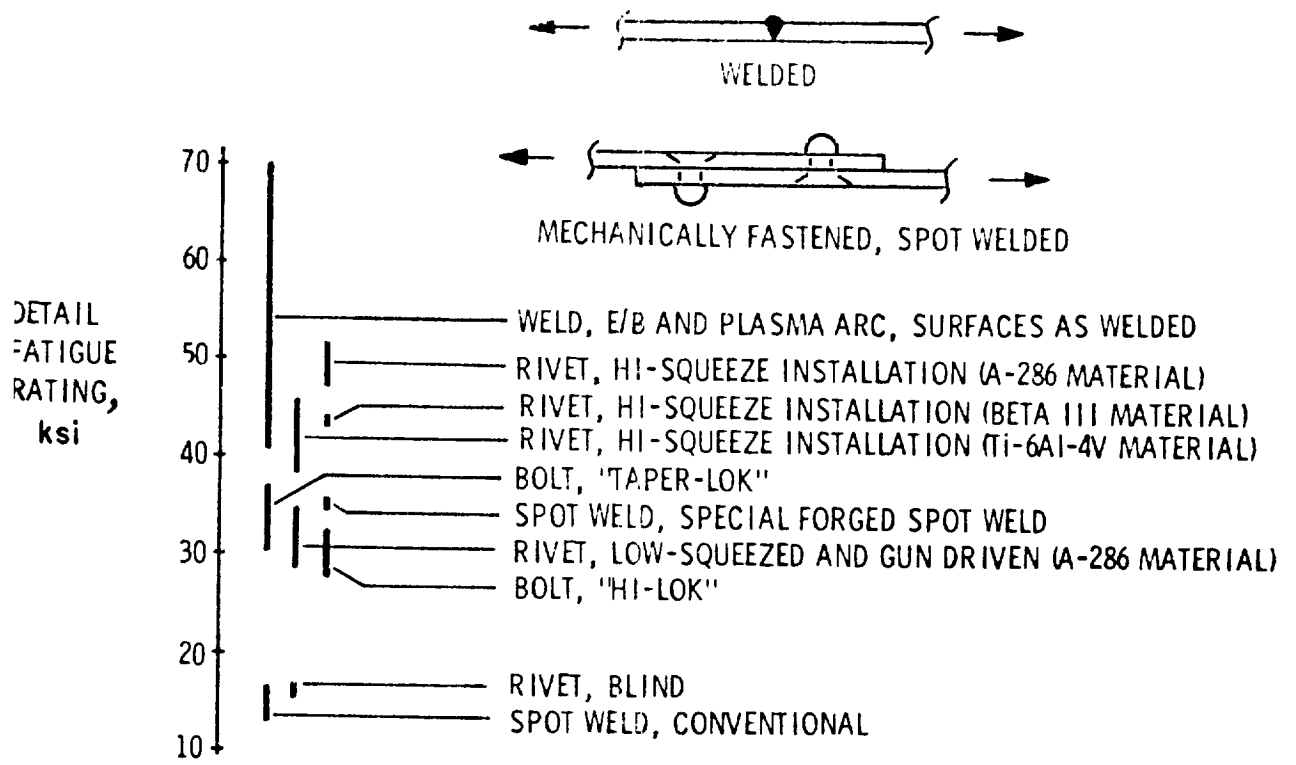


Figure 20.- Ti-6Al-4V joint detail fatigue rating. σ_{MAX} at $R = 0.06$ at 10^5 cycles life.

$$DFR = \lambda L - \mu M \left(\frac{1}{K_{T,0}} - \frac{1}{K_T} \right)$$

WHERE: L & M ARE MATERIAL PARAMETERS
 λ, μ AND $K_{T,0}$ ARE DETAIL PARAMETERS

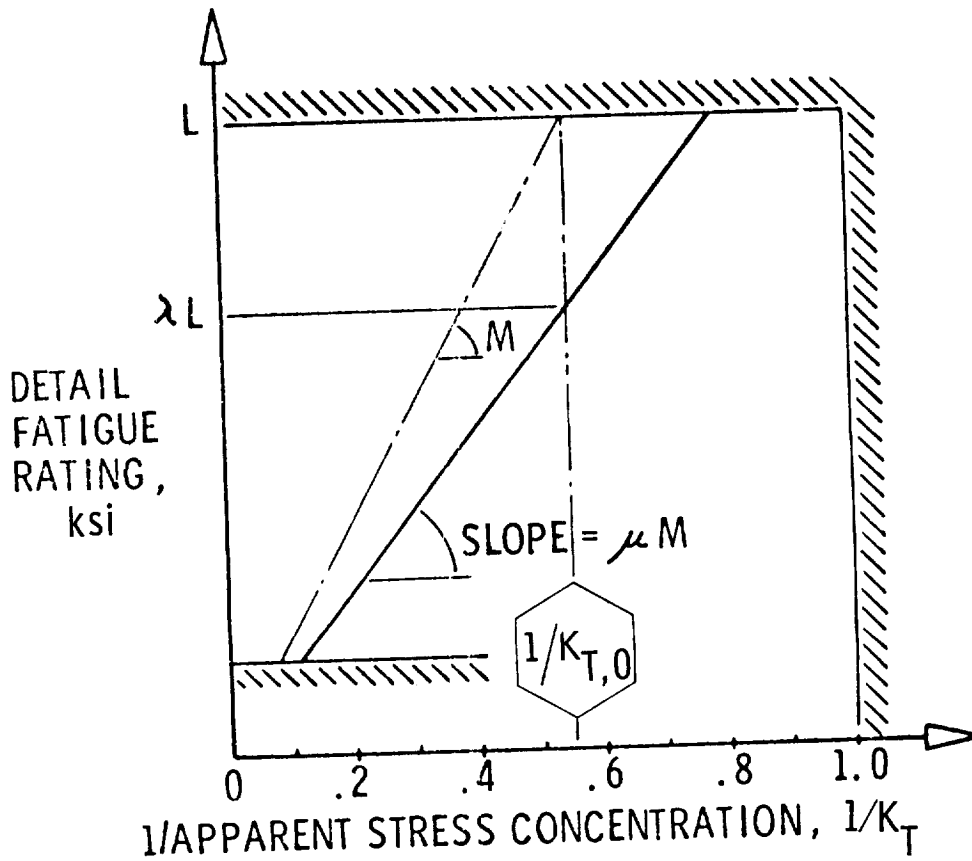


Figure 21.- Detail-fatigue-rating formulation.

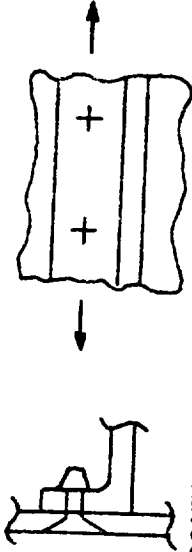
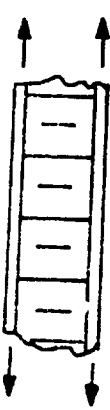

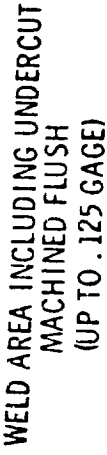

		DETAIL FATIGUE RATING, ksi	
 <p>CONTINUOUSLY ATTACHED STIFFENERS</p>	RIVET, HI-SQUEEZE INSTALLATION	65	
	RIVET, STANDARD INSTALLATION BOLT, "HI-LOK";	56	
	CLASS I FIT	46	
	TRANSITION FIT	50	
	INTERFERENCE FIT	54	
 <p>HONEYCOMB SANDWICH FACE SKINS</p>	"STRESSKIN"	53	
	ALUMINUM BRAZED	53	
 <p>BUTT-WELDED SKINS</p>	DIFFUSION BONDED C. P. CORE	55	
	DIFFUSION BONDED 3-2.5 CORE	65	
 <p>SURFACES AS WELDED (UP TO .063 GAGE)</p>	.016 GAGE FACE SKIN OVER .040 GAGE FACE SKIN	55	
		65	
 <p>WELD AREA INCLUDING UNDERCUT MACHINED FLUSH (UP TO .125 GAGE)</p>	<u>PROCESS</u>	<u>LOAD DIRECTION</u>	
		ELECTRON BEAM	LONGITUDINAL TRANSVERSE
	PLASMA ARC	LONGITUDINAL TRANSVERSE	65 55
	ELECTRON BEAM	LONGITUDINAL TRANSVERSE	65 65
	PLASMA ARC	LONGITUDINAL TRANSVERSE	65 65

Figure 22.- Typical detail fatigue ratings, basic structure.

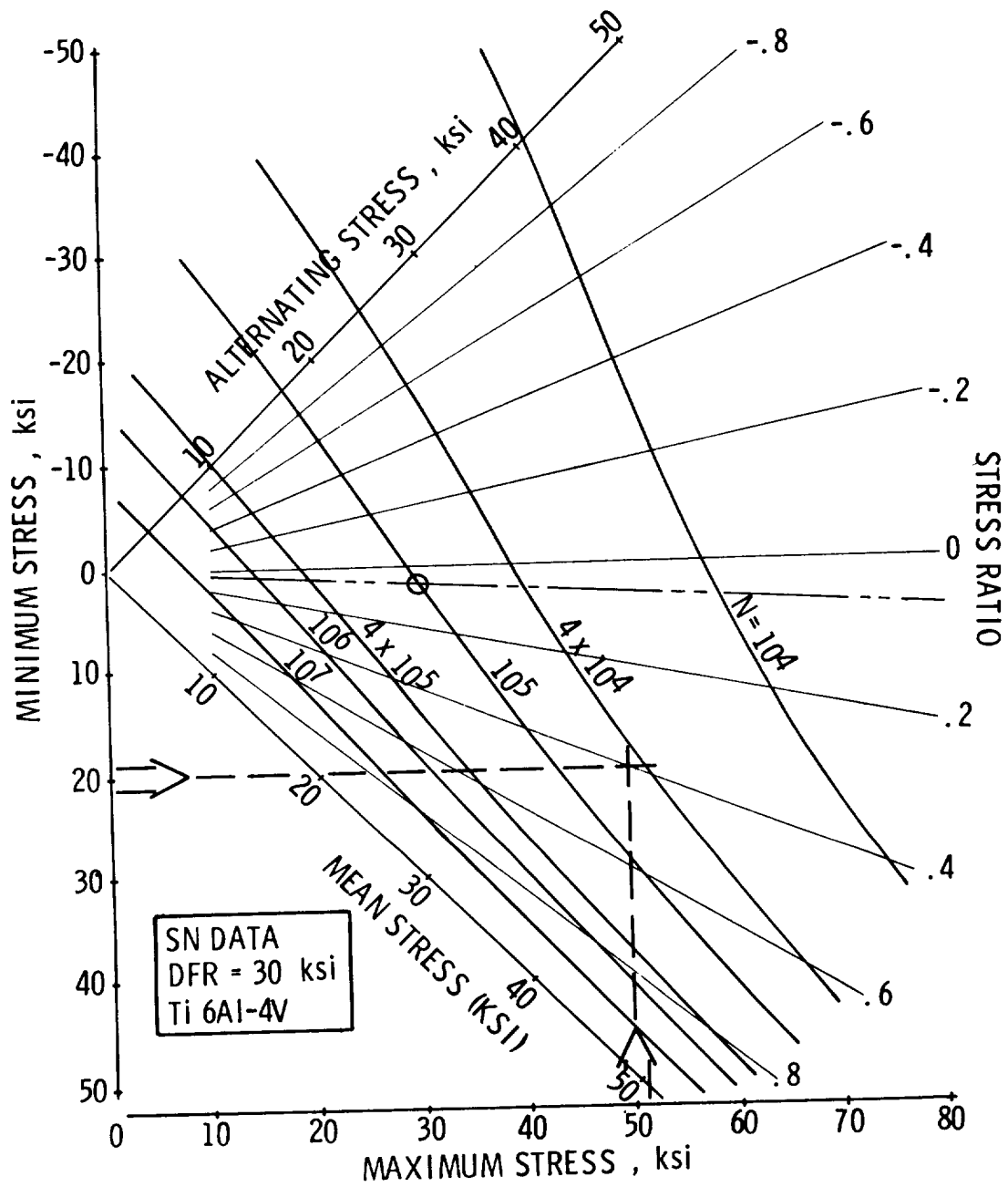


Figure 23.- Constant-life diagram for a component with DFR = 30 ksi.

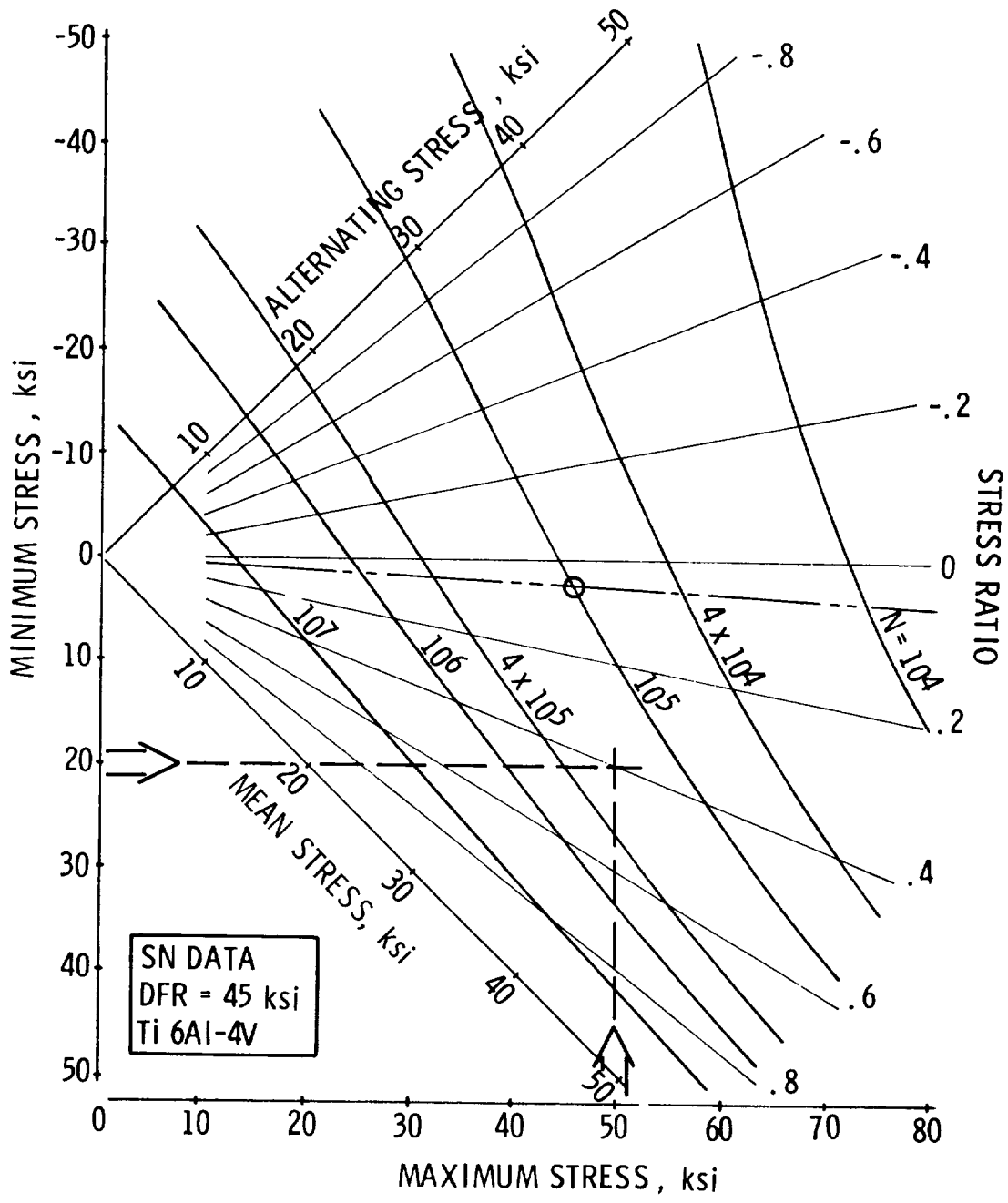


Figure 24.- Constant-life diagram for a component with DFR = 45 ksi.

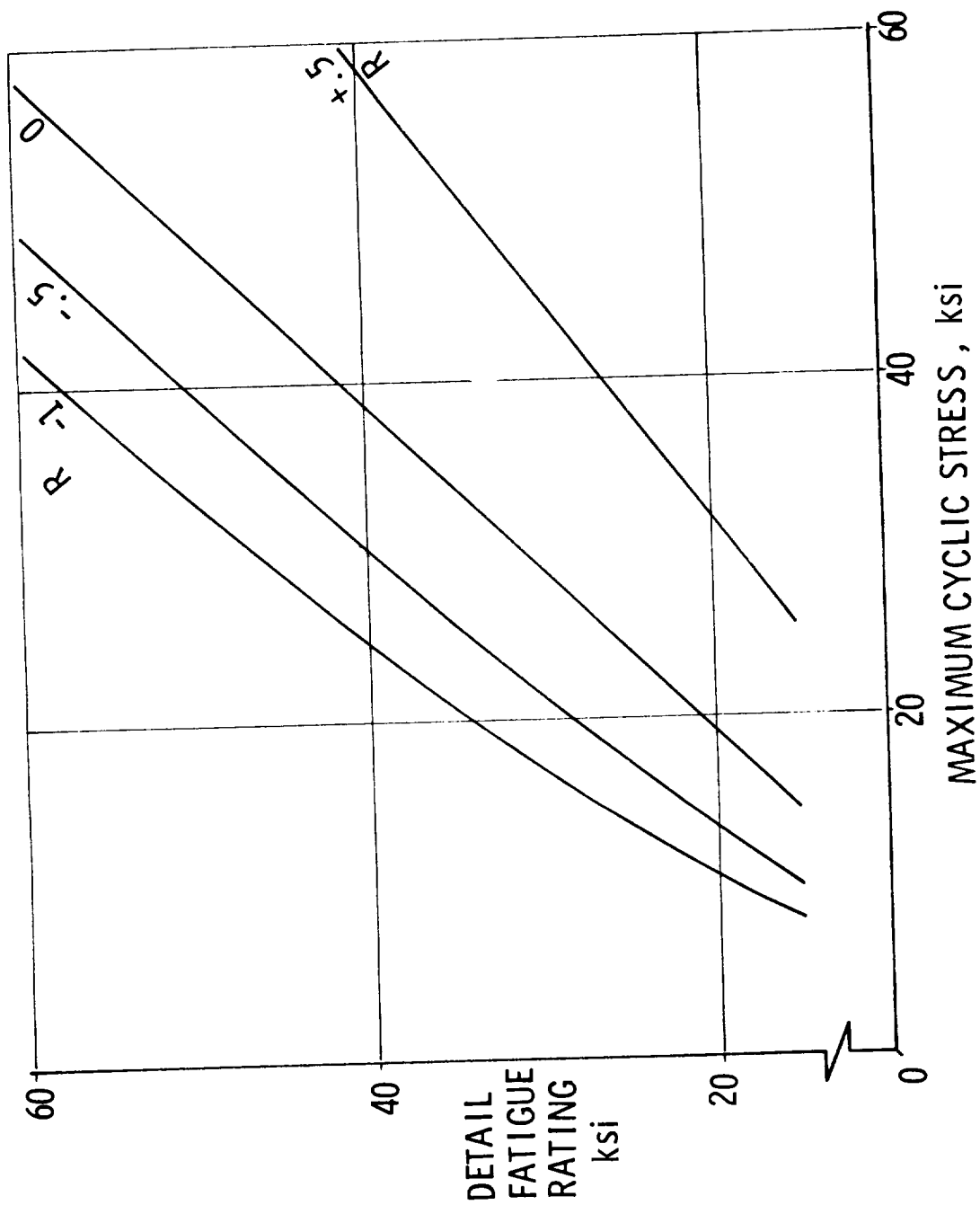


Figure 25.- Detail fatigue check at N = 100 000 cycles.

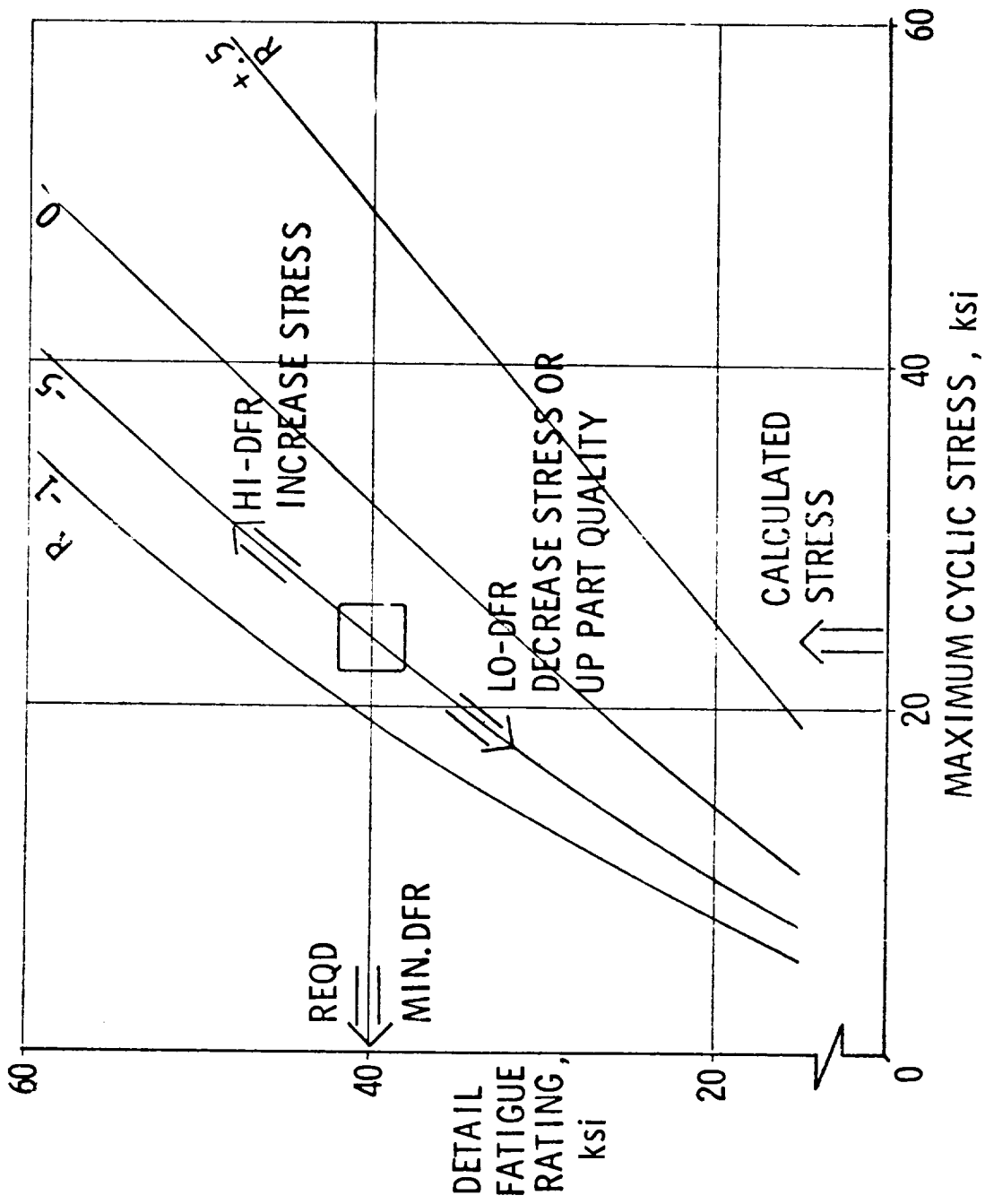


Figure 26.- Detail fatigue check at N = 200 000 cycles.

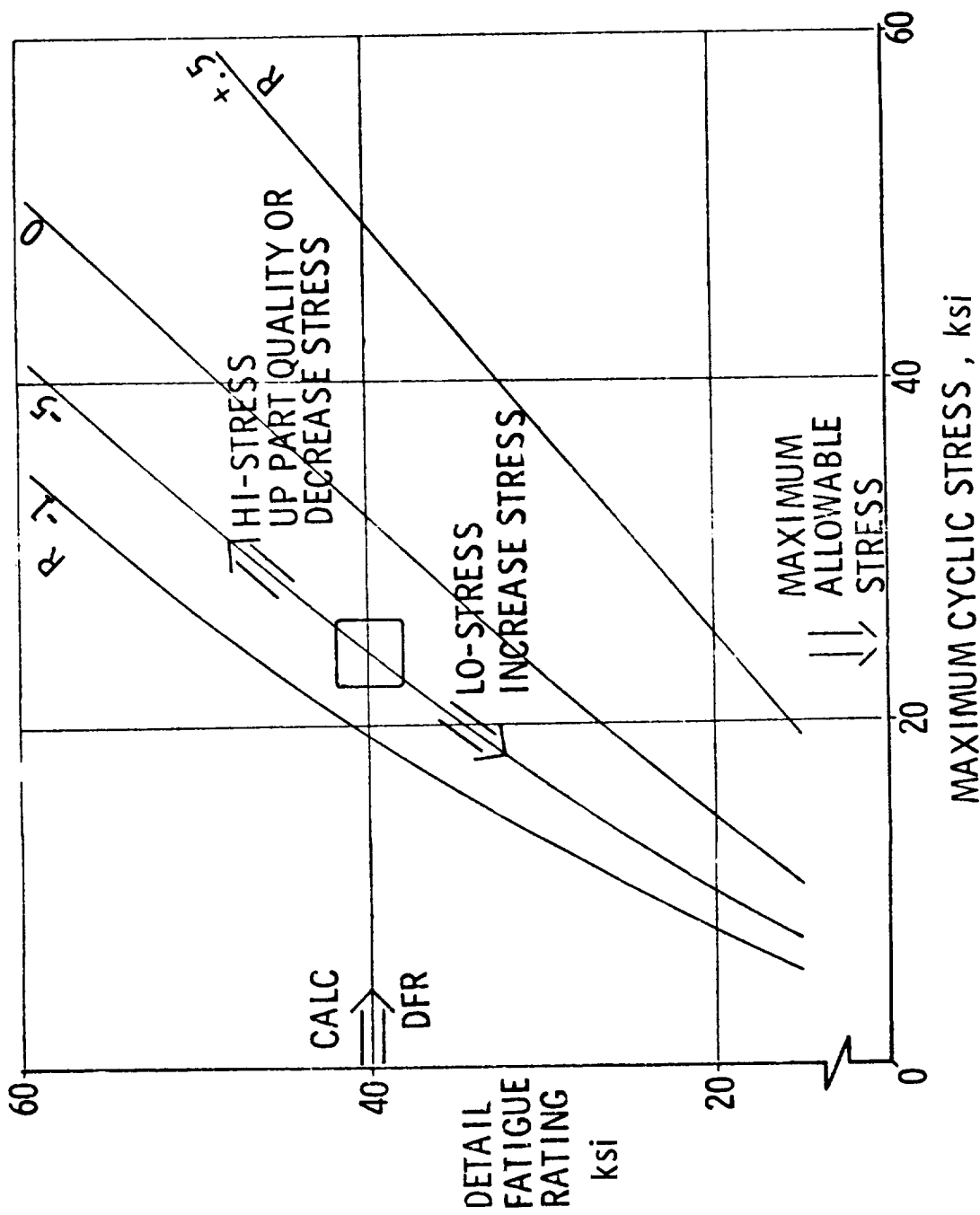


Figure 27.- Detail fatigue check at $N = 200\ 000$ cycles.

