



Strathprints Institutional Repository

Rawling, Michael and Tomkinson, Nick (2013) *Metal-free syn-dioxygenation of alkenes*. *Organic and Biomolecular Chemistry*, 11 (9). pp. 1434-1440. ISSN 1477-0520

Strathprints is designed to allow users to access the research output of the University of Strathclyde. Copyright © and Moral Rights for the papers on this site are retained by the individual authors and/or other copyright owners. You may not engage in further distribution of the material for any profitmaking activities or any commercial gain. You may freely distribute both the url (<http://strathprints.strath.ac.uk/>) and the content of this paper for research or study, educational, or not-for-profit purposes without prior permission or charge.

Any correspondence concerning this service should be sent to Strathprints administrator: <mailto:strathprints@strath.ac.uk>

Metal-free *syn*-dioxxygenation of alkenes

Michael J. Rawling and Nicholas C. O. Tomkinson*

Cite this: *Org. Biomol. Chem.*, 2013, **11**,
1434Received 9th December 2012,
Accepted 10th January 2013

DOI: 10.1039/c3ob27387c

www.rsc.org/obc

Reactions employing inexpensive reagents from sustainable sources and with low toxicity are becoming increasingly desirable from an academic and industrial perspective. A fascinating example of a synthetic transformation that requires development of alternative procedures is the osmium catalysed dihydroxylation. Recently there has been considerable interest in achieving this reaction through metal-free procedures. This review describes the methods available for metal-free *syn*-dioxxygenation of alkenes.

1 Introduction

The Sharpless asymmetric dihydroxylation is one of the most celebrated, influential and inspiring synthetic methods developed.¹ The broad substrate scope, high yields, exceptional levels of asymmetric induction, and convenient reaction conditions renders the process both robust and practical. Despite this success, the high cost and toxicity of osmium together with limited availability provide the impetus to develop new and alternative methods. In response to this requirement the community has delivered a number of transition-metal

catalysed processes but none have yet reached the gold-standard required.²

Along with transition-metal catalysed reactions there have been a number of recent successes in the development of metal-free methods. Although a general metal-free catalytic asymmetric alkene *syn*-dihydroxylation remains an elusive and attractive challenge a large body of work has been directed towards achieving this ultimate goal. This review outlines progress towards this target.

2 Peroxides

The use of organic peroxides for metal-free *syn*-dihydroxylation of alkenes has received much attention in recent years. The inherent high reactivity of peroxides together with their low cost and often non-toxic nature mean that reactions are

WestCHEM, Department of Pure and Applied Chemistry, Thomas Graham Building,
University of Strathclyde, 295 Cathedral Street, Glasgow, G1 1XL, UK.
E-mail: Nicholas.Tomkinson@strath.ac.uk; Fax: +44 (0) 141 5485743;
Tel: +44 (0) 141 5482276



Michael J. Rawling

Mike Rawling was born in Plymouth, England, UK in 1987. He studied Chemistry at The University of Sheffield where he was awarded an EPSRC Summer Vacation Bursary to carry out research under the supervision of Dr Simon Jones. He then completed his final year research project with Professor Nicholas Williams, receiving his MChem in 2009. An interest in organo-catalysis led him to undertake a PhD with Professor Nick Tomkin-

son at Cardiff University. This included a three-month placement at GlaxoSmithKline, Stevenage, UK, under the supervision of Matthew Campbell. He is now completing his PhD at The University of Strathclyde (2009–present).



Nicholas C. O. Tomkinson

Nick Tomkinson was born in St Andrews, Scotland in 1969. He studied Chemistry at The University of Sheffield and received his BSc in 1992 and PhD in 1996 under the supervision of Dr D. Neville Jones and Professor Jim Anderson. After postdoctoral studies with Dr Tim Willson at GlaxoSmithKline, Research Triangle Park, North Carolina (1996–1998), he was appointed to the staff at Cardiff University in 1999. In June 2011 he took up a position in the Department of Pure and Applied Chemistry at the University of Strathclyde. His research interests are centred on the development of practical synthetic methodology.

frequently efficient and allow for effective procedures that do not require the use of transition-metal catalysts to be developed.

2.1 Malonoyl peroxides

A promising area is the use of cyclic diacyl peroxides and in particular malonoyl peroxides.³ Cyclopropyl malonoyl peroxide **3** has been shown to be an effective reagent for the *syn*-dihydroxylation of a series of stabilised alkenes containing a wide range of functionality (22 examples) (Scheme 1).⁴ Treatment of an alkene with just 1.2 equivalents of peroxide **3** in the presence of 1 equivalent of water followed by basic hydrolysis leads to the corresponding *syn*-diol in excellent yield and very high levels of diastereoselectivity.

The proposed mechanistic course for the reaction is outlined in Scheme 2. Reaction of alkene **1** and peroxide **3** leads to **6** which undergoes ring closure, forming dioxonium **7**. Hydrolysis with the molecule of water necessary for reaction gives observed ester **9**. Basic hydrolysis of **9** affords diol **4** (86%) and diacid **10**, which can be recovered and converted into peroxide **3** in one simple synthetic step.

In a related study it was shown that the overall rate of this reaction could be controlled through modification of the peroxide structure.⁵ Although these reactions proceed with lower yield and stereoselectivity than reaction with cyclopropyl malonoyl peroxide **3** the ability to control the overall rate of reaction could have important implications in the development of a catalytic procedure.⁶

2.2 Phthaloyl peroxides

In a series of largely neglected reports,⁷ Greene showed that *trans*-stilbene **1** reacted with phthaloyl peroxide **11** to give two dioxygenated products **12** and **13** in a 1:3 ratio. Alkaline hydrolysis of **12** and **13** leads to (\pm)-hydrobenzoin **4** (Scheme 3).⁸ Significantly, this *syn*-dihydroxylation was shown to be stereospecific for the reaction of both *cis*- and *trans*-stilbene providing a powerful piece of synthetic methodology.

Greene did not develop this methodology further, presumably because of the explosive nature of the phthaloyl peroxide **11**. Siegel realised the potential of this method and recently reported on the improved reactivity of 3,4-dichlorophthaloyl peroxide **14** (20 examples) (Scheme 4).⁹

The reaction was simple to perform although elevated temperatures of 80 °C were required and **14** showed similar instability to **11**. 3,4-Dichlorophthaloyl peroxide **14** was shown to dihydroxylate a range of nucleophilic alkenes containing a

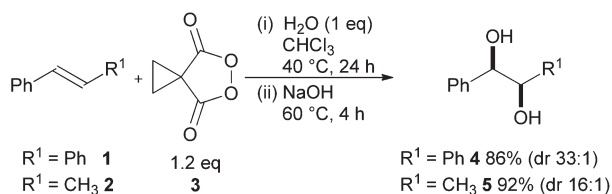

Scheme 1 Cyclopropyl malonoyl peroxide **3** mediated dihydroxylation.

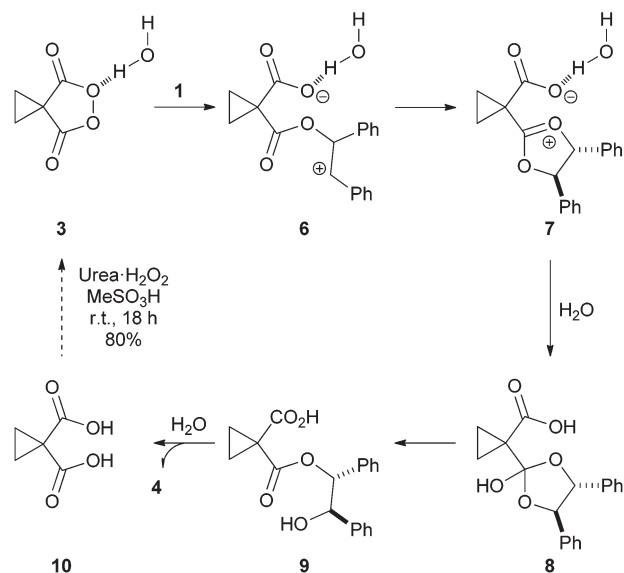

Scheme 2 Proposed pathway for the cyclopropyl malonoyl peroxide mediated dihydroxylation of stilbene.

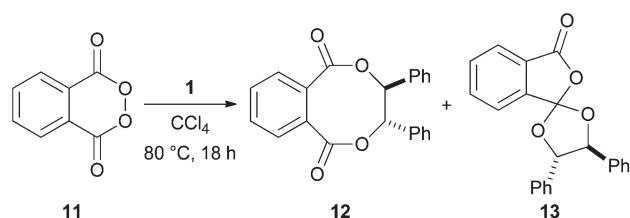

Scheme 3 Phthaloyl peroxide dioxygenation of stilbene **1**.

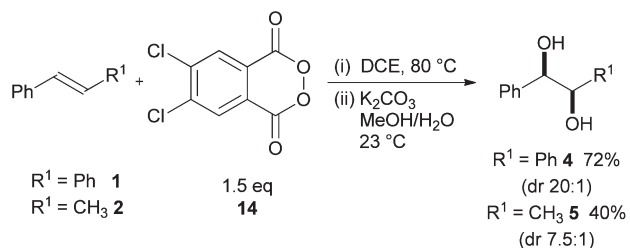

Scheme 4 3,4-Dichlorophthaloyl peroxide **14** dihydroxylation of alkenes.

variety of functionality with good diastereoselectivity. The reactions were frequently lower yielding and exhibited poorer diastereoselectivity when compared to cyclopropyl malonoyl peroxide **3** although the reaction of selected challenging aliphatic substrates was described.

2.3 Oxone

It is well established that Oxone is an effective reagent for the dihydroxylation of alkenes with *anti*-selectivity.¹⁰ De Kimpe and co-workers have described an unprecedented example of Oxone mediated *syn*-dioxygenation of mollugin **15** (Scheme 5).¹¹

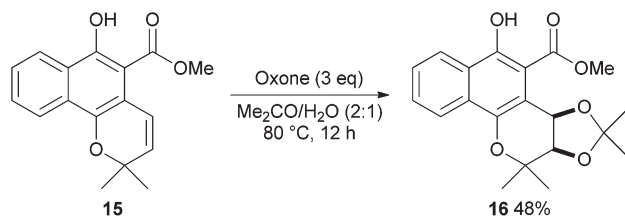

Scheme 5 Oxone mediated *syn*-dioxygenation of mollugin **15**.

Under specific conditions, mollugin **15** reacts with Oxone to produce *cis*-3,4-dihydroxymollugin acetonide **16** (48%) preferentially over the *trans* isomer. Protection of the phenol group in **15** prior to reaction leads to formation of the expected *trans*-diol illustrating that this method is highly substrate dependent. However, application of this method as a more general procedure for *syn*-dioxygenation presents significant opportunity.

3 Hypervalent iodine

Iodine reagents are attractive because of their low toxicity, ready availability and ease of handling and there have been a number of reviews on their applications in synthesis.¹² The use of hypervalent iodine compounds in the metal-free dioxygenation of alkenes has undergone a renaissance over recent years.

3.1 Achiral hypervalent iodine reagents

The first reported use of hypervalent iodine in the dioxygenation of alkenes was in 1939 when Criegee and Beucker showed that (diacetoxyiodo)arenes **17**, $\text{ArI}(\text{OAc})_2$, could be used in the *syn*-diacetoxylation of *trans*-anethole and cyclopentadiene.¹³ In the following 50 years, analogous *syn*-ditosyloxylation,¹⁴ *syn*-trifluoroacetoxylation¹⁵ and *syn*-methoxylation/perchlorination¹⁶ reactions have been described using alternative hypervalent iodine reagents **18–20** (Scheme 6).

The Woodward¹⁷ and Prévost¹⁸ reactions represent established methods for the *syn*- and *anti*-dihydroxylation of

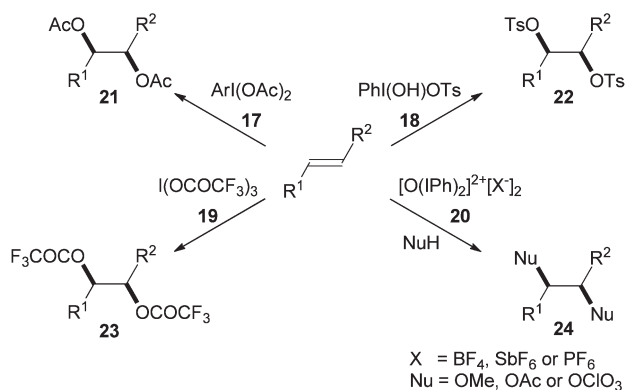

Scheme 6 Early examples of hypervalent iodine reagents in the dioxygenation of alkenes.

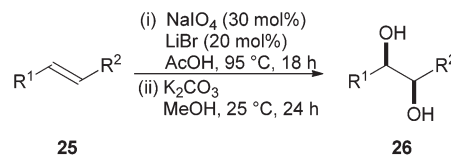

Scheme 7 Hypervalent iodine mediated Woodward–Prévost dihydroxylation.

alkenes respectively. A major drawback of these transformations is the requirement for a stoichiometric amount of silver salt. A synthetically useful alternative for *syn*-dihydroxylation was reported by Sudalai and co-workers in 2005¹⁹ using NaIO_4 as the oxidant (Scheme 7). Reaction of an alkene **25** with catalytic amounts of lithium bromide using sodium periodate or (diacetoxyiodo)benzene as the oxidant in wet acetic acid gives the *syn*-diol **26** in high yield after basic hydrolysis (21 examples).

Mechanistically it was proposed that Br_2 , generated *in situ* by oxidation of lithium bromide, brings about the bromoacetoxylation of alkenes *via* bromonium ion **27** to give the *trans*-1,2-bromoacetate derivative **28**. Intramolecular cyclisation gives 1,3-dioxolan-2-yl cation **29**, which is hydrolysed (H_2O) to give *syn*-hydroxy acetate **30** (Scheme 8). Interestingly, reaction in dry acetic acid leads to the *trans*-diacetate **31**.

The reaction works well for electron rich and electron deficient alkenes (21 examples), leading to the corresponding *syn*-diols in excellent yield and good diastereoselectivity. The reaction is simple to perform and all reagents are commercially available but the elevated reaction temperature (95 °C) and the solvent (acetic acid) mean the process is not suitable for more sensitive substrates.

Further improvement to this protocol was reported by Li and co-workers who addressed the issue of high temperature by employing $\text{PhI}(\text{OAc})_2$ in the presence of $\text{BF}_3 \cdot \text{OEt}_2$ ²⁰ resulting in a scalable, convenient and practical procedure for the

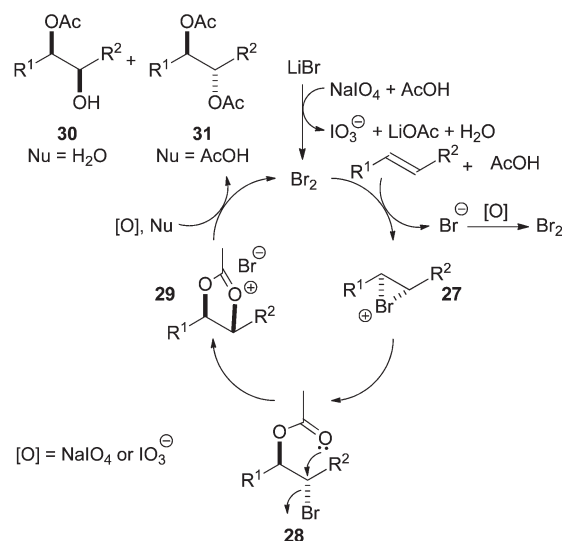

Scheme 8 Proposed catalytic cycle for hypervalent iodine mediated Woodward–Prévost dihydroxylation.

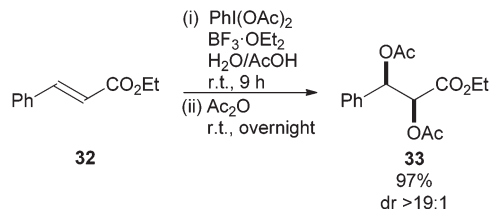

Scheme 9 $\text{BF}_3\cdot\text{OEt}_2$ catalysed diacetoxylation of alkenes with PhI(OAc)_2 .

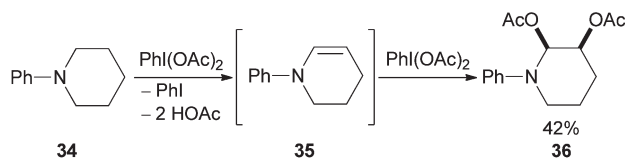

Scheme 10 Selective functionalisation of amines with PhI(OAc)_2 .

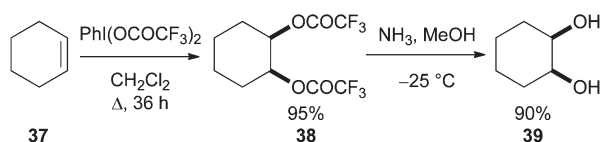

Scheme 11 Alkene dihydroxylation using $\text{PhI(OCOCF}_3)_2$.

diastereoselective *syn*-diacetoxylation of alkenes (19 examples). Interestingly, the reaction was also effective for electron deficient alkenes. For example, ethyl cinnamate **32** gave the *syn*-dioxxygenation product **33** in 97% yield and >19 : 1 diastereoselectivity (Scheme 9).

The reaction proved general for a range of alkenes producing the corresponding *syn*-diacetates in good to excellent yield and diastereoselectivity when wet acetic acid was used as the solvent. It was proposed that $\text{BF}_3\cdot\text{OEt}_2$ activated PhI(OAc)_2 through a Lewis acid coordination pathway. However, Gade²¹ demonstrated that protons can catalyse dioxxygenations when using PhI(OAc)_2 as the oxidant, so it is also possible that a strong Brønsted acid produced by the $\text{BF}_3\cdot\text{OEt}_2/\text{AcOH}$ could also be responsible for catalysis. The possibility of preparing the *anti*-diacetate by performing the reaction in a mixture of $\text{AcOH-Ac}_2\text{O}$ further enhances the appeal of this reaction sequence.

An interesting extension to the use of (diacetoxyiodo)-benzene in the *syn*-dioxxygenation of alkenes comes from the reaction of amines (12 examples).²² For example, PhI(OAc)_2 mediated oxidation of *N*-phenylpiperidine **34** gives the corresponding enamine **35** which is dioxxygenated *in situ* to give **36** in 42% yield (Scheme 10). Although 2.2 equivalents of oxidant are required, the potential to expand the scope of this transformation further is significant.

Çelik²³ reported that alkene *syn*-dioxxygenation can be achieved using the more reactive phenyliodine(III) bis(trifluoroacetate) in the absence of additive or catalyst (Scheme 11). Although the examples reported were limited and functional group tolerance was not explored the overall transformation

clearly has potential for development, particularly for substrates not tolerant of the acidic Woodward–Prévost conditions described above.

3.2 Chiral hypervalent iodine reagents

Although there is significant precedent for the use of stoichiometric chiral hypervalent iodine reagents in synthesis, it is only recently that application of this knowledge to alkene dihydroxylation has been described. Fujita reported an asymmetric variant of the Woodward and Prévost reactions using optically active hypervalent iodine reagents **40–43** (Scheme 12).^{24,25}

Reaction of alkene **44** with hypervalent iodine reagent **41** (1.2 equivalents) at -80°C , quenching with water at -40°C (Conditions A) gave a mixture of hydroxyacetate products **45** and **46** which were directly acetylated to give **47** (dr > 98 : 2, 95% ee) (Scheme 12). In an additional experiment it was shown that enantioselectivity could be switched by performing the reaction at -80°C in the presence of TMSOAc, followed by quenching at room temperature (Conditions B) (Scheme 13).

Although the ee's observed with these reagents are lower than would be expected by contemporary standards, the ability to alter both stereoselectivity and enantioselectivity simply by altering reaction conditions is particularly exciting and bodes

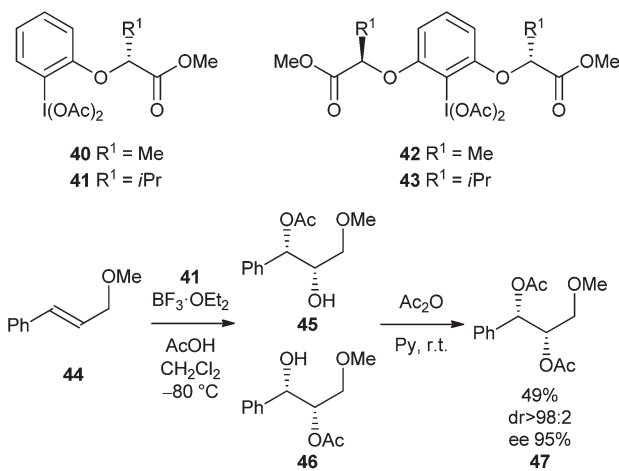

Scheme 12 Enantioselective alkene dioxxygenation.

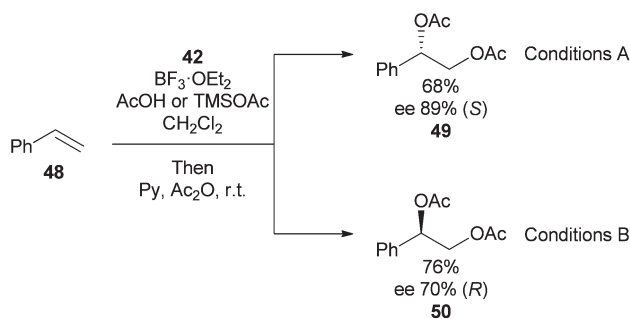

Scheme 13 Switching enantioselectivity in the dihydroxylation of styrene.

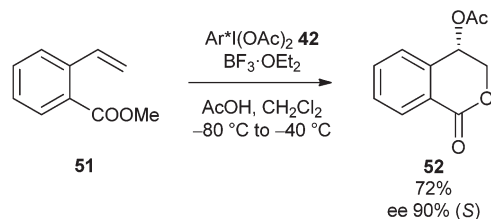

Scheme 14 Enantioselective acetoxylation.

well for further development in the area of alkene dioxygenation using hypervalent iodine reagents.

More recently Fujita has gone on to show that chiral hypervalent iodine reagent **42** can also be used in the enantioselective oxylation of methyl *ortho*-alk-1-enylbenzoate **51** in 90% ee (Scheme 14).²⁶

3.3 Catalytic hypervalent iodine reagents

Over recent years, a significant understanding of how to use sub-stoichiometric amounts of hypervalent iodine reagents has emerged.²⁷ This knowledge has been applied by Li and co-workers to the alkene dihydroxylation described above (Scheme 9) providing an effective organocatalytic alkene dihydroxylation.²⁸ Treatment of an alkene **25** with 0.2 equivalents of the aryl iodide **53** in the presence of either hydrogen peroxide or *m*CPBA as the stoichiometric oxidant followed by direct acetylation of the product leads to **54** (Scheme 15). Although functional group tolerance was not widely explored within this work, the 25 examples reported suggest the method has outstanding potential and the development of a catalytic asymmetric protocol should soon be forthcoming.

4 Selenium

4.1 Selenium dioxide

The use of selenium reagents in the *syn*-dioxygenation of alkenes was first reported by Tsutsumi and co-workers whilst they were investigating the acid-catalysed oxidation of alkenes.²⁹ They described the stereoselective oxidation of *cis*-but-2-ene **55** and *trans*-but-2-ene **57** to give the diacetates **56** and **58** respectively as the major reaction products, along with small amounts of the corresponding *syn*-monoacetates (<5%) (Scheme 16). Although yields of the products were low, the mild conditions and high selectivity provide an excellent starting point for those wishing to develop this transformation further.

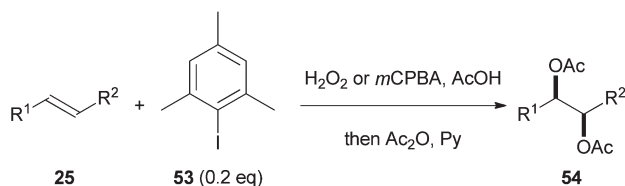

Scheme 15 Organocatalytic diacetoxylation of alkenes.

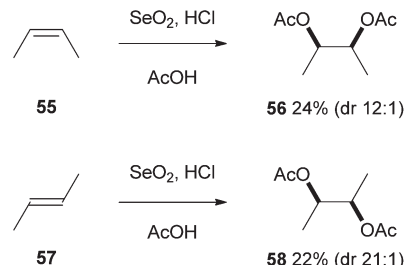
Scheme 16 Selenium dioxide mediated *syn*-diacetoxylation.

More recent reports by Nguyen and Lee examined selenium dioxide in the dioxygenation of diene substrates to prepare both 1,2- and 1,4-diols.³⁰ Once again this methodology has not been significantly developed suggesting that oxidation reactions with selenium dioxide may have a high substrate dependence and lack of generality.

4.2 Diaryl diselenide

A more general selenium-mediated dihydroxylation method was published by Tiecco in 2008. This report contained the first example of a diphenyl diselenide catalysed dihydroxylation of alkenes using ammonium persulphate or hydrogen peroxide as the stoichiometric oxidant (Scheme 17).³¹

It was proposed that this one-pot procedure occurred by oxidation of diphenyl diselenide **62** to perseleninic acid **64**, which epoxidised the alkene substrate giving **65**. S_N2 ring-opening of **65** by a molecule of water leads to the *anti*-diol **68** (Path B). S_N1 ring-opening of **65** (Path A) provided both the *syn* (**67**) and *anti* (**68**) diols. It was rationalised that hydrogen bonding between the water molecule and the hydroxyl group of intermediate **66** was responsible for the preferential *syn*-addition of the water molecule with selected substrates (Scheme 18).

Despite the reaction proceeding in good yield, none of the substrates reported contained functionality suggesting the reaction may have limited scope. Further drawbacks of this method include long reaction times (up to 12 days) and the poor stereoselectivities observed. Nevertheless this represents a novel catalytic process for the *syn*-dihydroxylation of alkenes.

4.3 Chiral diaryl diselenide

Significantly, Tiecco went on to show that use of chiral diselenide **69** in the reaction with 1-phenyl cyclohexene **59** gave the *syn*-diol **60** in an excellent 92% ee (Scheme 19). This is a particularly significant result in the field of dihydroxylation although substrate scope appears to be limited from the examples reported.³²

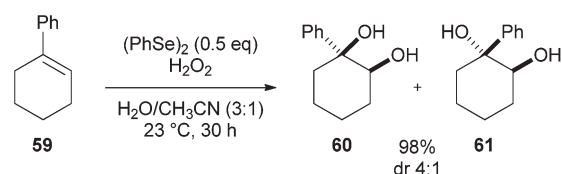

Scheme 17 Diphenyl diselenide catalysed dihydroxylation.

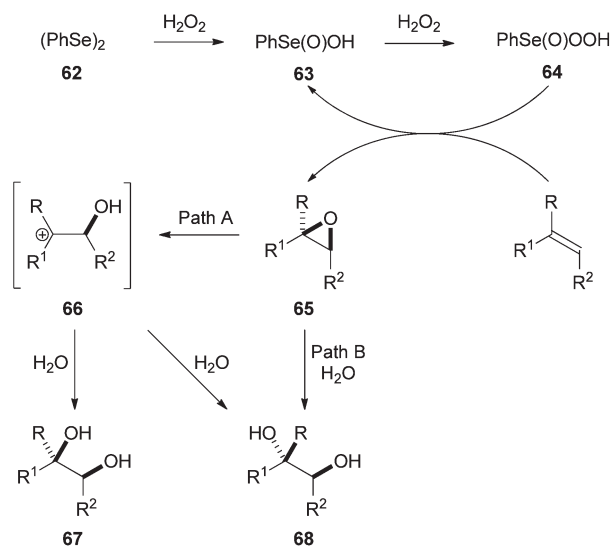

Scheme 18 Proposed mechanism for the diphenyl diselenide catalysed dihydroxylation.

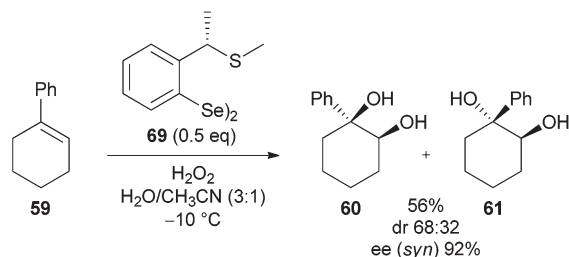

Scheme 19 Catalytic asymmetric dihydroxylation using chiral diselenide.

Organoselenium compounds clearly have great potential as convenient *syn*-dihydroxylation reagents but important mechanistic understanding and incorporation of functionality into substrates is required before a general protocol is established.

5 Sulphur

The use of sulphur in alkene *syn*-dihydroxylation is rare but an exciting report by Yoshida suggests that this area has potential for development. The method involves an oxidative *syn*-dihydroxylation mediated by electrochemically generated alkoxy-sulfonium ions (Scheme 20).³³ Five stabilised alkenes were oxidised in the presence of DMSO to give bisalkoxy-sulfonium ions **70** which underwent rapid hydrolysis with aqueous sodium hydroxide to afford the corresponding diols in good yield (52–86%). It was proposed that preference for *syn*-addition arises from sulfonium ion directed attack of the second molecule of DMSO on **70** to give **71**. Although electrochemical dioxygenation of alkenes has been known for some time,³⁴ this represents the first example of a direct electrochemical dihydroxylation of alkenes. Expanding the substrate

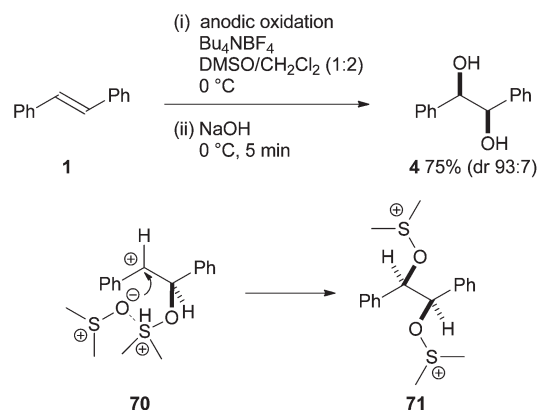

Scheme 20 Electrochemical *syn*-dihydroxylation.

scope beyond stabilised alkenes and improving diastereoselectivity would increase the significance of this work.

6 Conclusions

Recent years have seen a substantial amount of activity in the area of metal-free *syn*-dioxygenation of alkenes. This review has highlighted advances using peroxides, hypervalent iodine, selenium and sulphur as vehicles to deliver the oxygen atoms to the alkene. Whilst significant strides have been made, the bench-mark for alkene dihydroxylation, the osmium catalysed Upjohn procedure³⁵ and its asymmetric version developed by Sharpless¹ are truly outstanding synthetic procedures that represent the gold-standard for synthetic transformations when considering scope, selectivity, yield and versatility. With such formidable precedent, it is an exciting time for the metal-free methods being developed where catalytic and asymmetric variants are starting to be described. Further understanding of mechanism, reactivity and scope will be central to advancement in this area to address the pressing needs for this pivotal and industrially relevant transformation.

Notes and references

- H. C. Kolb, M. S. VanNieuwenhze and K. B. Sharpless, *Chem. Rev.*, 1994, **94**, 2483.
- For a recent review on osmium-free *syn*-dihydroxylation see: C. J. R. Bataille and T. J. Donohoe, *Chem. Soc. Rev.*, 2011, **40**, 114.
- M. Schwarz and O. Reiser, *Angew. Chem., Int. Ed.*, 2011, **50**, 10495.
- J. C. Griffith, K. M. Jones, S. Picon, M. J. Rawling, B. M. Kariuki, M. Campbell and N. C. O. Tomkinson, *J. Am. Chem. Soc.*, 2010, **132**, 14409.
- K. M. Jones and N. C. O. Tomkinson, *J. Org. Chem.*, 2012, **77**, 921.
- S. Picon, M. Rawling, M. Campbell and N. C. O. Tomkinson, *Org. Lett.*, 2012, **14**, 6250.

- 7 F. D. Greene, *J. Am. Chem. Soc.*, 1956, **78**, 2246; F. D. Greene, *J. Am. Chem. Soc.*, 1956, **78**, 2250; F. D. Greene and W. W. Rees, *J. Am. Chem. Soc.*, 1958, **80**, 3432; F. D. Greene, *J. Am. Chem. Soc.*, 1959, **81**, 1503; F. D. Greene and W. W. Rees, *J. Am. Chem. Soc.*, 1960, **82**, 890; F. D. Greene and W. W. Rees, *J. Am. Chem. Soc.*, 1960, **82**, 893.
- 8 A. Tadokoro, T. Takata and T. Endo, *Macromolecules*, 1993, **26**, 2388.
- 9 C. Yuan, A. Axelrod, M. Varela, L. Danysh and D. Siegel, *Tetrahedron Lett.*, 2011, **52**, 2540.
- 10 W. Zhu and W. T. Ford, *J. Org. Chem.*, 1991, **56**, 7022; S. Rani and Y. D. Vankar, *Tetrahedron Lett.*, 2003, **44**, 907.
- 11 N. V. S. Mudiganti, S. Claessens, P. Habonimana and N. De Kimpe, *J. Org. Chem.*, 2008, **73**, 3867.
- 12 T. Wirth, *Angew. Chem., Int. Ed.*, 2005, **44**, 3656; H. Liang and M. A. Ciufolini, *Angew. Chem., Int. Ed.*, 2011, **50**, 11849; L. F. Silva, Jr. and B. Olofsson, *Nat. Prod. Rep.*, 2011, **28**, 1722.
- 13 R. Criegee and H. Beucker, *Justus Liebigs Ann. Chem.*, 1939, **541**, 218.
- 14 L. Rebrovic and G. F. Koser, *J. Org. Chem.*, 1984, **49**, 2462.
- 15 J. Buddrus, *Angew. Chem., Int. Ed. Engl.*, 1973, **12**, 163; J. Buddrus and H. Plettenberg, *Chem. Ber.*, 1980, **113**, 1494.
- 16 V. V. Zhdankin, R. Tykwinski, B. Berglund, M. Mullikin, R. Caple, N. S. Zefirov and A. S. Koz'min, *J. Org. Chem.*, 1989, **54**, 2609.
- 17 R. B. Woodward and F. V. Brutcher, Jr., *J. Am. Chem. Soc.*, 1958, **80**, 209.
- 18 C. Prevost, *Compt. Rend.*, 1933, **196**, 1129; C. Prevost, *Compt. Rend.*, 1933, **197**, 1661; C. Prevost and J. Wiemann, *Compt. Rend.*, 1937, **204**, 700.
- 19 L. Emmanuvel, T. M. A. Shaikh and A. Sudalai, *Org. Lett.*, 2005, **7**, 5071.
- 20 W. Zhong, J. Yang, X. Meng and Z. Li, *J. Org. Chem.*, 2011, **76**, 9997.
- 21 Y.-B. Kang and L. H. Gade, *J. Am. Chem. Soc.*, 2011, **133**, 3658.
- 22 X.-Z. Shu, X.-F. Xia, Y.-F. Yang, K.-G. Ji, X.-Y. Liu and Y.-M. Liang, *J. Org. Chem.*, 2009, **74**, 7464.
- 23 M. Çelik, C. Alp, B. Coşkun, M. S. Gültekin and M. Balci, *Tetrahedron Lett.*, 2006, **47**, 3659.
- 24 M. Fujita, M. Wakita and T. Sugimura, *Chem. Commun.*, 2011, **47**, 3983. Diastereoselective Prévost and Woodward reactions of chiral alkene substrates have been reported, see: J. H. Kim, M. J. C. Long, J. Y. Kim and K. H. Park, *Org. Lett.*, 2004, **6**, 2273; J. H. Kim, M. J. Curtis-Long, W. D. Seo, Y. B. Ryu, M. S. Yang and K. H. Park, *J. Org. Chem.*, 2005, **70**, 4082; A. D'Alfonso, M. Pasi, A. Porta, G. Zanoni and G. Vidari, *Org. Lett.*, 2010, **12**, 596.
- 25 The use of chiral hypervalent iodine reagents in the dioxygenation of styrene was first reported by Wirth *et al.*, but low enantioselectivity was observed. See: T. Wirth and U. H. Hirt, *Tetrahedron: Asymmetry*, 1997, **8**, 23; U. H. Hirt, B. Spingler and T. Wirth, *J. Org. Chem.*, 1998, **63**, 7674; U. H. Hirt, M. F. H. Schuster, A. N. French, O. G. Wiest and T. Wirth, *Eur. J. Org. Chem.*, 2001, 1569.
- 26 M. Fujita, Y. Yoshida, K. Miyata, A. Wakisaka and T. Sugimura, *Angew. Chem., Int. Ed.*, 2010, **49**, 7068. For analogous asymmetric cycloetherification reactions, see: M. Fujita, S. Okuno, H. J. Lee, T. Sugimura and T. Okuyama, *Tetrahedron Lett.*, 2007, **48**, 8691; M. Fujita, Y. Ookubo and T. Sugimura, *Tetrahedron Lett.*, 2009, **50**, 1298.
- 27 R. D. Richardson and T. Wirth, *Angew. Chem., Int. Ed.*, 2006, **45**, 4402; T. Dohi and Y. Kita, *Chem. Commun.*, 2009, 2073; F. C. Kuepper, M. C. Feiters, B. Olofsson, T. Kaiho, S. Yanagida, M. B. Zimmermann, L. J. Carpenter, G. W. Luther, Z. Lu, M. Jonsson and L. Kloo, *Angew. Chem., Int. Ed.*, 2011, **50**, 11598; M. S. Yusubov and V. V. Zhdankin, *Curr. Org. Synth.*, 2012, **9**, 247.
- 28 W. Zhong, S. Liu, J. Yang, X. Meng and Z. Li, *Org. Lett.*, 2012, **14**, 3336.
- 29 K. A. Javaid, N. Sonoda and S. Tsutsumi, *Tetrahedron Lett.*, 1969, **10**, 4439; K. A. Javaid, N. Sonoda and S. Tsutsumi, *Bull. Chem. Soc. Jpn.*, 1970, **43**, 3475; N. Sonoda, S. Furui, K. A. Javaid and S. Tsutsumi, *Ann. N. Y. Acad. Sci.*, 1972, **192**, 49.
- 30 T. M. Nguyen and D. Lee, *Org. Lett.*, 2001, **3**, 3161.
- 31 C. Santi, M. Tiecco, L. Testaferri, C. Tomassini, S. Santoro and G. Bizzoca, *Phosphorus, Sulfur Silicon Relat. Elem.*, 2008, **183**, 956; S. Santoro, C. Santi, M. Sabatini, L. Testaferri and M. Tiecco, *Adv. Synth. Catal.*, 2008, **350**, 2881.
- 32 We are grateful to a reviewer who suggested that a limitation is oxidation of the sulphur atoms in the catalyst. Further developments using diselenide catalysts in an anti-dioxygenation have recently been reported, see: C. Santi, R. Di Lorenzo, C. Tidei, L. Bagnoli and T. Wirth, *Tetrahedron*, 2012, **68**, 10530.
- 33 Y. Ashikari, T. Nokami and J.-I. Yoshida, *Org. Lett.*, 2012, **14**, 938.
- 34 K. Koyama, T. Ebara, T. Tani and S. Tsutsumi, *Can. J. Chem.*, 1969, **47**, 2484.
- 35 V. VanRheenen, R. C. Kelly and D. Y. Cha, *Tetrahedron Lett.*, 1976, **17**, 1973.