

The 4-H Health and Sanitation Project

4-H CLUB CIRCULAR 36

COLUMBIA, MO.

REVISED JANUARY, 1940



COOPERATIVE EXTENSION WORK IN AGRICULTURE AND HOME ECONOMICS

UNIVERSITY OF MISSOURI COLLEGE OF AGRICULTURE AND THE UNITED
STATES DEPARTMENT OF AGRICULTURE COOPERATING

J. W. BURCH, Director, Agricultural Extension Service
Distributed in furtherance of the Acts of Congress of May 8, and June 30, 1914.

TABLE OF CONTENTS*

	Page
Introduction -----	3
Water -----	5
Water for Health -----	5
Dangers of Impure Water -----	5
Pure Water Supply -----	5
Springs -----	5
Construction of Wells and Cisterns -----	6
School Supply -----	6
Common Drinking Cup -----	6
Analysis -----	7
Methods of Making Safe -----	7
Wastes -----	8
Rubbish -----	8
Garbage Disposal -----	8
Disposal of Water -----	10
Disposal of Human Wastes -----	10
School Sewage Disposal -----	12
Ventilation -----	13
Moisture -----	13
Ventilators -----	14
Temperature -----	15
Milk -----	15
Importance in Diet -----	15
Production of Clean Milk -----	15
Pasteurization -----	18
Insects and Vermin -----	18
Fly Control -----	20
Fly Sprays -----	20
Fly Traps -----	21
Mosquito Control -----	23
Roaches and Their Control -----	24
Bedbugs and Their Control -----	25
Fleas -----	26
Rats, Prevention and Control -----	27
Mice -----	29
Ants -----	29
Project Objectives -----	30

*The 4-H Health and Sanitation Leader's Guide is to be used with this circular.

The 4-H Health and Sanitation Project*

OUR HEALTH, THE WEALTH WE KEEP AND SHARE†

Good health makes it possible for us and our friends to be happy. We can practice health habits and in this way do much to keep ourselves in good health. We must also have healthful conditions in our homes, schools and communities. Keeping our surroundings in the proper condition is known as sanitation. In this project we will consider the things about us which help us to care for our own and our neighbors' health.

Heating, lighting, ventilation, vermin control, protection of foods, control of flies and other insects, purity of water supply, and the disposal of wastes are some of the subjects included in sanitation. Of these, a pure water supply and the proper disposal of wastes are by far the most important for health.

When we think of environment it is necessary to remember that each person lives a continuous life and is influenced by the surroundings met at each moment of life, whether in the home, school, church, place of business or entertainment, or on the highways; whether walking, riding or standing still; playing, working, or studying.

Some persons are particular about the inside of their houses but neglect their yards, sheds, stables, etc.; and some are careful about their entire home places and forget that school and community conditions may be dangerous to their health and even to their lives.

Good housekeeping practices promote sanitation. A high degree of general cleanliness is an important factor, both inside and outside the house, and should include consideration of stables and similar buildings and their surroundings. Chickens and stock should be kept out of the house yard. The same measures should be rigidly applied to schools, churches, stores, theaters, and other public buildings and their surroundings. Roads, streets, and vacant lots should receive attention.

The purpose of the Health and Sanitation Project is to assist each club member to attain and maintain his or her own best possible condition of health, and to acquire a "health responsibility" in relation to home, school, and community welfare.

*Revised by May Sontag, State Club Agent, from the circular originally prepared by Miss Mary E. Stebbins, formerly Extension Specialist in Health. Reviewed and approved by Miss Louise Hilligas, Superintendent of University Hospitals.

†From "Song of Health"—Buchanan-Parish.

Each club member should make an inventory of his health and then follow the health rules and try to attain or maintain his best health.

Health Inventory

- Is my skin clear, clean and either pink or tanned? -----
 Is my hair smooth and glossy? -----
 Are my eyes bright and sparkling? -----
 Is my tongue clean and pink? -----
 Can I breath clearly through each nostril? -----
 Do I hear equally well with each ear? -----
 Are my muscles well developed and firm? -----
 Is my chest broad and useful for breathing? -----
 Is my back straight and are my shoulder blades flat? -----
 Is my posture erect and can I easily keep myself erect when walking
 and sitting? -----
 Is my step elastic and light? -----
 Can I play hard or work hard without too much "tired feeling"? --
 Have I a "clean, quick mind in a clean, strong body"? -----

Health Rules

1. Brush teeth each morning and night.
2. Wash the hands before eating.*
3. Take a full bath at least twice a week.
4. Have a natural bowel movement daily.
5. Drink at least six glasses of water each day.
6. Eat some fruit and green vegetables each day.
7. Drink milk; one quart a day is desirable.
8. Play or exercise out doors each day.
9. Sleep long hours in open air or with windows open.
 - 10-12 years—12 hours sleep needed.
 - 12-14 years—11 hours sleep needed.
 - 14-18 years—10 hours sleep needed.

Additional Suggestions

1. If possible, have a thorough physical examination by a physician.
2. Correct physical defects, if they are found.
3. Eat meals at regular hours.
4. Chew thoroughly.
5. Eat no sweets between meals.
6. Wear low-heeled, comfortable shoes.
7. Stand and walk properly—chest up, chin in, abdomen in.
8. Wash hands before meals, using own towel.

*A "common towel" should not be used in the home or school room for drying the hands. Paper towels are so inexpensive that these should be used in schools.

WATER

“Pure water externally, internally, eternally”.

A supply of pure water is of the utmost importance not only because water is the natural drink of man, but because of the dangers to health arising from an impure supply. It is used for so many purposes that the source of supply, well or cistern, should be conveniently located. Inside water systems can be installed in rural homes at very little expense, usually covered by the cost of materials only.

Water for Health—Human beings, in fact, all animals, require large quantities of water. The body may live for weeks without food if a liberal amount of fluids is provided, but will die very soon if no fluids at all are given. Large quantities of pure water taken daily will help to keep the body fit and will prevent many disagreeable conditions.

It is necessary to know that the water used is pure and that the water supply is so protected that no surface drainage or seepage can get into it.

Dangers of Impure Water.—The germs of certain diseases, such as typhoid fever, diarrhea, dysentery, cholera, and summer complaint are able to live in water for some time. These are all intestinal diseases and may get into the drinking water supply if rains wash over the ground or sink into the ground and then drain or seep into the well or cistern, carrying in the disease germs which have gotten on or into the soil. If water containing these germs is used, the persons using it may become sick of these diseases.

Pure Water Supply.—A properly located and properly constructed well or cistern is the best means of assuring a supply of pure water. A tightly fitted pump is necessary. An open top well or cistern cannot contain pure water. The well or cistern should be so located that there will not be any danger of contamination from the barnyard, cesspool, open toilet or other place of filth. All drainage of surface water should be away (down hill) from the cistern or well.

Spring Water.—If water from a spring is used the spring must be carefully protected; an open spring is most easily contaminated. The majority of the springs in Missouri are contaminated.

Construction of Wells and Cisterns.—The well or cistern should be so constructed as to protect the water supply from surface and shallow ground water, from waste water from the pump, and house wastes such as dish water, laundry or wash water.

Wells in sandy or clay soils should have water-tight walls with curbing or casing at least 10 feet deep. In limestone strata, water-

tight casing or curbing should be extended through the upper fissured layers down to solid rock formation.

Cisterns should have water-tight walls. Many cisterns leak and admit contaminated shallow ground water. Cisterns should have concrete covers. Wood covers warp, cracks open up and admit waste water.

A cut-off on rain water leader to permit wasting first dirty water from the roof should be provided. The inlet pipe should be of water-tight material, preferably cast iron or steel with screw joints. Many times when these are of tile they break off in the ground and other than clean rain water drains into the cistern.

A water-tight joint between pump base and pump platform is necessary to prevent waste water, bugs, etc., from entering the well.

The well should have a pump with solid base.

The Missouri State Board of Health at Jefferson City will supply upon request suggested plans for construction of wells of all types and properly constructed cisterns. Circular 413 "Farm Water Systems" and Circular 401 "Water and Sewage Disposal for Farm Homes" may also be secured from the Extension Service, University of Missouri.

School Water Supply.—"Every school shall be provided with an adequate safe water supply. When a municipal water supply is not available a water supply shall be developed, meeting the approval of the State Board of Health", from Missouri Public Health Manual.

Common Drinking Cup.—Sanitary drinking fountains should be provided in schools and other public places, or individual drinking cups should be provided.

Individual drinking cups in homes, schools, and public places will keep pure water pure for the drinker. If one person has used a cup, unless followed by proper cleansing, neither the cup nor the water is clean enough for a second person to use.

The State Board of Health regulation in regard to common drinking cups is as follows:

"No person, firm, corporation, or authorities owning, in charge of, or in control of any hotel, theatre, restaurant, lodging house, factory, school, church, store, office building, railway, trolley or other public conveyance station, or public conveyance by land, water or air, or other institution or conveyance frequented by the public or which may be used for the purpose of public assembly or as a place of employment, is permitted to furnish any cup, vessel or other receptacle for common use in any such place for drinking or eating purposes.

“The term ‘common use’ in this section shall be construed to mean for use by more than one person without adequate cleansing.”

Water Analysis.—If there is any doubt as to the purity of the water supply, a sample should be analyzed. It is a good plan, even if there is no doubt, to have the supply checked occasionally. Contact your local county health officer or county physician or write to the Missouri State Board of Health, Jefferson City, Missouri and ask how a water supply can be analyzed.

Methods of Making Water Safe.—Water used on picnics, camps and when traveling by automobile is often unsafe unless purified.

Water from wells, cisterns or springs which are not known to be safe, should be disinfected before use for drinking or cooking purposes. Boiling water for a short time will make it safe, but boiling of large quantities of water is not easily done and it may be desirable to disinfect the supply with a chemical.

To prepare a solution for disinfecting water, purchase a can of fresh, dry chlorinated lime (also called calcium hypochlorite or bleaching powder) from your local druggist.

Make up the powder into a smooth paste with a small amount of water, crushing up all lumps.

“Pour the clear solution into well or cistern and mix in the water, if possible. Do not pump out any water for at least two hours.

“Different kinds of water require different amounts of disinfectant. The best method is to add sufficient lime to give the water a strong odor. This will disappear in a few days. Ordinarily 1 ounce of bleaching powder for 1 thousand gallons is enough.

“The water supply will be safe until recontaminated. In order to permanently safeguard the water supply, the construction of the well or cistern should be improved so as to protect it from waste water, surface and shallow ground water.”

The following may be considered sanitary improvements:

Protect the water supply by:

Taking waste water far away from well, cistern or spring.

Making any necessary repairs in the construction of the well.

Providing pump.

Putting a trough under the pump spout.

Keeping the cover on the cistern pump.

Fencing chickens and stock away from the water supply.

Having the water supply analyzed.

Purifying the water supply, if necessary.

Using own individual drinking cup at home, in school, and other places.

WASTES

Careful handling of wastes is necessary to keep our homes and community attractive as well as do away with places where filth and disease germs may develop.

Rubbish.—Accumulations of rubbish are unsightly, may become the abiding place of insects and vermin and may promote bad odors. Papers, rags, and other inflammable material should be burned; tin cans should be buried; garbage which is not used for feeding purposes, may be utilized as fertilizer or should be burned or buried.

An annual or semi-annual house cleaning is an established custom in most homes and in some communities. Often a little care throughout the year would reduce the drudgery of these occasions and would provide better places in which to live. Many communities have established a custom of dumping rubbish in a hollow by the roadside or of throwing it into a stream. Both practices are bad and could be avoided by burning or burying such rubbish.

Garbage.—The handling of food refuse or garbage may be so managed that it will never become a nuisance and will not create bad odors or attract flies. A covered metal container should be provided, into which all scraps may be directly placed. A smooth-surfaced container, as a granite bucket, is easily handled; should be emptied frequently and thoroughly washed with soap and water. A lard can with handle and cover is sometimes used, and pails especially designed for this purpose may be purchased. One type which is very convenient and satisfactory is provided with a foot lever which raises the lid. Stores as well as homes should pay strict attention to the disposal of refuse food.

If garbage is not allowed to collect for too long a time and it does not decay and become odorous, it can usually be fed to hogs and chickens. If it cannot be disposed of in this way it should be wrapped in paper and burned or buried. It should never be scattered around and allowed to attract flies, nor should it be dumped in ponds or creeks.

Garbage Container.—The care of garbage is a problem in many homes. A covered metal container should be provided which can be:

1. Conveniently placed.
2. Easily emptied after each meal.
3. Easily cleaned with soap and water.

The covered pail shown on the following page fills all of these requirements.

The wooden cover is raised by placing one foot on the lever E. This leaves both hands free for scraping garbage.

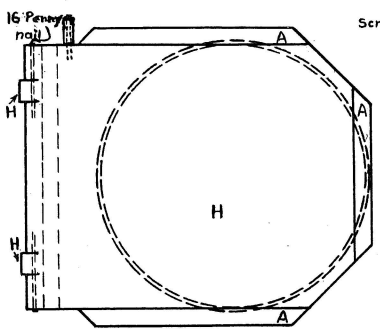

Top View

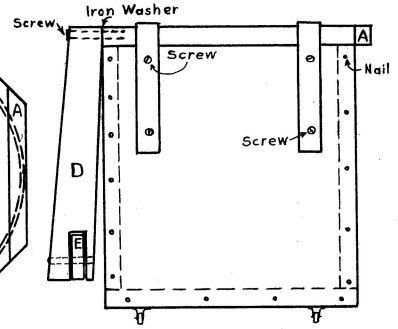

Back View

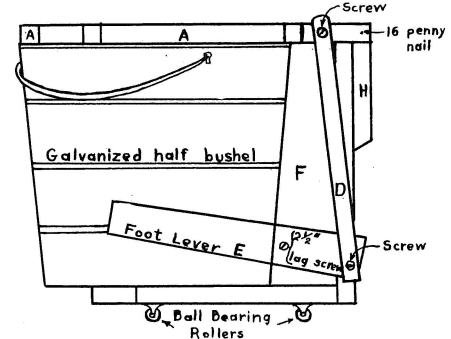

Side View

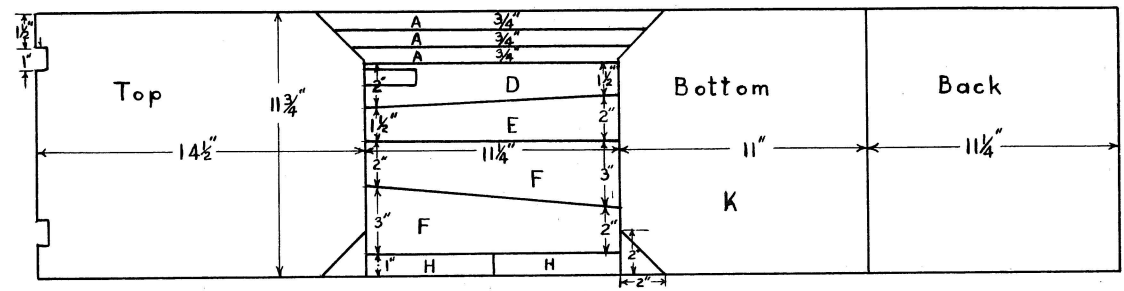

A 1" X 12" board 4 feet long, marked for sawing out parts for garbage container

A Home Made Garbage Container

Disposal of Water.—Where there is no drainage system, the disposal of liquid waste is often a difficult problem. Water from bathing, washing hands, dishes, and clothes, must all be carried some distance from the house and emptied where it will drain from and not toward the water supply. It is advisable to empty the water in different places, so the soil will not become soggy, so the sun and air may act on it more readily, and so the grass will not be killed.

In many homes much of the wash water and even dish water is thrown out onto the ground around the kitchen door. Such waste water may find its way into the cistern or well and spoil the drinking water; the ground around the kitchen may become soggy and moldy so that no grass can grow, bad odors are produced, and flies are attracted that later find their way into the house. A simple tile drain can be installed, with very little expense of time, trouble, or money, and would save lifting at least one-half ton of water each day in an ordinary household.

A water system in the home is one of the greatest conveniences possible and actually makes a home more healthful, as more water is used for bathing and for cleaning purposes, even more for washing dishes. If a complete water system cannot be installed all at once, a kitchen sink and drain will be a great advantage and will save the home-maker much needless heavy work and fatigue. Even a covered hopper connected with a tile drain will reduce the work and fatigue one-half, and the drain can be so placed that the sink can later be connected. All drains should be carried away from the house at least 50 feet, and so placed as to protect the water supply.

Disposal of Human Wastes.—The importance of the proper disposal of human wastes cannot be over-emphasized. Serious epidemics have resulted from lack of attention to such matters. Where there is no municipal sewage disposal system, it becomes the obligation of individual families to protect themselves and others from disease, by the construction and maintenance of a sanitary disposal system, as a septic tank or safe out-door privy.

Location and Construction of the Pit Privy.—The sanitary pit privy is recommended, where a sewage system is not available, by the Missouri State Board of Health. This privy house is constructed over a pit so flies and animals do not have access to the contents of the pit. It should not be located at a distance of less than 50 to 100 feet from a well, spring or cistern. It should be so placed that underground surface drainage is away from the water supply.

The privy should be exposed to sunshine; not placed under heavy shade trees or inside a dark building. There should be a walk or hard surfaced path leading from the house.

A cross section of the sanitary pit privy as approved by the Missouri State Board of Health is shown in the figure below. Complete instructions and detailed construction plans can be secured by writing to this department at Jefferson City for Form S. E. 10.

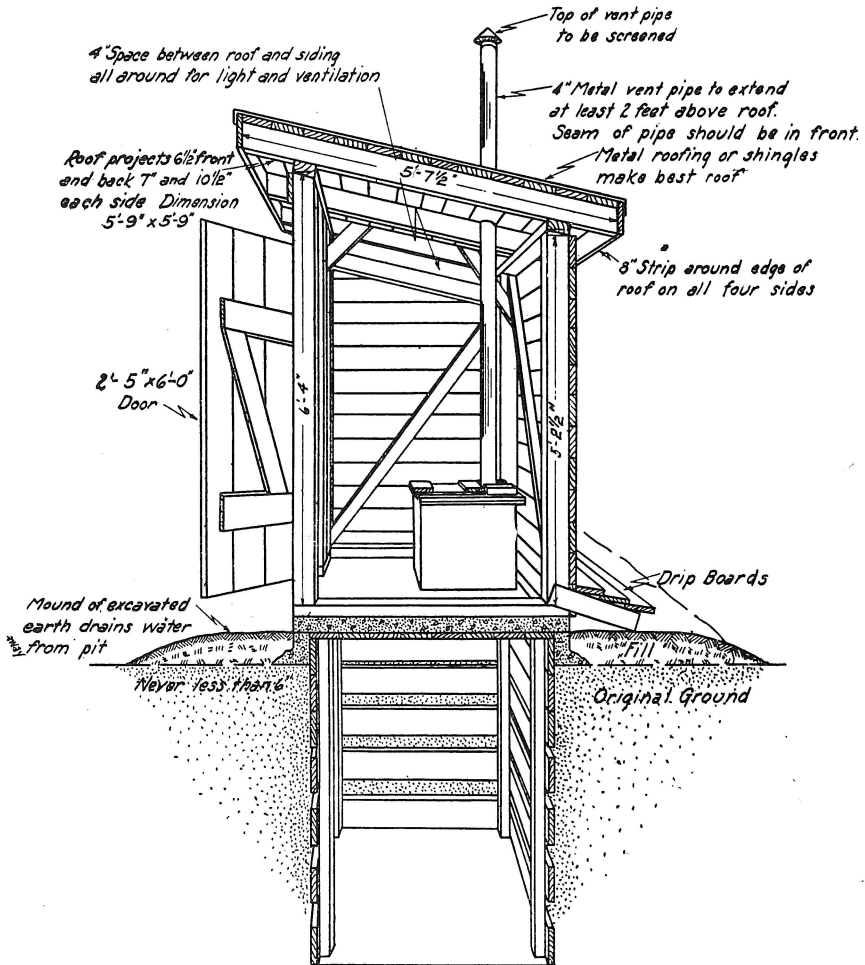

The pit should be at least 4 feet 6 inches deep, except where ground water level is high. Upper part of pit should be lined with concrete, brick, or wood, preferably concrete.

Any space between base of building and ground should be banked with earth and covered with drip boards, to prevent the dirt being removed by chickens, animals or rain. Seat openings should be covered. Covers should be larger than the openings and hinged.

Leather straps or strips from an old inner tube used as hinges will not rust and stick as metal hinges often do. Covers should close automatically. A block of wood may be fastened to the back wall in such a position that the cover can not remain upright.

Floors should be free from holes and cracks. Walls should be smooth (easy to brush and clean). Roof should be rain-proof. Vent flue of metal or wood should extend from pit, through the roof. Upper end of vent flue should be covered with wire screen.

Caring for the Privy.—Clean tissue toilet paper should be provided. Seat, both sides of covers and floor should be scrubbed at least once a week. Walls should be brushed occasionally to remove dust and cobwebs.

Pit should not be filled higher than within one foot of the ground surface. The house should then be moved over a new pit. The old pit should be filled with earth.

School Sewage Disposal.—The Missouri Public Health Manual, Book V, Part IV, Section 5, contains these regulations on school sewage disposal.

“Every school building shall be provided with separate toilets for boys and girls maintained in cleanly condition, and with one of the following methods of excreta disposal approved by the State Board of Health:

(a) Whenever a school building is provided with one or more water-flush toilets, the contents from said toilets shall be discharged into one of the following:

1. A public sanitary sewer, provided a public sanitary sewer is now or shall hereafter be made accessible.
2. A septic tank, provided no public sewer is available, as specified in paragraph 1, construction of said septic tank to meet the approval of the State Board of Health.

(b) In case a school building is not provided with water-flush toilets, one of the following devices for disposal of human excreta shall be installed:

1. A sanitary fly-proof pit privy which meets the approval of the State Board of Health.
2. Other methods of excreta disposal, such as chemical toilet, concrete vault, or other toilet device approved by the health officer.”

The following may be considered sanitary improvements:

Providing covered container for garbage.

Garbage pail emptied and washed with soap and water frequently.

Providing pail for waste water.

Emptying waste water far from house and water supply.
Frequently changing the place where the waste water is emptied.
Growing grass on bare spots around the kitchen.
Making toilet fly tight.
Building sanitary toilet.
Washing seats, etc., at least once a week.

VENTILATION

“Bring the outdoors indoors”

“Men have been known to go for months without shelter, for weeks without food, and for days without water, but no one can live more than a few minutes without air.”

It is necessary for health that a sufficient supply of fresh, cool, freely moving air be provided at all times, and that is what is meant by ventilation. It includes not only air, but air of the right temperature, of the proper degree of moisture and air that is constantly being changed.

In summer it is an easy matter to have plenty of the right sort of air inside buildings, for windows and doors are kept open most or all of the 24 hours of each day. During the winter months a large percentage of people house themselves closely in bad air and it is during these months that the greatest number of deaths occur—January, February, and March usually being the worst. The winter air is a wonderful tonic, is invigorating and is conducive to health.

“Bad air is undoubtedly as great a cause of ill health as any other condition in our home, social and business life. Hot, dry air is irritating and excites unhealthy conditions of the nose and throat and lower air passages; it lessens the appetite; it produces paleness and weakness; it lowers resistance to disease”.—“An ounce of fresh air is worth a pound of cough syrup.”

A good plan is to have some of the windows open at the bottom and at the top. The cool, fresh air can then enter at the bottom while the heated air will leave at the top.

Moisture.—The moisture in the air is called humidity. The amount of moisture in the air has a great influence on the comfort, health and efficiency of the persons living in it. One of the reasons that over-heated air is dangerous is because the heat dries up the moisture; the eyes, ears, nose, throat, and lungs of people in such dried air all suffer. A person is warmer in a room at 60° or 65° where the air has enough moisture, than in a room of 75° or 80° where the air is too dry.

It is not necessary to know the exact amount of moisture in the air; about 52% is considered healthful, but it is impossible to know how much there is without an instrument for recording it. The air in overheated buildings contains only about 25 to 30 per cent moisture.

If a stove is used for heating, a pan of water may be kept on it so that evaporation may supply some moisture. If a furnace is used, the water pan should always contain water so that the hot air rising into the house will contain some moisture.

Circulation of Air.—Moving air will remove from dwellings any excess heat, smoke, odors, dust or other substance arising from human occupancy, will maintain an even surface (or skin) temperature of the bodies of the persons in them and will have a stimulating effect on such persons, making them more alert and efficient.

Ventilators.—Ventilators or wind deflectors may be placed in the windows to prevent the wind blowing directly on the occupants of the room. Such wind deflectors may be purchased for a very small price or can easily be made of materials usually found in any home.

1. A simple wooden frame to which heavy cheese cloth has been tacked, may be made to fit under the open window. (See 1 in figure below).
2. A board may be fastened to the window casing and sill so that the window may be opened behind the board; the air, entering will be forced toward the ceiling instead of blowing straight into the room. (See 2 in figure below).
3. A deflector set at an angle to the window sill is very useful, and may be made entirely out of wood, or may be a wooden frame with glass insert, or the frame may be covered with fairly heavy cloth as shown in illustration. A frame covered with glass cloth would permit the important part of the sunshine to enter, as well as air. (See 3 in figure below).

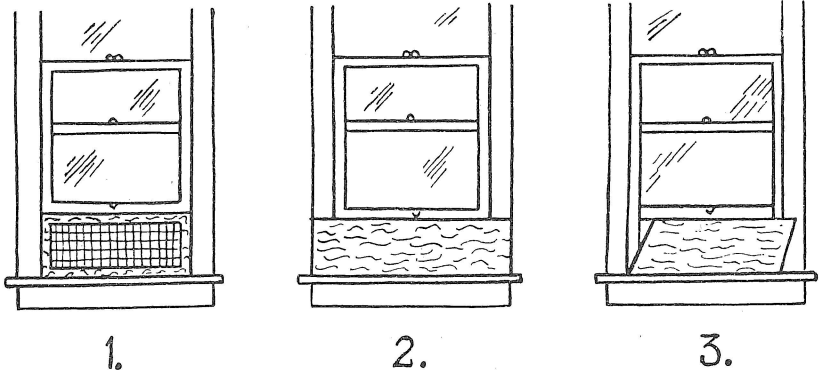

Temperature.—Cool air is much more healthful and invigorating than hot air. A temperature of 68° to 72° promotes health and lowers the number of cases of colds, pneumonia, influenza, etc., yet the majority of American houses are kept at a temperature of 75° to 80° and over during the winter. Dr. John H. Kellog says there are 1,000 deaths from too much heat in the winter to one death from cold. If a stove is used in the school room for heating, it should be jacketed.

A thermometer is one of the most important articles of ventilation equipment. Each home and school is urged to have a large thermometer placed in a prominent place. A "Healthometer" is a thermometer with 68° plainly marked as the health temperature.

It has been found that children in cool school rooms work better and learn much faster than in hot school rooms; that in factories the workers do much more work at 68° than at 75°, and that there are many more accidents at 75° than at 65°. Beware of the "fatal heat of winter". Keep the thermometer down to 68° or 72°.

The following may be considered sanitary improvements:

Increasing the ventilation by: Opening more windows, top and bottom. Keeping the windows open more hours.

Improving the ventilation by: Keeping the air moist. Maintaining the right temperature. Installing window ventilators.

MILK

"Milk for Health and Happiness"

Importance of Milk in the Diet.—Milk is the most nearly complete single food. Old as well as young should drink the amount of milk needed each day. Adults should have a pint of milk each day, and boys and girls should drink at least a quart of milk each day. This amount of milk is needed to supply the elements necessary for the formation and preservation of the teeth and bones, for the general development, growth and health of all human beings.

A quart of milk furnishes more than an ounce of pure protein which, under normal conditions, is more completely digested and absorbed than any other food protein. Milk also furnishes a large amount of energy, making it a food of champions. In addition to the calcium and phosphate or the building of the bones and the teeth, and the protein and energy contained in milk, milk contains a large amount of vitamins so necessary for good health.

Some countries depend almost entirely on goats for their milk supply, while in America cows are the chief source of milk supply.

Production of Clean Milk.—In order that milk may obtain its highest possible value as a food, it is necessary to do everything possible to produce milk of the highest quality.

Unfortunately, the germs of some diseases are able to live in milk and the persons using that milk may become sick of these diseases and may die. Among the diseases which may be carried through milk are tuberculosis, typhoid fever, scarlet fever, diphtheria, septic sore throat and undulant fever. The germs of some of these diseases come from unhealthy cows, while others get into the milk after it leaves the cow.

Clean milk is milk of good flavor, from healthy cows, milk that is free from dirt and contains only a small number of bacteria, none of which are harmful.

Cows Must be Healthy.—Cows should be kept in a healthy condition by feeding them the proper feeds for good health and for profitable milk production. Such feeds are: a good legume hay, corn, oats, bran and cottonseed or linseed meal. Cows should have plenty of salt; they should be fed a small amount of mineral, such as, steamed bone meal or finely powdered limestone, so as to give them plenty of calcium and phosphate to put into the milk.

Cows should have lots of good clean water to drink and should not be allowed to stand in stagnant ponds and low wet places.

It is important to know that the cows are healthy and that the whole process of getting the milk from the healthy cows to the persons using it is one unbroken chain of cleanliness.

Testing Cows for Bang's Disease and Tuberculosis.—Cows can be tested for Bang's Disease and tuberculosis to prove whether or not the cows have either of these diseases. Every cow in the herd should be tested for Bang's Disease every six months and for tuberculosis once a year or as often as the modified, accredited area plan requires the test. Any cows affected by either of these diseases should be removed from the herd and the stables and premises should be thoroughly disinfected. A good veterinarian can help in making the test and in advising as to what should be done if the animal is found to be affected. Ask your county agricultural agent or write the Missouri College of Agriculture for full information about how to get such tests made for your cows.

Milk Handlers Must be Healthy.—Great care must be taken to have only healthy persons handle milk or anything with which it will come in contact. Harmful bacteria may drop into the milk, may be carried by flies, may get into the milk from contaminated milk vessels or may be introduced from the hands of the milker. Care must be taken to avoid coughing and sneezing while milking or handling milk.

After the cows are prepared for milking, each milker should wash his hands thoroughly with soap and water and put on a clean pair of overalls and a jumper or wear a suit, preferably white, which is used for no other purpose.

Milking should be done only with clean, dry hands. If the hands become soiled, they must be again washed. If a milking machine is used, it should be properly cleaned and sterilized.

Clean Cows.—If the milk is to be clean, the cows must be kept clean, for manure, loose hairs, and other foreign matter may drop into the pail during the milking and will carry bacteria with them.

The stables should be clean, well lighted, and well ventilated. A clean yard is a great help in keeping the cows from becoming soiled with mud and manure. The best method of preventing such dirt from getting into the milk is to have the cows clean at milking time. The udders, flanks, and under parts of the bodies of the cows should be carefully washed with a clean cloth moistened with a chlorine solution before the milking is done.

Milk Utensils Must Be Clean.—All utensils which come in contact with milk should be made of durable, smooth, non-absorbent material. Wooden vessels are undesirable. Badly battered or rusty utensils are objectionable as they are hard to clean.

In order to produce clean milk, all buckets, cans and strainers for handling milk should be thoroughly washed immediately after milking.

Utensils must not only be thoroughly cleansed, but should be sterilized. First, rinse the utensils in cold or lukewarm water, then wash thoroughly until clean with hot water and an alkali washing powder, using a stiff brush; avoid rags, greasy soaps and soap powders. Rinse in hot water and then rinse in a chlorine solution. When not in use, the milk vessels should be kept where air and sunshine can reach them but should be protected from dust and flies.

Care of Milk.—Milk should be taken from the stable immediately after milking and strained. Very fine mesh copper strainers should not be used for straining milk as they cannot be thoroughly cleaned. A coarse mesh strainer with a wire clamp which will hold a fine cheese cloth in place is best. The cheese cloth should be removed, washed and boiled each time the strainer is used.

Milk should be cooled immediately after milking, to a temperature below 50°F. and kept at or below that temperature. Cold water will cool milk faster than the air. Rapid cooling is the most satisfactory way of keeping milk sweet.

Cooling Milk.—Milk must be kept cold. The jars or cans may be covered and kept standing in cold running water. If running water is not available, it will be necessary to put fresh, cold water in the trough frequently. A refrigerator or refrigerated room in which to keep the milk is a safeguard and a great convenience.

Pasteurization.—When it is easy for milk to become contaminated and there may be diseases carried in milk, a wise and safe thing to do is to pasteurize it before use.

Pasteurization is recognized by health authorities as the most practical, economical, positive and best method of preventing the spread of disease through milk.

Pasteurization is very simple. The milk is heated to 142°F. and kept at that temperature for 30 minutes, then cooled quickly and kept cool, at 50°F. or colder.

In the home, where one has only a small amount of milk, pasteurization may be done by the following method: Place the milk in an aluminum vessel on a hot flame and heat to 155°F. stirring constantly; then immediately set the vessel in cold water and continue stirring until cool.

The following may be considered sanitary improvements:

Having cows tested for Bang's Disease and Tuberculosis.

Keeping stables, barns, and barnyards clean.

Keeping long hairs clipped on flanks, udders, under parts of bodies of cows.

Washing flanks and udders of cows previous to each milking.

Washing and drying hands before milking.

Putting on clean clothes before milking.

Removing milk immediately, straining, cooling, and keeping it cool.

Properly cleaning and caring for milk pails, strainers, cloths, etc.

Pasteurizing milk.

INSECTS AND VERMIN

Everyone considers flies mosquitoes, roaches, fleas, rats and mice dirty and an annoyance; many people know that they are very destructive to various kinds of property and that it costs enormous sums of money to feed them, but not so many people realize that they actually carry various kinds of diseases of which human beings sicken and great numbers die.

The removal of such pests would definitely promote the health of vast numbers of people and would prevent innumerable deaths. All of them can be controlled at much less expense of time, labor and money than it takes to continually combat them.

The easiest, least expensive and most thorough way to begin the removal of any animal or insect pest is to destroy its breeding place. In that way hordes can be destroyed all at once, while fully developed adults will have to be dealt with one at a time, or in relatively limited numbers.

A high degree of general cleanliness inside and outside of buildings will do much to rid the premises of such pests, as most of them live, breed, and thrive in filth, dirt, and rubbish heaps.

Flies

Flies are such common pests that people sometimes forget how dangerous to human life they are. It is generally conceded that if flies should be exterminated, one of the chief causes of disease would be eliminated. Some people even think that it is impossible to get rid of them, but any place can be freed if the proper measures are carried out.

There are many kinds of flies, but it is the house fly which enters the home, store, restaurant, meat-market, etc. It is one of the dirtiest of insects and the most dangerous one known to man. We look upon it with disgust and fear because its habits all its life are so filthy, and because when it gets its wings it is so rapid and so persistent a distributor of dirt and disease.

The house fly never wipes its feet and, therefore, brings filth to your food and to you. This filth is loaded with germs. These germs communicate disease to you. In the body of a single fly 6,000,000 germs have been found. A few flies in spring will multiply to many million in summer. Flies live in dirt, filth and manure—therefore, no filth, no flies.

The body, legs, and feet of the fly are well fitted to carry filth and germs. They are covered with hairs and bristles and the feet have claws, in addition to pads covered with a sticky substance which enables it to maintain its foothold when upside-down. The house fly is often called the "messenger of death".

The eggs of the fly are laid on filth, generally on horse manure, but sometimes on cow manure, or other refuse heaps. The eggs usually hatch into maggots (or larvae) in 24 hours; the maggots burrow quickly into the substance—manure or refuse—on which the eggs were laid. The maggot stage lasts four to eight days and towards the end of that period the maggot burrows into the ground for an inch or two and comes to rest. The skin hardens, forming a cocoon (or pupa-case) in which the future fly develops to full size. In about five to seven days the full grown fly will come out from the cocoon hungry, and as soon as its wings are dry will usually go di-

rectly from its filthy brooding place to the house kitchen or dining room to feed and will infect everything it touches with the germs which are on its body, wings, legs, and feet, as well as in its saliva and excreta. Human beings are in constant danger when the discharges from any infectious disease are exposed to flies. Epidemics of typhoid fever and other diseases have been definitely traced to flies.

The disposal of human excreta is of utmost importance. In rural communities and smaller towns, sanitary outdoor toilets from which flies are excluded are a necessity.

Fly breeding in outdoor toilets may be prevented by scattering enough borax or lime over the excreta every 3 or 4 days to cover it entirely.

Protection of Food.—All food should be kept covered. Raw foods should be thoroughly washed through several waters. All garbage should be promptly and safely disposed of. Keep the house and surroundings clean and sanitary.

All of the measures for fly control should be applied to schools, stores, etc. Very few schools are screened and a fly is just as dangerous in a school room as in the home. Many stores, restaurants, hotels, etc. have foods constantly exposed to flies and dust. When buying food or eating in public places, select the stores and eating houses that keep the foods protected.

Fly Control.—The easiest and most effectual means of controlling the fly nuisance and danger is to destroy the breeding places and kill the maggots wholesale, instead of waiting until the flies develop their wings and come into the house carrying diseases and dirt. The majority of the maggots usually develop in horse manure and must have a certain amount of moisture in order to live.

If the manure is spread about once a week so that it will dry out, the maggots will dry up and die.

To aid further in prevention of fly breeding, manure may be treated with $\frac{1}{2}$ pound each of calcium cyanamid and superphosphate to each bushel of manure. These materials are scattered dry over the pile, then water is applied. In this way fly breeding is destroyed and the important fertilizing elements, nitrogen and phosphorus, are added.

Certain chemicals are frequently applied to manure to prevent fly development but they must be used with care. The above suggestions are considered safest.

Fly Sprays.—Where flies congregate in barns or around houses or gain entrance to houses and public buildings in considerable numbers, fly sprays may be used to advantage. Pyrethrum extract

in a high-grade kerosene (greaseless) applied with a good hand or electric spray gun is very effective in killing houseflies. Each gallon of kerosene should contain the extract of 1 pound of pyrethrum flowers testing 0.9 per cent of pyrethrins. If the pyrethrum flowers are of a lower grade, a proportionately larger quantity should be used. Out of doors the flies must be struck with the spray. Indoors the spray should be atomized in the air until there is a good floating mist. The room should then be closed for half an hour, to secure the best results. Many of the commercial fly sprays now on the market are essentially of this composition. Pyrethrum concentrates may also be purchased and appropriately diluted with refined kerosene. These are usually designated as 1 to 5, 1 to 20, and 1 to 40, that is, 1 gallon of the concentrate contains the extract of 5, 20, or 40 pounds of pyrethrum. (Adopted from the U. S. Department of Agriculture.)

Fly Poisons.—To destroy the fly after it has developed its wings, traps, poisons, swatters, and sticky paper may be used. Many of the ready prepared poisons contain arsenic and are dangerous. Either of the following mixtures may be safely used.

a. Mix 2 tablespoonsful of formaldehyde with one pint of equal parts of milk and water.

b. One tablespoonful of formaldehyde in one pint of water sweetened with two tablespoonfuls of sugar.

Keep in shallow plates. A piece of bread in the middle of the plate furnishes more space for the flies to alight and feed.

Fly Traps.—The home-made fly trap is an inexpensive, simple apparatus which could be made by anyone who is willing to give a little time to the work.

Home Made Fly Trap

Materials:—2 feet of 42 inch wire screen, or $3\frac{1}{2}$ feet of 34 inch wire screen. A wooden hoop, or hay wire.

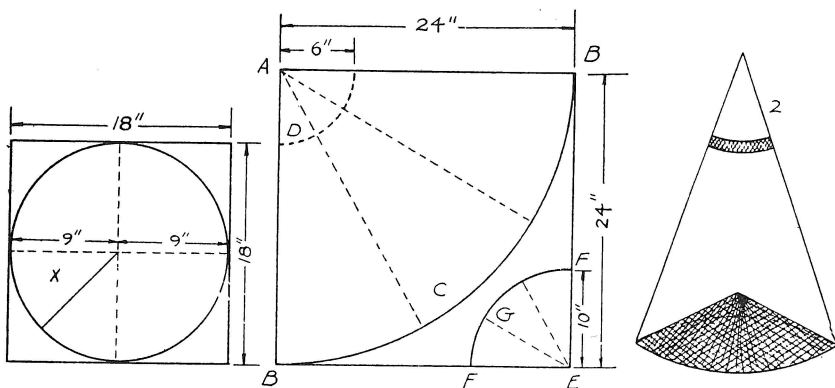

Directions for Making.—

1. To Make Outer Cone.—

- (1). Measure from corner (a) 24 inches to (b); then cut curved line (c) from (b) to (b).

Measure from corner (a) 6 inches then cut curved line (d). Join cut edges (ab), overlapping 1 inch. Sew together firmly, using heavy thread or fine wire.

- (2). Measure from corner (c) 10 inches to (f); then cut curved line (g) from (f) to (f).

Join the cut edges (ef), overlapping so that the line (gf) of the small cone will fit firmly over the larger cone.

Sew these edges together firmly. Bind the edges with tape, denim or any heavy material.

2. To Make Inner Cone.—

- (1). Measure 9 inches from the center (a) of an 18-inch square then cut out a circle of wire. Cut out section X about $\frac{1}{8}$ of the circumference, leaving enough to make the edges of the cone fit the finished lower edge of the outer cone.

Overlap edges, sew firmly.

3. To Complete Fly Trap.—

Place the inner cone 2 inside the outer cone 1, tack both edges to a wooden hoop or fasten to a wire.

Make a hole, the size of a lead pencil, up through the tip of the inner cone to form an opening and push the ends of the wire upward.

Note:—While working, wear gloves to protect the hands.

To use.—

Elevate the cone slightly and place a shallow dish containing buttermilk, molasses, or other food which readily attracts flies, under the cone.

To Empty Trap.—

Plunge the trap into boiling water; remove the small cone to empty the trap.

Screens.—All houses should be perfectly screened. It is an advantage to have the windows screened the full length as that makes it possible to open the windows both at the top and the bottom. All window screens should fit tightly so that there are no cracks around the edges. Door screens should close easily and completely. Often when the door has been closed there is a crack at the top, bottom or edge which will admit flies and other insects. Sometimes the door sags and a little adjustment is needed to correct this defect.

It is a simple and easy matter to repair a break or hole in the screen. Place a patch of screen wire over the hole and sew the patch on with a single strand of wire taken from the edge; or pull out some of the wires around all four sides of the patch so that the loose wire ends will be left sticking out from the solid screen of the patch. Bend these loose ends at a right angle to the patch, place patch over the hole to be repaired so that the bent ends will stick through the screen; bend the ends back on the opposite side of the screen so as to clamp the patch onto the screen.

The following may be considered sanitary improvements:

Repairing screens.

Installing new screens.

Using fly traps.

Spreading manure to kill fly maggots.

Using poisons regularly to kill fly maggots.

Using fly poisons.

Protecting food in homes, stores and public eating places from flies and dust.

Mosquitoes

Mosquitoes are a nuisance any time and any place and prevent peaceful sleep for many people. Often the pleasure of a cool summer evening in the yard is destroyed by the bites of mosquitos and a great many people are sick with malaria all or part of every year. Some are so sick that they must stay in bed, some try to carry on their regular duties, and many die each year all because of mosquitoes. One kind of mosquitoes carries malaria. Another kind carries yellow fever which has been a serious disease of man in many countries, since all mosquitoes are a nuisance and many are known to carry diseases, the wise plan is to try to get rid of them.

Destroy the Breeding Places.—Mosquitoes need water or damp places in which to breed and sometimes a very little water is sufficient. Therefore we want to get rid of such places or take care of them in such a way that they are unfit for the development of young mosquitoes.

The adult mosquito lays its eggs on the water or in damp places, and when they hatch they must go through various stages of growth before they are mosquitoes with wings. During the first stage they are "wigglers," live under the water and must come to the surface of the water for air. Without the air they will die. So one of the important ways to control mosquitoes is to put oil on the water in ponds, drainage ditches, etc. Very little oil is needed

and it does not hurt the stock to drink it. A tablespoon of kerosene thrown into a barrel will destroy all wigglers in a few hours. Additional applications may be necessary every 2 or 3 weeks.

Drainage of the pools, puddles, etc., is of prime importance. Weeds and other vegetable growths should be removed from pools.

When the breeding of mosquitos is taking place in an artificial lily pool, a bird bath, or other ornamental receptacle for water, a good means of prevention is to stock the pool with such fish as goldfish, trout, and minnows that will feed on the wigglers.

Troughs used for watering the stock should be emptied frequently and scrubbed out during the mosquito breeding season.

Control of Small Breeding Places.—Mosquitoes like to breed near human habitations and will often be found in very small puddles near houses, sometimes in a hoof print, in a rut, in the road, in a sagging gutter pipe on a roof, in a tub or barrel holding a little water or even a tin can which has been thrown out. Tin cans can be burned in a hot fire or buried, but, if it is necessary to allow them to accumulate for a time, it is well to punch holes in the bottoms at the time of opening to prevent their holding water. Puddles should be drained and barrels, tubs, etc., kept entirely empty, or the water in them oiled. Damp cellars and very thick shrubbery near the house will increase the danger and annoyance from mosquitoes. There should never be enough shrubbery or trees to keep the premises damp. "Let a little sunshine in" to dry out the dampness of cellars and under the shrubs and vines.

Screens and Bed Nets.—Buildings should be completely and thoroughly screened to prevent the entrance of mosquitos. The screens should be well fitted. Bed nets made of mosquito netting when tucked under the mattress at the edges gives much protection in unscreened or poorly screened houses.

Roaches

Roaches are usually a greater pest in cities and towns than in the farm home. They are called "night feeders" because they hide in cracks and behind objects during the day and come out at night to rob us of health by spreading their filth and their diseases everywhere they go. They travel fast and furiously over and into any kind of available food. They will feed greedily of the worst filth and pass quickly to foods that humans will eat; any food that is exposed will be visited by them. They are thought to carry diseases and perhaps certain parasites.

It requires continued, and persistent efforts to rid premises that have once become infested with roaches. There is a characteristic

and disagreeable odor readily noticeable in roach-infested places. Beware of the first roach; despise him and destroy him at once.

Prevention.—Cleanliness is one of the most important preventive measures. Open food, even crumbs, will attract roaches. It is necessary to keep kitchens, tables, floors, and pantry shelves free from crumbs and scraps of food. Leftovers should be carefully covered. Watch carefully all baskets or boxes of food supplies brought into the house. They are frequently carried from place to place. Use the fly swatter and kill all seen or trapped unexpectedly.

Control.—To rid the premises of roaches, fill cracks and crevices in shelves and woodwork; avoid leaving dishes unwashed; carefully remove all crumbs and scraps of food and use one of the following remedies:

1. Use powdered sodium fluoride. Apply in the evening with a small duster or bellows to cracks and hiding places. Scatter by hand to drawers, pantry shelves and to back of sinks where roaches run. Leave powder out two or three days. Repeat at intervals of a week or so until roaches disappear. Sodium fluoride is poisonous to man if taken in sufficient amounts and should be kept out of food and away from children and pets.
2. Pyrethrum powder may be used in the same way as sodium fluoride. It stupefies the roaches and since they may revive they should be swept up and destroyed. Pyrethrum powder is safe as it will not injure man or pets.
3. Phosphorous pastes are very effective and are available at most drug stores. Follow directions on container.
4. A very severe infestation is best remedied by fumigation by a professional fumigator.

Bedbugs

The bedbug is a wingless, sucking insect whose food is the blood of man. Because of their flat bodies they can hide in cracks in furniture, under loose wallpaper and in mattress tufts. They may be carried from home to home in clothing or in baggage. They feed at night so are not easily seen in daytime.

Control

Superheating.—Heat rooms, if well constructed, during the summer when temperature is already high to 120° to 125° F., for several hours. Use a room thermometer. This extreme heat will kill all

bugs, unless too many are in cracks which the high temperature may not reach.

Sprays and Hand Applications.—Fly sprays, commercial or home-made, which have as their base a high grade water white kerosene, practically stainless, will destroy bedbugs. They must come into contact with the bugs, therefore, a hand or power sprayer must be used. Where practical, kerosene, benzine or gasoline may be applied with a small brush by hand to cracks and crevices. Such application while tedious may be effective if done at frequent intervals.

Fumigation.—Fumigation with certain poisonous gases is the most effective, however, these are deadly poisonous and should be used by a well informed person or professional fumigator.

Fleas

Fleas have very promiscuous feeding habits and because of this many carry diseases. The rat flea is a known carrier of bubonic plague. Their eggs are not glued to hairs and they may fall off anywhere a cat or dog goes, and when the eggs hatch the larvae or wigglers may crawl under the edge of a dusty carpet or into a crack in the floor. Hogs and places where they frequent may become overrun with the pests.

Prevention.—To prevent having fleas in the house, it will be necessary to keep the house scrupulously clean; the premises outside free of fleas; to keep floor cracks free from dust, and to keep dogs and other animals outside the house. Use an oil mop for cleaning the floors. Barns and pig-pens should be kept free by frequent removal of bedding and scatterings as manure. A thorough application of used motor oil or such mixed with kerosene to ground, floors and walls of building will reduce the population. The animals should be treated at the same time.

For badly infested rooms sprinkle the floor with 5 lbs. of naphthalene flakes, and close for 24 hours; transfer naphthalene in other rooms if infested.

If the dogs and cats have fleas on their bodies, they should be bathed every two days in the following solution until they are entirely free:

Ninety-eight parts of soapy water and 2 parts of creolin. Several good commercial products are available at low cost. Spray the cat's and dog's beds with oil, either kerosene, benzine or crude oil.

Fresh pyrethrum dusted into the fur of an animal may be substituted for the creolin bath.

Rats

A rat is one of the most expensive visitors one can entertain, and yet there are more rats than people in the United States. It is estimated that there is one rat for every person living in a city and ten for every person living in the country; that one rat will eat about 50 pounds of grain in a year, and will destroy very much more; will eat many chickens and eggs, and that each year rats destroy \$200,000,000 worth of property in the United States.

What is still worse, they carry diseases which make people die and there have been many hundreds of thousands of deaths which are directly traceable to rats. They carry many parasites in their intestines, one of which is a tapeworm which people sometimes get. There is one disease which hogs get from rats and which people sometimes get from eating pork. The rat flea is the carrier of the Bubonic Plague. In addition, rats are very filthy, they run around in all kinds of dirt and will then take their dirty feet and bodies and tails into and through the food of human beings, depositing their dirt and their diseases wherever they go.

Most of the rats we have in the United States are the kind that prefer to live and raise their families in excavations or little caves, which are often found under barns and sheds. They frequently burrow two feet or more to get under a building. They eat anything they can find and while they sometimes move about in the day time, they really see better in the dark, so do most of their hunting and feeding at night. They multiply rapidly and grow up very fast. Under favorable circumstances it is possible for one pair of rats to have 400 to 600 children and grandchildren in 15 to 18 months.

Prevention.—The best way to prevent having rats is to “build them out” which means that all out-buildings will be raised off the ground in such a way that a rat cannot climb up the posts or gnaw through boarding. If a building is flat on the ground, the rats are furnished an ideal place to dig their cave homes, and to live and grow. No boxes or other material should be put under the buildings. A wire net may be stretched around to prevent this. The grounds around the building should not provide dwelling places for the rats, but should be kept clean and free of rubbish. No garbage should be left around.

Eradication.—Rats require shelter and food for proper development and if either is lacking they cannot subsist. After they become abundant other measures than prevention must be tried.

1. **Poisons.**—Poisons may be mixed with food and placed where the rats can find them easily, but such poisons are not always eaten. Rats are often particular about what they eat, and it is important that plenty of bait be exposed and thought given to a good selection of baits. The following poisons may be used:

Red Squill.—This is a poison made from a bulb type of plant. It can be bought either in powdered or liquid form. Since toxic qualities vary it is best to use amounts suggested on directions attached to the poison when purchased. Red squill is easier to use than most poisons as it is relatively harmless to man and animals. The same kinds of bait as discussed in a following paragraph may be used. As a rule, 1 oz. of red squill is used to each 1 lb. of bait.

Barium carbonate.—Use 1 part to 6 of bait. This is **very poisonous** to man and domestic animals and must be used with care.

Bait used may be ground fish, meats, vegetables, or cereals. Cereals should be made into a mush. If at all possible a variety of three or four kinds of bait should be used.

Place this bait where the rats will find it but where the other animals and poultry cannot get it because they may become poisoned by it.

2. **Traps.**—Traps may be used, though it is difficult to trap rats for the same reason that it is difficult to poison them, and also because they are very suspicious and investigate everything with their beady little eyes before they try a new thing. If the trap is well concealed and the rat is hungry, he will go into it and sometimes large numbers have been caught. If the trapping is to be successful, all other food must be removed, the traps should be placed where the rats have been accustomed to feed, and should be more or less concealed.
3. **Gas.**—To rid underground burrows of rats, the best known method is to "gas" them. There is a powder called calcium cyanide which forms a gas when the ground moisture mixes with it. To kill the rats, the powder is pumped into the openings of the rat runs, the ground air mixes with the powder, the gas goes on into the runways, and the rats are killed. Any person using the powder should stand up and should have the wind blowing away from him, never toward him.

Calcium cyanide produces a deadly gas which is **extremely poisonous** and should be handled with utmost care. It should never be used in enclosed buildings. Wash hands after handling the poison.

A simple pump or duster for forcing the dust into the nest may be purchased.

Fumes from a tractor or other gasoline motors are also deadly. When these are directed into runways, the rats are killed quickly. This practice has met with favor in many rural communities.

Mice

No home should house mice. They are destructive and dirty and careless in their habits. They run around in all kinds of filth, over and into any exposed food; they gnaw their way through even thick wooden partitions. They raise families that grow up very fast and it is necessary to get rid of every one or the evil will increase.

Mice are quite readily trapped as they are attracted by the smell of certain foods which they like better than others. Cooked bacon is a good bait.

Poisons.—It is not hard to destroy mice with poisons mixed with their favorite foods, but they often go back into their holes in the walls or under the floors to die, producing a bad odor which lasts several days.

Ants

Ants frequently become a great nuisance. If one cannot locate their nest and destroy it by using carbon bisulphide or perhaps boiling water, the use of poisoned bait is suggested. The ants will not die where the poisonous mixture is placed, but each ant carries a little home to the queen and soon the whole nest of ants will be poisoned. No one mixture will destroy all the different kinds of ants.

One teaspoon of tartar emetic to five of syrup mixed and soaked into sponge or excelsior and placed on a saucer will poison ants that like sweet foods. The poisons may be exposed also in small boxes with holes cut in the sides.

For those that like grease or meat the tartar emetic should be worked into fat.

Pyrethrum powder sprinkled on shelves poisons only the workers and does not do away with the colony unless used repeatedly.

Care should be used to keep children and animals away from the poisonous mixture in use.

The following may be considered sanitary improvements:

Instituting measures for control of mosquitoes, rats, mice, roaches, fleas, or ants, by:

Clean-up.

Destroying breeding places by:

Draining puddles.

Emptying or oiling all water containers, or periodically cleaning such containers as water troughs.

Making holes in bottom of all tin cans not immediately burned or buried.

Bathing flea infested cats and dogs.

Oiling beds of cats and dogs.

Destroying any of the above named pests.

OBJECTIVES OF HEALTH AND SANITATION PROJECT

Learn and practice health rules. (Keep record at least 1 week out of each month.)

Learn how sanitary conditions may be brought about in home and community.

Make and use a window ventilator.

Make and use a fly spray.

Make and use a fly trap.

Have home water supply analyzed.

Care for rubbish and tin cans at home and school.

Destroy one breeding place of flies and mosquitoes.

Keep a record of all work done and write a story of club experiences.

If the project group or community club of which it is a part wishes to work toward health and sanitation, it might sponsor a clean-up week, check and encourage destruction of breeding places of pests and assist others in checking water supplies. A dairy might also be visited.

REPORT BLANK

FOR MEMBERS IN

4-H HEALTH AND SANITATION



Name of Member ----- Age -----

County ----- P. O. ----- R. F. D. -----

Name of Community Club -----

Name of Project Leader -----

Date Started ----- Date Completed -----

Number of project meetings held ---- Number you attended -----

Committees on which you served -----

Number of individual demonstrations you gave -----

Number of team demonstrations you gave -----

Names of supplementary activities in which you took part -----

Did you attend a 4-H camp?--Did you attend the State Roundup?--

DAILY RECORD OF HEALTH HABITS*

(Check each day in blanks below)

	1st Week 1st Month							2nd Week 1st Month							1st Week 2nd Month							1st Week 3rd Month									
Month.....																															
Dates																															
I bathed my entire body, on dates checked.																															
I kept my hands and nails clean today.																															
I brushed my teeth at least once today.																															
I had 9 hours sleep (if more or less, record number of hours.)																															
I drank two glasses or more of milk today.																															
I drank no tea or coffee today.																															
I ate some vegetables (besides potatoes).																															
I ate some fruit today.																															
I drank at least 4 glassfuls of water.																															
I had a bowel movement today.																															
I slept with my windows open last night.																															
(For those underweight) I rested ½ hour today.																															
(For Health Project II—Health and Sanitation Club members, in addition to the above) I took breathing exercises out of doors today.																															

(*Adapted from Health Crusade and Child Health Organization of America.)

HEIGHT AND WEIGHT RECORD

Height		Weight	
1st Meeting	Last Meeting	1st Meeting	Last Meeting

Refer to your Health and First Aid Bulletin used in the 1st year health work for Height-Weight-Age Table.

PHYSICAL EXAMINATION

My family doctor examined me (date) -----
He reported the following -----
I have been vaccinated (date) -----
I have been immunized against diphtheria (date) -----
I have been immunized against typhoid fever (date) -----
My dentist examined my teeth (date) -----
My teeth were cleaned by the dentist (dates) -----

PROJECT ACTIVITIES

Did you make and install a window ventilator -----
Did you make and use a fly trap? -----
Did you make a fly spray? -----
Did you make a garbage container? -----
Did you have some water supply analyzed? ----- School? -----
Did you use an individual drinking cup? -----
Did you check the condition of the home toilet? -----
Did you care for rubbish and tin cans at home? -----
At school? -----
Did you destroy one or more breeding places of flies or mosquitoes? -----

SUGGESTIONS FOR THE CLUB STORY

How I became a club member.
What club work has meant to me in my home.
Special activities in which I took part.
What our club achieved in exhibits, judging and demonstrations.

Story.

(Use back of report and extra blank paper if needed)

Date -----

(Signed) -----

(Club Member)

Explanation.—Fill out all the blanks and the summary of club activities; write the story of club work for the year; hand this report blank to the project leader; attend the achievement program; and then your club work will be completed.

MU Libraries
University of Missouri--Columbia

Digitization Information Page

Local identifier circ

Capture information

Date captured	March 2017
Scanner manufacturer	Ricoh
Scanner model	MP 4503
Scanning system software	
Optical resolution	600 dpi
Color settings	2 bit bitonal and 8 bit grayscale (photographs)
File types	tiff

Source information

Format	Book
Content type	text with images
Source ID	
Notes	Original from MU Archives

Derivatives - Access copy

Compression	None
Editing software	Adobe Photoshop CS5
Editing characteristics:	
Resolution	600 dpi
Color	gray scale and bitonal
File types	pdf
Notes	Pages cropped and whitened