

# National Oceanography Centre, Southampton

## Cruise Report No. 27

### RRS *Discovery* Cruise 323

19th SEPTEMBER – 3rd OCTOBER 2007

First Deepwater Trials of the Autosub6000 AUV

*Principal Scientist*

S D McPhail

2008

National Marine Facilities Division  
National Oceanography Centre, Southampton  
University of Southampton  
Waterfront Campus  
European Way  
Southampton  
Hants SO14 3ZH UK  
Tel: +44 (0)023 8059 6370  
Fax: +44 (0)023 8059 6149  
Email: [sdm@noc.soton.ac.uk](mailto:sdm@noc.soton.ac.uk)

## DOCUMENT DATA SHEET

<b>AUTHOR</b> MCPHAIL, S. D. et al	<b>PUBLICATION DATE</b> 2008
<b>TITLE</b> RRS Discovery Cruise D323, 19 September-3 October 2007. First Deepwater Trials of the Autosub6000 AUV.	
<b>REFERENCE</b> Southampton, UK: National Oceanography Centre, Southampton, 38 pp. (National Oceanography Centre Southampton Cruise Report, No. 27)	
<b>ABSTRACT</b> <p>The main objective of the RRS <i>Discovery</i> Cruise 323 was to carry out the first deep sea field trials of the National Oceanography Centre (NOC) developed Autosub6000 Autonomous Underwater Vehicle. In addition, we took the opportunity, working with engineers from Proudman Oceanographic Laboratory (POL), to carry out deep water testing of integrated two way acoustic and satellite communications systems. NOC benthic biologists also carried out seabed sampling operations at the base of the Whittard and King Arthur canyons. As far as the Autosub6000 operations were concerned, the objectives of the cruise were completely met, with 8 dives, lasting 60 hours total and running for 278 km, to a maximum depth of 4553 m, and without faults. The POL tests of the acoustic and satellite systems were a success, and the NOC benthic biologists successfully obtained Mega core samples at the base of the Whittard canyon.</p>	
<b>KEYWORDS</b> <i>North East Atlantic, Cruise D323, Oceans 2025, Autosub, Autosub6000, AUV, Whittard Canyon, NE Atlantic</i>	
<b>ISSUING ORGANISATION</b> <b>National Oceanography Centre, Southampton</b> <b>University of Southampton, Waterfront Campus</b> <b>European Way</b> <b>Southampton SO14 3ZH UK</b> Tel: +44(0)23 80596116 Email: <a href="mailto:nol@noc.soton.ac.uk">nol@noc.soton.ac.uk</a>  <i>A pdf of this report is available for download at <a href="http://eprints.soton.ac.uk/">http://eprints.soton.ac.uk/</a></i>	

# CONTENTS

1. Ship's Personnel.....	4
2. Scientific Personnel .....	4
3. Itinerary.....	5
4. Background and Summary.....	5
5. Diary of Events .....	5
6. Autosub6000 Trials.....	11
6.1 General Objectives.....	11
6.2 Operating Area.....	11
6.3 Results compared to the pre cruise Objectives .....	11
6.4 Autosub6000 Navigation .....	15
6.5 Mission 7 Depth Control Tests .....	17
6.6 Autosub6000 Linkquest Acoustic Tracking and Telemetry .....	19
6.7 The Autosub6000 Pressure balanced Lithium Polymer Batteries.....	23
6.8 The Sonardyne USBL system and Compatt transponder.....	23
6.9 Autosub6000 Mechanical Configuration .....	25
7. POL D323 Cruise Trials Summary .....	26
Overview.....	26
Summary .....	35
8. Megacoring Operations.....	36
Operation of the Megacorer .....	36
Sampling for macrofauna.....	36
Sampling for protozoan meiofauna.....	37
9. Acknowledgement .....	38

## ***1. Ship's Personnel***

Sarjeant, P C	Peter	Master
Reynolds, P C T	Peter	Chief Officer
Oldfield, P T	Phil	Second Officer
Hailes, K D	Kieron	Third Officer
Pook, G A	Tiny	Chief Petty Officer Deck
Allison, P	Phillip	Petty Officer Deck
Crabb, G	Gary	Seaman 1A
Cumming, R A	Robert	Seaman 1A
McGeown, W M	William	Seaman 1A
Lambert, J W	Joseph	Seaman 1B
Jakobauferstroht, D W J	Dennis	E T O
Booth, P	Philip	Engineer Cadet Officer
Slater, I M	Ian	Chief Engineer
Harnett, J R	John	Third Engineer
Slater, G	Gary	Third Engineer
Haughton, J	John	Head Chef
Ripper, M	Michael	Purser Catering Officer
Caines, D A	Darren	Chef
Mingay, G M	Graham	Steward
Boyi, J	Johnson	Motorman 1
Macdonald, F K J	Fraser	Second Engineer
Minnock, M	Mick	CPO (Scientific)

## ***2. Scientific Personnel***

McPhail (PI)	Stephen	National Oceanography Centre, Southampton
Furlong	Maaten	National Oceanography Centre, Southampton
Pebody	Miles	National Oceanography Centre, Southampton
Perrett	James	National Oceanography Centre, Southampton
Morice	Colin	National Oceanography Centre, Southampton
Stevenson	Peter	National Oceanography Centre, Southampton
Squires	Mark	National Oceanography Centre, Southampton
White	David	National Oceanography Centre, Southampton
Cooper	James	National Oceanography Centre, Southampton
Amaro	Teresa	National Oceanography Centre, Southampton
Boorman	Ben	National Oceanography Centre, Southampton
Dinley	John	National Oceanography Centre, Southampton
Mack	Steve	Proudman Oceanographic Laboratory, Liverpool
Balfour	Chris	Proudman Oceanographic Laboratory, Liverpool
Jones	David	Proudman Oceanographic Laboratory, Liverpool

### ***3. Itinerary***

Departed Falmouth, UK    18<sup>th</sup> September 2007  
Arrived Falmouth, UK    3<sup>rd</sup> October 2007

### ***4. Background and Summary***

The main objective of RRS Discovery Cruise 323 was to carry out the first deep sea field trials (to 4500 m) of the National Oceanography Centre (NOC) developed Autosub6000 Autonomous Underwater Vehicle (AUV). We also took the opportunity, working with engineers from Proudman Oceanographic laboratory, to carry out deep water testing of integrated two way acoustic and satellite communications systems. NOC Benthic Biologists also carried out seabed sampling operations at the base of the Whittard and King Arthur canyons.

As far as the Autosub6000 operations were concerned, the objectives of the cruise were completely met, with 8 dives, lasting 60 hours total and running for 278 km, to a maximum depth of 4553 m, and without faults. The POL test of the Acoustic and Satellite systems were a success, and the NOC Benthic biologists, eventually after some problems with the corer, obtained seabed Mega core samples.

### ***5. Diary of Events***

The following is based on the ship's rough log and the Principle Scientist log.

All times in BST (GMT +1)

#### **18/9/2007      Falmouth in Dock**

0900: Autosub6000 Party joined ship.

1100 : Discussed plans for start of cruise with POL, OBE contingent and the captain.

1200: Safety Briefing and Document check.

Steve Mack and Chris Balford and David Jones (POL) measured the weight of their lander equipment in the dock.

Sonardyne engineer arrived, updated the USBL software and gave some training on the USBL operation to Dave White and James Cooper (TLO).

There was at first some difficulty in lowering the USBL pole for a Dock test of the USBL system, which was eventually resolved. The USBL pole, however needed to be lowered and raised manually.

The Compatt5 transponder, intended for Autosub6000 use was tested on a rope over the side.

#### **19/09/2007**

1000: Sailed for Falmouth Bay.

1322: Carried out initial float test with Autosub6000 with lines attached.

1458: Autosub6000 in water. @N:50 05.45 W: 04 56.837. Mission #001. Systems checked out with the AUV floating in water, surface runs, then two short (0.5 mile) runs at 15 m depth). All systems worked as planned.

Wind WSW 25 knt.

1710: AUV back on board.

1906: Picked up the replacement ships engineer by boat transfer, and sailed for deep water test sight.

**20/09/2007**

1124: N: 48 43.1 W: 07 40.5

Ship turned back towards Penzance to medically evacuate David Jones - POL.

2300 . Dropped off David Jones at Penzance by boat transfer (RNLA). Heading back to work area.

**21/9/2007**

Passage towards Autosub6000 deployment area. 1 day has been lost to the medivac.

**22/9/2007**

0655 Hove to for Autosub6000 deployment @ N: 47 12.9.0, W:11 10.1 (4680 m depth)

Mission #2 to dive to 4550 m depth, while measuring buoyancy variation with depth. To test the LinkQuest USBL and modem at ranges up to 5000m.

0800 Sea state 3 m. Wind NW 25 knots.

0810 Autosub6000 Mission # 002 dived. The AUV reached a depth of 4550 m. Tracking with the Tracklink 10000 was generally good , and the AUV controlled properly. No replies from the Compatt5.

1415 AUV back on the surface.

Wind SW 13 knots.

1450 All back onboard. Ship heading for Whittard canyon.

2018 At Whittard Canyon for echo sounder survey followed by Mega core.

2208 Corer deployed @ N: 47 37.1 W: 10 11.3 Station Number 16369

Wind SW 20 knots.

0025 Corer on seabed

0222 Corer inboard. Mud on tubes , but no samples.

0234 Corer deployed Station Number 16370.

Wind SW 20 knots.

0647 Corer inboard. Good penetration but no samples.

**23/9/2007**

0800 Rig up for wire test of the Sonardyne Compatt5, the POL Benthos modems and Release. I had been unhappy about the lack of weight on the wire, so a further 100 kg added, and the frame modified with the help of the deck crew.

1234 Start wire acoustics test. @N:47 35.0, W:10 09.9

Sea state 3m swell.

Wind WSW 14 knots.

1801 Wire test finished. Benthos release test was successful . The Compatt5 worked well to 4000m. The problem would seem to be that it had not been turned on properly for the previous Autosub6000 trial.

1810 Heading for the Coring station.

1851 Mega Corer deployed. @ N:47 37.1, W: 10 11.6.

2312 Corer inboard. No samples.  
2330 Heading for Autosub6000 station.

**24/9/2007**

0800 Arrived @ N: 47 16.8, 11 13.4. Weather conditions judged to be unsuitable to launch. Wind 35 knots. sea 4 to 5 m. Unsafe for Autosub6000 L&R .  
0930 Heading back to Whittard for more coring.  
1112 Hove to for wire test ore test for POL CTD comparison.  
Wind WSW 25 knots  
1452 Wire test completed. Heading for Whittard coring position.  
2026 Arrive for coring at Whittard @ N: 47 21.4, W: 10 11.6  
2038 Corer deployed. Station 16372.  
Wind NW x W 19 knots.

**25/9/07**

0050 Core inboard. No core.  
0100 Proceeding to Autosub6000 launch site.  
0126 Wind WNW 25 knot. Sea state 4 m. Not suitable for Autosub6000 launch as the forecast at predicted recovery time is as bad.  
Heading to the King Arthur canyon, for core attempt, possible POL work, and Autosub6000 deployment.  
1313 Arrive at King Arthur Canyon @ N: 47 55.2 w: 11 23.3  
Commence echo sounder survey.  
1347 Mega Corer deployed. Station 16373  
Wind NNW 20 knots.  
1756 Mega Core inboard. No samples.  
1845 Wire test for POL systems with multi stage telemetry links involving Linkquest modem, Orbcomm, and Inmarsat Sat coms.  
Wind NNW 18 knots.  
2334 Wire test complete. Communications systems worked well. Proceeding to Autosub6000 Launch position.

**26/9/2007**

0130 Autosub6000 launch. Mission # 003 @ N:47 47.2, W: 11 17.2 Up to 15 hours mission to test acoustic communications, buoyancy change, tracking systems.  
Wind NNE 18 knots.  
1530 Autosub6000 surfaced . Successful mission to 4270 m  
1632 Autosub6000 inboard.  
Wind NE x N 15 knots.  
1636 Transit to Whittard canyon. For another attempt at mega core.  
2150 Start mega core deployment @ N:47 36.9, W: 10 11.7. Station 16374.  
Wind NE x N 20 knots.

**27/9/2007**

- 0202 Mega Corer inboard. No samples.
- 0203 Mega Corer deployed. @ N:47 37.1 W: 10 11.4 Station 16375.  
Wind NE 18 knots.
- 0636 Mega Corer inboard. No samples.
- 0748 Wire test deployment of the POL MicroLander  
Wind NE x E 18 knots.
- 0800 Tests Completed successfully.
- 1135 Tethered test deployment of Telemetry Buoy. Streamed from starboard side.  
Wind NE 10 knots.
- 1535 Telemetry buoy inboard. Proceeded to the Autosub6000 launch area.
- 1745 Autosub6000 deployed. Mission #004 @ N: 47 34.0, W: 10 07.2.  
Test of diving capability, tracking, telemetry, buoyancy calculation.  
Wind E x N 11 knots.

**28/9/2007**

- 0840 Autosub6000 inboard following 15 hr mission. @ N: 47 34.5 W: 10 09.1  
All went well.  
Wind E x N 15 knots.
- 0911 Transit to corer station.
- 1044 Mega Corer deployed @ N:47 22.5, 10 11.1. Station 16376.  
Wind E x N 15 knots.
- 1500 Mega Core inboard. Sample taken at Whittard Canyon . Success.
- 1521 Mega Corer deployed @ N:47 22.5, 10 11.1. Station 16377.  
Wind E x N 15 knots.
- 1930 Mega Core inboard. Success again.
- 1940 Transit to Autosub6000 launch location.
- 2145 Autosub6000 deployed @ N:47 28.5, W: 10 22.0 Mission #005.  
The intention is to run the Autosub6000 between two waypoints 10 miles apart while at 4000 depth to test out deep navigation performance.

**29/9/2007**

- 0850 Autosub6000 recovered @ N:47 31.4, W: 10 36.6.  
Wind E x N. Sea 4 m.  
  
The mission was terminated early on the advice of the master, because of poor predicted weather conditions later, and a fleet of Taiwanese fishing vessels operating near the Autosub6000 return track. Hence only the first of the two intended reciprocal runs were completed.  
  
The LinkQuest transponder acoustic head on the AUV was damaged during recovery, due to collision with the ships stbrd counter.
- 1031 Commence POL wire acoustics test @ N: 47 30.1 W: 10 32.8



- 1624 Acoustics test completed. Proceeding to coring station at Whittard canyon.
- 1848 Mega Corer deployed @ N: 47 22.5, W:10 11.0. Station 16378  
Wind SE 20 knots.
- 2302 Mega Corer inboard. 8 good cores taken.
- 2327 Mega Corer deployed @ N:47 22.4 W: 10 11.0 Station 16379  
Wind SE 24 knots.

**30/9/2007**

- 0345 Mega Corer inboard. Good cores taken.
- 0557 USBL pole out for Autosub6000 deployment.
- 0622 Autosub6000 #6 dived @ N: 47 22.794, W: 10 10.799 .  
Dive to 4000m for more buoyancy data , and control stability tests at 500 m depth.  
Wind SE 20 knots.
- 0949 AUV on surface. Data downloaded. New control coefficients uploaded for speed and control trails.
- 1005 Autosub6000 dived again.
- 1100 AUV on surface. Stopped the mission running because the AUV was heading towards the ship. Data downloaded. New control coefficients uploaded for speed and control trails.
- 1235 Start Autosub6000 Mission #7 Control and speed trials.
- 1500 AUV on surface @ N: 47 22 .7, W: 10 10.8
- 1600 AUV back onboard. Transit to coring station.  
Wind SE x S 10 knots.
- 1626 Mega Corer deployed @ N:47 22.4, W:10 11.0 Station 16380
- 2033 Mega Corer inboard. Core taken.
- 2104 Mega Corer deployed. @ 47 22.4, W: 10 11.0 Station 16381

**1/10/2007**

- 0054 Mega Corer inboard. 1 good core.
- 0101 Transit to Autosub6000 test site on continental shelf @ 150 m water depth.
- 0840 Deployment aborted. Problem with the Autosub6000 ARGOS antenna
- 1040 Autosub6000 deployed for mission #008.  
Navigation trials on the continental shelf, in 150 m water depth. @ N: 48 17.0, W: 09 28.0.  
AUV runs WP1 to WP2
- 1404 Autosub6000 on surface at WP2
- 1408 Autosub6000 resumed mission
- 1720 Autosub6000 recovered @ N: 48 16.9, W: 09 28.4
- 1833 Mega Core deployed at N: 48 16.8 , W: 09 28.3 for test of equipment.
- 1856 Mega Core inboard.
- 1906 Heading for Falmouth.  
Wind ESE 15 knots.

**2/10/207**

1200 Commencing North → South, South → runs for the ships log calibration  
@ N: 49 05.9, W: 07 10.4

1300 Calibration runs complete. Resuming passage to Falmouth.

**3/10/2007**

0440 Lizard point. N:49 49.7, W: 05 01.2

0915 Docked at Falmouth

## 6. Autosub6000 Trials

Stephen McPhail

### 6.1 General Objectives

The general objective of the Autosub6000, RRS Discovery cruise 323 trials was to demonstrate that Autosub6000 is, with the exception of the sensor payload, ready for science missions to at least 4500 m deep. Although there is a moderate amount of data processing to be carried out, particularly in regard to the advanced navigation algorithms for fixing the AUV position when at depth, it seems likely that by this criterion, that the trials were a complete success.

The main more detailed objectives were to:

To run Autosub6000 at 4500m depth, 100 m off the seabed with it navigating and controlling to specification, and communicating and taking commands through Linkquest telemetry, and tracking through USBL at ranges up to 7 km – *Achieved*.

- To collect tracking data such that the AUV can be (post mission) positioned at better than 5m accuracy at this depth – *Achieved*.
- To collect data on AUV buoyancy variation with depth, and other vehicle parameters such as drag and propulsive efficiency – *Achieved*.
- To prove the operation of the batteries over several pressure and charge cycles – *Achieved*. 1 battery was withdrawn after failing to charge fully after mission 1.

### 6.2 Operating Area

The operating area chosen was in an area of the deep Celtic sea margin, near 47 North, 11 West . This area is the nearest area of deep sea (greater than 4500 m deep), to the port of Falmouth, Cornwall in the UK which is also conveniently flat. During the descents to 4000 m, when the AUV would have no bottom tracked navigation, the AUV would effectively drift with the currents. With anticipated times without bottom track of up to 10 hours, and anticipated worst case vertically averaged currents of  $0.07 \text{ ms}^{-1}$ , then it was necessary to find a site which was flat to within 40 m over a circular area of diameter 4km (later results showed this to be pessimistic, total drifts of about 1 km were experienced in practice over 15 hour deployments). A position at N: 47 13.0, W: 11 10.0 was chosen, with water depth of 4710 m (corrected by Carters Tables). Figure 3 is the depth profile for the first deep dive of Autosub6000 . Later in the cruise, having proven the control and navigation capabilities of the AUV, we chose positions near the base of the Whittard Canyon and King Arthur Canyon, with greater sea bed slope, and are slightly shallower, in order to reduce ships passage time between the Autosub6000 and Mega Coring stations. See Figure1, the Operating Area.

### 6.3 Results compared to the pre cruise Objectives

Essentially all the pre –cruise objectives have been met, or look likely to have been met once the data is processed fully. Table 1 lists the formal objectives which were set before cruise, and the results obtained during the cruise. Some of the objectives were met with results which exceeded our expectations. The LinkQuest system tracked and telemetered beyond 7000m. The descent and ascent speeds were higher than expected at  $0.9$  and  $1.9 \text{ ms}^{-1}$  respectively, this improving the efficiency of use of the AUV (more at-depth time). We devised a new method for getting some measure of buoyancy variation, drag, and propulsive efficiency by using steep angle ascent and descent data, and the ADCPs worked to 240 m range, more than the specified 200m (although this was not totally surprising given the lower acoustic attenuation in deep and cold water).

In terms of range performance, the Autosub was operating with only 2 batteries, following the removal of one battery which was giving problems in the charge control circuit. These worked well and to specification through several discharge cycles, and could easily supply the required power. In future with 6 battery packs , operational time of 60 hours would be achievable.

The AUV ran for total of 59 hours, 275 km, during 8 missions, to a maximum depth of 4556 m (corrected for depth sensor error). Table 2 lists the missions carried out.

## Map of Operating Area

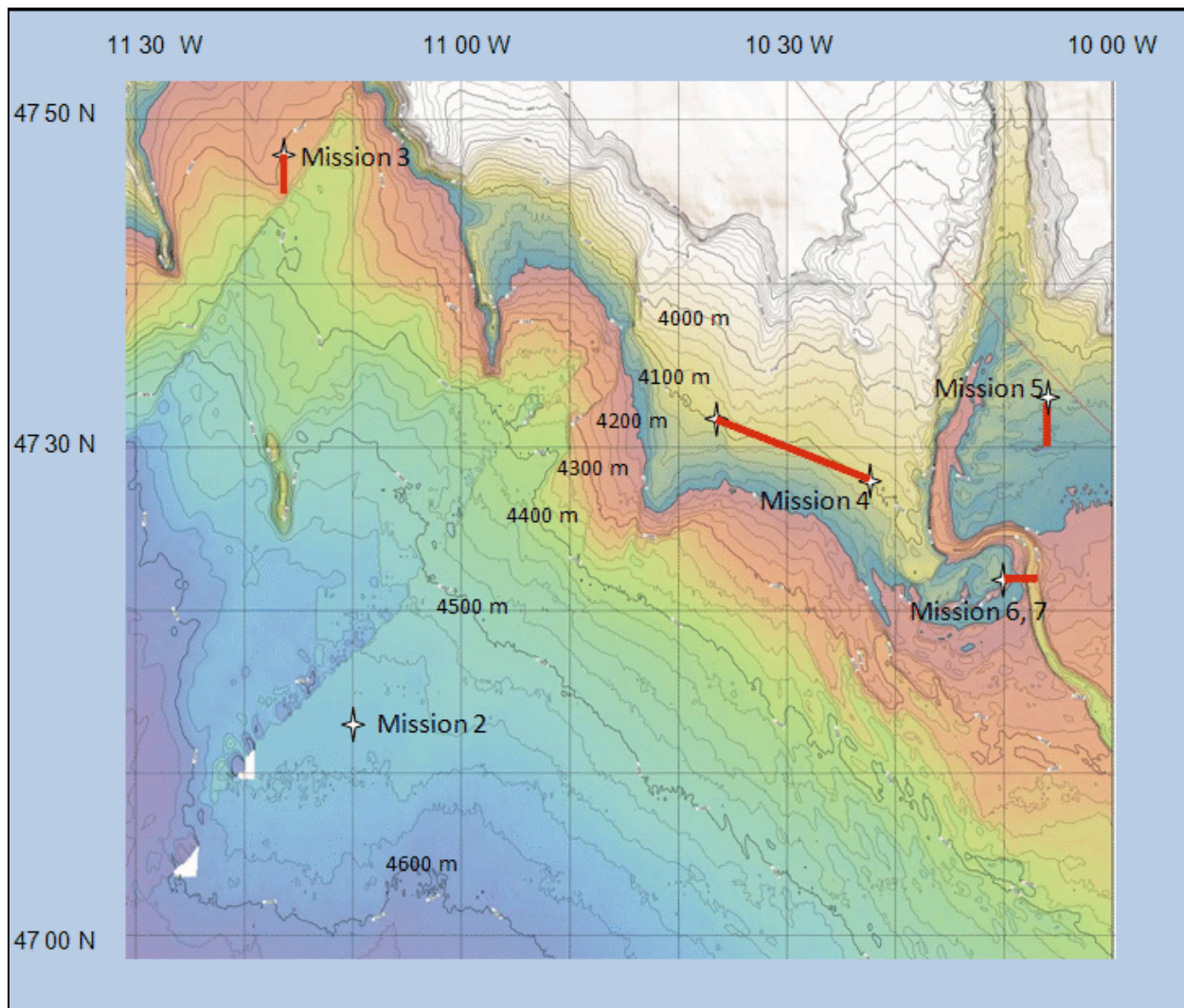

*Figure 1. Map of the Operating Area. Autosub Mission 1 was in Falmouth bay, Mission 8 was in shallow water to the north east of this chart, for navigation test runs. Bathymetry provided by UNCLOS group, NOC. data sources are UK Navy, Irish National Seabed Survey (Geological Survey of Ireland) and Petroleum Affairs Division, Ireland.*

Name	Detail and Method	Results
Buoyancy Vs depth	To collect data on AUV buoyancy variation with depth. To measure reversible and non reversible buoyancy changes. Methods used were to run the AUV in large circle at constant depth at various depths, and stages in the missions.	The controlled ascent method has greater merit in terms of sensitivity, and we expect this will be capable of detecting small buoyancy changes. The results suggest that the buoyancy increases by 6 kg over 4000 m depth range. So far there is no indication of any non reversible loss in buoyancy. If any, this is small. The AUV was able to fly without difficulty at this level of buoyancy.
Control and stability	To establish control characteristics. depth deviation. To fine tune as necessary the control parameters and position of the wings to achieve satisfactory control characteristics.	Constant depth runs carried out at 3 speeds and 5 different control settings. The AUV flying with the depth response ranging from under-damped to over-damped. The AUV flight was acceptable at all the settings. We did not move the wings as the original position seemed near optimal.
Range of USBL and telemetry - deep mode	Establish slant range of USBL tracking and telemetry system, when AUV is within 90 degree included angle under the ship (up to 4500m deep, 4500 m offset = 6400 m ).	Slant ranges up to 7166 m were demonstrated with the Tracklink tracking and telemetry system. What appears to be a Tracklink transponder firmware problem, at times limited our getting messages back to 1 per 8 requests.
Acoustic Positioning	To collect Tracklink USBL tracking data such that the AUV can be (post mission) positioned at better than 5m accuracy at 4500 m depth.	Good quantity data were collected on each of the deep missions. As an additional, tracking data was collected at the start and the end of a 20 km run at 4000 depth. Data was also collected on the ships position, heading, fish attitude, and vertical acceleration.
Batteries test	To prove the operation of the batteries over several pressure and charge cycles.	One of the batteries was removed after it failed to charge properly after the 2 <sup>nd</sup> Mission. There were no apparent problems with current sharing with the remaining two.
Navigation	Establish navigation accuracy. In water depth <150 m using GPS fixes as references, or when deep using acoustic positioning at ends of 10 km run.	Results for GPS referenced calibration run were satisfactory, suggesting that navigation accuracy to 1 part in 1000 drift or better is achievable. Data from deep run yet to be processed.
Speed Drag and Efficiency	Measure vehicle drag and propulsive efficiency with constant depth runs, varying motor power. Also Deceleration tests.	All tests carried out and data being processed. A new method which uses known buoyancy as the driving force was tested, and is hoped will give more accurate results and information on propulsive efficiency.
ADCP range	Establish tracking range of ADCP at depth.	Tracking to 240 m proved.
USBL comparisons	Compare performance of Sonardyne Compatt5 and Tracklink systems, by interspersing Sonardyne with Tracklink interrogations.	The Tracklink and Sonardyne Compatt5 systems did not to co- interfere. The Sonardyne system gave results (to 6000 m range) only later into the cruise due to setup problems, and perhaps unreliable software on the deck unit. .
Range of USBL and telemetry - shallow mode	Establish performance of USBL tracking and telemetry, in near horizontal mode (outside of manufacturers specification.)	The data are still being processed, with the vehicle at 80 m depth the Sonardyne system tracked to maximum 800 m horizontal range (reliably about 400 m). The Tracklink performance seemed similar in this mode, but results are yet to be processed.
Descent rate measure	Establish maximum descent and ascent rates (at the buoyancy set), and as necessary tune parameters such as descent pitch demand to maximise descent rate.	Vertical descent rate of $0.9 \text{ m s}^{-1}$ achieved at 400 W demand power and pitch of -56 degrees. Ascent rate of up to $1.9 \text{ ms}^{-1}$ . Predict that $1 \text{ ms}^{-1}$ down and $2 \text{ ms}^{-1}$ will be achievable at lower buoyancy and higher power.
Reliability	To collect data on reliability of Autosub6000. Target 50 hrs	There were no in-operation failures. The AUV ran for total of 59 hours, 275 km, during 8 missions

Table 1. Objectives set before the cruise for the Autosub6000 trials and the results.

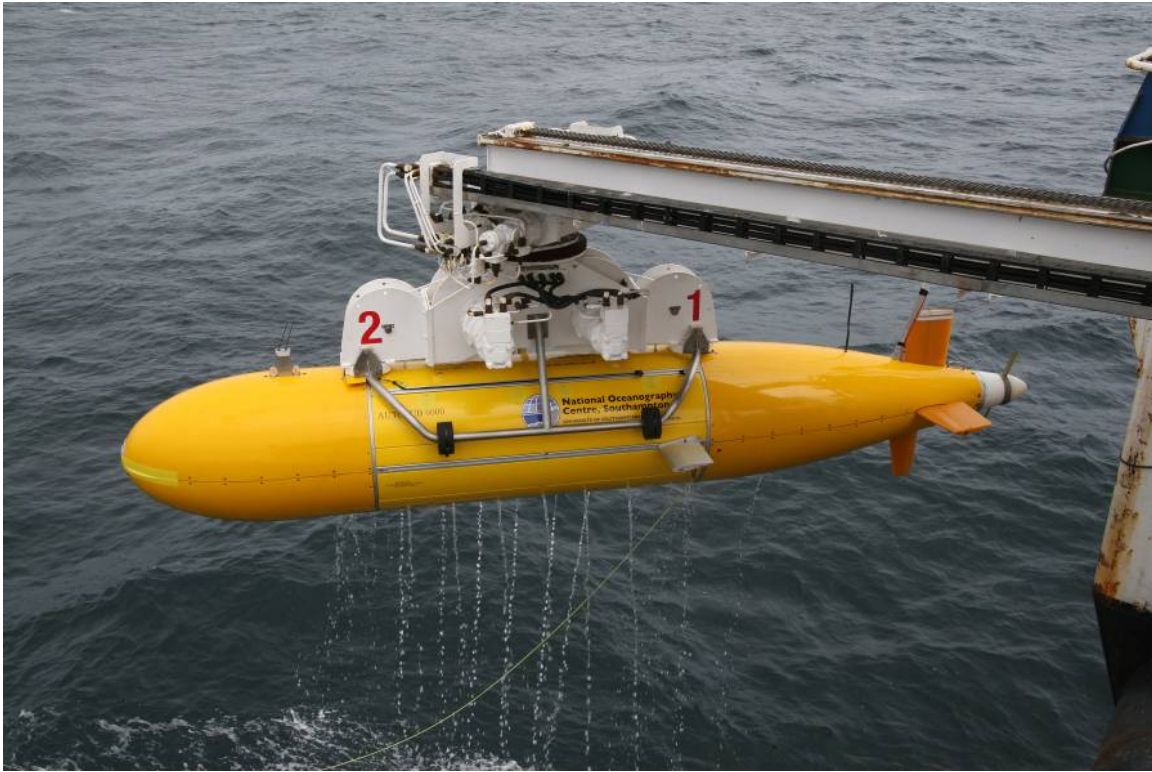

Figure 2. Autosub6000 being recovered onto RRS discovery following its first mission

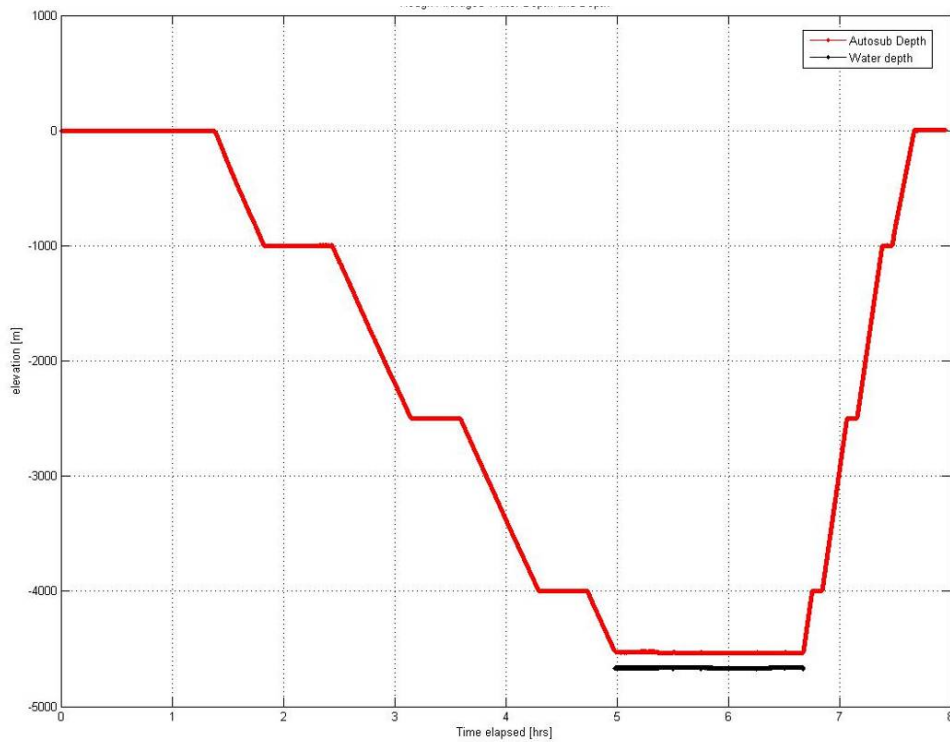

Figure 3. Depth profile for the Autosub6000 first deep water mission (the 2<sup>nd</sup> ever deployment of the AUV) The red trace is the AUV depth, the black trace is the seabed depth as measured by the AUV's ADCP.

#	Date	Depth m	Start position	Run km, hr	Objective
1	19/9	16	N: 50 05.45 , W: 04 56.84	4, 1	Basic control and navigation
2	22/9	4556	N: 47 12.90, W:11 10.10	33, 7	Deep dive buoyancy variation, telemetry and tracking
3	26/8	4299	N:47 47.20, W: 11 17.20	65, 14	As above + speed and drag tests
4	27/9	4159	N: 47 34.00, W: 10 07.20	63, 14	As above + free ascent buoyancy and ADCP range tests
5	28/9	4119	N:47 28.50, W: 10 22.00	51, 12	As above + 30 km transit at depth to test deep navigation
6	30/9	4018	N: 47 22.80, W: 10 10.80	21, 5	Deep dive + depth control tuning
7	30/9	502	N: 47 22.80, W: 10 10.80	10, 2	Depth control tuning
8	1/10	80.1	N: 48 17.00, W: 09 28.00	30, 6	Navigation calibration

Table 2: The missions and objectives for the Autosub6000 trials on RRS Discovery cruise 323 in September 2007.

## 6.4 Autosub6000 Navigation

Stephen McPhail

### *Summary + Conclusion*

A 8 mile reciprocal navigation run was carried out in a water depth of 150 m. The results indicate that the navigation system is performing at least or better than specified, and that dead reckoned navigation accuracy of better than 1 m drift for each km run should be achievable in future missions.

### *The Navigation System*

The Navigation system for Autosub6000 comprises a Thales GPS receiver, a Ixsea PHINS inertial navigation system, and an RDI Workhorse 300 kHz ADCP, housed in a 6000m rated titanium pressure case. When surfaced the AUV is able to position itself using GPS fixes, but when dived it must rely on either acoustic positioning (see section on acoustic positioning) or dead reckoning using the INS and the ADCP). When within 220 m of the sea bed the ADCP is able to obtain velocities relative to the seabed, giving the most accurate navigation. Essentially the PHINS INS gives very accurate heading information (with accuracies of the order of 1 milliradian (0.057 degrees). The ADCP, when bottom tracking, gives velocity (with accuracy of the order 0.1%) in the vehicle frame of reference. For accurate navigation, it is essential that the ADCP and the INS are accurately physically aligned as any misalignment of the two instruments of greater than about 1 milliradian will degrade the accuracy of the navigation. It is neither possible to mechanically align the components to this accuracy, nor to know what are the instrumental biases prior to the first missions, hence it is essential to carry out a calibration mission.

### *Calibration mission.*

The calibration mission must be run in water shallow enough so that the vehicle can obtain ADCP bottom lock throughout the mission, hence water depth of about 150 m was chosen on the continental shelf around N: 48 17.0, W: 9 28.0. The vehicle needs to obtain GPS fixes, then dive and run a straight track of several miles, surface and reacquire GPS positioning fixes. By comparing the difference in position between the GPS data at the ends of the line and the vehicle dead reckoned navigation, it is possible to calculate the alignment and scale errors in the PHINS / ADCP navigation. We carried out this navigation calibration experiment on the 1<sup>st</sup> October 2007. Two waypoints, 8 miles apart were chosen, and the vehicle ran at a demand depth of 80 m (with minimum altitude set to 60 m), in water depth of 160 to 135 m. The AUV surfaced at the North East waypoint, acquired a

GPS fixed, dived, then headed back on a reciprocal track to the first waypoint, where it surfaced. Figure 4 is a plot of the navigation track, and the results for this run are given in Table 3.

***Results of calibration mission***

The mean correction of 0.337 degrees, and scale factor of 0.00412 error gives the correction which should be applied to the navigation system to give the best navigation performance for future missions. For the scale factor correction, it will be important to check first the Salinity in the operating area, as this affects the speed of sound and hence the scale factor accuracy of the ADCP. The ADCP had been setup for a salinity of 35 ppt.

The overall conclusion, and encouraging result is that the deviation between the corrections between the two runs of 0.01193 degrees (0.2 milliradian) , and 0.00033 scale error (0.033%), suggests that the navigation accuracy will be very good in the future at 0.1 % or better of distance travelled.

Course Line 1 – Dead Reckoned	54.317	degrees
Course Line 1 – GPS Navigated.	54.666	degrees
Length Line 1 - Dead Reckoned	10474	m
Length Line 1 - GPs Navigated	10521	m
Course Line2 – Dead Reckoned	-129.149	degrees
Course Line 2 – GPS Navigated.	-128.824	degrees
Length Line 2 - Dead Reckoned	11768	m
Length Line 2 - GPs Navigated	11812	m
Course Error – Line 1 (DR - GPS)	0.349	degrees
Course Error – Line 2 (DR - GPS)	0.325	degrees
Magnitude Scale Error Line 1 (DR-GPS)/ GPS) -1)	0.00445	-
Magnitude Scale Error Line 1 ((DR-GPS)/ GPS) -1	0.003793	-
Mean Heading Correction	0.337	degrees
Deviation +/- of heading	-0.01193	degrees
Mean Scale correction	0.00412	-
Deviation +/- for scale correction.	0.00033	-

*Table 3. The results of the Navigation calibration run.*



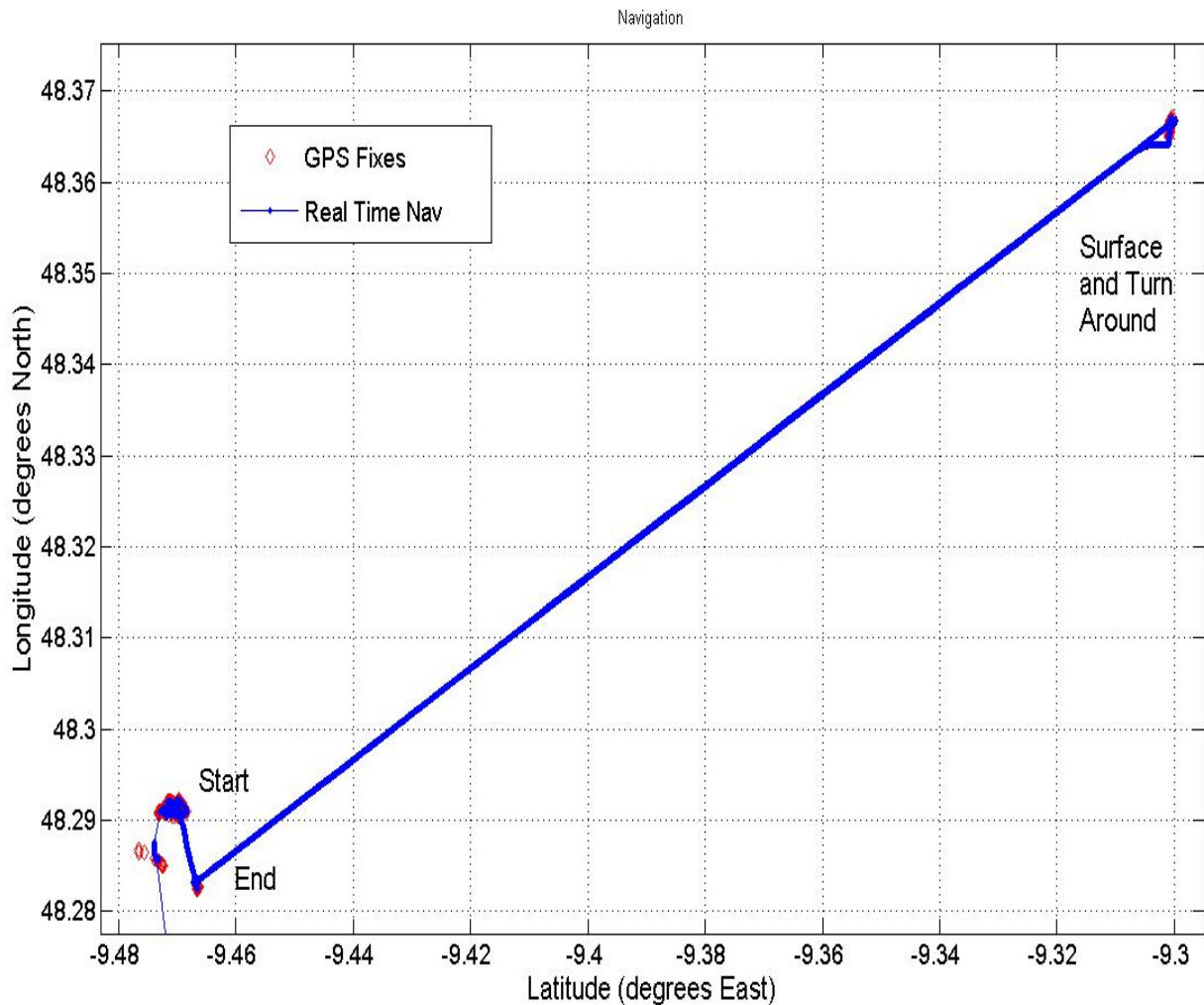

Figure 4. Navigation plot for Mission 008. The AUV dived, ran for 8 miles north east at 80 m depth, surfaced, acquired a GPS position fix, and then did the reciprocal track.

## 6.5 Mission 7 Depth Control Tests

James Perrett

During part of mission 7, a series of test were carried out in order to test the response of the AUV to different depth demands. The tests consisted of an 8 minute run up at a depth of 500 metres, followed by a change of depth demand to 495 metres for one minute, followed by a demand of 500 metres for one minute followed by another demand of 495 metres and finally followed by a demand of 500 metres for one minute. This sequence was repeated 3 times – once at a power of 400W, once at a power of 200W and finally at a power of 100W. After this the AUV surfaced, the control data was analysed and a new set of control coefficients was sent to the depth controller. The same mission segment was then repeated using the new coefficients. In all, 4 different sets of controller coefficients were tried and the initial results are shown in figure 5. The controller coefficients used are shown in table 4.

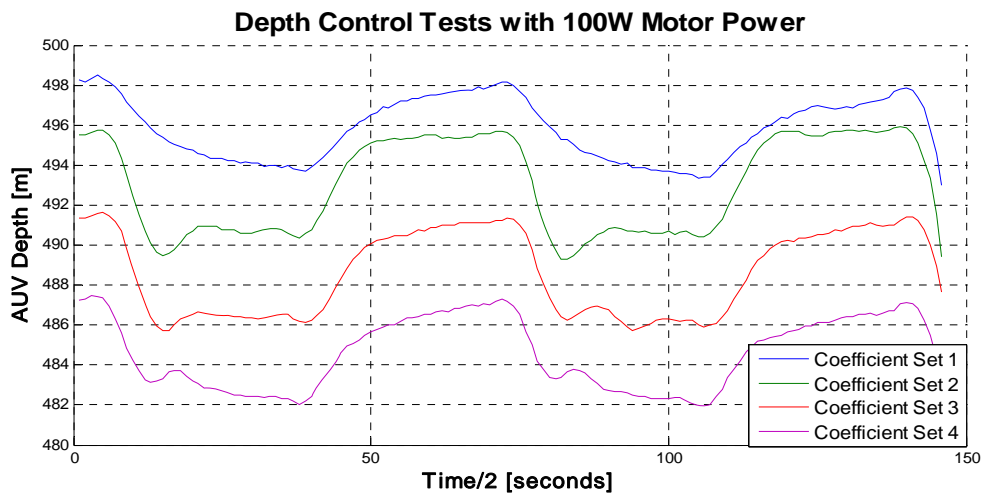
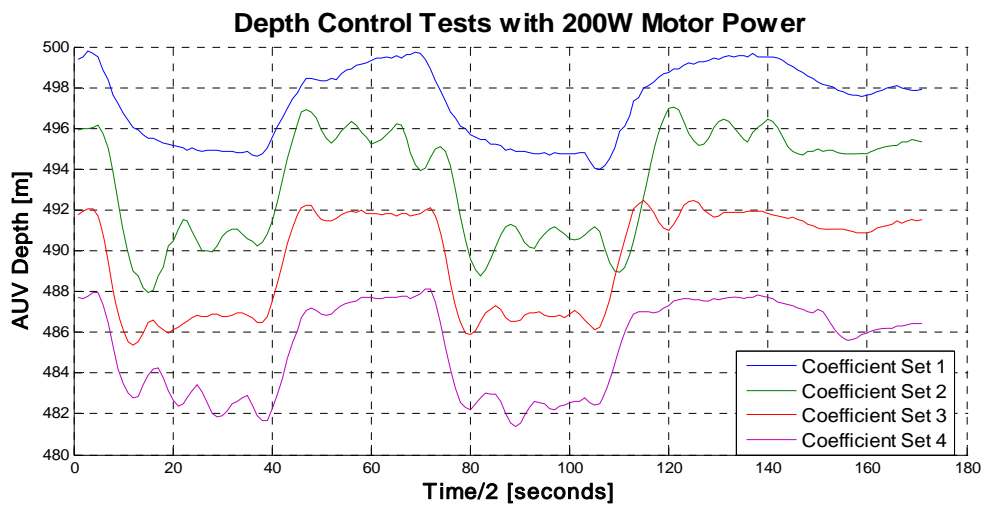
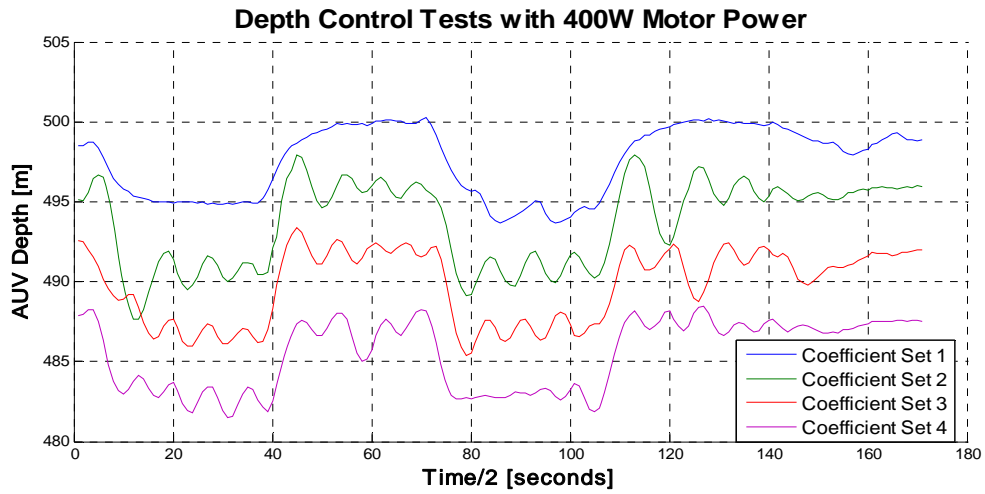

Figure 5 – Depth Control Tests at Varying Motor Powers with Different Control Coefficients . See Table 4 for description of control coefficient sets.

	<b>Pz</b>	<b>Dz</b>	<b>Ppitch</b>	<b>Dpitch</b>
<b>Coefficient Set 1</b>	0.04	0	2.2	4
<b>Coefficient Set 2</b>	0.12	3	2.2	4
<b>Coefficient Set 3</b>	0.1	3	2.2	4
<b>Coefficient Set 4</b>	0.08	4	2.2	4

*Table 4. Depth Control Coefficients used for Depth Control Tests*

## **6.6 Autosub6000 Linkquest Acoustic Tracking and Telemetry**

Miles Pebody

### **System Description**

The primary acoustic tracking and telemetry system on Autosub6000 is a Linkquest TrackLink 10000LC Ultra Short Baseline (USBL) tracking system with a TN10010CR transponder that includes the acoustic communications option. This system provides ultra short base line (USBL) tracking with digital telemetry data being appended to the end of each tracking interrogation and reply . The maximum length for a digital data message is 80bytes.

Specifications of USBL system:

Positioning accuracy	3°
Slant range accuracy	0.4m
Frequency	7.5KHz-12.5KHz
Operating beam width	120°

The equipment installed on the Autosub6000 consisted of an interface to the vehicle's control network and power, the transponder electronics and a single transducer head. The ship side equipment was mounted in a standard Precision echo Sounder (PES) fish body with an Ethernet connection to two computers. One computer ran the Linkquest TrackLink software and the other the NOC Autosub6000 telemetry control and logging software. The layout of both these systems is shown in figure 6.

## Autosub6000 Acoustic Telemetry - Shiptside

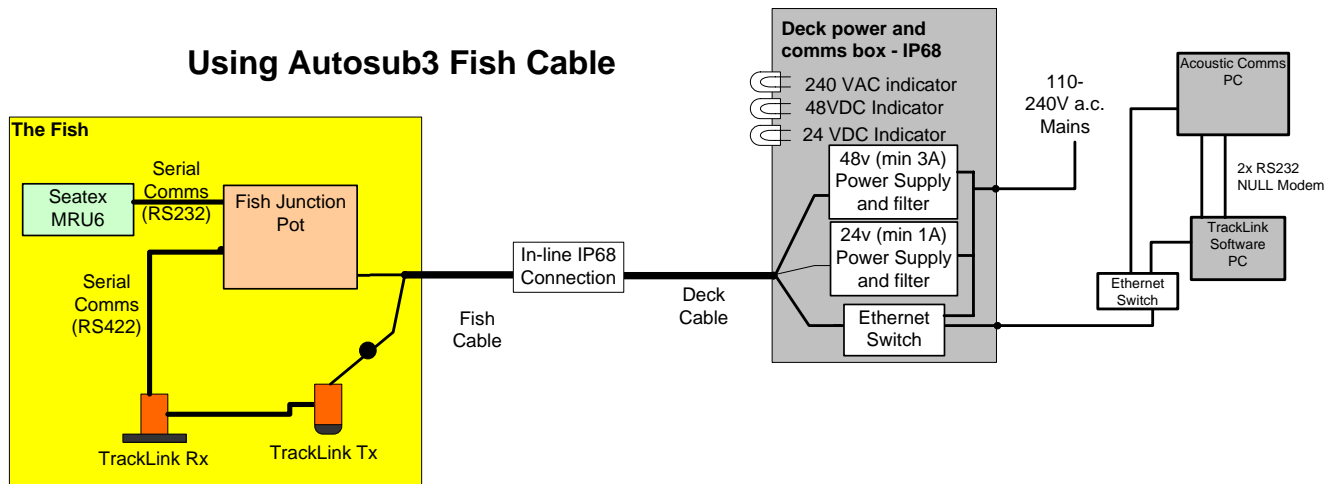

## Autosub6000 Acoustic Telemetry - AUVside

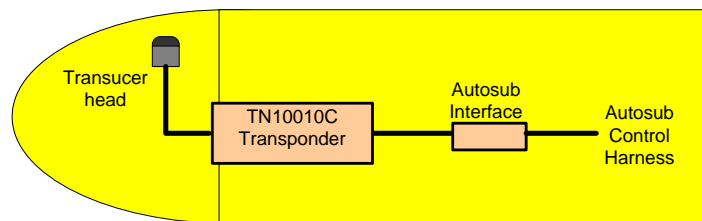

*Figure 6. Ship side and AUV side block diagram.*

For the purposes of digital telemetry communications the TrackLink provided a modem functionality with a first in, first out data stream. A data message was formatted by the telemetry computer and written via a serial port to the TrackLink computer which in turn transmitted the message to the AUV transponder as part of the next tracking interrogation. The AUV transponder then sent a serial data message to the Autosub6000 control system. Data messages from the Autosub6000 returned along the same path to the telemetry computer. Status data returned from the Autosub6000 included depth, heading, altitude, water speed, position and other items for confirmation of mission progress and safe operation.

Localised attitude information was used to provide heading corrections for the tracking bearing data (as the PES fish was able to swing independently from the ship) and for the support of AUV ranging data acquisition. This information was acquired from a Seatex MRU6 attitude sensor that was installed in the PES fish. This data was streamed to the telemetry computer and logged.

The ships heading and position was also logged by the telemetry computer. This information came from the ship's NMEA data stream. Sentences used were GPGGA and HEHDT sentences.

<b>Data Stream</b>	<b>Source</b>	<b>Format</b>
Tracking data	Linkquest TrackLink software on tracking PC	TP2 (out of choice of TP2, LXT, GPGLL)
Telemetry data	Autosub (via TrackLink)	See Autosub telemetry documentation.
PES Fish attitude	Seatex MRU6	Proprietary binary
Ship heading and position	Ship's data system via serial port patch.	NMEA: GPGGA, GPGLL, GPRMC and HEHDT

*Table 5. Autosub6000 Telemetry Data Streams*

## Discovery Installation

The two computers were located in the main lab and communicated with an Ethernet switch in a power supply box at the top of the PES fish cable via a private (the Autosub) local area network. The deck power supply box for the PES fish was located in the chemistry lab with cables running to the outside and PES fish winch on the deck above via a near by gooseneck. When deployed over the port side, the fish was outboard some 2m and at a depth of 12m (ship's draft 5m). The depth rating of the Linkquest equipment is not certain, being documented at 20m a figure of 15m has also been quoted. The NOC junction pot has been tested to 3.5bar.

Finally a serial feed was provided from the ship data logging and distribution system giving NMEA sentences: GPGGA and HEHDT for ship position and heading.

## Operations

The tracking and telemetry system was used on Autosub6000 missions 1 – 5. During the recovery of the AUV at the end of mission 5 the Linkquest transducer on the vehicle was damaged. This prevented any further missions that required telemetry and control. However the data collected was sufficient to provide a good indication of the systems performance.

Key objectives of the trial missions are listed in table 6:

<b>Name</b>	<b>Detail</b>	<b>Method (summary)</b>
Range of USBL and telemetry - deep mode	Establish slant range of USBL tracking and telemetry system, when AUV is within 90 degree included angle under the ship (up to 4500m deep, 4500 m offset = 6400 m ).	With ship stationary above AUV position, run AUV 4.5 km away and back.
Acoustic Positioning	To collect TrackLink USBL tracking data such that the AUV can be (post mission) positioned at better than 5m accuracy at 4500 m depth.	Collect Tracking data when AUV carries out 1km side box when at 4500 m depth.

*Table 6. Tracking and Telemetry Objectives*

Mission 2 data initially showed that the tracking and telemetry were working reliably. Of particular note was the consistent performance of the telemetry messages with virtually every message transfer in both directions being successful. However for deeper and longer ranges data showed that the system may have not been performing optimally. This was suggested by inconsistent returns from a depth of 4500m directly bellow the ship. In light of this, subsequent missions were run with the acoustic transducers fully exposed to open sea water on both the PES fish and on the AUV, with respective GRP panels being cut and the transducers being moved so that they were proud of the hull.

Mission 3 data showed that in the very early stages of the mission the system was performing very well, as it had at the closer ranges of mission 2. However, after approximately 130 minutes the return of telemetry messages became sporadic with a ratio of one message in eight being successfully returned. This ratio was consistent irrespective of the interrogation rate and can be seen in the figure 2 plot as 120 seconds between telemetry replies for a 15 second interrogation rate and 160 seconds for a 20 second interrogation rate. Observation of the telemetry computer display and logs of raw data showed that whilst telemetry interrogations and downlink telemetry request messages were being received and responded to by the AUV, the return data was arriving corrupted. This was despite the following actions:

- Reduce rate of tracking interrogation and telemetry requests.
- Send a wakeup call to the AUV transponder.
- Restart both computers and software.
- Reset power to Linkquest transceiver in PES fish.
- Ensuring that all ship's acoustics were switched off
- Ensuring that all the ship's thrusters were not running.

It was not possible to reset or power cycle the transponder in the AUV. Communication was made with Linkquest but no recommendations were received. Following discussion with LinkQuest, it now seems almost certain that these problems were due to firmware faults within the LinkQuest transponder (which the manufacturer is investigating).

The performance of the system during mission 4 was very stable (figure 7). It was possible to gather data at extreme ranges to ascertain the capabilities of both tracking and telemetry. Mission 5 however, from the outset showed the same degraded performance symptoms as in the later stages of mission 3.

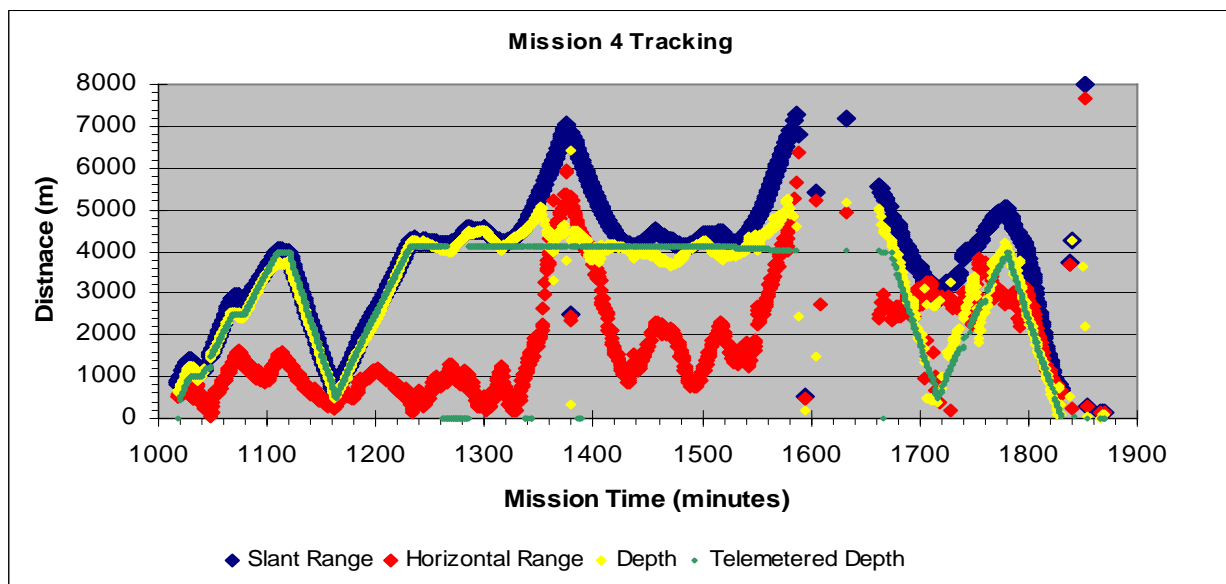

Figure 7. Showing tracking: blue – slant range, red horizontal range, yellow tracking depth and green telemeter depth. It is clearly demonstrated that the Linkquest tracking system is performing to its specification of a maximum slant range of 7000m (up to 7790 m). From approximately 1590 minutes until 1660 minutes there was no tracking or telemetry. During this period the ship had moved away from the area of operations and so the AUV was out of range.

## Conclusions

The one problem observed with the Linkquest system was with the telemetry return from the AUV. Whilst tracking and downlink telemetry transmission worked throughout the missions, the AUV transponder, on two separate missions, irrecoverably entered a mode in which it would only transmit a coherent message once in every 8 or 9 attempts. In this state of operation however, the message that was returned was returned without corruption and at all times the downlink telemetry was working allowing the Autosub6000 to receive commands from the support ship as well as be tracked up to and over the full specified range of 7000m.

### 6.7 The Autosub6000 Pressure balanced Lithium Polymer Batteries

David White

Key to the range performance of the Autosub6000 is the development at NOC of the pressure balanced Lithium Polymer Rechargeable batteries. For the trials Autosub6000 was fitted with three batteries, each with a capacity of 4500 W hours at a nominal 57 volts. Battery serial number #002 developed a fault in its charging circuit after the 2<sup>nd</sup> Mission and was removed, but the other two, #001 and #004, completed all eight missions with no problems to report. The charger functioned without fault.

### Charging

The batteries were charged, starting at 14, and deemed to be sufficiently charged when the charging current dropped below 1A. After each mission, they received a six hour charge, which generally injects about 60Ah into each battery, plus a top-up charge where possible. It is estimated that 12 hours will fully charge a completely flat battery. Based on the log of battery charges, the two batteries will give about 20 hours of running at average speeds. The measured and derived charging curves are shown below.

Ambient temperature during charges was 15<sup>0</sup>C to 20<sup>0</sup>C, rising to a maximum of 22<sup>0</sup>C after twelve hours.

### Fault on pack 2

While charging after mission M2, pack No. 2 switched off prematurely, while still drawing between 3 and 5 Amps. Attempts to restart the charge showed the current start up, then switch on and off, intermittently, suggesting an intermittent open circuit between the battery and the latch.

Investigation showed that the latch was not working, and several components had failed. The cause of failure was traced to a connection between the detector side of an opto-isolator and somewhere in the battery chain itself. This is most likely to be a fault with the board itself, and not field-repairable, so the battery was removed from the vehicle for the remainder of the cruise.

### 6.8 The Sonardyne USBL system and Compatt transponder

David White

A compatt5 transponder was mounted in the tail section of Autosub6000 as a backup to the LinkQuest system (figure 8). It was also interesting to compare the performances of the two systems.

The ship mounted USBL transceiver is mounted on a pole that passes through a gate valve in the ship's hull. The manual gate valve opening mechanism required attention by the ship's engineers at the start of the cruise, but worked satisfactorily thereafter.

The software on the USBL transceiver was upgraded by a Sonardyne engineer prior to the ship sailing. After considerable trouble, he was able to demonstrate the Compatt and a mini beacon transponding and communicating whilst alongside. When transponding, the system worked well and tracked the vehicle at 4100m to a horizontal range of 1.7km reliably, and intermittently to a range of

2.7km. When it failed, the problem was almost invariably due to the intricately constructed software in the deck unit.

The Compatt beacon was initially in a disabled state, ready to be used when Autosub was launched. It was mounted inside the aft section of the vehicle. On the first deep mission (Mission 2) the Compatt failed to transpond or reply to any acoustic communication down to a range of 300m. Removing it from the vehicle, it was found to be fully disabled and had not heard any acoustic command. It was enabled for tone commands and then enabled in wideband mode acoustically, while deployed on a wire test. It was left in that state for the next mission, when it was mounted with the transducer protruding through the fairing.

At the start of Mission 3 it transponded and replied to digital communications down to a depth of 4280m and a horizontal range of 1300m. Tracking was disabled to carry out tests on the LinkQuest system, and thereafter no attempt at transponding, digital communications, re-initialisation or enabling in any mode was successful, even at ranges of 1000m or less. There was also no tracking on Mission 4, during which the deck unit apparently died.

Sonardyne were able to provide a solution for the deck unit problem. It was determined that by taking the beacon offline, we had inadvertently disabled the wideband mode; the range in tone (PPM) mode in Autosub-6000 is very limited. It was re-enabled in wideband mode, which can only be done acoustically, with the vehicle circling below the ship at 100m. Thereafter it tracked the vehicle well, with a maximum range of 2.7km at a depth of 4100m. It was left enabled in wideband mode and tracking was stopped by exiting the navigation mode.

The deck unit gave further problems, apparently caused by its software rather than outside causes, resulting in temporary loss of all NMEA data and permanent loss of VRU data. Despite this it was possible to track the vehicle with acceptable accuracy on all subsequent missions.

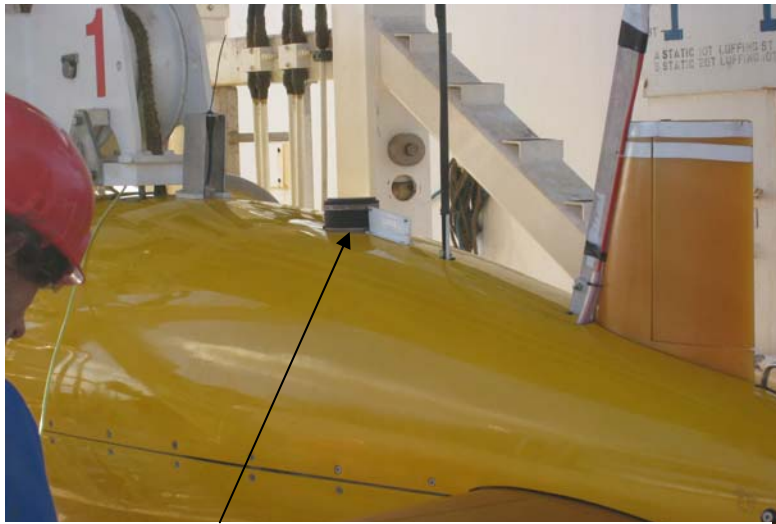

*Figure 8 Compatt 5 mounted in Autosub6000*



## 6.9 Autosub6000 Mechanical Configuration

Peter Stevenson.

### Mechanical build record

Autosub 6000 is similar to Autosub 3 in the design of the nose and tail sections. The major change is in the centre section which houses the lithium polymer secondary batteries and provides the full ocean depth buoyancy by means of Emerson and Cummins EL36 syntactic foam. The location of the AUV subsystems is as follows:-

#### Nose Section

- Argos Beacon and aerial
- 2 x strobe lights
- Linkquest telemetry and tracking system
- Recovery line hopper

#### Centre Section

- Syntactic Foam buoyancy
- Lithium polymer batteries
- Snatch recovery line

#### Tail Section

- Propulsion motor
- Control fins and actuators
- Additional syntactic foam
- PHINS INS with 300kHz ADCP assembly
- Digiquartz depth sensor
- Argos Beacon and aerial
- GPS aerial
- Radio Ethernet aerial
- Logger electronics tube
- Power and Control electronics tube
- Interface electronics tube
- Battery charge port
- Recovery line hopper

### Ballast and trim of the vehicle

The ballast and trim of the Autosub6000 was set up at NOC to be 20kg buoyant in  $1025.52 \text{ kg.m}^{-3}$  sea water and neutral trim (i.e lies horizontal in the water). The vehicle dived without difficulty during Mission 1 and flew with a small negative pitch (nose down) and small positive sternplane angle (sternplanes up) showing the vehicle was buoyant and had a good reserve of sternplane travel to control diving and surfacing. The ballast and trim of the vehicle remained unchanged for the whole cruise but lead ballast did have to be adjusted at sea for:-

- Moving of an Argos beacon and aerial from the nose section to the tail section.
- Removal of battery pack No2.

The following files record the ballast and trim history:-

- Autosub6000\Ballast+Trim As6k\NavAsub6k 3BattPackact.xls (Initial estimate at NOC)

- Autosub6000\Ballast+Trim As6k\NavAsub6k 2BattPack At Sea 21\_09\_07.xls (Ballast changes made to account for moving Argos beacon and removing battery pack No2)
- Autosub6000\Ballast+Trim As6k\NavAsub6k 2BattPack At Sea 23\_09\_07.xls (Update to account for removal of Compatt5 transponder guard; no ballast change made)

## **Launch and recovery**

The refurbished Autosub gantry was used for the launch and recovery of the vehicle, bolted to the bed frame previously made for the Discovery to spread the loadings over 6 pitches of the M24 deck matrix. The gantry was connected to the ship's hydraulics, motor No2, valve No5, with the pressure increased up to the maximum possible (180bar)

The recovery procedure was changed from recent practice of using an intermediary floating line between the sub and the gantry lines. The procedure we adopted was:-

- Ships' crew to grapple the taught line mounted above the backbone of the sub (like a taught washing line). The attached main recovery lines stored in hoppers in the AUV are then pulled out,
- The AUV recovery lines are tied to a gantry winch line routed around the starboard quarter to midships.
- The ship manoeuvres ahead and, if possible, away from the sub; the lines are carefully managed to prevent excess lines floating in the water.
- The winch line is hauled in, the two AUV lines are hooked to the two winch lines and the sub is winched out of the water.

The method worked better than using an intermediary line as there were less operational steps to carry out, the sub had a shorter distance to be towed and the two sets of lines became less twisted.

The grapples were purpose made, being much smaller than a conventional ships' grapple with lighter line and fitted with non return clips to prevent the 'washing line' from becoming unhooked. These met with the approval of the crew who found them easier to throw and quicker to recover.

The ship was consistently difficult to manoeuvre away from the sub once the lines had been tied in the midship area. The Linkquest transponder was damaged during one recovery when the AUV became sucked beneath the ships' counter. Other than this, no damage was sustained to the AUV during the eight launch and recoveries beyond sometimes snapping aerial masts and control fins slipping on their shafts. These are a feature of the design, enabling a fast and cheap replacement and avoiding potentially expensive and time consuming repairs.

## ***7. POL D323 Cruise Trials Summary***

S Mack, C Balfour and D. S. Jones

### **Overview**

This document gives a brief outline of the trials undertaken by POL during the Discovery 323 cruise. The cruise has presented an excellent opportunity to test some of the key instrumentation and scientific measurement techniques that will form the cornerstone of future scientific fieldwork campaigns to be undertaken by the laboratory.

**Pre Cruise Check In – Tuesday 18-09-07 :** During embarkation day the opportunity of a stable ship was used to check the buoyancy of the mini MYRTLE (multi-year return tide level equipment) frame, as shown in Fig. 9.



a – MYRTLE Plus Ballast Weight Lowered from the Aft Deck of Discovery

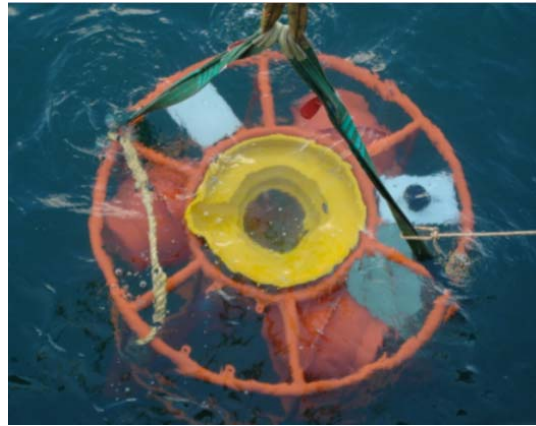

b – MYRTLE Buoyancy Test

*Fig. 9 – Mini MYRTLE-X Buoyancy Test*

**Day 1 – Wednesday 19/09/07:** The first full day on board was used to unpack, check equipment and begin assembly of the upper part of the telemetry buoy, perform initial instrumentation diagnostic checks etc.

**Day 2 – Thursday 20/09/07:** During day 2 of the cruise the upper part of the telemetry buoy was assembled and tested on the aft deck of the ship as shown in Fig. 9a. The SAMS UWM 4000 LinkQuest modems were also set to low power mode and used to transfer data from a Seabird Microcat CTD to the telemetry modem using an acoustic data link. A picture of this setup are shown in Fig. 10.

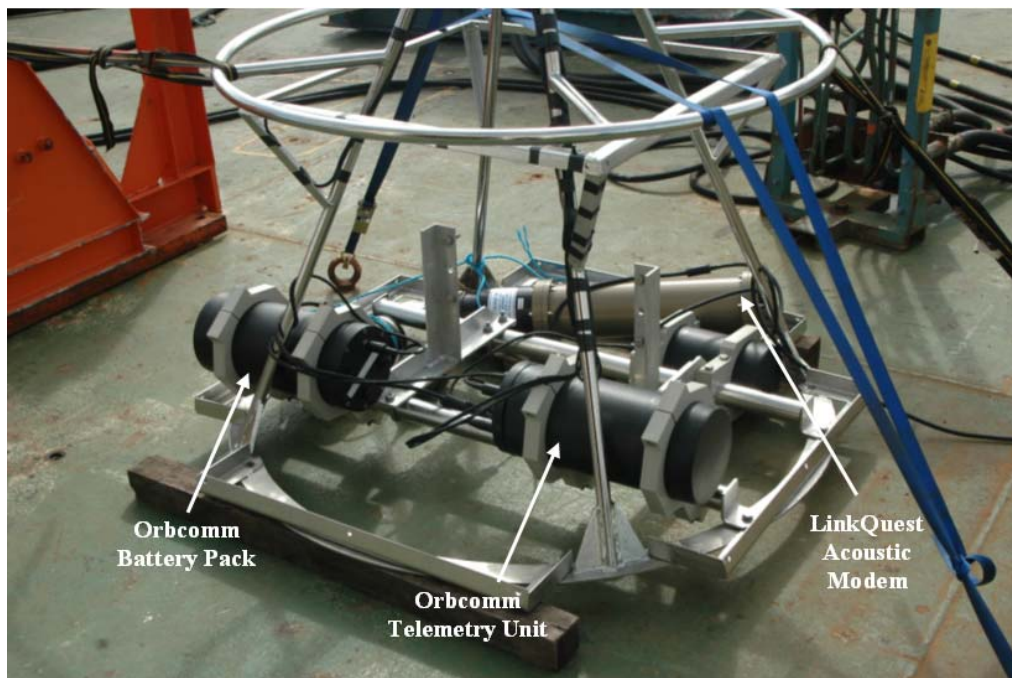

*Fig. 10 – Telemetry Frame and a Low Power Acoustic Data Link In Air Using the SAMS UWM4000 LinkQuest Modems*

**Day 3 – Friday 21/09/07:** Assembly of the enhanced release mechanism for the Benthos acoustic data link and testing of the sea bed power and data cables for MYRTLE was undertaken in the wet lab of Discovery. A progress report was emailed to POL and a request to confirm that the test data transmitted during yesterday’s deck trial was successfully received. A series of experiments were then undertaken with the 2000m depth rated FSI NXIC CTD on load from NOC. This testing was aimed at developing a procedure to configure the FSI CTD for a wire test via the POL scaffolding frame to a depth of <2000m in conjunction with a Microcat. This should provide a CTD cast like comparison between the measurements of the two instruments.

**Day 4 – Saturday 22/09/07:** Favourable conditions during the day have presented an opportunity to perform a wire test using the POL scaffolding frame. The forecast is for the weather to deteriorate later this evening meaning that daytime would be the last chance until the weather breaks to test the CTDs and the Benthos acoustic link. Unfortunately, a few technical problems with the reed switch operated power supply to one of the glass spheres meant that there was a delay in the re-assembly of the frame after the source of the problem has been identified. This meant that the test had to be postponed to the following day in order to make way for other experiments scheduled during Saturday.

**Day 5 – Sunday 23/09/07:** Favourable weather conditions remained so a ‘wire test’ was scheduled for lunchtime. Discussions with the ships crew and the PSO revealed that the scaffolding frame was probably not strong enough to withstand the forces involved when it is suspended from the side of the ship to a depth of > 2000m.



*11 a – Assembled and Enhanced Scaffolding Frame*



*11 b – Modified frame in Background and MYRTLE Weight Disk Based Ballast in Foreground*

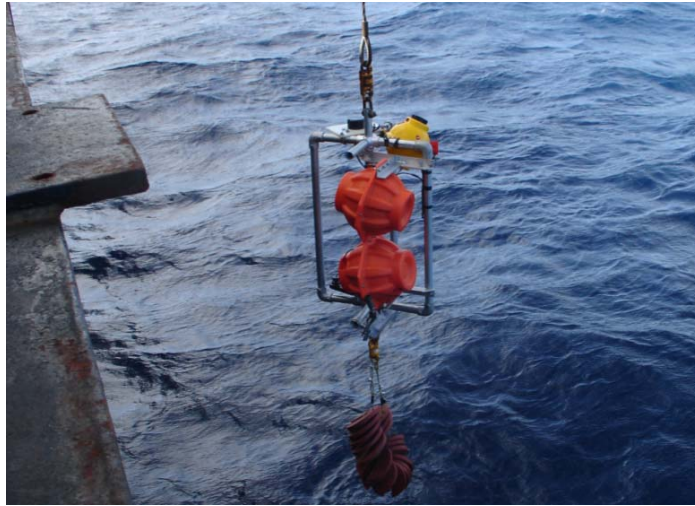

c – Frame Deployment for Glass Spheres, Benthos Acoustic Link and Modified Release Assembly

*Fig. 11 – Scaffolding Frame With Spheres, Benthos Transducer and Release Test Mechanism Plus a Lead Ballast Weight*

It is likely that during a deep deployment of the frame, the ships movement can be transferred into forces exerted on the frame couplings that are likely to cause standard grub screw lock based scaffolding clamps to fail. The frame was extensively modified to include shackle mounting holes at either end of the central mounting pole. An enhanced ballast arrangement was also constructed using all 18 of the 10Kg MYRTLE additional ballast disks mounted on plastic coated steel cable. This cable was looped through all of the available MYRTLE weight disks. The steel cable was then tied using a reef knot and locked using two pairs of bulldog clamps one pair at either side of the cable knot. This formed a 180Kg ballast load that was shackled to the bottom of the scaffolding frame along with an additional 40Kg lead ingot to provide >200Kg of ballast. This enhanced and strengthened scaffolding assembly is shown in Fig. 11. All of the instrumentation was mounted on the central scaffold pole that was now shackled at either end. This central pole provided the main load bearing part of the structure and eliminated any excessive loads being exerted on the standard scaffolding clamps.

During this trial a high speed Benthos acoustic data modem was tested along with a standard Benthos acoustic transponder. The main purpose of this test was to assess the maximum depth at which the Benthos high speed data link could operate. This trial was also intended to confirm the correct operation of the Standard Benthos transponder at 4000m, which is typical of the of depth that the MYRTLE frame is likely to be deployed during the cruise. The frame was lowered at a rate of 20 metres per minute at a GPS location of 47° 34' 48.90" N and 10° 09' 44.85" W.

**Day 6 – Monday 24/09/07:** Although the weather had deteriorated over the evening to such an extent that other scheduled experiments for the cruise were suspended, it was still possible to perform a second wire test during the morning. For this test the Seabird Microcat CTD, FSI NXIC CTD and Benthos standard acoustic transponder + release mechanism were mounted on the scaffolding frame as shown in Fig. 12. The Seabird CTD was configured to sample temperature, conductivity, pressure and derived PSS-78 salinity at 30 second intervals, starting at 09:40GMT. Due to the FSI NXIC CTD having a capability to make measurements at a higher sample rate than the Seabird Microcat, the FSI CTD was configured to measure the same parameters as the Microcat at the same logging start time with an increased sample rate of 10 second intervals. The intention of this test was to assess the relative measurement performance of each of the manufacturers CTDs to a depth of 1800 metres. At the same time, a CTD cast like data set will be generated for the specific location of the trial. The test was started at 10:15 GMT at a GPS location of 47° 21' 45.89" N and 10° 09' 44.85" W and lasted ~4.5 hours. A separate graph of the recorded data for each of the two CTDs is shown in Fig. 13.

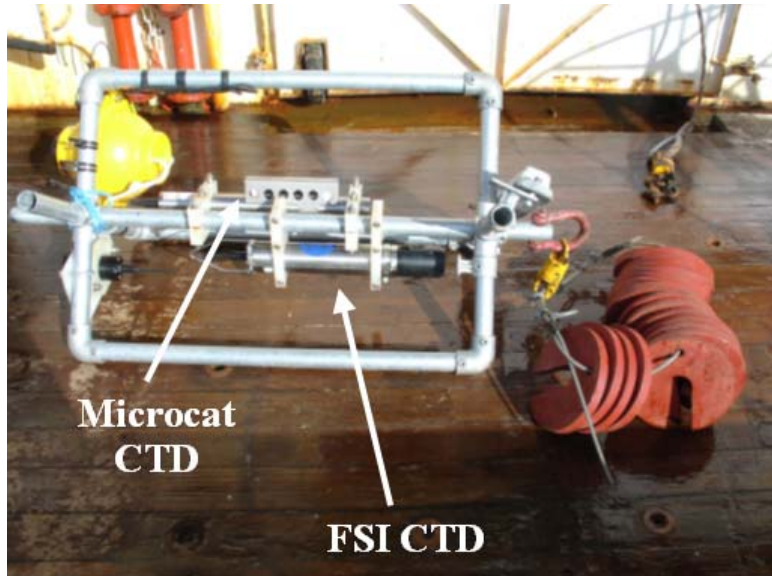

Fig. 12– Scaffolding Frame Wire Test With Seabird Microcat CTD, FSI NXIC CTD and Benthos Acoustic Release

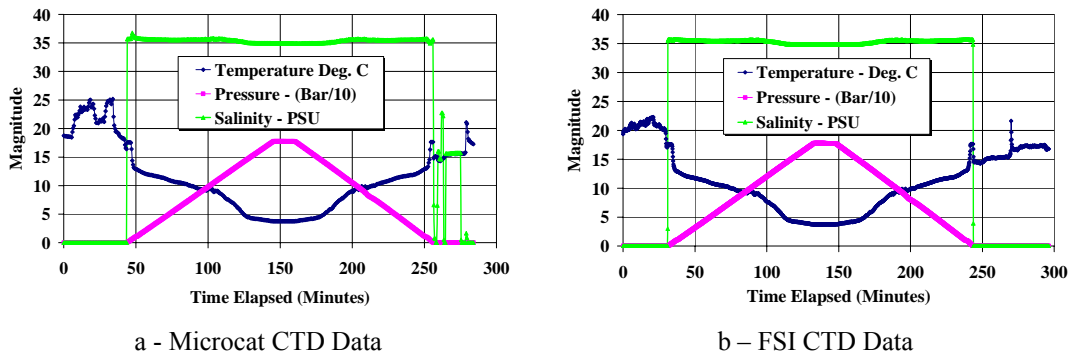
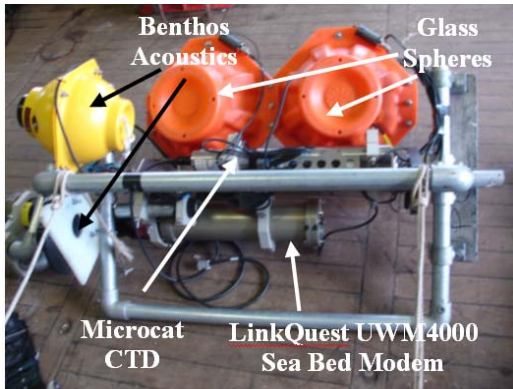

Fig 13 – Seabird and FSI Measurement Comparison for a 1800m CTD Cast

**Day 7 – Tuesday 25/09/07:** With weather conditions not being ideal there was an opportunity to do another wire test later in the day before Autosub was deployed. This trial was undertaken at a GPS location of 47° 54' 38.10" N and 11° 22' 10.87" W. The key details of the trial were:

1. Previous problems with the Benthos XT6000 acoustic transponder resulted in lack of confidence in the release mechanism working in 4000m of water. Therefore, unless the cause of the problem can be identified and fully rectified, it is probably not worth the risk of deploying MYRTLE in case it is not possible to recover the frame due to a defective release mechanism. The Benthos acoustic transponder is normally one of the most standard and reliable systems and it was a real surprise problems were experienced with this unit.
2. The POL scaffolding 'wire test' rig was modified to accommodate the MYRTLE instrumentation (two glass spheres – one power and one with multi release control electronics, the new Benthos acoustic link, the suspect Benthos acoustic transponder, a UWM4000 bottom LinkQuest modem and the 7000m rated Seabird Microcat CTD). This allowed a wire test from the side of the ship to simulate a MYRTLE deployment. Pictures of the setup are shown in Figs. 14a and 14b.
3. A scaffolding bracket was constructed to mount the SAMS UWM4000 LinkQuest surface modem. This allowed the modem to be safely suspended from a line over the side of the ship to form an acoustic data link with the instrumentation on the scaffolding frame. It took most of the day to complete the construction of these rigs.



a – Assembled Scaffolding Rig

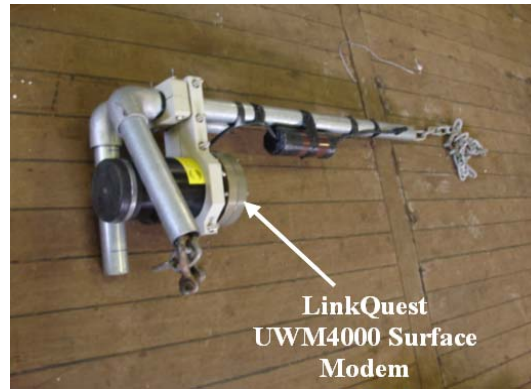

b – Assembled Surface Modem Mounting

*Fig 14 – MYRTLE Instrumentation for the Scaffolding Rig Wire Test*

At approximately 5:30 pm there was time in the cruise plan before Autosub was deployed to perform a wire test with the POL instrumentation and the key features of this trial were:

1. The scaffolding rig with the MYRTLE instrumentation was slowly lowered to a depth of 4000m and returned to the surface using the ships winch.
2. An acoustic link was established with the instrumentation using the SAMS surface modem, which was suspended over the side of the ship so that it was just below the sea surface, and the sea bed modem that was mounted on the frame.
3. The Microcat was configured to output CTD data every 5 minutes to the surface via the LinkQuest modem acoustic link. This data was connected to the Orbcomm telemetry system which was set up on the upper part of the telemetry buoy. The Orbcomm telemetry buoy assembly was located on the aft deck of the ship and the Orbcomm satellite system was used to send the measurements to POL.
4. When the scaffolding frame was at a depth of >1500m, a BGAN satellite based internet link was then set up on the deck of the ship, as shown in Fig 14. A ‘webmail’ internet based email account was then accessed and used to send an email to the Orbcomm telemetry modem on the aft deck of the ship. This email included a command code to change the Microcat sample rate from one measurement every 5 minutes to one measurement every 10 minutes.
5. Approximately 10 minutes later this command was received and the Orbcomm telemetry unit implemented this change by scripting commands, via the acoustic link, to the Microcat on the instrumentation scaffolding frame that was now at a depth of ~1500m. This sample rate change was successfully completed, clearly demonstrating remote control of the instrumentation.
6. The trial continued with the acoustic link successfully sending Microcat data every 10 minutes all the way to the maximum depth of 4000m and then back to the surface. These measurements were also successfully transferred using the Orbcomm telemetry system on the aft deck of the ship.
7. A different and more directional (not omni-directional as had been previously used) transducer was used with the Benthos high speed acoustic link. While this improved the performance of the acoustic link, the system still had problems with reliable communication in depths of sea water >1500m.
8. At the full depth of 4000m the suspect Benthos acoustic transponder was fired and this time the release mechanism worked.
9. The instrumentation was recovered at the end of the trial at approximately 11:30 pm and the Orbcomm telemetry unit was left switched on to report the ships GPS position and the time of the GPS fix at 20 minute intervals as it steamed to the Autosub trial location.

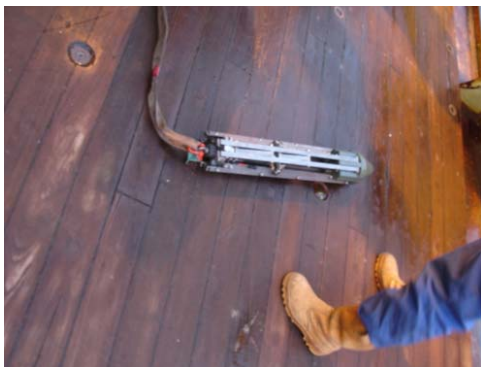

*Fig. 15 – BGAN Telemetry Trials*

While this was clearly not a MYRTLE deployment, this test fully demonstrated the operation of the instrumentation in 4000m of water. In addition to this, the ability to remote control the sea bed instrumentation via an email based command using Orbcomm telemetry and an acoustic link was also demonstrated. An internet connection was also established using BGAN from the deck of the ship. Therefore, this trial accomplished most of the prime objectives of the cruise without risking MYRTLE when the lander frame release mechanism is suspect.

**Day 8 – Wednesday 26/09/07:** This day was primarily reserved for Autosub and Microbiology core sampling operations and the available time was used to update the cruise documentation and plan future trials.

**Day 9 – Thursday 27/09/07:** Ship time had been allocated from 07:00 to 16:00 at a GPS location of 47° 34' 54.05" N and 10° 9' 06.21" W for POL trials. The first scheduled test involved shackling the POL MicroLander to the CTD winch and lowering it to a depth of 100m to check the release mechanism. Photographs of the MicroLander trial are shown in Fig. 16.



a – Microlander Ready for Deployment



b – Microlander Activated and Being Recovered

*Fig. 16 – POL MicroLander Wire Tests*



The test shown in Fig. 16 comprised of initially opening and closing the three legs of MicroLander to charge the internal pressure cylinder and then deploying the device over the side of the ship. A wire test to 100m depth was then undertaken and the subsequent raising of MicroLander back to the sea surface demonstrated that the foldable leg release mechanism had operated correctly underwater.

The second test that was undertaken was designed to test the Iridium based telemetry system used by the MYRTLE releasable data capsule. Fig. 17 shows pictures of the capsule deployment for the telemetry test. Testing of the correct operation of the data capsule was achieved by first using the BGAN telemetry unit to establish an internet connection on the aft deck of the ship. Once internet access had been established verification that the Iridium based data packet transfer had successfully occurred was undertaken. This was achieved by first accessing the email POL account that Iridium sends messages to via the internet. Then testing was undertaken which confirmed that the anticipated test data had arrived in the form of email attachments.



a –MYRTLE Data Telemetry Releasable Capsule Ready for Deployment

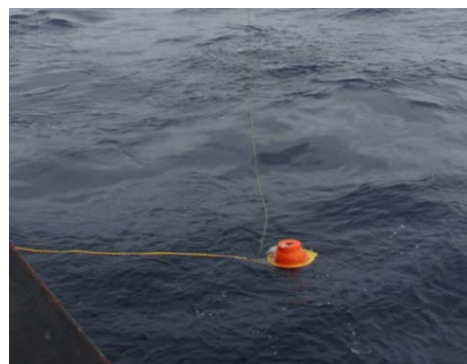

b – MYRTLE Data Telemetry Capsule Deployment

*Fig. 17 – MYRTLE Iridium Based Releasable Data Capsule Tests*

**Day 10 – Friday 28/09/07:** The Autosub trials from the previous day were still underway during the morning and this time was used to update the cruise summary documentation etc. The time available during the Autosub deployment was also used to plan the forthcoming trials for the remainder of the cruise.

**Day 11 – Saturday 29/09/07:** The scaffolding wire test frame was deployed over the side of the ship to perform a second full system wire test to a depth of 4000m. The LinkQuest UWM4000 surface modem was also lowered over the side of the ship to a depth just below the sea surface to establish an acoustic data link. The test was performed at a GPS location of 47° 30' 02.99" N and 10° 32' 51.88" W and started at 09:35 GMT. The primary intention of this test was to make full use of the ship time available to POL to consolidate the results from the previous full system wire test on Tuesday 25<sup>th</sup> September. The new Benthos acoustic data link and the XT6000 transponder were also evaluated during this trial. Initial data checks showed that the LinkQuest and Benthos data links were performing well. The Benthos XT 6000 transponder/acoustic release was correctly reporting the water depth when requested to do so.

1. The trial included testing of the LinkQuest and Benthos acoustic data links, testing of the Benthos XT6000 acoustic release (transponder), an initial seabird Microcat sampling rate of one measurement every 5 minutes and Orbcomm telemetry to relay the LinkQuest data to POL. An initial CTD winch wire feed rate of 20m per minute was used.
2. At 10:20 GMT the BGAN unit was used to provide an internet connection and an email command was issued to the Orbcomm telemetry system to change the Microcat sample rate to one measurement every 60 seconds.

3. After approximately 8 minutes latency the Orbcomm system processed this command and scripted, via the LinkQuest acoustic link, the sample rate change at 10:27 GMT, at a depth of approximately 750m.
4. As the depth increased, the LinkQuest data link became more problematic, probably due to acoustic noise. At around about this time, the Benthos acoustic data link failed and refused to respond.
5. At 2500m depth the CTD winch wire feed rate was increased to 30m per minute so as not to consume too much ship time for the POL wire test trial, which was already behind schedule (due to temporary water resistant seals being added to deck cables etc to cope with a series of outbursts of heavy rain during the initial phases of the trial).
6. Beyond 3000m depth the LinkQuest modems began to have difficulty meeting the required data transfer rate of one Microcat measurement every 60 seconds. From time to time some spurious characters would be sent to the Orbcomm telemetry unit from the LinkQuest modem and was tending to store several samples and then trying to send bursts of several bytes or several full samples at varying time intervals.
7. At approximately 13:00 GMT the full depth of 4000m was reached and BGAN was used again to allow a new and second email command to be issued to change the Microcat sample rate to one measurement every 10 minutes.
8. Several commands were sent to the Benthos XT6000 acoustic transponder to fire the release mechanism on test and the unit failed to acknowledge that the command had been received.
9. At approximately 13:10 GMT the CTD winch was started again to bring the scaffolding test frame to the surface at an initial rate of 60m per minute.
10. During the initial phase of the return of the test frame from a depth of 4000m the LinkQuest acoustic data link was very problematic, only sending occasional measurements.
11. At 13:28 GMT the command to change the Microcat sample rate to one measurement every 10 minutes was received by the Orbcomm telemetry unit.
12. At 14:10 GMT the winch was stopped with the measurement frame at a depth of 1500m and measurements at 10 minute intervals were being sent by the Microcat via the LinkQuest acoustic link to the Orbcomm telemetry unit.
13. The winch was then re-started at approximately 14:20 GMT.
14. At a depth of 860m the winch speed was increased to 60m per minute to speed the completion of the trial to allow ship time to be used for other experiments scheduled during the cruise.
15. Recovery of the wire test system at approximately 15:15 GMT showed that this time the Benthos XT6000 had successfully operated the burn wire release when it was triggered at a depth of 4000m even though an acknowledgement was not sent to the deck unit that issued the release command via a near the surface transducer.

**Day 12 – Sunday 30/09/07:** The ship was on station at GPS coordinates 47° 22' 46.70" N and 10° 11' 10.82" and Orbcomm telemetry system on the aft deck of the ship had been left switched on since yesterday to report the ships position at 20 minute intervals. The primary purpose of today's work was to test the operation of the MYRTLE releasable data capsule when it is configured for Orbcomm telemetry. Fig. 18 shows two photographs of the experimental apparatus. The capsule electronics was re-configured to use an Orbcomm antenna and data telemetry modem as shown in Fig. 18a. This arrangement, along with a battery power source, was then mounted on the MYRTLE frame on the aft deck of the ship which provided a convenient mounting location, as shown in Fig. 18b. The correct operation of the Orbcomm configuration of the data capsule was verified by observing the Orbcomm modem diagnostic 'log' port via a serial interface.

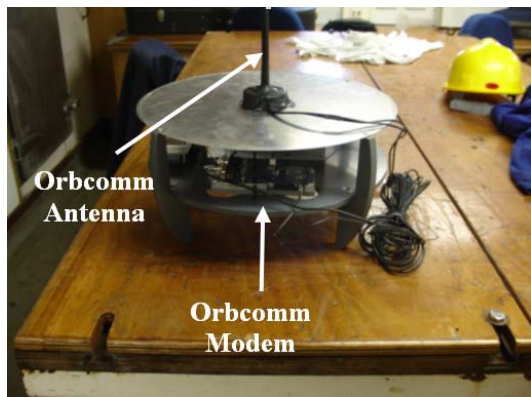

a – Capsule Electronics Configured for Orbcomm

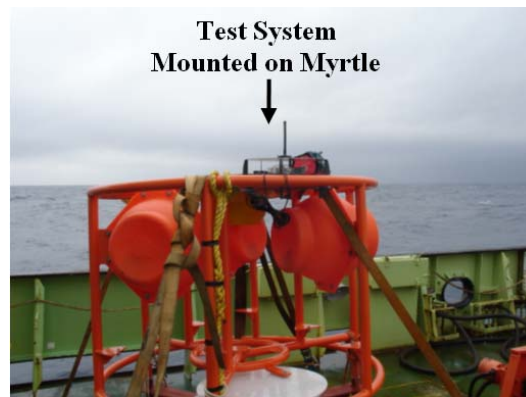

b – Capsule Electronics Fitted to MYRTLE Frame for Testing on the Aft Deck of the Ship

*Fig. 18 – POL MYRTLE Releasable Capsule Telemetry Tests Using Orbcomm*

## Summary

Reliability problems were observed with the MYRTLE lander Benthos XT6000 based acoustic release mechanism. Therefore a deployment of the MYRTLE frame and its complimentary surface based telemetry buoy was not undertaken. A series of wire tests were then developed to meet the objectives of the cruise. This allowed the time available for POL trials during the Discovery 323 cruise to successfully demonstrate some of the key instrumentation and techniques that are going to be used for future scientific work associated with the laboratory. A summary of the key achievements of the cruise is:

- The development of cost effective deep water ‘wire test’ rigs based upon re-configurable galvanised steel scaffolding sections and couplings plus an appropriate level of ballast weight.
- Comparison trials of two commercial CTDs when they are used for deep sea deployments. Namely, the Seabird Microcat (electrode type conductivity cell) and the FSI NXIC (shielded inductive type conductivity cell) instruments.
- Trials to determine the performance of the LinkQuest and Benthos commercial underwater acoustic modems when they are used for long distance underwater measurement data transfer.
- Bi-directional data transfer using an acoustic link over thousands of metres of sea water to re-configure deployed sea bed instruments. This was performed during two separate trials at two different locations.
- Remote measurement data transfer telemetry trials using the Orbcomm and Iridium global messaging services.
- Worldwide remote control of deployed deep sea instruments using an email based command interface and the Orbcomm low earth orbit satellite constellation.
- Remote internet access and telemetry system evaluation using the Inmarsat geostationary satellite based BGAN service.
- Verification of the correct operation of the POL MicroLander instrument deployment platform using a 100m wire test.
- Demonstration of the MYRTLE releasable Iridium based telemetry capsule that incorporates a Iridium based data telemetry. Subsequent verification of the correct operation of the capsule data transfer using BGAN.
- Re-configuration of the MYRTLE releasable telemetry capsule to use an Orbcomm data modem and subsequent verification of the correct operation of the capsule data transfer using serial communications based diagnostics.

## ***8. Megacoring Operations***

B Boorman, T Amaro, J Dinley.

Three stations at the same depth (ca. 4200 m) were sampled for macrofauna in the Whittard Canyon and in the King Arthur Canyon using the Megacorer. A total of 13 Megacores were taken. No samples were retained in the first 7 attempts (see table7).

### **Operation of the Megacorer**

The gear was fished on each occasion using a 10kHz pinger fixed 50m above the corer to help with landing the corer at an appropriate speed. Pay-out speed on the winch was always 40m/minute, recovery at 45m/minute and the gear the gear was landed and extracted from the sediment at 10m/minute.

There were a number of failures of the corer at the start of the cruise which can be put down to a combination of causes, namely poor ground, excessive swell, age of gear and a broken cross-brace on the corer. It is unknown whether the repairs to the cross-brace or the change of ground resulted in the obtaining of good samples, but it is suspected that the bottom of the thalweg is too sandy to allow a sample to be taken in these areas.

The authors would especially like to thank the bridge officers for their station keeping on this cruise in some tricky conditions.

### **Sampling for macrofauna**

At ca. 47.22.54 W and 10.10.96 W in the Whittard Canyon, 6 Megacores were taken. They were in general very good samples; most of the tubes had penetrated the sediment and had a clear overlying water (not disturbed). The upper 20 cm of the sediment were sampled in six sediment layers, 0-1, 1-3, 3-5, 5-10, 10-15, 15-20 cm. A cutting ring was used to slice the sediment. This was placed on top of the megacore tube, which had been placed on a plunger. A cutting plate was used to slice off each layer. The sediment layers samples 0-1 and 1-3 cm were placed immediately in a solution of 10% formaldehyde in seawater, prior to sieving. Each sediment layer was carefully washed with seawater through 300 and 500  $\mu\text{m}$  sieves, including the overlying water with the 0-1 cm sample. The sieved material was fixed immediately in 10% buffered formaldehyde in seawater.

The samples will be used for studying macrofauna diversity.

Station	Date	Gear	Location	Latitude	Longitude	Depth (m)	comment	Depth sampled
16369	22.09..2007	10+2	Whittard Canyon	47 37.00	10 11.28	4275	Mud on tubes but no samples	-
16370	23.09.2007	08+2	Whittard Canyon	47 37.03	10 11.25	4276	Good penetration, but no samples	-
16731	23.09..2007	08+2	Whittard Canyon	47 37.06	10 11.57	4278	Good penetration but no samples	-
16372	24.09.2007	08+2	Whittard Canyon	47 36.99	10 11.58	4280	Mud on tubes but no samples	-
16373	25.09.2007	08+2	King Arthur Canyon	47 54.54	11 21.96	4276	1off 10cm sample not retained	-
16374	26.09..2007	08+2	Whittard Canyon	47 37.01	10 11.61	4279	1off short core taken	-
16375	27.09.2007	08	Whittard Canyon	47 36.99	10 11.42	4277	Mud on tubes but no samples	-
16376	28.09.2007	08	Whittard Canyon	47 22.54	10 10.96	4241	7/8 good cores	31
16377	28.09.2006	08	Whittard Canyon	47 22.46	10 10.99	4245	4/8 good cores	14
16378	29.09.2007	08	Whittard Canyon	47 22.47	10 10.99	4243	8/8 good cores	29 cm
16379	29.09.2007	08	Whittard Canyon	47 22.53	10 11.02	4241	8/8 good cores	29 cm
16380	30.09.2007	08+2	Whittard Canyon	47 22.50	10 11.02	4245	6+1 good cores	25 cm
16381	30.09.2007	08+2	Whittard Canyon	47 22.50	10 11.02	4243	1+0 good core	18 cm

Table 7- List of the stations data for the Megacores carried out in the Whittard Canyon and in the King Arthur Canyon.

### Sampling for protozoan meiofauna

Two cores were taken from the Whittard Canyon at the depth ca. 4200 m.

One multicore was sliced at 0-0.5, 0.5-1, 1-1.5, 1.5-2, 2-3, 3-4, 4-5, 5-6, 6-7, 7-8, 8-9, 9-10 cm. And the other one was sliced at 0-0.5, 0.5-1, 1-1.5, 1.5-2, 2-3, 3-4, 4-5 cm.

A cutting ring was used to support the upper layers of soupy sediment. This was placed on top of the multicore tube, which had been placed on a plunger. A cutting plate was used to slice off each layer. The sediment was washed off the cutting ring into a storage bottle. Each layer was preserved in buffered formalin in 500 ml bottles. The samples will be used for protozoan faunal community analysis.



*Figure 19: Teresa Amaro, sampling a layer of sediment from a core taken from the Whittard Canyon*



*Figure 20: A core from taken showing layering. Top is soupy material, then a sandy layer, followed by a heavier mud.*

## **9. Acknowledgement**

This first trials cruise of Autosub6000 achieved all of its pre cruise objectives, an achievement which we had hardly dared consider. We also managed very useful acoustic and telemetry trials with POL, and succeeded, in the end, in sampling the seabed at the base of the Whittard Canyon. These successes are testament to the tremendous effort and contribution of every person on the RRS *Discovery*. I would like to thank the Master, Peter Sarjeant, and his crew for all their efforts on our behalf.

Stephen McPhail, Principal Scientist.