

CoA/N / M&P-8

CoA Note M & P No. 8.

ST. NO.
U.D.C. R. 30452/B
AUTH.

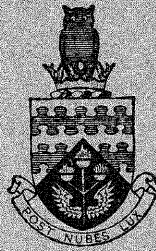

THE COLLEGE OF AERONAUTICS
CRANFIELD

AN EVALUATION OF THE BRITISH STANDARD
PROPOSALS FOR SYMBOLS ON MACHINE
TOOL INDICATOR PLATES

by

R. S. Easterby

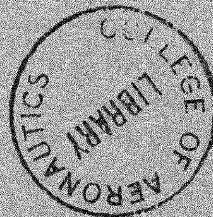

R 30452/B

March, 1965



THE COLLEGE OF AERONAUTICS

DEPARTMENT OF PRODUCTION AND INDUSTRIAL ADMINISTRATION

ERGONOMICS LABORATORY

AN EVALUATION OF THE BRITISH STANDARD
PROPOSALS FOR SYMBOLS ON MACHINE
TOOL INDICATOR PLATES

- by -

R.S. Easterby, B.E.E., A.L.C.

S U M M A R Y

The work detailed in this report has been undertaken as part of a research project supported by the Machine Tool Industry Research Association on Ergonomics and Machine Tool Design. In an early research project report, some comments were offered on the Draft British Standard for Symbols for Machine Tool Indicator Plates, and the Director of M.T.I.R.A. invited the author to elaborate on these preliminary criticisms. Although finalisation of the British Standard was imminent, it was realised that it would be remiss if a research project specifically devoted to ergonomics and machine tool design did not make a detailed and constructive assessment of the proposed standard symbols.

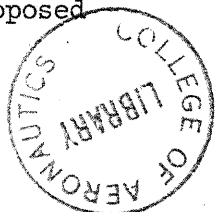

Summary (Continued)

This report presents an analysis of the British Standard (BS 3641:1963), Symbols for machine tool indicator plates, emphasising the principles of construction of sign systems, improvements in perceptibility and the standardisation of presentation for drawing office application of the standard.

Any language, and these symbols are a language, must have rules for defining the meaning of the signs and rules for their construction and use. The discussion presents an analysis of the requirements for the symbols leading to six basic symbol classifications, viz:

- Defining a direction
- Defining an element
- Defining a function

- Specifying a rate
- Specifying a manoeuvre
- Specifying a warning

Using this structure to classify the symbols will facilitate the extension of the standard range by the combination of symbols according to principles outlined in the report.

The fundamental features of visual perception relevant to the design of symbols are discussed. The ability of the operator to interpret a symbol is related to its perceptibility as determined by the stability and clarity of the figure/background relationship. This relationship is affected by such factors as continuity, closure, simplicity, symmetry, size, grouping and unity of the symbol forms. These last three characteristics are important if the range of symbols are to be seen as a unified set, particularly if the symbols are used in combined forms. From these theoretical considerations some practical guide lines are laid down for the design of symbol forms.

Finally it is suggested that some attention is paid to the application of the Standard. Since the effectiveness of a symbol is determined by its proportion as well as its shape, the proportions must be accurately specified, the presentation of all the symbols on a reference grid would avoid distortions of the standard form. It would also facilitate the design of different sized displays, and the layout and manufacture of composite displays.

Contents

	<u>Page No.</u>
Summary	
1. Introduction	1
2. Sign systems	1
3. Principles of perception	2
3.1 Definition	2
3.2 The determinants of perceptibility	3
3.3 Characteristics of figure: contour, closure and continuity	4
3.4 Characteristics of figure: symmetry, simplicity and unity	5
3.5 Characteristics of figure: effect of size, shape and form	6
3.6 Characteristics of figure: superposed forms	6
4. Practical design of symbols	7
4.1 The symbol system	7
4.2 Design of symbol forms	10
5. Presentation	11
6. References	12

Figures

Appendix 1

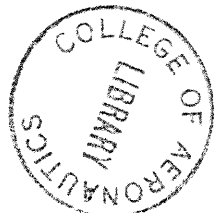

1. Introduction

The presentation of visual information in coded form is concomitant with the increasing complexity of machines. The more complex the machine, the greater the possibility that the operators' controls will have to be removed to some central situation where he will make the more critical decisions on the control of the system. Most control and display problems in the design of man/machine complexes involve design decisions on the balance between machine functions and human functions. If the machine exercises a large degree of control over the output, then the operators' displays require more critical attention from the engineering designer. Thus the increasing use of power elements in machine processes increases the value of visual display elements which assist the operator in schematising and understanding the functioning of complex hardware.

It is plain that attention to the elementary specification of size of letters, numerals and signs can make these display elements visible. Equally important, but not so immediately obvious, are the effects of changes in the form of the display. The engineering designer's task is to understand the process of information transmission by coding and decoding, where the decoding element is the human operator. The choice of code, i.e. the type of display, should therefore take account of the inherent abilities and limitations of the human operator.

The use of symbols to identify machine functions is an important part of this class of coding/decoding problem. Apparently, the designers task is simple; to devise a set of unified symbols for use in the context of machine tool controls. The difficulties arise when some attempt is made to unify these with some degree of objectivity on a national or international scale. If we are dealing with a subject as complex as human perception, the ideal solution will not be arrived at by discussions based on individual preference or experience. The scope for individual opinion comes later, after the basic perceptual problems have been identified and understood and a formal design framework established.

This report therefore defines the basic human characteristics involved in symbol perception in an attempt to offer an informed, objective and constructive criticism of the standard range of symbols and their application.

2. Sign systems

A necessary condition for the establishment of a set of signs, i.e. a symbolic language, is a systematic and rational method of construction. If this were not so, we should arrive at a different answer every time we attempted to interpret a set of signs. Thus, the derivation of a system of signs must be based on three principles, viz:

1. Pragmatics

There must be some agreed principle that the signs refer to a particular context: e.g. these signs apply to the users of machine tools.

2. Semantics

There must be an agreed set of principles for defining the relationship between the sign and the object to which the sign refers: i.e. the assigning of meaning.

3. Syntactics

There must be an agreed set of principles for the construction and combination of signs to make a language, i.e. the rules of syntax.

Before any detailed discussion of the symbol forms, these basic ideas must first be fashioned. Then, and only then, is it appropriate to speculate on the actual physical form of the symbols.

Implicit in language structure are semantic differences between the types of meaning of different signs (words). The parallel with ordinary speech is a useful one. We have different types of word: nouns, verbs, adjectives, pronouns, prepositions, etc. Obviously, an elementary sign system will have a small number of word types, but it is important to identify the basic type of symbol word required. We must specify nouns - signs standing for things or objects (i.e. in this application machine tool elements). There must be identification of verbs - signs standing for actions (functions) and there must be adjectives, signs describing other signs (directions, sense and type).

Equally implicit in the language structure are the syntactic rules for combining the symbolic words into symbolic sentences. Again the analogies with ordinary language are useful. The rules for combination must be agreed so that sentences can have a consistent meaning, e.g. noun plus a verb gives a transitive sentence (in our case element plus function gives manoeuvre). These principles of semantics and syntactics are more fully explained in relation to the machine tool symbols in Section 4.1.

3. Principles of perception

3.1 Definition

Perception is the process by which the data coming through the sense organs is integrated and supplemented by experience, so that it has some meaning for the observer. Our senses receive from the physical world changing sensory impressions which vary continuously in magnitude and variety. The development of a major part of our psychological processes since birth is directed towards the organisation of these sensory impressions to form a coherent, stable and consistent meaning of the outside world.

Thus we must not equate perceptions with the reception of sensory data. Sensation is the process of transducing the physical quantities of light,

sound, heat, etc., into properly coded nervous information. Perception is the organisation of this coded sensory data into meaningful concepts. For example, we can conceive of three dimensional space even though our visual receptors, our eyes, only form two dimensional images on the retina. Again, we can vary the perception of an object, depending on the context in which we see it or conversely our perception of an object is the same even though we see it differently, i.e. we receive a different set of sensory impressions. A table is perceived as a table with rectangular corners, even though we may view it from many different angles. This is because our perceptual experience tells us that this is the most useful way of organising these apparently different sense impressions corresponding to the one object, in this case a table.

The comprehension of this essential property of perception is essential to the understanding of its application to the design of symbols, for we shall explore in the following sections the detailed characteristics of visual perception and then subsequently apply them to the present problem of machine tool symbols.

3.2 The determinants of perceptibility

The perceptibility of a visual display is manifestly affected by more characteristics than the basic physical ones of size, brightness and contrast. The concept of perceptibility is quite distinct from that of visibility. Naturally, display elements must first be visible if they are to be perceived, but, the minimum requirements for visibility do not necessarily bestow the optimum conditions for perception.

Perceptibility means the ease with which one can assign meaning to a particular portion of a display. Thus there is a basic meaning associated with a particular shape (e.g. an arrow) and the apprehension of this meaning may be facilitated or hindered depending on how the form is defined. (e.g. in the case of an arrow the proportions of the shaft, head, etc.).

We distinguish things from one another by their shape and identify them by their form, and this distinction and identification are two stages in the perceptual process. The determinants of shape and form are the figures in the visual field which in turn are characterised by their contour. The contour may be defined by a line outline or, as in the case of a solid figure, a contrast boundary. This delineation of one part of the visual field from the other is called the 'figure/ground' phenomenon. It corresponds to the primary stage in the hierarchical process of perception; before we can identify any particular sections of the visual field we must structure it into the central part, the 'figure', and the less essential complementary part of the 'ground'. The figure has contour, solidity, saturated colour and is structured. Conversely, the field is diffuse and lacks substance. The figure is of course the feature which demands our attention and the sharpness and unambiguity of contour are two of the determinants of an easily perceptible figure. This phenomenon of the figure/ground relationship was

first recognised and investigated by the 'Gestalt' psychologists, Kohler, Wertheimer and Koffka and much of the perceptual theory we are interested in rests on their ideas and experiments. (Koffka, 1935).

With any perception process there is a spontaneous tendency on the part of the observer to segregate the incoming sensory patterns into groups. The observer segregates the visual field into separate comprehensible parts; some of these parts are ignored while the remainder command detailed attention. Even the apparently formless visual fields do not manifest themselves in human perception as entirely amorphous, unorganized masses. We strive to comprehend the superficially formless by perceiving multiplicities of figure groupings in an 'effort after meaning' (Bartlett, 1932).

From these principles springs the concept of 'figural goodness'. The perceptual processes, in attempting to decode the incoming visual stimuli, examine the different structural patterns for clarity and stability. The more this perceptual process is enhanced by the inherent clarity and stability in the visual sensations supplied by the form, then the more 'figural goodness' that form is said to possess. The percept i.e. the meaning of the form, is based on the clearest and stablest pattern. Thus, if we wish to avoid confusion and ambiguity, we must have forms possessing the maximum 'figural goodness' which in turn implies high internal organisation and stability of the visual form.

Consider the examples in Figure 1, which illustrate this principle. Figure 1(a) is an example of an unstable perceptual pattern. We may perceive it as a hexagon with interconnecting lines or as a cube viewed either from the top or bottom. It is difficult to stabilise on any one of these percepts. The figures 1(b), 1(c) show progressions from the less stable in 1(a), to the more stable form in 1(c). The illustrations progressing from 1(d) to 1(f) show an analogous set of signs based on the standard symbol 1.10 - Spindle rotation.

The primary influences on perceptibility are therefore a clear, stable and impressive definition of the figure/ground relationships (Vernon, 1952). The more detailed characteristics of the figure elements affect this primary requirement. We must therefore consider these detailed properties of contour, closure, continuity, symmetry, simplicity, unity, size, shape, form and the complex response to apparently superposed forms.

3.3 Characteristics of figure: contour, closure and continuity

For a figure to be defined it must possess a contour, and this contour can be generated by either a line or a contrast boundary. Lines we perceive appear as lines, not as areas, and although in strict geometrical terms a line is an area, psychologically this is not so. Lines do however have the attribute of shape and, more important, if a line forms a closed or nearly closed figure we no longer see a line on a homogeneous background but a surface figure bounded by a line. This surface figure is not as 'figurally

good' as an equivalent solid form bounded by a contrast boundary. The difference arises because the line bounded form is relatively less stable than the equivalent solid form. The line form is potentially ambiguous, since there is a surface figure bounded by the 'inside' of the line as well as that bounded by the 'outside'. Hence the superiority of the solid contrast bounded figure (silhouette) which has an 'outside' contrast boundary but no 'inside' boundary.

A discussion of contour involves two further issues - closure and continuity. Experimental evidence points to the superiority of closed figures - indeed the tendency of the perceptual process, again based on the organising principle, is to close the figure to achieve high internal figural organisation. These principles have been verified by Perkins (see Vernon, 1952) who demonstrated that, when subjects were asked to reproduce unclosed figures they invariably drew the figures as closed. Even when the unclosed portion of the visual field falls on the blind spot, the figure is perceived as a closed figure. The diagrams in Figure 2 illustrate this point, where 2(a) shows an incomplete cross which we perceive as a cross, Figure 2(b) shows the effect of closure on the perception of shapes bounded by nearly closed figures, as demonstrated by Kohler (see Koffka, 1935). The predominating groupings of pairs of vertical lines is between those pairs which tend to form an enclosed space, rather than those close together. The principle of closure has been applied to the re-design of 1.28 - Speed of boring cut, by providing a closed circular figure as a basis for the symbol.

Equally the continuity of a figure has a strong influence on perceptibility. Figures with a strong tendency to smooth continuous outlines are 'figurally good' (this explains the unique characteristics of the circle). Thus in Figure 3(a) (from Koffka, 1935) the 'figurally good' figure is the rectangle - not the two separate trapezia which, combined make up the Figure. We therefore perceive the rectangle with a superposed line rather than two abutting trapezia. Conversely, with the second Figure 2(b), we perceive two lozenge figures rather than the single figure, because the continuity of the total figure is not strong enough to sustain it as a single figural entity. The application of this principle shows a marked improvement in the re-design of 3.7 - Automatic Cycle, illustrated in Figure 2(c) and 2(d).

3.4 Characteristics of figure: symmetry, simplicity and unity.

A corollary of the principle of organisation in perceiving, is that simple well organised figures will be the most easily perceived. These principles are neatly illustrated by Bahnsen's experiments (quoted by Koffka, 1935) which demonstrated that the simplest figures were always perceived. Using material illustrated in Figure 4 he found that subjects always perceived the symmetrical balanced figures in preference to the unsymmetrical intervening figure. This is a further confirmation of the preferred nature of stable forms, and the principle has been intuitively observed in the existing range of symbols, and does not require further illustration here.

The more complex the percept, naturally the more complex must be the contents of the visual field. Conversely, if the meaning to be conveyed is simple, there is nothing to be gained by adding superfluous boundaries and extensions to the figure contour. Any superfluities may suggest alternative and ambiguous interpretations. As an illustration, the existing standard symbol 2.6 - Tapping Spindle - has been simplified in the illustration in Figure 5.

The impact of a symbol is also related to its integrated form - again emphasising the requirement for organised sensory data. The symbols must be designed so that individually they have a corporate unity and also when used in combined form, they 'belong' together. Thus, shapes which have the same meaning in different symbol groupings, should preserve a unity of shape, and symbols consisting of combined figures should be as united and as integrated as possible - see Figure 6 illustrating the changes proposed for symbol 1.31 - Speed of milling cut.

3.5 Characteristics of figure: Effect of size, shape and form

Most experimental evidence points to increased accuracy of perception with increasing size and intensity, the size being a more effective determinant than the intensity. (By size we of course mean visual size - the angle subtended at the observers eye by the image. Obviously absolute size in itself is of no consequence but must be related to visual size as a function of the distance of the observer). Dewey and Dallenbach (see Vernon, 1952) showed that a reduction in intensity by a factor of four only required an increase in size by a factor of two to compensate to the same level of perceptibility. Thus the boldness of the figure greatly enhances its perceptibility; compare the revised designs with most of the original proposals.

The figure perception is also affected by the boundaries of the ground and the relative orientation of the figure in relation to these boundaries. The perceived figure takes its cue from the identification of particular contours with the ground boundary lines. Thus a square may be perceived as a square or a diamond, depending on its relative orientation with respect to the enclosing boundaries of the ground. This feature is important where figures are superimposed and the outlines of one figure may become the boundaries of the smaller enclosed figure. Subtle interactions between the enclosing figure may influence the perception of the enclosed figure. Naturally, because of the existence of the main directions of space - viz. the horizontal and the vertical, these directions exert a radical influence on the process of organising the visual field; the organisation of the field is more easily achieved in these main, rather than other, directions.

3.6 Characteristics of figure: Superposed forms

Although we live in a three dimensional world, most of our visual communication is through two dimensional displays. This is because the retina in the sensory mechanism of the eye is a two dimensional display.



The function of our nervous system is to translate the two dimensional sensory pattern received on the retina into the appropriate dimensional concept. We accept this fact and interpret displays so that they are consistent with our knowledge of the three dimensional world, derived through other sense patterns and experiences, although it is possible to have misconceptions, as in the case of optical illusions. Nevertheless, for most practical purposes, when presented with a set of figures in combination we may perceive them either as a single unified form or as one form 'lying on top of' another. The preferred percept is a function of the relative 'figural goodness' of the individual or total forms comprising the visual field.

For example solid contour figures appear to 'lie on top of' line contour figures. In addition previously discussed factors such as closure, continuity and symmetry influence this single/double perception. Again as argued above, if the total figure is figurally better than the individual parts, then the total figure will be perceived in preference to the individual elemental figures as witnessed in Illustration 2. Figure 7 also illustrates these principles. Illustration 7a constitutes in total an irregular shape, but in reality we perceive it as two superposed regular shapes. We can enhance this perception as in 7b by giving each a different definition of contour - one line-bounded, the other contrast bounded. These variations are shown applied to the symbol 2.14 - Tracer - where the version 7d has obvious advantages over 7c.

4. Practical design of symbols

4.1 The symbol system

The symbol system must first be characterised by defining the three principles mentioned in section 2 as prerequisites for any sign language. Clearly, the first principle can be fulfilled by agreeing that the context of this sign language is the operator of a machine tool and his machine.

Secondly, an examination of machine tool sign systems shows that the meaning of three basic types of symbol must be defined:

(a) Defining a direction

Descriptive of the plane(s) of motion and the direction(s) of motion of that plane, e.g. Linear, Rotational, Continuous, Intermittent, Reciprocating.

(b) Defining an element

Descriptive of a machine part to which a particular control, display direction or manoeuvre applies, e.g. Pump, Spindle, Half Nut.

(c) Defining a function

Descriptive of a particular facility the machine can execute.

This is distinct from the actual mechanism or motion (element) which achieves this function, e.g. Feed, Stop, Open, Thread, Shut, Close, Disengage, Lock.

Notice that these functions which can be achieved by different elements or even the same element, e.g. lead screw, can provide feed and thread functions.

Finally, we must specify the syntactic relationships which define the ways in which we are able to combine the basic symbol words to form symbolic sentences. These are of three types in this application. The specification of an intransitive sentence which specifies a rate, a transitive sentence which specifies a manoeuvre and a small but important class of imperative sentence of one word, restraining the operator. These are in a sense negative instructions, as distinct from the positive instructions transmitted by the other types of sign. It is also important that the sentences are primarily instructive - not descriptive. The operator looks at these signs for instructions on how to achieve given objectives and to this end they must tell him how to achieve certain states. To achieve this he must make decisions and these decisions require information in this instructive mode. Only incidentally will these displays, when associated with a control position, provide him with a description of the current state of the machine.

(d) Rate

A rate is a quantitative determination of function together with a description of the direction and the mode of motion:

i.e.

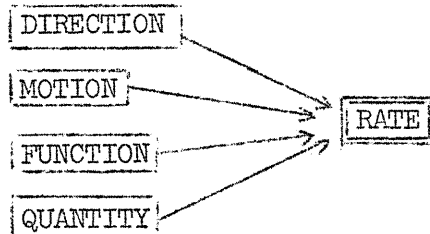

To define the quantity we of course use the standard arabic numerals and abbreviations for the measurement units.

(e) Manoeuvre

Descriptive of a particular action executed on an element to achieve or change a given function, e.g. open chuck, increase feed, rotate spindle.

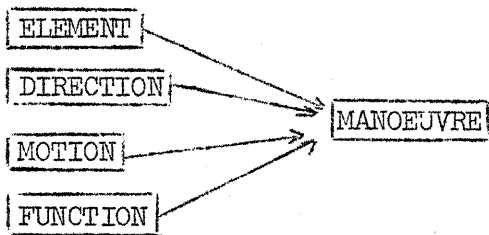

(f) Warning

Finally a small section which are inhibitory, which warn the operator to exercise caution before initiating functions viz: High voltage, caution.

This is a useful subdivision here - the symbols comprising this section each describe warnings about mechanical components and electrical components and are expressly designed for protection of the operator, not the machine.

We have categorised all the basic symbol words according to the three fundamental types: Direction, Element, Function. It is a simple matter to add to them as new concepts of motion elements or functions arise.

Given these basic symbol 'words', the definition of rates and manoeuvre are defined by the syntactic rules for combining symbols to express these complex machine tool operations. A proposed structure is shown in Figure 8 which gives a detailed classification of the basic symbol elements at present in use. Using the proposed syntactic rules, it is possible to arrive at all the combined forms also at present in use. However, a valuable feature of this structure is the ability to further combine any existing direction, function or element symbols, to give an expanded range of symbols. The value of the formal structure is now apparent, since it enables a much more flexible, yet consistent application of the existing range of international standard symbols.

The inconsistencies of the present standard are significantly pointed by these general considerations. The existing structure is confused by intermixing of elementary functions and manoeuvres, e.g. Automatic cycle is a function. The verbal descriptions are variable both in form and sense (c.f. Engaging, closed, Engage tracer, lock; - all classified as manoeuvres yet all described by different parts of speech!). These considerations are extremely important if the standard range is to be capable of consistent extension for more complex forms.

4.2 Design of symbol forms

Based on the principles of perception, considered in perfectly generalised form in section 3, it is now possible to lay down guide lines for the design of the individual symbols. The implications of these theoretical considerations are quite decisive. The more we can match the characteristics of the visual image to the idealised process of perception, the more rapidly and unambiguously will the symbol be perceived. Naturally, many of the existing symbols already possess some of the necessary attributes, but many contradictions, inconsistencies and superfluities have crept into the design of the symbols because of the absence of the essential formal framework for their appraisal. The basic principles used in the re-design of the symbols are:

- (i) Figure/Ground. The symbol should exploit the principles of the figure/ground phenomenon and to this end should be as clear and as stable as possible.
- (ii) Figure Boundary. The figures should be bounded by a contrast boundary in preference to a line boundary. Where more than one figure is required for any symbol the most important figure should be the solid contrast contour bound figure. The rationalisation of these principles implies the following, consistent, allocations of solid and outline figures:

SYMBOL DYNAMIC (Function, Direction) Solid figure.

MOVING OR ACTIVE PART (Element) Outline figure.

STATIONARY OR INACTIVE PART (Element, warning).. Solid figure

This permits a rational approach to the design of complex figures since the stationary element part (solid figure) will, by definition, never require the dynamic part (solid figure) to be superimposed. Problems of overlapping solid figures should therefore not occur.

- (iii) Simplicity. The symbols should be as simple as possible. Fine detail (chips curling from tool edges, centre lines, etc.) makes no contribution to unambiguous and rapid interpretation.
- (iv) Symmetry. Symbols should be as symmetrical as possible, providing that asymmetry adds no further meaning to the figure.
- (v) Unity. Symbols should be as unified as possible. This can be achieved by consistent use of the same size and proportions of individual elements when they repeat. Secondly, when solid and line outline figures occur together, more unity is achieved when solid figures are integrated by enclosing them with the line outline figures.

- (vi) Closure. Line contour figures should always form closed figures unless it is expressly required to have an open figure to achieve the correct meaning.
- (vii) Size, Form and Shape. Symbols should be bold solid figures possessing substance and area - not line shapes.
- (viii) Orientation. The prevailing outlines of the symbol should follow as far as possible the main spatial axes of the horizontal and the vertical.

Most of these principles have been illustrated in the text by reference to experimental material or practical examples of actual symbol re-design. A full appraisal of each individual symbol is presented in the Appendix 1.

5. Presentation

From the foregoing discussions, the utility of a symbol as part of a machine tool display is a function of its shape and its proportions. If the proposals in this report are implemented, then the specification of each symbol must be controlled so as to achieve the best design of symbolic display.

There will be significant advantages in specifying quite rigorously the proportions of all the symbols shown in the standard by displaying them on a reference grid. This type of presentation will avoid distortions of the standard form and preserve the correct figure/ground relationships. The sizes shown can be assumed full size for a normal viewing distance of 28" but since the basic problem is perceiving and not seeing, there is considerable scope for variation in size to suit various machine tool layouts. It must be stressed that a uniform reduction or magnification should be used on a given machine facia, otherwise a set of symbols lacking visual unity may result. The value of a grid reference system is immediately obvious in this respect as it allows rapid reproduction to any convenient scale. The proposed grid is based on modules of four, corresponding to the normal engineering practice of using inches, quarters, eights, etc. for specifying untoleranced dimensions.

Given the general acceptance of these designs as standard, it may prove advantageous for manufacturers of plates and control elements who use either engraving, photo etching or casting techniques, to maintain a standard stock of the most frequently used designs. These may then be rapidly assembled to make up composite plates to suit individual machine tool makers requirements. Equally for design work, the unification of size, shape and proportions could encourage the manufacture of preprinted displays using cut out or transfer techniques. These could be used for the assembly of trial layouts, thus reducing drawing office time and effort, while at the same time improving the quality of the design of the displays.

6. References

1. Bartlett, F.C. (1932) Remembering.
(London: Cambridge University Press).
2. Koffka, K. (1935) Principles of Gestalt Psychology.
(New York: Harcourt, Brace).
3. Vernon, M.D. (1952) A further study of visual perception.
(London: Cambridge University Press).

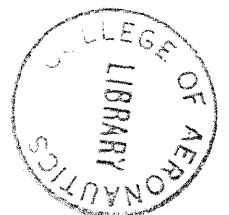

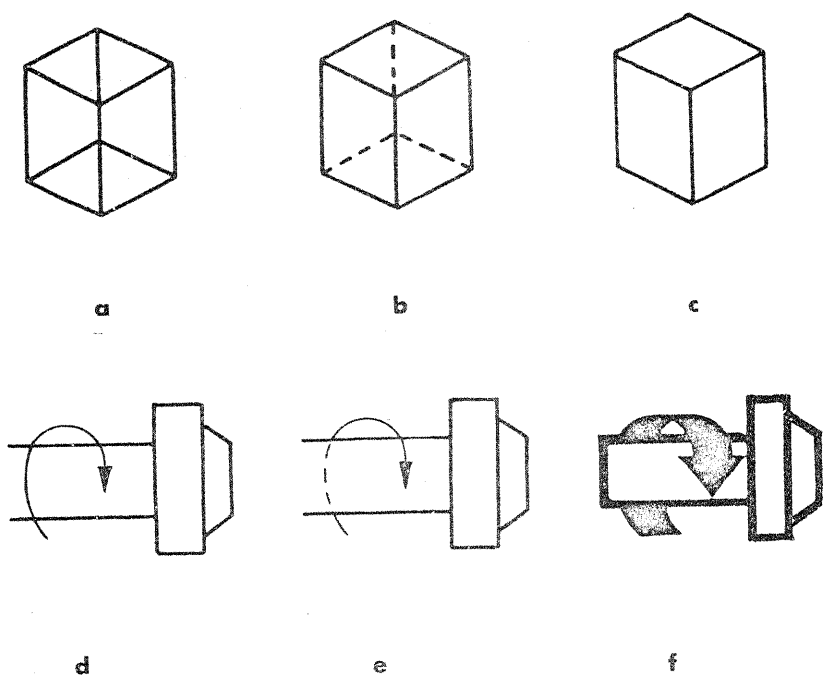

FIG.1 Effect of figure on perceptual stability

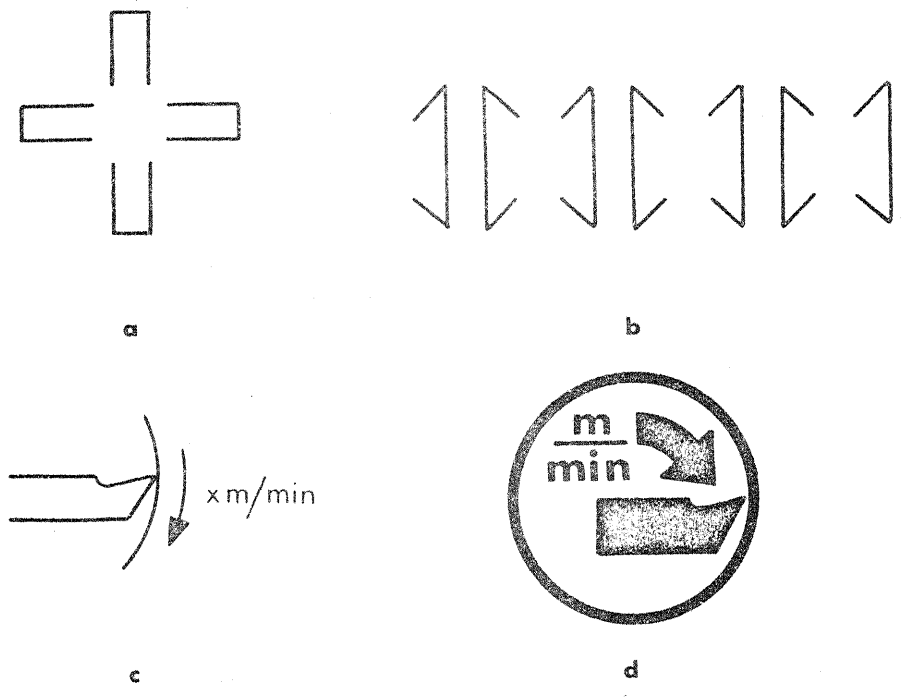

FIG. 2 Effect of closure on perception

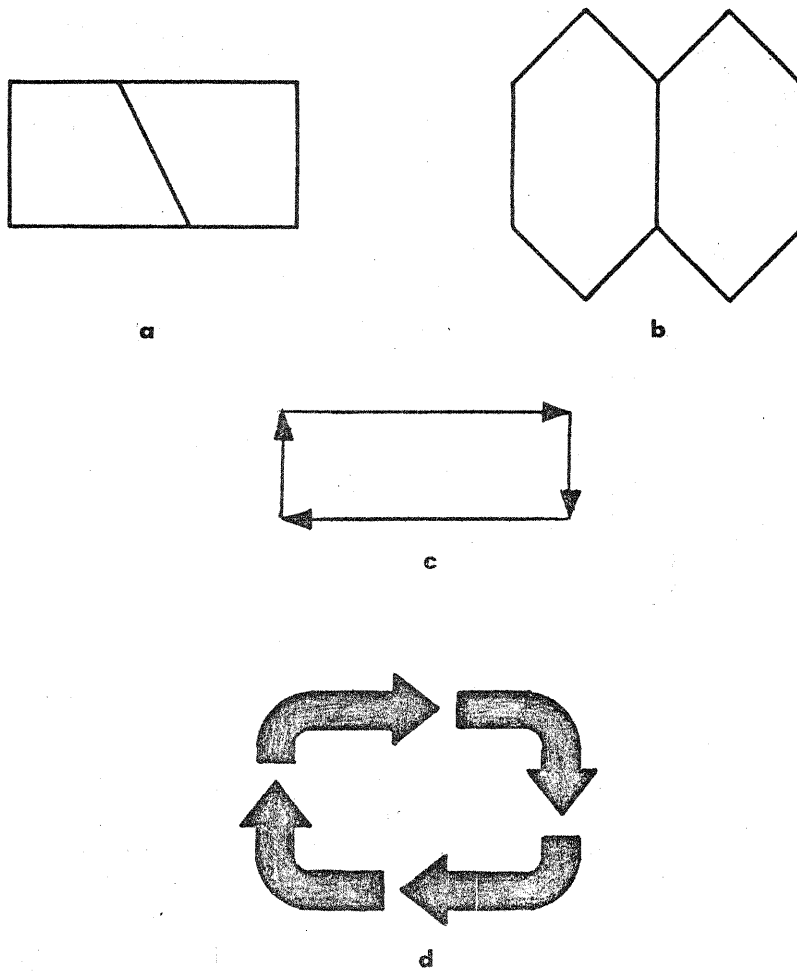

FIG 3 Effect of continuity on perception

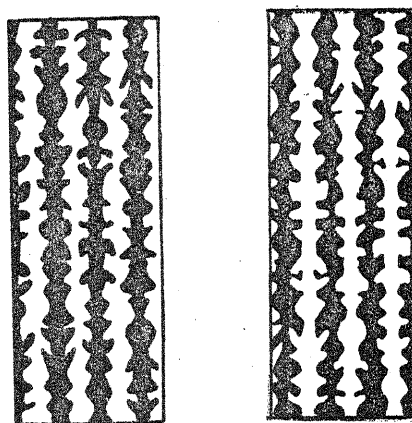

FIG. 4 Effect of symmetry on perception

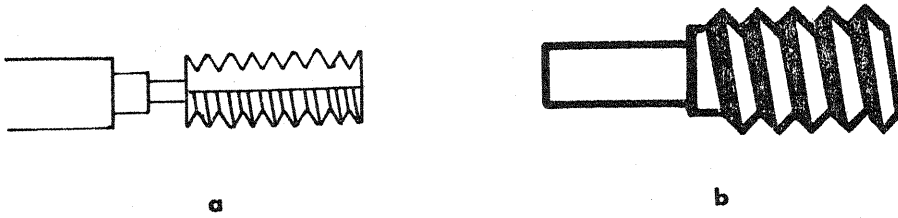

FIG. 5 Effect of simplicity on perception

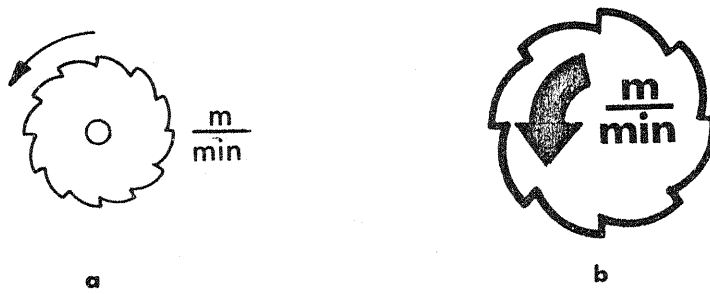

FIG. 6 Effect of unity on perception

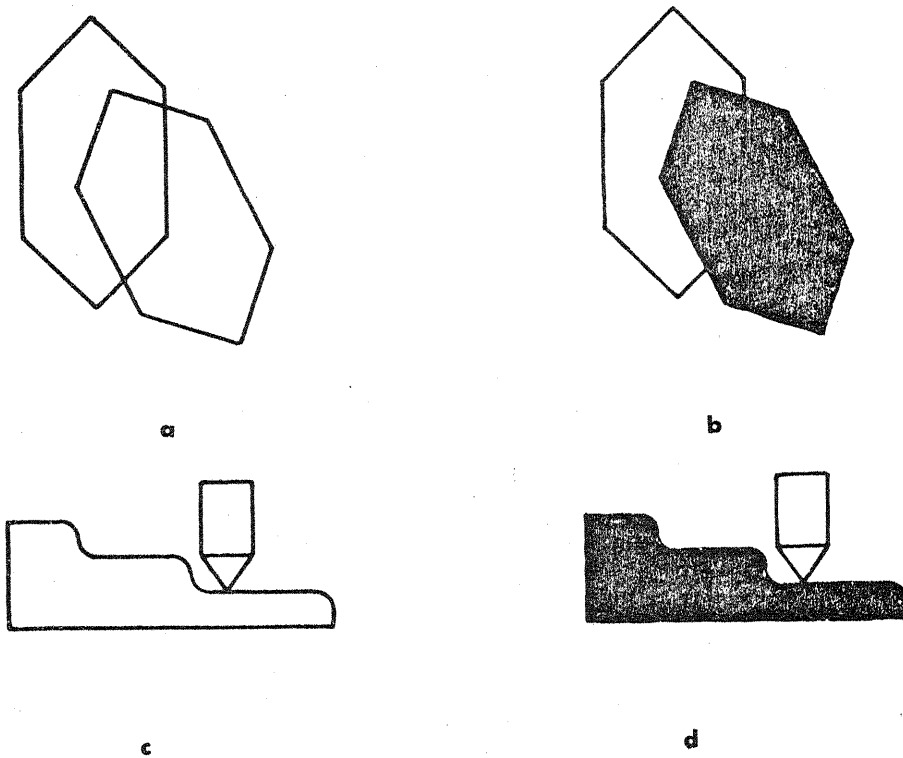

FIG. 7 Effect of line and contrast bounded figures on perception

<u>DIRECTIONS</u> (Symbolic Adjectives)		<u>FUNCTIONS</u> (Symbolic Verbs)		<u>ELEMENTS</u> (Symbolic Nouns)		
<u>Sense</u>		<u>Major</u>	<u>Minor</u>	<u>Major</u>	<u>Minor</u>	
<u>Axis</u>	-	Longitudinal	Feed	Adjust	Chuck	Coolant Outlet
		Transverse	Thread	Open	Spindle	Lubrication Point
		Vertical	Drill	Close	Drill Spindle	Greasing Point
<u>Mode</u>	-	Linear	Bore	Stop	Tap Spindle	Drain Outlet
		Rotational	Tap	Emergency Stop	Work Table	Filler Inlet
<u>Type</u>	-	One sense	Turn	Start	Mill Spindle	Full Level
	-	Two senses	Climb Mill	Lock	Motor	Low Level
		Intermittent	Conv. Mill	Unlock	Pump	Filter
		Limited	Plane	Clamp	Tracer	Brake
		Limited and return	Traverse	Unclasp	Half Nut	Hydraulic Motor
		Reciprocal	Auto Cycle		Lead Screw	
		Manual Cycle		Turret		
		Index		Double Face Slide		
		Rotate		Single Face Slide		
		Increase		Sump		
		Decrease		Blower		
				Pump		
				Exhauster		
				Lighting		
				Main Switch		
				Shear Pin		

WARNING
(Symbolic imperatives)

Danger
Caution

Figure 8

CLASSIFICATION OF SYMBOL MEANINGS

APPENDIX 1

DETAILED EXAMINATION OF SYMBOLS

The following appendix gives detailed comments and suggestions for the revised design of the symbols. These comments appear alongside copies of the revised proposals and the original proposals.

Section 5 has not been evaluated in this way as the proposals are sufficiently justified by considering the four main sections. It is suggested that Section 5 be integrated into the section on elements as indicated in figure 8 of the main report.

(1)

REVISED

ORIGINAL

1.1 Direction of rectilinear motion

CLASS: DIRECTION

A basic symbol.

Improved figure/ground enables the construction of more complex combined symbols.

Should be used consistently to define direction only. Other forms involving arrows should use form significantly different (See 2.9 etc. and 3.2).



1.2 Rectilinear motion in two directions

CLASS: DIRECTION

Defines direction and mode.

Improved figure/ground based on 1.1.

Symbol broken at centre point to improve perception and allows insertion of function, e.g. (feed) (See 1.20)



1.3 Interrupted rectilinear motion (Jog)

CLASS: DIRECTION

Defines a direction and mode.

Improved figure/ground based on 1.1.



1.4 Limited rectilinear motion

CLASS: DIRECTION

Defines a direction and mode.

Improved figure/ground as in 1.1.



(ii)

REVISED

ORIGINAL

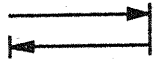

1.5 Limited rectilinear motion and return

CLASS: DIRECTION

Defines direction and mode.

Improved figure/ground relationship.

Right hand vertical line destroys

continuity and therefore eliminated.

Arrows closely spaced to improve

integration and unity.

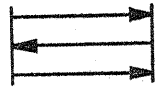
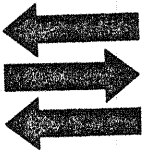

1.6 Oscillatory rectilinear motion (continuous)

CLASS: DIRECTION

Defines a direction and mode.

Improved figure/ground relationship

Vertical lines destroy continuity and

notion of continuous motion (c.f. 1.5

above)

Arrows closely spaced to improve

integration and unity.



1.7 Direction of continuous rotation

CLASS: DIRECTION

Improved figure/ground relationship



1.8 Rotation in two directions

CLASS: DIRECTION

Defines direction and mode.

Improved figure/ground based on 1.7

Symbol broken at centre as 1.3

(iii)

REVISED

ORIGINAL

1.9 Direction of interrupted rotation (Jog)

CLASS: DIRECTION

Defines a direction and mode.

Improved figure ground based on 1.7



1.10 Limited rotation (or indexing)

CLASS: DIRECTION

Defines direction and mode.

Improved figure/ground based on 1.7



1.11 Limited rotation and return

CLASS: DIRECTION

Defines direction and mode.

Improved figure ground based on 1.7

Radial line destroys continuity.

Arrows closely spaced to improve integration and unity.



1.12 Oscillating motion

CLASS: DIRECTION

Defines direction and mode

Improved figure ground based on 1.7

Extension of 1.11

Radial lines destroy continuity

Arrows closely spaced to improve integration and unity.



(iv)

REVISED

ORIGINAL

1.13 Direction of spindle rotation

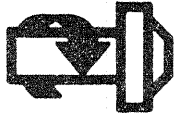

CLASS: RATE - will usually be qualified by symbol 1.14
Original - unstable and unclosed figure.
Improved figure/ground of directional arrow and spindle symbol, now closed
Directional arrow standardised for use with other rotation rates e.g. with 1.30 drill speed or 2.8 Grinding spindle speed.

1.14 Revolutions per minute



CLASS: RATE
Revised symbol given integrated form.

1.15 Feed per revolution

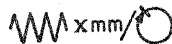
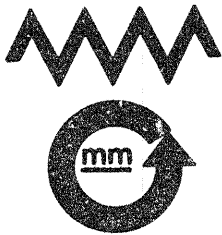

CLASS: RATE
Revised symbol given integrated form.
Inverted form of 1.14 for revolutions.

1.16 Feed per minute

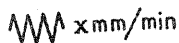

CLASS: RATE
In original, letters and numerals badly integrated with figure
Revised quotient form permits better integration with feed symbol.

(v)

REVISED

ORIGINAL

1.17 Normal feed

CLASS: RATE

Revised form integrates numerals with sign as in 1.16

As a relative symbol it should be used in conjunction with 1.18 and 1.19



1.18 Reduced feed

CLASS: RATE

Revised form integrates numerals with sign as 1.16

As a relative symbol it should be used in conjunction with 1.17 and 1.19.

The fine pitch form is not recommended as it only leads to confusing perception. Numerical information is preferable.



1.19 Rapid feed

CLASS: RATE

Revised form integrates numerals with sign as 1.16

As a relative symbol it should be used in conjunction with 1.17 and 1.18.

The coarse pitch form is not recommended as it only leads to confusing perception. Numerical information is preferable.



1.20 Longitudinal feed

CLASS: FUNCTION

Defines function and direction.

Combined from 1.16 and 1.2.

For one direction only, deliberate assymetry reinforces meaning.



(vi)

REVISED

ORIGINAL

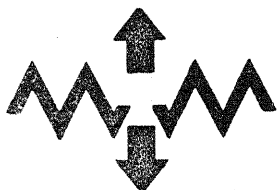

1.21 Transverse feed

CLASS: FUNCTION

Defines function and direction.

Combined from 1.16 and 1.2

Deliberate break allows insertion at numerals to specify rate.



1.22 Vertical feed

CLASS: FUNCTION

Defines function and direction.

1.23 Rapid Traverse

NOT RECOMMENDED FOR USE

Rapid traverse has no meaning except in relation to some other slower rate. The symbol is figurally bad, has no association with any other symbols and it is not thought necessary.



1.24 Threading

CLASS: FUNCTION

Defines a function.

Symbol made more meaningful by use of sloping lines.

REVISED

ORIGINAL

1.25 Increase of value

CLASS: FUNCTION
No change required



1.26 Decrease of value

CLASS: FUNCTION
No change required



1.27 Speed of planing

CLASS: RATE
Defines function, direction and quantity.
Solid figure allocated to stationary element.
Moving element, with dynamic is closed.
Arrow superposed on bounded figure.

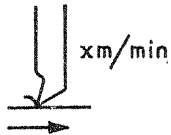
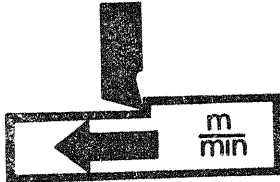

1.28 Speed of turning cut

CLASS: RATE
Defines function, direction and quantity.
Solid figure allocated to stationary part - consistent with 1.27, 1.29.
Moving element is closed, line bounded figure with dynamic arrow superposed.
Numerical data integrated with closed figure.

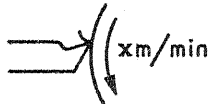

REVISED

ORIGINAL

1.29 Speed of boring cut

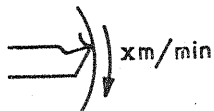
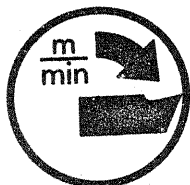

CLASS: RATE

Defines a function, direction and quantity. Solid figure allocated to stationary part - consistent with 1.27, 1.28.

Moving element is closed line bounded figure with dynamic arrow superposed. Numerical data integrated with closed figure.

1.30 Speed of drilling cut

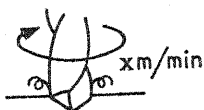

CLASS: RATE

Defines functional element, direction, quantity. Element consistent with 2.5 and dynamic arrow identical to that used in 1.13

1.31 Speed of milling cut

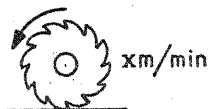
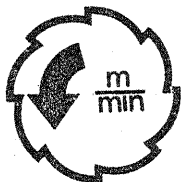

CLASS: RATE

Defines functional element, direction, quantity. Element greatly simplified. Dynamic superposed and integrated with element.

Numerical information integrated with closed figure.

1.32 Conventional milling

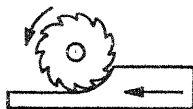
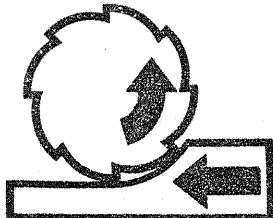

CLASS: FUNCTION

Defines function and relative directions. Element greatly simplified. Both elements moving, so each a line bounded figure with dynamic arrow superposed.

(ix)

REVISED

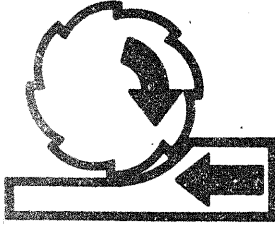

ORIGINAL

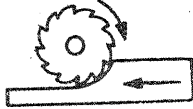

1.33 Climb milling (down milling)

CLASS: FUNCTION

Defines function and relative directions.
Element greatly simplified. Both
elements moving so each a line bounded
figure with dynamic arrow superposed.



(x)

REVISED

ORIGINAL

2.1 Electric Motor

CLASS: ELEMENT
Bolder outlines



2.2 Rectangular work table

CLASS: ELEMENT
Bolder outlines

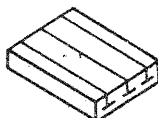
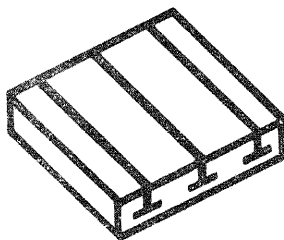

2.3 Circular work table

CLASS: ELEMENT
Bolder outlines

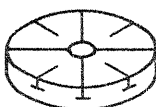
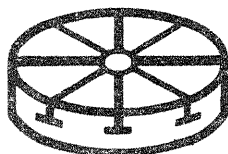

2.4 Turning spindle

CLASS: ELEMENT
Bolder outlines
Uniform spindle size used to permit
superposition of rotation arrow as in
1.13.

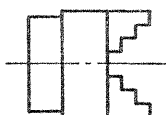
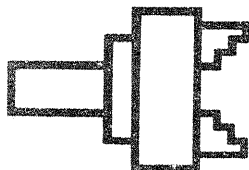

REVISED

ORIGINAL



2.5 Drilling spindle

CLASS: ELEMENT

Simplified and more meaningful outline - detail restricted in interests of simplicity.

Uniform spindle size used to permit superposition of rotation arrow as in 1.13 (See 1.30)



2.6 Tapping spindle

CLASS: ELEMENT

Simplified and more meaningful outline - detail restricted in interests of simplicity.

Uniform spindle size used to permit superposition of rotation arrow as in 1.13

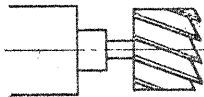

2.7 Milling spindle

CLASS: ELEMENT

Bolder and less complex outline.

Uniform spindle size as in 2.4 to 2.8.

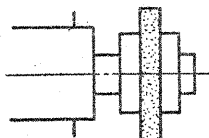
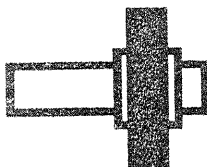

2.8 Grinding spindle

CLASS: ELEMENT

Bolder and less complex outline.

Uniform spindle size as 2.4 to 2.7

(x11)

REVISED

ORIGINAL

2.9 Pump (general symbol)

CLASS: ELEMENT

Bolder outlines.

Arrow here does not imply functional direction so different form used.



2.10 Coolant pump

CLASS: ELEMENT

Bolder outlines

Arrow does not imply functional direction so different form used.

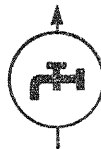

2.11 Lubricant pump

CLASS: ELEMENT

Bolder outlines

Arrow does not imply functional direction so different form used.



2.12 Hydraulic pump

CLASS: ELEMENT

Bolder outlines

Arrow does not imply functional direction so different form used.



REVISED

ORIGINAL

2.13 Hydraulic motor

CLASS: ELEMENT

Bolder outlines

Arrow does not imply functional direction so different form used. Symbol may require modification if it can be shown that it is to easily confused with pump symbol.



2.14 Tracer

CLASS: ELEMENT

Exploitation of solid and outline figure to improve symbol.

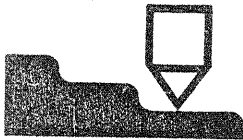

2.15 Double facing slide

CLASS: ELEMENT

Bolder outlines



2.16 Single facing slide

CLASS: ELEMENT

Bolder outlines



(xiv)

REVISED

ORIGINAL

3.1 Stepless regulation

CLASS: FUNCTION.

No change.

Complementary symbol of non stepless regulation needed.



3.2 Adjustable

CLASS: FUNCTION

Improved concept of adjustment by addition of centre circular figure.

Not a good symbolic concept as difficult to integrate with other symbols. Application uncertain.



3.3(a) Lock

CLASS: FUNCTION

Considered as uniform with 3.4(a) and based on 1.2. Basic symbol unchanged for lock/unlock. Arrow directions reversed only.



3.3(b) Chuck closed

CLASS: MANOEUVRE

Considered as uniform with 3.4(b) and based on basic 1.1 symbol arrow. Basic symbol unchanged for close/open, arrow directions reversed only.

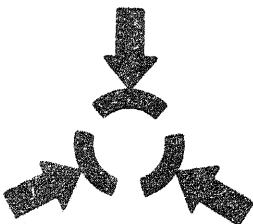

REVISED

ORIGINAL

3.4(a) Unlock

CLASS: FUNCTION

See 3.3(a)

Note also inconsistent language to describe these symbols

c.f. Lock!

Chuck closed!

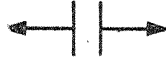

3.4(b) Chuck open

CLASS: MANOEUVRE

See 3.3(b)

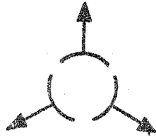
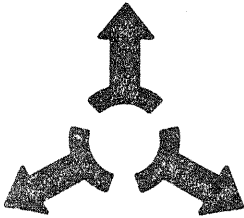

3.5 Brake on

CLASS: MANOEUVRE

Comments as for 3.3



3.6 Brake off

CLASS: MANOEUVRE

Comments as for 3.3



REVISED

ORIGINAL

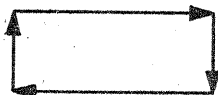
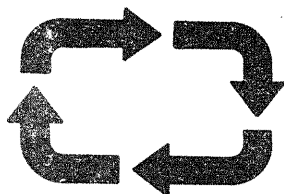

3.7 Automatic cycle

CLASS: FUNCTION

Basic symbol form used. Continuity improved by moving arrow heads to centres of sides of rectangle.



3.8 Hand control

CLASS: FUNCTION

Bolder outlines



3.9 Start, on

CLASS: FUNCTION

No comment



3.10 Stop, off

CLASS: FUNCTION

No comment

REVISED

ORIGINAL

3.11 Start and stop - same control

CLASS: FUNCTION
No comment



3.12 In action as long as control operated

CLASS: FUNCTION
No comment



3.13 Emergency stop - master stop

CLASS: FUNCTION
Changed to solid figure

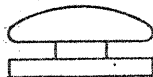

3.14 Engage

CLASS: FUNCTION
Modified to give more meaningful symbol.

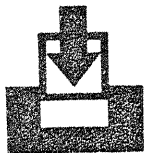

(xviii)

REVISED

ORIGINAL

3.15 Disengaging

CLASS: FUNCTION
Complement to 3.14

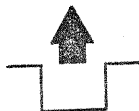
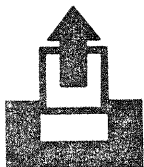

3.16 Halfnut closed

CLASS: ELEMENT
Strictly is an element and can be specified by combining engage with element symbol, to give function.

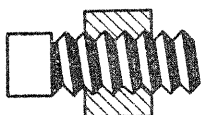
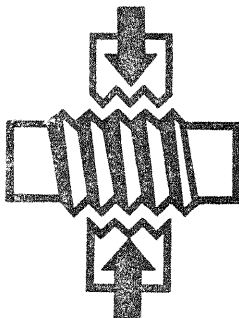

3.17 Halfnut open

See 3.16 above.

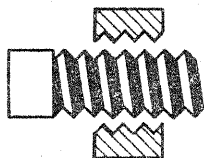
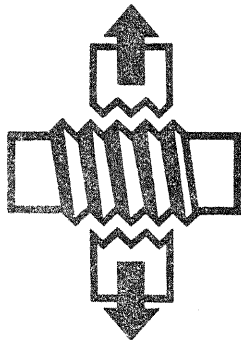

3.18 Engage Tracer

CLASS: MANOEUVRE
Combination of element (tracer)
and function (engage)
Symbol based on 2.14 and 3.14

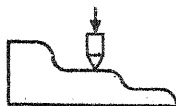
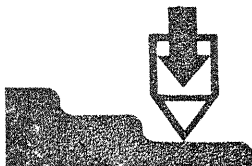

(xix)

REVISED

ORIGINAL

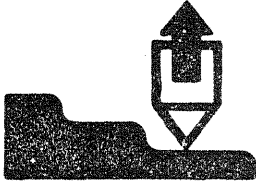

3.19 Disengage tracer

CLASS: MANOEUVRE
As for 3.18



(xx)

REVISED

ORIGINAL

4.1 Shear pin construction

CLASS: ELEMENT

Simplified with bolder outlines.
Strictly defines a machine element.

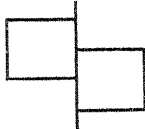

4.2 Attention (high voltage) danger

CLASS: WARNING

Preferred use for electrical danger



4.3 Caution

CLASS: WARNING

Preferred use for mechanical danger



4.4 Main switch

CLASS: ELEMENT

Element with danger sign superposed.

