

Original citation:

Lin, Min Chih, Lozin, Vadim V., Moyano, Veronica and Szwarcfiter, Jayme (2017) Perfect edge domination : hard and solvable cases. *Annals of Operations Research* . doi:10.1007/s10479-017-2664-3

Permanent WRAP URL:

<http://wrap.warwick.ac.uk/92507>

Copyright and reuse:

The Warwick Research Archive Portal (WRAP) makes this work by researchers of the University of Warwick available open access under the following conditions. Copyright © and all moral rights to the version of the paper presented here belong to the individual author(s) and/or other copyright owners. To the extent reasonable and practicable the material made available in WRAP has been checked for eligibility before being made available.

Copies of full items can be used for personal research or study, educational, or not-for profit purposes without prior permission or charge. Provided that the authors, title and full bibliographic details are credited, a hyperlink and/or URL is given for the original metadata page and the content is not changed in any way.

Publisher's statement:

The final publication is available at Springer via <https://doi.org/10.1007/s10479-017-2664-3>

A note on versions:

The version presented here may differ from the published version or, version of record, if you wish to cite this item you are advised to consult the publisher's version. Please see the 'permanent WRAP url' above for details on accessing the published version and note that access may require a subscription.

For more information, please contact the WRAP Team at: wrap@warwick.ac.uk

Perfect Edge Domination: Hard and Solvable Cases

Min Chih Lin · Vadim Lozin · Veronica A.
Moyano · Jayme L. Szwarcfiter

Received: date / Accepted: date

Abstract Let G be an undirected graph. An edge of G *dominates* itself and all edges adjacent to it. A subset E' of edges of G is an *edge dominating set* of G , if every edge of the graph is dominated by some edge of E' . We say that E' is a *perfect edge dominating set* of G , if every edge not in E' is dominated by exactly one edge of E' . The *perfect edge domination problem* is to determine a least cardinality perfect edge dominating set of G . For this problem, we describe two NP-completeness proofs, for the classes of claw-free graphs of degree at most 3, and for bounded degree graphs, of maximum degree at most $d \geq 3$ and large girth. In contrast, we prove that the problem admits an $O(n)$ time solution, for cubic claw-free graphs. In addition, we prove a complexity dichotomy theorem for the perfect edge domination problem, based on the results described in the paper. Finally, we describe a linear time algorithm for finding a minimum weight perfect edge dominating set of a P_5 -free graph. The algorithm is robust, in the sense that, given an arbitrary graph G , either it computes a minimum weight perfect edge dominating set of G , or it exhibits an induced subgraph of G , isomorphic to a P_5 .

Keywords claw-free graphs, complexity dichotomy, cubic graphs, NP-completeness, perfect edge domination

Min Chih Lin
CONICET, Instituto de Cálculo and Departamento de Computación, Universidad de Buenos Aires, Buenos Aires, Argentina.
E-mail: oscarlin@dc.uba.ar

Vadim Lozin
University of Warwick, United Kingdom.
E-mail: v.lozin@warwick.ac.uk

Veronica A. Moyano
CONICET, Instituto de Cálculo and Departamento de Matemática, Universidad de Buenos Aires, Buenos Aires, Argentina.
E-mail: vmoyano@ic.fcen.uba.ar

Jayme L. Szwarcfiter
I. Mat., COPPE and NCE, Universidade Federal do Rio de Janeiro, and Instituto Nacional de Metrologia, Qualidade e Tecnologia, Rio de Janeiro, Brazil
E-mail: jayme@nce.ufrj.br

1 Introduction

Edge domination problems have been the focus of considerable attention, in the last few years. Among the relevant variations of these problems are the perfect edge domination and efficient edge domination. In the former variation, each edge outside the dominating set is dominated by exactly one edge, while in the latter, what is more, the edges inside are dominated by themselves only. The problems consist in determining such dominating sets, of minimum cardinality or minimum total weight of their edges. Most of the known results, so far concerned the efficient edge dominating case (also known as *dominating induced matching*), for instance see [2, 3, 4, 6, 8, 9, 10, 11, 12, 13, 14, 15, 16, 17]. These two types of dominations may lead to problems of a quite different nature. To start with, an efficient edge dominating set of a graph may not exist, while it necessarily exists for the perfect domination. Furthermore, there are important differences concerning the complexity status of the problems for classes of graphs although both of them are hard, in general. In fact, perfect edge domination problems seem to be not easier to tackle than efficient edge domination. On the other hand, if a graph contains an efficient edge dominating set then such set is also a minimum cardinality perfect edge dominating set [7],[15]. The corresponding decision problems, for the cardinality version, are therefore as follows.

EFFICIENT EDGE DOMINATION

INPUT: Graph G

QUESTION: Does G contain an efficient edge dominating set ?

PERFECT EDGE DOMINATION

INPUT: Graph G , integer p

QUESTION: Does G contain a perfect edge dominating set S of size $\leq p$?

Both problems are known to be NP-complete [8] and [15], respectively.

In the present paper, we consider perfect edge domination. The main proposed results are as follows:

- A NP-hardness proof for the cardinality version of perfect edge domination in claw-free graphs of degree at most 3.
- A linear time solution for weighted (with possibly negative weights) perfect edge domination in cubic claw-free graphs.
- A NP-hardness proof for the cardinality version of perfect edge domination in bounded-degree graphs of large girth. The proof also implies NP-hardness for r -regular graphs, $r \geq 3$.
- A complexity dichotomy theorem which establishes NP-hardness for the perfect edge domination problem in any class of bounded degree graphs, defined by forbidding one general graph H . The only exception is when H is a set of disjoint paths, in which case the corresponding perfect edge domination problem admits a polynomial time solution.
- A robust linear time algorithm for solving weighted perfect edge domination problem of P_5 -free graphs. That is, in linear time, the algorithm either finds a minimum weight edge dominating set of the graph, or exhibits an induced P_5 .

We remark that the above problems have already been solved for efficient edge domination. In contrast with the perfect edge domination hardness proposed in the present paper, Cardoso, Koperlainen and Lozin [6] have described an $O(n^2)$ time algorithm for finding an

efficient edge dominating set, for general claw-free graphs. More recently, the corresponding weighted problem has been solved in $O(n)$ time, by Lin, Mizrahi and Szwarcfiter [12]. Moreover, Hertz, Lozin, Ries, Zamaraev and de Werra [9] have shown that the efficient edge domination problem can still be solved in polynomial time for graphs containing no long claws. Finally, for bounded degree graphs, Cardoso, Cerdeira, Delorme and Silva [4] have shown that efficient edge domination problem is NP-complete for r -regular graphs for $r \geq 3$.

Known results to the authors for the perfect edge domination problem are as follows. Lu, Ko and Tang [15] proved the problem is NP-complete for bipartite graphs. As for polynomial time solvable cases, there are linear time algorithms also described by Lu, Ko and Tang, for generalized series-parallel graphs and chordal graphs. In addition, there is a linear time algorithm for circular-arc graphs, by Lin, Mizrahi and Szwarcfiter [13]. All of these algorithms solve the weighted perfect edge domination problem.

The structure of the paper is as follow. Section 2 describes the terminology employed. Section 3 contains the NP-completeness proof of the perfect edge domination problem for claw-free graphs of degree at most three. In Section 4 we show that the weighted perfect edge domination problem is solvable in linear time for cubic claw-free graphs. In Section 5 we prove NP-hardness of the perfect edge domination problem in bounded degree graphs even restricted to those of large girth. This result implies the NP-hardness for r -regular graphs with $r \geq 3$. Section 6 contains the dichotomy theorem for the complexity of the perfect edge domination problem for bounded degree H -free graphs. When H is a disjoint union of paths the problem is solvable in polynomial time, otherwise it remains NP-hard. Section 7 is dedicated to the case $H = P_k$. For P_5 -free graphs we present a robust algorithm which solves the weighted perfect edge domination problem in linear time.

2 Preliminaries

Let G be an undirected graph with no loops or multiple edges. The vertex and edge sets of G are denoted by $V(G)$ and $E(G)$, respectively, $|V(G)| = n$. For v, w , adjacent vertices of G , write vw to denote the edge incident to v and w . For $v \in V(G)$, let $N(v) = \{w \in V(G) | v, w \text{ are adjacent}\}$, and $N[v] = N(v) \cup \{v\}$. The edges e and e' are adjacent if they are incident to a common vertex. For $e \in E(G)$, let $N'(e) = \{e' \in E(G) | e, e' \text{ are adjacent}\}$, and $N'[e] = N'(e) \cup \{e\}$. For $V' \subseteq V(G)$, denote by $G[V']$ the subgraph induced in G by V' . Similarly, for $E' \subseteq E(G)$, denote by $G[E']$ the subgraph of G having exactly the edges of E' without isolated vertices. Each edge $e \in E(G)$ may be assigned a real value, called the *weight* of e . The girth of G is the length of a shortest cycle contained in G . If G is an acyclic graph the girth is defined to be infinity.

A vertex $v \in V(G)$ *dominates* itself and any other vertex adjacent to it. A subset of vertices $X \subseteq V(G)$ is a (*vertex*) *dominating set* if every vertex of G is dominated by some vertex of X . An edge $vw \in E(G)$ *dominates* itself and any other edge adjacent to it. A subset of edges $E' \subseteq E(G)$ is a *perfect edge dominating set* (PEDS) of G , if every edge of $E(G) \setminus E'$ is dominated by exactly one edge of E' . On the other hand if every edge of $E(G)$ is dominated exactly once by E' then E' is an *efficient edge dominating set* (EEDS), also called a *dominating induced matching*. The *cardinality perfect (efficient) edge domination problem* is to determine the perfect (efficient) edge dominating set of G of least cardinality. The corresponding *weighted* problems are defined replacing minimum cardinality by minimum sum of weights of the dominating edges.

Let $P \subseteq E(G)$ be a perfect edge dominating set of a connected graph G . Then P defines a 3-coloring of the vertices of G , as below:

- *black vertices*: Those having at least two incident edges of P . We denote this subset of vertices by B .
- *yellow vertices*: Those which are incident to exactly one edge of P . We denote this subset of vertices by Y .
- *white vertices*: The ones which are not incident to any edge of P . We denote this subset of vertices by W .

We call (B, Y, W) the *3-coloring associated to P* .

Observation 1 W is an independent set.

Observation 2 All edges incident to black vertices are necessarily contained in P .

Observation 3 A vertex is yellow if and only if it is a pendant vertex in the induced subgraph $G \setminus W$.

Observation 4 White vertices have only yellow neighbors.

Observation 5 Every vertex of an induced K_t with $t \geq 4$ must be black.

Observation 6 Every induced triangle has (i) three black vertices or (ii) two yellow vertices and one white vertex.

Observation 7 A perfect edge dominating set is an efficient edge dominating set if and only if $B = \emptyset$. In this case, the subset induced by Y is an induced matching of G .

We remark that Observation 4 implies Observation 1.

It is straightforward to see that any 3-coloring (B, Y, W) of the vertices of G , that verifies the conditions of Observations 1, 3 and 4, is necessarily associated to some perfect edge dominating set of G .

When $B \neq \emptyset$ and $W = \emptyset$ then $E(G)$ is the only perfect edge dominating set, called the *trivial perfect edge dominating set* of G . Any perfect edge dominating set P which is neither trivial nor an efficient edge dominating set is called *proper perfect edge dominating set* because $W, B, Y \neq \emptyset$. Similarly, (B, Y, W) is then called a *proper coloring*.

3 Claw-free graphs of degree at most three

In this section, we prove NP-completeness of the perfect edge domination problem, for claw-free graphs, of degree at most three. We recall that the efficient edge domination problem can be solved in polynomial time for general claw-free graphs [6, 12]. However, for r -regular graphs, fixed $r \geq 3$, efficient edge domination problem is also NP-complete [4].

Theorem 1 [4] For arbitrary fixed $r \geq 3$, deciding on the existence of efficient edge dominating sets on r -regular graphs is NP-complete.

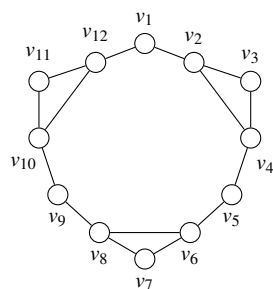

Fig. 1 The shield graph

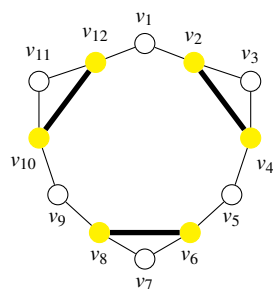

Fig. 2 The minimum PEDS which is a EEDS

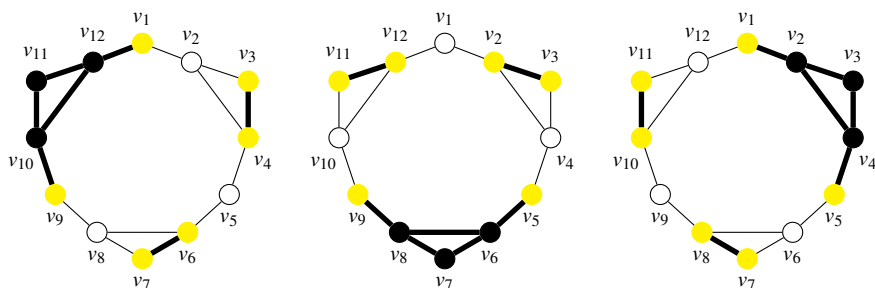

Fig. 3 Proper PEDS

Let G be an r -regular graph with n vertices. Then the number of its edges is exactly $\frac{rn}{2}$. Suppose G admits some efficient edge dominating set D . It will be useful to determine $|D|$. Let $(B = \emptyset, Y, W)$ be the 3-coloring associated to D . It is easy to see, $|Y| = 2|D|$, $|W| = n - 2|D|$, $\frac{rn}{2} - |D| = r|W| = r(n - 2|D|) = rn - 2r|D|$ and $\frac{rn}{2} - |D| = (r - 1)|Y| = (r - 1)2|D| = 2r|D| - 2|D|$ which implies $rn - 2r|D| = 2r|D| - 2|D|$ and $rn = 4r|D| - 2|D| = (4r - 2)|D|$. Hence, $|D| = \frac{rn}{4r - 2}$.

Now, let us turn to the perfect edge domination problem. Start by determining the possible perfect edge dominating sets for the graph of Figure 1.

Lemma 1 *The only perfect edge dominating sets of the shield graph are the following cases:*

- (i) *The efficient edge dominating set $\{v_2v_4, v_6v_8, v_{10}v_{12}\}$ (Figure 2).*

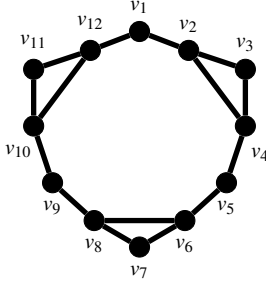

Fig. 4 The trivial PEDS

- (ii) The (symmetrical) proper perfect edge dominating sets $\{v_3v_4, v_6v_7, v_9v_{10}, v_{10}v_{11}, v_{11}v_{12}, v_{12}v_1, v_{10}v_{12}\}$, $\{v_2v_3, v_5v_6, v_6v_7, v_7v_8, v_8v_9, v_6v_8, v_{11}v_{12}\}$ and $\{v_1v_2, v_2v_3, v_3v_4, v_4v_5, v_2v_4, v_7v_8, v_{10}v_{11}\}$ (Figure 3).
- (iii) The trivial perfect edge dominating set $\{v_1v_2, v_2v_3, v_3v_4, v_4v_5, v_5v_6, v_6v_7, v_7v_8, v_8v_9, v_9v_{10}, v_{10}v_{11}, v_{11}v_{12}, v_{12}v_1, v_2v_4, v_6v_8, v_{10}v_{12}\}$ (Figure 4).

Proof. Clearly, all edges subsets described in (i), (ii) and (iii) are perfect edge dominating sets of the shield graph. Let P be a perfect edge dominating set of such a graph and (B, Y, W) , the 3-coloring associated to P . Consider the colors of v_3, v_7 and v_{11} .

- The vertices $v_3, v_7, v_{11} \in B$. By Observation 6, $v_2, v_4, v_6, v_8, v_{10}$ and v_{12} are also black vertices. v_1, v_5 and v_9 can be neither white vertices (Observation 4) nor yellow vertices (Observation 3). Hence, all vertices have black colors which implies P to be the trivial perfect edge dominating set described in (iii).
- Suppose that v_3 is a white vertex. By Observation 6, v_2 and v_4 are yellow vertices. By observation 3, v_1 and v_5 must be white vertices. And by Observation 4, v_{12} and v_6 are yellow vertices. Clearly, by Observation 6, exactly one of v_7 or v_8 is yellow vertex and the other is white. Suppose that $v_7 \in Y$ and $v_8 \in W$. Then $v_9 \in Y$ (Observation 4) and $v_{10} \notin W$ (Observation 3). As v_{10} has two yellow neighbors (v_9 and v_{12}), by Observation 3, v_{10} is a black vertex. Therefore, the condition of Observation 6 does not hold for the triangle $\{v_{10}, v_{11}, v_{12}\}$, a contradiction. Consequently, $v_8 \in Y$ and $v_7 \in W$. Symmetrically, using exactly the same argument, we conclude that $v_{10} \in Y$ and $v_{11} \in W$. Finally, v_9 is a white vertex by Observation 3 and clearly P is the efficient edge dominating set described in (i).
- Next, consider v_3 to be yellow. Using the Observations stated before, and employing a case analysis, leads to proving item (ii) of the lemma. The details are omitted. \square

We employ an operation that replaces certain vertices by the shield graph.

Let G be a graph having a vertex v of degree 3, and x, y and z , the neighbors of v . The **magnification** of v is the operation that replaces v by a shield S_v and replaces the edges xv, yv, zv by xv_3, yv_7, zv_{11} (we call v_3, v_7 and v_{11} the *contact* vertices of S_v). The magnification of a cubic graph G , $\mathcal{M}(G)$, is the graph obtained applying magnification to all its vertices. The following claim is obvious.

Claim $\mathcal{M}(G)$ is claw-free and has degree at most 3.

If G has n vertices (implying that G has $\frac{3n}{2}$ edges) then $\mathcal{M}(G)$ has $12n$ vertices and $15n + \frac{3n}{2} = \frac{33n}{2}$ edges.

We relate the cardinality of an efficient edge dominating set of G to that of a perfect edge dominating set of $\mathcal{M}(G)$.

Theorem 2 *Let G be a cubic graph with n vertices and $\mathcal{M}(G)$ the magnification of G . Then G admits some efficient edge dominating set D if and only if $\mathcal{M}(G)$ has a perfect edge dominating set P of size at most $\frac{57n}{10}$.*

Proof. Assume G admits some efficient edge dominating set D with $|D| = \frac{3n}{10}$. Let Y_D the subset of vertices incident to some edge of D and $W_D = V \setminus Y_D$. It is clear that $|Y_D| = \frac{3n}{5}$ and $|W_D| = \frac{2n}{5}$. Next, we will describe how to construct a perfect edge dominating set P of $\mathcal{M}(G)$ by choosing appropriately its associated 3-coloring (B, Y, W) . As the vertices of $\mathcal{M}(G)$ are partitioned into n different shields S_v , we choose locally the coloring of each shield S_v , then we check if the total coloring is valid. If $v \in W_D$ then its corresponding shield S_v takes the coloring described in Figure 2. Otherwise, $v \in Y_D$ and v has exactly 2 white neighbors and one neighbor v' in G . In this case, such S_v and $S_{v'}$ should take some coloring described in Figure 3 in such a way that the edge connecting both shields in $\mathcal{M}(G)$ has both extreme vertices with black color. Clearly, this can be achieved. This coloring is valid because the partial coloring in each shield is valid and every edge that connects two shields has both extreme vertices with black color or one with white color and the other with yellow color. Now, we examine the number of edges of this perfect edge dominating set P . Every shield S_v contributes 3 edges if v is white and 7 edges if v is yellow. The number of edges that belong to P and connect two shields is exactly the number of edges in D . Consequently, the total number of edges of P is $3|W_D| + 7|Y_D| + |D| = \frac{6n}{5} + \frac{21n}{5} + \frac{3n}{10} = \frac{57n}{10}$ as required.

Conversely, suppose $\mathcal{M}(G)$ has a perfect edge dominating set P of size at most $\frac{57n}{10}$. Let (B, Y, W) be the associated 3-coloring of P . We examine locally the coloring of each shield S_v . If some contact vertex has white color, then using the same argument as in the proof of Lemma 1 all contact vertices have white color and there are exactly 3 edges of P within S_v . In this case, call S_v a white shield. Similarly, if some contact vertex has yellow color, there are exactly 2 contact vertices with yellow color, the other contact vertex is black and there are exactly 7 edges of P within S_v . In this case, call S_v a yellow shield. The third possibility is that all contact vertices have black color and all 15 edges of S_v belong to P . We call S_v a black shield. Denote by b, y, w the numbers of black, yellow and white shields, respectively. Clearly, every white shield is adjacent to exactly 3 yellow shields (two shields are adjacent if there is some edge between their contact vertices), and every yellow shield is adjacent to two white shields and to one non-white shield. It implies that $3w = 2y$. This is the number of edges that connect two different shields and do not belong to P . As the total number of edges of $\mathcal{M}(G)$ is $\frac{33n}{2}$ and $|P| \leq \frac{57n}{10}$, the number of edges that do not belong to P is $12w + 8y + 3w = 12w + 12w + 3w = 27w \geq \frac{108n}{10}$. That is $w \geq \frac{2n}{5}$. Hence, $y \geq \frac{3n}{5}$ and $b = 0$. Moreover, $w = \frac{2n}{5}$ and $y = \frac{3n}{5}$. We can define the color of each vertex v of G as the color of S_v . This coloring corresponds to an efficient edge dominating set of G . \square

The next corollary is a consequence of Theorems 1 and 2.

Corollary 1 *The minimum perfect edge domination problem for claw-free graphs of degree at most 3 is NP-hard.*

Proof. Clearly, checking if a subset of edges is a perfect edge dominating set of at most certain size can be done in polynomial time. This implies the problem is \mathcal{NP} . To prove the completeness, we can apply the reduction from efficient edge domination problem for cubic graphs which is NP-complete by Theorem 1. Take any instance of this problem. The input

is a cubic graph G with n vertices. We transform G to $\mathcal{M}(G)$ which is claw-free and has degree at most 3. This can be done in polynomial-time. By Theorem 2, G has an efficient edge dominating set if only if $\mathcal{M}(G)$ has a perfect edge dominating set of size at most $\frac{57n}{10}$. Therefore, the proof is complete. \square

4 Cubic claw-free graphs

In this section, we show that the weighted version of the perfect edge domination problem can be solved in linear time for cubic claw-free graphs. Without loss of generality, we consider only connected graphs.

The first lemma concerns efficient edge dominating sets of claw-free graphs.

Lemma 2 [12] *There is an algorithm of complexity $O(n)$ which finds the least weight efficient edge dominating set of a claw-free graph G , or reports that G does not admit efficient edge dominating sets.*

The following observation is useful.

Observation 8 *A graph G is a cubic claw-free graph if and only if G is cubic and every vertex of it is contained in some triangle.*

The second lemma concerns proper perfect edge dominating sets of connected graphs where every vertex is contained in some triangle.

Lemma 3 *Let G be a connected graph where every vertex is contained in some triangle. Then G admits no proper perfect edge dominating set.*

Proof. Suppose the contrary and let P be a proper perfect edge dominating set of G , and (B, Y, W) its corresponding coloring of the vertices of G . The idea is to show that every vertex of G has black color which implies that P is the trivial perfect edge dominating set, which is a contradiction. Since P is proper, G contains some black vertex v . By the hypothesis, v is contained in at least one triangle of G . Clearly, any pair of adjacent neighbors of v must have black color by Observation 6. We can apply iteratively the same reasoning to each new considered black vertex and we call this procedure as *black propagation*. If every vertex of G has been considered, we are done. Suppose there is some unconsidered vertex. As G is connected, there must be an edge uw in G such that u has been considered and w has not. It is clear that u and w do not have a common neighbor. Again, by the hypothesis, there is a triangle C' containing w . Since u has black color, by Observation 4, w cannot be a white vertex. By Observation 6, w must have some neighbor with non-white color in C' . But w has already a black neighbor u which is not in C' . Therefore, w has black color by Observation 3. Again, we can apply the black propagation to w . Repeating iteratively the same argument, we conclude that all vertices of G must be black, and therefore G cannot contain a proper edge dominating set. \square

The algorithm follows immediately from the two above lemmas and the Observation 8. Let G be a connected cubic claw-free graph, whose edges have been assigned weights, possibly negative. By Lemma 3 it does not contain proper perfect edge dominating sets. Then first, we apply the algorithm described in [12] for claw-free graphs. If G contains an efficient edge dominating set then the latter algorithm finds the least weighted of such sets, and the minimum between this set and the trivial perfect edge dominating set $E(G)$ is the

answer of our algorithm. Otherwise, G does not contain an efficient edge dominating set, and therefore the only perfect edge dominating set of G is $E(G)$ and this is the answer of the algorithm.

By recalling that $|E(G)| = \frac{3n}{2}$, the complexity of the algorithm is therefore $O(n)$.

This linear time algorithm can be extended easily to claw-free graphs where every degree two vertex has two adjacent neighbors. Because in this case, every vertex is in some triangle except for pendant vertices. We can see that Lemma 3 is still valid for any connected component of these graphs. We know that pendant vertices never have black colors by definition. If there is some black vertex in the connected component, then all vertices of this component are colored black, except the pendant ones. Therefore, every such pendant vertex has a black neighbor if the component is not exactly K_2 . In any case, every pendant vertex must be colored yellow. Consequently, there are no white vertices. This means that Lemma 3 remains valid for connected claw-free graphs where every degree two vertex has two adjacent neighbors. The latter implies that the linear time algorithm above described can be extended for such class.

5 Bounded degree graphs of large girth

In this section, we prove NP-hardness of the perfect edge domination problem in bounded degree graphs even restricted to those of large girth.

The following additional notation is employed. For a non negative integer l , and an edge $e = vw \in E(G)$, where $v, w \in V(G)$, the l -subdivision of e is the operation that replaces e by a $(l+1)$ -path, denoted by $S_l(e)$, formed by edges e_0, \dots, e_l , such that all its l internal vertices are newly inserted vertices, each of degree 2, while e_0 is incident to v and e_l incident to w . In general, for $E' \subseteq E(G)$, $S_l(E')$ is the set of the l -subdivisions of the edges of E' , while $S_l(G)$ denotes the l -subdivision graph of G , the one obtained by subdividing all its edges. In such a graph, the extreme vertices of each edge $e \in E(G)$ become the extremes of the paths $S_l(e)$ and are called *extremes* of $S_l(G)$. We omit the subscript from S when there is no ambiguity.

Throughout this section, G denotes an r -regular graph, and $S(G)$ the $3k$ -subdivision of G , for some integer $k \geq 0$. To avoid trivial cases, let $r \geq 3$.

Lemma 4 *Let $e = vw \in E(G)$ and P be a perfect edge dominating set of $S(G)$. Then*

1. $|S(e) \cap P| \geq k$.
2. $|S(e) \cap P| = k \Rightarrow e_0, e_{3k} \notin P, |\{v, w\} \cap W| = 1$ and $|\{v, w\} \cap Y| = 1$.

Proof. Note that Lemma 4 holds for $k = 0$ since (1.) is trivially true and (2.) holds because $e = e_0 = e_k$ is dominated by P . For $k \geq 1$ since P is a perfect edge dominating set, at least one in every three consecutive edges of $S(e)$ must belong to P . Observe the following subsets of edges $\{e_1, e_2, e_3\}, \{e_4, e_5, e_6\}, \dots, \{e_{3k-2}, e_{3k-1}, e_{3k}\}$. Each of them has at least one edge of P and we can conclude that $|S(e) \cap P| \geq k$. If some of them has at least two edges of P then $|S(e) \cap P| \geq k+1$. Otherwise, every one has exactly one edge of P . Easily, we can determine these edges knowing which edge of $\{e_1, e_2, e_3\}$ belongs to P . The three possibilities are: (i) $e_1, e_4, \dots, e_{3k-2}$ (ii) $e_2, e_5, \dots, e_{3k-1}$ and (iii) e_3, e_6, \dots, e_{3k} .

Next, we assume that $|S(e) \cap P| = k$ and we consider the alternatives:

1. $e_0 \in P$

Then $|S(e) \cap P| = |\{e_0\}| + |\{e_1, e_2, e_3\} \cap P| + \dots + |\{e_{3k-2}, e_{3k-1}, e_{3k}\} \cap P| \geq 1+k$ which is a contradiction.

2. $e_{3k} \in P$

Using similar argument of Alternative 1, we can conclude that $|S(e) \cap P| \geq k + 1$. Again, a contradiction.

3. $e_0, e_{3k} \notin P$

Examine the further alternatives:

(a) $v, w \in W$:

Clearly, $e_1, e_{3k-1} \in P$. Hence, some of the subsets $\{e_1, e_2, e_3\}, \{e_4, e_5, e_6\}, \dots, \{e_{3k-2}, e_{3k-1}, e_{3k}\}$ has at least two edges of P and implies that $|S(e) \cap P| \geq k + 1$. This is a contradiction.

(b) $v, w \in Y$:

Then $e_1, e_{3k-1} \notin P$ because e_0 (e_{3k}) is dominated by some edge incident to v (w). Furthermore, $e_2, e_{3k-2} \in P$ (to dominate e_1 and e_{3k-1} , respectively). Again, some of the subsets $\{e_1, e_2, e_3\}, \{e_4, e_5, e_6\}, \dots, \{e_{3k-2}, e_{3k-1}, e_{3k}\}$ has at least two edges of P implying that $|S(e) \cap P| \geq k + 1$ and leading to a contradiction.

(c) $v \in B$ or $w \in B$:

Then $e_0 \in P$ or $e_{3k} \in P$ which is a contradiction to the assumption.

(d) One of v, w is W and the other one is Y . This is the only situation where $|S(e) \cap P| = k$ can occur.

□

The next lemma describes a lower bound for the size of a perfect edge dominating set of $S(G)$.

Lemma 5 *Let $e \in E(G)$ and P be a perfect edge dominating set of $S(G)$. Then*

1. $|S(N'[e]) \cap P| \geq 2rk - k + 1$
2. $|P| \geq \frac{nr}{2(2r-1)} \cdot (2rk - k + 1)$

Proof. By Lemma 4, it follows that $|S(e) \cap P| \geq k$, for any $e \in E(G)$. Since G is an r -regular graph, $|N'[e]| = 2r - 1$. Consequently, $|S(N'[e]) \cap P| \geq (2r - 1)k$. In addition, also by Lemma 4, $|S(e) \cap P| = k$ implies that an extreme vertex v of e belongs to W , the other extreme $w \in Y$, and the extreme edge e_{3k} of $S(e)$, incident to w , is not in P . In order to attain $|S(N'[e]) \cap P| = (2r - 1)k$, all $2r - 1$ edges of $N'[e]$ must satisfy the latter condition. However, the yellow extreme vertex of e must have some incident edge $e'' \in P$ and this edge e'' belongs to some $S(e')$, $e' \in E(G)$. Clearly, $e' \in N'(e)$ and according to Lemma 4, $|S(e') \cap P| \geq k + 1$. Consequently, the bound is refined as $|S(N'[e]) \cap P| \geq (2r - 2)k + k + 1 = 2rk - k + 1$, proving the first part of the lemma.

To prove the second part, we remind that in each edge neighborhood $N'[e]$ of G , $2r - 2$ of the edges of $S(N'[e])$ contain at least k edges of P , while one edge of $N'[e]$ corresponds in $S(N'[e])$ to at least $k + 1$ edges in P . Since $|E(G)| = \frac{nr}{2}$ and $|P| = \sum_{e \in E(G)} |S(e) \cap P|$, it follows $(2r - 1)|P| = \sum_{e \in E(G)} |S(N'[e]) \cap P| \geq \frac{nr}{2}(2rk - k + 1)$. That is, $|P| \geq \frac{nr}{2(2r-1)} \cdot (2rk - k + 1)$, as required. □

Corollary 2 *The following are equivalent:*

- (i) $S(G)$ admits a perfect edge dominating set of size $\frac{nr}{2(2r-1)} \cdot (2rk - k + 1)$
- (ii) G can be colored with two colors, W and Y , such that
 - No two vertices of W are adjacent, and
 - Every vertex of Y has exactly one neighbor of the same color in G .
- (iii) G admits an efficient edge dominating set.

Proof. (i) \Rightarrow (ii)

By the two previous lemmas, whenever $|P| = \frac{nr}{2(2r-1)} \cdot (2rk - k + 1)$, in each edge neighborhood $N'[e]$ of G , $2r - 2$ of the edges of $S(N'[e])$ contain exactly k edges of P , while one edge

of $N'[e]$ contributes with $k+1$ edges to P . Color the vertices of G , as follows. Assign color Y to both extremes of the edges which contribute with $k+1$ edges and the color W to the remaining vertices of G . The coloring so obtained satisfies the required conditions.

(ii) \Rightarrow (i)

By hypothesis, G admits a coloring with colors W and Y , satisfying the conditions of the theorem. Such a coloring partitions the edges of $E(G)$ into two types. Those whose extremes are colored W and Y , and those with both extremes colored Y . If $k=0$, $G=S(G)$ and we define P as the set of edges with both extremes colored Y . If $k \geq 1$ since every yellow vertex has exactly one yellow neighbor in G , it follows that, for any $e \in E(G)$, $S(N'[e])$ contains exactly one edge with both extremes Y , while each one of the remaining edges of $S(N'[e])$ has extremes colored W and Y , respectively. We can construct a perfect edge dominating set P , by selecting edges from each $N'(e)$, where $e = vw \in E(G)$. If v and w are both in Y then $S(e) \cap P = \{e_0, e_3, \dots, e_{3k}\}$. Otherwise, we can suppose that v is in W while w is in Y , and in this case $S(e) \cap P = \{e_1, e_4, \dots, e_{3k-2}\}$. It is easy to verify that P is a perfect edge dominating set of size $\frac{nr}{2(2r-1)} \cdot (2rk - k + 1)$.

The proofs (ii) \Rightarrow (iii) and (iii) \Rightarrow (ii) are straightforward. \square

Next, we present the main result of this section.

Theorem 3 *The cardinality perfect edge domination problem is NP-hard, even if restricted to graphs having vertices of bounded degree r and girth at least k , for any fixed $r, k \geq 3$.*

Proof. It is straightforward to conclude that the problem belongs to \mathcal{NP} . The transformation is from the efficient edge domination problem for r -regular graphs, which is known to be NP-complete for fixed r (Cardoso, Cerdeira, Delorme and Silva [4]). Let G be an r -regular graph, $|V(G)| = n$. Construct an instance of the perfect edge domination problem, as follows. Let $k \geq 3$ be a fixed integer, define $k' = \max\{1, \lceil \frac{k-3}{9} \rceil\}$. The input graph for the latter problem is the $3k'$ -subdivision $S(G)$ of G . Set the value of p , as $p = \frac{nr}{2(2r-1)} \cdot (2rk' - k' + 1)$. Clearly, $S(G)$ has no cycles shorter than $3 \cdot (3k' + 1) = 9k' + 3 \geq k$ and its vertices have maximum degree r . Finally, by Corollary 2, G contains an efficient edge dominating set if and only if $S(G)$ contains a perfect edge dominating set of size p which completes the proof of NP-completeness. \square

As Lemma 4, Lemma 5 and Corollary 2 hold for $k=0$, and using similar arguments of the proof of Theorem 3, we can prove the following corollary.

Corollary 3 *The cardinality perfect edge domination problem is NP-hard, even if restricted to r -regular graphs, for $r \geq 3$.*

6 A dichotomy theorem

In this section, we describe a dichotomy theorem for the complexity of the perfect edge domination problem. It is a consequence of the NP-completeness proofs of the previous sections.

Define a *linear forest* as a graph whose connected components are induced paths.

Theorem 4 *Let H be a graph, and \mathcal{G} the class of H -free graphs of degree at most d , for some fixed $d \geq 3$. Then the perfect edge domination problem is*

- polynomial time solvable for graphs in \mathcal{G} if H is a linear forest
- NP-complete otherwise.

Proof. First, assume H is not a linear forest. There are two situations. If H contains some induced cycle C_s it follows that \mathcal{G} contains, as a subclass, the C_s -free graphs of maximum degree at most d . The latter subclass contains the graphs of bounded degree at most d and girth at least $s + 1$. By Theorem 3, the perfect edge dominating set is NP-complete for such a class. For the second alternative, assume that H does not contain cycles. Since H is not a linear forest, it follows that H is a forest containing a vertex of degree at least 3. That is, \mathcal{G} contains the class of claw-free graphs of maximum degree at most 3. By Corollary 1 the perfect edge domination problem is also NP-complete in this case.

Finally, assume that H is a linear forest and its connected components consist of exactly t disjoint induced paths. In this case, we can bound the number of vertices of each connected component of G . Then H is an induced subgraph of P_q , with $q = |V(H)| + t - 1$. An H -free graph is in particular P_q -free, and each connected component of G is P_q -free and has maximum degree at most d . Then each connected component has at most $\frac{d^q - 1}{d - 1}$ vertices. That is, a constant number of vertices as H has fixed size. Therefore, we can solve perfect edge domination problem in polynomial time. \square

Corollary 4 *The perfect edge domination problem is NP-complete for H -free graphs where H is any graph except linear forests.*

We leave as an open problem the question whether or not there exists some graph class for which the efficient edge domination problem is NP-complete and the perfect edge domination problem can be solved in polynomial time.

7 Perfect edge dominating sets of P_5 -free graphs

In this section, we describe a robust linear time algorithm for finding minimum weight perfect edge dominating set of a P_5 -free graph. Given an arbitrary graph G , in linear time the algorithm either finds such edge dominating set or exhibits an induced P_5 of the graph.

The following definitions are useful. Let G be a connected graph, and $v \in V(G)$. The *eccentricity* of v , denoted $\varepsilon(v)$ is the maximum distance between v and any other vertex. A vertex of minimum eccentricity in the graph is called *central*. Finally, a vertex having eccentricity at most 2 is named *principal vertex*.

Note that if a connected graph has a vertex with eccentricity at least 4 then it has an induced P_5 . Any central vertex of a connected P_5 -free graph has eccentricity at most 2 (consequence of Theorem 5).

7.1 The basis

We describe below the theorems in which the correctness and complexity of the proposed algorithm is based on.

The following structural result by Bacsó and Tuza is fundamental.

Theorem 5 [1] *Every connected graph contains an induced P_5 , a dominating K_p , or a dominating P_3 .*

The proposed algorithm needs to determine which of these three subgraphs G contains. This will be achieved through a principal vertex. Then we need a robust method to compute such a vertex, if it exists. For a chosen vertex v , call $Test(v)$ the operation that determines its eccentricity and recognizes the following situations:

- (i) If v has infinite eccentricity, then G is not connected.
- (ii) If v has eccentricity at least 4, then G has an induced P_5 .
- (iii) If v has eccentricity 3, then G has an induced P_4 starting in v ,
- (iv) If v has eccentricity at most 2, then v is a principal vertex of G .

It is clear that $\text{Test}(v)$ can be done in linear-time. The cases (i) and (ii) allow to recognize that the input G is not a connected P_5 -free graph.

The following theorem describes the robust linear time computation of a principal vertex.

Theorem 6 *Any connected graph G contains a principal vertex or an induced P_5 . Moreover there is a linear-time algorithm to find a principal vertex of G or to detect that G is not P_5 -free.*

Proof. We describe an algorithm that uses at most 3 times the procedure *Test* to check a vertex. At any point of the algorithm, if an induced P_5 is found, then the algorithm ends and returns that induced P_5 . First choose any vertex $u \in V$ and $\text{Test}(u)$. If $\varepsilon(u) = 3$, let z be such that $\text{dist}(u, z) = 3$ and u, v, w, z an induced P_4 . Choose $v_1 \in A := N(u) \cap N(w)$ such that v_1 has the maximum number of neighbors in $B := V \setminus (N(u) \cup N(w) \cup N(z))$. Note that u, v_1, w, z is an induced P_4 and possibly $v = v_1$.

Next, $\text{Test}(v_1)$ and $\text{Test}(w)$. We will show that $\varepsilon(v_1) = \varepsilon(w) = 3$ implies that G has an induced P_5 . As v_1 has eccentricity 3, there exists a vertex x such that $\text{dist}(x, v_1) = 3$. Also x verifies $\text{dist}(x, w) = 3$ or $\text{dist}(x, w) = 2$ because $v_1 w \in E(G)$.

If $\text{dist}(x, w) = 3$ let v_1, a, b, x be a shortest path between v_1 and x , as in Figure 5. Note that $N[x] \cap \{u, v_1, w, z\} = \emptyset$, $N(b) \cap \{v_1, w\} = \emptyset$ because $\text{dist}(x, v_1) = 3$ and $\text{dist}(x, w) = 3$. If $N(b) \cap \{u, z\} \neq \emptyset$ there is an induced P_5 and we can find it and return it. Otherwise, $N(b) \cap \{u, z\} = \emptyset$. We can assume $wa \in E(G)$ otherwise w, v_1, a, b, x is an induced P_5 . Following the same idea, x, b, a, v_1, u and x, b, a, w, z are possible induced P_5 's, then we can assume that $ua, az \in E(G)$ which is a contradiction because $\text{dist}(u, z) = 3$. Therefore, in this case the algorithm always finds an induced P_5 .

If $\text{dist}(x, w) = 2$ let w, a, x be a shortest path between w and x . Note that $N[x] \cap \{u, v_1, w\} = \emptyset$ because $\text{dist}(x, v_1) = 3$. If $zx \in E(G)$ then u, v_1, w, z, x is an induced P_5 . Thus, $zx \notin E(G)$ and we are in the situation of Figure 6. We assume $ua \in E(G)$ otherwise u, v_1, w, a, x is an induced P_5 . This implies that $a \in A = N(u) \cap N(w)$ and it is adjacent to $x \in B = V \setminus (N(u) \cup N(w) \cup N(z))$. Recall that v_1 was chosen as a vertex belonging to A with maximum degree in B . As $v_1 x \notin E(G)$, then there exists $y \in B$ such that $v_1 y \in E(G)$ and $ay \notin E(G)$. It follows that there is a P_5 induced either by y, v_1, u, a, x if $xy \notin E(G)$ or by x, y, v_1, w, z if $xy \in E(G)$. Again, the algorithm always finds an induced P_5 . \square

Once a principal vertex is obtained, we find an induced P_5 , or a dominating K_p , or a dominating P_3 following the theorem below. We remark that using a recent characterization of P_k -free graphs, by Camby and Schaudt [5], it is possible to obtain a dominating induced P_3 or a dominating K_p in $O(n^5(n+m))$ time when a connected P_5 -free graph is given.

Theorem 7 *For any connected graph G , there is a linear-time algorithm to find a dominating induced P_3 , a dominating K_p , or to detect that G is not a P_5 -free graph.*

Proof. The algorithm searches a dominating set contained in $N[v]$ where v is a principal vertex of G . Again, at any point of the algorithm, if an induced P_5 is found, then the algorithm ends and returns that induced P_5 .

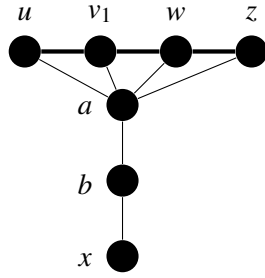

Fig. 5 $dist(v_1, x) = dist(w, x) = 3$.

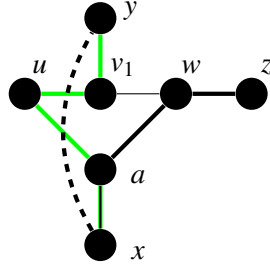

Fig. 6 $dist(v_1, x) = 3$ and $dist(w, x) = 2$.

1. Find a principal vertex v or an induced P_5 of G using the robust linear-time algorithm of Theorem 6.
2. Let $X := N[v]$ be the initial dominating set. Consider iteratively each vertex $w \in N(v)$: if $X \setminus \{w\}$ is still a dominating set then $X := X \setminus \{w\}$. This can be done in linear-time using a variable for each vertex of $V \setminus N[v]$ to count the number of neighbors in X . A vertex $w \in N(v)$ can not be removed from X if only if some of its neighbors has exactly one dominator in X .
3. If $|X| \leq 3$ then G has a dominating P_3 or a dominating $K_{|X|}$. If $|X| \geq 4$ and it is not a complete graph, we will show that G has an induced P_5 . We can assume that G has a subgraph like one in Figure 7, where $\{v_1, v_2, v_3\} \subset X$ and does not induce a triangle. Each one of them has a proper dominated vertex w_1, w_2, w_3 respectively. Edges between w_i and w_j are drawn in order to avoid the induced P_5 w_i, v_i, v, v_j, w_j . Nevertheless in (i) and (ii) w_2, w_1, v_1, v, w_3 is a induced P_5 ; and in (iii) the vertices w_2, v_2, v_3, w_3, w_1 or w_2, w_1, v_1, v, w_3 induce a P_5 .

□

We remark that the above theorem might be of interest to other P_5 -free algorithmic problems, since it represents an algorithmic proof of Bacsó and Tuza's theorem [1].

7.2 Colorings, vertex dominating sets and perfect edge dominating sets

Next, we describe the remaining algorithms on which the proposed solution is based. They are related to 3-colorings of the graph, vertex dominating sets and the different kinds of perfect edge dominating sets, that is, efficient edge dominating, trivial ones and proper.

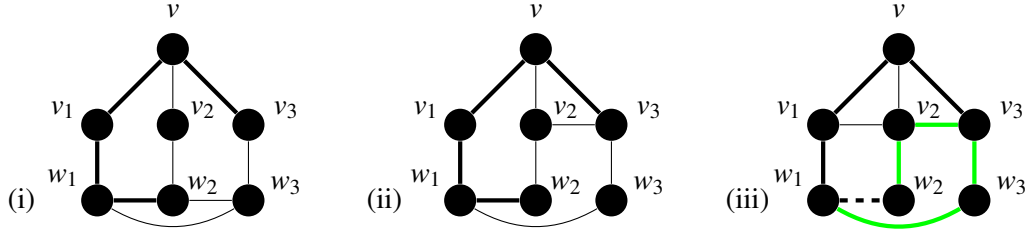

Fig. 7 Center v and its sons and proper grandsons.

The first two theorems concern the construction of perfect edge dominating sets, associated to a given 3-coloring of the graph.

Theorem 8 *Given a graph G and $W \subseteq V$, there is a linear-time algorithm to verify if there exists some perfect edge dominating set whose associated 3-coloring is (B, Y, W) .*

Proof. In the affirmative case, using Observation 3, we can determine Y in linear-time and so $B = V \setminus (W \cup Y)$. Therefore, we construct a 3-coloring (B, Y, W) in this way and then test the validity of (B, Y, W) by checking the conditions of Observations 1, 3 and 4. All these computations can be done in linear-time. \square

Theorem 9 *Given a connected graph G and $Y \subset V$, there is a linear-time algorithm to verify if there exists some perfect edge dominating set whose associated 3-coloring is $(B = \{b\}, Y, W)$. Moreover, the algorithm can find a vertex b for which the sum of the weight of its incident edges is minimum.*

Proof. Clearly, if such perfect edge dominating set exists, it verifies

- i. $G[Y]$ is a graph with maximum degree 1 and at least one vertex has degree 0.
- ii. $V \setminus Y$ is an independent set.
- iii. If $\{s_1, s_2, \dots, s_k\} \subseteq Y$ are the vertices with degree 0 in $G[Y]$, and $\{y_1, y_2, \dots, y_l\} \subset Y$ are the vertices of degree 1, the black vertex belongs to $\bigcap_{i=1}^k N(s_i) \setminus \bigcup_{j=1}^l N(y_j)$.

Therefore, we check conditions (i) and (ii), and construct $A = \bigcap_{i=1}^k N(s_i) \setminus \bigcup_{j=1}^l N(y_j)$ in linear-time. Note that all vertices in A are equivalent. If $A \neq \emptyset$, each $b \in A$ generates a valid coloring (B, Y, W) , $B = \{b\}$, $W = V \setminus (B \cup Y)$. Condition (ii) and $|B| = 1$ imply that (B, Y, W) satisfies the conditions of Observations 1 and 4. Condition (i) and $b \in A$ imply that (B, Y, W) satisfies the condition of Observation 3. So, the validity of (B, Y, W) holds. \square

The next theorem refers to finding an efficient edge dominating set of a graph, given a fixed size vertex dominating set of it.

Theorem 10 [11] *Given a graph G and a vertex dominating set of fixed size of G , there is a linear-time algorithm to solve the minimum weight efficient edge domination problem for G .*

The following results relate trivial perfect edge dominating sets of a graph and the existence of vertex dominating complete subgraphs of certain sizes.

Observation 9 *Given a graph G , a dominating set D of G , a perfect edge dominating set P of G and (B, Y, W) the 3-coloring associated to P , if $D \subseteq B$ then P is the trivial perfect edge dominating set.*

This observation is a direct consequence of Observation 4.

Corollary 5 *Given a connected graph G , if there is a dominating K_p with $p \geq 4$ then G has exactly one perfect edge dominating set P and P is trivial.*

Proof. Suppose that there is a non-trivial perfect edge dominating set P . By Observation 5, all vertices of K_p must be black and by Observation 9, P must be trivial and this is a contradiction. \square

Corollary 6 *Given a connected P_5 -free graph G , if G admits some non-trivial perfect edge dominating set P then G has a dominating induced P_3 or a dominating K_3 .*

Proof. If G has at most 2 vertices, then it has only one perfect edge dominating set which is trivial. Therefore, G has at least 3 vertices. Now, suppose that G has neither dominating induced P_3 nor dominating K_3 . By Theorem 5, G must have some dominating K_p with $p \neq 3$. In case $p \geq 4$, by Corollary 5, G has no non-trivial perfect edge dominating set which is a contradiction. Therefore, $p \leq 2$. As G is connected with at least 3 vertices, it is always possible to add more vertices to K_p to form a dominating K_3 or a dominating induced P_3 . Again, a contradiction. \square

Corollary 7 *Given a graph G , if G has some vertex dominating K_1 or K_3 then G has no proper edge dominating sets.*

Proof. First, assume G has a dominating $K_1 = \{u\}$ which means that u is a universal vertex. Suppose that P is a proper edge dominating set. Let v be any black vertex. By Observation 9, v cannot be a universal vertex. As u is a neighbor of v , then u is a yellow vertex because it is a universal vertex. As v is a black vertex, v has another non-white neighbor w . Moreover, w is adjacent to the universal vertex u . This contradicts that u is a yellow vertex.

Next, suppose G contains a dominating K_3 . Suppose that G has some proper edge dominating set P and (B, Y, W) , its associated 3-coloring, with $B, Y, W \neq \emptyset$. By Observation 6, (i) all vertices of the dominating K_3 are black or (ii) exactly two of them are yellow vertices and the other vertex is white. In case (i), by Observation 9, P must be trivial which is a contradiction. In case (ii), there are no black vertices as consequence of Observations 3 and 4. Again, a contradiction. \square

Finally, the last theorem relates the existence of proper edge dominating sets to special colorings of a dominating P_3 .

Theorem 11 *Given a connected P_5 -free graph G , if G admits some proper perfect edge dominating set P , with associated 3-coloring (B, Y, W) , then G has a vertex dominating P_3 (formed by vertices v_1, v_2 and v_3) with one of the possible combinations of colors of Figure 8.*

Proof. Clearly, by Corollaries 6 and 7 G has a dominating induced P_3 . By Observations 1, 3 and 4, there exists neither two adjacent white vertices, nor yellow vertices with at least two non-white neighbors nor white vertices with black neighbors. As a consequence, the possible colors of the dominating induced P_3 must match to some combinations of Figure 8 or some of Figure 9. If the combination (f) of Figure 9 is matched then all vertices of the dominating induced P_3 are black vertices and by Observation 9, P is a trivial perfect edge dominating set leading to a contradiction. If the combination (g) of Figure 9 is matched,

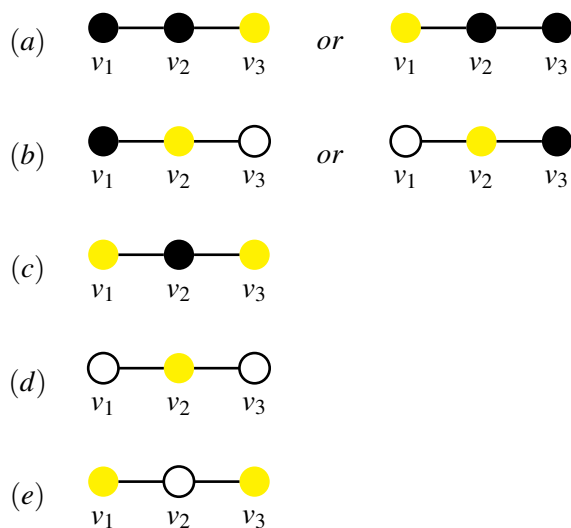

Fig. 8 Possible valid colorings of dominating induced P_3

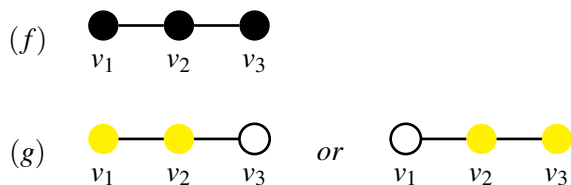

Fig. 9 Invalid colorings of dominating induced P_3

two adjacent vertices of the dominating induced P_3 are yellow vertices and the other one is a white vertex. None of these three vertices can have black neighbors which implies $B = \emptyset$ and P to be an efficient dominating set. Again, this is a contradiction. Therefore, the only valid options are those of Figure 8. \square

7.3 The algorithm

Let G , $|V(G)| > 1$, be an arbitrary connected graph. The proposed algorithm, along the process, constructs a set \mathcal{E} containing a few candidates for the minimum weight perfect edge dominating set of G . At the end, it selects the least one of them and returns the minimum edge dominating set of G ,

1. Define $\mathcal{E} := \{E(G)\}$
2. Find a principal vertex of G . If no such vertex exists then return an induced P_5 and stop.
3. Using the principal vertex v , find (i) an induced P_5 , or (ii) a dominating K_p , or (iii) a dominating P_3 .
4. Case (i): An induced P_5 is found. Then return it and stop.

5. Case (ii): A dominating K_p is found. If $p \geq 4$ then return $E(G)$ and stop. Otherwise, $p \leq 3$ and using such dominating K_p , find a minimum weight efficient edge dominating set and, if it exists, include it in \mathcal{E} . If $K_p = \{v_1, v_2\}$ and $N(v_1) \cap N(v_2) = \emptyset$ then transform the dominating K_2 into a dominating P_3 by adding a third vertex to it.
6. Case (iii): A dominating P_3 is found. First, again using such a vertex dominating set, find a minimum weight efficient edge dominating set of G , and include it in \mathcal{E} , if it exists. Then look for a proper perfect edge dominating set of G , by considering every possible coloring of the P_3 , according to Figure 8. In each of the cases (a)-(b) ((c)-(e)), below, the algorithm determines at most two (one) proper perfect edge dominating sets (set), which are (is) then included in \mathcal{E} .
 - (a) Without loss of generality, v_3 is the yellow vertex of the dominating induced P_3 . Clearly, $W = N(v_3) \setminus \{v_2\}$ and we can apply the linear-time algorithm of Theorem 8 to determine the proper perfect edge dominating set whose associated 3-coloring is (B, Y, W) . Include it in \mathcal{E} , if it exists.
 - (b) Without loss of generality, v_1 is the black vertex of the dominating induced P_3 . We can apply the same technique of (a) using $W = N(v_2) \setminus \{v_1\}$.
 - (c) Again, apply the same technique of (a) using $W = (N(v_1) \cup N(v_3)) \setminus \{v_2\}$.
 - (d) In this case, v_1 and v_3 have only yellow neighbors. As we are looking for proper perfect edge dominating sets, there is some black vertex somewhere. Clearly, v_2 must have exactly one black neighbor and the other neighbors of v_2 are white vertices. So, $Y = N(v_1) \cup N(v_3)$, $|B| = 1$, and we can apply the linear-time algorithm of Theorem 9 to determine the proper perfect edge dominating set whose associated 3-coloring is (B, Y, W) with least weight. Again, if successful include it in \mathcal{E} .
 - (e) In this case, v_1 (v_3) can have at most one black neighbor. As we are looking for proper perfect edge dominating sets, there is at least one black vertex. First, we assume that there are some triangles using edges of the dominating induced P_3 (the number of these triangles is exactly $|N(v_1) \cap N(v_2)| + |N(v_2) \cap N(v_3)|$ which can be computed in linear-time). If there are at least 2 triangles using the same edge, without loss of generality $\{v_1, v_2, x\}$ and $\{v_1, v_2, x'\}$, then the coloring is invalid. If $\{v_1, v_2, x\}$ and $\{v_2, v_3, x'\}$ are triangles then the coloring is invalid or it cannot admit black vertices, which means there are no proper perfect edge dominating sets. The only possibility for the graph to admit a proper perfect edge dominating set (which implies the existence of black vertices) is the existence of exactly one triangle using an edge of the dominating induced P_3 and $|B| = 1$. Clearly, the yellow vertices are $Y = N(v_2)$ and we then proceed as in Case (d). Next, suppose there is no triangle using an edge of the dominating induced P_3 . Clearly, every vertex in $A_{1,3} = N(v_1) \setminus N(v_3)$ has to be adjacent to every vertex in $A_{3,1} = N(v_3) \setminus N(v_1)$ or there is some induced P_5 , which the algorithm returns and then stops. It is not hard to see this can be accomplished in linear-time. Suppose that there is only a black vertex b . It has to be adjacent to v_1 and v_3 , otherwise (without loss of generality, $bv_1 \notin E(G)$) there is an induced P_5 formed by y, v_1, v_2, v_3, b where y is a yellow neighbor of v_1 . Then the yellow vertices are $Y = N(v_2)$ and we proceed as in (d). The last case is that there are two black vertices b_1, b_3 where $b_1 \in A_{1,3}$ and $b_3 \in A_{3,1}$, and the coloring is invalid if $|A_{1,3}| > 1$ or $|A_{3,1}| > 1$. The algorithm will check if $(B = \{b_1, b_3\}, Y = N(v_2), W = V \setminus (B \cup Y))$ is a valid coloring, and include in \mathcal{E} the corresponding edge dominating set. All these computations can be done in linear-time.
7. Select the least weight perfect edge dominating set of \mathcal{E} , return it and stop.

The correctness and linear time complexity of the algorithm follows directly from the propositions formulated in the previous subsections.

To summarise we state the main result of this section.

Theorem 12 *The weighted perfect edge domination problem can be solved for P_5 -free graphs in linear time in a robust way.*

Acknowledgements

We appreciate the comments of an anonymous reviewer, which significantly helped us improving the presentation and clarity of this work.

Min Chih Lin and Veronica A. Moyano were partially supported by UBACyT Grant 20020120100058 and 20020130100800BA, and PICT ANPCyT Grant 2013-2205. Vadim Lozin acknowledges support of the Russian Science Foundation, grant 17-11-01336. Jayme L. Szwarcfiter was partially supported by CNPq and CAPES, research agencies.

References

1. G. Bacsó, Zs. Tuza, Dominating cliques in P_5 -free graphs, *Periodica Mathematica Hungarica* 21, 303-308 (1990).
2. A. Brandstadt, A. Leitert, D. Rautenbach, Efficient dominating and edge dominating sets for graphs and hypergraphs, *Proceedings of the 23rd International Symposium on Algorithms and Computation (ISAAC 2012)*, 2012, *Lecture Notes in Computer Science*, 7676, 558-277 (2012).
3. A. Brandstadt, R. Mosca, Dominating induced matching for P_7 -free graphs in linear time. *Proceedings of the 22nd International Symposium on Algorithms and Computation (ISAAC 2011)*, *Lecture Notes in Computer Science*, 100-109 (2011).
4. D. M. Cardoso, J. O. Cerdeira, C. Delorme, P. C. Silva, Efficient edge domination in regular graphs, *Discrete Applied Mathematics* 156, 3060-3065 (2008).
5. E. Camby, O. Schaudt, A new characterization of P_k -free graphs, *Graph-Theoretic Concepts in Computer Science - 40th International Workshop (WG 2014)*, France, *Revised Selected Papers*, 129-138 (2014).
6. D. M. Cardoso, N. Koperlainen, V. V. Lozin, On the complexity of the induced matching problem in hereditary classes of graphs, *Discrete Applied Mathematics* 159, 521-531 (2011).
7. J. P. Georges, M. D. Halsey, A. M. Sanaulla, M. A. Whittlesey, Edge domination and graph structure, *Congressus Numerantium* 76, 127-144 (1990).
8. D. L. Gristead, P. J. Slater, N. A. Sherwani, N. D. Holnes, Efficient edge domination problems in graphs, *Information Processing Letters* 48, 221-228 (1993).
9. A. Hertz, V. Lozin, B. Ries, V. Zamaraev, D. de Werra, Dominating induced matchings in graphs containing no long claw, accepted for *J. Graph Theory*.
10. M. C. Lin, M. Mizrahi, J. L. Szwarcfiter, An $O^*(1.1939^n)$ time algorithm for minimum weighted dominating induced matching *Proceedings of the 24th International Symposium on Algorithms and Computation (ISAAC 2013)*, 2013, Hong Kong, *Lecture Notes in Computer Science*, 8283, 558-567 (2013).
11. M. C. Lin, M. Mizrahi, J. L. Szwarcfiter, Exact algorithms for dominating induced matching. *Corr*, abs/1301.7602, (2013).
12. M. C. Lin, M. Mizrahi, J. L. Szwarcfiter, Fast algorithms for some dominating induced matching problems, *Information Processing Letters* 114, 524-528 (2014).
13. M. C. Lin, M. Mizrahi, J. L. Szwarcfiter, Efficient and perfect domination on circular-arc graphs, *Proceedings of the VIII Latin-American Graphs, Algorithms and Optimization Symposium (LAGOS' 2015)*, Beberibe, Brazil, *Electronic Notes in Discrete Mathematics*, to appear (2015).
14. M. C. Lin, V. Moyano, D. Rautenbach, J. L. Szwarcfiter, The Maximum Number of Dominating Induced Matchings, *Journal of Graph Theory* 78, 258-268 (2015).
15. C. L. Lu, M.-T. Ko and C. Y. Tang, Perfect edge domination and efficient edge domination in graphs, *Discrete Applied Mathematics* 119, 227-250 (2002).
16. C. L. Lu, C. Y. Tang, Solving the weighted efficient edge domination problem in bipartite permutation graphs, *Discrete Applied Mathematics* 87, 203-211 (1998).
17. M. Xiao, H. Nagamochi, Exact algorithms for dominating induced matching based on graph partition, *Discrete Applied Mathematics* 190-191, 147-162 (2015).