

Optimisation of Pacemaker Therapy for Cardiac Function

John Gierula BSc (Hons)

NIHR Doctoral Research Fellow, Lecturer in Clinical Physiology and
Cardiac Physiologist

Submitted in accordance with the requirements for the degree of
Doctor of Philosophy

The University of Leeds
Leeds Institute of Cardiovascular and Metabolic Medicine
School of Medicine

January 2017

Intellectual Property and Publication Statements:

The candidate confirms that the work submitted is his own and that appropriate credit has been given where reference has been made to the work of others.

This copy has been supplied on the understanding that it is copyright material and that no quotation from the thesis may be published without proper acknowledgement.

The right of John Gierula to be identified as Author of this work has been asserted by him in accordance with the Copyright, Designs and Patents Act 1988.

Dedication

This thesis is dedicated to my wife and children; Emma, Samuel and Lily Gierula, for their unfaltering love, support and welcome distraction whilst writing this thesis and throughout my career. Also to my parents Margaret and Zygmunt Gierula, for their unfailing love and guidance, and without whom my career would not have been possible.

A special mention must also go to my great friend, and supervisor, Dr Klaus Witte. Without his unrelenting enthusiasm, support and guidance I would not be in the fortunate position I am in today.

Acknowledgements

I would like to start by thanking my supervisors, Dr Klaus Witte and Professor Mark Kearney for recognising and having faith in my potential, providing inspiration, guidance, encouragement and support and providing me with the opportunity to undertake research at the Leeds Institute for Cardiovascular and Metabolic Medicine (LICAMM). I would also like to sincerely thank the LICAMM research team and all the staff at the Leeds Cardiovascular Clinical Research Facility and Cardiac Investigations Unit, for their assistance and support.

This research has been carried out by a multi-disciplinary team, and could not have been completed without the tireless and enthusiastic help and support of Dr Klaus Witte, Maria Paton, Judith Lowry, Rowena Byrom, Dr Haqeel Jamil and Dr Richard Cubbon. My own contributions have been to supervise, design, coordinate and carry out the research studies, as well as the subsequent analyses and discussions. The other members of the group and their contributions have been: exercise test supervision, echocardiography, randomisation, data collection, blinding, assistance with statistical analysis and advice on writing papers.

The time, and funding, to complete this series of investigations has been made available through a number of sources. A special mention must go to the staff of the Cardiac Investigations Unit, the Cardiology CSU, and in particular Gina McGawley, at Leeds Teaching Hospitals NHS Trust. The

generous allocation of time, equipment and facilities made this research possible. From 2012 my salary was funded by the REM-HF study, a British Heart Foundation (BHF), multi-centre, UK wide, randomised-control trial of weekly remote monitoring v usual care, in 1800 patients with heart failure and an implantable cardiac pacemaker or defibrillator. In 2015 I was awarded a National Institute of Health Research (NIHR) Healthcare Scientist Doctoral Fellowship £300,685 which enabled me to focus on the final data analysis, writing of this thesis and to perform further work investigating how optimising the rate response function, based on left ventricular contractility, in patients with heart failure and pacemakers affects exercise capacity.

Finally, I would like to thank all the patients who volunteered for these studies - helping to advance our understanding of the adverse effects of pacemaker therapy on heart function, and how we may optimise pacemaker therapy to halt or indeed reverse decline.

Abstract

Patients with right ventricular (RV) pacemakers are at increased risk of left ventricular (LV) systolic dysfunction (LVSD) and chronic heart failure (CHF). I aimed 1) to establish the prevalence of LVSD in patients with long-term RV pacemakers listed for pulse generator replacement (PGR), 2) to evaluate the effects on LV function of reprogramming existing pacemakers to reduce RV pacing (RVP) and 3) to investigate whether upgrade to cardiac resynchronization therapy (CRT) at the time of PGR is beneficial in patients with unavoidable RV pacing and LVSD.

Data were collected on 491 patients listed for PGR. Reduced left ventricular ejection fraction (LVEF) <50% was observed in 40%. Multivariable analysis revealed %RVP, serum creatinine and previous myocardial infarction (MI) to be independently related to the presence of LVSD.

An audit was performed to investigate the effects of optimising pacemaker programming to avoid RV pacing in 66 patients. At 6m, RV pacing was reduced by a mean of 49%, with a mean improvement in LVEF of 6% and no reduction in exercise capacity, NT-pro-BNP or quality of life.

Fifty patients with unavoidable RV pacing, LVSD, and mild symptoms of CHF, listed for PGR were randomized 1:1 to either standard RV-PGR or CRT. At 6 months there was a difference in change in median LVEF, improvements in exercise capacity, quality of life, and NT-proBNP in those

randomized to CRT. After 809 days, 17 patients had died or been hospitalized (6 CRT and 11 PGR) and two patients in the PGR arm required CRT for deteriorating CHF.

In summary, LVSD is common in patients with standard RV pacemakers and relates to cardiovascular co-morbidities, careful reprogramming to avoid unnecessary RV pacing can improve LVEF without adversely affecting exercise capacity and quality of life and upgrading patients with unavoidable RV pacing to CRT at PGR improves LV function, and exercise tolerance and may reduce admissions and further upgrades.

Table of Contents

Dedication	iii
Acknowledgements	iv
Abstract	vi
Table of Contents	viii
List of Tables	xii
List of Figures	xiii
Preface	xv
Bibliography	xvii
Chapter 1. Introduction to Pacemaker therapy	1
1.1 Introduction.....	1
1.2 History of heart rhythm, pacemaker therapy and electrophysiology.....	3
1.3 Epidemiology of pacemakers in the UK.....	36
1.4 Effects of RV pacing on cardiac function.....	36
1.5 Alternate right ventricular pacing sites.....	51
1.5.1 RV outflow tract pacing.....	51
1.5.2 RV septal pacing.....	52
1.5.3 His Bundle pacing.....	53
1.6 Cardiac Resynchronisation Therapy (CRT).....	54
Chapter 2. Introduction to Chronic Heart Failure (CHF) and its treatment	55
2.2 Terminology of CHF.....	55
2.3 Epidemiology of CHF.....	56
2.4 Diagnosis of CHF.....	58
2.5 Pathophysiology and aetiology of CHF.....	60
2.5.1 The Haemodynamic Model.....	63
2.5.2 Cardio-renal model.....	64
2.5.3 Neuro-hormonal model.....	64
2.5.4 Abnormal Ca ²⁺ cycling model.....	65
2.5.4 Cell death model.....	66
2.5.5 Genetic model.....	66
2.6 Management of CHF.....	66
2.6.1 General Management of CHF.....	67

2.6.1.1 Diet.....	67
2.6.1.2 Exercise	67
2.6.1.3 Travel	69
2.6.1.4 Smoking	69
2.6.1.5 Alcohol consumption	69
2.6.2 Modification of risk factors to prevent CHF.....	70
2.7 Pharmacological therapy of CHF	71
2.7.1 Angiotensin-converting enzyme inhibitors (ACEI)	71
2.7.2 Adrenergic receptor antagonists (beta-blockers).....	72
2.7.3 Mineralocorticoid/aldosterone receptor antagonists (MRAs).....	73
2.7.4 Loop and thiazide diuretics.....	74
2.7.5 Angiotensin receptor neprilysin inhibitor (ARNI)	74
2.7.6 I_f -channel inhibitor	75
2.7.7 Angiotensin II type I receptor blockers (ARBs).....	76
2.7.8 Digoxin	76
2.7.9 Anti-arrhythmic agents	78
2.8 Devices	78
2.8.1 Implantable cardioverter-defibrillator (ICD).....	78
2.8.2 Primary prevention ICD	79
2.8.2.1 Where ICDs are proven to be of benefit.....	79
2.8.2.2 Where ICDs are not proven to be of benefit.....	80
2.8.2.3 Practical issues around ICD therapy	81
2.8.2.4 What happens when the battery is flat?	82
2.8.2.5 New developments in ICD therapy	82
2.8.3 Secondary prevention ICD	83
2.8.4 Cardiac resynchronisation therapy (CRT)	83
2.8.4.1 Prevalence and effect of conduction delay	83
2.8.4.2 How does CRT help?	85
2.8.4.3 Personalisation of CRT programming for most effect	87
2.8.4.4 How does CRT work?	87
2.8.4.5 Does CRT work in everyone?	89
2.8.4.6 Who do the guidelines say is eligible for CRT?	91
2.8.4.7 Assessment of eligibility – does echocardiography help?	92

2.8.5 Upgrade of existing pacemakers to CRT.....	93
Chapter 3. Methodology	95
3.1 Transthoracic Echocardiography (TTE).....	95
3.1.2 Measurement of LV dimensions and volumes.....	95
3.1.3 Assessment of LV systolic function	98
3.1.4 Reliability of TTE	99
3.2 Echocardiography protocol.....	100
3.3 Formal exercise testing	101
3.4 Assessing exercise capacity	101
3.4.1 Cardio-pulmonary exercise (CPX) testing	102
3.4.2 Introduction to CPX testing.....	102
3.4.3 CPX test overview	103
3.4.4 Peak Oxygen Consumption (pVO ₂) and exercise intolerance.....	104
3.4.5 Measuring pVO ₂	106
3.4.6 Respiratory exchange ratio (RER)	106
3.4.7 VE/VCO ₂ slope.....	107
3.4.8 End tidal carbon dioxide (PETCO ₂).....	107
3.4.9 Sub-maximal exercise	108
3.4.10 Exercise protocols	109
3.4.11 Stationary cycle	110
3.4.12 Treadmill	110
3.4.13 CPX protocol	111
3.5 Assessing quality of life in CHF	112
Chapter 4. What is the prevalence of left ventricular dysfunction in pacemaker patients requiring a battery replacement?	114
4.1 Introduction	114
4.2 Methods	114
4.3 Results	116
4.3.1 Device prescription and programming.....	119
4.3.2 Echocardiographic and Cardiopulmonary exercise test results	122
4.4 Outcome data.....	127
4.5 Discussion.....	129
4.5.1 Aetiology of RV pacing associated LV dysfunction	130
4.5.2 Medical management of RV pacing associated LV dysfunction.....	131

4.5.3 Device based management of RV pacing associated LV dysfunction.....	132
4.5.4 Preventing RV pacing associated LV dysfunction	133
4.6 Limitations	134
4.7 Conclusions.....	135
Chapter 5. What are the effects of a strategy to reduce right ventricular pacing on left ventricular function?	136
5.1 Introduction	136
5.2 Methods	137
5.3 Results	141
5.4 Discussion.....	147
5.5 Limitations	150
5.6 Conclusions.....	151
Chapter 6. Cardiac resynchronization therapy in pacemaker-dependent patients with left ventricular dysfunction.	152
6.1 Introduction	152
6.2 Methods	153
6.2 Results	157
6.3 Discussion.....	161
6.4 Limitations	165
6.5 Conclusions.....	166
Chapter 7. Discussion.....	167
List of Abbreviations.....	170
Appendix A – What is the prevalence of left ventricular dysfunction in pacemaker patients requiring a battery replacement? - Ethical approval	173
Appendix B – What is the prevalence of left ventricular dysfunction in pacemaker patients requiring a battery replacement? - LTHT R&D approval	176
Appendix C – Cardiac resynchronization therapy in pacemaker-dependent patients with left ventricular dysfunction - ethical approval	180
Appendix D – Cardiac resynchronization therapy in pacemaker-dependent patients with left ventricular dysfunction - LTHT R&D approval	184
References.....	188

List of Tables

Table 2.1 Current ESC guidelines for CRT implantation.....	91
Table 4.1: Pacemaker survey patient demographic data.....	118
Table 4.2 Pacemaker, echocardiographic and cardiopulmonary exercise test variables in 491 pacemaker pulse generator replacement patients	120
Table 4.3 Multivariable model of predictors of the presence of impaired left ventricular function.....	124
Table 5.1: Baseline variables in 66 patients with RV pacemakers.....	142
Table 5.2: Changes in clinical variables following reprogramming to avoid RV pacing.....	144
Table 6.1: Baseline variables	159
Table 6.2: Implant data.....	160
Table 6.3: Changes in outcomes variables between groups from baseline to six months.....	160

List of Figures

Figure 1.1 Pacemaker diagram	1
Figure 1.2: Circulation by William Harvey	4
Figure 1.3: Von Ziemssen’s recordings of ventricular activity	7
Figure 1.4: First human ECG recording by Waller.....	9
Figure 1.5: Albert Hymans Artificial Pacemaker 1932.....	11
Figure 1.6: Hyman’s pacemaker in a box	12
Figure 1.7: Hyman’s electrodes	12
Figure 1.8: Flow diagram of Hyman’s artificial pacemaker	13
Figure 1.9: Hyman’s recordings.....	13
Figure 1.10: The Hymanotor (Adlanco)	14
Figure 1.11: The Grass stimulator	15
Figure 1.12: Early external electronic pacemakers	16
Figure 1.13: Paul Zoll’s external pacemaker.....	17
Figure 1.14: Paul Zoll’s external pacemaker.....	18
Figure 1.15: Early Zoll paced ECG tracings	19
Figure 1.16: Lillehei’s “myocardial wire”	21
Figure 1.17: Bakken’s circuit.....	24
Figure 1.18 Bakken’s pacemaker with leads.....	24
Figure 1.19: Medtronic pacemaker	25
Figure 1.20: Wearable pacemaker.....	26
Figure 1.21: Medtronic pacemaker product literature.....	26
Figure 1.22: Lillehei’s paper	27
Figure 1.23: Senning and Elmqvist’s implantable pacemaker	28
Figure 1.24: Senning’s abstract	29
Figure 1.25: Hunter-Roth electrodes	30
Figure 1.26 Elema pacing lead	31
Figure 1.27: Pacemakers of the 70’s.....	33
Figure 1.28: Pacemakers of the 80’s.....	33
Figure 1.29: Pacemakers of the 90’s.....	34
Figure 1.30: Medtronic CRT pacemaker	35
Figure 1.31: Schematic diagram of Biotronik remote follow-up	35
Figure 1.32: New pacemaker implant rate 2003-2013, adapted from CRM National Clinical Audit Report (Group, 2014).....	36

Figure 2.1 Pathophysiology of heart failure.....	62
Figure 2.2 Regional and global pathophysiology of cardiac dyssynchrony, used with permission from Wolters Kluwer Health Inc.....	88
Figure 3.1 LV cavity dimension measurement using M-mode	96
Figure 3.2 LV cavity dimension measurement using digital callipers.....	97
Figure 3.3 Simpson’s Bi-plane method of measuring LVEF.....	99
Figure 3.4: Modified Bruce protocol	111
Figure 4.1 Percentage ventricular pacing at PGR in those with and without CHB at baseline.	121
Figure 4.2 The incidence of LV systolic dysfunction, based on pacing percentage	122
Figure 4.3 Frequency of left ventricular systolic dysfunction in patients with or without cardiovascular co-morbidity (hypertension, type 2 diabetes mellitus, and apparent coronary artery disease), split by percentage of ventricular pacing.....	123
Figure 4.4: Receiver-operating characteristic (ROC) curve for left ventricular dysfunction (LVEF <50%) with ≥80% right ventricular pacing and previous myocardial infarction.....	125
Figure 4.5 The relationship between right ventricular pacing and peak oxygen consumption at baseline.....	126
Figure 4.6 The relationship between right ventricular pacing and LVEF at baseline	126
Figure 4.6: Kaplan Meier curve for survival out of hospital in patients with pacemakers divided by left ventricular ejection fraction and percentage of ventricular pacing prior to generator replacement.....	128
Figure 5.1: Leeds RV pacing avoidance algorithm.....	138
Figure 5.2: The relationship between change in right ventricular pacing percentage (V-pace) and change in left ventricular ejection fraction (LVEF) function at six months.....	146
Figure 6.1: Study protocol.....	154
Figure 6.2: Median change in left ventricular ejection fraction (LVEF) in cardiac resynchronisation therapy (CRT) group and standard right ventricular pulse generator group (RV-PGR) from baseline to follow-up at six months.....	160
Figure 6.3: The effect of CRT or RV-PGR on left ventricular ejection fraction (LVEF) at six months.....	161

Preface

The relationship between right ventricular (RV) pacing and left ventricular systolic dysfunction (LVSD) and chronic heart failure (CHF) is established. The purpose of this series of investigations is to establish the prevalence of LVSD in a cohort of patients with existing RV pacemakers requiring a pulse generator replacement (PGR), and to determine the effects of optimising pacemaker therapy at PGR.

The results of this work have underpinned two successful NIHR fellowship applications:

The first is my primary supervisor, Dr Klaus Witte's, NIHR Clinician Scientist award – OPT-pace. Klaus was awarded £588,878, OPT pace is a 5 year study further investigating the relationships between right ventricular pacing, cardiovascular co-morbidities and chronic heart failure. The study includes a randomised control trial of my right ventricular pacing avoidance algorithm and specialist heart failure therapy vs. standard pacemaker follow-up and also includes follow-up of patients with newly implanted pacemakers for bradycardia with the primary outcome of predicting who will develop left ventricular systolic dysfunction.

The second successful application is my fellow Cardiac Physiologist Maria Paton's NIHR ICA Doctoral Fellowship. Maria was awarded £300,393 to investigate if left ventricular systolic dysfunction related to right ventricular

pacing is progressive, or static. The study also includes an RCT of an enhanced version of my right ventricular pacing reduction algorithm, to further evaluate the effects of reducing not only the effects of reducing unnecessary right ventricular pacing on left ventricular function and heart failure symptoms, but also the effects on battery longevity and avoiding future battery replacements.

Bibliography

The following is a list of papers and abstracts I have authored or co-authored:

Publications

Jamil HA, Gierula J, Paton MF, Byrom R, Lowry JE, Cubbon RM, Cairns DA, Kearney MT, Witte KK. Chronotropic Incompetence Does Not Limit Exercise Capacity in Chronic Heart Failure *J Am Coll Cardiol*. 2016 Apr 26

Witte KK, Byrom R, Gierula J, Paton MF, Jamil HA, Lowry JE, Gillott RG, Barnes SA, Chumun H, Kearney LC, Greenwood JP, Plein S, Law GR, Pavitt S, Barth JH, Cubbon RM, Kearney MT. Effects of Vitamin D on Cardiac Function in Patients With Chronic HF: The VINDICATE Study. *J Am Coll Cardiol*. 2016 Jun 7

Cubbon RM, Witte KK, Kearney LC, Gierula J, Byrom R, Paton M, Sengupta A, Patel PA, Walker A, Cairns DA, Rajwani A, Hall AS, Sapsford RJ, Kearney MT. Performance of 2014 NICE defibrillator implantation guidelines in heart failure risk stratification *Heart*. 2016 Feb 8

Cubbon RM, Ruff N, Groves D, Eleuteri A, Denby C, Kearney L, Ali N, Walker AM, Jamil H, Gierula J, Gale CP, Batin PD, Nolan J, Shah AM, Fox KA, Sapsford RJ, Witte KK, Kearney MT. Ambulatory heart rate range predicts mode-specific mortality and hospitalisation in chronic heart failure. *Heart*. 2016 Feb 1

Cubbon RM, Thomas CH, Drozd M, Gierula J, Jamil HA, Byrom R, Barth JH, Kearney MT, Witte KK. Calcium phosphate and calcium phosphate product are markers of outcome in patients with chronic heart failure. *J Nephrology* 2014; in press- original article

Gierula J, Witte KK. Response to (resynchronization) therapy in chronic heart failure, time for a different approach? *Eur J Heart Fail* 2014

Gierula J, Jamil HA, Witte KK. Septal pacing: still no clarity? *PACE* 2014 - letter

Gierula J, Cubbon RM, Jamil HA, Byrom R, Waldron Z, Pavitt S, Kearney MT, Witte KK. Patients with long term permanent pacemakers have a high prevalence of left ventricular dysfunction. *Journal Cardiovascular Medicine* 2014, in press

Gierula J, Jamil HA, Byrom, R, Joy E, Cubbon RM, Kearney MT, Witte KK.

Pacing-associated left ventricular dysfunction? Think programming first!

Heart 2014 - original article

Gierula J, Cubbon RM, Jamil HA, Byrom RJ, Waldron ZL, Pavitt S, Kearney

MT, Witte KK. Patients with long-term permanent pacemakers have a high

prevalence of left ventricular dysfunction. *J Cardiovascular Med*

(Hagerstown) 2014 in press

Gierula J, Cubbon RM, Jamil HA, Byrom, R, Baxter P, Pavitt, S, Gilthorpe

MS, Hewison, J, Kearney MT, Witte KK. Cardiac resynchronisation therapy

in pacemaker dependent patients with left ventricular dysfunction. *Europace*

2013 - original article

Abstracts

Allen LA, Paton MP, Jamil HA, Gierula J, Garnham J, Kearney MT, and Witte

KK. Factors affecting exercise capacity in diabetic heart failure patients.

Circulation 2015

Lowry J, Gierula J, Byrom R, Barnes S, Jamil HA, Kearney LC, Cubbon RM,

Kearney MT, Witte KK. Vitamin d supplementation improves the size and

function of the left ventricle in patients with heart failure. *Eur Heart J* 2015.

Jamil H, Gierula J, Byrom R, Winsor S, Sunley E, Kearney L, Houghton A, Bailey K, Cubbon R, Reynolds G, Pavitt S, David C, Julian B, Davis M, Sharples L, Kearney M, Witte K. Using natriuretic peptide levels to diagnose heart failure in primary care: An evaluation of the 2010 United Kingdom National Institute of Clinical Excellence Guidelines on the diagnosis of chronic heart failure. *BMJ* 2015.

Abdel-Rahman D, Paton MP, Gierula J, Bramley P, Jamil HA, and Witte KK .Pragmatic versus electrocardiographic-guided loop recorder position, an outcomes study. *Heart Rhythm UK* 2015

Corrigan J, Paton MP, and Gierula J. The role of a cardiac physiologist in cardiac research. *CRN Conference London* 2015

Chapter 1. Introduction to Pacemaker therapy

1.1 Introduction

A modern-day pacemaker is an implantable electronic device capable of delivering a regular pulse to the heart. Early pacemakers were designed to be electronic metronomes and modern iterations have added complex hardware and software around that basic function to allow for programmability. Today's pacemaker systems are fully implantable and consist of 1) a pulse generator that includes circuitry and a battery with around 8 years longevity and 2) the leads that deliver current to and sense intrinsic electrical activity in myocardium. (Fig 1)

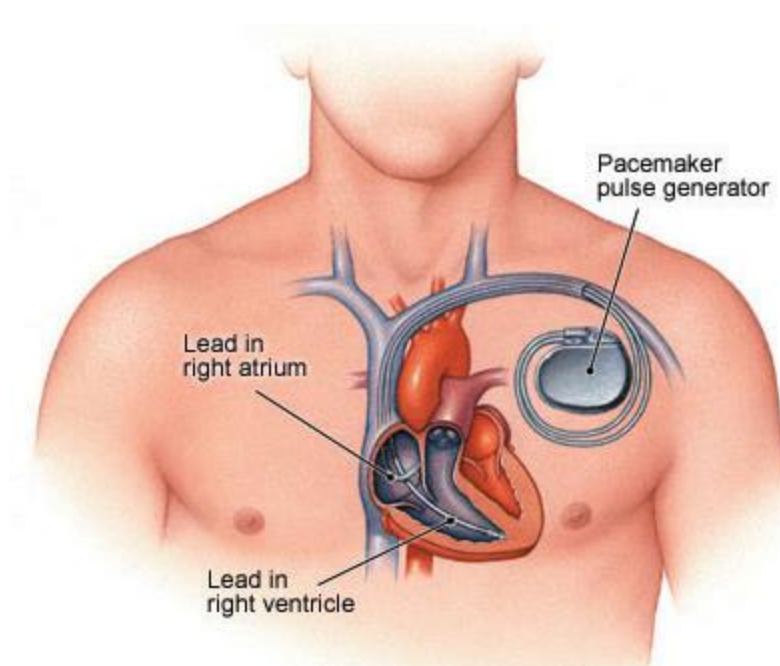

Figure 1.1 Pacemaker diagram

A permanent implantable cardiac pacemaker is part of the recommended treatment for bradycardia by the National Institute for Health and Care

Excellence (NICE),(NICE, 2005) the European Society of Cardiology (ESC) (Brignole et al., 2013) and the American College of Cardiology (ACC) and American Heart Association (AHA).(Epstein et al., 2008) Pacemakers are associated with improved quality of life, improved longevity and symptomatic relief in patients with atrioventricular (AV) block, and sick sinus syndrome (SSS).(Shaw et al., 1985, Lamas et al., 1998, Ohm and Breivik, 1978, Mlynarski et al., 2009) In addition, the only effective treatment for symptomatic sinus bradycardia and chronotropic incompetence is cardiac pacing.(Epstein et al., 2008) Although supported by little data of improved efficacy,(Toff et al., 1997) it is generally thought that based upon quality of life years gained, dual chamber pacemakers might be more cost effective than single chamber in individuals in sinus rhythm (SR) with AV block.(Castelnuovo et al., 2005)

Historically, the therapeutic use of cardiac pacing is seen as falling within the medical field of electro-diagnosis and electrotherapy,(Aquilina, 2006) more recently termed Electrophysiology. Over time, through observational, animal and human interventional studies, the pacemaker has developed from an externally powered device (dependent upon DC current), to a fully implantable device with battery longevity of more than 8 years.

This section will first describe the history of cardiac pacemaker therapy, following this will be a review of the existing literature around the potential adverse effects of right ventricular pacing. I performed an extensive, systematic search of available literature resources, using MeSH search

terms- accessing Pubmed, MEDLINE, EMBASE, the Cochrane Central Register of Controlled Trials (CENTRAL, 2017), Conference Proceedings Citation Index - Science (CPCI-S), ClinicalTrials.gov, and the World Health Organization (WHO) International Clinical Trials Registry Platform (ICTRP). I did not apply any language restrictions, and searches included animal studies. (Relevo, 2012)

1.2 History of heart rhythm, pacemaker therapy and electrophysiology

Hippocrates (460-375 BC) provided an early insight into the detrimental effects of syncope, potentially related to bradycardia “*Those who suffer from frequent and strong faints, without any manifest cause, die suddenly*”,(Aquilina, 2006, Katz and Katz, 1962) and Aristotle (384-322 BC) described the heart as “*the source of all movement, since the heart links the soul with the organs of life*”.(Dunn, 2006) Wang Shu-he (280BC) wrote 10 books about the pulse in ancient China,(Wang et al., 2012) and Sphygmology, which deals with the theory of the pulse, arises from “Sphygmos” – the Greek term for the pulse(Aquilina, 2006), and in Roman times, Galen theorised that different pulse types related to disease.(Pasipoularides, 2014)

The field of what is now referred to as Electrophysiology continued to develop, and in 1580 Geronimo Mercuriale formed the concept of syncope, and how syncope was related with a low pulse rate - “*Ubi pulsus sit rarus semper expectanda est syncope*”, which roughly translates as “when the

pulse is rare, expect syncope”.(Aquilina, 2006) In 1600 William Harvey used a flick of his finger to restart a pigeon's heart following cardiac arrest, and he described and illustrated the circulatory system in 1628 (Fig 1.2.).(Ribatti, 2009)

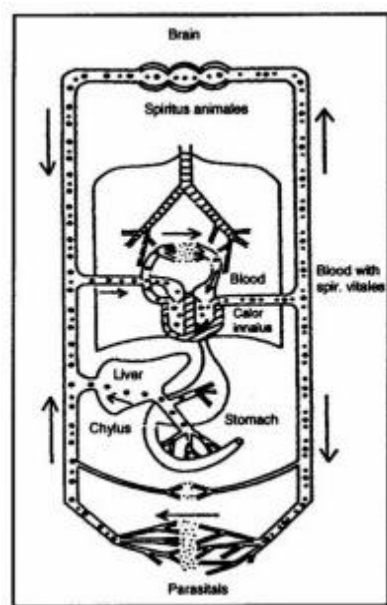

Figure 1.2: Circulation by William Harvey

In the 1640's speculations on the bio-electrical properties of the cardiovascular system were published, and in 1717 Slovenian physician Marcus Gerbazius (1658 - 1718) first described symptoms of bradycardia related to complete atrio-ventricular (AV) block.(Aquilina, 2006) Following this, in 1761 Italian born anatomist and proclaimed “*father of modern anatomical pathology*” Giovanni Battista Morgagni (1682 - 1771), implied a causal relationship between bradycardia and syncope, with his clinical explanation of circulatory arrest.(Aquilina, 2006)

In 1774 the Registers of the Royal Human Society of London made the first reference to external stimulation of the heart in a young female patient,(Aquilina, 2006) and the first studies on the effects of electrical energy when applied to the body were conducted by Danish physicist Nickolev Abildgaard in 1775. Electrodes were placed on the sides of a hen's head, and an electric charge was applied which resulted in the birds death. Electrodes were applied over various parts of the hen's body, which failed to resuscitate the bird. However, the bird staggered to its feet and walked away following application of the electrodes to its chest, it was presumed that this defibrillated the heart, resulting in the bird's successful resuscitation.(Chaikhouni, 2010) Scottish pioneer of experimental surgery John Hunter (1728 - 1793), recommended in 1776 that victims of drowning should be resuscitated through the application of electrical stimulation.(Chaikhouni, 2010) This was attempted by Charles Kite in London. In 1788 he reported on the resuscitation of a three year old girl through the use of an electrostatic generator and declared that: "*...electricity is the most powerful stimulus we can apply...if it is able so powerfully to excite the action of the external muscles, it will be capable of reproducing the motion of the heart which is infinitely more irritable, and by that means accomplish our great desideratum, the renewal of the circulation.*".(Eisenberg, 1994)

In 1791 Italian physician and natural scientist Luigi Galvani (1737 – 1798) made a substantial contribution to modern cardiac electrophysiology when he published the findings of his experiments on frog hearts and muscles. He

announced that electrical activity existed within organic tissue. There followed a consensus that electrical activity had an effect on the heart.(Aquilina, 2006, Chaikhouni, 2010) To further strengthen the accumulating evidence within electrophysiology, reports exist of Prussian geographer, naturalist and explorer Alexander von Humboldt resuscitating a dead bird found in his garden via a blade of zinc in its beak and a shaft of silver in the rectum, through which he applied an electric shock. His actions resulted in the bird to flapping its wings and attempting to walk.(Finger et al., 2013)

During 1800-1802 French anatomist and physiologist Marie Francois Xavier Bichat (1701-1802) and fellow countryman, physiologist and paediatrician Pierre-Hubert Nysten (1771-1818) experimented on decapitated humans. They reported that by using electric current they were able to make hearts beat again.(Aquilina, 2006) Following this, in 1804 the Italian born physicist Giovanni Aldini (1762 – 1834) described his animal and cadaver experiments, during which he is said to have “*alleviated cardiac syncope*”, through electrical currents.(Parent, 2004)

In 1827 Irish surgeon Robert Adams (1791 - 1875) first described that cardiac rhythm dysfunction and cerebral symptoms may be related, when describing a patient with frequent syncope and a slow heart rate. And in 1846, another Irishman William Stokes (1804 – 1878) provided further evidence of the relationship between syncope and bradycardia and provided a further detailed analysis of the case Adam’s presented.(Berry, 2006)

Swiss anatomist, physiologist and histologist Rudolph Albert von Kolliker (1817 – 1905) published his work on the heart's "action currents" in 1855, demonstrating that each beat of a frog's heart produced an electric current.(Fye, 1999) In 1872 the French neurologist Duchenne de Boulogne (1806 - 1875) performed a successful resuscitation of a child that had drowned by attaching an electrode to the leg and tapping the precordium with another electrode.(Parent, 2005)

In 1882, a 46yr old female patient attended the clinic of German physician Hugo Von Ziemssen (1829 – 1902). She had recently had a chest tumour removed and had been left with her heart exposed, covered only by a thin layer of skin. Using an electric current, Von Ziemssen changed the heart rate by directly stimulation of the heart, and noted that stimulation only occurred if the rate of stimulation was greater that the underlying heart rate and that slower stimulation produced a slower and erratic heart rate. Figure 1.3 shows recordings that clearly demonstrate ventricular activity produced by the electrical impulses.(Aquilina, 2006)



Figure 1.3: Von Ziemssen's recordings of ventricular activity

In 1889, Scottish pioneer of Electrophysiology John MacWilliam (1857 – 1937) collated all of the available data to date and produced the basic concepts of pacing. He depicted the practice of applying electricity over the chest to “*excite rhythmic contraction... to stimulate by direct means the action of the heart which has been suddenly enfeebled or arrested in diastole by causes of a temporary or transient character*”,(Silverman and Fye, 2006, Aquilina, 2006) and thereby provided medicine with its first unified theory of cardiac pacing

Further evidence of cardiac rhythm disturbances were provided by Dutch anatomist Karel Frederik Wenckebach (1864 – 1940) in 1899 with his description of type I second degree atrio-ventricular block in humans, this was achieved using sphygmographic methods of measuring the radial pulse as the electrocardiogram was still in development.(Fye, 1990) In 1906 English cardiologist John Hay (1873 – 1959), using simultaneous recordings from the radial artery and jugular vein as the electrocardiograph still wasn't widely available, produced a case report of type II second degree atrio-ventricular block.(Barold and Luderitz, 2001)

From the late 1800's to the early 1900's the invention of the electrocardiograph was a major technological advancement that would allow cardiology to further the understanding of arrhythmias, and therefore the development of arrhythmia therapy, including cardiac pacing. London based Physiologist, Augustus Desire' Waller (1856- 1922) recorded the first human

surface electrocardiogram in 1887 using the Lippmann capillary electrometer, Figure 1.4. Waller described that “each beat of the heart gives an electric change, beginning at one end of the organ and ending at the other”.(Aquilina, 2006, Besterman and Creese, 1979)

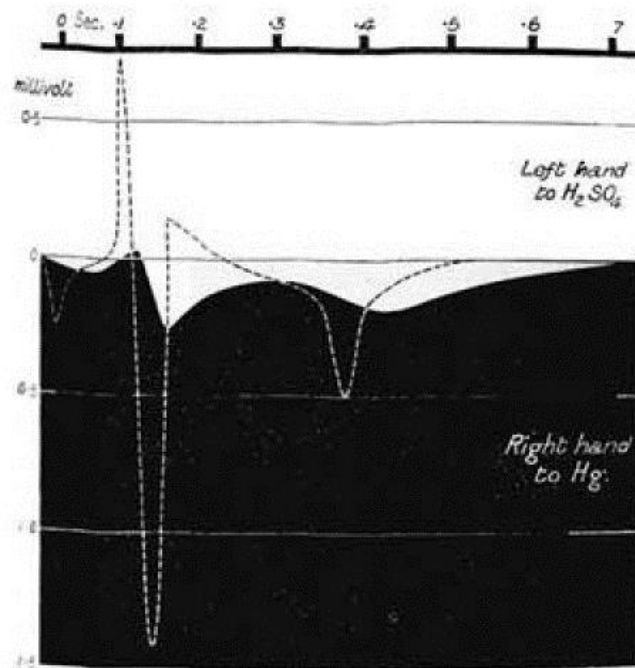

Figure 1.4: First human ECG recording by Waller

Dutch physiologist, Willem Einthoven (1860 – 1927) further added to development of the electrocardiograph, with his recordings in 1892. He observed that the ECG had four deflections, and initially named them with the characters A, B, C, D, however later changed this to use P, Q, R, S and T. His work was met with scepticism within the scientific community, however Einthoven continued his work and described the Einthoven triangle in 1913 and used this as the basis for electrocardiographic calculations. The same year also saw the introduction of the bipolar electrode system, and

Einthoven was awarded the Nobel Prize for Physiology and Medicine in 1924 for his work in electrocardiography.(Aquilina, 2006, Barold, 2003)

In 1933, American cardiologist Frank Norman Wilson (1890 – 1952) expanded electrocardiography beyond using only the extremities - by introducing the unipolar chest wall electrodes, and following this in 1942 his fellow American cardiologist Emanuel Goldberger introduced the “*unipolar amplified (augmented) extremity leads*” This completed the 12-lead electrocardiogram as used today,(Aquilina, 2006, Johnston, 1952, AlGhatrif and Lindsay, 2012) and played an important role in the further advancement of pacemaker technology.

Development of the first external cardiac pacemakers is credited to two individuals - Australian anaesthetist Mark Lidwill (1878 – 1969) and the American physiologist Albert S Hyman (1893 – 1972). Lidwill's device required the insertion of a needle into the patient's ventricle, and ran on alternating current. In 1928 he saved the life of a new-born child in cardiac arrest using electrical stimulation of the heart. He reported this to the Australian Medical Society in 1929.(Aquilina, 2006, Mond et al., 2012, Furman, 2002)

Hyman was the first to develop an external pacemaker device. Hyman was interested in “*reviving the stopped heart by means of intra-cardial therapy*”. This therapy initially consisted of the injection of medication including epinephrine directly into the heart. Lidwell realised that it was the needle that

stimulated the heart to beat, through setting up an action current of injury as it punctured the heart, and not the drug itself.(Irnich et al., 1978, Aquilina, 2006)

Hyman's device (Figure 1.5) was described by himself as an “*artificial pacemaker*” in 1932. He is therefore credited with coining the term “pacemaker”, which is now universally accepted. Hyman’s pacemaker was powered by a spring-wound hand-cranked motor, since mechanical power was more reliability than commercially available batteries.(Irnich et al., 1978, Aquilina, 2006)

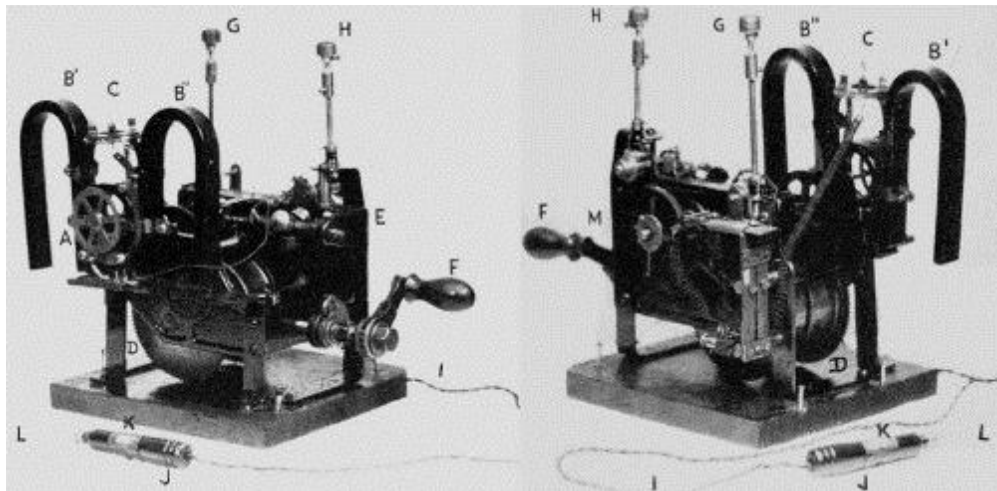

Figure 1.5: Albert Hyman's Artificial Pacemaker 1932

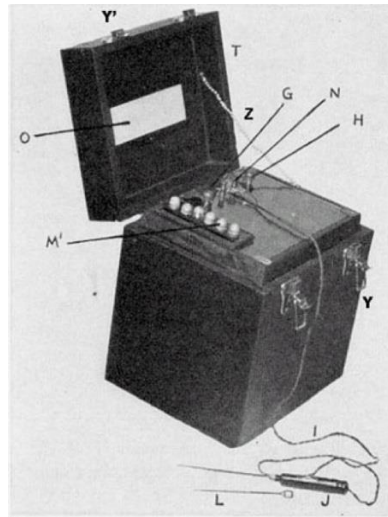

Figure 1.6: Hyman's pacemaker in a box

The mechanism drove a DC current generator, and, through a bipolar electrical needle (Fig 1.7) inserted into the right atrium through the chest wall, electrical impulses were delivered. Pacing could be delivered at 30, 60 or 120 pulses per minute as required. None of the three devices built survives and only two photographs are available. (Aquilina, 2006, Irrich et al., 1978)

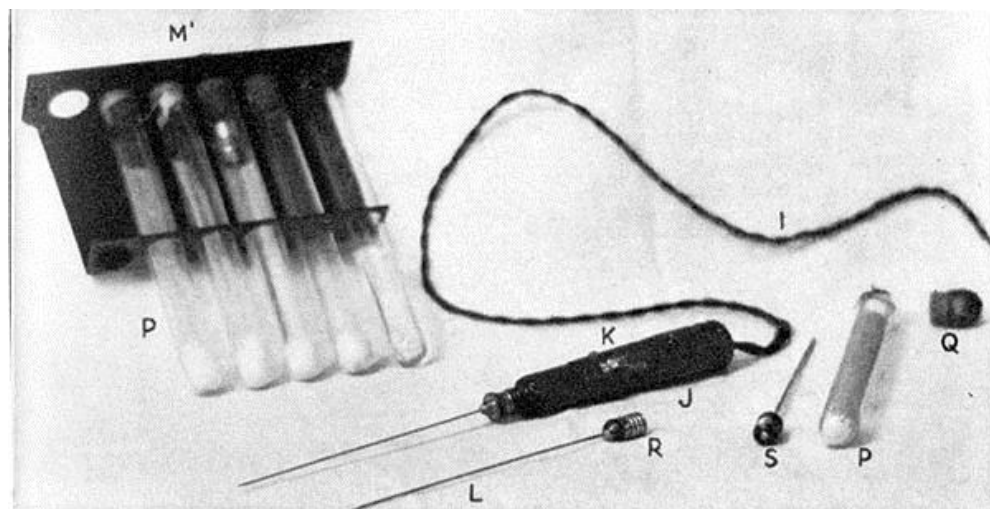
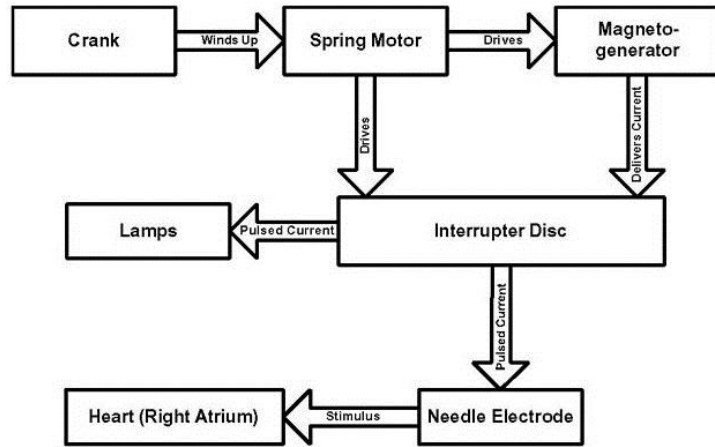

Figure 1.7: Hyman's electrodes



Flow Diagram of Hyman Pacemaker

Diagram detailing how the spring-wound Hyman pacemaker produced stimuli.

Figure 1.8: Flow diagram of Hyman’s artificial pacemaker

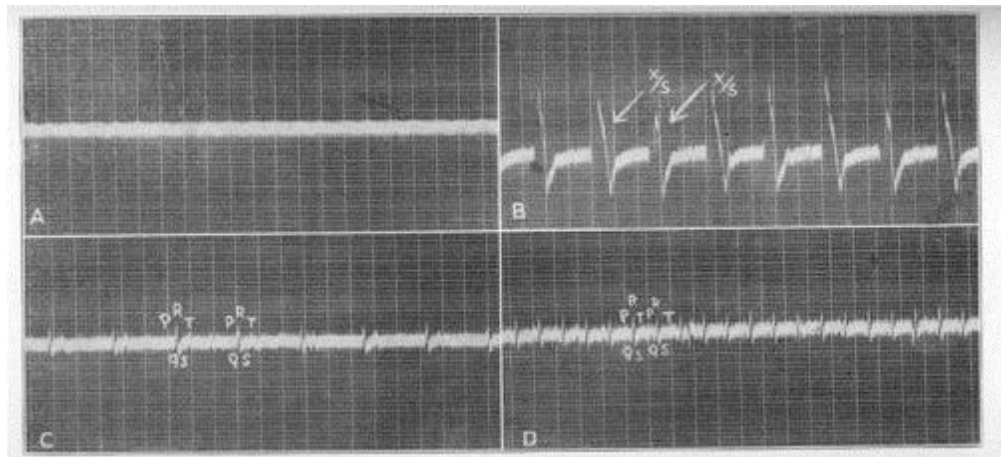

Figure 1.9: Hyman’s recordings

Hyman’s device was met with opposition and suspicion from the medical community, who did not accept his use of electro-stimulation. Combined with technical issues, his progress was halted and he never published his work. Hyman found it difficult to find a local manufacturer, but eventually German company Siemens-Halske and their American partners Adlanco did agree to

manufacture a battery operated version. It was named the Hymanotor, (Fig 1.10), but was unreliable during testing.(Irnich et al., 1978, Aquilina, 2006)



Figure 1.10: The Hymanotor (Adlanco)

In 1949 in Toronto, Canadian cardiothoracic surgeons Wilfred Bigelow (1913 – 2005) and John Callaghan (1923 – 2004) began experimenting with hypothermia to induce bradycardia, reduce metabolism and allow cardiac surgery. Re-warming did not increase the heart rate as quickly as they required, so they began to experiment with sino-atrial node stimulation.(Aquilina, 2006, Kermod-Scott, Furman, 2002) Whilst experimenting on a dog, the heart stopped, and Bigelow recounted: “*Out of interest and in desperation, I gave the left ventricle a good poke with a probe I was holding. All four chambers of the heart responded. Further pokes clearly indicated that the heart was beating normally with good blood pressure.*” These hypothermia experiments further advanced the development of pacemaker therapy.(Aquilina, 2006, Furman, 2002)

During the 1940's and early 50's a physiological stimulator, manufactured by Grass Manufacturing Co (Fig 1.11), was the principle device used to generate electrical impulses. This device had the potential to stimulate the heart in clinical and laboratory situations. Stimulation rate, voltage output and pulse width could be adjusted.(Aquilina, 2006)



Figure 1.11: The Grass stimulator

In 1949, Canadian electrical engineer John Hopps (1919-1998), employed by the National Research Council of Canada, built the first electronic device purposefully designed as a cardiac pacemaker. This external device, (Fig 1.12) driven by vacuum tubes, paced the atria via a trans-venous approach using a bipolar electrode catheter. This allowed atrial pacing to be delivered, without violent chest wall muscular contractions thereby controlling the heart relatively painlessly.(Aquilina, 2006, Hopps, 1981, Haddad et al., 2006)



Figure 1.12: Early external electronic pacemakers

The 1950's saw the development of mains-powered pacemakers. They were contained in large boxes and therefore had to have wheels and required mains electricity supply, limiting their portability.(Aquilina, 2006)

In 1951, American cardiologist Paul Zoll (1911 – 1999), developed an external pacemaker, which was used to successfully treat heart block. Zoll's device, "*The electrodyne PM-65 pacemaker*" (Fig 1.13), is credited as a major advancement in modern cardiac pacing technology. The device consisted of an electrocardiograph for cardiac rhythm monitoring and a pulse generator, which ran off mains electricity, to pace the heart.(Aquilina, 2006, Furman, 2002)

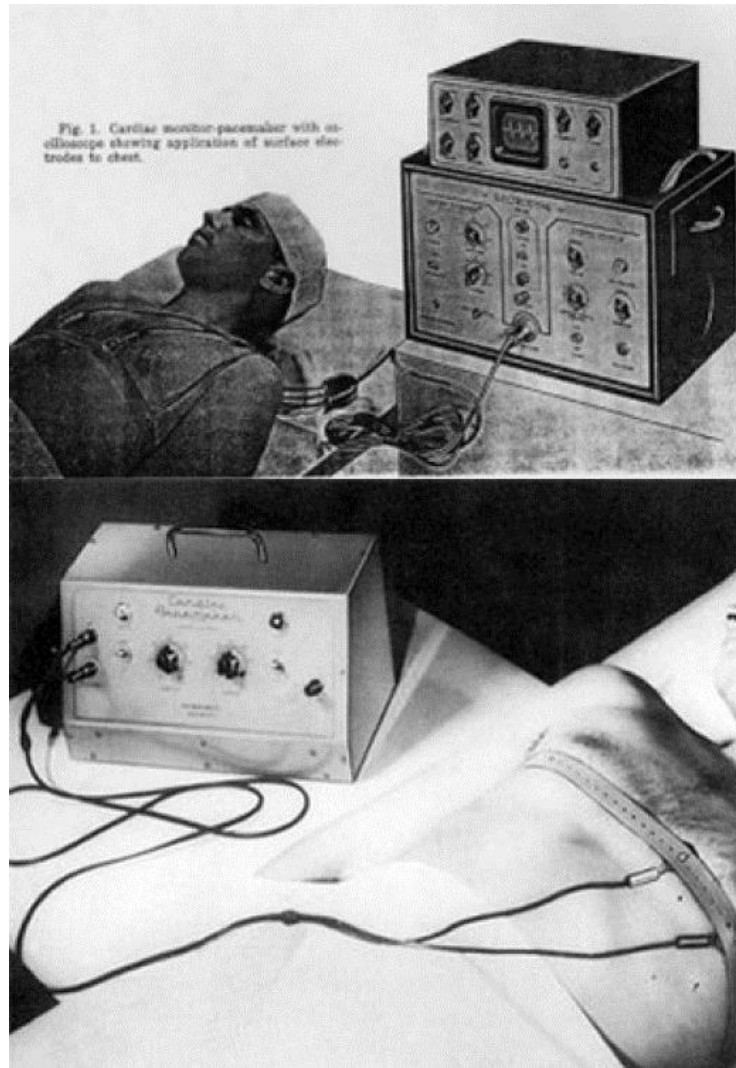

Figure 1.13: Paul Zoll's external pacemaker

The device was heavy, bulky, had to be transported using a cart, and as it was powered by mains electricity, could only go as far as the power cord would allow (Fig 1.14). It delivered electrical impulses through a pair of metal electrodes strapped to the patient's chest directly over the heart. The patients found the experience painful, as the electric shocks irritated the skin.(Aquilina, 2006, Furman, 2002)

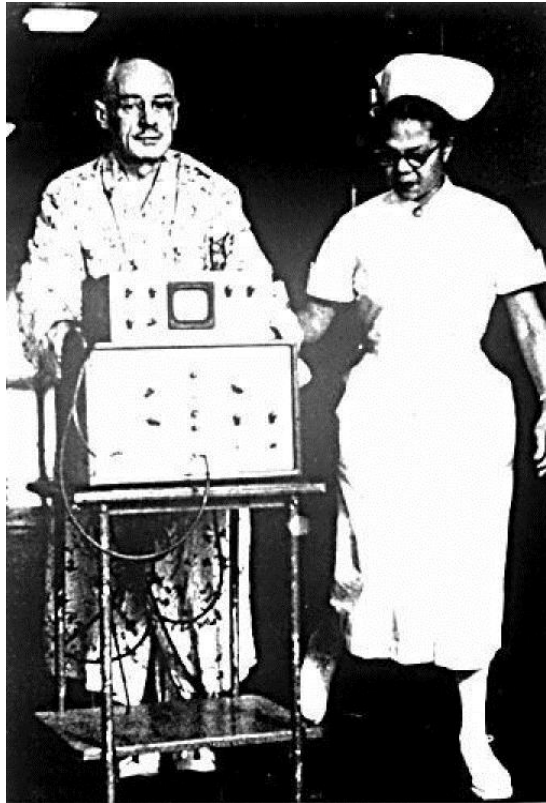

Figure 1.14: Paul Zoll's external pacemaker

In 1952, Zoll reported two episodes, when his device was used to successfully treat two patients suffering from ventricular standstill (Fig. 1.15) and in 1956 Zoll used transthoracic electric shocks to treat ventricular fibrillation in human subjects.



Figure 4. Electrocardiogram in a Patient in Cardiac Arrest, Showing Sporadic Ventricular Beats Interrupted by a Run of Ventricular Rhythm at 100 per Minute Stimulated by the External Mechanical Pacemaker.

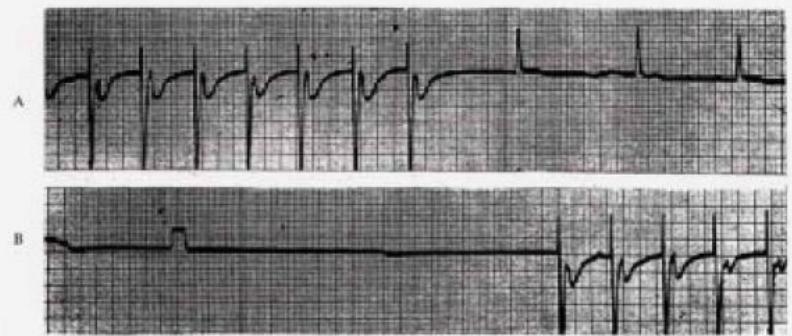

FIGURE 1. Resuscitation from Ventricular Standstill after Cardiac Surgery in Case 8. Effective electric stimulation during ventricular standstill is followed by spontaneous cardiac beats (A). An episode of ventricular standstill is terminated by effective external stimulation (B).

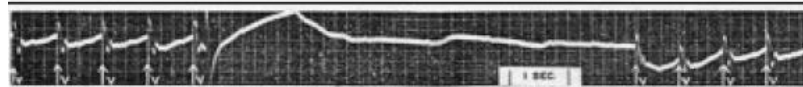

Figure 2. Electrocardiogram (Lead 3) in Case 2, Showing Regular Ventricular Response (V) to Electric Stimulus (Arrow) at a Rate of 78 per Minute, with Intervening Ventricular Asystole When the Stimulator Was Discontinued for Eight Seconds.

Figure 1.15: Early Zoll paced ECG tracings

In St. George's Hospital, London, in 1956 cardiologists Aubrey Leatham and Geoffrey Davies developed an external pacemaker used to resuscitate patients with heart block and asystole. Paul Zoll had just reported his studies on the use of external pacing to treat ventricular standstill, but there were major differences between the two devices. Zoll's pacemaker delivered "fixed pacing", which paced irrespective of the patients underlying heart rate, whereas Leatham and Davies developed system with a "demand pacing" capability, meaning the device could pace the heart in relation to the patient's underlying heart rate. The device still stimulated the heart through

the chest wall, and was manufactured by UK company Firth-Cleveland. The device included a battery, two electrical output settings, “*duration of asystole permitted*” and adjustable sensitivity controls for sensing of the underlying electrocardiogram.(John Camm et al., 2010, Aquilina, 2006)

US cardiac surgeon Clarence Walton Lillehei (1918 – 1999) had performed open-heart surgery in Minnesota on over 300 children and young adults born with congenital heart disease by 1957. Complications encountered by his team during cardiac surgery were to be a major driving force in the advancement of cardiac pacing technology. Despite successful surgery, around 1 in 10 patients developed post-op complete heart block as a result of damage to the conduction system during surgery to repair ventricular septal defects, and mortality in these was 100%.(Gott, 2007) Medical intervention, was helpful in the short-term, but inevitably heart block would return.(Aquilina, 2006)

Lillehei thought that pacing would temporarily provide support to the cardiac rhythm, and maintain heart rate whilst the conduction system was recovering, but realised that high voltage pacing delivered through the skin was painful and traumatic. Following many experiments, Vincent Gott (1927) and William Weirich (1924 - 2014) demonstrated in animals that low voltage electrical impulses delivered by a wire positioned in the right ventricle, and connected to a Glass pulse generator, could stimulate the heart and restore cardiac rhythm.(Aquilina, 2006, Gott, 2007)

Lillehei and his team developed the “*myocardial wire*”, which consisted of numerous braided stainless steel wires covered in a Teflon sleeve (Fig 1.16). One end of the wire was implanted directly into the heart and the other end was connected to the external pulse generator. To complete the circuit, a further electrode was buried under the skin. Only 1.5 volts was required to stimulate the heart, as the electrode was in direct contact with the myocardium. There was no damage to the heart, and once normal conduction had returned the wire could be easily removed by gentle traction.(Aquilina, 2006)

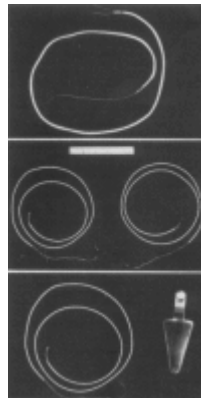

Figure 1.16: Lillehei’s “myocardial wire”

The first implant of the myocardial wire was on the 30th January 1957 in a 3-year old girl who had developed complete heart block following surgery for Fallot’s tetralogy. The pacing procedure was successful - the patient regained sinus rhythm and survived. Following this, myocardial wires started to be implanted prophylactically ready for urgent use. Techniques were developed to allow implantation through a hollow needle to treat non-surgical cases of heart block.(Aquilina, 2006)

There were obvious drawbacks to the set-up at the time. The stimulator was large and immobile and relied on mains power supply. This was to be the most fatal flaw, highlighted when in October 1957, a power failure lasting three hours resulted in the death of a baby. This event prompted Lillehei to contact Earl Bakken, founder of Medtronic Inc. He asked him to design a portable, battery powered pacemaker, as he felt lack of mobility and an unreliable power source were the main drawbacks of the current system.(Aquilina, 2006)

The late 1950's – early 1960's are often referred to as the “Golden Years” of Electrophysiology due to three landmark achievements

- 1) The first battery-operated, wearable pacemaker in 1957.
- 2) The first implantable permanent pacemaker 1958.
- 3) The first long-term treatment of heart block with an implantable pacemaker in 1960.(Aquilina, 2006)

American electrical engineer and TV repairman Earl E. Bakken (1924 – present) developed the first battery-operated, wearable pacemaker in 1957. Bakken co-founded Medtronic Inc, now the largest medical device company in the world, with his relative Palmer Hermundslie (1919-1970) in a garage in northeast Minneapolis in 1949. Their company began as a repair service and distributor for hospital electrical equipment but they also built bespoke equipment at the request of clinical and laboratory researchers. Their time in

hospital and university departments repairing equipment, allowed them to build relationships with physicians and their staff.(Aquilina, 2006, Steinhaus, 2008)

Clarence Walton Lillehei had assigned Bakken the task of developing a battery powered, portable pacemaker. Bakken's initial attempts involved using a car battery as the power source for the pulse generator. This plan was abandoned early on. The car battery was deemed too inefficient and the pulse generator still had to be transported using a trolley. Bakken's next attempt was an adaptation of an electronic, transistorised metronome he had seen advertised in an electronics journal. The device operated as a timing system, the circuit transmitted loud clicks through a speaker and the rate of the clicks was adjustable. Bakken disconnected the speaker, modified the circuit (Fig. 60) and placed it into a four inch square aluminium box, with an on-off switch and control knobs to adjust stimulus rate and the amplitude of energy delivered (Fig 1.18).(Aquilina, 2006, Steinhaus, 2008)

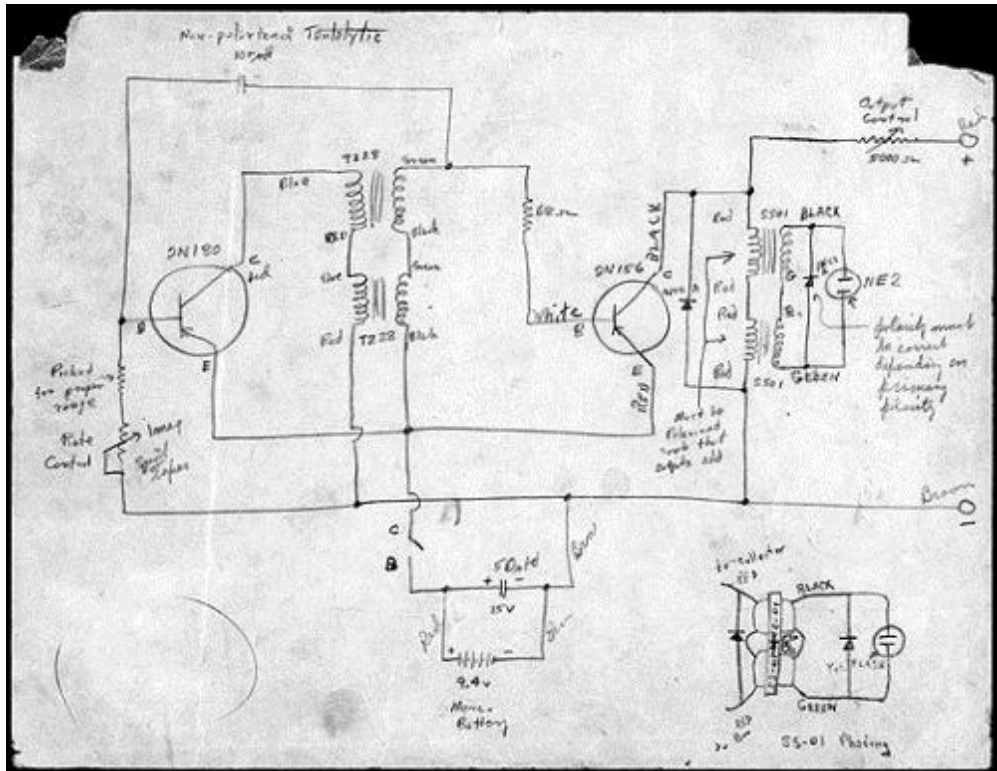

Figure 1.17: Bakken's circuit

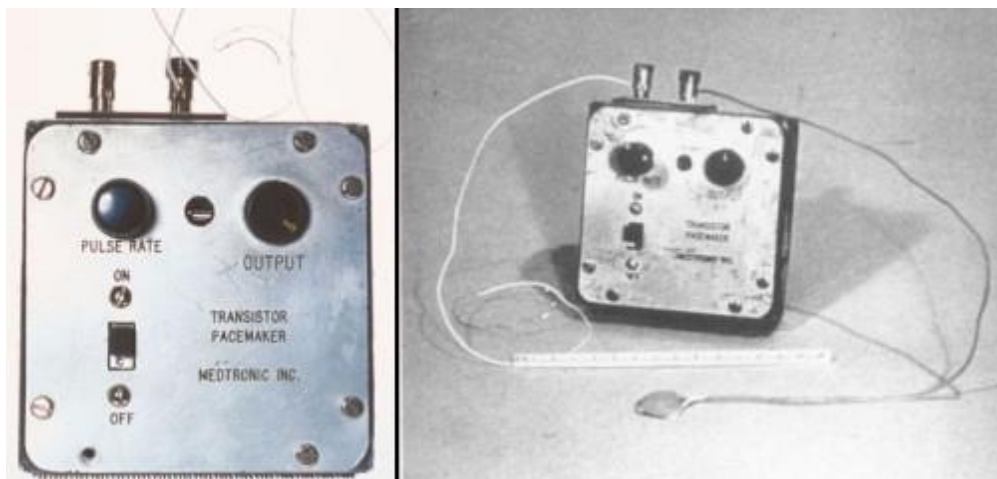

Figure 1.18 Bakken's pacemaker with leads

Bakken took the device to the University lab where it was successfully tested on a dog. The following day when he returned to the hospital to continue work on a different project, he saw one of Lillehei's patients wearing the

device he had delivered the day before. Lillehei explained to Bakken that he had been informed by the lab that the pacemaker worked and he *“wouldn’t allow a child to die because we hadn’t used the best technology available.”* The first battery-powered pacemaker was in clinical use, following only four weeks of development. Subsequent modifications included handles and a strap to make the device “wearable” (Fig 1.19) a red neon light that flashed with each stimulus, and dials that were more childproof. Product literature was provided.(Aquilina, 2006, Steinhaus, 2008)



Figure 1.19: Medtronic pacemaker

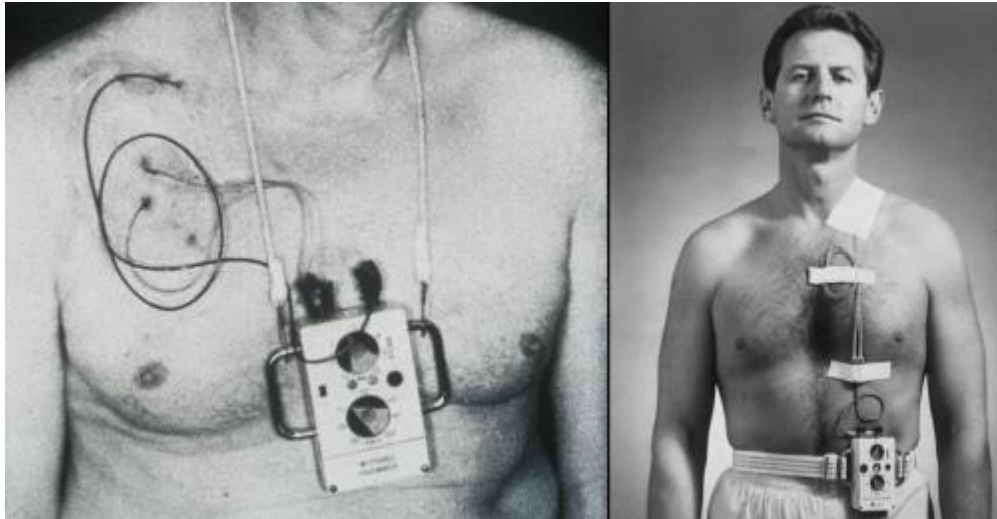

Figure 1.20: Wearable pacemaker

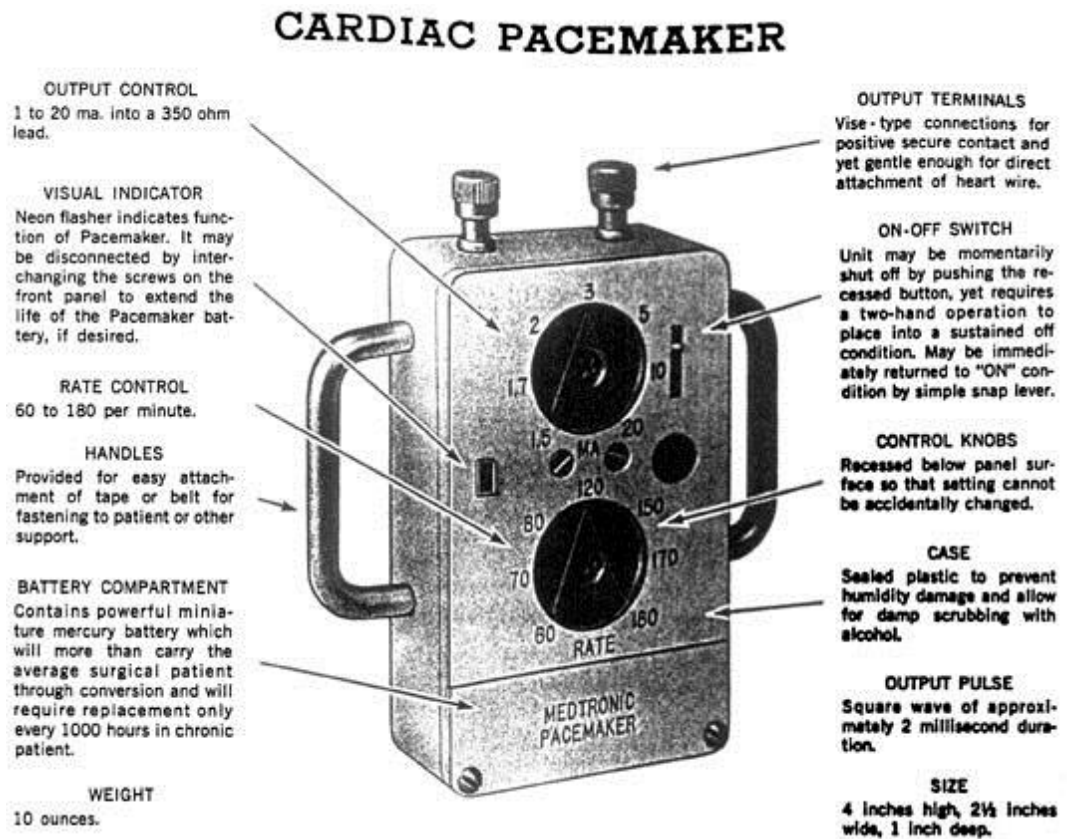

Figure 1.21: Medtronic pacemaker product literature

Despite the success of Bakken's device, infections along the pacing wires were frequent. Lillehei noted this in abstract he published in 1960: "*The question of how long stimulation can be maintained appears to be related to*

electrode materials, design and technique of implantation... The possibility of infection along the wire exists, but... can be minimised by tunnelling the wire for some distance before bringing it out on through the skin.” (Fig 1.22)

Recurrent, post-operative heart block caused several deaths, and it became apparent that patients needed permanent, rather than temporary pacing for long-term survival. The myocardial wire became less effective as scar tissue developed around the stimulation site, requiring an increase in stimulus voltage to maintain capture and causing discomfort because of thoracic muscles twitching. It was apparent that a fully implantable system with different electrode materials was required. (Aquilina, 2006, Steinhaus, 2008)

76/2006

J.A.M.A., April 30, 1960

TRANSISTOR PACEMAKER FOR TREATMENT OF COMPLETE ATRIOVENTRICULAR DISSOCIATION

C. Walton Lillehei, M.D., Ph.D., Vincent L. Gott, M.D., Paul C. Hodges Jr., M.D., David M. Long, M.D.
and
Earl E. Bakken, B.E.E., Minneapolis

A transistor pacemaker (fig. 1) and bipolar electrode has been developed for use in patients with complete atrioventricular dissociation and an inadequate cardiac output. This pacemaker is designed for either short-term or long-term ventricular stimulation by means of an internally implanted myocardial electrode.¹

Complete atrioventricular dissociation is likely to occur in about 10% of patients who have undergone surgical repair of septal defects located in the vicinity of the atrioventricular node and the common bundle of His, and this method of internal stimulation was developed originally to meet this need.

Temporary or permanent complete heart block is not, however, a rare complication of many diverse types of myocardial pathology, sometimes idiopathic or induced by arteriosclerosis, infection, or drug administration; therefore this method of internal stimulation has found a place also in the treatment of selected patients with complete block from these causes.

The pacemaker here described has been used in 66 patients to correct complete heart block. In most cases the block followed surgical procedures, but it also occurred in some nonsurgical patients. The pacemaker consists of three parts: a 9.4-volt mercury cell battery as the source of power; a transistorized oscillator transformer to generate the pulses needed to stimulate the heart; and a unipolar or bipolar electrode in the form of a wire anchored by stitches to the myocardium. The myocardium of the right ventricle has usually been chosen as the most convenient site. Nonsurgical patients incapacitated by complete heart block with low cardiac output have had their conditions maintained on continuous stimulation for up to 15 months by means of this equipment.

Figure 1.22: Lillehei's paper

On October 8th 1958, Swedish thoracic surgeon Ake Senning (1915 – 2000), implanted the first implantable pacemaker, designed by medical engineer Rune Elmqvist (1906 – 1996), at the Karolinska Hospital in

Stockholm. The risk of infection from external pacemakers drove their desire to design a completely implantable device. A pulse generator with a rechargeable battery, which was recharged via induction, was implanted along with myocardial electrodes. The unit was hand-made (Fig 1.23) and consisted of the electronic circuit, nickel-cadmium batteries and the coil recharging antenna. These were placed in an epoxy resin case which had excellent bio-compatibility and was 55mm in diameter and 16mm thick. The impulses were delivered at amplitude of 2 volts and a pulse width of 1.5ms and the pulse rate was fixed at a constant rate of 70 to 80 beats per minute. The first device failed after a few hours, its replacement six weeks, and the third lasted until 1960. Anne H Larsson had a total of 26 pacemakers in his lifetime, and has since passed away - he died aged 86 on 28th December 2001. (Larsson et al., 2003). Senning reported the procedure at the Second International Conference on Medical electronics in 1959 and it was published as an abstract in 1960 (Fig 1.24).(Jeffrey and Parsonnet, 1998, Aquilina, 2006)

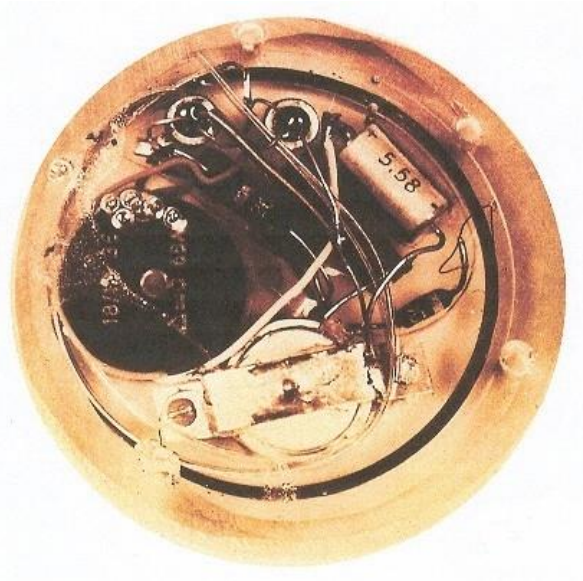

Figure 1.23: Senning and Elmqvist's implantable pacemaker

An Implantable Pacemaker for the Heart

SOMMAIRE : Description d'un régulateur compact, destiné à être implanté sous la peau au niveau de l'épigastre. Le générateur d'impulsion est composé d'un multivibrateur avec un transistor au silicium. L'amplitude des impulsions est d'environ 2 volts, leur durée est d'environ 1,5 milli-seconde. Leur fréquence est constante et d'environ 80 pulsations par seconde. La source d'énergie est un petit accumulateur au cadmium-nickel, composé de deux séries interconnectées de cellules, de 60 mAh chacune.

ONE of the major problems in connection with the permanent use of pacemakers for the heart is the prevention of infection through the channel where the cable is brought out through the skin.

A compact pacemaker is described which is intended to be implanted subcutaneously in the epigastrium. The pulse generator consists of a repetitive blocking oscillator with a silicon transistor. The pulses are fed to the base-circuit of a second silicon transistor. The collector circuit of the second transistor is connected to the electrode over an RC network. The pulse height is about 2 V, and the pulse duration is about 1.5 msec. The pulse frequency is constant and about 80 pulse/sec.

The source of energy is a small nickel-cadmium accumulator consisting of two series-connected cells of 60 mAh each. The apparatus also contains a

coil and a silicon diode, which form the secondary circuit of an inductive charging device. The primary circuit of this device consists of a 150 kc/s generator feeding a large diameter coil. This coil is placed over the pacemaker outside the skin, when the accumulator is charged.

The electrode cable had to be specially developed in order to withstand the movements in the body (about 10^4 bends every day).

Experience from animal experiments and one human case are reported.

R. Elmquist and A. Senning,
Stockholm

Figure 1.24: Senning's abstract

American electrical engineer, Wilson Greatbatch (1919 – 2011) was developing an oscillator to help with the recording of tachycardic episodes when he accidentally discovered a way to make an implantable pacemaker. When designing his circuit he used a larger resistor by mistake, which made the circuit deliver a 1.8 millisecond pulse followed by a 1 second interval. Greatbatch realized that this device could pace a human heart. On the 7th May 1958, Greatbatch brought his pacemaker to the animal lab at the hospital. There, surgeons William Chardack (1919 – 2011) and Andrew Gage (1922 – present), exposed the heart of a dog and applied two pacing wires which were connected to Greatbatch's device, the heart began to beat in synchrony with the device. (Aquilina, 2006, Jeffrey and Parsonnet, 1998)

Following this, many experiments took place in animals and in 1959 Greatbatch patented the implantable pacemaker. Chardack reported the first successful implant in June 1960 on a 77-year old man in complete heart block. In 1961, Chardack, Gage and Greatbatch reported a series of pacemaker implants in 15 patients. Later, Greatbatch invented the long-life lithium-iodine battery to power pacemakers.(Jeffrey and Parsonnet, 1998, Aquilina, 2006)

The next major advancements in pacemaker technology came in the form of lead development. On the 4th April 1959 Professor of Surgery, Samuel Hunter (1921 – 2008) and Norman Roth (1931 - 1997), Chief Engineer at Medtronic, implanted a bipolar stainless steel electrode in a patient suffering from complete heart block following a myocardial infarction. The lead was constructed of two stainless steel wires secured in a silicone rubber base (Fig 1.25).

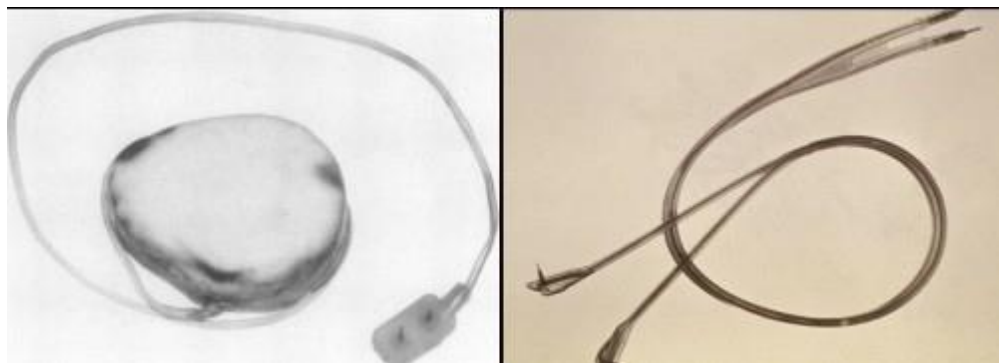

Figure 1.25: Hunter-Roth electrodes

A new lead was developed in 1959 by Swedish company Elema Schonander in partnership with telecoms company Ericsson. It was constructed from four

thin bands of stainless steel, which were wound around a polyester braid and insulated with soft polyethylene (Fig 1.26). It was designed to flex, and was estimated to last for at least 6 years.(Aquilina, 2006)

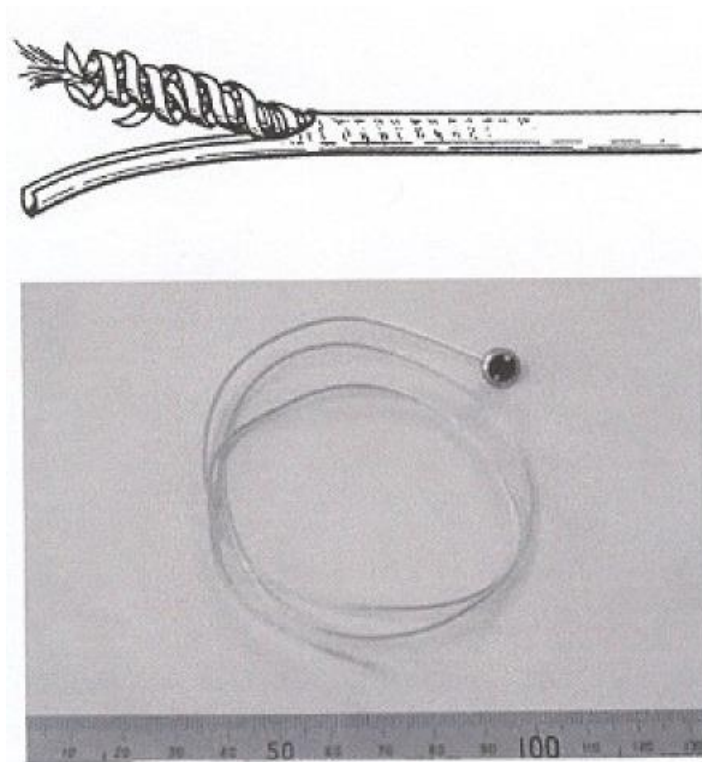

Figure 1.26 Elema pacing lead

Technology continued to develop to make pacemakers more reliable, programmable and automated in the therapy they delivered. The therapeutic aim changed from saving life to include improving quality of life and enhancing care. Trans-venous leads began to replace epicardial leads, to allow pacemakers to be implanted without a general anaesthetic and a thoracotomy. “Demand” pacemakers were developed which could sense underlying cardiac activity and only pace when required. The lithium-iodine battery was developed, resulting in increased pacemaker longevity, and leads were developed to provide “passive” or “active fixation” via tines or a

retractable screw. Titanium casing replaced the epoxy resin and silicone rubber, previously used to enclose the battery and circuitry and protect the internal components.(Aquilina, 2006)

A non-invasive method of programming pacemakers was introduced in the 1970's (Fig 1.27). This was achieved via a radio-frequency link, meaning most variables could be adjusted to follow the clinical requirements of the patient. Towards the end of the 1970's dual-chamber pacemakers were introduced, which could pace and sense both the atria and ventricles. This allowed a more synchronised pacing pattern to be delivered, which could replicate the heart's own conduction pathway. In the 1980's (Fig 1.28) steroid-eluting pacemaker leads were introduced. The steroid from the lead tip decreased the inflammatory response evoked by the lead tip, and reduced the initial rise in capture threshold. In the 1980's rate-responsive pacemakers were developed by including an accelerometer within the pacemaker to detect movement, thereby increasing or decreasing the pacing rate appropriately according to the activity level.(Aquilina, 2006)



Figure 1.27: Pacemakers of the 70's



Figure 1.28: Pacemakers of the 80's

Microprocessor-driven pacemakers were introduced in the 1990's (Fig 1.29) allowing pacemakers to detect and store information using algorithms to detect episodes of tachycardia and percentage of pacing delivered. They

could modify their internal parameters automatically when required to do so.(Aquilina, 2006)



Figure 1.29: Pacemakers of the 90's

In the 1990's, investigators began examining whether ventricular dyssynchrony might play a role in the failing heart and investigated pacemaker-like devices that stimulated several places in the heart simultaneously to minimise conduction delay. The efficacy of multisite pacing in humans was demonstrated in landmark studies by Cazeau et al, Auricchio et al, and Kass et al, and led to Cardiac Resynchronization Therapy (CRT) – the use of artificial electric cardiac stimulation for the principal purpose of changing ventricular function. (Cazeau et al., 1994, Auricchio et al., 1999, Kass et al., 1999) Bi-ventricular pacing, or CRT, was introduced as a treatment for patients with heart failure and left bundle branch block (LBBB). An additional lead is introduced via the coronary sinus to stimulate the epicardial surface of the left ventricle. This allows the right and left ventricles to be paced simultaneously to help resynchronise ventricular contraction, in

the presence of interventricular conduction delay. The improved contraction improves symptoms and survival (Figure 1.30).(Cleland et al., 2005)



Figure 1.30: Medtronic CRT pacemaker

Automaticity of pacemaker follow-up continued to progress, enabling follow-up visits to be simpler and briefer. Technology was also developed to allow pacemaker data to be uploaded telephonically and via the internet, a term coined “Remote follow-up” (Fig 1.31).(Aquilina, 2006)

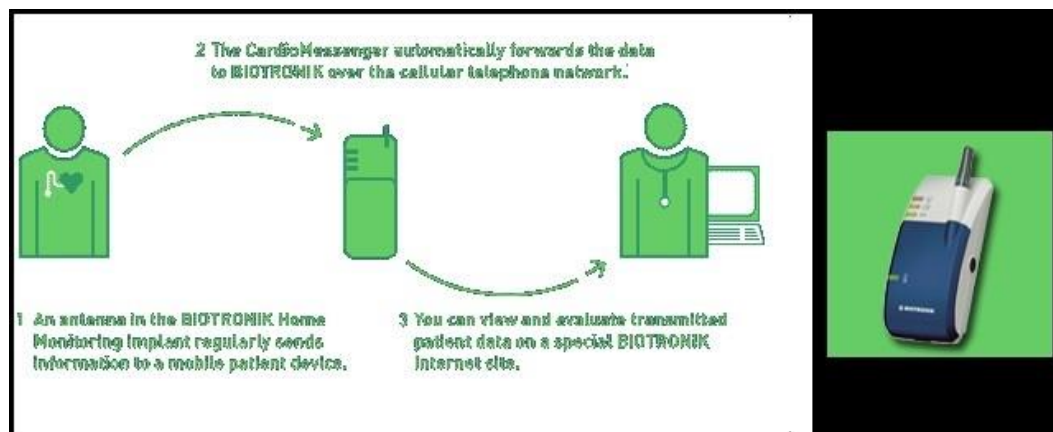

Figure 1.31: Schematic diagram of Biotronik remote follow-up

1.3 Epidemiology of pacemakers in the UK

In 2014, 45,131 pacemakers were implanted in the UK (Raatikainen et al., 2015) - an increase from just over 44,500 in 2013.(Arribas et al., 2014)

Figure 1.32 shows the UK (excluding Scotland due to incomplete data) implant rate from 2003-2013.(Group, 2014)

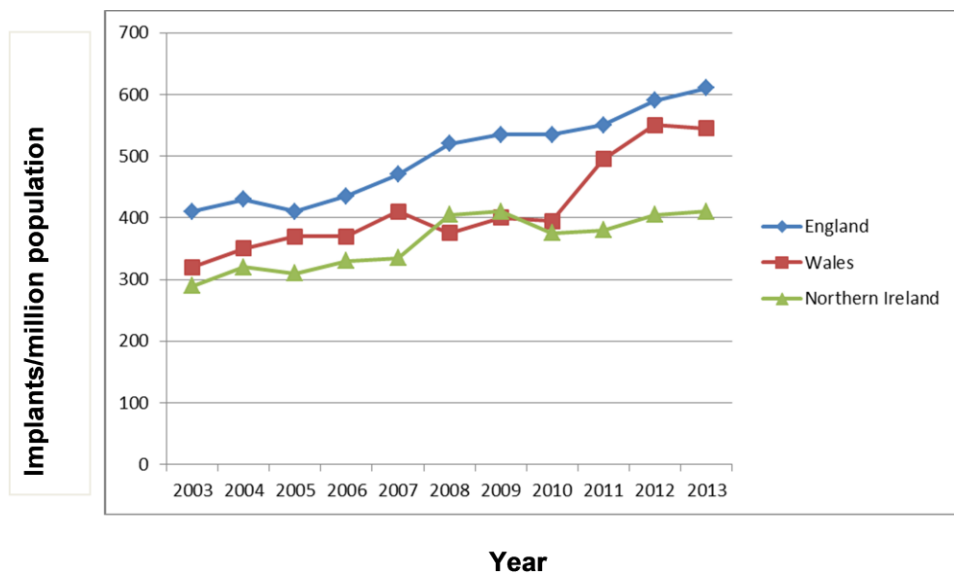

Figure 1.32: New pacemaker implant rate 2003-2013, adapted from CRM National Clinical Audit Report (Group, 2014)

1.4 Effects of RV pacing on cardiac function

Despite proven mortality and quality of life benefits of pacemaker implantation,(Lamas et al., 1998, Shaw et al., 1985, Ohm and Breivik, 1978, Mlynarski et al., 2009) long-term pacing in the right ventricle (RV) may be detrimental to left ventricular (LV) function in some individuals. Pacing the heart using a pacing lead situated in the RV apex has been standard clinical

practice for many years, but this practice has come into question with evidence directing a change in practice toward reducing unnecessary ventricular pacing where possible.

The earliest recordings of the potential detrimental effects of RV pacing were published by Carl J Wiggers in 1925.(CJ, 1925) Wiggers observed adverse changes in LV intra-ventricular pressure curves recorded in dogs, during right ventricular pacing. But it was in the late 1980's and early 1990's that the association between persistent RV pacing and heart failure was recognised. Animal experiments of rapid chronic RV pacing were used to develop experimental models of congestive heart failure,(Wilson et al., 1987, Chow et al., 1990, Masaki et al., 1993, Travill et al., 1992, Armstrong et al., 1986) and it was recognised that prolonged RV pacing was associated with adverse cardiac structural, haemodynamic and neuro-hormonal changes. Human studies comparing atrial to ventricular pacing demonstrated an association with RV pacing and increased incidence of congestive heart failure and atrial fibrillation (AF).(Feuer et al., 1989, Rosenqvist et al., 1986, Rosenqvist et al., 1988, Andersen et al., 1997, Andersen et al., 1994)

It is now appreciated that disorganised ventricular activation, as recognised by electrocardiography, either spontaneous as with left bundle branch block (LBBB),(Xiao et al., 1991, Xiao et al., 1992, Grines et al., 1989, Wilensky et al., 1988, Shamim et al., 1999, Ozdemir et al., 2001, Duzenli et al., 2008) or iatrogenic with RV pacing,(Tse et al., 2002, Tse and Lau, 1997, Nielsen et al., 2000, Thackray et al., 2003, O'Keefe et al., 2005) is associated with

adverse clinical outcomes.(Andersen et al., 1997, Nielsen et al., 1998, Wilkoff et al., 2002, Sweeney et al., 2003) Electrical activation in RV pacing is similar to that in intrinsic LBBB. It originates at the RV apex and passes through the inter-ventricular septum, rather than the His-Purkinje system, then spreads through the LV myocardium with the latest area of activation being the LV infero-lateral,(Varma, 2008, Sweeney and Prinzen, 2006) or infero-posterior region,(Vassallo et al., 1986, Rodriguez et al., 2003, Auricchio et al., 2004) resulting in disorganised contraction.

The acute adverse haemodynamic effect of pacing the RV is negatively correlated with QRS duration (used as a measure of ventricular activation time),(Park et al., 1985) and different sites of RV pacing change the strength of LV contraction, with a linear inverse relationship between the changes and changes in QRS duration.(Burkhoff et al., 1986) Animal,(Sweeney and Prinzen, 2006, Prinzen and Peschar, 2002) and human (Lieberman et al., 2006) studies of RV pacing have shown a larger LV volume during RV pacing and also that pacing at different sites within the RV induces a rightwards shift of the pressure-volume relationship during LV contraction. These adverse changes are associated with a decrease in the ability of the LV to generate pressure (contractility), shown by a reduction in (+dP/dt) and a reduced stroke volume. Overall, RV apical pacing causes a reduction in LVEF of 5-10% in both long and short-term studies,(Tse et al., 2002, Tse and Lau, 1997, Nahlawi et al., 2004) and also has adverse effects on LV diastolic function.(Tse et al., 2002, Tse and Lau, 1997, Prinzen and Peschar, 2002, Zile et al., 1987) In addition to the reduction in left ventricular ejection

fraction (LVEF), RV pacing causes adverse remodelling of the LV,(Lee et al., 1994, Albertsen et al., 2008) and 27% of attendees at a pacemaker clinic have previously been found to have left ventricular systolic dysfunction (LVSD) and heart failure symptoms.(Thackray et al., 2003) The adverse effects of long-term RV pacing in patients with RV pacemakers may also contribute to hospitalisation due to heart failure, with hospitalisation rates of between 10-26% previously reported.(Sweeney et al., 2003, Zhang et al., 2008) These adverse effects may,(Sweeney et al., 2003, Sharma et al., 2005) or may not,(Riahi et al., 2012) be associated with the amount of RV pacing. Other factors and co-morbidities such as age, AF, impaired LV function and QRS duration may also contribute.(Riahi et al., 2012)

Evidence of the clinical superiority of dual chamber (DDD) vs. single chamber ventricular (VVI) pacing, in terms of exercise capacity,(Karlof, 1975, Kruse et al., 1982, Fananapazir et al., 1983, Perrins et al., 1983, Kristensson et al., 1985, Pehrsson et al., 1988, Rediker et al., 1988, Lau et al., 1990) quality of life,(Boon et al., 1987, Perrins et al., 1983) and mortality (Alpert et al., 1987, Alpert et al., 1986, Hesselson et al., 1992) led to DDD pacemakers being used more frequently. However, early DDD pacemakers had limited options for changing AV delays, which often led to permanent RV pacing, and any associated progressive symptoms of heart failure were attributed to progression of conduction disease, rather than reduced cardiac function associated with RV pacing.(Levine, 2010)

The “Danish” pacing trial, (Andersen et al., 1997) was a study of long-term outcomes (up to 8 years) of a previous prospective study in which 225 patients with SSS were randomised to either single-chamber atrial pacing (AAI) or single-chamber ventricular pacing (VVI).(Andersen et al., 1994) Previously there were no differences in mortality between groups (log rank test, $p=0.12$), but more patients in the VVI group had AF and thromboembolic events than those randomised to AAI.(Andersen et al., 1994) However, the Danish trial did show that in the long-term, VVI pacing was associated with increased all-cause mortality, (relative risk 0.66 [95% CI 0.44-0.99]; $p=0.045$) and cardiovascular mortality (0.47 [0.27–0.82], $p=0.0065$), and that those randomised to AAI were at lower risk of developing AF (relative risk 0.54 [95% CI 0.33–0.89], $p=0.012$). (Andersen et al., 1997) The rationale behind the reported adverse outcomes was that intrinsic AV conduction was maintained with AAI pacing, thus avoiding the abnormal ventricular depolarisation seen with RV pacing.

The Pacemaker Selection in the Elderly (PASE) trial was prospective trial in which patients were randomised to receive either DDDR or VVIR pacemakers.(Lamas et al., 1998) 2010 patients with sinus-node dysfunction were assigned to DDDR or VVIR pacing and followed for a median of 33.1 months. The primary end point (all-cause mortality or non-fatal stroke) did not differ between the groups ($p=0.48$), but in patients randomised to DDDR pacing the risk of developing AF was lower (hazard ratio, 0.79; 95 percent confidence interval, 0.66 to 0.94; $P=0.008$), and heart-failure QoL scores were better ($p<0.001$). Rates of hospitalization for heart failure, death and

stroke were not significantly different in unadjusted analyses and were only minimally significant in adjusted analyses.(Lamas et al., 1998)

The Canadian Trial of Physiologic Pacing (CTOPP) was a randomised trial of 1474 patients receiving a DDDR or AAIR pacemaker vs a VVIR pacemaker, for bradycardia, with the rationale of examining the effects of physiological vs ventricular pacing on the primary outcome of cardiovascular death or stroke.(Connolly et al., 2000c) Annual occurrence of the primary outcome was 5.5% with ventricular pacing vs 4.9% with physiologic pacing (RRR, 9.4%; 95% CI: -10.5 to 25.7%; p=0.33). Annual AF rate was significantly lower in the physiologic-pacing group (5.3 v 6.6% (RRR, 18%; 95% CI: 0.3 to 32.6%; p=0.05) Annual all-cause mortality and hospitalization for heart failure rates were lower in those paced physiologically, but did not reach statistical significance. However, there were more complications associated with physiologic pacing 9% v 3.8%, p<0.001).(Connolly et al., 2000c)

The United Kingdom Pacing and Cardiovascular Events (UKPACE) trial compared elderly patients with atrioventricular block receiving single-chamber ventricular pacing and dual-chamber pacing.(Toff et al., 2005) 2021 patients aged 70 years or older were randomised to receive a single-chamber ventricular pacemaker (VVI) or a dual-chamber pacemaker (DDD). The VVI group were randomised receive fixed-rate or rate responsive pacing. Mean annual mortality rate was 7.2% in the VVI group v 7.4% in the DDD (HR, 0.96; 95% CI: 0.83 to 1.11). There were no differences

between groups in annual rates of AF, heart failure or composite stroke, TIA or other thromboembolic outcomes.

From the accumulating evidence base towards AV sequential pacing being a more physiological way of pacing,(Karlof, 1975, Kruse et al., 1982, Fananapazir et al., 1983, Perrins et al., 1983, Kristensson et al., 1985, Pehrsson et al., 1988, Rediker et al., 1988, Lau et al., 1990, Boon et al., 1987, Alpert et al., 1987, Alpert et al., 1986, Hesselson et al., 1992) and having evidence that VVI implantable cardioverter defibrillators reduced mortality in patients with heart failure,(1997a) device manufacturers began developing dual-chamber implantable cardioverter defibrillators (ICD's). Dual-chamber ICD's were immediately widely accepted, on the reasoning that the introduction of an atrial lead would be beneficial in terms of both improved haemodynamics from AV sequential pacing whilst also providing improved rhythm recognition, although no studies had been carried out to support this approach. It was the introduction of dual chamber pacing into ICD's that rapidly led to the evidence of an association between RV pacing and CHF.

The dual-chamber pacing or ventricular backup pacing in patients with an implantable defibrillator: the Dual Chamber and VVI Implantable Defibrillator (DAVID) Trial was designed, in the late 1990s. The trial had the objective of investigating the efficacy of dual-chamber pacing when compared with backup ventricular pacing in patients with standard ICD indications, without an indication for anti-bradycardia pacing. The primary endpoint was a

composite of death or worsening or new heart failure resulting in hospitalization.(Wilkoff et al., 2002, Wilkoff, 2001) Part of the inclusion criteria for participation in the DAVID trial was that the patient did not require ventricular pacing. In addition to standard anti-tachycardia therapies, participants were randomly allocated to either a back-up setting of VVI 40 bpm or DDDR 70 bpm. The programming of the AV delay settings was at the individual investigators discretion at each of the study sites. Most of the physicians left the paced and sensed AV delays at factory settings of 170/150 ms respectively.

The study was terminated early in 2002, due to an increase in the primary endpoint in the DDD group compared to the VVI group. Participants randomised to DDDR pacing had much higher RV pacing than those programmed to VVI group (57.9 vs 1.5% $p < 0.001$, 59.6% vs 0.6%, $p < 0.001$ and 58.9% vs 3.5%, $p < 0.001$ at 3, 6 and 12 months respectively). Prompted by the results of the DAVID trial, the investigators of the Mode Selection Trial (MOST), MADIT II, and MIDAS,(Shukla et al., 2005, O'Keefe et al., 2005, Freudenberger et al., 2005, Steinberg et al., 2005) studies performed a retrospective analysis of their data, and arrived at a similar conclusion to the DAVID investigators – that high levels of RV pacing were associated with a higher incidence of LV dysfunction, heart failure, atrial fibrillation and hospitalisations.

Two hypotheses arose from the outcome of the DAVID trial. First, that the adverse effects in the DDD group were due to high heart rate from being

paced at 70bpm with rate response activated, therefore increasing metabolic demand and worsening ischaemia, leading to ventricular dysfunction. The second hypothesis focussed on the AV delay settings, and how short AV delay settings can increase the amount of ventricular pacing.

The DAVID II trial was designed to explore the first hypothesis; the investigators compared VVI pacing at 40 with AAI pacing at 70 in a further cohort of patients requiring ICD therapy, with no indication for pacemaker therapy. The study was completed and upon examination of the data, there was no significant difference between the groups, ruling out the higher heart rate as the cause of LV dysfunction and CHF.

To explore the second hypothesis, the bradycardia settings of the ICDs that were implanted in the DAVID study were examined.(Sharma et al., 2005) It was found that a sub-group of patients had their AV delays extended by the physician to encourage intrinsic conduction. From this further data analysis, the investigators found a split of three groups with different characteristics:

- 1) A ventricular pacing percentage >40%, related to higher incidence of LV dysfunction, heart failure and AF.
- 2) Pacing at VVI 40 produced the lowest amount of ventricular pacing (<4%), but was not associated with the best outcomes.
- 3) The patients in whom the physicians had programmed long AV delays had the lowest incidence of adverse effects. This group were paced around 11% in the right ventricle. It was considered that their better outcome, despite higher RV pacing when compared to the VVI pacing

group, was due to maintenance of AV synchrony provided by DDD pacing.

Around the same time as the DAVID trial was being conducted, US pacemaker and ICD manufacturer Boston Scientific were conducting the Inhibition of Unnecessary RV Pacing with AVSH in ICD's (INTRINSIC RV) trial.(Olshansky et al., 2007) The study design was very similar to DAVID apart from one key area - the AV delay settings were specified in the study protocol. The inclusion criteria for the INTRINSIC RV trial included an indication for an ICD and intact AV conduction, therefore not requiring RV pacing. There were two groups 1) a VVI group and 2) a DDD group. The DDD group was sub-divided into 2 groups 1) a permanent AV delay of 200 ms (longer than DAVID trial) and 2) an AV delay of 200 ms plus Boston Scientific's own RV pacing avoidance algorithm - AV Search Hysteresis® (AVSH). AVSH could increase the AV delay up to 300 ms and would maintain this longer AV delay setting as long as intrinsic AV nodal conduction was intact.

The results of the INTRINSIC RV trial were released in 2007, and were similar to the DAVID trial in that the patient group with >40% RV pacing had the highest incidence of LV dysfunction and heart failure. What was also similar to the DAVID trial was that the group programmed to VVI had the lowest amount of RV pacing but not the lowest incidence of heart failure. The lowest incidence of CHF and LV dysfunction was to be found in the

group programmed DDD with the AVSH RV pacing avoidance algorithm activated, despite this group having an RV pacing percentage of 11-19%.

In acknowledgement of the gathering evidence of the potential adverse effects of RV pacing, pacemaker manufacturers began developing algorithms designed to reduce unnecessary RV pacing. This technology was aimed mainly at patients with sinus bradycardia or low grade/intermittent AV block, and is designed to deliver RV pacing when absolutely necessary to maintain patient safety. Despite the opinion of many cardiologists that permanent single-chamber atrial pacing was sufficient for patients with a sinus bradycardia pacing indication, concern existed that developing AV conduction system disease, or the disruption of AV nodal conduction through medical therapy, could not be ruled out as a future complication and could lead to problems in patients with only a single chamber atrial system implanted. Also, intact AV nodal conduction at rest does not reflect AV nodal conduction at higher heart rates, hence the enthusiasm for DDD systems remained, but the risk of RV pacing countered by the development of RV pacing avoidance algorithms.

Two main methods of RV pacing reduction emerged;

- 1.) AV Hysteresis

The first was released by the majority of pacemaker manufacturers, and was based around extension the AV delay settings of the pacemaker by the pacemaker software. These algorithms are designed so that pacemaker software increases the AV delay settings incrementally, until

the pacemaker senses an intrinsically conducted ventricular beat, or the device reaches the predetermined AV delay upper limit. If a ventricular beat is not sensed within this time period the pacemaker paces the RV, producing a ventricular contraction thus maintaining AV synchrony and cardiac output. The pacemaker software continues extending the AV delay until intrinsic ventricular activity is sensed, or the ventricle is paced. If the AV delay reaches a pre-determined upper limit without a sensed ventricular event, the software reverts back to the original programmed settings, designed to represent a “physiological” PR interval duration. Studies have demonstrated the effectiveness of AV search hysteresis in reduction of RV pacing.(Olshansky et al., 2006, Pakarinen and Toivonen, 2013, Kolb et al., 2011, Bauer et al., 2015, Yadav et al., 2016)

2.) Atrial pacing with ventricular sensing based algorithms.

The second method of unnecessary RV pacing avoidance algorithm was first introduced by US pacemaker manufacturer Medtronic, Medtronic named this algorithm Managed Ventricular Pacing® (MVP). MVP, also known as AAI-DDD or AAIR-DDDR, is designed to inhibit RV pacing following a sensed or intrinsic atrial event, until after the following atrial event, at which point a ventricular stimulus is delivered. There is also a search function where the pacemaker software will search for intrinsic ventricular activity at set intervals. Trials have demonstrated the effectiveness of MVP over standard DDD programming, with significant reductions in RV pacing,(Gillis et al., 2006, Sweeney et al., 2004, Sweeney et al., 2005, Milasinovic et al., 2008, Rey et al., 2012) and reduction in atrial arrhythmia burden.(Rey et al., 2012)

French pacemaker manufacturers, Sorin-ELA, released an algorithm similar to MVP named AAIsafeR®.(Savoure et al., 2005, Pioger et al., 2007) The difference between AAIsafeR and MVP is that it includes an AV delay which is programmable up to 450ms. This is designed to avoid RV pacing whilst also avoiding long pauses which can occur with the MVP algorithm, and can lead to presyncopal symptoms. AAIsafeR has been shown to be safe, (Thibault et al., 2009) and effective at reducing RV pacing.(Pioger et al., 2007)

The SAVE PACe trial,(Sweeney et al., 2007) published in 2007, was a randomised study designed to assess the effects of reducing ventricular pacing, via both MVP and Search AV hysteresis algorithms vs standard DDD pacing in 1065 patients with sick sinus syndrome and normal A-V conduction on the time to the development of persistent AF. Over a mean follow-up period of 1.7 ± 1.0 years, the median percentage of RV pacing was lower in the group randomised to DDD with RV pacing avoidance vs standard DDD pacing (9.1% vs. 99.0%, $P<0.001$). The risk of developing AF was lower in those allocated RV pacing avoidance (68 patients (12.7%) v vs 42 (7.9%)), with a hazard ratio for developing persistent AF of 0.60 (95% confidence interval, 0.41 to 0.88; $p=0.009$). There was no significant difference in mortality between the two groups (4.9% vs. 5.4%; $p=0.54$). (Sweeney et al., 2007)

Inevitably, comparisons of the effectiveness of AV hysteresis vs MVP algorithms at reducing ventricular pacing have been made, including a prospective study of 322 patients requiring DDD(R) pacemakers published in 2008.(Purerfellner et al., 2008) The primary end point was a reduction in ventricular pacing after 1 month. Patients were split into categories based upon their degree of AV block: permanent 3rd degree AVB, intermittent 3rd degree AV block, 2nd degree AV block, 1st degree AV block and no AV block. After 1 month, those with MVP activated vs Search AV+ had significantly lower median %VP in all categories except for permanent 3rd degree AV block.: no AV block (0.3 vs 2.9, $P < 0.0001$), 1st degree AV block (0.9% vs 80.6%, $P < 0.0001$), 2nd degree AV block (37.6 vs 99.3, $P < 0.002$), intermittent 3rd degree AV block (1.2 vs 42.2, $P = 0.02$), permanent 3rd degree AV block (98.9 vs 100, $P = 1.00$) suggesting that MVP is better at avoiding RV pacing than AV hysteresis.

Results from a similar study were published in 2010. The IDEAL RVP study,(Murakami et al., 2010) sponsored by Medtronic, was designed to compare Medtronic's own AV Hysteresis algorithm (Search AV+) with MVP. This was a randomised, crossover study design in which patients received a Medtronic pacemaker and either the Search AV+ or MVP mode was activated for 1 month, and then changed to the other algorithm for a further 1 month. The primary end point was again reduction in ventricular pacing percentage. Patients were again categorized into groups according to degree of AV block at recruitment: no AV block, 1st degree AV block, 2nd degree AV block, intermittent 3rd degree AV block, and permanent 3rd

degree AV block. Similar results to the 2008 study were confirmed in that MVP was more successful than AV search+ at reducing RV pacing in all patient groups, except for those with permanent 3rd degree AVB: no AV block (0.2 vs. 0.8%, $P < 0.000$), 1st degree AV block (2.3 vs. 27.4%, $P = 0.001$), 2nd degree AV block (16.4% vs. 91.9%, $P = 0.0052$) intermittent 3rd degree AV block (37.7% vs. 92.7%, $P = 0.0003$) and permanent AV block (100% vs 100%, $P = \text{NS}$).

A longer term study published in 2014,(Chen et al., 2014) randomised 385 patients requiring a DDD pacemaker. Patients implanted with DDD pacemakers were allocated MVP or the Search AV+ algorithm.(99) The primary endpoint was reduction in percentage of VP collected at 1, 6 and 12-month intervals in patients with sinus and AV node dysfunction. Of the recruited patients, 253 had SND and 72 had AVB. The %VP in the MVP group was significantly lower than in the SAV+ group at all follow-up intervals. At 12-months, median %VP in SND patients was 0.2% in the MVP group vs 1.4% in the SAV+ group ($P < 0.0001$) and median %VP in patients with AVB was 11.8% in the MVP group vs 98.1% in the SAV+ group ($P < 0.001$). A trend in the correlation between %VP and AT/AF burden was observed.

RV pacing avoidance algorithms can significantly reduce RV pacing but there remains a lack of evidence demonstrating the long-term clinical relevance of RV pacing avoidance on patient-orientated outcomes and they may even be deleterious.

1.5 Alternate right ventricular pacing sites

As well as trying to avoid unnecessary RV pacing, alternative pacing sites emerged as options in the attempt to offset the potential negative effects of RV apical pacing in patients with mandated high levels of RV pacing due for example to CHB. RV pacing from the apex is considered to be suboptimal, due to the abnormal ventricular activation sequence produced, whereas pacing from the ventricular septum or right ventricular outflow tract (RVOT) was considered to be potentially less detrimental.(Manolis, 2006) The theory of pacing from these sites was that that ventricular activation would more resemble intrinsic conduction, as the origin of the paced beat would originate from near the heart's own conduction pathway. Alternate pacing sites are considered particularly important for individuals predicted to be exposed to high amounts of ventricular pacing, or with underlying ventricular dysfunction.

1.5.1 RV outflow tract pacing

Pacing from the RV outflow tract has been studied the most comprehensively among alternative pacing sites. (Flevari et al., 2009, Hillock and Mond, 2012, Kaye et al., 2009, Mond et al., 2007, Rosso et al., 2010, Stambler et al., 2003, Vlay, 2006) A retrospective study of RV outflow tract vs RV apical pacing, demonstrated improved survival in 150 unselected patients,(Vanerio et al., 2008) whilst a small, non-randomised, study in 14 patients could not establish a benefit of RV outflow tract pacing on LV

dyssynchrony.(Schwaab et al., 1999) A meta-analysis of 9 studies containing 217 patients compared RV outflow tract and RV apical pacing and established a positive haemodynamic effect of RV outflow tract over RV apical pacing,(de Cock et al., 2003) although many of the studies had short-term follow-up periods. Further work, with longer follow-up duration and in-depth dyssynchrony analysis is required to further investigate the effects of RV outflow tract vs RV apical pacing.

1.5.2 RV septal pacing

RV septal pacing has also been investigated as a potential alternative pacing site due to reports from short-term comparative studies of improved ventricular synchrony, shorter QRS duration, normal cardiac axis, better LVEF and reduced pacing lead issues.(Victor et al., 2006, Burri et al., 2007, Yu et al., 2007) However, longer term randomised studies have not confirmed that septal pacing is superior to RV apical pacing. Results from the Protect-Pace trial, which examined the effect of RV pacing lead site on LV function in patients with high-grade AV block, showed no significant differences between RV apical and RV septal pacing in heart failure hospitalization, mortality, AF burden or plasma brain natriuretic peptide levels.(Kaye et al., 2015) A further randomized study, of 98 patients with AV block, found no differences in LVEF and exercise capacity after 18 months of follow-up.(Kypta et al., 2008)

1.5.3 His Bundle pacing

His bundle pacing has also been studied as an alternative pacing site to RV apical pacing. Deshmukh et al. were the first to investigate the feasibility of this strategy in 2001 in 12 human subjects with AF, Dilated Cardiomyopathy (DCM) and QRS duration <120ms, following previous work done in canine models. His bundle capture was maintained at long-term follow-up in 11 patients (92%). After a mean follow-up period of 23.4 ± 8.3 months, LV end-diastolic diameter had decreased from 51 ± 10 mm to 43 ± 8 mm ($p < 0.01$) and LVEF had increased from $18.2 \pm 9.8\%$ to $28.6 \pm 11.2\%$ ($p < 0.05$) (Deshmukh et al., 2000). His bundle pacing may result in favourable improvements in inter- and intra-ventricular dyssynchrony, myocardial perfusion and mitral regurgitation, (Occhetta et al., 2006, Zanon et al., 2008) although the second study showed no significant difference in NYHA class, LV volume, LVEF or plasma brain natriuretic peptide levels. (Zanon et al., 2008)

A meta-analysis published by Shimony et al. (Shimony et al., 2012) examined all of the randomized studies comparing RV apical pacing vs non-apical pacing (His, para-His and mid-septal pacing). In total, 754 patients from 14 studies were analysed, 385 had 'septal' pacing with 369 having RV apical pacing. Beneficial effects on LVEF were demonstrated for follow-up periods of more than 12 months and for patients with LVEF less or equal to 45%. Despite this, there were no significant differences demonstrated in measures of quality of life, functional tests (inc walking tests and pVO_2) and morbidity/mortality rates. Despite evidence of some beneficial effects of

alternative pacing sites, at present, septal and direct His bundle pacing are not widely used in patients requiring permanent cardiac pacing largely due to problems with lead positioning and concerns about lead stability and electrical parameters when compared to RV apical pacing.(Epstein et al., 2008)

1.6 Cardiac Resynchronisation Therapy (CRT)

De novo, and upgrade of existing right ventricular pacemakers to, CRT as a treatment option for patients with CHF will be discussed in the next chapter on heart failure.

Chapter 2. Introduction to Chronic Heart Failure (CHF) and its treatment

2.1 Introduction to CHF

Chronic heart failure (CHF) is a syndrome characterised by symptoms including fatigue, breathlessness at rest and during exertion and ankle swelling. A key feature is reduced cardiac output on exertion, as a result of one or more of many potential cardiac structural or functional abnormalities, which through neuro-hormonal activation, or direct haemodynamic effects has adverse systemic effects on kidneys, skeletal muscles, lung function, immune system, resulting in a poor prognosis, recurrent hospitalisations, and significantly reduced quality of life (QoL).(Dickstein et al., 2008)

2.2 Terminology of CHF

The terminology commonly used to define CHF is centred on the measurement of the left ventricular ejection fraction (LVEF). Patients with CHF are generally defined into two categories:

1. Those with reduced LVEF (usually <40%), HF with reduced EF (HFrEF) or left ventricular systolic dysfunction (LVSD))
2. Those with normal LVEF (usually ≥50%), HF with preserved EF (HFpEF) or left ventricular diastolic dysfunction.

LVSD is defined as reduced LVEF due to reduced cardiac contractility, whereas LV diastolic dysfunction is reduced cardiac output due to impaired relaxation properties of the myocardium.(Ponikowski et al., 2016)

Recently, a third category of CHF has been proposed: HF with mid-range EF (usually 40–49%) or HFmrEF, reflecting the lack of evidence for treatment for people with mild LV systolic dysfunction.(Ponikowski et al., 2016) Defining CHF based on LV function is regarded by many as simplistic since the degree of cardiac dysfunction relates poorly to symptoms. However, other methods of definition lack clarity and only for HFrEF do we have therapies shown to reduce morbidity and mortality. Hence the classification of heart failure based around LV function remains.(Ponikowski et al., 2016)

2.3 Epidemiology of CHF

CHF is common in developed countries, with 1-2% of adults affected, rising to $\geq 10\%$ of those aged over 70.(Mosterd and Hoes, 2007, Redfield et al., 2003, Bleumink et al., 2004, Ceia et al., 2002) The overall incidence of CHF has remained stable over the last 2 decades,(Ho et al., 1993, Levy et al., 2002) and although recent data based on hospitalization suggests that the incidence of CHF may be decreasing,(Gerber et al., 2015, Owan et al., 2006) this might be the result of better treatment and more advanced outpatient programs. At age 55, the lifetime risk of developing CHF is higher in males (33%) than females (28%).(Bleumink et al., 2004)

Improvements in treatments for CHF and associated co-morbidities improve outcome and symptoms, but increase prevalence. The societal burden is increased further by lifestyle choices with more people than ever living alone, and the overall ageing of the population.

Therapeutic advancements have improved treatment of CHF over time, but morbidity and mortality remain high. CHF is responsible for 5% of all hospital admissions, and is the most common cause for hospital admission in those over 65.(Yousaf et al., 2012, Mosterd and Hoes, 2007) Recent European data show that 12-month all-cause mortality rates were 17% for hospitalized patients and 7% for stable patients and 12-month hospitalization rates were 44% for hospitalized patients and 32% for stable patients.(Maggioni et al., 2013b)

Patients with heart failure suffer a poor quality of life, worse than that experienced by others with other chronic conditions, such as COPD and many cancers not only due to the high risk of readmission,(Stewart et al., 2001b) but also frequent GP visits (Stewart et al., 2001a) and persistent reduced physical capacity due to symptoms of breathlessness and fatigue.(Hobbs et al., 2002)

2.4 Diagnosis of CHF

The primary symptoms of heart failure are breathlessness and fatigue resulting in exercise intolerance. These symptoms have poor specificity,(135-139) and although they can alert the physician to the prospect of underlying disease, the absence of symptoms does not exclude underlying disease. Accurate diagnosis of CHF necessitates a thorough clinical examination, usually combined with investigations to confirm the diagnosis, identify underlying aetiology and provide objective measurements of severity.

Demonstration of underlying cardiac dysfunction is a key component of the diagnosis of CHF.(Ponikowski et al., 2016) However, cardiac dysfunction is the result of many different diseases which in addition to effects on the myocardium can also adversely affect the valves, conduction system or pericardium.

Symptoms and echocardiographic evidence of LVSD are an accepted combination to make a diagnosis of CHF in the majority of patients. However, many patients with significant cardiac disease do not have overt symptoms or have deteriorated slowly and assume it is a normal part of ageing and do not seek help. The most common presenting symptoms of CHF are non-specific, and many patients with shortness of breath on exertion and ankle swelling do not have heart failure.(Davie et al., 1997,

Mant et al., 2009, Oudejans et al., 2011, Fonseca, 2006, Kelder et al., 2011a) Additionally, there is no defined cut-off value of LVEF or any alternative measurement of cardiac function that can be used to define CHF. Therefore, many patients presenting with symptoms typical of CHF may have equivocal results from initial cardiac investigations. Also, symptoms in the presence of good LV systolic function may represent impaired relaxation of the left ventricle during diastole defined 'diastolic dysfunction' and may be described as having HFpEF.

National and European guidance suggest plasma concentration of natriuretic peptides (NPs) should be used as an initial diagnostic test, in non-acute situations, if CHF is suspected. (National Clinical Guideline, 2010, Ponikowski et al., 2016) Elevated NPs can help identify those who may warrant further cardiac investigation, as those with normal plasma NP levels are the least likely to have CHF. (Ponikowski et al., 2016) It is recommended that serum concentrations of B-type natriuretic peptide (BNP) or N-terminal pro-B-type natriuretic peptide (NTproBNP) be measured. (National Clinical Guideline, 2010, Ponikowski et al., 2016)

High levels of serum NPs are associated with poor outcomes, and therefore those with suspected CHF and a BNP level of >400 pg/ml (116 pmol/litre) or an NTproBNP level >2000 pg/ml (236 pmol/litre) require urgent referral for cardiology review and transthoracic echocardiography within 2 weeks.(National Clinical Guideline, 2010) Those with a BNP level between 100 and 400 pg/ml (29–116 pmol/litre) or an NTproBNP level between 400 and 2000 pg/ml (47–236 pmol/litre), and symptoms of heart failure, are

considered at lower risk, and should have cardiology review and transthoracic echocardiography within 6 weeks.(National Clinical Guideline, 2010)

NPs may be elevated as a result of several cardiovascular and non-cardiovascular reasons that may reduce their effectiveness in diagnosing CHF, AF, age and renal failure being the most important factors.(Maisel et al., 2008) NPs have been demonstrated to have high negative predictive values (0.94–0.98) in acute and non-acute settings, and low positive predictive values in the acute (0.66–0.67) and non-acute settings (0.44–0.57).(Roberts et al., 2015, Zaphiriou et al., 2005, Fuat et al., 2006, Yamamoto et al., 2000, Cowie et al., 1997, Krishnaswamy et al., 2001, Kelder et al., 2011b) Therefore, the use of serum NP levels is recommended for ruling-out, rather than confirming, a diagnosis of CHF. (Ponikowski et al., 2016)

2.5 Pathophysiology and aetiology of CHF

Ischaemic heart disease (IHD) is the most common cause of CHF in the developed world,(Felker et al., 2002) and can lead to CHF through different pathophysiological processes.(Cleland et al., 2003a, Cleland et al., 2003b) Myocardial infarction (MI) may result in permanent loss of cardiac myocytes and their replacement with scar but coronary occlusion may also result in a persistent (but not permanent) loss of myocardial contraction without permanent cell death (myocardial hibernation). Less severe or transient coronary occlusion with entirely reversible ischaemia usually does not lead

to left ventricular dysfunction, although recurrent ischaemia can lead to 'stunning' with more short-term loss of contractility than hibernation. Hibernation, stunning and reversible ischaemia are potential therapeutic targets in CHF but until recently,(Velazquez et al., 2016) little evidence existed to guide management.

Hypertension is a major risk factor in CHF and may be the biggest worldwide contributor to the development of the condition. This may be directly through increased afterload, or indirectly through hypertension being the biggest contributor to IHD.(Lloyd-Jones et al., 2002, Levy et al., 1996) Valvular heart disease, infiltration (amyloid, sarcoidosis), viral infection, idiopathic dilated cardiomyopathy (DCM) and tachycardia induced cardiomyopathy are also potential causes of CHF. These are collected into the term non-ischaemic cardiomyopathy or non-ischaemic heart failure and form in total around 30% of all cases in the western world.

Many patients have asymptomatic cardiac dysfunction for years before they experience symptoms. A combination of increased LV stroke volume via LV remodelling, peripheral vasoconstriction as a result of increased renin-angiotensin aldosterone system (RAAS) activation and increased heart rate and cardiac contractility via sympathetic nervous system activity can maintain filling pressures and cardiac output.

Eventually these compensatory mechanisms fail, and further dilatation of the left ventricle no longer results in an increased stroke volume, but rather to an increase in end-diastolic pressure. High levels of angiotensin II and

adrenergic hormones persistently stimulate peripheral vasoconstriction, and cause salt and water retention leading to increased afterload and an increase in the circulating volume. These hormones also increase myocyte apoptosis, worsening LV function and further over-activation of compensatory mechanisms. ACE inhibitor and beta-blocker therapy can counter-act these causes of deterioration. (Cleland et al., 2001, Khand et al., 2001)

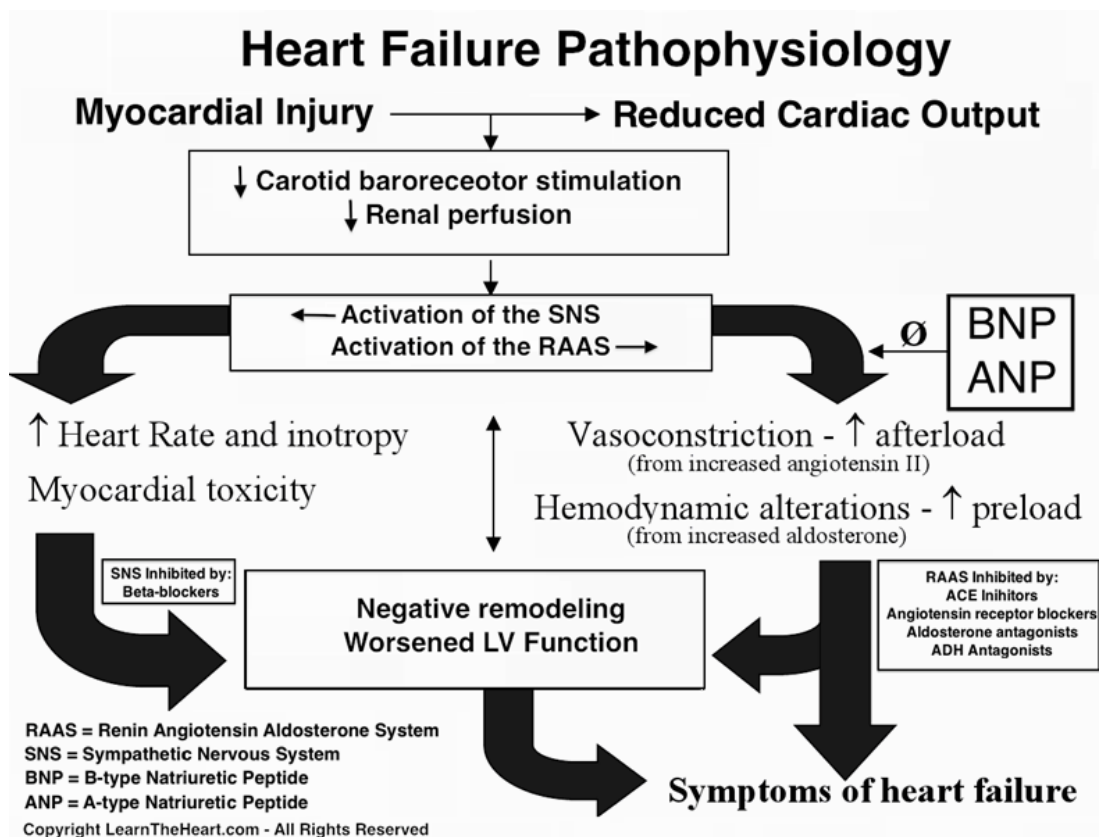

Figure 2.1 Pathophysiology of heart failure

The underlying mechanisms involved in the pathophysiology of CHF (depicted in Fig 2.1) have been investigated from many different viewpoints over the last 50-60 years, which has led to various theories emerging, these theories are often referred to as “models”. (Katz and Konstam, 2008)

2.5.1 The Haemodynamic Model

In the late 1960's, Braunwald et al defined CHF as "*a clinical syndrome characterized by well-known symptoms and physical signs. . . . [It is] the pathological state in which an abnormality of myocardial function is responsible for the failure of the heart to pump blood at a rate commensurate with the requirements of the metabolizing tissues during ordinary activity*".(Braunwald et al., 1967) Evidence for the hemodynamic model of CHF came from both animal models, and human work, showing that CHF as a result of pressure overload results in reduction in contractility of cardiac myocytes.(Spann et al., 1967, van Der Velden et al., 2001)

Haemodynamic changes in CHF can result from ventricular remodelling – which varies depending on the type of CHF in relation to ventricular function.(van Heerebeek et al., 2006) In patients with HFrEF, the LV cavity is often dilated, and there can be reduced LV mass. Both cardiomyocyte diameter and myocyte density are reduced in HFREF.(Borbély et al., 2005) In contrast patients with HFPEF usually have normal LV volume and LV wall hypertrophy, and as a result LV mass is increased.(Ohtani et al., 2012).

The extracellular matrix (ECM) is often described as the scaffolding, or internal skeleton, of the ventricles(Owen and Spinale, 2010) as and such is an important determinant of ventricular structure and function. Following MI, remodelling of the ECM occurs with replacement fibrosis.(Gandhi et al., 2011) This can result in thinning of the LV wall and impairment of LV pump

function. Fibrosis can also be stimulated by persistent activation of the renin-angiotensin-aldosterone system.(Creemers and Pinto, 2010)

2.5.2 Cardio-renal model

Renal sodium and water retention are important mechanisms of the CHF syndrome - they play a critical role in the development of two fundamental symptoms of heart failure - shortness of breath and oedema. This realisation led the development of the cardio-renal model of HF. Diuretics and dietary sodium restriction are mainstays in CHF management, however intensive diuretic therapy can lead to renal failure which associated with high mortality.(Braunwald, 2013)

2.5.3 Neuro-hormonal model

Activation of the adrenergic nervous system plays an important part in increasing cardiac performance during increased demand. The adrenergic nervous system modulates myocardial contractility and redistributes blood flow to areas of demand.(Braunwald et al., 1967, Braunwald et al., 1963) In acute HF reduced cardiac output stimulates the adrenergic system to enhance cardiac and increase vasoconstriction, which raises blood pressure adding perfusion of vital organs. Prolonged activation of the adrenergic nervous system and renin-angiotensin-aldosterone is deleterious to the cardiovascular system, resulting in remodelling of the ventricles and myocardial injury. A vicious cycle begins in what has become known as the

neuro-hormonal model of HF. Blockade of these systems made their significance clear, when it was realised that blocking them improves survival in CHF patients.(Braunwald, 2013)

2.5.4 Abnormal Ca^{2+} cycling model

The significance of the contribution of Calcium (Ca^{2+}) to cardiac contraction has been known since the work of Ringer in the early 1880's.(Ringer, 1883)

Dysregulation of Ca^{2+} fluxes are thought to be fundamental to the reduced cardiac contractility that occurs in some types CHF. (Braunwald, 2013)

Abnormalities in Ca^{2+} handling has been established in some types of HF. A Ca^{2+} leak in diastole lowers the Ca^{2+} content of the Sarcoplasmic Reticulum, which reduces the amount of Ca^{2+} that is released during activation, which in turn reduces cardiac contractility.(Belevych et al., 2011)

A further abnormality of Ca^{2+} fluxes that may affect cardiac function is reduced function of the SERCA2a pump. This reduces the Ca^{2+} concentration of the cardiac SR and therefore the amount of Ca^{2+} available for release during myocyte activation – resulting in ventricular systolic dysfunction and ventricular tachyarrhythmias.(Chen et al., 2004)

This impairment in SERCA2a pump function reduces both the speed and quantity of Ca^{2+} removal from the cytoplasm, this reduces ventricular relaxation, causing diastolic dysfunction.(Braunwald, 2013)

2.5.4 Cell death model

All types of HF are characterized by an increased rate of cell death or Apoptosis.(Konstantinidis et al., 2012) Apoptosis has been accredited to a number of stresses, such as increased levels of neurohormones; increased adrenergic activity; inflammation; oxidative stress; toxins, such as alcohol or cancer chemotherapeutic agents; and infiltrative processes. Apoptosis usually increases with aging and can also be increased under pressure overload. It is proposed that reduction of myocytes over time leads to CHF.(Olivetti et al., 1997)

2.5.5 Genetic model

A number of important genetic disorders have been discovered which have led to the genetic model of CHF.(Morita et al., 2005, Herman et al., 2012) Currently, the focus of genetics work is on examining the entire genome using genome-wide association studies.(Zeller et al., 2012) As CHF is a syndrome, genome-wide association studies are designed to search for associations with conditions which lead to CHF such as IHD, HTN, hyperlipidaemia, and diabetes mellitus.(Schunkert et al., 2011)

2.6 Management of CHF

This section will focus on the management of heart failure due to LVSD. The objectives of treatment in patients with heart failure are to improve symptoms, quality of life, and functional capacity, prevent hospitalisation and reduce mortality.(Ponikowski et al., 2016)

2.6.1 General Management of CHF

Most general advice given to patients upon a diagnosis of CHF is not evidence based. I have used the guidelines published by the European Society of Cardiology working group on heart failure.(Ponikowski et al., 2016)

2.6.1.1 Diet

Patients with heart failure should eat a healthy, well-balanced diet. Care should be taken to reduce salt intake. Patients on warfarin should be warned that alcohol consumption and changes in diet may result in loss of anti-coagulant control.

2.6.1.2 Exercise

Patients should be encouraged to take regular exercise. Exercise has several benefits. Improved cardiovascular fitness will improve exertional capacity, help to minimise/reduce muscle wasting and could possibly improve prognosis. Traditionally, reduced function of the heart as a pump has been viewed as the sole cause of CHF. However, work over the last 20 years suggests CHF as a complex pathophysiology initiated with cardiac dysfunction, which then involves adaptive changes in the musculoskeletal, neuroendocrine, cardiovascular, renal, haemostatic, inflammatory, and immune systems.(Piepoli and Coats, 2013)

The CHF syndrome is characterized by haemodynamic adaptation in the cardiovascular system, sympathetic activation, heightened immune response, systemic inflammation, and increased catabolism.(Piepoli and Coats, 2013) The physical deconditioning that occurs among CHF patients, along with increased catabolism, contributes to loss of muscle mass, which in turn adds to the decline in physical capacity seen in CHF over time. Furthermore, the chronic systemic inflammation seen in CHF changes skeletal muscle function and promotes muscle atrophy, which further contributes to reduced physical capacity.(Mann, 2002, Piepoli et al., 2010)

Patients with CHF display an insufficient peripheral blood flow response to both exercise and pharmacologically induced vasodilatation.(Zelis et al., 1975) thought to be due to ongoing vasoconstrictor drive, oedema of vessel walls, reduced peripheral vasculature, an impaired nitric oxide vasodilator system or heightened response of the vasoconstrictor endothelium system. (Drexler et al., 1993, Coats, 1996)

The only therapy shown to improve functional capacity and reverse peripheral abnormalities in CHF is exercise training. And through exercise training, increases in skeletal muscle mass, mitochondrial function and density, and changes in skeletal muscle fibre type have been identified in patients with CHF.(Adamopoulos et al., 1993)

Increases in physical activity are reported to reduce the risk of CHF hospitalisation whilst there does seem to be a dose response with physical activity beyond guideline recommendations achieving more significant reductions in CHF risk.(Pandey et al., 2015) Regular physical activity may

contribute to the reduction of other modifiable risks of CHF such as obesity and insulin resistance.(Kenchiah et al., 2002)

2.6.1.3 Travel

Patients with CHF are at increased risk of venous thrombosis if inactive during long periods whilst travelling, and changes in diet and climate may effect diuretic and anti-coagulant requirements. Advice should include keeping sensibly hydrated and mobile during long journeys taking plenty of breaks.

2.6.1.4 Smoking

Smoking is a strong independent predictor of morbidity and mortality in patients with LVSD, whilst smoking cessation has a significant effect on reducing morbidity and mortality in patients with LVSD.(Suskin et al., 2001)

2.6.1.5 Alcohol consumption

There is a U-shaped relationship between alcohol intake and the risk of developing CHF. The lowest risk is associated with modest alcohol consumption.(Dorans et al., 2015, Goncalves et al., 2015, Larsson et al., 2015) Whilst acute alcohol reduces cardiomyocyte contractility, it also leads to chronic changes including apoptosis, interstitial fibrosis eventually leading to an alcohol-induced cardiomyopathy.

2.6.2 Modification of risk factors to prevent CHF

Substantial evidence exists that developing HF may be preventable or delayed through modification of risk factors, or treating asymptomatic LV systolic dysfunction.

Control of hypertension can delay the onset of developing HF and may increase longevity.(Kostis et al., 1997, Beckett et al., 2008, Sciarretta et al., 2011, Wright et al., 2015) Recently, the SPRINT study has shown that treating hypertension to a lower goal of systolic blood pressure (SBP) <120 mmHg vs. <140 mmHg in older (≥ 75 yrs), or high-risk subjects with hypertension, reduces the risk of cardiovascular disease, mortality and hospitalization for HF.(Wright et al., 2015)

In patients with IHD, without LV systolic dysfunction or HF, angiotensin converting enzyme inhibitors (ACEI) prevent or delay the onset of HF and reduce cardiovascular and all-cause mortality.(Dagenais et al., 2006) Up-titration of beta-blockers (BB) and renin–angiotensin system antagonists to maximum tolerated dosages may improve outcomes in patients with IHD, without HF and elevated plasma natriuretic peptides.(Ledwidge et al., 2013, Huelsmann et al., 2013)

Primary percutaneous coronary intervention (PPCI) for ST segment elevation myocardial infarction (STEMI) reduces the risk of developing a substantial reduction in LVEF and development of LVSD and

CHF.(Windecker et al., 2014) Following an MI, particularly with associated LVSD, commencing an ACEI, a BB and a mineralocorticoid receptor antagonist (MRA), reduces CHF hospitalization and mortality.(Jong et al., 2003, Pfeffer et al., 1992, Dargie, 2001, Montalescot et al., 2014, Pitt et al., 2003) HMG-CoA reductase inhibitors (known as 'statins') also reduce the frequency of development of CHF.(Scirica et al., 2006, Kjekshus et al., 1997, Afilalo et al., 2007)

2.7 Pharmacological therapy of CHF

2.7.1 Angiotensin-converting enzyme inhibitors (ACEI)

Angiotensin converting enzyme inhibitors (ACEI) inhibit the conversion of inactive angiotensin I to the active angiotensin II, which has vasoconstrictive, salt-retentive, and hypertrophic properties. ACEI also inhibit the kininase enzyme, which is involved in bradykinin degradation,(Brown and Vaughan, 1998) the product of heightened renin-angiotensin system activity due to CHF and diuretic use. As a result there is arterial and venous dilatation, a slight drop in arterial blood pressure and improved renal blood flow. Blockade of these systems has favourable effects on cardiac and vascular structural remodelling.

ACEIs are recommended in all patients with symptomatic CHF and LVSD where tolerated, based upon evidence of their efficacy in reducing mortality and morbidity, both in CHF (1987, 1992, Garg and Yusuf, 1995, Packer et al., 1999) and in acute LVSD following an MI for example.(1993, Pfeffer et

al., 1992, Kober et al., 1995) ACEIs should be up-titrated to the maximum tolerated dose to achieve inhibition of the renin–angiotensin–aldosterone system (RAAS).(Packer et al., 1999) Despite overwhelming evidence in support of ACEI use in CHF with LVSD and a dose response relationship,(Packer et al., 1999) there remains inadequate up-titration of ACEIs in normal clinical practice.(Maggioni et al., 2013a)

2.7.2 Adrenergic receptor antagonists (beta-blockers)

CHF is a state of chronic sympathetic nervous system activation, which increases heart rate, causes vasoconstriction, increases adverse remodelling, provokes arrhythmia and stimulates renin-angiotensin system activation and hypokalaemia.(Cleland et al., 1996) Persistently heightened sympathetic activation is predictive of a worse outcome, and is potentially causal.(Cleland et al., 1996, Cohn et al., 1984) β -adrenoceptor antagonists (BB) interfere with the effects of adrenaline and noradrenaline on β -receptors, and therefore lower sympathetic nervous system activation. These agents, specifically those that block the beta-1 receptor improve many of the aspects of sympathetic activation, although agents that block a wider range of receptors may be more effective.(Poole-Wilson et al., 2003a, Poole-Wilson et al., 2002)

In patients with symptomatic CHF due to LVSD BB reduce mortality and morbidity, on top of the effects due to ACEI and diuretic therapy.(Hjalmarson et al., 2000, Packer et al., 2001, 1999b, 1999a, Flather et al., 2005) Patients

admitted with acute, decompensated heart failure should be commenced on a BB cautiously, but the agents are beneficial even in patients with persistent fluid overload or acute heart failure.(Packer et al., 2001) Guidance suggests that beta-blockers and ACEIs can be started together as soon as the diagnosis of CHF is made. No evidence exists supporting commencing of a BB before an ACEI has been started, and it generally makes little difference which come first,(Krum et al., 2011) unless there is a contraindication to ACEI therapy.(Willenheimer et al., 2005)

BB should be commenced at low dose, and gradually up-titrated to maximum tolerated dose with regular monitoring of heart rate and blood pressure.

2.7.3 Mineralocorticoid/aldosterone receptor antagonists (MRAs)

The MRAs, spironolactone and eplerenone, block the receptors that bind aldosterone and other steroid hormone receptors. MRAs are recommended in all symptomatic patients with CHF and LVEF $\leq 35\%$, alongside ACEIs and beta-blockers to reduce mortality and heart failure hospitalization.(Pitt et al., 2003, Zannad et al., 2011) Close monitoring of potassium levels and renal function is recommended in those taking MRAs, with caution recommended in those with serum potassium levels >5.0 mmol/L.

2.7.4 Loop and thiazide diuretics

Diuretics are recommended to manage the symptoms of CHF associated with fluid and salt retention, such as shortness of breath and peripheral and pulmonary oedema, and are shown to provide symptomatic relief.(Faris et al., 2002) Meta analyses have shown that in patients with chronic HF, when compared with placebo both loop and thiazide diuretics appear to reduce mortality and deteriorating HF and appear to improve exercise capacity,(Faris et al., 2012, Faris et al., 2002) although diuretics are yet to be tested in an RCT.(Ponikowski et al., 2016)

Diuretics are divided into 'loop' or thiazide diuretics. Loop diuretics are the diuretics used most commonly in CHF. They work on the Loop of Henle and result in a very powerful diuresis over 4-8 hours. Thiazide diuretics are less potent but are longer acting than loop diuretics, they are more likely to cause hypokalaemia than loop diuretics. Loop and thiazide diuretics can be used together in patients with severe CHF and resistance to loop diuretics. The addition of a thiazide diuretic can provoke an extremely marked diuresis.(Channer et al., 1994) Careful monitoring of renal function is advised when loop and thiazide diuretics are combined due to the increased risk of dehydration and renal dysfunction.(Ponikowski et al., 2016)

2.7.5 Angiotensin receptor neprilysin inhibitor (ARNI)

Angiotensin receptor neprilysin inhibitors are a new class of agents that have been developed that act on the renin angiotensin aldosterone system (RAAS) and the neutral endopeptidase system. The first is LCZ696, which

combines a portion of valsartan and sacubitril (a neprilysin inhibitor) as a single substance. Inhibiting neprilysin slows down the degradation of natriuretic peptides, bradykinin and other peptides. High circulating A-type natriuretic peptide (ANP) and BNP enhances diuresis, natriuresis, myocardial relaxation and prevent LV remodelling. Renin and aldosterone secretion are also inhibited by ANP and BNP. Selective AT1-receptor blockade moderates vasoconstriction and reduces sodium and water retention and reduces myocardial hypertrophy.(King et al., 2015, Mangiafico et al., 2013)

A trial investigating the long-term effects of ARNIs (sacubitril/valsartan) compared with an ACEI (enalapril) showed the superiority of sacubitril/valsartan in reducing all-cause mortality, cardiovascular mortality and hospitalizations for worsening CHF. This was in a specific population of ambulatory patients with symptomatic heart failure, with LVEF $\leq 35\%$, elevated plasma BNP levels, and an estimated GFR (eGFR) ≥ 30 mL/min/1.73 m² of body surface area, who were able to tolerate both enalapril (10 mg *b.i.d.*) and sacubitril/valsartan (97/103 mg *b.i.d.*) at separate treatment points.(McMurray et al., 2014)

2.7.6 *I_f*-channel inhibitor

Ivabradine inhibits the *I_f* channel in the sinus node and slows the heart rate without appreciable effects on blood pressure. Because of its specific action on the sinus node, it is only useful in patients in sinus rhythm. Ivabradine reduced the combined endpoint of mortality or hospitalization for patients

with symptomatic heart failure and LVEF $\leq 35\%$, with a heart rate of ≥ 70 bpm in SR, hospitalized for heart failure within the previous 12 months, and already on maximally tolerated doses of beta-blocker, an ACEI (or ARB) and an MRA.(Swedberg et al., 2010) Ivabradine is approved for use in patients with heart failure, LVEF $\leq 35\%$, in sinus rhythm with a resting heart rate ≥ 75 bpm, because of a survival benefit based on a subgroup analysis.(Bohm et al., 2013, Ponikowski et al., 2016)

2.7.7 Angiotensin II type I receptor blockers (ARBs)

ARBs are recommended as an alternative CHF therapy in those intolerant of an ACEI.(Granger et al., 2003) Candesartan has been shown to reduce cardiovascular mortality in a randomised trial,(Granger et al., 2003) and Valsartan showed a reduction in heart failure hospitalization in patients with CHF and LVSD on ACEIs. (Cohn and Tognoni, 2001) Combined ACEI/ARB therapy for CHF, which can lead to marked hyperkalaemia, is only useful in patients where other therapies are not tolerated or contra-indicated. Consequently, ARBs are indicated only in those intolerant of an ACEI. Combined ACEI/ARB should only be considered, under close supervision, in patients with symptomatic CHF receiving a BB and intolerant of an MRA.(Ponikowski et al., 2016)

2.7.8 Digoxin

Digoxin has been used for the treatment of CHF for over 2 centuries. It has mild inotropic and diuretic properties, moderates neuro-endocrine function and slows atrio-ventricular conduction.(Slatton et al., 1997, Gheorghide et

al., 1995, Krum et al., 1995) Digoxin is predominantly used in CHF to modulate ventricular rate in patients with AF, but is only recommended when other available treatments are not an option.(Khand et al., 2002, Vamos et al., 2015, Van Gelder et al., 2010, Bavishi et al., 2015, Freeman et al., 2015, Washam et al., 2015) The effects of digoxin in patients in AF and CHF have not been studied in RCTs, and recent evidence suggest potentially increased risk of mortality and CHF hospitalization. (Ouyang et al., 2015, Vamos et al., 2015) However, a recent meta-analysis of non-randomised studies concluded that digoxin has no adverse effect on mortality in patients with CHF in AF.(Ziff et al., 2015)

Digoxin may be used in patients with symptomatic CHF in SR to reduce the risk of all-cause and heart failure hospitalization,(1997b) and also to improve symptoms,(Packer et al., 1993) but digoxin has no effect on mortality when used in conjunction with an ACEI.(1997b)

The most effective dose of digoxin is uncertain. Low doses are mildly positively inotropic,(Slatton et al., 1997, Gheorghide et al., 1995, Krum et al., 1995, van Veldhuisen et al., 1995) while higher doses, those usually reserved for rate control, can be associated with side effects such as arrhythmia, nausea, vomiting, confusion, and sudden death.(Rathore et al., 2002)

2.7.9 Anti-arrhythmic agents

Patients with heart failure, particularly those with ischaemic aetiology, are at increased risk of ventricular tachyarrhythmia and sudden cardiac death. Despite this, anti-arrhythmic agents do not improve survival in patients with CHF.(Bardy et al., 2005) Amiodarone, in combination with a beta-blocker, can be used to reduce the frequency and duration of symptomatic ventricular arrhythmias, but may have a negative impact on survival in those with severe CHF.(Bardy et al., 2005) (Torp-Pedersen et al., 2007) As such, other than beta-blockers, amiodarone and dofetilide, anti-arrhythmic agents are contra-indicated in CHF, due to increased risk of worsening heart failure and sudden death.(Kober et al., 2008, Torp-Pedersen et al., 2007)

The best method for reducing ventricular arrhythmia in patients with CHF may be through optimisation of medical therapy including ACEIs, BB, MRAs and sacubitril/valsartan, which all reduce the risk of sudden death.(Pitt et al., 1999, Kotecha et al., 2014, Cleland et al., 1999, Desai et al., 2015)

2.8 Devices

2.8.1 Implantable cardioverter-defibrillator (ICD)

Cardiovascular mortality has decreased, due to the adoption of improved preventive and treatment practices to reduce the burden of coronary artery disease (CAD) and CHF, in high-income countries in the last 20

years.(Niemeijer et al., 2015, Priori et al., 2015) Despite this, cardiovascular disease remains responsible for approximately 17 million deaths each year worldwide, of which around 25% are sudden cardiac deaths (SCD).(Priori et al., 2015) Men are at higher risk of SCD than women, and the risk of SCD increases with age due to higher prevalence of CAD.(Eckart et al., 2011) The mortality rate from SCD is estimated to range from 1.40 per 100 000 person-years [95% confidence interval (CI) 0.95, 1.98] in women to 6.68 per 100 000 person-years (95% CI 6.24, 7.14) in men.(Eckart et al., 2011)

Around 40% of patients with CHF suffer sudden or unexplained death.(Poole-Wilson et al., 2003b) This may be as a result of brady or tachyarrhythmias, but can also be due to coronary, vascular or cerebrovascular episodes. Medical therapy can improve, or reduce the deterioration, of cardiovascular function which can reduce the incidence of sudden death, but cannot treat arrhythmias should they occur. Antiarrhythmic medications can reduce the frequency and burden of tachy-arrhythmias, but can in fact worsen overall mortality.(Ponikowski et al., 2016) ICDs on the other hand treat both brady- and tachy-arrhythmia and could therefore reduce sudden cardiac death.

2.8.2 Primary prevention ICD

2.8.2.1 Where ICDs are proven to be of benefit

A primary prevention ICD implantation is recommended in patients with CHF and LVSD, without documented ventricular arrhythmia, deemed to be at risk

of sudden cardiac death. Implantation of an ICD is recommended only when optimal medical therapy has failed to increase the LVEF above 35%.(Ponikowski et al., 2016) The cut-off for ejection fraction is controversial, since the manuscripts on which the ESC guidelines are based included only 400 people with LVEF 30-35%.(Ponikowski et al., 2016)

Despite this slight controversy, overall ICDs reduce the incidence of sudden arrhythmic death in patients with CHF and LVSD.(Theuns et al., 2010, Cook and Ridker, 2009) However, in patients with moderate or severe heart failure, this is usually offset by an increased incidence of death due to deteriorating CHF.(Bardy et al., 2005) ICDs are most cost-effective in patients with important LVSD, but mild symptoms where for every 100 implants, 2 deaths per year are prevented.(Bardy et al., 2005) The benefit of ICD implantation is greater in those with CHF and ischaemic aetiology, rather than those with DCM, as patients with ischemic aetiology are at greater risk of sudden cardiac death.(Theuns et al., 2010) Patients with heart failure, LVSD and a long QRS duration are also at increased risk, although these patients are also usually offered cardiac resynchronisation therapy (CRT).(Bardy et al., 2005, Moss et al., 1996)

2.8.2.2 Where ICDs are not proven to be of benefit

ICD's are of no benefit, within 40 days after an MI. Although sudden cardiac death is reduced, overall mortality is not, demonstrating clearly how deteriorating severe LVSD is a pre-terminal state and that treating arrhythmia is merely converting the nature of the death. In the studies that

have been carried out, preventing death due to arrhythmia merely increased death due to cardiogenic shock and heart failure.(Hohnloser et al., 2004, Steinbeck et al., 2009) A patient at particularly high risk of sudden arrhythmic death in whom contractile recovery is expected, could be offered a wearable defibrillator, for example, patients awaiting cardiac transplantation,(Opreanu et al., 2015) or patients with LVEF <35% following surgical or percutaneous coronary revascularisation.(Zishiri et al., 2013) A lack of data from randomised trials means there is a limited evidence base for their use.

ICD implantation is not recommended in NYHA Class IV patients with symptoms unresponsive to medical therapy, and unsuitable for CRT, a ventricular assist device or cardiac transplant, as such patients have significant risk of dying from pump failure.(Ponikowski et al., 2016) ICD therapy is unlikely to provide any benefit in patients with significant co-morbidities that might die within a year from these rather than their CHF.(Sanders et al., 2005, Steinberg et al., 2014, Raphael et al., 2015, Miller et al., 2015)

2.8.2.3 Practical issues around ICD therapy

Before ICD implantation, patients should receive counselling regarding the reason for implantation, and also potential complications such as inappropriate therapy and implant complications such as infection and bleeding. Patients should also receive counselling around deactivation of

therapies when their heart failure gets worse, or they develop other important life threatening conditions.(Stewart et al., 2010)

ICD's should be programmed with long detection intervals,(Moss et al., 2012) which reduces the risk of inappropriate therapy and also appropriate but unnecessary therapy for non-sustained ventricular tachycardia.(Moss et al., 2012, Gasparini et al., 2013, Cleland and Buga, 2010)

2.8.2.4 What happens when the battery is flat?

In the same way as drug treatment is reviewed, ICD treatment should be reconsidered at each appointment and certainly at the time of generator replacement. A procedure to replace an ICD generator due to battery depletion should follow a thorough assessment of the patient and the indication for ICD therapy. Controversy surrounds whether patients with an improvement of LVEF to >35% who have not required their device should receive a replacement device when the original generator has depleted.(Merchant et al., 2014, Yap et al., 2014, Kini et al., 2014, Erkapic et al., 2013, Alsheikh-Ali et al., 2008)

2.8.2.5 New developments in ICD therapy

By avoiding trans-venous leads and the intravascular complications associated with them, subcutaneous ICDs have some advantages over standard trans-venous systems and may be as effective at treating shockable ventricular arrhythmias.(Bardy et al., 2010, Aziz et al., 2014) They can be used in patients with difficult or absent venous access, but caution

should be taken in patient selection due to their inability to treat bradyarrhythmia, provide CRT or anti-tachycardia pacing (ATP). More robust evidence from RCTs, around the performance of these devices, is required.(Olde Nordkamp et al., 2012, Burke et al., 2015)

2.8.3 Secondary prevention ICD

In survivors of cardiac arrest, and in those that have had symptomatic sustained ventricular arrhythmia, ICDs reduce mortality when compared with amiodarone, and should be considered when the intention is to improve survival.(Ponikowski et al., 2016) When considering an ICD implant the patient should be counselled, and their quality of life, LVEF (survival benefit is unproven with LVEF >35%) and existing life-limiting co-morbidities should be considered.(Ponikowski et al., 2016, 1997a, Connolly et al., 2000b, Connolly et al., 2000a)

2.8.4 Cardiac resynchronisation therapy (CRT)

CRT implantation improves cardiac function, heart failure symptoms, quality of life and mortality and morbidity in specific individuals.(Sohaib et al., 2015, Cleland et al., 2013)

2.8.4.1 Prevalence and effect of conduction delay

Normal left ventricular myocardial contraction is coordinated through specialised cardiomyocytes including the Purkinje conduction fibres and results in a synchronous contraction of the left ventricular myocardium.(Kirk

and Kass, 2013a) This coordinated conduction and contraction pattern may be impaired by disease of the conduction system or myocardium, (e.g. LBBB) or by stimulation of contraction outside of the normal conduction system (e.g. RV pacing).(Kirk and Kass, 2013a) Any disruption of the normal conduction system can result in altered LV contraction due to dyssynchronous contraction. In such instances, overall LV contraction becomes un-coordinated and inefficient. This results in a reduction in LV systolic function.(Kirk and Kass, 2013a, Burkhoff et al., 1986, Park et al., 1985)

Almost 50% of patients with CHF and LVSD have ventricular conduction delays, such as LBBB.(Schuster et al., 2005, Ghio et al., 2004) The dyssynchrony that occurs as a result creates significant regional difference in myocardial work,(Vernooy et al., 2005) (Fig 2.1 A) the earliest activated regions have reduced work load, with the latest activated regions having increased work load, this is associated with regional changes in regional myocardial blood flow.(Prinzen et al., 1999, Rosen et al., 2009) Time differences between early and late activation sites result in a reduction in stroke volume (Fig 2.1 A).(Chakir et al., 2009) The greatest volume differences occur when the time differences in muscle activation are greatest, (Fig 2.1 B, shown by the arrows) during isovolumic contraction and late systole into early relaxation. Hence rate of pressure rise (dP/dt_{max}) and myocardial shortening after aortic valve closure are frequently used and sensitive measures of dyssynchrony. The overall effect of dyssynchrony on LV function, when viewed by pressure–volume loops,(Park et al.,

1985) reveal a rightwards shift of the end-systolic pressure–volume relationship (Figure 2.1 C). Stroke volume (represented by loop width) and stroke work (represented by loop area) decline in the presence of dyssynchrony.(Kirk and Kass, 2013b) The effect is particularly relevant in the presence of LV systolic dysfunction, where dyssynchrony compounds the situation, worsening morbidity and mortality.(Bader et al., 2004)

Dyssynchronous contraction has little impact on cardiac function in those with normal heart function.(Kirk and Kass, 2013b) However, since the 1990's dyssynchrony and its short-term effects on cardiac output, and long-term effects on cardiac function led to the concept that pacing might be able to improve conduction delay and reduce dyssynchrony. Ground-breaking studies by Cazeau et al, Auricchio et al, and Kass et al (Cazeau et al., 1994, Auricchio et al., 1999, Kass et al., 1999) demonstrated the beneficial effects of multisite pacing in patients, leading to the development of cardiac resynchronization therapy (CRT), credited as being the first method of improving cardiac function via the use of artificial electrical stimulation.(Kirk and Kass, 2013b)

2.8.4.2 How does CRT help?

CRT involves electrically stimulating the right and left ventricles simultaneously. This usually involves a pacemaker lead positioned in the right ventricular apex, or on the right ventricular septum, and a pacemaker lead positioned to stimulate the left ventricular free wall.(Kirk and Kass, 2013b) The left ventricular electrode is positioned via the coronary sinus,

into a lateral cardiac vein, thereby allowing simultaneous pacing, or, if required, optimised left and right timing.(Kirk and Kass, 2013b) The pacemaker is programmed to ensure biventricular stimulation occurs by having short atrio-ventricular delays. Individual optimization of the AV delay can improve LV systolic function in some patients, but devices are often set to default settings.(Spragg and Kass, 2006)

A lateral LV lead position, which is often where conduction is most delayed, may be one of the most important factors for successful cardiac resynchronisation therapy,(Kirk and Kass, 2013b) whilst an apical position may be detrimental. (Singh et al., 2011, Thebault et al., 2012, Wilton et al., 2014) Attempts have been made to identify the optimal LV lead position by using echocardiographic techniques to identify the latest region of LV activation. Two randomized studies have reported improved outcomes following heart failure hospitalization(Saba et al., 2013) and significant LV reverse remodelling(Khan et al., 2012) by using speckle-tracking echocardiography to guide LV lead placement to identify the latest activated LV segment.

Most commonly, there is simultaneous biventricular stimulation in CRT, promoting a more coordinated LV contraction, which may improve LV systolic function within 1 beat,(Kass et al., 1999) (Fig 2.2 C) and improves LV stroke volume and work (Fig 2.2 D). These improvements in LV haemodynamics are achieved with no increase in myocardial oxygen consumption at rest, indicating an important improvement in LV mechanical

efficiency,(Ukkonen et al., 2003, Nelson et al., 2000) (Fig 2.2 F). Other work has shown that CRT enhances coronary blood flow, improving both volume and velocity.(Kyriacou et al., 2012)

CRT reduces morbidity and mortality from CHF,(Cleland et al., 2005, Bristow et al., 2004) with the greatest effects seen in those patients with basal dyssynchrony.(Chalil et al., 2007, Gorcsan et al., 2010) On the other hand, implantation of CRT in those without LV dyssynchrony may be detrimental.(Auger et al., 2012)

2.8.4.3 Personalisation of CRT programming for most effect

Optimizing AV and VV delays in CRT can improve LV haemodynamics in some patients,(Kass et al., 1999, Spragg and Kass, 2006, Hay et al., 2004) but LV lead position and site of stimulation have the greatest influence on CRT performance.(Kirk and Kass, 2013b) Early RV stimulation creates an LBBB type ECG pattern and can exacerbate dyssynchrony, worsening LV dysfunction, hence frequently, the LV is stimulated first (creating an RBBB type ECG pattern).(Hay et al., 2004, Byrne et al., 2007, Mills et al., 2009) LV only pacing, with the LV lead positioned in the mid-lateral wall, may have similar haemodynamic benefits as biventricular pacing in patients with LBBB.(Kass et al., 1999, Boriani et al., 2012)

2.8.4.4 How does CRT work?

CRT is the only intervention that improves cardiac function both acutely and chronically whilst improving long-term survival.(Kirk and Kass, 2013b) CRT

was initially thought of as a purely mechanical therapy, and that resynchronising cardiac contraction would improve LV contraction and performance. This viewpoint focussed interest on methods to identify and measure dyssynchrony, such as QRS duration on the 12-lead ECG and later assessing dyssynchrony via trans-thoracic echocardiography using tissue-Doppler. The mechanical effects of CRT no doubt contribute to its clinical effectiveness, but mounting evidence backs molecular and cellular changes that CRT induces, which are likely protagonists as well. CRT influences a range of structural and signalling pathway changes which occur in heart failure.(Kirk and Kass, 2013b)

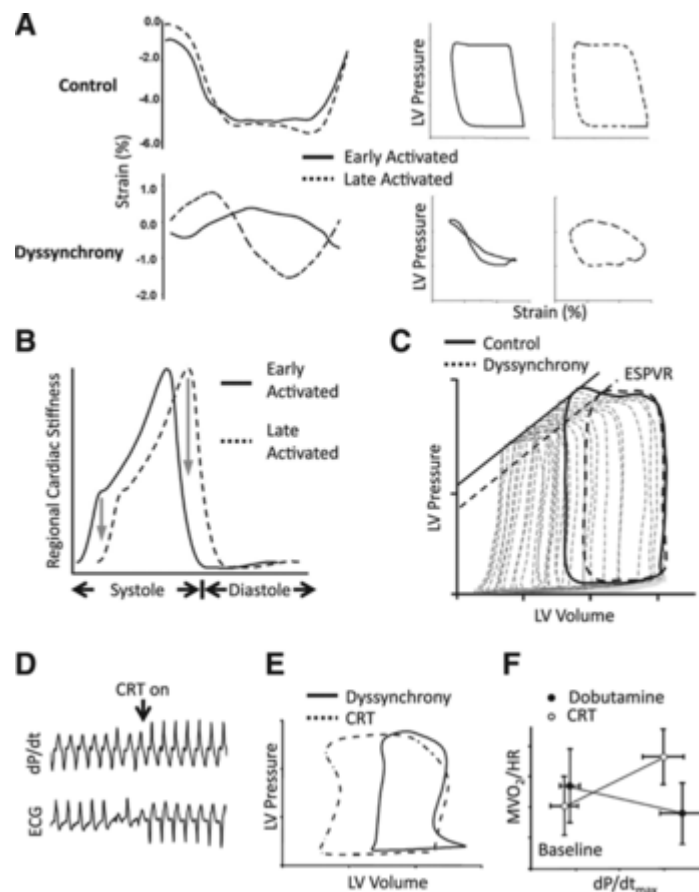

Figure 2.2 Regional and global pathophysiology of cardiac dyssynchrony, used with permission from Wolters Kluwer Health Inc.

CRT has been shown to improve functional mitral regurgitation (FMR), which is associated with worse outcome in those with DCM.(Cleland et al., 2005, van Bommel et al., 2011) FMR can be caused by LV chamber and mitral annular dilation causing poor coaptation of the mitral valve leaflets, papillary muscle dyssynchrony, and AV conduction delay which can worsen presystolic MR.(Brecker et al., 1992) CRT may reduce FMR by modulating each of these causes of FMR. A short AV delay reduces presystolic MR, improved LV synchrony reduces papillary muscle dyssynchrony and reductions in in LV volume reduce the effects of chamber and annular dilatation.(Murphy et al., 2006, Sutton et al., 2006) A small study of 34 patients with reduced FMR following CRT showed >90% have reduced chamber volumes, suggesting this as the major likely mechanism for reduced FMR in CRT patients.(Solis et al., 2009)

2.8.4.5 Does CRT work in everyone?

Around 30% of CRT recipients do not “respond” to CRT. Efforts to predict response have been made, but no definitive reason has been proven.(Sung and Foster, 2011, Delgado and Bax, 2011) The Predictors of Response to CRT (PROSPECT) trial set out to prospectively examine a number of routine and advanced echocardiographic techniques against markers of clinical response in 300 patients over a six month follow-up period. The primary outcomes were left ventricular reverse remodelling and improvement in the heart failure Clinical Composite Score. (Yu et al., 2005a) When examined, the trial revealed that *“no single echocardiographic measure of dyssynchrony may be recommended to improve patient selection for CRT beyond current guidelines”*. (Chung et al., 2008)

Whereas medication can be discontinued in people for whom they seem not to be beneficial, this is not possible with CRT. Once the device is implanted, the risks have been encountered and the money spent. This 'up front' issue unique to devices, drives the need to identify the recipients most likely to benefit beyond current knowledge. At present a 30% non-response rate and ambiguity over predictors of response beyond QRS duration suggest the true mechanism of response to CRT is not fully understood, and further investigation is required.

CRT primarily alters electric activation, which underlies the theory behind its use: that regional delay of activation can be reduced via coordinated activation through bi-ventricular stimulation.(Kirk and Kass, 2013b) A delay in electrical activation will result in a mechanical delay if electromechanical coupling is intact.(Russell et al., 2010) However, electromechanical association can also be affected through regional variation in wall stress, cardiac contractility, scarring or fibrosis.(Kirk and Kass, 2013b) Any form of uncoordinated contraction will worsen electromechanical delay in the regions which are activated latest and therefore usually exposed to the highest stress.(Russell et al., 2011, Kerckhoffs et al., 2012) Also, contraction can appear dyssynchronous even in the presence of normal electrical activation, due to regional variation in cardiac contractility,(Kass, 2008) for example, there is dyssynchronous right–left heart contraction in pulmonary hypertension,(Kalogeropoulos et al., 2008, Brili et al., 2013, Marcus et al., 2008) without prolonged QRS duration,(Marcus et al., 2008) in this situation

dyssynchrony is thought to occur due to higher RV wall stress. Differences in the timing of myocardial contraction following myocardial infarction can appear as dyssynchrony, though this is less likely to be improved by CRT.(Abd-Elmoniem et al., 2012)

2.8.4.6 Who do the guidelines say is eligible for CRT?

Current ESC guidelines for CRT implantation can be seen in Table 2.1 (adapted from ESC guidelines) and are largely based on QRS duration.(Ponikowski et al., 2016)

Table 2.1 Current ESC guidelines for CRT implantation

Recommendations	Class	Level
CRT is recommended for symptomatic HF patients in SR with a QRS duration \geq 150 msec and LBBB QRS morphology with LVEF \leq 35% despite OMT to improve symptoms and reduce morbidity and mortality.	I	A
CRT should be considered for symptomatic HF patients in SR with a QRS duration \geq 150 msec and non-LBBB QRS morphology with LVEF \leq 35% despite OMT to improve symptoms and reduce morbidity and mortality.	IIa	B
CRT is recommended for symptomatic HF patients with HF in SR with a QRS duration of 130-149 msec and non-LBBB QRS morphology with LVEF \leq 35% despite OMT to improve symptoms and reduce morbidity and mortality.	I	B
CRT may be considered for symptomatic HF patients in sinus rhythm with a QRS duration of 130-149 msec and non-LBBB QRS morphology with LVEF \leq 35% despite OMT to improve symptoms and reduce morbidity and mortality	IIIb	B
CRT rather than RV pacing is recommended for patients with HFrEF regardless of NYHA class, in SR or AF, with an indication for ventricular pacing and high degree AV block in order to reduce morbidity.	I	A
CRT should be considered for patients with LVEF \leq 35% in NYHA Class III-IV despite OMT to improve symptoms and reduce morbidity and mortality if they are in AF and have a QRS duration \geq 130 msec and good rate control to ensure bi-ventricular capture is in place or the patient is expected to return to sinus rhythm	IIa	B
Patients with HFrEF who have received an RV pacemaker or ICD and develop worsening HF despite OMT with a high proportion of RV pacing may be considered for upgrade to CRT. This does not apply to patients with stable HF	IIIb	B
CRT is contra-indicated in patients with a QRS duration $<$ 130 msec	III	A

2.8.4.7 Assessment of eligibility – does echocardiography help?

Although some studies have identified no relationship between QRS duration and variables of functional capacity or cardiac structural remodelling,(Yu et al., 2005b, Mollema et al., 2007) meta-analyses of 15 large CRT trials revealed that QRS duration predicts two-thirds of those who respond to CRT.(Bax and Gorcsan, 2009) Other measures of cardiac dyssynchrony have concentrated on regional wall motion delay.(Kirk and Kass, 2013b) Tissue-Doppler derived methods of dyssynchrony analysis showed initial promise,(Bax et al., 2004, Van Bommel et al., 2010) however, the multi-centre Predictors of Response to Cardiac Resynchronization Therapy (PROSPECT) trial showed significant variability in dyssynchrony assessment, and that tissue-Doppler derived dyssynchrony assessment had poor predictive value.(Chung et al., 2008) More recently, other methods of dyssynchrony assessment have emerged including speckle tracking via transthoracic echocardiography,(Delgado et al., 2008, Gorcsan et al., 2007, Lim et al., 2008, Tanaka et al., 2010) 3D transthoracic echocardiography,(Auger et al., 2011, Kleijn et al., 2012, Russo et al., 2012, Marsan et al., 2008) and dyssynchrony assessment using cardiac MRI techniques.(Bilchick et al., 2008, Budge et al., 2012, Marsan et al., 2009) The implications of 'de-selecting' people considered eligible on current standards are great so robust evidence is needed if any of these techniques to be widely accepted and used in the clinical setting.(Delgado and Bax, 2011, Sung and Foster, 2011) Equally, careful clinical and health economic assessments are required before selecting people who do not fulfil current indications for a CRT device.

Mechanical dyssynchrony in the absence of electrical dyssynchrony can occur in some patients with heart failure and a narrow QRS complex. CRT as a treatment in this situation has been suggested,(Achilli et al., 2003, Yu et al., 2006) however, recent multi-centre showed no benefit of CRT in narrow QRS,(Beshai et al., 2007, Thibault et al., 2013, Ruschitzka et al., 2013) with 2 trials terminated early due to futility and safety concerns.(Thibault et al., 2013, Ruschitzka et al., 2013) Methods of dyssynchrony evaluation exist which combine electric and mechanical parameters,(Ghosh et al., 2011, Ramanathan et al., 2004) but lack rigorous evidence from clinical trials.(Kirk and Kass, 2013b)

2.8.5 Upgrade of existing pacemakers to CRT

As discussed in chapter 1, patients with permanent RV pacemakers often develop left ventricular dysfunction and heart failure due to the dyssynchrony that the pacemaker induces. Internationally, 'upgrades' to CRT represent between 23–28% of all CRT implants,(Leclercq, 2008) despite the fact that this approach has been tested only in small, often non-randomised studies. However, overall, the results from the four small randomized, crossover trials are promising.(Leclercq, 2008, Delnoy et al., 2011, Hoijer et al., 2006, van Geldorp et al., 2010) All of the trials had a similar design - periods of between 2–6 months duration of CRT was compared with periods of between 2–6 months of RV pacing. All participants had conventional RV pacing indications for bradycardia (mainly AV block), severe CHF symptoms (NYHA class III or IV) and LVEF <40%. When compared with the RV pacing

period, patients experienced fewer hospitalisations, improved LV function and improved symptoms during the CRT pacing period.

The results from the randomised studies presented above are similar to those arising from several small longitudinal observational studies. In these observational studies, patients were upgraded to CRT due to worsening of CHF symptoms and deterioration of LV function associated with significant periods and volumes of RV pacing. (Baker et al., 2002, Eldadah et al., 2006, Laurenzi et al., 2007, Leon et al., 2002, Shimano et al., 2007, Valls-Bertault et al., 2004, Vatankulu et al., 2009) Almost all of the participants were in NYHA class III or IV, and had an LVEF of <35% at the time of upgrade. Patients showed significant clinical improvement, improved cardiac function and reduced symptoms during the follow-up periods which ranged from 1–20 months.

Despite the lack of definitive data from large randomised control trials, there is accumulating evidence that patients with high volumes of RV pacing, reduced LVEF and CHF symptoms should be upgraded to CRT.

Chapter 3. Methodology

My studies were designed to include surrogate endpoints of known prognostic value such as echocardiography, peak oxygen consumption (exercise capacity) and symptoms, as well as patient-orientated endpoints such as quality of life, symptoms and exercise capacity. In this chapter I shall describe the methodology for each endpoint and its relevance.

3.1 Transthoracic Echocardiography (TTE)

Transthoracic echocardiography, or cardiac ultrasound, is the term used when referring to cardiac imaging using ultrasound imaging techniques. This includes two and three-dimensional imaging, colour flow Doppler, continuous and pulsed wave Doppler, tissue Doppler imaging (TDI), myocardial deformation imaging (strain and strain rate) and contrast imaging. Transthoracic echocardiography (TTE) is the most frequently used method for cardiac and functional and structural assessment in patients with chronic heart failure (CHF), and most commonly focuses on LV size and systolic function.(Ponikowski et al., 2016, Lang et al., 2015)

3.1.2 Measurement of LV dimensions and volumes

Internal dimensions and volumes are the most frequently used variables to quantify LV cavity size. Measurements are made at specific points during the

cardiac cycle, usually end-diastole and end-systole, these dimensions can then be applied to equations used to derive parameters of LV function. (Lang et al., 2015) LV internal cavity and wall thickness dimensions should be measured in the parasternal long-axis view and measurements should be obtained at the level of the mitral valve leaflet tips. Dimensions can be obtained using M-mode imaging (Fig 3.1), or by using digital callipers (Fig 3.2). (Lang et al., 2015)

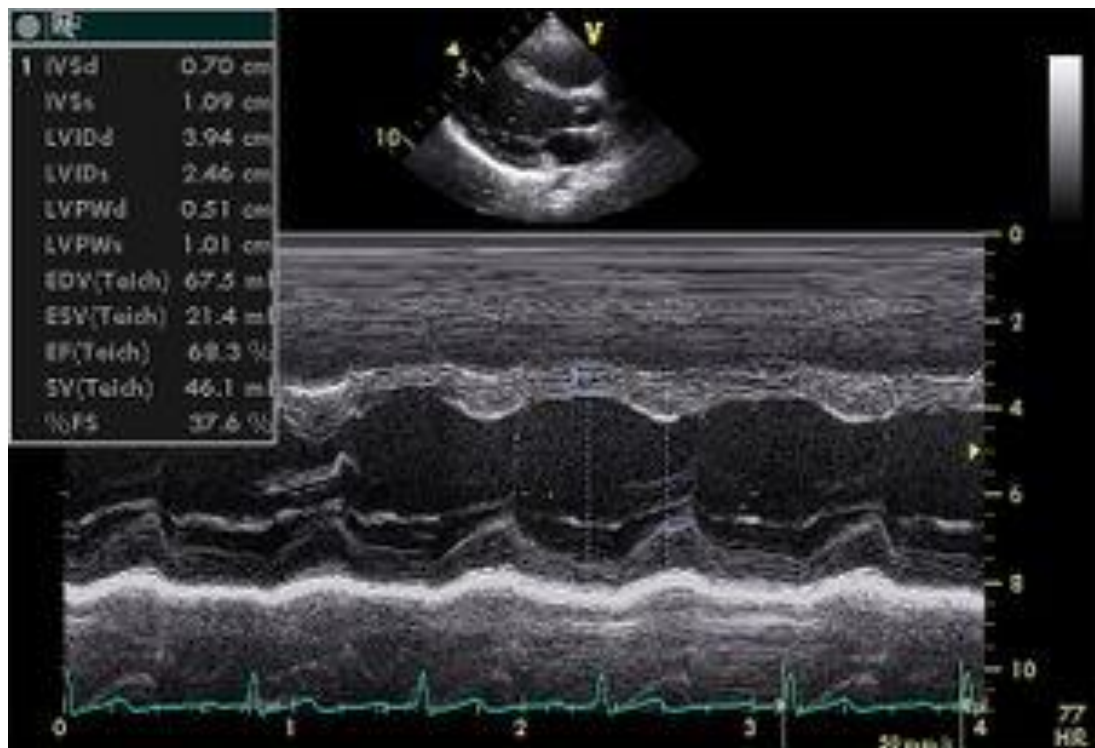

Figure 3.1 LV cavity dimension measurement using M-mode

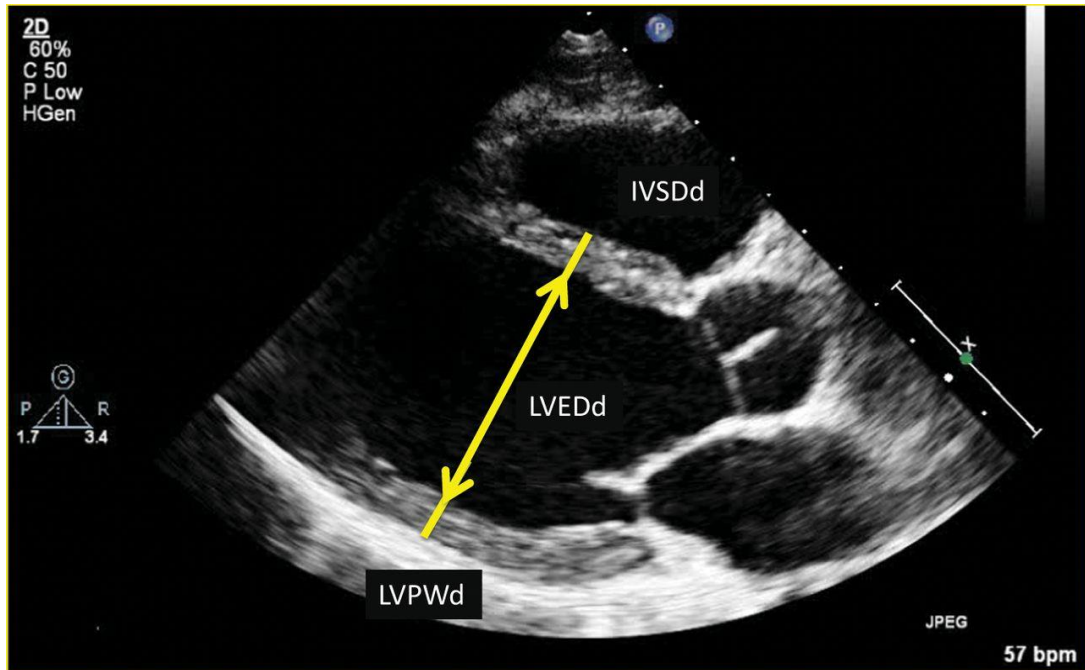

Figure 3.2 LV cavity dimension measurement using digital callipers

LV volumes can be measured using two or three dimensional echocardiography. Using linear measurements to calculate LV volumes is one method of measuring LV volumes, but they are considered inaccurate, as they rely on the assumption of a fixed geometric LV morphology. As such, the Teichholz and Quinones methods for measuring LV volumes are no longer recommended for clinical application.(Lang et al., 2015)

Volumetric measurements are made by tracing round the internal border of the interface between the LV cavity and the myocardium. LV length is defined as the distance between the internal myocardial border at the LV apex, and the midpoint of a line drawn across the mitral annulus. It is recommended that LV volumes are measured from the apical four- and two-chamber views.

3.1.3 Assessment of LV systolic function

The most commonly used method for measuring LV systolic function from 2 dimensional echocardiography is the left ventricular ejection fraction (LVEF), using the biplane method of disks summation (modified Simpson's rule) (Fig 3.3). For measurement of LVEF LV end diastolic volume (LVEDV) and LV end systolic volume (LVESV) are obtained from apical four- and two-chamber views. (Lang et al., 2015, Ponikowski et al., 2016)

An LVEF of <50% will be used to determine left ventricular systolic dysfunction, as this was consensus around the time of beginning the study and is most frequently used to distinguish between HFrEF and HFpEF.(Owan et al., 2006, Hogg et al., 2004, Owan and Redfield, 2005, Vasan et al., 1995) However, discussion exists around whether <50% or <55% is the most evidence based method determining left ventricular systolic dysfunction.(Mahadevan et al., 2008)

Doppler analysis can be used in the calculation of haemodynamic measurements, such as cardiac output and stroke volume, this is done using pulsed-wave Doppler in the left ventricular outflow tract (LVOT) using the velocity time integral method. (Lang et al., 2015, Ponikowski et al., 2016)

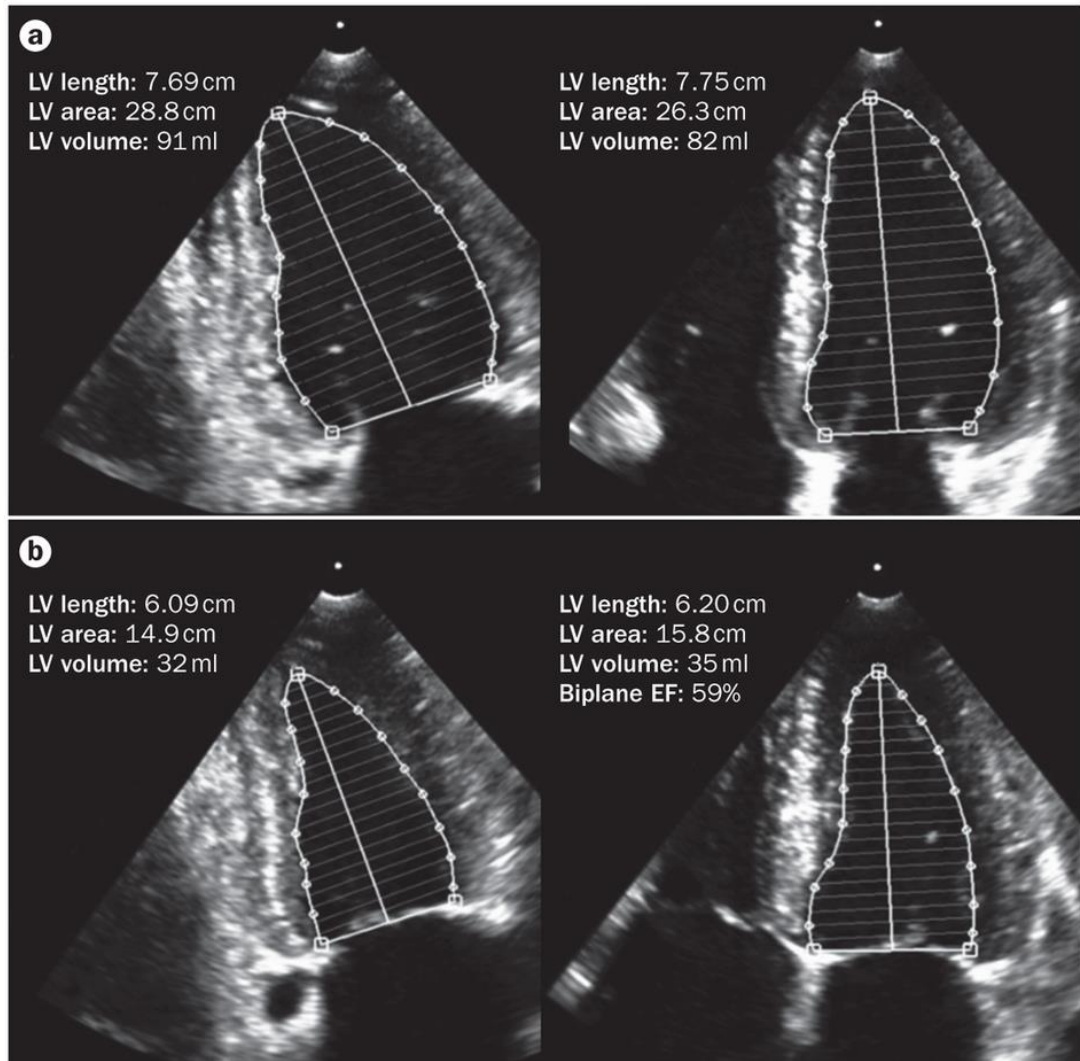

Figure 3.3 Simpson's Bi-plane method of measuring LVEF

3.1.4 Reliability of TTE

TTE is a widely accepted imaging modality in measuring cardiac structure and function,(Palmieri et al., 1999) however TTE, and particularly LVEF, is limited by test-retest reliability.(Palmieri et al., 1999) Because of this, in research scenarios a large sample size is required to detect change with confidence.(Kalogeropoulos et al., 2012) Factors which may limit image acquisition in TTE include insufficient training, sub-standard equipment, poor

imaging, technical ability of the sonographer, experience of the sonographer and patient body habitus, to name a few.(Himelman et al., 1988)

Therefore, acquiring accurate images in TTE, and in particular LVEF, relies upon operator skill and experience and image quality. To minimise variability it is recommended that cardiac ultrasound departments should aim for inter- and intra-operator variability for LVEF of 10%.(EACI, 2016) This should be achieved through the use of standard operating procedures, thereby ensuring standardisation among procedures.(EACI, 2016) To maintain consistency and to reduce inter and intra-observer variability the British, European and American societies of echocardiography recommend regular quality control and audit.((BSE), EACI, 2016)

3.2 Echocardiography protocol

All transthoracic echocardiographic assessments were carried out by the same British Society of Echocardiography (BSE) accredited sonographer, who collected datasets according to BSE guidelines.((BSE)) All participants had a full 2-dimensional transthoracic echocardiographic examination, with grey-scale and tissue Doppler images recorded. Images were obtained using a GE Vivid 7 ultrasound machine and stored offline, on the Echopac system, to allow offline analysis and measurements.

Left ventricular (LV) systolic function assessment was done using the modified Simpson's bi-plane method - the 2 dimensional end systolic and end diastolic LV areas were measured in orthogonal planes using the apical 4-chamber and 2-chamber views. Where relevant, the sonographer was blinded to the study arm and protocol, and the images requiring analysis were anonymised.

3.3 Formal exercise testing

Reduced exercise capacity, a common symptom in heart failure patients, occurs due to complex pathophysiological changes related to adverse changes in the complex relationship between peripheral and central systems involved in oxygen transport and utilisation during exertion. Formal exercise testing is recommended as part of comprehensive functional assessment, to allow exercise capacity to be measured objectively.

3.4 Assessing exercise capacity

Many methods of assessing exercise capacity are available. History taking, classification based on NYHA status and daily living questionnaires are all frequently used methods which give an impression of functional capacity and can be ascertained relatively easily. Symptoms relate modestly to objective measures of functional capacity, which suggests that patient reported symptoms may not be reliable measures of exercise intolerance,(ESC, 2001,

Wilson et al., 1999) and their use in assessing treatment effect may not be robust.(Arena et al., 2007)

3.4.1 Cardio-pulmonary exercise (CPX) testing

Exercise capacity in heart failure relies on a complex interplay between the neuro-hormonal, pulmonary and central and peripheral circulatory systems of the body.(ESC, 2001) The limitations of these systems, and an objective measure of exercise capacity, can be assessed by using cardio-pulmonary exercise (CPX) testing.

3.4.2 Introduction to CPX testing

CPX testing is recommended in patients with heart failure, to measure response to physical exertion. The results are used to assess severity of disease, prognosis and the effect of therapy.(Weber and Janicki, 1985, Myers and Gullestad, 1998, Cohn et al., 1993, Stelken et al., 1996, Chua et al., 1997, Stevenson et al., 1995, Guazzi et al., 1999, ESC, 2001)

An objective assessment of exercise capacity can be made using specific maximal and sub-maximal parameters. Several CPX parameters have been studied including peak oxygen uptake (pVO_2), oxygen uptake at anaerobic threshold (AT), exercise duration and the slope of ventilation vs. carbon dioxide production (VE/VCO_2 slope).(ESC, 2001) A familiarisation test is recommended when performing a CPX test in heart failure patients as results can vary, with one study requiring 11 tests to get reproducible

results.(Pinsky et al., 1990) Conversely, Witte et al found that following a familiarisation test, a peak CPX test is not a training stimulus, with reproducible results.(Witte et al., 2003) However, performing multiple familiarisation tests is impractical, and the most difference seems to occur between the first and second test, thought to be due to familiarisation with the equipment and technique.(ESC, 2001)

3.4.3 CPX test overview

Whilst performing a CPX test, individuals perform physical exertion whilst breathing room-air. The volume and concentration of inspired and expired oxygen (O₂) and carbon-dioxide (CO₂) and respiratory rates and volumes, are collected via a mouth-piece or face mask. Metabolic gas exchange data is analysed on a breath by breath basis by O₂ and CO₂ analysers.

A CPX test is usually performed on an ergometer which allows workload to be measured and controlled, this usually takes place on a treadmill or stationary cycle, but can also be performed on an arm-crank cycle or rowing ergometer. To allow for accurate assessment of workload performed, a standard protocol is used, of which there are many available. CPX tests performed on cycle ergometers usually involve a ramping protocol, whereby the workload increases at a predetermined intensity every minute. Treadmill protocols usually involved a staged, or stepped, protocol where the workload increases in stages at predetermined time intervals.

3.4.4 Peak Oxygen Consumption (pVO_2) and exercise intolerance

Directly measured peak oxygen consumption (pVO_2) is an established and reproducible measure of aerobic capacity and exercise tolerance in individuals with heart failure. (Bensimhon et al., 2008, Weber and Janicki, 1985, Mancini et al., 1991, Myers et al., 2000, Meyer et al., 1997, Marburger et al., 1998, Behrens et al., 1994, Gullestad et al., 1998) 'VO₂ max' is defined as a plateau in the maximum oxygen consumption reached during exercise, despite an increasing workload. (ESC, 2001) Oxygen uptake during CPX testing has a linear relationship with workload. (Hansen et al., 1984) This is decreased in cardiovascular, pulmonary and neuromuscular disease and can be increased with physical training. (Blomqvist and Saltin, 1983)

'VO₂ max' is usually not achieved in patients with heart failure, as they are frequently limited by fatigue or shortness of breath. 'Peak VO₂' (pVO_2), defined as 'VO₂ at peak exercise' is a more appropriate term to describe the highest oxygen uptake achieved in patients with heart failure. pVO_2 is more reliable than other indicators of exercise tolerance. (ESC, 2001) Exceeding the anaerobic threshold (AT) which occurs around 60–70% of pVO_2 , or a respiratory exchange ratio (RER) - ratio of VCO_2 to VO_2 , exceeding 1.0 at peak exercise suggests adequate physical effort has been made. (ESC, 2001)

pVO_2 is poorly correlated with resting haemodynamic parameters such as ejection fraction, (ESC, 2001) this is because haemodynamic parameters measured at rest do not accurately represent cardiac pumping function

during exercise, or cardiac functional reserve, which can be assessed during exercise.(ESC, 2001) During physical exertion peak VO_2 correlates with maximal cardiac output, cardiac output in response to physical exertion is modulated by increases in heart rate and stroke volume,(Miyamura and Honda, 1972) and insufficient cardiac output is the principal determinant of impaired aerobic capacity and exercise tolerance in asymptomatic or mildly symptomatic heart failure patients.(ESC, 2001, Harrington and Coats, 1997)

In patients with moderate to severe heart failure, the decreased vasodilation in skeletal muscle vasculature in response to exercise is an important determinant of reduced exercise tolerance and peak VO_2 .(ESC, 2001) Healthy subjects distribute around 90% of cardiac output to leg skeletal muscle during maximal exercise, whilst patients with heart failure distribute around 50– 60% of total cardiac output.(ESC, 2001) Impaired ability to redistribute cardiac output to the legs during exercise is most probably caused by many factors which include increased vascular resistance and endothelial dysfunction, the main mechanisms responsible for peripheral vascular dysfunction are increased neuro-hormonal activation.(ESC, 2001) Increased ergoreceptor activity has been demonstrated in patients with heart failure, which leads to inappropriate dyspnoea, hyperventilation and abnormal muscular fatigue/weakness. This is due to sympathetic respiratory and circulatory over-stimulation.(Piepoli et al., 1996)

To summarise, the main cause of exercise intolerance in those with asymptomatic or mildly symptomatic heart failure is most likely reduced

cardiac output reserve, whereas those with moderate or severe heart failure are limited by a combination of reduced cardiac output reserve, and abnormal peripheral mechanisms.(ESC, 2001)

3.4.5 Measuring pV_{O_2}

During the test all gas exchange is measured breath by breath, and during exercise O_2 uptake and CO_2 production at the mouth represent O_2 utilisation and CO_2 production at the musculoskeletal level. VO_2 is calculated as the product of minute ventilation (VE) and the oxygen fraction that can be utilised by exercising skeletal muscles during maximal and sub-maximal (anaerobic threshold (AT)) exercise.(K Wasserman, 2004)

The value for pV_{O_2} is dependent upon age, sex, body size and fitness level. VO_2 is measured in absolute volume per minute (ml/min), but is divided by weight in kg to allow for comparison between individuals of differing body mass, i.e. ml/kg/min.(K Wasserman, 2004)

3.4.6 Respiratory exchange ratio (RER)

Whether pV_{O_2} is representative of an individual's maximal effort can be determined by using the respiratory exchange ratio (RER). The RER is the ratio of expired VCO_2 to VO_2 consumption ($VCO_2:VO_2$). As the ability of the skeletal muscles to respire aerobically is exceeded, the resultant increase in lactate production results in increased exhaled VCO_2 . Therefore, an RER of 1.0-1.1 suggests that the individual has achieved their cardio-pulmonary

limits, and has not terminated the test due to other limiting factors such as musculoskeletal pain or poor motivation.(K Wasserman, 2004, Mezzani et al., 2003)

3.4.7 VE/VCO₂ slope

Heart failure patients display a steeper increase in respiratory rate during physical exertion, and increased ventilation rates, at given workloads.(ESC, 2001, K Wasserman, 2004) The magnitude of such ventilatory abnormalities is represented by the increased slope of the relation between ventilation and CO₂ production (VE/VCO₂ slope), which is related to peak VO₂.(ESC, 2001) This increased ventilation is due to haemodynamic mechanisms such as increased dead-space in the lung (caused by ventilation–perfusion mismatch in the lung), heightened hypoxic carotid chemo-sensitivity and skeletal muscle abnormalities (early accumulation of lactate in the blood, heightened ergoreflex activity, early blood lactate accumulation).(ESC, 2001, Piepoli et al., 1996, Chua et al., 1996) A steeper VE/VCO₂ slope is related to adverse prognosis.(Ingle et al., 2007, Sun et al., 2002)

3.4.8 End tidal carbon dioxide (PETCO₂)

The partial pressure of end tidal CO₂ (PetCO₂, mmHg) is measured during a CPX test. Low PetCO₂ at rest, and during physical exertion, suggests hyperventilation and reflects lung ventilation/perfusion mismatch, low PETCO₂ is a further indicator of disease severity and outcome.(Arena et al., 2003, Yasunobu et al., 2005)

3.4.9 Sub-maximal exercise

Measures of submaximal exercise capacity can be obtained from a CPX test, and are considered useful in situations where individuals are unable to complete a maximal effort CPX test. There is a linear increase in the slope of minute ventilation from the onset of exercise, however there is an abrupt change in the slope at the point where the metabolic demand, made by increasing exercise intensity, becomes too intense for aerobic metabolism to supply and skeletal muscles have to rely increasingly on anaerobic metabolism to continue exercising.

An increase in anaerobic glycolysis leads to a rapid increase in blood lactate concentration, and as a result excess CO_2 production via bicarbonate occurs to buffer the increased in H^+ ions. At this point there is a deflection in the slope of VCO_2 production, this deflection point is known as the ventilatory or anaerobic threshold (AT) expressed as VO_2 in mL/kg/min.(Beaver et al., 1986)

AT is a universally recognised way of measuring sub-maximal exercise capacity, and can be used to assess the effects of an intervention on functional benefits based on its correlation to activities of daily living.(Wilmore et al., 1998) AT is generally occurs at around 70% of pVO_2 in heart failure patients, which is lower than it would in normal subjects.(Shimizu et al., 1991, ESC, 2001)

3.4.10 Exercise protocols

There is no common consensus concerning the most appropriate exercise test protocol with which to assess functional capacity in individuals with heart failure, the protocol is often chosen due to physician preference, and the most effective method has been a discussion point for many years.(ESC, 2001, Balke and Ware, 1959, Bruce, 1971, Stuart and Ellestad, 1980, Weber et al., 1982, Page et al., 1994)

Several incremental exercise protocols are available, and there can be considerable differences between protocols in terms of the mode of exercise, usually stationary cycle or treadmill, and also in exercise duration, the rate at which work is incremented and the duration of each stage. A gradually incrementing workload has been shown to be a more accurate reflection of exercise capacity than sudden increases in workload, especially in patients with heart failure.(ESC, 2001)

The aim of a CPX test is to have a test that provides a gradual and consistent increase in workload, allowing adequate metabolic gas kinetic response, with an exercise time of between 8 and 12 minutes, this allows the most accurate assessment of pV_{O_2} .(Buchfuhrer et al., 1983, Fletcher et al., 1995, ESC, 2001) Tests shorter than 8 minutes duration are considered to be off insufficient length to allow steady-state gas exchange to occur, and tests longer than 12 minutes are considered to be more limited by general fatigue, than cardiopulmonary limits.(K Wasserman, 2004)

3.4.11 Stationary cycle

A stationary cycle is thought of as the most accurate method of performing a CPX test, as the legs are isolated and there can be no additional help from the arms.(K Wasserman, 2004) A stationary cycle protocol usually follows a protocol whereby the workload is gradually ramped up throughout the test until exhaustion is reached between 8 and 12 minutes. The workload is measured in Watts, and protocols typically increase in a set amount of Watts per minute e.g. 10W/min, 20W/min etc.(K Wasserman, 2004)

3.4.12 Treadmill

Treadmill protocols can lead to a 10-20% higher pV_{O_2} than cycle protocols.(Page et al., 1994, Myers et al., 1991, Buchfuhrer et al., 1983, Fletcher et al., 1995, Myers and Froelicher, 1990) However, multicentre trials in heart failure have found comparable pV_{O_2} values when using treadmill or stationary cycle.(Page et al., 1994) The Bruce protocol is the most frequently used treadmill protocol in cardiology settings, and this can be modified by the addition of 2 stages at the beginning, the 1st consisting of 3 minutes of exercise at 1.7mph at 0% gradient and the 2nd 1.7mph at 5% gradient. The 'Modified Bruce' protocol is shown in Figure 3.4 often used in heart failure patients, as the standard Bruce protocol is considered too difficult and may result in a test of insufficient duration.(Bruce and McDonough, 1969)

Stage	Speed (mph)	Grade (%)	Duration (min)
0	1.7	0	3
0.5	1.7	5	3
1	1.7	10	3
2	2.5	12	3
3	3.4	14	3
4	4.2	16	3
5	5.0	18	3
6	5.5	20	3
7	6.0	22	3

Figure 3.4: Modified Bruce protocol

The Naughton and Balke protocols are alternative treadmill protocols, with more gentle increments in speed and gradient than the Bruce protocol, however their more gentle profile may lead to excessive test duration, and therefore might be less likely to achieve a representative $\dot{V}O_2$. (Balke and Ware, 1959, Nagle et al., 1965)

3.4.13 CPX protocol

Following consent, 12-lead ECG and gas exchange variables were collected for a period of six minutes to ensure steady-state conditions were achieved. The same experienced Cardiac Physiologist performed all of the CPX tests during the studies. A 12-lead, real-time, ECG was displayed during the resting, test and recovery phases. 12-lead ECGs were printed at baseline, end of each 3 minute stage, peak exercise and during recovery.

All participants performed a symptom limited maximal CPX test on a treadmill using the modified Bruce protocol (Fig 3.4). During each test,

inspired and expired air was collected using a mouthpiece and metabolic gas exchange analysis was performed breath-by-breath using the MedGraphics Ultima CardioO2 equipment (Medical Graphics UK Limited, Gloucester, UK). The analyser was calibrated using the manufacturer recommended volume and automated gas calibration techniques before every exercise test.

Patients were encouraged to perform a maximal exercise test prior to the test. Patients were instructed to exercise to exhaustion or to onset of symptoms. The test may also be terminated by the staff in the advent of ECG changes. All subjects were recovered for at least six minutes following the test, or until heart rate and any ECG changes returned to normal. All tests were carried out in the same exercise laboratory. All CPX and ECG data were recorded and stored securely for later analysis. Because of the numbers involved in the study it was deemed impractical to perform a familiarisation CPX.

3.5 Assessing quality of life in CHF

Quality of life is used in medicine to determine a patient's quality of life from their own perspective.(Katschnig, 2006) Quality of life is significantly reduced in CHF, and measures of the quality of life in CHF patients are an important source of data in research.(Guyatt, 1993) The aim of measuring quality of life in research is to have an objective appraisal of how the physical and emotional effects of a condition affect an individual's life.(Katschnig, 2006, Guyatt, 1993) Such data can be used during baseline assessment and as

outcome measures, and can be used to assess the impact of any intervention on an individual's quality of life.(Soler-Soler and Permanyer-Miralda, 1994, Guyatt, 1993)

Quality of life is usually measured by patients completing questionnaires. Examples of questionnaires assess quality of life in patients with heart failure include:

1. The Chronic Heart Failure Questionnaire
2. The Minnesota Living with Heart Failure Questionnaire
3. The Yale Scale
4. The Quality of Life Questionnaire in Severe Heart Failure
5. The Kansas City Cardiomyopathy Questionnaire.

(Coelho et al., 2005)

Chapter 4. What is the prevalence of left ventricular dysfunction in pacemaker patients requiring a battery replacement?

Hypothesis – “Left ventricular systolic dysfunction is related to right ventricular pacing percentage in a cohort of patients awaiting pacemaker battery replacement”

4.1 Introduction

Previous data have suggested that patients with pacemakers are at a higher risk of prevalent left ventricular systolic dysfunction (LVSD) and heart failure admissions. I set out to establish relationships between pacemaker variables and left ventricular function and interacting confounders.

4.2 Methods

The inclusion criteria was that all patients from 1st April 2008 – 21st December 2012, with a pacemaker implanted for bradycardia, referred for elective pacemaker generator replacement at Leeds General Infirmary were invited to attend the cardiology department at least one week before their procedure. Exclusion criteria included being unable to consent, aged under 18, ICD or CRT device implanted and congenital heart disease. At the time of study commencement, around 125 battery replacements were performed each year. Patients with bradycardia pacemakers are followed annually at Leeds Teaching Hospitals NHS Trust, and are referred for battery

replacement when the estimated longevity of the battery was between 3-6 months. Patients would be informed that they had been referred, and to expect an appointment through the post. Details of the existing device, such as potential lead connection problems, or the requirement of a new lead, would be assessed by a senior Cardiac Physiologist, and any potential problems reported to the physician performing the procedure. Echocardiographic variables including height, weight, blood pressure, symptomatic status (New York Heart Association category), medical therapy, past medical and cardiac history, date of first implantation, indication for implant and the number of pacemaker generator replacements were recorded. The implant indication was confirmed by reviewing the baseline electrocardiograph tracings and the medical records. The pacemaker was interrogated to document programmed settings and the percentage of right atrial and RV paced (%VP) beats. We multiplied the %VP with the number of years of pacing to gain some estimate of total volume of ventricular pacing (years of 100% VP).

Each patient had a full transthoracic echocardiographic investigation (Vivid 7, Vingmed, USA), and, in those without neuromuscular, skeletal, pulmonary, and other conditions preventing exercise testing, symptom-limited, peak cardiopulmonary exercise testing using a treadmill, was carried out to establish exercise capacity including peak oxygen consumption (Medgraphics, USA), and heart rate and blood pressure responses to exercise. Blood tests were performed at this visit or prior to the battery replacement procedure, to measure renal function and blood count.

For hospitalisation and mortality 31st December 2012 was chosen as the censor date, and all patients attending the assessment were included in the final analysis. Mortality and hospitalisation data were ascertained from both electronic and paper records. Data analysis was undertaken using SPSS version 18. Associations between variables were initially investigated using simple regression and later by multiple regression. Differences between groups were investigated using Student's t-test and a Cox proportional hazard model was used to compute the hazard ratio and corresponding 95% confidence intervals for subsequent mortality or hospitalisation. The study was approved by the Leeds West Research Ethics Committee. A sample size calculation was not performed, the data collection was governed by time constraints and ceased on 31st December 2011.

4.3 Results

During the study period 508 patients underwent pacemaker generator replacement, a complete dataset was collected on 491 (97%) of these. Included in this cohort of 491 patients were 66 patients who took part in the study described in chapter 5. These 66 patients had their pacemaker programming optimized to reduce RV pacing, associated with statistically significant improvements in LV systolic function. Inclusion of these 66 patients, with improvements to such an important prognostic marker as LV systolic function, may have influenced the mortality and admission rates reported in this chapter. Age, pacemaker variables and co-morbidities were

not different in those assessed and not. Table 4.1 shows demographic and basic pacemaker data. Cardiovascular co-morbidities (43% had ischaemic heart disease, 27% atrial fibrillation and 13% diabetes mellitus) and concurrent cardiovascular medical therapies were common.

Table 4.1: Pacemaker survey patient demographic data

	Mean (95% CI) or % [n]
Age (years)	76 (74-78)
Sex (% male [n])	56 [275]
Height (cm)	165 (163-167)
Weight (kg)	78 (76-80)
Years since first implant	10 (9.6-10.4)
Age at implant (years)	66 (64-68)
NYHA	II
Years of present generator	8.2 (7.6-8.8)
Baseline indication (% [n])	
Sinus node disease	54 [265]
AV-block	43 [211]
Other	3 [15]
Complete heart block at baseline (% [n])	27 [133]
Sinus rhythm at enrollment (% [n])	73 [358]
eGFR (ml/min)	57 (55-59)
Creatinine (µmol/L)	113 (109-117)
QRS width (ms)	161 (155-166)
Overt ischaemic heart disease (MI, PCI, CABG) (% [n])	15, 6, 22 [74, 29, 108]
Diabetes mellitus (% [n])	13 [64]
Hypertension (% [n])	44 [216]
B-blockers (% [n])	59 [290]
ACE-inhibitors (% [n])	68 [334]
Spirolactone (% [n])	10 [49]
Furosemide dose (mg/day)	20 (14-26)

Values are means (95% CI), median for NYHA or % (or n) as indicated.

AV; atrioventricular, eGRF; estimated glomerular filtration rate, MI; myocardial infarction, PCI; percutaneous coronary intervention, CABG; coronary artery bypass grafting, ACE-inhibitor; angiotensin-converting-enzyme inhibitor.

4.3.1 Device prescription and programming

Table 4.2 contains the device characteristics and detail of their programming. Patients in SR were more likely to have a dual chamber device implanted than patients in AF (93 v 49%), and there was no age difference between those with and without dual chamber devices. The most common indication for implantation was sinus node disease (54%), with 42% having an indication of AV block, including 27% of the total with third degree block (complete heart block (CHB)) at baseline (table 4.1). Patients with an implant indication for CHB had a higher %VP at the time of PGR (85 (3) v 50 (2) %) than those without CHB at implant, and although 78% of those with CHB at baseline had >80%VP at PGR, 12% had less than 40%VP at follow-up (Fig 4.1) Additionally, 37% of patients implanted for AV-delay but not in CHB at baseline were receiving >80%VP at the time of PGR.

37 (8%) of patients had an LVEF of <35%. These patients were referred to the heart failure clinic at LTHT for further management. The patients remained in the study for analysis purposes.

Table 4.2 Pacemaker, echocardiographic and cardiopulmonary exercise test variables in 491 pacemaker pulse generator replacement patients

Devices and their programming	% [n]
Hardware (% [n])	
Ventricular lead only	20 [96]
Dual chamber sensing (VDD lead)	0.5 [2]
Dual chamber pacing	80 [393]
Pacing mode (% [n])	
AAI (R)	1 [4]
VVI	13 [63]
VVIR	12 [61]
VDD	5 [23]
DDD	37 [183]
DDDR	25 [124]
DDI (R)	7 [33]
Rate response on (% [n])	(48%) [236]
Pacemaker variables	Mean (CI)
Base rate (/min)	62 (61-63)
Max track rate (/min)	122 (120-124)
Paced/sensed AV delay (CHB) (ms)	192/168 (178-206/154-182)
Paced/sensed AV delay (non-CHB) (ms)	246/219 (237-255/208-230)
% paced atrium	46 (42-50)
% paced ventricle	56 (52-60)
>80% ventricular pacing	45 [220]
Echocardiographic and CPX variables	Mean (CI) or median (IQR)
LVEF (%)	50 (48-52)
LVEF <35%	37 (8%)
LVEDD (mm)	48 (46-50)
LA diameter (mm)	42 (40-44)
E-wave velocity (m/s)	0.80 (0.40)
A-wave velocity (m/s)	1.00 (0.00)
E/A ratio	0.78 (0.32)
Peak VO ₂ (ml/kg/min) (n=159)	17.6 (16.6-18.6)
VE/VCO ₂ slope	34 (10)

Values are means (95% CI) except for LA diameter, E-wave, A-wave and E/A ratio which are median (IQR) and LVEF <35% which is n (%)

AV; atrioventricular, CPX; cardiopulmonary exercise test, LVEF; left ventricular ejection fraction, LVEDD, left ventricular end-diastolic diameter, peak VO₂; peak oxygen consumption, VE/VCO₂ slope; ratio between ventilation and carbon dioxide output.

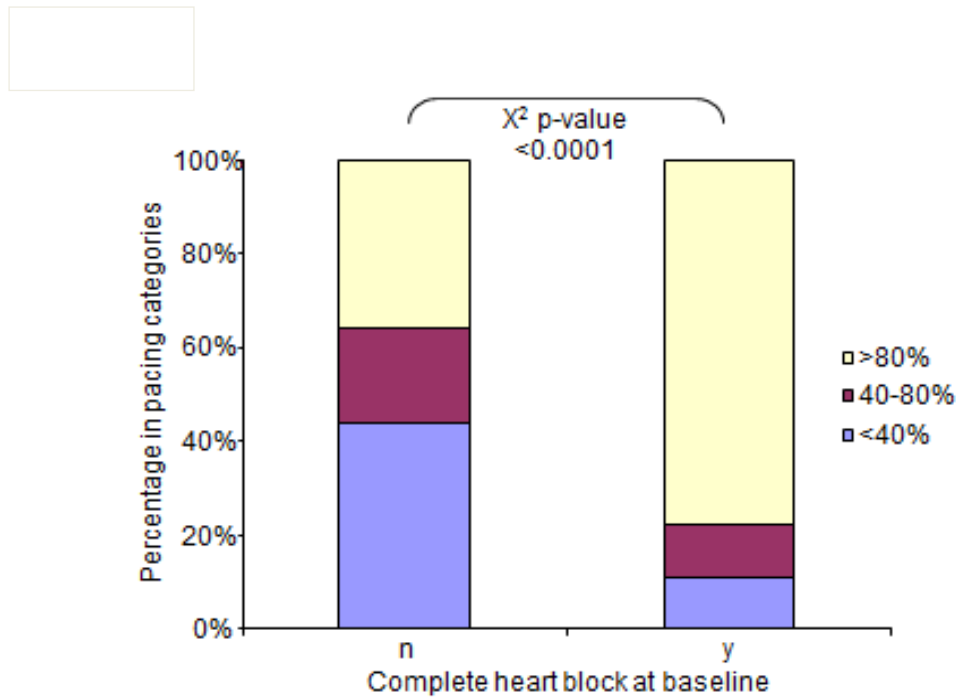

Figure 4.1 Percentage ventricular pacing at PGR in those with and without CHB at baseline.

There was a weak relationship between age and %VP, ($r=0.1$; $p=0.014$) and although patients with >80%VP were older, the total volume of %VP was not related to age. There was no relationship between the presence of existing cardiovascular co-morbidities (myocardial infarction, percutaneous coronary angioplasty, hypertension, or cardiac surgery), seen in 50% of the population and the %VP. However, there was a relationship between %VP and renal function, ($r=0.20$; $p=0.0077$) and furosemide dose ($r=0.2$; $p<0.02$), and patients with >80%VP at PGR had significantly worse renal function (eGFR 53 (2) v 60 (2); $p=0.01$).

Rate response mode was more frequently activated in patients in AF (66 v 41%), and was associated with a higher %VP in single chamber (but not in dual chamber) devices (%VP 78 (4) v 59 (7)%). As a result, patients with

single chamber devices experienced a higher %VP than those with dual chamber devices (71 (4) v 53 (3) %).

4.3.2 Echocardiographic and Cardiopulmonary exercise test results

Table 4.2 contains results of the echocardiographic and CPX results in patients attending for PGR. The incidence of LV systolic dysfunction (LVEF<50%) in all patients was 40%, but this was significantly higher (59%) in those with >80%VP than in those with <80%VP (22%) (Fig 4.2) and in those with cardiovascular co-morbidities (Fig 4.3). Patients with LV systolic dysfunction were more likely to be taking β -blockers (79 v 47%) and ACE-inhibitors (or angiotensin receptor blockers)(83 v 63%), although daily doses were not optimal (mean bisoprolol equivalent 4.5 (0.5)mg).

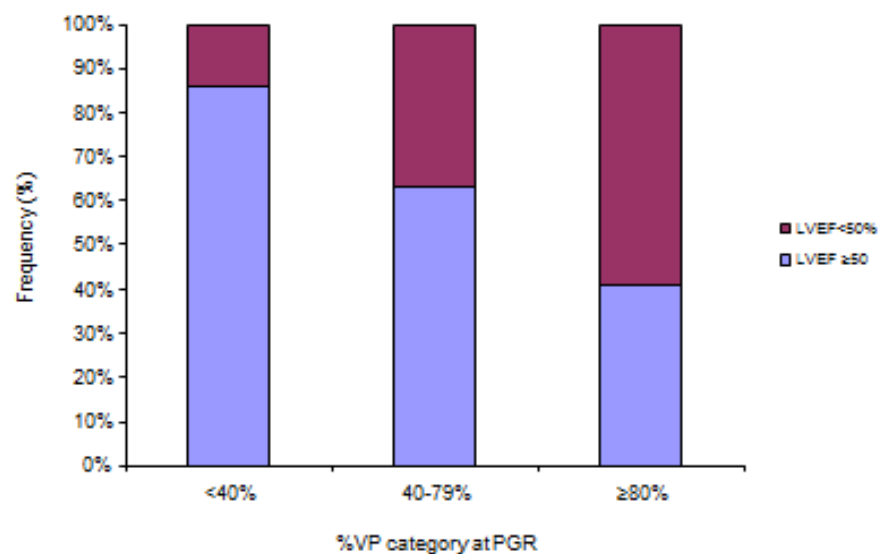

Figure 4.2 The incidence of LV systolic dysfunction, based on pacing percentage

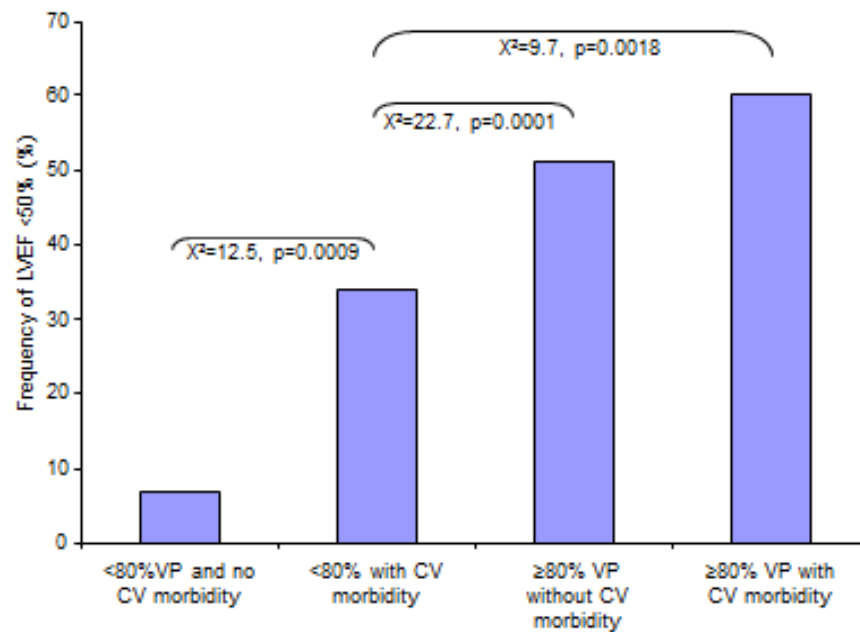

Figure 4.3 Frequency of left ventricular systolic dysfunction in patients with or without cardiovascular co-morbidity (hypertension, type 2 diabetes mellitus, and apparent coronary artery disease), split by percentage of ventricular pacing

Patients with CHB at baseline had worse LV systolic function (LVEF 46 (1) v 52 (1)%) and were more likely to have LV systolic dysfunction ($X^2=7.6$) at PGR than those with intact AV conduction, but the differences between those with and without >80%VP at PGR were greater (LVEF 55 (1) v 46 (1)% and $X^2=48$).

For most patients, it was their first PGR (78% [n=283]). Although patients with previous generator replacements had a higher amount of ventricular pacing than those attending for their first replacement, (54 (2) v 63 (4)%VP), and had a higher total volume of pacing (4 (0.2) v 11 (1) years of 100% VP),

there was no relationship between the number of previous generator replacements (ANOVA $p=0.28$) and LVEF or presence of LVSD.

Simple regression suggested relationships between LVEF and age ($r=0.15$; $p=0.006$), %VP at PGR ($r=0.40$; $p<0.0001$), years of 100% VP ($r=0.24$; $p<0.0001$), serum creatinine ($r=0.26$; $p<0.0001$), paced QRS ($r=0.41$; $p=0.0003$), and furosemide dose ($r=0.32$; $p=0.0001$). In a multivariable model %VP at PGR and previous myocardial infarction remained significant (table 4.3), pVO_2 , VE/VCo₂ slope, LVEF and QRS duration were not significant in this model. Figure 4.4 shows the receiver operator curve for predicting LVEF <50% using %VP at PGR, creatinine, and previous myocardial infarction. Using three variables: %VP, years of 100%VP and previous MI, our model has a negative predictive value of 91%, a positive predictive value of 51% with a c-statistic of 0.74.

Table 4.3 Multivariable model of predictors of the presence of impaired left ventricular function

	Odds Ratio	95% confidence intervals of odds ratios		p-value
		Low	High	
Myocardial infarction (yes)	3.66	1.41	9.57	0.008
% ventricular pacing (per %)	1.03	1.02	1.04	<0.001
Creatinine (per μmol)	1.02	1.00	1.03	0.011

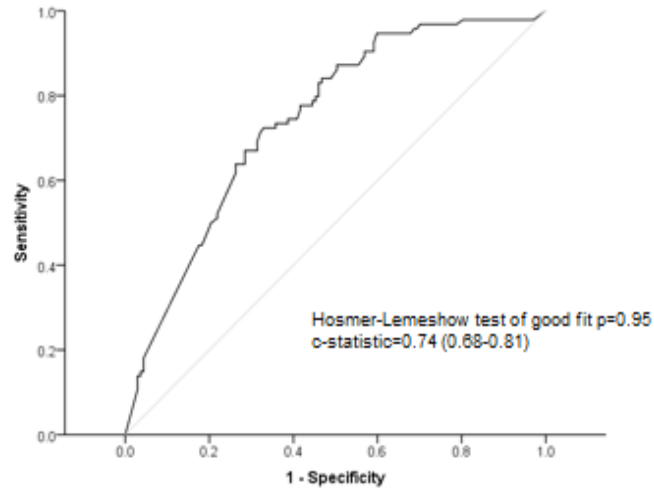

Figure 4.4: Receiver-operating characteristic (ROC) curve for left ventricular dysfunction (LVEF <50%) with $\geq 80\%$ right ventricular pacing and previous myocardial infarction.

Peak oxygen consumption was available in 159 (33%) patients. Patients with pacemakers have significantly limited exercise capacity, which is lowest in those with the highest amount of ventricular pacing ($>80\%$ VP) (peak oxygen consumption 15 (1) v 20 (1)). Fig 4.5 shows the relationship between RV pacing and peak VO_2 ($r^2 = 0.07$; $p = 0.006$) in this cohort. Fig 4.6 shows the relationship between RV pacing and LVEF ($r^2 = 0.16$; $p < 0.0001$). And In multiple regression, peak oxygen consumption is related to age, renal function and furosemide requirement rather than any marker of pacemaker activity.

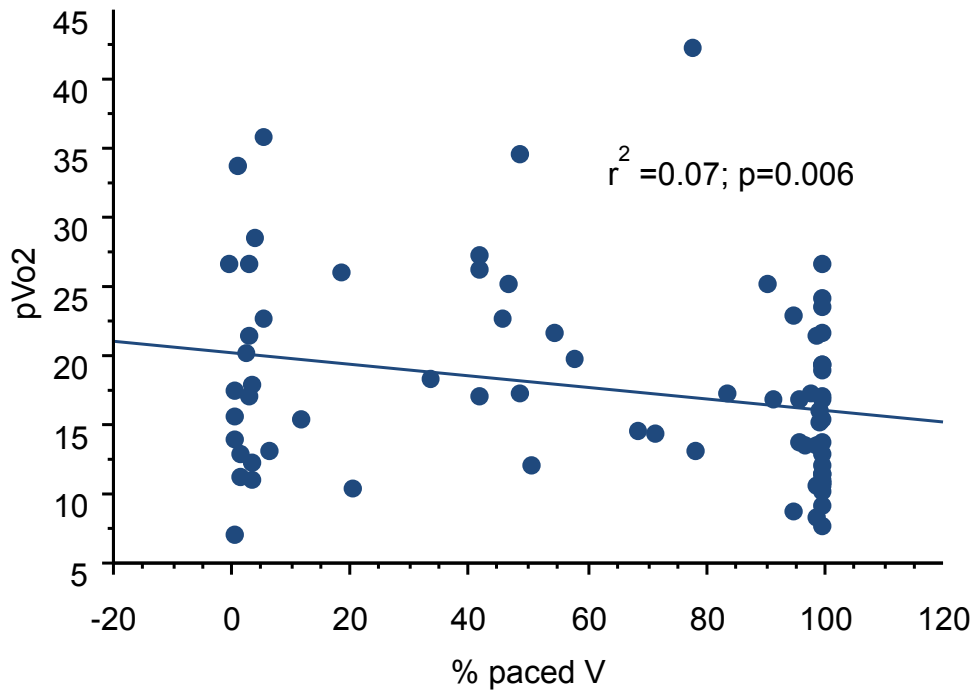

Figure 4.5 The relationship between right ventricular pacing and peak oxygen consumption at baseline

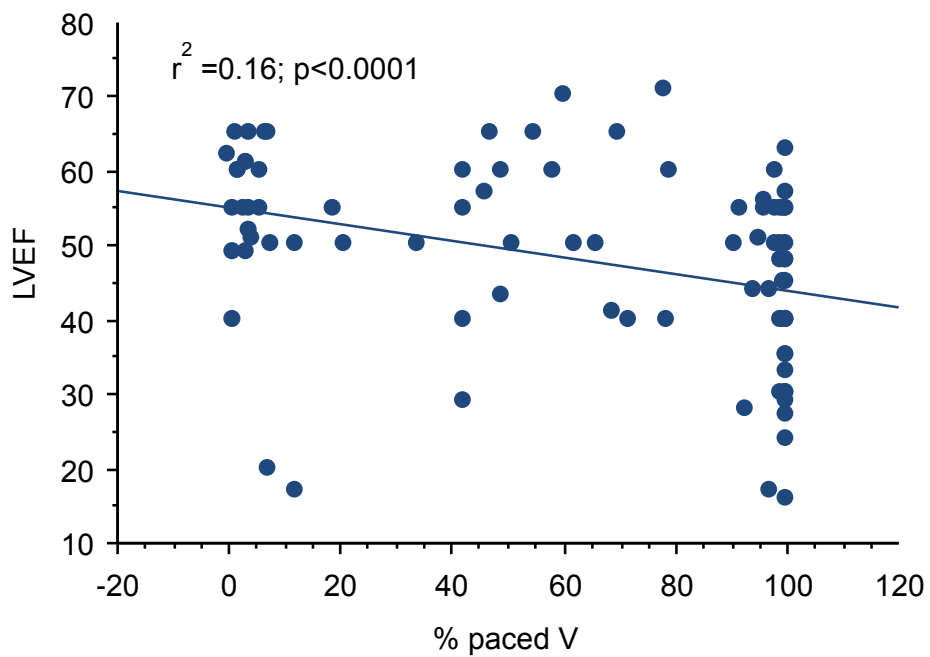

Figure 4.6 The relationship between right ventricular pacing and LVEF at baseline

4.4 Outcome data

In our prospective analysis of outcome we excluded 25 patients who were enrolled into a randomised study of upgrade to cardiac resynchronisation therapy. This left a population of 466. After a mean follow-up time of 668 (19) days, 56 patients (12%) were dead (n=34) or had been hospitalised (n=22) for heart failure. Univariable predictors of mortality or hospitalisation for heart failure are shown in table 4.4. On multivariable analysis, only LVEF \geq 50% was independently associated with better survival (HR 0.48 (0.25-0.94)). The Kaplan Meier curves for patients with and without LVEF <50% and with and without %VP>80% are shown in Figure 4.6.

Table 4.4: Univariable cox-regression analysis of predictors of combined mortality or hospitalisation for heart failure

	Hazard Ratio	95% confidence intervals of hazard ratios		p-value
		Low	High	
Age (per year)	1.035	1.007	1.064	0.014
% ventricular pacing (per %)	1.01	1.002	1.018	0.017
LVEF <50% (y/n)	2.44	1.28	4.66	0.007
Creatinine (per μ mol)	1.011	1.006	1.015	<0.001
Haemoglobin (per g/dL)	0.68	0.57	0.81	<0.001
Furosemide (per mg)	1.018	1.008	1.029	0.001
pVo2 (ml/min/kg)	0.863	0.754	0.989	0.0335

LVEF; left ventricular ejection fraction

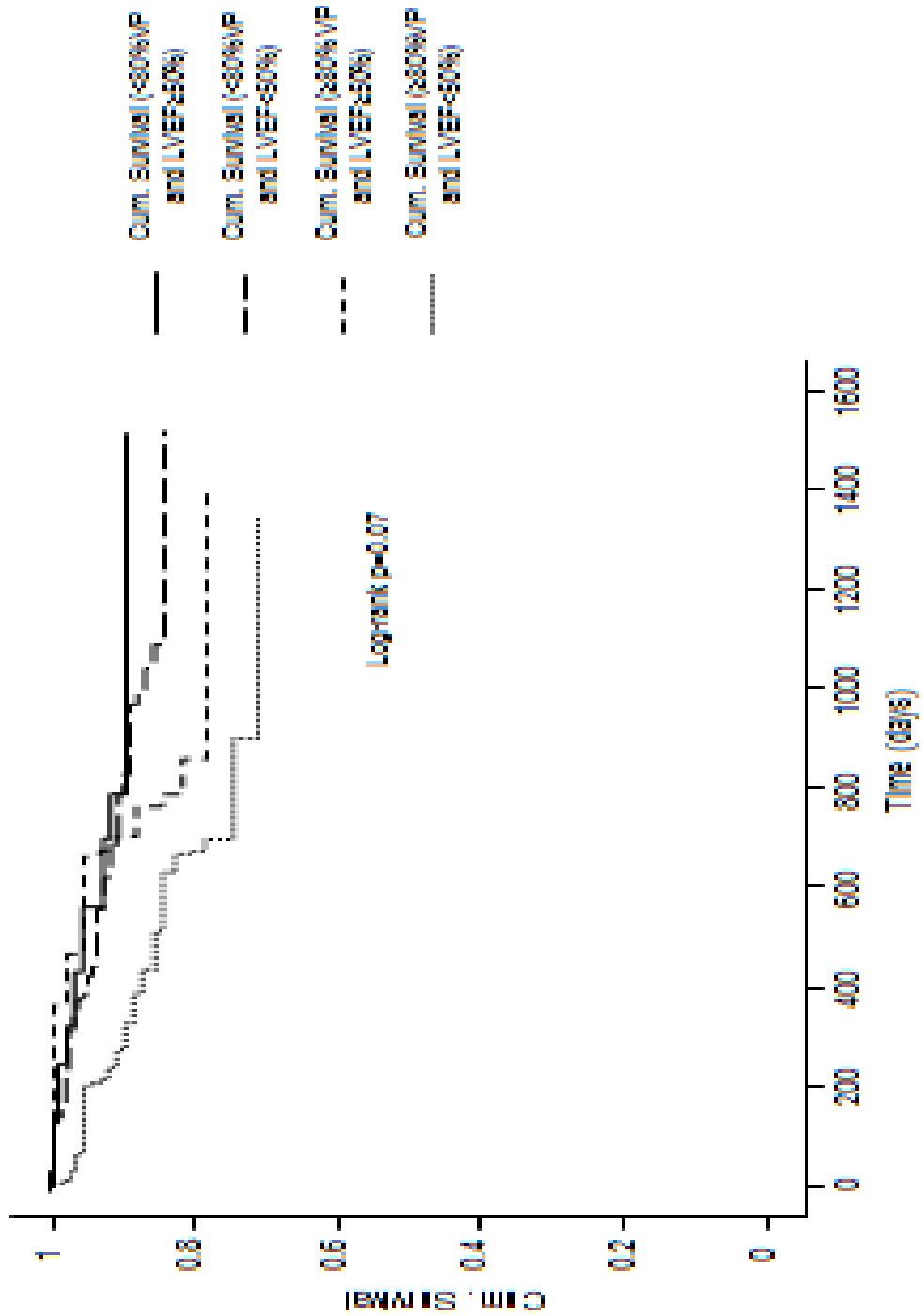

Figure 4.6: Kaplan Meier curve for survival out of hospital in patients with pacemakers divided by left ventricular ejection fraction and percentage of ventricular pacing prior to generator replacement

4.5 Discussion

The present data are the first to systematically explore a current cohort of patients undergoing standard pacemaker generator replacement. The data demonstrate a high prevalence of LV dysfunction and co-morbidity and a mortality rate only modestly lower than that of heart failure patients of similar age.(Cubbon et al., 2011) The degree of LV dysfunction is independently related to the amount of RV pacing and, particularly when combined with a high percentage of ventricular pacing, LV dysfunction suggests an adverse prognosis.

In retrospective analyses,(Brunner et al., 2004, Jahangir et al., 1999, Shen et al., 1994, Shen et al., 1996, Jelic et al., 1992, Mayosi et al., 1999) and one prospective study,(Sweeney et al., 2008) of patients receiving new pacemakers, the most consistent feature predicting outcome was LVSD at baseline although age, coronary artery disease, co-morbidities (chronic airways disease and diabetes mellitus), paced QRS (for subsequent hospitalisation), and atrio-ventricular block are also associated with a worse outcome. In our cohort pacing mode or indication was not relevant once %VP and the presence of LV dysfunction had been taken into account.

Additionally, by demonstrating a dose-response relationship between the amount of ventricular pacing and the degree of LV dysfunction, we have fulfilled one of the requirements for causality.(Shukla et al., 2005) The weak relationship between age and LVEF, and the poor association between %VP

and cardiovascular co-morbidities suggest that the relationship between RV pacing and LV dysfunction is causative rather than merely associative.

We have been able to construct a model based upon simple pacemaker-related and clinical variables (>80%VP, years 100%VP, and previous myocardial infarction) that has a negative predictive value of 91% for LVSD and a c-statistic of 0.74 (0.68-0.81). This would form an easy way to select patients who might benefit from a more extensive review.

4.5.1 Aetiology of RV pacing associated LV dysfunction

RV pacing induces ventricular dyssynchrony,(Bordachar et al., 2003) similar to that seen in intrinsic left bundle branch block (LBBB),(Witte et al., 2006, Varma, 2008, Tops et al., 2006, Tops et al., 2009, Tops et al., 2007) which leads to altered regional blood flow and wall stress and increases cardiac sympathetic activity.(Lee et al., 1994) Endomyocardial biopsies in patients with long-term pacemakers reveal increased fibrosis, fat deposition, and mitochondrial morphological changes.(Karpawich et al., 1999) The severity of these perfusion abnormalities, the regional wall motion abnormalities, and degree of left ventricular dysfunction are directly related to the duration of ventricular pacing,(Tse and Lau, 1997) although subtle changes can be identified after only 18 months.(Tse et al., 2002)

Hence, RV apical pacing, by leading to adverse LV remodelling, LV dilatation, and asymmetrical hypertrophy,(Thambo et al., 2004) could either

induce LV dysfunction or accentuate pre-existing latent LV dysfunction present as a result of other co-morbidity of which most patients receiving pacemakers (and generator replacements) have at least one. Most patients undergoing pacemaker implantation do not have cardiac imaging prior to the procedure, and there are also no large follow-up studies of patients undergoing RV pacing examining changes in LV function, so which features identify patients at high risk of future LV dysfunction is unknown.

4.5.2 Medical management of RV pacing associated LV dysfunction

Medical therapy for symptomatic and asymptomatic pacemaker-associated LV dysfunction is under-investigated. Patients with pacemakers and heart failure were often excluded from trials of medical therapy and studies specifically looking at patients with pacemakers and LV dysfunction are rare.(Suwa et al., 1998) Furthermore, although the large studies of heart failure and asymptomatic LVSD did not exclude pacemaker patients, sub-study analysis in patients with pacemakers was not done. In our cohort, this lack of knowledge is reflected by the finding that patients with LV dysfunction were not on optimal medical therapy.

4.5.3 Device based management of RV pacing associated LV dysfunction

As RV pacing contributes to poorer outcomes,(Wilkoff et al., 2002) reducing RV pacing may improve LV function or prevent further deterioration. But although >80%VP in VVI mode and >40%VP in DDD mode are associated with an increased rate of hospitalisation for heart failure, (Sweeney et al., 2003) it is unknown whether there is a threshold of %VP below which the risk of subsequent or deteriorating LVSD is low and whether this is different in patients with established LVSD or a combination of risk factors. Large prospective observational datasets are required to identify whether there is a threshold of acceptable %VP below which LVSD is unlikely to occur or worsen.

Patients with sinus node disease have a low %VP and a low frequency of LVSD but in those with A-V delay, reprogramming to reduce RV pacing, can reduce the incidence of atrial arrhythmia,(Kolb et al., 2011, Sweeney et al., 2007, Gillis et al., 2006, Murakami et al., 2010, Nitardy et al., 2009, Davy et al., 2012). Whether such adjustments and algorithms are safe and cost-effective is unknown.(Kolb et al., 2011)

Patients with standard pacemakers and heart failure, with high levels of right ventricular pacing due complete heart block or a slow response to atrial

fibrillation, often have their pacemaker upgraded to a cardiac resynchronisation therapy (CRT) device. Non-randomised data identify that this leads to similar improvements as in de-novo CRT implants, in terms of clinical variables and measures of LV function,(Witte et al., 2006, Laurenzi et al., 2007) and only two randomised (cross-over) studies have been completed. In the first study, in 10 patients with symptomatic heart failure, there were acute improvements in LV function, symptom scores and B-type natriuretic peptide levels following CRT.(Laurenzi et al., 2007) In the second study, involving 36 patients with LV dysfunction (LVEF <40%) without CHF symptoms, there were improvements in cardiac function following upgrade to biventricular pacing.(van Geldorp et al., 2010) However, an upgrade procedure is not without risk in patients with existing pacemakers, with risk of infection meaning that an upgrade procedure cannot be assumed to be benign. In the latter study, 5 patients required second (or third) procedures (including one mini-thoracotomy) to achieve LV pacing. There are no randomised trials in patients on optimal CHF medical therapy investigating the morbidity and mortality effect of upgrading to CRT in patients with chronic RV pacing and LV dysfunction with or without heart failure symptoms and a registry of successful implants, although useful, is not enough.(Bogale et al., 2011)

4.5.4 Preventing RV pacing associated LV dysfunction

These results have implications for the use of CRT in patients requiring a pacemaker for bradycardia thought to be 'at risk' of developing LVSD. Complete heart block at implant only modestly predicts high %VP at future

follow-up, however 65% of patients with low grade AV node disease, without CHB at implant, go on to pace more than >80%VP. Therefore, CHB at baseline represents only 80% of those requiring >80%VP at PGR. In addition, despite a high %VP, some patients seem resistant to the potentially deleterious effects of RV apical pacing, so not all patients with high degree A-V block will have high %VP at PGR, and not all patients with high %VP go on to develop LVSD. Not all patients in this cohort with LV dysfunction were taking optimal medical therapy and the incremental benefit of implanting a CRT device at baseline or at PGR for rate support is not clear.

4.6 Limitations

This dataset does not include patients that did not survive to PGR, and therefore represents a selected population. However, even this group has a significant subsequent morbidity and mortality so a PGR may be an appropriate time point to review pacemaker and medical therapy. Patients with an LVEF of <35% were referred to the heart failure service for review. These patients remained in the study for analysis, which may skew the results as they have not followed the usual care pathway for pacemaker patients. Patients did not perform a familiarisation CPX which may influence the results, however performing a familiarisation test was not practical with the number of recruits and time constraints.

4.7 Conclusions

Patients with RV pacemakers referred for elective PGR have a high incidence of left ventricular systolic dysfunction and low peak exercise capacity, strongly related to the amount of RV pacing to which they are exposed. Those with left ventricular systolic dysfunction and high amounts of RV pacing are at high risk of subsequent mortality. Simple variables can identify those patients who might benefit from a more comprehensive review around the time of generator replacement. Whether there are clinical and economic benefits of using the opportunity of elective generator replacement to optimise medical and device therapy in patients with cardiac dysfunction is unknown.

Chapter 5. What are the effects of a strategy to reduce right ventricular pacing on left ventricular function?

Hypothesis – “Reducing unnecessary right ventricular pacing improves left ventricular systolic function, in a cohort of patients awaiting pacemaker battery replacement”

5.1 Introduction

During the survey of pacemaker patients coming for generator replacement, it became apparent that many patients had high amounts of right ventricular pacing despite reliable underlying intrinsic activity. The aim of the present project was therefore to establish the effects of reprogramming pacemakers to reduce RV pacing on LV function, exercise capacity, neurohormonal levels and symptoms.

Reducing unnecessary right ventricular pacing may have important clinical significance. It is well established that right ventricular pacing contributes towards the development of LVSD, CHF and AF, which may all contribute toward poor outcomes and quality of life. Therefore reducing unnecessary right ventricular pacing could influence outcomes and quality of life. Reducing unnecessary right ventricular pacing may also prolong battery life

and extend the life of the pacemaker, or even prevent battery replacement in some individuals.

5.2 Methods

All patients referred for a PGR at Leeds General Infirmary were invited to attend a comprehensive pre-procedure assessment as described previously.

In all patients with avoidable RV pacing seen over a six month period, we followed a pre-specified algorithm outlined in Figure 5.1

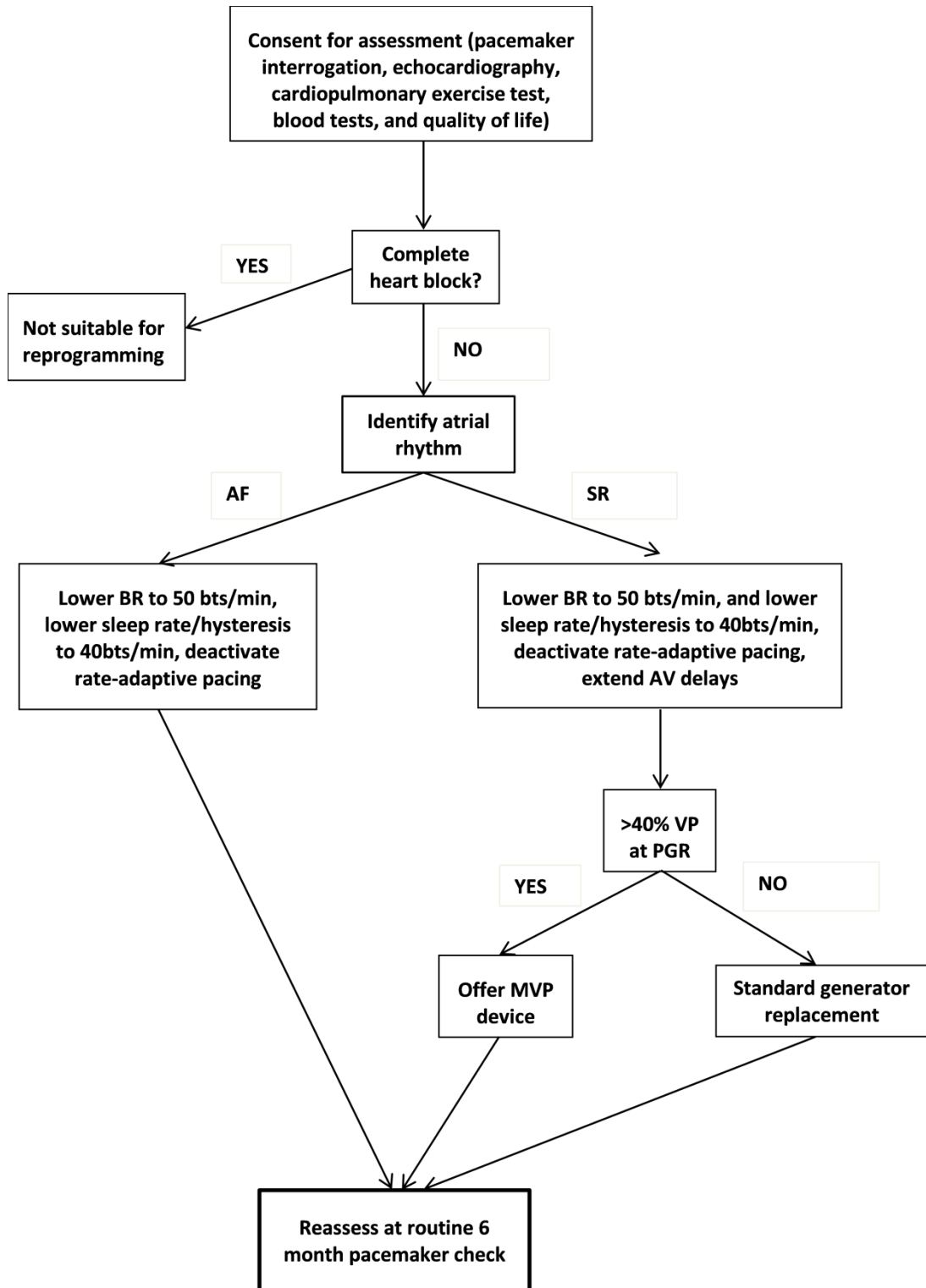

Figure 5.1: Leeds RV pacing avoidance algorithm

First, the day-time base rate (BR) was reduced to 50 beats per minute, and the sleep rate (or hysteresis where available) to 40 beats/minute. Rate responsive pacing was deactivated in patients without chronotropic

incompetence. In those with SR and low-grade/intermittent heart block we extended AV delays to avoid RV pacing, and patients with significantly long PR intervals were offered a replacement generator capable of avoiding RV pacing through software such as the managed ventricular pacing (MVP) algorithm by Medtronic. During routine follow-up at 6 months, patients in whom we had made changes to their pacemaker prescription or programming were reassessed in the same way as previously mentioned. The project was designed as an audit to prospectively evaluate the effect of this new pacing-avoidance protocol introduced to the Leeds Pacemaker Clinic. At the time of conducting the audit there was no standard operating procedure regarding device programming, devices were programmed to the personal preference of the cardiac physiologist or were left at manufacturers standard settings.

Patients with significant heart failure, life-threatening and/or severe co-morbidities (severe chronic airways disease or terminal malignancy) were excluded. Patients with an LVEF $\leq 50\%$ and unavoidable RV pacing were also excluded from our audit, since these were randomised into a randomised control trial of upgrade to CRT versus standard PGR.

The primary endpoint was change in LV ejection fraction (LVEF) from baseline to six months. Transthoracic echocardiographic images were recorded on a Vivid 7 imaging system and stored offline on a commercially available analysis system (Echopac, GE, USA). Images were anonymised and analysed in random fashion. LV ejection fraction was calculated using

the mean from three non-paced, normally conducted beats using the modified Simpson's rule (bi-plane). The study was powered based upon an estimate of an improvement in LVEF of 5% of on a baseline LV ejection fraction of 45% (SD 12) in patients requiring >50% ventricular pacing, based upon previous studies of CRT and our own pilot data.(Foley et al., 2009) With these variables, we calculated a proposed cohort of at least 63 individuals to allow us a power of 0.8 and a significance of 0.05.

Secondary endpoints were exercise capacity measured by peak oxygen consumption (pVO_2), quality of life and NT-proBNP levels. Peak oxygen consumption was calculated from the last 15s of a symptom-limited incremental peak exercise test on a treadmill, using breath-by-breath analysis (Medgraphics, St Paul, USA). To measure quality of life, we used the EuroQoL-HF questionnaire,(Cleland et al., 2000) which is sensitive to change in symptoms,(Witte et al., 2005) and relates to outcomes in CHF. For purpose of analysis, quality of life scores from the EuroQoL-HF were converted to a percentage of the maximum score possible. NYHA classification was not used as patients with significant heart failure and airways disease were excluded.

Data analysis was undertaken using SPSS version 18. Normally distributed continuous data are presented as means (95% confidence intervals (CI)). Continuous variables with a skewness statistic outside the range of -1 and +1, are presented as median and interquartile range (IQR). To investigate differences between groups (atrial fibrillation and sinus rhythm) Student's t-

tests for normally distributed variables and Mann-Whitney U test for non-parametric variables (NT-pro-BNP and quality of life) were used. Normally distributed baseline and follow-up data (echocardiographic and cardiopulmonary variables) were analysed using paired t-tests and quality of life and NT-pro-BNP were analysed using two sided Wilcoxon rank sum tests. Correlation coefficients were calculated for continuous baseline variables and for changes in LVEF, and ventricular pacing at follow-up. We corrected for multiple testing using the false discovery rate.(Benjamini Y, 1995) For all analyses the entire cohort was analysed initially, and then subdivided by atrial rhythm AF vs. sinus rhythm.

5.3 Results

Baseline characteristics for the patients included in the audit are presented in table 5.1. Programming of the pacemaker parameters at baseline was consistent with usual practice, with a low BR, reasonably extended A-V delays for those in SR, and rate-adaptive pacing activated in 68% of patients. The only pacing variable different between the two groups was the frequency of rate-adaptive pacing which was more common in patients with AF (X^2 7.1; $p=0.008$).

Table 5.1: Baseline variables in 66 patients with RV pacemakers

	Mean (95% CI) or n [%]
Age (years)	77 (75-79)
Sex (male)	79 [52]
Height (cm)	170 (168-172)
Weight (kg)	79 (75-83)
Remote MI	11 [17]
Remote CVA	3 [5]
Hypertension	31 [47]
Diabetes mellitus	6 [10]
NYHA	2
AF	56 [37]
CABG	15 [23]
Heart rate (beats/min)	73 (69-79)
DBP (mmHg)	72 (68-76)
SBP (mmHg)	128 (122-134)
Sinus rhythm	31 [47]
Paced QRS duration (ms)	165 (153-177)
Intrinsic QRS duration (ms)	94 (88-100)
Years of pacing (years)	10 (8-12)
Proportion of ventricular paced beats (%)	78 (72-83)
Baseline indication (n [%])	
Sinus node disease incl. atrial fibrillation	46 [70]
Atrio-ventricular node disease	13 [20]
Other	7 [10]
Base rate (beats/min)	62 (59-65)
Rate-adaptive pacing percentage (SR/AF)	58 / 82
A-V delays (ms)	
Paced	232 (208-256)
Sensed	223 (203-243)
Furosemide dose (mg) (n=24)	20 (12-28)
Beta-blocker	48 [73]
ACE inhibitor	38 [58]
Warfarin	31 [47]
Quality of life (%) (median, IQR)	83 (18)
Creatinine ($\mu\text{mol/L}$)	119 (109-129)
Estimated GFR (l/min)	57 (53-61)
Haemoglobin (g/dL)	13.7 (13.1-14.1)
B-type natriuretic peptide (pmol/L) (median, IQR)	1368 (2121)
LVEF (%)	43 (39-45)
LVEDD (mm)	52 (50-54)
LVESD (mm)	40 (38-42)
PAP (mmHg)	38 (34-42)
pV_{O_2} (ml/kg/min)(n=45)	19 (17-21)

Values for continuous variables are means (95% CI), or median (IQR) where indicated and for categorical variables are 'n' [%]

MI; myocardial infarction, CVA; cerebrovascular accident, CABG, coronary artery bypass grafting, DBP; diastolic blood pressure, SBP; systolic blood pressure, CHB; complete heart block, ACE-inhibitor; angiotensin-converting enzyme inhibitor, GFR; glomerular filtration rate, LVEF, left ventricular ejection fraction, LVEDD, left ventricular end-diastolic diameter, LVESD; left ventricular end-systolic diameter, PAP; pulmonary artery pressure, pV_{O_2} ; peak oxygen consumption.

Clinical and echocardiographic variables were usual for a cohort of patients with an average of 10 years of right ventricular pacing.(Davy et al., 2012) Patients in AF were more likely to have heart failure symptoms (63% v 51% in NYHA class II; $\chi^2=6.0$; $p<0.05$), larger cardiac dimensions (LVEDD 55mm (52-57) v 49 (46-51); $p=0.003$) and higher NT-pro-BNP levels at baseline (1778 (IQR ng/L 2366) v 485 (IQR 1301); $p=0.003$). LVEF, past medical history and medical therapy were the same across AF and SR patients.

There was a correlation between ventricular pacing percentage (%VP) at baseline and LVEF in patients in sinus rhythm ($r=0.5$; $p=0.03$), but no relationship between %VP at baseline and sensed/paced A-V delays. Also, there was also a relationship between BR and LVEF ($r=0.36$; $p=0.003$), and although this remained significant in patients with AF on when %VP was added into multiple regression, ($r=0.4$; $p=0.05$), LVEF and BR were not independently related in patients with SR.

The reduction in base rate to 50 bpm and the de-activation of rate-adaptive pacing was not tolerated in two of the patients. Both patients were in AF and had their pacemakers reprogrammed to their original settings after one week. These patients were included in the intention to treat analysis.

All patients returned for their 6-month reassessment. At the next pacemaker follow-up mean resting heart rates were lower by 8 (6-10) beats per minute ($p<0.0001$), with no difference between patients in SR or AF. 21 (68%) of the patients in SR received a device with a pacing avoidance algorithm (in whom

programmed AV delays could be shortened), the remainder had a mean increase in AV delay of 100ms.

The pacing avoidance strategy reduced mean RV pacing percentage by 49 (41-57)%, ($p < 0.0001$) from baseline and was higher in patients in SR than in those in AF (-61 (49-73 v -40 (30-50)%; $p = 0.01$). There was an additional reduction in %VP in patients prescribed with devices containing pacing avoidance algorithms, (-67 (52-80) v -53 (28-76), this did not reach significance.

The programming changes as a whole were associated with an improvement in LVEF of 6% ($p < 0.0001$ from baseline) and a reduction in LV cavity dimensions, see Table 5.2.

Table 5.2: Changes in clinical variables following reprogramming to avoid RV pacing

	Pre-intervention	Post-intervention	p-value
Proportion of ventricular paced beats (%)	78 (72-83)	28 (20-36)	<0.0001
Quality of life (%) (median, IQR)	83 (18)	87 (20)	0.43
B-type natriuretic peptide (pmol/L) (median, IQR)	1368 (2121)	1250 (1649)	0.26
LVEF (%)	43 (39-45)	48 (45-51)	<0.0001
LVEDD (mm)	52 (50-54)	50 (49-52)	0.03
LVESD	40 (38-42)	38 (36-40)	0.007
PAP (mmHg)	38 (34-42)	38 (33-42)	0.22
NYHA	2	2	0.18
Peak heart rate (beats/min)	126 (118-134)	124 (116-132)	0.12
pVO ₂ (ml/kg/min)	19 (17-21)	20 (17-23)	0.39

Values for continuous variables are means (95% CI), or median (IQR) where indicated.

LVEF, left ventricular ejection fraction, LVEDD, left ventricular end-diastolic diameter, LVESD, left ventricular end-systolic diameter, PAP; pulmonary artery pressure, pVO₂; peak oxygen consumption. P-values correspond to paired t-tests for normally distributed data and Wilcoxon rank sum tests for quality of life and NT-pro-BNP data

The $\Delta VP\%$ achieved using the pacing avoidance algorithm was higher in patients in SR, but there was no difference in the response for LVEF by atrial rhythm (or by strategy), although patients with AF had a greater magnitude of improvement in LVEDD ($p < 0.02$ between SR and AF). There was no overall change in NT-pro-BNP levels, quality of life or exercise variables (including peak heart rates) in the cohort as a whole or when divided by atrial rhythm.

For the entire cohort, there was a relationship between $\Delta VP\%$ and change in LVEF ($r = 0.26$; $p = 0.04$) (Figure 5.2) and a trend towards a relationship between $\Delta VP\%$ and change in NT-pro-BNP levels ($r = 0.27$; $p = 0.07$). This latter relationship was significant in patients with AF ($r = 0.44$; $p = 0.03$). Also, in patients in AF, despite no improvement in exercise capacity, there were significant inverse relationships between the change in pVO_2 and reduction in RV pacing ($r = 0.66$; $p = 0.005$). Mean quality of life was not influenced by reductions in pacing percentage in either the SR or AF group.

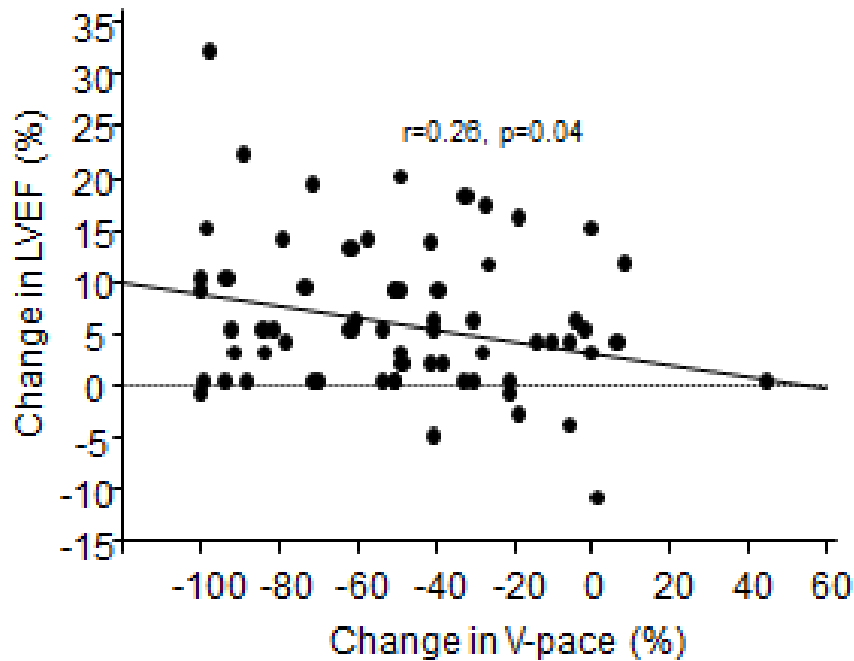

Figure 5.2: The relationship between change in right ventricular pacing percentage (V-pace) and change in left ventricular ejection fraction (LVEF) function at six months

The data presented in Fig 5.2 may be influenced by two cases with significant changes to their LVEF. The first individual had a significant improvement in their LVEF of 32%, and a reduction in RV pacing by 95%. This 74 year male patient had 1st degree AV block, a PR interval of 350ms and no known history of IHD. Right ventricular pacing could not be avoided by extending his AV-delays, so following the pacing reduction algorithm we the patient was implanted with a Medtronic Adapta pacemaker, with MVP mode activated. The second patient was a 79 year old male in AF. There was a reduction in LVEF of 12% and a minor increase in RV pacing percentage of 2%. This patient's clinical situation had deteriorated and was referred to the heart failure clinic for further evaluation.

5.4 Discussion

These data provide the first evidence that reducing unnecessary RV pacing, across a wide range of patients, is associated with improved LV systolic function without adversely affecting exercise capacity or quality of life. The data demonstrating that the degree of RV pacing reduction achieved relates to the degree of improvement in LV function and (in the atrial fibrillation group) the degree of improvement in exercise capacity and NT-pro-BNP, are especially powerful. They add to the already existing hypothesis that that RV pacing is not merely associated with cardiac dysfunction, but also contributes to it.

Heart failure or asymptomatic LVSD is a common finding in patients with permanent pacemakers,(Thackray et al., 2003) and is associated with a poor overall outcome, particularly in patients requiring a high proportion of ventricular pacing. As a result of this observation, cardiac resynchronisation therapy (CRT) upgrades to existing pacemaker systems are common.(Bogale et al., 2011) Data from large randomised studies examining the benefits of upgrade to CRT on LV function, neuro-hormonal activation, quality of life and heart failure hospitalisation are required. Randomised studies would also need to investigate complication rates as upgrading existing devices carries higher risk of subsequent complication than performing a new implant.(Nery et al., 2010) The high prevalence of heart failure in patients requiring a pacemaker for bradycardia has led to studies examining the use of CRT in this setting (Curtis et al., 2013). Unfortunately, due to methodological issues with the single large trial, this

strategy is unlikely to be accepted without further evidence.(Witte, 2014) These data clearly demonstrate that careful reduction of unnecessary RV pacing through reprogramming or pacing avoidance algorithms, can successfully avoid RV pacing or reduce it to levels below which an adverse effect is less likely.(Sweeney et al., 2003) Adding this finding to the previous observation, outlined in the previous chapter, that an implant indication of intermittent complete heart block at implant, is not a reliable guide to the need for long-term frequent RV pacing, nor is reliably associated with subsequent LVSD (unlike %RV pacing in the preceding year), means that selecting patients in whom CRT for bradycardia is likely to be of benefit remains difficult based on current evidence.

The de-activation of rate-adaptive pacing was well tolerated by both groups of patients in this audit. Rate-adaptive pacing is an algorithm designed to increase HR in those with chronotropic incompetence during times of increased demand. Various methods of sensing the presence of increasing demand are available including motion sensors such as accelerometer and piezoelectric systems which sense motion, transthoracic impedance sensors which are designed to detect changes in breathing associated with increased demand, measurement of changes in QT duration associated with exercise, and sensors designed to which detect changes in contractility such as Livanova's SonR lead and Biotronik's CLS system.(Malinowski, 1998, Jutzy et al., 1990, Sulke et al., 1991, Lazarus and Mitchell, 1996, Candinas et al., 1997) There was no reduction in pVO_2 or peak heart rate during cardiopulmonary exercise testing and no difference in quality of life. Rate-

adaptive pacing in pacemaker patients without CHF is associated with a greater cardiac output rise during exercise,(McMeekin et al., 1990) and although studies have shown improvements in exercise capacity ranging from minimal,(Batey et al., 1990, Carmouche et al., 1998) to significant,(Capucci et al., 1992) there is no consistency on improvement in measures of quality of life in either AF or SR.(Lau et al., 1989, Trappe et al., 1988, Haywood et al., 1993) The literature is equally inconsistent about whether rate-adaptive CRT pacing does,(Tse et al., 2005, Sims et al., 2011) or does not,(Van Thielen et al., 2008) improve exercise tolerance in patients with CHF, but there does seem to be no positive effect on quality of life.(Martin et al., 2012) Therefore, these data are consistent with current evidence that rate-adaptive pacing offers little benefit in most patients with pacemakers implanted for bradycardia, but de-activating rate-adaptive pacing can reduce %VP and improve, or preserve, left ventricular systolic function. Furthermore, what is likely, but unproven, is that careful reprogramming, providing a 'sleep' or hysteresis rate, and in doing so reducing %VP, has the long-term benefit of prolonging battery life.

68% of patients with SR (n=21) received a pacemaker with a pacing-avoidance algorithm at PGR. Previous work investigating these algorithms has focussed on their efficacy at reducing RV pacing and associated AF in patients with sinus node disease.(Kolb et al., 2011, Sweeney et al., 2007, Davy et al., 2012) These data endorse for the first time that the reduction of unnecessary RV pacing with these algorithms contributes to an improvement in LVEF.

Finally, this dataset contributes to the literature in one further critical way. There is some inconsistency about whether RV pacing contributes to LV dysfunction,(Riahi et al., 2012) or is merely associated with it. By reducing the exposure to a proposed aetiological factor, in this case RV pacing, and observing an improvement in a condition, we have confirmed one of the rules of causation.(Hill, 1965)

5.5 Limitations

This study is a significant proof of concept analysis of data, collected from a non-selected cohort of consecutive patients, to a clinic designed to assess patients prior to PGR. The intervention was not applied in a randomised, double blind fashion and the results of the analysis must be interpreted in light of this. But, programming changes and data collection followed a robust standardized process in consecutive patients. And the analysis of the echocardiographic images, cardio-pulmonary exercise test and NT-pro-BNP results, and pacing data presented in this report was performed on an intention-to-treat basis in a randomised, blinded fashion by a single experienced cardiac physiologist. We were careful to avoid altering medical therapy over the six month follow-up period, although the patients' usual physicians were free to do so. Hence we are confident that the changes presented are purely due to modifications in pacemaker therapy. A larger study would require randomization to correct for non-device treatments.

Other limitations include that the study was carried out in a single centre and that the outcomes variables are surrogates for hospitalization and mortality.(Foley et al., 2009) The shortcomings of surrogate endpoints are typical of proof of concept small scale studies. In order to establish the benefits of pacemaker reprogramming to reduce unnecessary RV pacing, on heart failure events in an unselected population of patients a larger randomised, placebo-controlled study with longer follow-up is required to provide robust efficacy and cost effectiveness data.

5.6 Conclusions

In an unselected cohort of consecutive patients without complete heart block, I have demonstrated that reducing RV pacing is possible with no adverse effects on symptoms, exercise capacity or quality of life. This strategy is associated with improved LVEF, suggesting that RV pacing contributes to LV dysfunction in patients with pacemakers. The time of PGR might be an opportunity to optimise pacing prescription.

Chapter 6. Cardiac resynchronization therapy in pacemaker-dependent patients with left ventricular dysfunction.

Hypothesis – Upgrading to cardiac resynchronization therapy, at the time of battery replacement, improves left ventricular systolic function in a cohort of patients awaiting pacemaker battery replacement.

6.1 Introduction

It is increasingly recognised that patients with complete heart block, dependent upon their pacemaker, are at increased risk of prevalent left ventricular systolic dysfunction and increased risk of presenting with heart failure in the future. (Zhang et al., 2008) There is enthusiasm to implant a CRT device into people with complete heart block and left ventricular systolic dysfunction, although in patients with modest LVSD and few symptoms, there are few data to support this practice. I became aware that in addition to a dilemma at the time of initial implant, this is also a problem at generator replacement. I have described in chapter 4 that I found a high prevalence of mildly symptomatic left ventricular systolic dysfunction in these people. There was no published evidence to describe what should be done in the absence of reprogramming options. An upgrade procedure to CRT is a logical option, but comes at a cost in terms of complications, and cost. The aim of this study therefore was to investigate the effect of elective CRT

upgrade at pacemaker generator replacement versus standard care in patients with mildly symptomatic LVSD and mandatory RV pacing.

6.2 Methods

Adult patients, referred for a pacemaker pulse generator replacement were recruited into a randomised, placebo-controlled trial of pacemaker upgrade to CRT versus standard pulse generator replacement (PGR), see Fig 6.1. Inclusion criteria included unavoidable high rates of RV pacing (>80%), LVSD (left ventricular ejection fraction (LVEF) <50%), and mild to no symptoms of heart failure. Exclusion criteria included life-threatening or severe co-morbidity (severe chronic airways disease or terminal malignancy), suboptimal non-invasive imaging quality, recent heart failure hospitalisation, documented ventricular tachy-arrhythmia, and inability or unwillingness to provide consent.

As previously described, all patients listed for pacemaker pulse generator replacement at Leeds General Infirmary were invited to attend an assessment session prior to the procedure. Each subject underwent transthoracic echocardiography, completed a quality of life questionnaire, had a blood test for renal function, blood count and N-terminal proB-type natriuretic peptide (NT-proBNP) measurement, and where possible, a treadmill based cardiopulmonary exercise test was performed to document peak oxygen consumption (pVO_2).

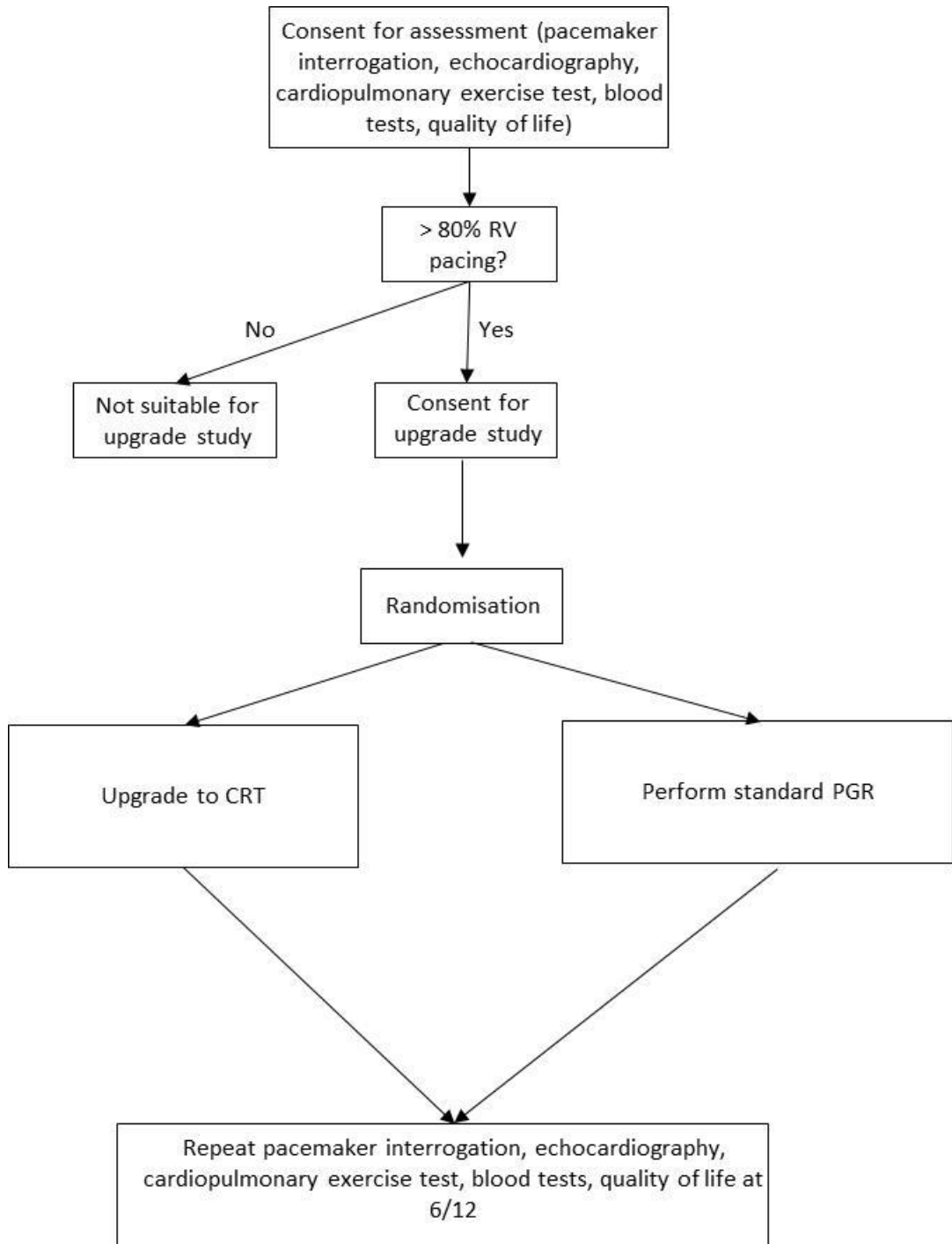

Figure 6.1: Study protocol

After the assessment, consecutive patients eligible to participate in the present study, were offered an information sheet, and those interested in taking part were asked to sign a consent form. Subjects were randomised, via a telephone randomisation service provided by the clinical trials unit at

the University of Leeds School of Medicine, to receive either a standard PGR or upgrade to CRT.

Upgrade to CRT or PGR was performed within two weeks of the date of consent. In patients randomised to receive upgrade to CRT all implants were performed by the same, experienced consultant cardiologist. Venous access, coronary sinus cannulation and left ventricular lead placement were performed as usual practice, with a lateral position of the left ventricular lead electrodes attempted. To limit infection risk, the pacemaker capsule was not opened until the left ventricular lead was optimally positioned. Following this, the right heart leads were electrically tested as normal, and all three leads were connected to either a Medtronic Insync III or Consulta P generator (Medtronic, Minneapolis, USA). This pacemaker was then programmed to simultaneous left and right ventricular stimulation, other pacemaker variables were kept unchanged. Echocardiographic or electrical optimisation was not performed. Patients receiving a standard PGR were scheduled via the usual method, and had their procedure performed by a consultant or specialist registrar. Patients maintained their usual pacemaker follow-up schedule and were invited back for a repeat assessment at six months post upgrade/PGR.

The primary endpoint was the difference, in the change in LVEF from baseline to six months, between the two groups. Transthoracic echocardiographic images were recorded on a Vivid 7 imaging system and stored offline on a commercially available analysis system (Echopac, GE, USA). Anonymised images were analysed in random fashion at the end of

the study by a single blinded observer. Based upon existing observational work, a clinically significant improvement in LVEF of 5% in the CRT arm, and no change in LVEF in the PGR group at six months was estimated. In the sample size calculation, an LV lead implant failure rate of around 8% was allowed for, and a loss to follow up of 5% was also included. To have a power of 90% in a two-sided independent samples t-test to detect the 5% difference we calculated that we would need to recruit 50 patients (25 to each arm).

Secondary endpoints included exercise capacity measured by peak oxygen consumption (pVO_2), NT-proBNP levels and quality of life. pVO_2 was calculated from the last 30s of a symptom-limited incremental peak exercise tolerance test on a treadmill or stationary cycle. Gas exchange was measured using breath-by-breath analysis (Medgraphics, St Paul, USA). To assess quality of life, the EuroQoL-HF questionnaire was used.(Cleland et al., 2000) The EuroQoL-HF questionnaire is sensitive to symptom changes and relates to outcomes, in CHF.(Witte et al., 2005, Cleland et al., 2003a) To simplify analysis, quality of life scores from the EuroQoL-HF were converted to a percentage of the expected maximum. A combined endpoint of all-cause hospitalisation and mortality until the end of the follow-up period for all patients was completed. Digital and paper hospital and general practice records were accessed to confirm cause and duration of admission and cause of death.

Baseline variables were presented as means (95% confidence intervals). Analysis of baseline and follow-up data was undertaken on an intention-to-treat basis. The study was approved by Leeds West Local Research Ethics Committee and Research and Development at Leeds Teaching Hospitals NHS Trust. SPSS version 18 was used for data analysis.

6.2 Results

Baseline characteristics for the enrolled patients can be seen in table 6.1. The indication for pacemaker implant was CHB in all but five patients, whose initial indication was SSS but who had later developed AV conduction tissue disease. Patients randomized to CRT implant had a longer procedural time and a higher mean radiation dose than those receiving an RV-PGR (Table 6.2). There were no immediate post-procedural or early complications, and there were no long-term complications up to the censor date of 1 May 2012. In the CRT arm, there was one implant failure due to superior vena cava stenosis, therefore it was not possible to implant an LV lead. This patient received a RV-PGR, but as per the pre-specified analysis plan, was included in the CRT arm for the analysis.

Table 6.3 shows the changes from baseline to 6 months in patients randomized to upgrade to CRT or standard RV-PGR. In the CRT group there was an improvement in LV function (Figure 6.2 and 6.3). In patients randomized to CRT there was also an improvement in peak exercise capacity, AT (which could not be measured in 7 patients) an improvement in

quality of life and a reduction in NT-proBNP levels. There was no heterogeneity in any of the four outcomes with respect to baseline atrial rhythm, with patients in AF demonstrating an improvement in cardiac function, exercise capacity, BNP, and quality of life from baseline, of similar degree to the changes seen in patients with sinus rhythm. The only variable to behave differently by atrial rhythm was Δ LV end-diastolic diameter (LVEDD), which did not change in patients with sinus rhythm but was significantly reduced by CRT in patients with atrial fibrillation ($P = 0.019$). So, although CRT was associated with a reduction in LVEDD overall, it did not reach statistical significance for the group overall.

Table 6.1: Baseline variables

	CRT (n=25)	RV (n=25)
Age (years)	77 (73-81)	77 (73-81)
Sex (male)	16	16
Height (cm)	164 (156-172)	166 (162-170)
Weight (kg)	82 (74-90)	73 (67-80)
Remote MI (n)	5	6
Remote CVA (n)	1	1
Hypertension (n)	14	10
Diabetes mellitus (n)	4	7
CABG (n)	6	7
Heart rate (bts/min)	77 (71-83)	68 (62-74)
DBP (mmHg)	66 (70-62)	71 (65-77)
SBP (mmHg)	120 (110-130)	139 (125-153)
Sinus rhythm (n)	20	17
QRS duration (ms)	168 (160-176)	159 (149-169)
Years of pacing (years)	10 (8-12)	12 (10-14)
Beta-blocker (n)	14	13
ACE inhibitor (n)	18	19
Warfarin (n)	5	6
Quality of life (%)	82 (76-88)	87 (83-91)
Creatinine (µmol/L)	117 (107-127)	119 (105-133)
Estimated GFR (l/min)	56 (50-62)	55 (49-61)
Haemoglobin (g/dL)	13.6 (13.0-14.2)	13.4 (12.6-14.2)
B-type natriuretic peptide (pmol/L)	1613 (570-2656)	977 (471-1483)
LVEF (%)	39 (35-43)	41 (37-45)
LVEDD (mm)	50.6 (47.7-53.5)	49.2 (46.2-52.1)
PAP (mmHg)	34 (28-40)	33 (29-37)
pVo ₂ (ml/kg/min)	14.2 (12-16)	15.8 (13-18)
AT (ml/kg/min)	11.1 (9-13)	11.3 (9-13)

Values are means (CI).

MI; myocardial infarction, CVA; cerebrovascular accident, CABG, coronary artery bypass grafting, DBP; diastolic blood pressure, SBP; systolic blood pressure, CHB; complete heart block, ACE-inhibitor; angiotensin-converting enzyme inhibitor, GFR; glomerular filtration rate, LVEF, left ventricular ejection fraction, LVEDD, left ventricular end-diastolic diameter, PAP; pulmonary artery pressure, pVo₂; peak oxygen consumption.

Table 6.2: Implant data

	CRT (n=25)	RV (n=25)
Implant duration (min)	66 (54-78)	51 (43-59)
Fluoroscopy time (min)	12.2 (6.3-18.4)	1.3 (0.4-2.1)
Dose (mGy)	2578 (1214-3942)	298 (102-494)

Values are means (CI)

Table 6.3: Changes in outcomes variables between groups from baseline to six months

	CRT (n=25)	RV (n=24)	p-value
Δ LVEF (%)	9 (6-12)	-1.5 (-4.5-0.8)	<0.0001
Δ pVO ₂ (ml/kg/min)	2.1 (0.5-2.7)	-0.5 (-1.6-0.4)	0.007
Δ Quality of life (%)	2.3 (-0.3-11.1)	-2.0 (-3.5-0.0)	0.007
Δ NT-proBNP (pmol/L)	-56 (-437-218)	85 (-15-492)	0.03
Δ AT (ml/kg/min)	0.7 (0.1-1.2)	- 0.4 (-1.1-0.2)	0.01

Values are medians (interquartile range)

LVEF; left ventricular ejection fraction, pVO₂; peak oxygen consumption, N-terminal pro B-type natriuretic peptide

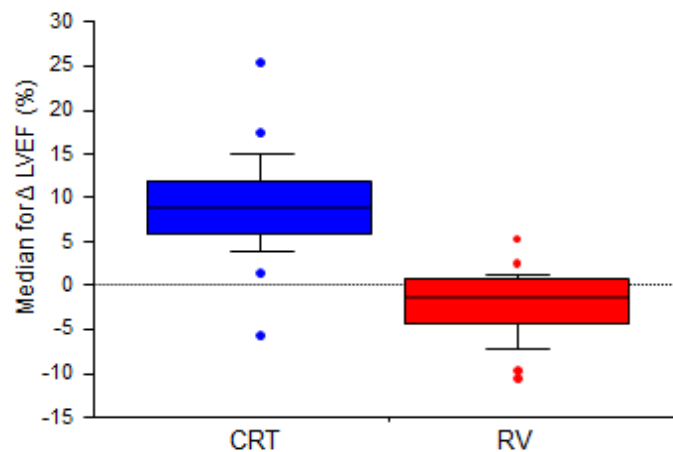

Figure 6.2: Median change in left ventricular ejection fraction (LVEF) in cardiac resynchronisation therapy (CRT) group and standard right ventricular pulse generator group (RV-PGR) from baseline to follow-up at six months.

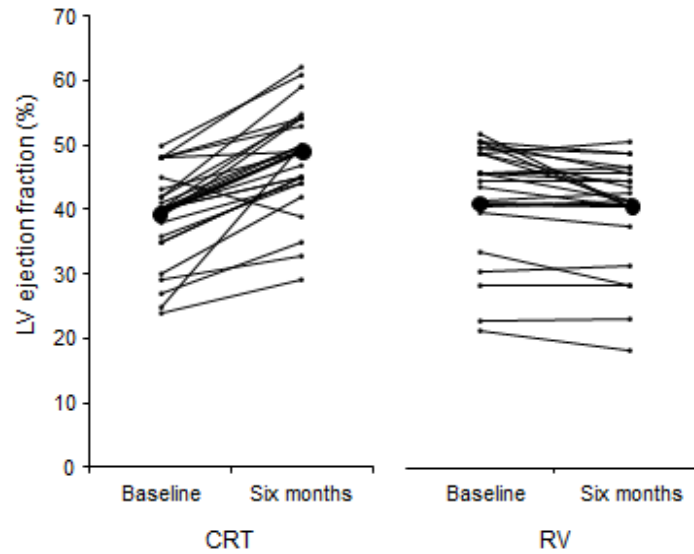

Figure 6.3: The effect of CRT or RV-PGR on left ventricular ejection fraction (LVEF) at six months.

Mean follow-up duration at the censor date of 1 May 2012 was 809 (729 – 880) days. During this time three patients had died, one in the CRT arm and two in the RV-PGR arm. The combined exploratory endpoint of death or all-cause hospitalization was not statistically different between the arms: 17 patients had died or been hospitalized for any cause (6 in CRT group and 11 in the RV-PGR group). Mean (CI) days in hospital was 8 (4 – 12) days, with a trend to fewer days in hospital in those randomized to CRT than those receiving standard PGR [4 (2 – 7) vs. 11 (6 – 16) days; $p=0.047$]. Two patients in the RV-PGR were upgraded to CRT for worsening heart failure within this extended follow-up period.

6.3 Discussion

Upgrade to CRT at the time of standard pacemaker PGR in patients with unavoidable RV pacing and LVSD leads to clinically and statistically

significantly improved LV function, quality of life, and exercise capacity, and reductions in N-terminal pro-B-type natriuretic peptide levels. Upgrade to CRT was associated with fewer all-cause hospitalizations and fewer subsequent interventions, and if this pattern is reproduced in larger studies, it may therefore be cost-effective.

Heart failure or asymptomatic LVSD is a common finding in patients with permanent pacemakers implanted for bradycardia,(Thackray et al., 2003, Wilkoff et al., 2002) and is associated with a poor overall outcome, particularly in patients requiring a high amount of ventricular pacing. What the optimal management plan of pacemaker-associated LVSD has never been formally established. Many of the studies of device and medical therapy for CHF have excluded patients with pacemakers, and the numbers have been inadequate to justify a subgroup analysis, in those that did not exclude this group. Specifically, CRT improves cardiac function, symptoms and outcomes in CHF patients,(Cleland et al., 2000, Cazeau et al., 2001, Abraham et al., 2002, Bristow et al., 2004) and is indicated (class I recommendation, level of evidence A) for patients with LVSD (LVEF \leq 35%), ongoing or prior CHF symptoms (NYHA class III and IV) and surface ECG interventricular conduction delay,(McMurray et al., 2012, Daubert et al., 2012, Epstein et al., 2013) but thus far has not been the focus of a randomized controlled study in patients with RV pacemakers and high levels of RV pacing due to heart block.

Observational studies have proposed that upgrading existing RV pacing systems to CRT in patients with CHF leads to comparable improvements in cardiac function and symptoms as new CRT implants,(Tang et al., 2010, Nagele et al., 2008, Wokhlu et al., 2009, Frohlich et al., 2010) and international guidelines briefly discuss the potential of upgrading existing RV pacemakers to CRT as part of the management of severe CHF but acknowledge the lack of data to support such a policy. Regardless of the lack of randomized data, upgrades of existing pacemakers to CRT devices are frequently performed in Europe and the USA.(Marinskis et al., 2012, Poole et al., 2010) The data from European studies suggest that patients receiving an upgrade to CRT have no greater mortality or complication risk than those receiving a new implant of mortality or complications.(Marinskis et al., 2012) There have only been two other randomized studies of upgrading existing right ventricular pacemakers to CRT. Both were done in patients who were younger than those included in this study. In the 1st study, in 10 patients with heart failure, there were acute improvements in LV function, symptoms, and BNP levels following upgrade to CRT.(Hoijer et al., 2006) In the 2nd study, 36 patients with existing right ventricular pacemakers, LV systolic dysfunction (LVEF <40%) and without heart failure symptoms, demonstrated improved cardiac function following upgrade to CRT.(van Geldorp et al., 2010)

Performing an upgrade to an existing RV pacemaker carries a higher complication risk than performing a new implant.(Poole et al., 2010, Nery et al., 2010) This is due to potential damage to existing leads, possibility of

limited venous access and risk of infection.(Jones et al., 2008, Bongiorni et al., 2008) In the 2nd randomised study discussed above, 5 of the 36 patients enrolled required further intervention (including one thoracotomy) to achieve CRT pacing. The 'Resynchronization – defibrillation for ambulatory heart failure trial' (RAFT) randomized patients referred for ICD without severe heart failure symptoms to a standard ICD or CRT-D. Patients recruited to the study with existing pacemakers did not benefit from upgrade to CRT, even if their paced QRS duration was <200 ms. (Bogale et al., 2011) Therefore, it cannot be assumed that an upgrade to CRT, in a patient with severe CHF and an existing pacemaker will be beneficial.

Preliminary data, of a randomized controlled trial data in patients with LV systolic dysfunction requiring a pacemaker to treat bradycardia, demonstrated better LV function in those receiving CRT vs. RV pacing.(Kindermann et al., 2006)

The 'Biventricular versus right ventricular pacing in heart failure patients with atrioventricular block' (BLOCK HF) study suggests that patients requiring a pacemaker for AV block, with mild LVSD, will benefit from de novo CRT over RV pacing in terms of the effects of CRT on a combined outcome of all-cause mortality, heart failure hospitalization, and deterioration in LV function. (Curtis et al., 2013) Higher complication rates than what would occur with standard RV pacing were reported, as all patients were implanted with a CRT device. Further questions remain as to whether this approach is clinically or cost-effective vs. carefully programmed RV pacing.

The present study is the first randomized, placebo controlled study on how patients with an existing RV pacemaker requiring a battery replacement and mildly symptomatic LVSD should be managed. CRT reduces hospitalisations in patients with mild symptoms, LVSD and conduction delay.(Linde et al., 2008, Moss et al., 2009) The present study provides additional data about CRT in patients with standard pacemakers, high levels of RV pacing and mild symptoms of heart failure. The study results propose a strategy that may allow additional procedures, and their additional risks and costs, to be avoided in some patients. If this data suggesting reduced hospitalizations were to be reproduced in further studies, this strategy might be cost-effective also.

6.4 Limitations

The present study is an important proof of concept study, but requires further evaluation of efficacy and cost effectiveness. The study has limitations including being single centre, both the study physician and patients were unblinded and the end-points are surrogates for prognosis. Surrogate endpoints can be disadvantageous in small proof-of-concept studies, and LV ejection fraction has come under scrutiny in recent CRT studies as a poor marker for outcome.(Foley et al., 2009) However, there was consistent change in each of my endpoints including exercise capacity and quality of life, and the extended follow-up data suggest potential benefits in definitive outcomes, requiring a larger study or longer follow-up to confirm.

6.5 Conclusions

Heart failure is common in patients with pacemakers and relates to hospitalization and mortality,(Thackray et al., 2003, Wilkoff et al., 2002) but patients with pacemakers were frequently excluded from studies of medical therapy for heart failure, the benefits of medical or device therapy in this population is unknown. My data demonstrate that LVSD combined with unavoidable RV pacing responds to upgrade to CRT, and that upgrade to CRT at the time of PGR may be an opportunity to optimize pacing therapy. Further evaluation of whether a coordinated programme of risk stratification, device programming, device prescription and optimized medical therapy at the time of PGR could lead to improved outcomes and cost-effective patient care is justified in this patient group.

Chapter 7. Discussion

Pacemakers are an extremely effective treatment for bradycardia, with robust evidence in support of their positive effects on mortality and quality of life. The field of electrophysiology has progressed from early recognition of the link between the pulse and syncope in around 400 BC, through curiosity driven experiments of the effects of electrical stimulation on animal hearts, to modern pacemaker therapy. Current pacemakers are a complex, reliable medical technology that not only treat bradycardia, but also provide a wealth of diagnostic including information on heart rhythm abnormalities, patient activity and can also transmit diagnostic information via the telecommunications network.

However, pacemakers represent a double-edged sword. They treat bradycardia effectively, whilst also putting patients at risk of LVSD due to the detrimental effects of RV pacing. RV pacing is still an accepted way to induce experimental left ventricular systolic dysfunction (LVSD) in animal models of chronic heart failure (CHF), and landmark trials such as - the Dual-chamber pacing or ventricular backup pacing in patients with an implantable defibrillator: the Dual Chamber and VVI Implantable Defibrillator (DAVID) trial, provided robust evidence of the potential adverse effects in humans. This led to a drive by the pacemaker industry to develop device based algorithms to reduce unnecessary RV pacing where possible.

This thesis provides novel information that right ventricular (RV) pacing is a contributory factor in the development of left ventricular systolic dysfunction (LVSD) and chronic heart failure (CHF). It does this by providing observational and interventional datasets to describe causation.

My data include the first study to systematically explore a current cohort of patients undergoing standard pacemaker generator replacement (Chapter 4). I have identified a dose-response in RV pacing and LVSD and that the effect of this is related to co-morbidities especially coronary artery disease or myocardial infarction. My data suggest that patients at higher risk of prevalence HF or LVSD can be identified using simple clinical and pacemaker-related variables. I also demonstrated that LVSD was the strongest predictor of mortality in patients with an RV pacemaker.

Chapter 5 describes the first ever study to explore the effects of RV pacing avoidance on LV function. I have shown that reducing unnecessary RV pacing improves LV systolic function without impairing exercise capacity and quality of life in a representative group of consecutive patients

Chapter 6 includes data from the first randomized, placebo controlled study on the effects of elective CRT upgrade in people with mild or no symptoms of heart failure and LVSD requiring PGR. I proved that this approach improves LVEF, exercise capacity and symptoms even in these mildly symptomatic patients, while it also seems to lead to reduced hospitalisations and mortality.

At present the follow-up of pacemakers is limited to technical aspects of the device functionality. The totality of my data indicates that pacemaker patients should have a regular review of indication, programming and cardiac function which could be undertaken by non-physician specialists working and empowered by series of guidelines based upon my work that could be particularly important at the time at which battery replacement is contemplated. Widespread clinical adoption of the evidence provided in this thesis, by identifying patients at risk of heart failure, and describing possible therapeutic options including optimisation of programming and pre-emptive CRT could improve the quality of life and prognosis of patients with pacemakers throughout the world, whilst also being cost-effective in reducing further expensive upgrade procedures and reducing admissions.

List of Abbreviations

American Heart Association	AHA
Angiotensin-converting enzyme inhibitors	ACEI
Atrial Fibrillation	AF
Atrioventricular	AV
Atrioventricular Node	AVN
Anaerobic Threshold	AT
Beats per Minute	BPM
Beta-Blocker	BB
British Society of Echocardiography	BSE
Cardiac Resynchronisation Therapy	CRT
Cardiopulmonary Exercise Test	CPX
Chronic Heart Failure	CHF
Cardiac Output	CO
Complete Heart Block	CHB
Coronary Artery Bypass Grafting	CABG
Coronary Artery Disease	CAD
Diabetes Mellitus	DM
Dilated Cardiomyopathy	DCM
Ejection Fraction	EF

Electrocardiograph	ECG
European Society of Cardiology	ESC
Heart Failure with mid-range Ejection Fraction	HFmrEF
Heart Failure with Preserved Ejection Fraction	HFpEF
Heart Failure with Reduced Ejection Fraction	HFrEF
Heart Rate	HR
Hypertension	HTN
Implantable Cardioverter Defibrillator	ICD
Ischaemic Heart Disease	IHD
Left Bundle Branch Block	LBBB
Left Ventricle	LV
Left Ventricular Ejection Fraction	LVEF
Left Ventricular Systolic Dysfunction	LVSD
Myocardial Infarction	MI
National Institute for Health and Care Excellence	NICE
Naturetic Peptides	NP
New York Heart Association	NYHA
Peak Oxygen Consumption	pVO ₂
Percutaneous Coronary Intervention	PCI
Pulse Generator Replacement	PGR
Renin Angiotensin Aldosterone System	RAAS

Randomised Control Trial	RCT
Right Ventricle	RV
Right Ventricular Outflow Tract	RVOT
Sick Sinus Syndrome	SSS
Sinus Node	SN
Sinus Node Disease	SND
Sinus Rhythm	SR
Standard Deviation	SD
Standard Error	SE
Superior Vena Cava	SVC
Transthoracic Echocardiogram	TTE
Ventilation	VE

Appendix A – What is the prevalence of left ventricular dysfunction in pacemaker patients requiring a battery replacement? - Ethical approval



National Research Ethics Service

Leeds (West) Research Ethics Committee

A/B Floor, Old Site
Leeds General Infirmary
Great George Street
Leeds
LS1 3EX

Telephone: 0113 3923181
Facsimile: 0113 392 2863

20 February 2008

Dr Klaus K Witte
Senior Lecturer in cardiology
University of Leeds
LIGHT building

Dear Dr Witte

Full title of study: The prevalence and effects on exercise tolerance of left ventricular dysfunction in the Leeds pacemaker population.
REC reference number: 08/H1307/12

Thank you for your letter of 13 February 2008, responding to the Committee's request for further information on the above research and submitting revised documentation.

The further information has been considered on behalf of the Committee by the Chair.

Confirmation of ethical opinion

On behalf of the Committee, I am pleased to confirm a favourable ethical opinion for the above research on the basis described in the application form, protocol and supporting documentation as revised.

Ethical review of research sites

The Committee has designated this study as exempt from site-specific assessment (SSA). There is no requirement for [other] Local Research Ethics Committees to be informed or for site-specific assessment to be carried out at each site.

Conditions of approval

The favourable opinion is given provided that you comply with the conditions set out in the attached document. You are advised to study the conditions carefully.

Approved documents

The final list of documents reviewed and approved by the Committee is as follows:

Document	Version	Date
Application	2	16 January 2008
Investigator CV	Klaus K Witte	19 December 2007
Investigator CV	J Gierula	
Protocol	1.1	13 February 2008

This Research Ethics Committee is an advisory committee to Yorkshire and The Humber Strategic Health Authority
The National Research Ethics Service (NRES) represents the NRES Directorate within
the National Patient Safety Agency and Research Ethics Committees in England

Covering Letter		19 December 2007
Summary/Synopsis	V1 (In Protocol)	19 December 2007
GP/Consultant Information Sheets		19 December 2007
Participant Information Sheet	1.1	13 February 2008
Participant Consent Form	1.1	13 February 2008
Response to Request for Further Information		13 February 2008
Evidence of Insurance	University of Leeds	24 September 2007

R&D approval

All researchers and research collaborators who will be participating in the research at NHS sites should apply for R&D approval from the relevant care organisation, if they have not yet done so. R&D approval is required, whether or not the study is exempt from SSA. You should advise researchers and local collaborators accordingly.

Guidance on applying for R&D approval is available from <http://www.rdforum.nhs.uk/rdform.htm>.

Statement of compliance

The Committee is constituted in accordance with the Governance Arrangements for Research Ethics Committees (July 2001) and complies fully with the Standard Operating Procedures for Research Ethics Committees in the UK.

After ethical review

Now that you have completed the application process please visit the National Research Ethics Website > After Review

Here you will find links to the following

- a) Providing feedback. You are invited to give your view of the service that you have received from the National Research Ethics Service on the application procedure. If you wish to make your views known please use the feedback form available on the website.
- b) Progress Reports. Please refer to the attached Standard conditions of approval by Research Ethics Committees.
- c) Safety Reports. Please refer to the attached Standard conditions of approval by Research Ethics Committees.
- d) Amendments. Please refer to the attached Standard conditions of approval by Research Ethics Committees.
- e) End of Study/Project. Please refer to the attached Standard conditions of approval by Research Ethics Committees.

We would also like to inform you that we consult regularly with stakeholders to improve our service. If you would like to join our Reference Group please email referencegroup@nationalres.org.uk.

08/H1307/12	Please quote this number on all correspondence
--------------------	---

With the Committee's best wishes for the success of this project

Yours sincerely



Laura Sawiuk
REC Co-ordinator
On Behalf of
Mr Jon Silcock
Chair

Email: laura.sawiuk@leedsth.nhs.uk

Enclosures: *Standard approval conditions*

Copy to: Mr Clare Skinner, University of Leeds
R&D, Leeds Teaching Hospitals NHS Trust

Appendix B – What is the prevalence of left ventricular dysfunction in pacemaker patients requiring a battery replacement? - LTHT R&D approval

The Leeds Teaching Hospitals 
NHS Trust

30/01/2008

Research & Development Directorate
A/B Corridor, Old Site

The General Infirmary at Leeds
Great George Street
Leeds
West Yorkshire
LS1 3EX

Dr Klaus Witte
Senior Lecturer in Cardiology
LIGHT Building
University of Leeds

Tel: 0113 392 2878
Fax: 0113 392 6397

www.leedsteachinghospitals.com

Dear Dr Klaus Witte

Re: LTHT R&D Approval of CD08/8474: The prevalence and effects on exercise tolerance of left ventricular dysfunction in the Leeds pacemaker population.

I write with reference to the above research study. I can now confirm that this study has R&D approval and the study may proceed at The Leeds Teaching Hospitals NHS Trust (LTHT). This organisational level approval is given based on the information provided in the documents listed below.

As principal investigator you have responsibility for the design, management and reporting of the study. In undertaking this research you must comply with the requirements of the *Research Governance Framework for Health and Social Care* which is mandatory for all NHS employees. This document may be accessed on the Department of Health website at <http://www.dh.gov.uk/research>

R&D approval is therefore given on the understanding that you comply with the requirements of the *Framework* as listed in the attached sheet "Conditions of Approval".

If you have any queries about this approval please do not hesitate to contact the R&D Department on telephone 0113 392 2878.

Indemnity Arrangements

The Leeds Teaching Hospitals NHS Trust participates in the NHS risk pooling scheme administered by the NHS Litigation Authority 'Clinical Negligence Scheme for NHS Trusts' for: (i) medical professional and/or medical malpractice liability; and (ii) general liability. NHS Indemnity for negligent harm is extended to researchers with an employment contract (substantive or honorary) with the Trust. The Trust only accepts liability for research activity that has been managerially approved by the R&D Department.

Chairman Martin Buckley Chief Executive Maggie Boyle

The Leeds Teaching Hospitals incorporating: Chapel Allerton Hospital Cookridge Hospital Leeds Chest Clinic
Leeds Dental Institute Seacroft Hospital St James's University Hospital The General Infirmary at Leeds
Wharfedale Hospital

The Trust therefore accepts liability for the above research project and extends indemnity for negligent harm to cover you as principal investigator and the researchers listed on the R&D approval form provided that each member of the research team has an employment contract (substantive or honorary) with the Trust. Should there be any changes to the research team please ensure that you inform the R&D Department and that s/he obtains an employment contract with the Trust if required.

Yours sincerely



Dr D R Norfolk
Associate Director of R&D

Approved documents

The documents reviewed and approved are listed as follows

<i>Document</i>	<i>Version</i>	<i>Date of document</i>
Protocol	1.0	19/12/07
SSI Form	5.5	17/01/08
CMT Approval		21/01/08
NHS REC Application Form	5.5	17/01/08

Conditions of R&D Approval

- Approval from your local Clinical Management Team must be obtained before starting the study.
 - Approval of the appropriate Research Ethics Committee, where necessary, must be obtained before starting the study. Any changes made to the project during ethical review must be reviewed and approved by the R&D Department to maintain R&D Approval status.
 - Arrangements must be made to ensure that all members of the research team, where applicable, have employment contracts with the Trust (either full or honorary).
 - Agreements must be in place with appropriate support departments regarding the services required to undertake the project and arrangements must be in place to recompense them for the costs of their services.
 - Arrangements must be in place for the management of financial and other resources provided for the study, including intellectual property arising from the work.
 - Priority should be given at all times to the dignity, rights, safety and well being of participants in the study
 - Healthcare staff should be suitably informed about the research their patients are taking part in and information specifically relevant to their care arising from the study should be communicated promptly.
 - Each member of the research team must be qualified by education, training and experience to discharge his/her role in the study. Students and new researchers must have adequate supervision, support and training.
 - The research must follow the protocol approved by the relevant research ethics committee. Any proposed amendments to or deviations from the protocol must be submitted for approval to the Research Ethics Committee, the research sponsor, regulatory authority and any other appropriate body. The R&D Department should be informed where the amendment has resource implications within the CMT and the CMT research lead/clinical director notified.
 - Any adverse events/adverse drug reactions must be reported to the appropriate research ethics committee, research sponsor and any other regulatory authority. Adverse events in clinical trials of investigational medicinal products must be reported in accordance with the Medicines for Human Use (Clinical Trials) Regulations 2004. All serious adverse events as defined in the research protocol,
-

that occur within LTHT should be reported via the IR1 reporting system to the Risk Management Department, Trust Headquarters, St James's University Hospital, Beckett Street, Leeds LS9 7TF.

- Reports on the progress and outcomes of the work must be produced on time and to an acceptable standard. Please send a copy of the progress report produced for the Research Ethics Committee to the R&D Department for monitoring.
- Procedures should be in place to ensure collection of high quality, accurate data and the integrity and confidentiality of data during processing and storage.
- Arrangements must be made for the appropriate archiving of data when the research has finished. Records must normally be kept for 15 years.
- All data and documentation associated with the study must be available for audit at the request of the appropriate auditing authority. Currently 10% of REC approved projects are randomly selected for audit inspection by the R&D Department each year. You will be informed by letter if your study is selected.
- Findings from the study should be disseminated promptly and fed back as appropriate to research participants.
- Findings from the study should be exposed to critical review through accepted scientific and professional channels.

Commercially Sponsored Trials

If the study is commercially sponsored approval is given subject to provision of the following documents.

- Clinical Trials Agreement - agreed and signed off by the R&D Department (on behalf of the Leeds Teaching Hospitals NHS Trust) and the Sponsor.
- Indemnity agreement, if not included in the Clinical Trials Agreement- (standard ABPI no fault arrangements apply) signed by the R&D Department and the Sponsor

It is essential that all the responsibilities set out in the Research Governance Framework and outlined above are fulfilled. The Trust reserves the right to withdraw R&D approval for a study, and therefore the provision of indemnity cover (for negligent harm) for its employees, where it is found that the above criteria have not been met. The Trust will not accept liability for any activity that has not been fully approved.

Appendix C – Cardiac resynchronization therapy in pacemaker-dependent patients with left ventricular dysfunction - ethical approval



National Research Ethics Service

Leeds (West) Research Ethics Committee

A/B Floor, Old Site
Leeds General Infirmary
Great George Street
Leeds
LS1 3EX

Telephone: 0113 392 6788
Facsimile: 0113 392 2863

15 July 2008

Dr Klaus K Witte
Senior Lecturer in Cardiology
LIGHT building
Leeds University
LS9 5JT

Dear Dr Witte

Full title of study: Pacemaker upgrade to cardiac resynchronisation in patients with left ventricular dysfunction dependant upon right ventricular pacing
REC reference number: 08/H1307/47

Thank you for your letter of 26 March 2008, responding to the Committee's request for further information on the above research and submitting revised documentation, subject to the conditions specified below.

The further information has been considered on behalf of the Committee by Dr Michael Rivlin (Vice Chair) and Professor Howard Bird (Alternate Vice Chair).

Confirmation of ethical opinion

On behalf of the Committee, I am pleased to confirm a favourable ethical opinion for the above research on the basis described in the application form, protocol and supporting documentation as revised.

Ethical review of research sites

The favourable opinion applies to the research sites listed on the attached form.

Conditions of the favourable opinion

The favourable opinion is subject to the following conditions being met prior to the start of the study.

Management permission or approval must be obtained from each host organisation prior to the start of the study at the site concerned.

Management permission at NHS sites ("R&D approval") should be obtained from the relevant care organisation(s) in accordance with NHS research governance arrangements. Guidance on applying for NHS permission is available in the Integrated Research Application System or at <http://www.rdforum.nhs.uk>.

Notice of no objection must be obtained from the Medicines and Healthcare products Regulatory Agency (MHRA).

The sponsor is asked to provide the Committee with a copy of the notice from the MHRA, either confirming no objection or giving grounds for objection, as soon as this is available.

Approved documents

The final list of documents reviewed and approved by the Committee is as follows:

<i>Document</i>	<i>Version</i>	<i>Date</i>
Application		13 June 2008
Investigator CV		18 January 2008
Protocol	1.1	23 December 2007
Compensation Arrangements		24 August 2007
GP/Consultant Information Sheets	1.0	23 December 2007
Participant Information Sheet	1.1	26 March 2008
Participant Consent Form	1.0	23 January 2008
Response to Request for Further Information		26 March 2008
Email from Researcher		04 July 2008

Statement of compliance

The Committee is constituted in accordance with the Governance Arrangements for Research Ethics Committees (July 2001) and complies fully with the Standard Operating Procedures for Research Ethics Committees in the UK.

After ethical review

Now that you have completed the application process please visit the National Research Ethics Website > After Review

You are invited to give your view of the service that you have received from the National Research Ethics Service and the application procedure. If you wish to make your views known please use the feedback form available on the website.

The attached document "After ethical review – guidance for researchers" gives detailed guidance on reporting requirements for studies with a favourable opinion, including:

- Notifying substantial amendments
- Progress and safety reports
- Notifying the end of the study

The NRES website also provides guidance on these topics, which is updated in the light of changes in reporting requirements or procedures.

We would also like to inform you that we consult regularly with stakeholders to improve our service. If you would like to join our Reference Group please email referencegroup@nres.npsa.nhs.uk.

08/H1307/47

Please quote this number on all correspondence

With the Committee's best wishes for the success of this project

Yours sincerely



Miss Anna Fawlk
Assistant Administrator
On behalf of
Dr Michael Rivlin
Vice Chair

Email: anna.fawlk@leedsth.nhs.uk

Enclosures: "After ethical review – guidance for researchers"
Site approval form

Copy to: *Mrs Clare Skinner, University of Leeds*
R&D, Leeds Teaching Hospitals NHS Trust

Leeds (West) Research Ethics Committee					
LIST OF SITES WITH A FAVOURABLE ETHICAL OPINION					
<i>For all studies requiring site-specific assessment, this form is issued by the main REC to the Chief Investigator and sponsor with the favourable opinion letter and following subsequent notifications from site assessors. For issue 2 onwards, all sites with a favourable opinion are listed, adding the new sites approved.</i>					
REC reference number:	08/H1307/47	Issue number:	1	Date of issue:	15 July 2008
Chief Investigator:	Dr Klaus K Witte				
Full title of study:	Pacemaker upgrade to cardiac resynchronisation in patients with left ventricular dysfunction dependant upon right ventricular pacing				
<i>This study was given a favourable ethical opinion by Leeds (West) Research Ethics Committee on 14 July 2008. The favourable opinion is extended to each of the sites listed below. The research may commence at each NHS site when management approval from the relevant NHS care organisation has been confirmed.</i>					
Principal Investigator	Post	Research site	Site assessor	Date of favourable opinion for this site	Notes ⁽¹⁾
Dr Klaus K Witte	Senior Lecturer in Cardiology	LEEDS TEACHING HOSPITALS NHS TRUST	Leeds (West) Research Ethics Committee	15/07/2008	
Approved by the Chair on behalf of the REC:					
..... (Signature of Chair/Co-ordinator)					
(delete as applicable)					
..... (Name)					

Appendix D – Cardiac resynchronization therapy in pacemaker-dependent patients with left ventricular dysfunction - LTHT R&D approval

The Leeds Teaching Hospitals 
NHS Trust

30/01/2008

Dr Klaus Witte
Senior Lecturer in Cardiology
LIGHT Building
University of Leeds

Research & Development Directorate
A/B Corridor, Old Site

The General Infirmary at Leeds
Great George Street
Leeds
West Yorkshire
LS1 3EX

Tel: 0113 392 2878
Fax: 0113 392 6397

www.leedsteachinghospitals.com

Dear Dr Klaus Witte

Re: LTHT R&D Approval of CD08/8475: Pacemaker upgrade to cardiac resynchronisation in patients with left ventricular dysfunction dependant upon right ventricular pacing

I write with reference to the above research study. I can now confirm that this study has R&D approval and the study may proceed at The Leeds Teaching Hospitals NHS Trust (LTHT). This organisational level approval is given based on the information provided in the documents listed below.

As principal investigator you have responsibility for the design, management and reporting of the study. In undertaking this research you must comply with the requirements of the *Research Governance Framework for Health and Social Care* which is mandatory for all NHS employees. This document may be accessed on the Department of Health website at <http://www.dh.gov.uk/research>

R&D approval is therefore given on the understanding that you comply with the requirements of the *Framework* as listed in the attached sheet "Conditions of Approval".

If you have any queries about this approval please do not hesitate to contact the R&D Department on telephone 0113 392 2878.

Indemnity Arrangements

The Leeds Teaching Hospitals NHS Trust participates in the NHS risk pooling scheme administered by the NHS Litigation Authority 'Clinical Negligence Scheme for NHS Trusts' for: (i) medical professional and/or medical malpractice liability; and (ii) general liability. NHS Indemnity for negligent harm is extended to researchers with an employment contract (substantive or honorary) with the Trust. The Trust

Chairman Martin Buckley Chief Executive Maggie Boyle

The Leeds Teaching Hospitals incorporating: Chapel Allerton Hospital Cookridge Hospital Leeds Chest Clinic
Leeds Dental Institute Seacroft Hospital St James's University Hospital The General Infirmary at Leeds
Wharfedale Hospital

W/A280

only accepts liability for research activity that has been managerially approved by the R&D Department.

The Trust therefore accepts liability for the above research project and extends indemnity for negligent harm to cover you as principal investigator and the researchers listed on the R&D approval form provided that each member of the research team has an employment contract (substantive or honorary) with the Trust. Should there be any changes to the research team please ensure that you inform the R&D Department and that s/he obtains an employment contract with the Trust if required.

Yours sincerely



Dr D R Norfolk
Associate Director of R&D

Approved documents

The documents reviewed and approved are listed as follows

<i>Document</i>	<i>Version</i>	<i>Date of document</i>
Protocol	1.1	23/12/07
SSI Form	5.5	14/03/08
CMT Approval		21/01/08
NHS REC Application Form	5.5	14/03/08

Conditions of R&D Approval

- Approval from your local Clinical Management Team must be obtained before starting the study.
 - Approval of the appropriate Research Ethics Committee, where necessary, must be obtained before starting the study. Any changes made to the project during ethical review must be reviewed and approved by the R&D Department to maintain R&D Approval status.
 - Arrangements must be made to ensure that all members of the research team, where applicable, have employment contracts with the Trust (either full or honorary).
 - Agreements must be in place with appropriate support departments regarding the services required to undertake the project and arrangements must be in place to recompense them for the costs of their services.
 - Arrangements must be in place for the management of financial and other resources provided for the study, including intellectual property arising from the work.
 - Priority should be given at all times to the dignity, rights, safety and well being of participants in the study
 - Healthcare staff should be suitably informed about the research their patients are taking part in and information specifically relevant to their care arising from the study should be communicated promptly.
 - Each member of the research team must be qualified by education, training and experience to discharge his/her role in the study. Students and new researchers must have adequate supervision, support and training.
 - The research must follow the protocol approved by the relevant research ethics committee. Any proposed amendments to or deviations from the protocol must be submitted for approval to the Research Ethics Committee, the research sponsor, regulatory authority and any other appropriate body. The R&D Department should be informed where the amendment has resource implications within the CMT and the CMT research lead/clinical director notified.
 - Any adverse events/adverse drug reactions must be reported to the appropriate research ethics committee, research sponsor and any other regulatory authority. Adverse events in clinical trials of investigational medicinal products must be reported in accordance with the Medicines for Human Use (Clinical Trials) Regulations 2004. All serious adverse events as defined in the research protocol,
-

that occur within LTHT should be reported via the IR1 reporting system to the Risk Management Department, Trust Headquarters, St James's University Hospital, Beckett Street, Leeds LS9 7TF.

- Reports on the progress and outcomes of the work must be produced on time and to an acceptable standard. Please send a copy of the progress report produced for the Research Ethics Committee to the R&D Department for monitoring.
- Procedures should be in place to ensure collection of high quality, accurate data and the integrity and confidentiality of data during processing and storage.
- Arrangements must be made for the appropriate archiving of data when the research has finished. Records must normally be kept for 15 years.
- All data and documentation associated with the study must be available for audit at the request of the appropriate auditing authority. Currently 10% of REC approved projects are randomly selected for audit inspection by the R&D Department each year. You will be informed by letter if your study is selected.
- Findings from the study should be disseminated promptly and fed back as appropriate to research participants.
- Findings from the study should be exposed to critical review through accepted scientific and professional channels.

Commercially Sponsored Trials

If the study is commercially sponsored approval is given subject to provision of the following documents.

- Clinical Trials Agreement - agreed and signed off by the R&D Department (on behalf of the Leeds Teaching Hospitals NHS Trust) and the Sponsor.
- Indemnity agreement, if not included in the Clinical Trials Agreement- (standard ABPI no fault arrangements apply) signed by the R&D Department and the Sponsor

It is essential that all the responsibilities set out in the Research Governance Framework and outlined above are fulfilled. The Trust reserves the right to withdraw R&D approval for a study, and therefore the provision of indemnity cover (for negligent harm) for its employees, where it is found that the above criteria have not been met. The Trust will not accept liability for any activity that has not been fully approved.

References

1987. Effects of enalapril on mortality in severe congestive heart failure. Results of the Cooperative North Scandinavian Enalapril Survival Study (CONSENSUS). The CONSENSUS Trial Study Group. *N Engl J Med*, 316, 1429-35.
1992. Effect of enalapril on mortality and the development of heart failure in asymptomatic patients with reduced left ventricular ejection fractions. The SOLVD Investigators. *N Engl J Med*, 327, 685-91.
1993. Effect of ramipril on mortality and morbidity of survivors of acute myocardial infarction with clinical evidence of heart failure. The Acute Infarction Ramipril Efficacy (AIRE) Study Investigators. *Lancet*, 342, 821-8.
- 1997a. A comparison of antiarrhythmic-drug therapy with implantable defibrillators in patients resuscitated from near-fatal ventricular arrhythmias. The Antiarrhythmics versus Implantable Defibrillators (AVID) Investigators. *N Engl J Med*, 337, 1576-83.
- 1997b. The effect of digoxin on mortality and morbidity in patients with heart failure. *N Engl J Med*, 336, 525-33.
- 1999a. The Cardiac Insufficiency Bisoprolol Study II (CIBIS-II): a randomised trial. *Lancet*, 353, 9-13.
- 1999b. Effect of metoprolol CR/XL in chronic heart failure: Metoprolol CR/XL Randomised Intervention Trial in Congestive Heart Failure (MERIT-HF). *Lancet*, 353, 2001-7.
- (BSE), B. S. O. E. *A Standard Transthoracic Echo* [Online]. Available: <https://www.bsecho.org/tte-minimum-dataset/> [Accessed].
- ABD-ELMONIEM, K. Z., TOMAS, M. S., SASANO, T., SOLEIMANIFARD, S., VONKEN, E. J., YOUSSEF, A., AGARWAL, H., DIMAANO, V. L., CALKINS, H., STUBER, M., PRINCE, J. L., ABRAHAM, T. P. & ABRAHAM, M. R. 2012. Assessment of distribution and evolution of mechanical dyssynchrony in a porcine model of myocardial infarction by cardiovascular magnetic resonance. *J Cardiovasc Magn Reson*, 14, 1.
- ABRAHAM, W. T., FISHER, W. G., SMITH, A. L., DELURGIO, D. B., LEON, A. R., LOH, E., KOCOVIC, D. Z., PACKER, M., CLAVELL, A. L., HAYES, D. L., ELLESTAD, M., TRUPP, R. J., UNDERWOOD, J., PICKERING, F., TRUEX, C., MCATEE, P. & MESSENGER, J. 2002. Cardiac resynchronization in chronic heart failure. *N Engl J Med*, 346, 1845-53.
- ACHILLI, A., SASSARA, M., FICILI, S., PONTILLO, D., ACHILLI, P., ALESSI, C., DE SPIRITO, S., GUERRA, R., PATRUNO, N. & SERRA, F. 2003. Long-term effectiveness of cardiac resynchronization therapy in patients with refractory heart failure and "narrow" QRS. *J Am Coll Cardiol*, 42, 2117-24.
- ADAMOPOULOS, S., COATS, A. J., BRUNOTTE, F., ARNOLDA, L., MEYER, T., THOMPSON, C. H., DUNN, J. F., STRATTON, J., KEMP, G. J., RADDA, G. K. & ET AL. 1993. Physical training improves skeletal muscle metabolism in patients with chronic heart failure. *J Am Coll Cardiol*, 21, 1101-6.
- AFILALO, J., MAJDAN, A. A. & EISENBERG, M. J. 2007. Intensive statin therapy in acute coronary syndromes and stable coronary heart disease: a comparative meta-analysis of randomised controlled trials. *Heart*, 93, 914-21.
- ALBERTSEN, A. E., NIELSEN, J. C., POULSEN, S. H., MORTENSEN, P. T., PEDERSEN, A. K., HANSEN, P. S., JENSEN, H. K. & EGEBLAD, H. 2008. Biventricular pacing preserves left ventricular performance in patients with high-grade atrio-ventricular block: a randomized comparison with DDD(R) pacing in 50 consecutive patients. *Europace*, 10, 314-20.

- ALGHATRIF, M. & LINDSAY, J. 2012. A brief review: history to understand fundamentals of electrocardiography. *J Community Hosp Intern Med Perspect*, 2.
- ALPERT, M. A., CURTIS, J. J., SANFELIPPO, J. F., FLAKER, G. C., WALLS, J. T., MUKERJI, V., VILLARREAL, D., KATTI, S. K., MADIGAN, N. P. & KROL, R. B. 1986. Comparative survival after permanent ventricular and dual chamber pacing for patients with chronic high degree atrioventricular block with and without preexistent congestive heart failure. *J Am Coll Cardiol*, 7, 925-32.
- ALPERT, M. A., CURTIS, J. J., SANFELIPPO, J. F., FLAKER, G. C., WALLS, J. T., MUKERJI, V., VILLARREAL, D., KATTI, S. K., MADIGAN, N. P. & MORGAN, R. J. 1987. Comparative survival following permanent ventricular and dual-chamber pacing for patients with chronic symptomatic sinus node dysfunction with and without congestive heart failure. *Am Heart J*, 113, 958-65.
- ALSHEIKH-ALI, A. A., HOMER, M., MADDUKURI, P. V., KALSMITH, B., ESTES, N. A., 3RD & LINK, M. S. 2008. Time-dependence of appropriate implantable defibrillator therapy in patients with ischemic cardiomyopathy. *J Cardiovasc Electrophysiol*, 19, 784-9.
- ANDERSEN, H. R., NIELSEN, J. C., THOMSEN, P. E., THUESEN, L., MORTENSEN, P. T., VESTERLUND, T. & PEDERSEN, A. K. 1997. Long-term follow-up of patients from a randomised trial of atrial versus ventricular pacing for sick-sinus syndrome. *Lancet*, 350, 1210-6.
- ANDERSEN, H. R., THUESEN, L., BAGGER, J. P., VESTERLUND, T. & THOMSEN, P. E. 1994. Prospective randomised trial of atrial versus ventricular pacing in sick-sinus syndrome. *Lancet*, 344, 1523-8.
- AQUILINA, O. 2006. A brief history of cardiac pacing. *Images Paediatr Cardiol*, 8, 17-81.
- ARENA, R., MYERS, J., ASLAM, S. S., VARUGHESE, E. B. & PEBERDY, M. A. 2003. Technical considerations related to the minute ventilation/carbon dioxide output slope in patients with heart failure. *Chest*, 124, 720-7.
- ARENA, R., MYERS, J., WILLIAMS, M. A., GULATI, M., KLIGFIELD, P., BALADY, G. J., COLLINS, E. & FLETCHER, G. 2007. Assessment of functional capacity in clinical and research settings: a scientific statement from the American Heart Association Committee on Exercise, Rehabilitation, and Prevention of the Council on Clinical Cardiology and the Council on Cardiovascular Nursing. *Circulation*, 116, 329-43.
- ARMSTRONG, P. W., STOPPS, T. P., FORD, S. E. & DE BOLD, A. J. 1986. Rapid ventricular pacing in the dog: pathophysiologic studies of heart failure. *Circulation*, 74, 1075-84.
- ARRIBAS, F., AURICCHIO, A., BORIANI, G., BRUGADA, J., DEHARO, J. C., HINDRIKS, G., KUCK, K. H., MERINO, J. L., VARDAS, P., WOLPERT, C. & ZEPPEFELD, K. 2014. Statistics on the use of cardiac electronic devices and electrophysiological procedures in 55 ESC countries: 2013 report from the European Heart Rhythm Association (EHRA). *Europace*, 16 Suppl 1, i1-i78.
- AUGER, D., BERTINI, M., MARSAN, N. A., HOKE, U., EWE, S. H., THIJSSSEN, J., WITKOWSKI, T. G., YIU, K. H., NG, A. C., VAN DER WALL, E. E., SCHALIJ, M. J., BAX, J. J. & DELGADO, V. 2011. Prediction of response to cardiac resynchronization therapy combining two different three-dimensional analyses of left ventricular dyssynchrony. *Am J Cardiol*, 108, 711-7.
- AUGER, D., BLEEKER, G. B., BERTINI, M., EWE, S. H., VAN BOMMEL, R. J., WITKOWSKI, T. G., NG, A. C., VAN ERVEN, L., SCHALIJ, M. J., BAX, J. J. & DELGADO, V. 2012. Effect of cardiac resynchronization therapy in patients without left intraventricular dyssynchrony. *Eur Heart J*, 33, 913-20.

- AURICCHIO, A., FANTONI, C., REGOLI, F., CARBUCICCHIO, C., GOETTE, A., GELLER, C., KLOSS, M. & KLEIN, H. 2004. Characterization of left ventricular activation in patients with heart failure and left bundle-branch block. *Circulation*, 109, 1133-9.
- AURICCHIO, A., STELLBRINK, C., BLOCK, M., SACK, S., VOGT, J., BAKKER, P., KLEIN, H., KRAMER, A., DING, J., SALO, R., TOCKMAN, B., POCHE, T. & SPINELLI, J. 1999. Effect of pacing chamber and atrioventricular delay on acute systolic function of paced patients with congestive heart failure. The Pacing Therapies for Congestive Heart Failure Study Group. The Guidant Congestive Heart Failure Research Group. *Circulation*, 99, 2993-3001.
- AZIZ, S., LEON, A. R. & EL-CHAMI, M. F. 2014. The subcutaneous defibrillator: a review of the literature. *J Am Coll Cardiol*, 63, 1473-9.
- BADER, H., GARRIGUE, S., LAFITTE, S., REUTER, S., JAIS, P., HAISSAGUERRE, M., BONNET, J., CLEMENTY, J. & ROUDAUT, R. 2004. Intra-left ventricular electromechanical asynchrony. A new independent predictor of severe cardiac events in heart failure patients. *J Am Coll Cardiol*, 43, 248-56.
- BAKER, C. M., CHRISTOPHER, T. J., SMITH, P. F., LANGBERG, J. J., DELURGIO, D. B. & LEON, A. R. 2002. Addition of a left ventricular lead to conventional pacing systems in patients with congestive heart failure: feasibility, safety, and early results in 60 consecutive patients. *Pacing Clin Electrophysiol*, 25, 1166-71.
- BALKE, B. & WARE, R. W. 1959. An experimental study of physical fitness of Air Force personnel. *U S Armed Forces Med J*, 10, 675-88.
- BARDY, G. H., LEE, K. L., MARK, D. B., POOLE, J. E., PACKER, D. L., BOINEAU, R., DOMANSKI, M., TROUTMAN, C., ANDERSON, J., JOHNSON, G., MCNULTY, S. E., CLAPP-CHANNING, N., DAVIDSON-RAY, L. D., FRAULO, E. S., FISHBEIN, D. P., LUCERI, R. M. & IP, J. H. 2005. Amiodarone or an implantable cardioverter-defibrillator for congestive heart failure. *N Engl J Med*, 352, 225-37.
- BARDY, G. H., SMITH, W. M., HOOD, M. A., CROZIER, I. G., MELTON, I. C., JORDAENS, L., THEUNS, D., PARK, R. E., WRIGHT, D. J., CONNELLY, D. T., FYNN, S. P., MURGATROYD, F. D., SPERZEL, J., NEUZNER, J., SPITZER, S. G., ARDASHEV, A. V., ODURO, A., BOERSMA, L., MAASS, A. H., VAN GELDER, I. C., WILDE, A. A., VAN DESSEL, P. F., KNOPS, R. E., BARR, C. S., LUPO, P., CAPPATO, R. & GRACE, A. A. 2010. An entirely subcutaneous implantable cardioverter-defibrillator. *N Engl J Med*, 363, 36-44.
- BAROLD, S. S. 2003. Willem Einthoven and the birth of clinical electrocardiography a hundred years ago. *Card Electrophysiol Rev*, 7, 99-104.
- BAROLD, S. S. & LUDERITZ, B. 2001. John Hay and the earliest description of type II second-degree atrioventricular block. *Am J Cardiol*, 87, 1433-5.
- BATEY, R. L., SWEESY, M. W., SCALA, G. & FORNEY, R. C. 1990. Comparison of low rate dual chamber pacing to activity responsive rate variable ventricular pacing. *Pacing Clin Electrophysiol*, 13, 646-52.
- BAUER, A., VERMEULEN, J., TOIVONEN, L., VOITK, J., BARR, C. & PEYTCHEV, P. 2015. Minimizing right ventricular pacing in pacemaker patients with intact and compromised atrioventricular conduction : Results from the EVITA Trial. *Herzschrittmacherther Elektrophysiol*, 26, 359-366.
- BAVISHI, C., KHAN, A. R. & ATHER, S. 2015. Digoxin in patients with atrial fibrillation and heart failure: A meta-analysis. *Int J Cardiol*, 188, 99-101.
- BAX, J. J., BLEEKER, G. B., MARWICK, T. H., MOLHOEK, S. G., BOERSMA, E., STEENDIJK, P., VAN DER WALL, E. E. & SCHALIJ, M. J. 2004. Left ventricular dyssynchrony predicts response and prognosis after cardiac resynchronization therapy. *J Am Coll Cardiol*, 44, 1834-40.

- BAX, J. J. & GORCSAN, J., 3RD 2009. Echocardiography and noninvasive imaging in cardiac resynchronization therapy: results of the PROSPECT (Predictors of Response to Cardiac Resynchronization Therapy) study in perspective. *J Am Coll Cardiol*, 53, 1933-43.
- BEAVER, W. L., WASSERMAN, K. & WHIPP, B. J. 1986. A new method for detecting anaerobic threshold by gas exchange. *J Appl Physiol (1985)*, 60, 2020-7.
- BECKETT, N. S., PETERS, R., FLETCHER, A. E., STAESSEN, J. A., LIU, L., DUMITRASCU, D., STOYANOVSKY, V., ANTIKAINEN, R. L., NIKITIN, Y., ANDERSON, C., BELHANI, A., FORETTE, F., RAJKUMAR, C., THIJS, L., BANYA, W. & BULPITT, C. J. 2008. Treatment of hypertension in patients 80 years of age or older. *N Engl J Med*, 358, 1887-98.
- BEHRENS, S., ANDRESEN, D., BRUGGEMANN, T., EHLERS, C. & SCHRODER, R. 1994. [Reproducibility of symptom-limited oxygen consumption and anaerobic threshold within the scope of spiroergometric studies in patients with heart failure]. *Z Kardiol*, 83, 44-9.
- BELEVYCH, A. E., TERYTYEV, D., TERYTYEVA, R., NISHIJIMA, Y., SRIDHAR, A., HAMLIN, R. L., CARNES, C. A. & GYÖRKE, S. 2011. The relationship between arrhythmogenesis and impaired contractility in heart failure: role of altered ryanodine receptor function. *Cardiovascular research*, 90, 493-502.
- BENJAMINI Y, H. Y. 1995. Controlling the false discovery rate: a practical and powerful approach to multiple testing. *Journal of the Royal Statistical Society*, 289-300.
- BENSIMHON, D. R., LEIFER, E. S., ELLIS, S. J., FLEG, J. L., KETEVIAN, S. J., PINA, I. L., KITZMAN, D. W., MCKELVIE, R. S., KRAUS, W. E., FORMAN, D. E., KAO, A. J., WHELLAN, D. J., O'CONNOR, C. M. & RUSSELL, S. D. 2008. Reproducibility of peak oxygen uptake and other cardiopulmonary exercise testing parameters in patients with heart failure (from the Heart Failure and A Controlled Trial Investigating Outcomes of exercise training). *Am J Cardiol*, 102, 712-7.
- BERRY, D. 2006. History of cardiology: Robert Adams, MD, and William Stokes, MD. *Circulation*, 113, f92.
- BESHAI, J. F., GRIMM, R. A., NAGUEH, S. F., BAKER, J. H., 2ND, BEAU, S. L., GREENBERG, S. M., PIRES, L. A. & TCHOU, P. J. 2007. Cardiac-resynchronization therapy in heart failure with narrow QRS complexes. *N Engl J Med*, 357, 2461-71.
- BESTERMAN, E. & CREESE, R. 1979. Waller--pioneer of electrocardiography. *Br Heart J*, 42, 61-4.
- BILCHICK, K. C., DIMAANO, V., WU, K. C., HELM, R. H., WEISS, R. G., LIMA, J. A., BERGER, R. D., TOMASELLI, G. F., BLUEMKE, D. A., HALPERIN, H. R., ABRAHAM, T., KASS, D. A. & LARDO, A. C. 2008. Cardiac magnetic resonance assessment of dyssynchrony and myocardial scar predicts function class improvement following cardiac resynchronization therapy. *JACC Cardiovasc Imaging*, 1, 561-8.
- BLEUMINK, G. S., KNETSCH, A. M., STURKENBOOM, M. C., STRAUS, S. M., HOFMAN, A., DECKERS, J. W., WITTEMAN, J. C. & STRICKER, B. H. 2004. Quantifying the heart failure epidemic: prevalence, incidence rate, lifetime risk and prognosis of heart failure The Rotterdam Study. *Eur Heart J*, 25, 1614-9.
- BLOMQVIST, C. G. & SALTIN, B. 1983. Cardiovascular adaptations to physical training. *Annu Rev Physiol*, 45, 169-89.
- BOGALE, N., WITTE, K., PRIORI, S., CLELAND, J., AURICCHIO, A., GADLER, F., GITT, A., LIMBOURG, T., LINDE, C. & DICKSTEIN, K. 2011. The European Cardiac Resynchronization Therapy Survey: comparison of outcomes

- between de novo cardiac resynchronization therapy implantations and upgrades. *Eur J Heart Fail*, 13, 974-83.
- BOHM, M., BORER, J., FORD, I., GONZALEZ-JUANATEY, J. R., KOMAJDA, M., LOPEZ-SENDON, J., REIL, J. C., SWEDBERG, K. & TAVAZZI, L. 2013. Heart rate at baseline influences the effect of ivabradine on cardiovascular outcomes in chronic heart failure: analysis from the SHIFT study. *Clin Res Cardiol*, 102, 11-22.
- BONGIORNI, M. G., SOLDATI, E., ZUCHELLI, G., DI CORI, A., SEGRETI, L., DE LUCIA, R., SOLARINO, G., BALBARINI, A., MARZILLI, M. & MARIANI, M. 2008. Transvenous removal of pacing and implantable cardiac defibrillating leads using single sheath mechanical dilatation and multiple venous approaches: high success rate and safety in more than 2000 leads. *Eur Heart J*, 29, 2886-93.
- BOON, N. A., FREW, A. J., JOHNSTON, J. A. & COBBE, S. M. 1987. A comparison of symptoms and intra-arterial ambulatory blood pressure during long term dual chamber atrioventricular synchronous (DDD) and ventricular demand (VVI) pacing. *Br Heart J*, 58, 34-9.
- BORBÉLY, A., VAN DER VELDEN, J., PAPP, Z., BRONZWAER, J. G., EDES, I., STIENEN, G. J. & PAULUS, W. J. 2005. Cardiomyocyte stiffness in diastolic heart failure. *Circulation*, 111, 774-781.
- BORDACHAR, P., GARRIGUE, S., LAFITTE, S., REUTER, S., JAIS, P., HAISSAGUERRE, M. & CLEMENTY, J. 2003. Interventricular and intra-left ventricular electromechanical delays in right ventricular paced patients with heart failure: implications for upgrading to biventricular stimulation. *Heart*, 89, 1401-5.
- BORIANI, G., GARDINI, B., DIEMBERGER, I., BACCHI REGGIANI, M. L., BIFFI, M., MARTIGNANI, C., ZIACCHI, M., VALZANIA, C., GASPARINI, M., PADELETTI, L. & BRANZI, A. 2012. Meta-analysis of randomized controlled trials evaluating left ventricular vs. biventricular pacing in heart failure: effect on all-cause mortality and hospitalizations. *Eur J Heart Fail*, 14, 652-60.
- BRAUNWALD, E. 2013. Heart Failure. *JACC: Heart Failure*, 1, 1-20.
- BRAUNWALD, E., CHIDSEY, C. A., HARRISON, D. C., GAFFNEY, T. E. & KAHLER, R. L. 1963. Studies on the function of the adrenergic nerve endings in the heart. *Circulation*, 28, 958-969.
- BRAUNWALD, E., ROSS, J., JR. & SONNENBLICK, E. H. 1967. Mechanisms of contraction of the normal and failing heart. *N Engl J Med*, 277, 794-800 contd.
- BRECKER, S. J., XIAO, H. B., SPARROW, J. & GIBSON, D. G. 1992. Effects of dual-chamber pacing with short atrioventricular delay in dilated cardiomyopathy. *Lancet*, 340, 1308-12.
- BRIGNOLE, M., AURICCHIO, A., BARON-ESQUIVIAS, G., BORDACHAR, P., BORIANI, G., BREITHARDT, O. A., CLELAND, J., DEHARO, J. C., DELGADO, V., ELLIOTT, P. M., GORENEK, B., ISRAEL, C. W., LECLERCQ, C., LINDE, C., MONT, L., PADELETTI, L., SUTTON, R., VARDAS, P. E., ZAMORANO, J. L., ACHENBACH, S., BAUMGARTNER, H., BAX, J. J., BUENO, H., DEAN, V., DEATON, C., EROL, C., FAGARD, R., FERRARI, R., HASDAI, D., HOES, A. W., KIRCHHOF, P., KNUUTI, J., KOLH, P., LANCELLOTTI, P., LINHART, A., NIHOYANNOPOULOS, P., PIEPOLI, M. F., PONIKOWSKI, P., SIRNES, P. A., TAMARGO, J. L., TENDERA, M., TORBICKI, A., WIJNS, W., WINDECKER, S., KIRCHHOF, P., BLOMSTROM-LUNDQVIST, C., BADANO, L. P., ALIYEV, F., BANSCH, D., BAUMGARTNER, H., BSATA, W., BUSER, P., CHARRON, P., DAUBERT, J. C., DOBREANU, D., FAERESTRAND, S., HASDAI, D., HOES, A. W., LE HEUZEY, J. Y., MAVRAKIS, H., MCDONAGH, T., MERINO, J. L., NAWAR, M. M., NIELSEN, J. C., PIESKE, B., POPOSKA, L., RUSCHITZKA, F., TENDERA, M., VAN GELDER, I. C. & WILSON, C. M.

2013. 2013 ESC Guidelines on cardiac pacing and cardiac resynchronization therapy: the Task Force on cardiac pacing and resynchronization therapy of the European Society of Cardiology (ESC). Developed in collaboration with the European Heart Rhythm Association (EHRA). *Eur Heart J*, 34, 2281-329.
- BRILI, S., STAMATOPOULOS, I., MISAILIDOU, M., CHRYSOHOOU, C., TOUSOULIS, D., TATSIS, I. & STEFANADIS, C. 2013. Longitudinal strain curves in the RV free wall differ in morphology in patients with pulmonary hypertension compared to controls. *Int J Cardiol*, 167, 2753-6.
- BRISTOW, M. R., SAXON, L. A., BOEHMER, J., KRUEGER, S., KASS, D. A., DE MARCO, T., CARSON, P., DICARLO, L., DEMETS, D., WHITE, B. G., DEVRIES, D. W. & FELDMAN, A. M. 2004. Cardiac-resynchronization therapy with or without an implantable defibrillator in advanced chronic heart failure. *N Engl J Med*, 350, 2140-50.
- BROWN, N. J. & VAUGHAN, D. E. 1998. Angiotensin-converting enzyme inhibitors. *Circulation*, 97, 1411-20.
- BRUCE, R. A. 1971. Exercise testing of patients with coronary heart disease. Principles and normal standards for evaluation. *Ann Clin Res*, 3, 323-32.
- BRUCE, R. A. & MCDONOUGH, J. R. 1969. Stress testing in screening for cardiovascular disease. *Bull N Y Acad Med*, 45, 1288-305.
- BRUNNER, M., OLSCHIEWSKI, M., GEIBEL, A., BODE, C. & ZEHENDER, M. 2004. Long-term survival after pacemaker implantation. Prognostic importance of gender and baseline patient characteristics. *Eur Heart J*, 25, 88-95.
- BUCHFUEHRER, M. J., HANSEN, J. E., ROBINSON, T. E., SUE, D. Y., WASSERMAN, K. & WHIPP, B. J. 1983. Optimizing the exercise protocol for cardiopulmonary assessment. *J Appl Physiol Respir Environ Exerc Physiol*, 55, 1558-64.
- BUDGE, L. P., HELMS, A. S., SALERNO, M., KRAMER, C. M., EPSTEIN, F. H. & BILCHICK, K. C. 2012. MR cine DENSE dyssynchrony parameters for the evaluation of heart failure: comparison with myocardial tissue tagging. *JACC Cardiovasc Imaging*, 5, 789-97.
- BURKE, M. C., GOLD, M. R., KNIGHT, B. P., BARR, C. S., THEUNS, D. A., BOERSMA, L. V., KNOPS, R. E., WEISS, R., LEON, A. R., HERRE, J. M., HUSBY, M., STEIN, K. M. & LAMBIASE, P. D. 2015. Safety and Efficacy of the Totally Subcutaneous Implantable Defibrillator: 2-Year Results From a Pooled Analysis of the IDE Study and EFFORTLESS Registry. *J Am Coll Cardiol*, 65, 1605-15.
- BURKHOF, D., OIKAWA, R. Y. & SAGAWA, K. 1986. Influence of pacing site on canine left ventricular contraction. *Am J Physiol*, 251, H428-35.
- BURRI, H., SUNTHORN, H., DORSANZ, P. A., VIERA, I. & SHAH, D. 2007. Thresholds and complications with right ventricular septal pacing compared to apical pacing. *Pacing Clin Electrophysiol*, 30 Suppl 1, S75-8.
- BYRNE, M. J., HELM, R. H., DAYA, S., OSMAN, N. F., HALPERIN, H. R., BERGER, R. D., KASS, D. A. & LARDO, A. C. 2007. Diminished left ventricular dyssynchrony and impact of resynchronization in failing hearts with right versus left bundle branch block. *J Am Coll Cardiol*, 50, 1484-90.
- CANDINAS, R., JAKOB, M., BUCKINGHAM, T. A., MATTMANN, H. & AMANN, F. W. 1997. Vibration, acceleration, gravitation, and movement: activity controlled rate adaptive pacing during treadmill exercise testing and daily life activities. *Pacing Clin Electrophysiol*, 20, 1777-86.
- CAPUCCI, A., BORIANI, G., SPECCHIA, S., MARINELLI, M., SANTARELLI, A. & MAGNANI, B. 1992. Evaluation by cardiopulmonary exercise test of DDDR versus DDD pacing. *Pacing Clin Electrophysiol*, 15, 1908-13.

- CARMOUCHE, D. G., BUBIEN, R. S. & KAY, G. N. 1998. The effect of maximum heart rate on oxygen kinetics and exercise performance at low and high workloads. *Pacing Clin Electrophysiol*, 21, 679-86.
- CASTELNUOVO, E., STEIN, K., PITT, M., GARSIDE, R. & PAYNE, E. 2005. The effectiveness and cost-effectiveness of dual-chamber pacemakers compared with single-chamber pacemakers for bradycardia due to atrioventricular block or sick sinus syndrome: systematic review and economic evaluation. *Health Technol Assess*, 9, iii, xi-xiii, 1-246.
- CAZEAU, S., LECLERCQ, C., LAVERGNE, T., WALKER, S., VARMA, C., LINDE, C., GARRIGUE, S., KAPPENBERGER, L., HAYWOOD, G. A., SANTINI, M., BAILLEUL, C. & DAUBERT, J. C. 2001. Effects of multisite biventricular pacing in patients with heart failure and intraventricular conduction delay. *N Engl J Med*, 344, 873-80.
- CAZEAU, S., RITTER, P., BAKDACH, S., LAZARUS, A., LIMOUSIN, M., HENAO, L., MUNDLER, O., DAUBERT, J. C. & MUGICA, J. 1994. Four chamber pacing in dilated cardiomyopathy. *Pacing & Clinical Electrophysiology*, 17, 1974-9.
- CEIA, F., FONSECA, C., MOTA, T., MORAIS, H., MATIAS, F., DE SOUSA, A. & OLIVEIRA, A. 2002. Prevalence of chronic heart failure in Southwestern Europe: the EPICA study. *Eur J Heart Fail*, 4, 531-9.
- CHAIKHOUNI, A. 2010. The magnificent century of cardiothoracic surgery part 8: reviving the dead. *Heart Views*, 11, 85-91.
- CHAKIR, K., DAYA, S. K., AIBA, T., TUNIN, R. S., DIMAANO, V. L., ABRAHAM, T. P., JQUES-ROBINSON, K. M., LAI, E. W., PACAK, K., ZHU, W. Z., XIAO, R. P., TOMASELLI, G. F. & KASS, D. A. 2009. Mechanisms of enhanced beta-adrenergic reserve from cardiac resynchronization therapy. *Circulation*, 119, 1231-40.
- CHALIL, S., STEGEMANN, B., MUHYALDEEN, S., KHADJOOI, K., SMITH, R. E., JORDAN, P. J. & LEYVA, F. 2007. Intraventricular dyssynchrony predicts mortality and morbidity after cardiac resynchronization therapy: a study using cardiovascular magnetic resonance tissue synchronization imaging. *J Am Coll Cardiol*, 50, 243-52.
- CHANNER, K. S., MCLEAN, K. A., LAWSON-MATTHEW, P. & RICHARDSON, M. 1994. Combination diuretic treatment in severe heart failure: a randomised controlled trial. *Br Heart J*, 71, 146-50.
- CHEN, S., CHEN, K., TAO, Q., ZHENG, L., SHEN, F., WU, S., FAN, J., XU, G., WANG, L., ZHOU, X. & ZHANG, S. 2014. Reduction of unnecessary right ventricular pacing by managed ventricular pacing and search AV+ algorithms in pacemaker patients: 12-month follow-up results of a randomized study. *Europace*, 16, 1595-602.
- CHEN, Y., ESCOUBET, B., PRUNIER, F., AMOUR, J., SIMONIDES, W. S., VIVIEN, B., LENOIR, C., HEIMBURGER, M., CHOQUEUX, C. & GELLEN, B. 2004. Constitutive cardiac overexpression of sarcoplasmic/endoplasmic reticulum Ca²⁺-ATPase delays myocardial failure after myocardial infarction in rats at a cost of increased acute arrhythmias. *Circulation*, 109, 1898-1903.
- CHOW, E., WOODARD, J. C. & FARRAR, D. J. 1990. Rapid ventricular pacing in pigs: an experimental model of congestive heart failure. *Am J Physiol*, 258, H1603-5.
- CHUA, T. P., CLARK, A. L., AMADI, A. A. & COATS, A. J. 1996. Relation between chemosensitivity and the ventilatory response to exercise in chronic heart failure. *J Am Coll Cardiol*, 27, 650-7.
- CHUA, T. P., PONIKOWSKI, P., HARRINGTON, D., ANKER, S. D., WEBB-PEPLOE, K., CLARK, A. L., POOLE-WILSON, P. A. & COATS, A. J. 1997. Clinical correlates and prognostic significance of the ventilatory response to exercise in chronic heart failure. *J Am Coll Cardiol*, 29, 1585-90.

- CHUNG, E. S., LEON, A. R., TAVAZZI, L., SUN, J. P., NIHOYANNOPOULOS, P., MERLINO, J., ABRAHAM, W. T., GHIO, S., LECLERCQ, C., BAX, J. J., YU, C. M., GORCSAN, J., 3RD, ST JOHN SUTTON, M., DE SUTTER, J. & MURILLO, J. 2008. Results of the Predictors of Response to CRT (PROSPECT) trial. *Circulation*, 117, 2608-16.
- CJ, W. 1925. The muscular reactions of the mammalian ventricles to artificial surface stimuli. *American Journal of Physiology*, Vol 73, 346-378.
- CLELAND, J. G., ABRAHAM, W. T., LINDE, C., GOLD, M. R., YOUNG, J. B., CLAUDE DAUBERT, J., SHERFESEE, L., WELLS, G. A. & TANG, A. S. 2013. An individual patient meta-analysis of five randomized trials assessing the effects of cardiac resynchronization therapy on morbidity and mortality in patients with symptomatic heart failure. *Eur Heart J*, 34, 3547-56.
- CLELAND, J. G., BRISTOW, M. R., ERDMANN, E., REMME, W. J., SWEDBERG, K. & WAAGSTEIN, F. 1996. Beta-blocking agents in heart failure. Should they be used and how? *Eur Heart J*, 17, 1629-39.
- CLELAND, J. G. & BUGA, L. 2010. Device therapy: Defibrillators-a shocking therapy for cardiomyopathy? *Nat Rev Cardiol*, 7, 69-70.
- CLELAND, J. G., DAUBERT, J. C., ERDMANN, E., FREEMANTLE, N., GRAS, D., KAPPENBERGER, L. & TAVAZZI, L. 2005. The effect of cardiac resynchronization on morbidity and mortality in heart failure. *N Engl J Med*, 352, 1539-49.
- CLELAND, J. G., FREEMANTLE, N., BALL, S. G., BONSER, R. S., CAMICI, P., CHATTOPADHYAY, S., DUTKA, D., EASTAUGH, J., HAMPTON, J., LARGE, S., NORELL, M. S., PENNELL, D. J., PEPPER, J., SANDA, S., SENIOR, R. & SMITH, D. 2003a. The heart failure revascularisation trial (HEART): rationale, design and methodology. *Eur J Heart Fail*, 5, 295-303.
- CLELAND, J. G., MASSIE, B. M. & PACKER, M. 1999. Sudden death in heart failure: vascular or electrical? *Eur J Heart Fail*, 1, 41-5.
- CLELAND, J. G., PENNELL, D. J., RAY, S. G., COATS, A. J., MACFARLANE, P. W., MURRAY, G. D., MULE, J. D., VERED, Z. & LAHIRI, A. 2003b. Myocardial viability as a determinant of the ejection fraction response to carvedilol in patients with heart failure (CHRISTMAS trial): randomised controlled trial. *Lancet*, 362, 14-21.
- CLELAND, J. G., SWEDBERG, K., COHEN-SOLAL, A., COSIN-AGUILAR, J., DIETZ, R., FOLLATH, F., GAVAZZI, A., HOBBS, R., KOREWICKI, J., MADEIRA, H. C., PREDA, I., VAN GILST, W. H., WIDIMSKY, J., MAREEV, V., MASON, J., FREEMANTLE, N. & EASTAUGH, J. 2000. The Euro Heart Failure Survey of the EUROHEART survey programme. A survey on the quality of care among patients with heart failure in Europe. The Study Group on Diagnosis of the Working Group on Heart Failure of the European Society of Cardiology. The Medicines Evaluation Group Centre for Health Economics University of York. *Eur J Heart Fail*, 2, 123-32.
- CLELAND, J. G., THYGESEN, K., URETSKY, B. F., ARMSTRONG, P., HOROWITZ, J. D., MASSIE, B., PACKER, M., POOLE-WILSON, P. A. & RYDEN, L. 2001. Cardiovascular critical event pathways for the progression of heart failure; a report from the ATLAS study. *Eur Heart J*, 22, 1601-12.
- COATS, A. J. 1996. The "muscle hypothesis" of chronic heart failure. *J Mol Cell Cardiol*, 28, 2255-62.
- COELHO, R., RAMOS, S., PRATA, J., BETTENCOURT, P., FERREIRA, A. & CERQUEIRA-GOMES, M. 2005. Heart failure and health related quality of life. *Clin Pract Epidemiol Ment Health*, 1, 19.
- COHN, J. N., JOHNSON, G. R., SHABETAI, R., LOEB, H., TRISTANI, F., RECTOR, T., SMITH, R. & FLETCHER, R. 1993. Ejection fraction, peak exercise oxygen consumption, cardiothoracic ratio, ventricular arrhythmias, and plasma norepinephrine as determinants of prognosis in heart failure. The V-HeFT VA Cooperative Studies Group. *Circulation*, 87, Vi5-16.

- COHN, J. N., LEVINE, T. B., OLIVARI, M. T., GARBERG, V., LURA, D., FRANCIS, G. S., SIMON, A. B. & RECTOR, T. 1984. Plasma norepinephrine as a guide to prognosis in patients with chronic congestive heart failure. *N Engl J Med*, 311, 819-23.
- COHN, J. N. & TOGNONI, G. 2001. A randomized trial of the angiotensin-receptor blocker valsartan in chronic heart failure. *N Engl J Med*, 345, 1667-75.
- CONNOLLY, S. J., GENT, M., ROBERTS, R. S., DORIAN, P., ROY, D., SHELDON, R. S., MITCHELL, L. B., GREEN, M. S., KLEIN, G. J. & O'BRIEN, B. 2000a. Canadian implantable defibrillator study (CIDS) : a randomized trial of the implantable cardioverter defibrillator against amiodarone. *Circulation*, 101, 1297-302.
- CONNOLLY, S. J., HALLSTROM, A. P., CAPPATO, R., SCHRON, E. B., KUCK, K. H., ZIPES, D. P., GREENE, H. L., BOCZOR, S., DOMANSKI, M., FOLLMANN, D., GENT, M. & ROBERTS, R. S. 2000b. Meta-analysis of the implantable cardioverter defibrillator secondary prevention trials. AVID, CASH and CIDS studies. Antiarrhythmics vs Implantable Defibrillator study. Cardiac Arrest Study Hamburg . Canadian Implantable Defibrillator Study. *Eur Heart J*, 21, 2071-8.
- CONNOLLY, S. J., KERR, C. R., GENT, M., ROBERTS, R. S., YUSUF, S., GILLIS, A. M., SAMI, M. H., TALAJIC, M., TANG, A. S., KLEIN, G. J., LAU, C. & NEWMAN, D. M. 2000c. Effects of physiologic pacing versus ventricular pacing on the risk of stroke and death due to cardiovascular causes. Canadian Trial of Physiologic Pacing Investigators. *New England Journal of Medicine*, 342, 1385-91.
- COOK, N. R. & RIDKER, P. M. 2009. Advances in measuring the effect of individual predictors of cardiovascular risk: the role of reclassification measures. *Ann Intern Med*, 150, 795-802.
- COWIE, M. R., STRUTHERS, A. D., WOOD, D. A., COATS, A. J., THOMPSON, S. G., POOLE-WILSON, P. A. & SUTTON, G. C. 1997. Value of natriuretic peptides in assessment of patients with possible new heart failure in primary care. *Lancet*, 350, 1349-53.
- CREEMERS, E. E. & PINTO, Y. M. 2010. Molecular mechanisms that control interstitial fibrosis in the pressure-overloaded heart. *Cardiovascular research*, cvq308.
- CUBBON, R. M., GALE, C. P., KEARNEY, L. C., SCHECHTER, C. B., BROOKSBY, W. P., NOLAN, J., FOX, K. A., RAJWANI, A., BAIG, W., GROVES, D., BARLOW, P., FISHER, A. C., BATIN, P. D., KAHN, M. B., ZAMAN, A. G., SHAH, A. M., BYRNE, J. A., LINDSAY, S. J., SAPSFORD, R. J., WHEATCROFT, S. B., WITTE, K. K. & KEARNEY, M. T. 2011. Changing characteristics and mode of death associated with chronic heart failure caused by left ventricular systolic dysfunction: a study across therapeutic eras. *Circ Heart Fail*, 4, 396-403.
- CURTIS, A. B., WORLEY, S. J., ADAMSON, P. B., CHUNG, E. S., NIAZI, I., SHERFESEE, L., SHINN, T. & SUTTON, M. S. 2013. Biventricular pacing for atrioventricular block and systolic dysfunction. *N Engl J Med*, 368, 1585-93.
- DAGENAIS, G. R., POGUE, J., FOX, K., SIMOONS, M. L. & YUSUF, S. 2006. Angiotensin-converting-enzyme inhibitors in stable vascular disease without left ventricular systolic dysfunction or heart failure: a combined analysis of three trials. *Lancet*, 368, 581-8.
- DARGIE, H. J. 2001. Effect of carvedilol on outcome after myocardial infarction in patients with left-ventricular dysfunction: the CAPRICORN randomised trial. *Lancet*, 357, 1385-90.
- DAUBERT, J. C., SAXON, L., ADAMSON, P. B., AURICCHIO, A., BERGER, R. D., BESHAI, J. F., BREITHARD, O., BRIGNOLE, M., CLELAND, J., DELURGIO, D. B., DICKSTEIN, K., EXNER, D. V., GOLD, M., GRIMM, R.

- A., HAYES, D. L., ISRAEL, C., LECLERCQ, C., LINDE, C., LINDENFELD, J., MERKELY, B., MONT, L., MURGATROYD, F., PRINZEN, F., SABA, S. F., SHINBANE, J. S., SINGH, J., TANG, A. S., VARDAS, P. E., WILKOFF, B. L., ZAMORANO, J. L., ANAND, I., BLOMSTROM-LUNDQVIST, C., BOEHMER, J. P., CALKINS, H., CAZEAU, S., DELGADO, V., ESTES, N. A., HAINES, D., KUSUMOTO, F., LEYVA, P., RUSCHITZKA, F., STEVENSON, L. W. & TORP-PEDERSEN, C. T. 2012. 2012 EHRA/HRS expert consensus statement on cardiac resynchronization therapy in heart failure: implant and follow-up recommendations and management. *Europace*, 14, 1236-86.
- DAVIE, A. P., FRANCIS, C. M., CARUANA, L., SUTHERLAND, G. R. & MCMURRAY, J. J. 1997. Assessing diagnosis in heart failure: which features are any use? *Qjm*, 90, 335-9.
- DAVY, J. M., HOFFMANN, E., FREY, A., JOCHAM, K., ROSSI, S., DUPUIS, J. M., FRABETTI, L., DUCLOUX, P., PRADES, E. & JAUVERT, G. 2012. Near elimination of ventricular pacing in SafeR mode compared to DDD modes: a randomized study of 422 patients. *Pacing Clin Electrophysiol*, 35, 392-402.
- DE COCK, C. C., GIUDICI, M. C. & TWISK, J. W. 2003. Comparison of the haemodynamic effects of right ventricular outflow-tract pacing with right ventricular apex pacing: a quantitative review. *Europace*, 5, 275-8.
- DELGADO, V. & BAX, J. J. 2011. Assessment of systolic dyssynchrony for cardiac resynchronization therapy is clinically useful. *Circulation*, 123, 640-55.
- DELGADO, V., YPENBURG, C., VAN BOMMEL, R. J., TOPS, L. F., MOLLEMA, S. A., MARSAN, N. A., BLEEKER, G. B., SCHALIJ, M. J. & BAX, J. J. 2008. Assessment of left ventricular dyssynchrony by speckle tracking strain imaging comparison between longitudinal, circumferential, and radial strain in cardiac resynchronization therapy. *J Am Coll Cardiol*, 51, 1944-52.
- DELNOY, P. P., OTTERVANGER, J. P., VOS, D. H., ELVAN, A., MISIER, A. R., BEUKEMA, W. P., STEENDIJK, P. & VAN HEMEL, N. M. 2011. Upgrading to biventricular pacing guided by pressure-volume loop analysis during implantation. *J Cardiovasc Electrophysiol*, 22, 677-83.
- DESAI, A. S., MCMURRAY, J. J., PACKER, M., SWEDBERG, K., ROULEAU, J. L., CHEN, F., GONG, J., RIZKALA, A. R., BRAHIMI, A., CLAGGETT, B., FINN, P. V., HARTLEY, L. H., LIU, J., LEFKOWITZ, M., SHI, V., ZILE, M. R. & SOLOMON, S. D. 2015. Effect of the angiotensin-receptor-neprilysin inhibitor LCZ696 compared with enalapril on mode of death in heart failure patients. *Eur Heart J*, 36, 1990-7.
- DESHMUKH, P., CASAVANT, D. A., ROMANYSHYN, M. & ANDERSON, K. 2000. Permanent, direct His-bundle pacing: a novel approach to cardiac pacing in patients with normal His-Purkinje activation. *Circulation*, 101, 869-77.
- DICKSTEIN, K., COHEN-SOLAL, A., FILIPPATOS, G., MCMURRAY, J. J., PONIKOWSKI, P., POOLE-WILSON, P. A., STROMBERG, A., VAN VELDHUISEN, D. J., ATAR, D., HOES, A. W., KEREN, A., MEBAZAA, A., NIEMINEN, M., PRIORI, S. G. & SWEDBERG, K. 2008. ESC Guidelines for the diagnosis and treatment of acute and chronic heart failure 2008: the Task Force for the Diagnosis and Treatment of Acute and Chronic Heart Failure 2008 of the European Society of Cardiology. Developed in collaboration with the Heart Failure Association of the ESC (HFA) and endorsed by the European Society of Intensive Care Medicine (ESICM). *Eur Heart J*, 29, 2388-442.
- DORANS, K. S., MOSTOFSKY, E., LEVITAN, E. B., HAKANSSON, N., WOLK, A. & MITTLEMAN, M. A. 2015. Alcohol and incident heart failure among middle-aged and elderly men: cohort of Swedish men. *Circ Heart Fail*, 8, 422-7.

- DREXLER, H., HAYOZ, D., MUNZEL, T., JUST, H., ZELIS, R. & BRUNNER, H. R. 1993. Endothelial function in congestive heart failure. *Am Heart J*, 126, 761-4.
- DUNN, P. M. 2006. Aristotle (384–322 bc): philosopher and scientist of ancient Greece. *Arch Dis Child Fetal Neonatal Ed*, 91, F75-7.
- DUZENLI, M. A., OZDEMIR, K., SOYLU, A., AYGUL, N., YAZICI, M. & TOKAC, M. 2008. The effect of isolated left bundle branch block on the myocardial velocities and myocardial performance index. *Echocardiography*, 25, 256-63.
- EACI, A. A. 2016. Recommendations for Cardiac Chamber Quantification by Echocardiography in Adults: An Update from the American Society of Echocardiography and the European Association of Cardiovascular Imaging. *Eur Heart J Cardiovasc Imaging*, 17, 412.
- ECKART, R. E., SHRY, E. A., BURKE, A. P., MCNEAR, J. A., APPEL, D. A., CASTILLO-ROJAS, L. M., AVEDISSIAN, L., PEARSE, L. A., POTTER, R. N., TREMAINE, L., GENTLESK, P. J., HUFFER, L., REICH, S. S. & STEVENSON, W. G. 2011. Sudden death in young adults: an autopsy-based series of a population undergoing active surveillance. *J Am Coll Cardiol*, 58, 1254-61.
- EISENBERG, M. S. 1994. Charles Kite's essay on the recovery of the apparently dead: the first scientific study of sudden death. *Ann Emerg Med*, 23, 1049-53.
- ELDADAH, Z. A., ROSEN, B., HAY, I., EDVARDSEN, T., JAYAM, V., DICKFELD, T., MEININGER, G. R., JUDGE, D. P., HARE, J., LIMA, J. B., CALKINS, H. & BERGER, R. D. 2006. The benefit of upgrading chronically right ventricle-paced heart failure patients to resynchronization therapy demonstrated by strain rate imaging. *Heart Rhythm*, 3, 435-42.
- EPSTEIN, A. E., DIMARCO, J. P., ELLENBOGEN, K. A., ESTES, N. A., 3RD, FREEDMAN, R. A., GETTES, L. S., GILLINOV, A. M., GREGORATOS, G., HAMMILL, S. C., HAYES, D. L., HLATKY, M. A., NEWBY, L. K., PAGE, R. L., SCHOENFELD, M. H., SILKA, M. J., STEVENSON, L. W. & SWEENEY, M. O. 2013. 2012 ACCF/AHA/HRS focused update incorporated into the ACCF/AHA/HRS 2008 guidelines for device-based therapy of cardiac rhythm abnormalities: a report of the American College of Cardiology Foundation/American Heart Association Task Force on Practice Guidelines and the Heart Rhythm Society. *Circulation*, 127, e283-352.
- EPSTEIN, A. E., DIMARCO, J. P., ELLENBOGEN, K. A., ESTES, N. A., 3RD, FREEDMAN, R. A., GETTES, L. S., GILLINOV, A. M., GREGORATOS, G., HAMMILL, S. C., HAYES, D. L., HLATKY, M. A., NEWBY, L. K., PAGE, R. L., SCHOENFELD, M. H., SILKA, M. J., STEVENSON, L. W., SWEENEY, M. O., SMITH, S. C., JR., JACOBS, A. K., ADAMS, C. D., ANDERSON, J. L., BULLER, C. E., CREAGER, M. A., ETTINGER, S. M., FAXON, D. P., HALPERIN, J. L., HIRATZKA, L. F., HUNT, S. A., KRUMHOLZ, H. M., KUSHNER, F. G., LYTLE, B. W., NISHIMURA, R. A., ORNATO, J. P., PAGE, R. L., RIEGEL, B., TARKINGTON, L. G. & YANCY, C. W. 2008. ACC/AHA/HRS 2008 Guidelines for Device-Based Therapy of Cardiac Rhythm Abnormalities: a report of the American College of Cardiology/American Heart Association Task Force on Practice Guidelines (Writing Committee to Revise the ACC/AHA/NASPE 2002 Guideline Update for Implantation of Cardiac Pacemakers and Antiarrhythmia Devices) developed in collaboration with the American Association for Thoracic Surgery and Society of Thoracic Surgeons. *J Am Coll Cardiol*, 51, e1-62.
- ERKAPIC, D., SPERZEL, J., STILLER, S., MELTENDORF, U., MERMI, J., WEGSCHEIDER, K. & HUGL, B. 2013. Long-term benefit of implantable cardioverter/defibrillator therapy after elective device replacement: results of

- the INcidence free SUrvival after ICD REplacement (INSURE) trial--a prospective multicentre study. *Eur Heart J*, 34, 130-7.
- ESC 2001. Recommendations for exercise testing in chronic heart failure patients. *Eur Heart J*, 22, 37-45.
- FANANAPAZIR, L., BENNETT, D. H. & MONKS, P. 1983. Atrial synchronized ventricular pacing: contribution of the chronotropic response to improved exercise performance. *Pacing Clin Electrophysiol*, 6, 601-8.
- FARIS, R., FLATHER, M., PURCELL, H., HENEIN, M., POOLE-WILSON, P. & COATS, A. 2002. Current evidence supporting the role of diuretics in heart failure: a meta analysis of randomised controlled trials. *Int J Cardiol*, 82, 149-58.
- FARIS, R. F., FLATHER, M., PURCELL, H., POOLE-WILSON, P. A. & COATS, A. J. 2012. Diuretics for heart failure. *Cochrane Database Syst Rev*, Cd003838.
- FELKER, G. M., SHAW, L. K. & O'CONNOR, C. M. 2002. A standardized definition of ischemic cardiomyopathy for use in clinical research. *J Am Coll Cardiol*, 39, 210-8.
- FEUER, J. M., SHANDLING, A. H. & MESSENGER, J. C. 1989. Influence of cardiac pacing mode on the long-term development of atrial fibrillation. *Am J Cardiol*, 64, 1376-9.
- FINGER, S., PICCOLINO, M. & STAHNISCH, F. W. 2013. Alexander von Humboldt: galvanism, animal electricity, and self-experimentation part 2: the electric eel, animal electricity, and later years. *J Hist Neurosci*, 22, 327-52.
- FLATHER, M. D., SHIBATA, M. C., COATS, A. J., VAN VELDHUISEN, D. J., PARKHOMENKO, A., BORBOLA, J., COHEN-SOLAL, A., DUMITRASCU, D., FERRARI, R., LECHAT, P., SOLER-SOLER, J., TAVAZZI, L., SPINAROVA, L., TOMAN, J., BOHM, M., ANKER, S. D., THOMPSON, S. G. & POOLE-WILSON, P. A. 2005. Randomized trial to determine the effect of nebivolol on mortality and cardiovascular hospital admission in elderly patients with heart failure (SENIORS). *Eur Heart J*, 26, 215-25.
- FLETCHER, G. F., BALADY, G., FROELICHER, V. F., HARTLEY, L. H., HASKELL, W. L. & POLLOCK, M. L. 1995. Exercise standards. A statement for healthcare professionals from the American Heart Association. Writing Group. *Circulation*, 91, 580-615.
- FLEVARI, P., LEFTHERIOTIS, D., FOUNTOULAKI, K., PANOU, F., RIGOPOULOS, A. G., PARASKEVAIDIS, I. & KREMASTINOS, D. T. 2009. Long-term nonoutflow septal versus apical right ventricular pacing: relation to left ventricular dyssynchrony. *Pacing Clin Electrophysiol*, 32, 354-62.
- FOLEY, P. W., LEYVA, F. & FRENNEAUX, M. P. 2009. What is treatment success in cardiac resynchronization therapy? *Europace*, 11 Suppl 5, v58-65.
- FONSECA, C. 2006. Diagnosis of heart failure in primary care. *Heart Fail Rev*, 11, 95-107.
- FREEMAN, J. V., REYNOLDS, K., FANG, M., UDALTSOVA, N., STEIMLE, A., POMERNACKI, N. K., BOROWSKY, L. H., HARRISON, T. N., SINGER, D. E. & GO, A. S. 2015. Digoxin and risk of death in adults with atrial fibrillation: the ATRIA-CVRN study. *Circ Arrhythm Electrophysiol*, 8, 49-58.
- FREUDENBERGER, R. S., WILSON, A. C., LAWRENCE-NELSON, J., HARE, J. M. & KOSTIS, J. B. 2005. Permanent pacing is a risk factor for the development of heart failure. *Am J Cardiol*, 95, 671-4.
- FROHLICH, G., STEFFEL, J., HURLIMANN, D., ENSELEIT, F., LUSCHER, T. F., RUSCHITZKA, F., ABRAHAM, W. T. & HOLZMEISTER, J. 2010. Upgrading to resynchronization therapy after chronic right ventricular pacing improves left ventricular remodelling. *European Heart Journal*, 31, 1477-85.
- FUAT, A., MURPHY, J. J., HUNGIN, A. P., CURRY, J., MEHRZAD, A. A., HETHERINGTON, A., JOHNSTON, J. I., SMELLIE, W. S., DUFFY, V. & CAWLEY, P. 2006. The diagnostic accuracy and utility of a B-type

- natriuretic peptide test in a community population of patients with suspected heart failure. *Br J Gen Pract*, 56, 327-33.
- FURMAN, S. 2002. Early History of Cardiac Pacing and Defibrillation. *Indian Pacing Electrophysiol J*, 2, 2-3.
- FYE, W. B. 1990. Karel Frederik Wenckebach, 1864-1940. *Clin Cardiol*, 13, 146-8.
- FYE, W. B. 1999. Rudolf Albert von Koelliker. *Clin Cardiol*, 22, 376-7.
- GANDHI, M. S., KAMALOV, G., SHAHBAZ, A. U., BHATTACHARYA, S. K., AHOKAS, R. A., SUN, Y., GERLING, I. C. & WEBER, K. T. 2011. Cellular and molecular pathways to myocardial necrosis and replacement fibrosis. *Heart Fail Rev*, 16, 23-34.
- GARG, R. & YUSUF, S. 1995. Overview of randomized trials of angiotensin-converting enzyme inhibitors on mortality and morbidity in patients with heart failure. Collaborative Group on ACE Inhibitor Trials. *Jama*, 273, 1450-6.
- GASPARINI, M., PROCLEMER, A., KLERSY, C., KLOPPE, A., LUNATI, M., FERRER, J. B., HERSI, A., GULAJ, M., WIJFELS, M. C., SANTI, E., MANOTTA, L. & ARENAL, A. 2013. Effect of long-detection interval vs standard-detection interval for implantable cardioverter-defibrillators on antitachycardia pacing and shock delivery: the ADVANCE III randomized clinical trial. *Jama*, 309, 1903-11.
- GERBER, Y., WESTON, S. A., REDFIELD, M. M., CHAMBERLAIN, A. M., MANEMANN, S. M., JIANG, R., KILLIAN, J. M. & ROGER, V. L. 2015. A contemporary appraisal of the heart failure epidemic in Olmsted County, Minnesota, 2000 to 2010. *JAMA Intern Med*, 175, 996-1004.
- GHEORGHIADÉ, M., HALL, V. B., JACOBSEN, G., ALAM, M., ROSMAN, H. & GOLDSTEIN, S. 1995. Effects of increasing maintenance dose of digoxin on left ventricular function and neurohormones in patients with chronic heart failure treated with diuretics and angiotensin-converting enzyme inhibitors. *Circulation*, 92, 1801-7.
- GHIO, S., CONSTANTIN, C., KLERSY, C., SERIO, A., FONTANA, A., CAMPANA, C. & TAVAZZI, L. 2004. Interventricular and intraventricular dyssynchrony are common in heart failure patients, regardless of QRS duration. *Eur Heart J*, 25, 571-8.
- GHOSH, S., SILVA, J. N., CANHAM, R. M., BOWMAN, T. M., ZHANG, J., RHEE, E. K., WOODARD, P. K. & RUDY, Y. 2011. Electrophysiologic substrate and intraventricular left ventricular dyssynchrony in nonischemic heart failure patients undergoing cardiac resynchronization therapy. *Heart Rhythm*, 8, 692-9.
- GILLIS, A. M., PURERFELLNER, H., ISRAEL, C. W., SUNTHORN, H., KACET, S., ANELLI-MONTI, M., TANG, F., YOUNG, M. & BORIANI, G. 2006. Reducing unnecessary right ventricular pacing with the managed ventricular pacing mode in patients with sinus node disease and AV block. *Pacing Clin Electrophysiol*, 29, 697-705.
- GONCALVES, A., CLAGGETT, B., JHUND, P. S., ROSAMOND, W., DESWAL, A., AGUILAR, D., SHAH, A. M., CHENG, S. & SOLOMON, S. D. 2015. Alcohol consumption and risk of heart failure: the Atherosclerosis Risk in Communities Study. *Eur Heart J*, 36, 939-45.
- GORCSAN, J., 3RD, OYENUGA, O., HABIB, P. J., TANAKA, H., ADELSTEIN, E. C., HARA, H., MCNAMARA, D. M. & SABA, S. 2010. Relationship of echocardiographic dyssynchrony to long-term survival after cardiac resynchronization therapy. *Circulation*, 122, 1910-8.
- GORCSAN, J., 3RD, TANABE, M., BLEEKER, G. B., SUFFOLETTO, M. S., THOMAS, N. C., SABA, S., TOPS, L. F., SCHALIJ, M. J. & BAX, J. J. 2007. Combined longitudinal and radial dyssynchrony predicts ventricular response after resynchronization therapy. *J Am Coll Cardiol*, 50, 1476-83.

- GOTT, V. L. 2007. Critical role of physiologist John A. Johnson in the origins of Minnesota's billion dollar pacemaker industry. *Ann Thorac Surg*, 83, 349-53.
- GRANGER, C. B., MCMURRAY, J. J., YUSUF, S., HELD, P., MICHELSON, E. L., OLOFSSON, B., OSTERGREN, J., PFEFFER, M. A. & SWEDBERG, K. 2003. Effects of candesartan in patients with chronic heart failure and reduced left-ventricular systolic function intolerant to angiotensin-converting-enzyme inhibitors: the CHARM-Alternative trial. *Lancet*, 362, 772-6.
- GRINES, C. L., BASHORE, T. M., BOUDOULAS, H., OLSON, S., SHAFER, P. & WOOLEY, C. F. 1989. Functional abnormalities in isolated left bundle branch block. The effect of interventricular asynchrony. *Circulation*, 79, 845-53.
- GROUP, B. H. R. S. A. 2014. *CRM National Clinical Audit Report* [Online]. British Heart Rhythm Society (BHRS). Available: <http://www.devicesurvey.com/> [Accessed 12/12/2016 2016].
- GUZZI, M., PALERMO, P., PONTONE, G., SUSINI, F. & AGOSTONI, P. 1999. Synergistic efficacy of enalapril and losartan on exercise performance and oxygen consumption at peak exercise in congestive heart failure. *Am J Cardiol*, 84, 1038-43.
- GULLESTAD, L., MYERS, J., ROSS, H., RICKENBACHER, P., SLAUSON, S., BELLIN, D., DO, D., VAGELOS, R. & FOWLER, M. 1998. Serial exercise testing and prognosis in selected patients considered for cardiac transplantation. *Am Heart J*, 135, 221-9.
- GUYATT, G. H. 1993. Measurement of health-related quality of life in heart failure. *J Am Coll Cardiol*, 22, 185a-191a.
- HADDAD, S. A., HOUBEN, R. P. & SERDIJN, W. A. 2006. The evolution of pacemakers. *IEEE Eng Med Biol Mag*, 25, 38-48.
- HANSEN, J. E., SUE, D. Y. & WASSERMAN, K. 1984. Predicted values for clinical exercise testing. *Am Rev Respir Dis*, 129, S49-55.
- HARRINGTON, D. & COATS, A. J. 1997. Mechanisms of exercise intolerance in congestive heart failure. *Curr Opin Cardiol*, 12, 224-32.
- HAY, I., MELENOVSKY, V., FETICS, B. J., JUDGE, D. P., KRAMER, A., SPINELLI, J., REISTER, C., KASS, D. A. & BERGER, R. D. 2004. Short-term effects of right-left heart sequential cardiac resynchronization in patients with heart failure, chronic atrial fibrillation, and atrioventricular nodal block. *Circulation*, 110, 3404-10.
- HAYWOOD, G. A., KATRITSIS, D., WARD, J., LEIGH-JONES, M., WARD, D. E. & CAMM, A. J. 1993. Atrial adaptive rate pacing in sick sinus syndrome: effects on exercise capacity and arrhythmias. *Br Heart J*, 69, 174-8.
- HERMAN, D. S., LAM, L., TAYLOR, M. R., WANG, L., TEEKAKIRIKUL, P., CHRISTODOULOU, D., CONNER, L., DEPALMA, S. R., MCDONOUGH, B., SPARKS, E., TEODORESCU, D. L., CIRINO, A. L., BANNER, N. R., PENNELL, D. J., GRAW, S., MERLO, M., DI LENARDA, A., SINAGRA, G., BOS, J. M., ACKERMAN, M. J., MITCHELL, R. N., MURRY, C. E., LAKDAWALA, N. K., HO, C. Y., BARTON, P. J., COOK, S. A., MESTRONI, L., SEIDMAN, J. G. & SEIDMAN, C. E. 2012. Truncations of titin causing dilated cardiomyopathy. *N Engl J Med*, 366, 619-28.
- HESSELSON, A. B., PARSONNET, V., BERNSTEIN, A. D. & BONAVIDA, G. J. 1992. Deleterious effects of long-term single-chamber ventricular pacing in patients with sick sinus syndrome: the hidden benefits of dual-chamber pacing. *J Am Coll Cardiol*, 19, 1542-9.
- HILL, A. B. 1965. THE ENVIRONMENT AND DISEASE: ASSOCIATION OR CAUSATION? *Proc R Soc Med*, 58, 295-300.
- HILLOCK, R. J. & MOND, H. G. 2012. Pacing the right ventricular outflow tract septum: time to embrace the future. *Europace*, 14, 28-35.

- HIMELMAN, R. B., CASSIDY, M. M., LANDZBERG, J. S. & SCHILLER, N. B. 1988. Reproducibility of quantitative two-dimensional echocardiography. *Am Heart J*, 115, 425-31.
- HJALMARSON, A., GOLDSTEIN, S., FAGERBERG, B., WEDEL, H., WAAGSTEIN, F., KJEKSHUS, J., WIKSTRAND, J., EL ALLAF, D., VITOVEC, J., ALDERSHVILE, J., HALINEN, M., DIETZ, R., NEUHAUS, K. L., JANOSI, A., THORGEIRSSON, G., DUNSELMAN, P. H., GULLESTAD, L., KUCH, J., HERLITZ, J., RICKENBACHER, P., BALL, S., GOTTLIEB, S. & DEEDWANIA, P. 2000. Effects of controlled-release metoprolol on total mortality, hospitalizations, and well-being in patients with heart failure: the Metoprolol CR/XL Randomized Intervention Trial in congestive heart failure (MERIT-HF). MERIT-HF Study Group. *Jama*, 283, 1295-302.
- HO, K. K., PINSKY, J. L., KANNEL, W. B. & LEVY, D. 1993. The epidemiology of heart failure: the Framingham Study. *J Am Coll Cardiol*, 22, 6a-13a.
- HOBBS, F. D., KENKRE, J. E., ROALFE, A. K., DAVIS, R. C., HARE, R. & DAVIES, M. K. 2002. Impact of heart failure and left ventricular systolic dysfunction on quality of life: a cross-sectional study comparing common chronic cardiac and medical disorders and a representative adult population. *Eur Heart J*, 23, 1867-76.
- HOGG, K., SWEDBERG, K. & MCMURRAY, J. 2004. Heart failure with preserved left ventricular systolic function; epidemiology, clinical characteristics, and prognosis. *J Am Coll Cardiol*, 43, 317-27.
- HOHNLOSER, S. H., KUCK, K. H., DORIAN, P., ROBERTS, R. S., HAMPTON, J. R., HATALA, R., FAIN, E., GENT, M. & CONNOLLY, S. J. 2004. Prophylactic use of an implantable cardioverter-defibrillator after acute myocardial infarction. *N Engl J Med*, 351, 2481-8.
- HOIJER, C. J., MEURLING, C. & BRANDT, J. 2006. Upgrade to biventricular pacing in patients with conventional pacemakers and heart failure: a double-blind, randomized crossover study. *Europace*, 8, 51-5.
- HOPPS, J. A. 1981. The development of the pacemaker. *Pacing Clin Electrophysiol*, 4, 106-8.
- HUELSMANN, M., NEUHOLD, S., RESL, M., STRUNK, G., BRATH, H., FRANCESCO, C., ADLBRECHT, C., PRAGER, R., LUGER, A., PACHER, R. & CLODI, M. 2013. PONTIAC (NT-proBNP selected prevention of cardiac events in a population of diabetic patients without a history of cardiac disease): a prospective randomized controlled trial. *J Am Coll Cardiol*, 62, 1365-72.
- INGLE, L., GOODE, K., CARROLL, S., SLOAN, R., BOYES, C., CLELAND, J. G. & CLARK, A. L. 2007. Prognostic value of the VE/VCO₂ slope calculated from different time intervals in patients with suspected heart failure. *Int J Cardiol*, 118, 350-5.
- IRNICH, W., PARSONNET, V. & MYERS, G. H. 1978. Compendium of pacemaker technology. Introduction and historical review. *Pacing Clin Electrophysiol*, 1, 371-4.
- JAHANGIR, A., SHEN, W. K., NEUBAUER, S. A., BALLARD, D. J., HAMMILL, S. C., HODGE, D. O., LOHSE, C. M., GERSH, B. J. & HAYES, D. L. 1999. Relation between mode of pacing and long-term survival in the very elderly. *J Am Coll Cardiol*, 33, 1208-16.
- JEFFREY, K. & PARSONNET, V. 1998. Cardiac pacing, 1960-1985: a quarter century of medical and industrial innovation. *Circulation*, 97, 1978-91.
- JELIC, V., BELKIC, K., DJORDJEVIC, M. & KOCOVIĆ, D. 1992. Survival in 1,431 pacemaker patients: prognostic factors and comparison with the general population. *Pacing Clin Electrophysiol*, 15, 141-7.
- JOHN CAMM, A., JONES, S., GAMMAGE, M. D. & ROWLAND, E. 2010. Aubrey Leatham and the introduction of cardiac pacing to the UK. *Europace*, 12, 1356-9.

- JOHNSTON, F. D. 1952. Frank Norman Wilson: November 19, 1890-September 11, 1952. *Circulation*, 6, 641-2.
- JONES, S. O. T., ECKART, R. E., ALBERT, C. M. & EPSTEIN, L. M. 2008. Large, single-center, single-operator experience with transvenous lead extraction: outcomes and changing indications. *Heart Rhythm*, 5, 520-5.
- JONG, P., YUSUF, S., ROUSSEAU, M. F., AHN, S. A. & BANGDIWALA, S. I. 2003. Effect of enalapril on 12-year survival and life expectancy in patients with left ventricular systolic dysfunction: a follow-up study. *Lancet*, 361, 1843-8.
- JUTZY, R. V., FLORIO, J., ISAEFF, D. M., MARSA, R. J., BANSAL, R. C., JUTZY, K. R., LEVINE, P. A. & FEENSTRA, L. 1990. Comparative evaluation of rate modulated dual chamber and VVIR pacing. *Pacing Clin Electrophysiol*, 13, 1838-46.
- K WASSERMAN, J. H., D SUE, W STRINGER, B WHIPP 2004. *Principles of Exercise Testing and Interpretation*, Philadelphia, USA, Lippincott Williams & Wilkins.
- KALOGEROPOULOS, A. P., GEORGIOPOULOU, V. V., DEFILIPPI, C. R., GOTTDIENER, J. S. & BUTLER, J. 2012. Echocardiography, natriuretic peptides, and risk for incident heart failure in older adults: the Cardiovascular Health Study. *JACC Cardiovasc Imaging*, 5, 131-40.
- KALOGEROPOULOS, A. P., GEORGIOPOULOU, V. V., HOWELL, S., PERNETZ, M. A., FISHER, M. R., LERAKIS, S. & MARTIN, R. P. 2008. Evaluation of right intraventricular dyssynchrony by two-dimensional strain echocardiography in patients with pulmonary arterial hypertension. *J Am Soc Echocardiogr*, 21, 1028-34.
- KARLOF, I. 1975. Haemodynamic effect of atrial triggered versus fixed rate pacing at rest and during exercise in complete heart block. *Acta Med Scand*, 197, 195-206.
- KARPAWICH, P. P., RABAH, R. & HAAS, J. E. 1999. Altered cardiac histology following apical right ventricular pacing in patients with congenital atrioventricular block. *Pacing Clin Electrophysiol*, 22, 1372-7.
- KASS, D. A. 2008. An epidemic of dyssynchrony: but what does it mean? *J Am Coll Cardiol*, 51, 12-7.
- KASS, D. A., CHEN, C. H., CURRY, C., TALBOT, M., BERGER, R., FETICS, B. & NEVO, E. 1999. Improved left ventricular mechanics from acute VDD pacing in patients with dilated cardiomyopathy and ventricular conduction delay. *Circulation*, 99, 1567-73.
- KATSCHNIG, H. 2006. Quality of life in mental disorders: challenges for research and clinical practice. *World Psychiatry*, 5, 139-145.
- KATZ, A. M. & KATZ, P. B. 1962. DISEASE OF THE HEART IN THE WORKS OF HIPPOCRATES. *Br Heart J*, 24, 257-64.
- KATZ, A. M. & KONSTAM, M. A. 2008. Definition, historical aspects. *Heart Failure: Pathophysiology, Molecular Biology, and Clinical Management*. 2nd ed. Baltimore, MD: Lippincott Williams & Wilkins.
- KAYE, G., STAMBLER, B. S. & YEE, R. 2009. Search for the optimal right ventricular pacing site: design and implementation of three randomized multicenter clinical trials. *Pacing Clin Electrophysiol*, 32, 426-33.
- KAYE, G. C., LINKER, N. J., MARWICK, T. H., POLLOCK, L., GRAHAM, L., POULIOT, E., POLONIECKI, J. & GAMMAGE, M. 2015. Effect of right ventricular pacing lead site on left ventricular function in patients with high-grade atrioventricular block: results of the Protect-Pace study. *Eur Heart J*, 36, 856-62.
- KELDER, J. C., CRAMER, M. J., VAN WIJNGAARDEN, J., VAN TOOREN, R., MOSTERD, A., MOONS, K. G., LAMMERS, J. W., COWIE, M. R., GROBBEE, D. E. & HOES, A. W. 2011a. The diagnostic value of physical

- examination and additional testing in primary care patients with suspected heart failure. *Circulation*, 124, 2865-73.
- KELDER, J. C., CRAMER, M. J., VERWEIJ, W. M., GROBBEE, D. E. & HOES, A. W. 2011b. Clinical utility of three B-type natriuretic peptide assays for the initial diagnostic assessment of new slow-onset heart failure. *J Card Fail*, 17, 729-34.
- KENCHIAH, S., EVANS, J. C., LEVY, D., WILSON, P. W., BENJAMIN, E. J., LARSON, M. G., KANNEL, W. B. & VASAN, R. S. 2002. Obesity and the risk of heart failure. *N Engl J Med*, 347, 305-13.
- KERCKHOFFS, R. C., OMENS, J. H. & MCCULLOCH, A. D. 2012. Mechanical discoordination increases continuously after the onset of left bundle branch block despite constant electrical dyssynchrony in a computational model of cardiac electromechanics and growth. *Europace*, 14 Suppl 5, v65-v72.
- KERMODE-SCOTT, B. *Wilfred G Bigelow*, BMJ. 2005 Apr 23;330(7497):967.
- KHAN, F. Z., VIRDEE, M. S., PALMER, C. R., PUGH, P. J., O'HALLORAN, D., ELSIK, M., READ, P. A., BEGLEY, D., FYNN, S. P. & DUTKA, D. P. 2012. Targeted left ventricular lead placement to guide cardiac resynchronization therapy: the TARGET study: a randomized, controlled trial. *J Am Coll Cardiol*, 59, 1509-18.
- KHAND, A. U., CLELAND, J. G. & DEEDWANIA, P. C. 2002. Prevention of and medical therapy for atrial arrhythmias in heart failure. *Heart Fail Rev*, 7, 267-83.
- KHAND, A. U., GEMMELL, I., RANKIN, A. C. & CLELAND, J. G. 2001. Clinical events leading to the progression of heart failure: insights from a national database of hospital discharges. *Eur Heart J*, 22, 153-64.
- KINDERMANN, M., HENNEN, B., JUNG, J., GEISEL, J., BOHM, M. & FROHLIG, G. 2006. Biventricular versus conventional right ventricular stimulation for patients with standard pacing indication and left ventricular dysfunction: the Homburg Biventricular Pacing Evaluation (HOBIPACE). *J Am Coll Cardiol*, 47, 1927-37.
- KING, J. B., BRESS, A. P., REESE, A. D. & MUNGER, M. A. 2015. Nephilysin Inhibition in Heart Failure with Reduced Ejection Fraction: A Clinical Review. *Pharmacotherapy*, 35, 823-37.
- KINI, V., SOUFI, M. K., DEO, R., EPSTEIN, A. E., BALA, R., RILEY, M., GROENEVELD, P. W., SHALABY, A. & DIXIT, S. 2014. Appropriateness of primary prevention implantable cardioverter-defibrillators at the time of generator replacement: are indications still met? *J Am Coll Cardiol*, 63, 2388-94.
- KIRK, J. A. & KASS, D. A. 2013a. Electromechanical dyssynchrony and resynchronization of the failing heart. *Circ Res*, 113, 765-76.
- KIRK, J. A. & KASS, D. A. 2013b. Electromechanical dyssynchrony and resynchronization of the failing heart. *Circulation Research*, 113, 765-76.
- KJEKSHUS, J., PEDERSEN, T. R., OLSSON, A. G., FAERGEMAN, O. & PYORALA, K. 1997. The effects of simvastatin on the incidence of heart failure in patients with coronary heart disease. *J Card Fail*, 3, 249-54.
- KLEIJN, S. A., ALY, M. F., KNOL, D. L., TERWEE, C. B., JANSMA, E. P., ABD EL-HADY, Y. A., KANDIL, H. I., SOROUR, K. A., VAN ROSSUM, A. C. & KAMP, O. 2012. A meta-analysis of left ventricular dyssynchrony assessment and prediction of response to cardiac resynchronization therapy by three-dimensional echocardiography. *Eur Heart J Cardiovasc Imaging*, 13, 763-75.
- KOBER, L., TORP-PEDERSEN, C., CARLSEN, J. E., BAGGER, H., ELIASSEN, P., LYNGBORG, K., VIDEBAEK, J., COLE, D. S., AUCLERT, L. & PAULY, N. C. 1995. A clinical trial of the angiotensin-converting-enzyme inhibitor trandolapril in patients with left ventricular dysfunction after myocardial

- infarction. Trandolapril Cardiac Evaluation (TRACE) Study Group. *N Engl J Med*, 333, 1670-6.
- KOBER, L., TORP-PEDERSEN, C., MCMURRAY, J. J., GOTZSCHE, O., LEVY, S., CRIJNS, H., AMLIE, J. & CARLSEN, J. 2008. Increased mortality after dronedarone therapy for severe heart failure. *N Engl J Med*, 358, 2678-87.
- KOLB, C., SCHMIDT, R., DIETL, J. U., WEYERBROCK, S., MORGENSTERN, M., FLECKENSTEIN, M., BEIER, T., VON BARY, C., MACKES, K. G., WIDMAIER, J., KREUZER, J., SEMMLER, V. & ZRENNER, B. 2011. Reduction of right ventricular pacing with advanced atrioventricular search hysteresis: results of the PREVENT study. *Pacing Clin Electrophysiol*, 34, 975-83.
- KONSTANTINIDIS, K., WHELAN, R. S. & KITSIS, R. N. 2012. Mechanisms of cell death in heart disease. *Arteriosclerosis, thrombosis, and vascular biology*, 32, 1552-1562.
- KOSTIS, J. B., DAVIS, B. R., CUTLER, J., GRIMM, R. H., JR., BERGE, K. G., COHEN, J. D., LACY, C. R., PERRY, H. M., JR., BLAUFox, M. D., WASSERTHEIL-SMOLLER, S., BLACK, H. R., SCHRON, E., BERKSON, D. M., CURB, J. D., SMITH, W. M., MCDONALD, R. & APPLGATE, W. B. 1997. Prevention of heart failure by antihypertensive drug treatment in older persons with isolated systolic hypertension. SHEP Cooperative Research Group. *Jama*, 278, 212-6.
- KOTECHA, D., HOLMES, J., KRUM, H., ALTMAN, D. G., MANZANO, L., CLELAND, J. G., LIP, G. Y., COATS, A. J., ANDERSSON, B., KIRCHHOFF, P., VON LUEDER, T. G., WEDEL, H., ROSANO, G., SHIBATA, M. C., RIGBY, A. & FLATHER, M. D. 2014. Efficacy of beta blockers in patients with heart failure plus atrial fibrillation: an individual-patient data meta-analysis. *Lancet*, 384, 2235-43.
- KRISHNASWAMY, P., LUBIEN, E., CLOPTON, P., KOON, J., KAZANEGRA, R., WANNER, E., GARDETTO, N., GARCIA, A., DEMARIA, A. & MAISEL, A. S. 2001. Utility of B-natriuretic peptide levels in identifying patients with left ventricular systolic or diastolic dysfunction. *Am J Med*, 111, 274-9.
- KRISTENSSON, B. E., ARNMAN, K., SMEDGARD, P. & RYDEN, L. 1985. Physiological versus single-rate ventricular pacing: a double-blind cross-over study. *Pacing Clin Electrophysiol*, 8, 73-84.
- KRUM, H., BIGGER, J. T., JR., GOLDSMITH, R. L. & PACKER, M. 1995. Effect of long-term digoxin therapy on autonomic function in patients with chronic heart failure. *J Am Coll Cardiol*, 25, 289-94.
- KRUM, H., VAN VELDHUISEN, D. J., FUNCK-BRENTANO, C., VANOLI, E., SILKE, B., ERDMANN, E., FOLLATH, F., PONIKOWSKI, P., GOULDER, M., MEYER, W., LECHAT, P. & WILLENHEIMER, R. 2011. Effect on mode of death of heart failure treatment started with bisoprolol followed by Enalapril, compared to the opposite order: results of the randomized CIBIS III trial. *Cardiovasc Ther*, 29, 89-98.
- KRUSE, I., ARNMAN, K., CONRADSON, T. B. & RYDEN, L. 1982. A comparison of the acute and long-term hemodynamic effects of ventricular inhibited and atrial synchronous ventricular inhibited pacing. *Circulation*, 65, 846-55.
- KYPTA, A., STEINWENDER, C., KAMMLER, J., LEISCH, F. & HOFMANN, R. 2008. Long-term outcomes in patients with atrioventricular block undergoing septal ventricular lead implantation compared with standard apical pacing. *Europace*, 10, 574-9.
- KYRIACOU, A., WHINNETT, Z. I., SEN, S., PABARI, P. A., WRIGHT, I., CORNELUSSEN, R., LEFROY, D., DAVIES, D. W., PETERS, N. S., KANAGARATNAM, P., MAYET, J., HUGHES, A. D., FRANCIS, D. P. & DAVIES, J. E. 2012. Improvement in coronary blood flow velocity with acute biventricular pacing is predominantly due to an increase in a diastolic

- backward-travelling decompression (suction) wave. *Circulation*, 126, 1334-44.
- LAMAS, G. A., ORAV, E. J., STAMBLER, B. S., ELLENBOGEN, K. A., SGARBOSSA, E. B., HUANG, S. K., MARINCHAK, R. A., ESTES, N. A., 3RD, MITCHELL, G. F., LIEBERMAN, E. H., MANGIONE, C. M. & GOLDMAN, L. 1998. Quality of life and clinical outcomes in elderly patients treated with ventricular pacing as compared with dual-chamber pacing. Pacemaker Selection in the Elderly Investigators. *N Engl J Med*, 338, 1097-104.
- LANG, R. M., BADANO, L. P., MOR-AVI, V., AFILALO, J., ARMSTRONG, A., ERNANDE, L., FLACHSKAMPF, F. A., FOSTER, E., GOLDSTEIN, S. A., KUZNETSOVA, T., LANCELLOTTI, P., MURARU, D., PICARD, M. H., RIETZSCHEL, E. R., RUDSKI, L., SPENCER, K. T., TSANG, W. & VOIGT, J.-U. 2015. Recommendations for Cardiac Chamber Quantification by Echocardiography in Adults: An Update from the American Society of Echocardiography and the European Association of Cardiovascular Imaging. *European Heart Journal – Cardiovascular Imaging*, 16, 233-271.
- LARSSON, B., ELMQVIST, H., RYDEN, L. & SCHULLER, H. 2003. Lessons from the first patient with an implanted pacemaker: 1958-2001. *Pacing Clin Electrophysiol*, 26, 114-24.
- LARSSON, S. C., ORSINI, N. & WOLK, A. 2015. Alcohol consumption and risk of heart failure: a dose-response meta-analysis of prospective studies. *Eur J Heart Fail*, 17, 367-73.
- LAU, C. P., RUSHBY, J., LEIGH-JONES, M., TAM, C. Y., POLONIECKI, J., INGRAM, A., SUTTON, R. & CAMM, A. J. 1989. Symptomatology and quality of life in patients with rate-responsive pacemakers: a double-blind, randomized, crossover study. *Clin Cardiol*, 12, 505-12.
- LAU, C. P., WONG, C. K., LEUNG, W. H. & LIU, W. X. 1990. Superior cardiac hemodynamics of atrioventricular synchrony over rate responsive pacing at submaximal exercise: observations in activity sensing DDDR pacemakers. *Pacing Clin Electrophysiol*, 13, 1832-7.
- LAURENZI, F., ACHILLI, A., AVELLA, A., PERALDO, C., ORAZI, S., PEREGO, G. B., CESARIO, A., VALSECCHI, S., DE SANTO, T., PUGLISI, A. & TONDO, C. 2007. Biventricular upgrading in patients with conventional pacing system and congestive heart failure: results and response predictors. *Pacing Clin Electrophysiol*, 30, 1096-104.
- LAZARUS, A. & MITCHELL, K. 1996. A prospective multicenter study demonstrating clinical benefit with a new accelerometer-based DDDR pacemaker. Dromos Dr Investigators Group. *Pacing Clin Electrophysiol*, 19, 1694-7.
- LECLERCQ, C. 2008. Upgrading from right ventricular pacing to biventricular pacing in pacemaker patients with chronic heart failure: Heart failure. *Heart*, 94, 102-7.
- LEDWIDGE, M., GALLAGHER, J., CONLON, C., TALLON, E., O'CONNELL, E., DAWKINS, I., WATSON, C., O'HANLON, R., BIRMINGHAM, M., PATLE, A., BADABHAGNI, M. R., MURTAGH, G., VOON, V., TILSON, L., BARRY, M., MCDONALD, L., MAURER, B. & MCDONALD, K. 2013. Natriuretic peptide-based screening and collaborative care for heart failure: the STOP-HF randomized trial. *Jama*, 310, 66-74.
- LEE, M. A., DAE, M. W., LANGBERG, J. J., GRIFFIN, J. C., CHIN, M. C., FINKBEINER, W. E., O'CONNELL, J. W., BOTVINICK, E., SCHEINMAN, M. M. & ROSENQVIST, M. 1994. Effects of long-term right ventricular apical pacing on left ventricular perfusion, innervation, function and histology. *J Am Coll Cardiol*, 24, 225-32.
- LEON, A. R., GREENBERG, J. M., KANURU, N., BAKER, C. M., MERA, F. V., SMITH, A. L., LANGBERG, J. J. & DELURGIO, D. B. 2002. Cardiac

- resynchronization in patients with congestive heart failure and chronic atrial fibrillation: effect of upgrading to biventricular pacing after chronic right ventricular pacing. *J Am Coll Cardiol*, 39, 1258-63.
- LEVINE, P. A. 2010. Ventricular pacing: to pace or not to pace. *Europace*, 12, 11-4.
- LEVY, D., KENCHIAIAH, S., LARSON, M. G., BENJAMIN, E. J., KUPKA, M. J., HO, K. K., MURABITO, J. M. & VASAN, R. S. 2002. Long-term trends in the incidence of and survival with heart failure. *N Engl J Med*, 347, 1397-402.
- LEVY, D., LARSON, M. G., VASAN, R. S., KANNEL, W. B. & HO, K. K. 1996. The progression from hypertension to congestive heart failure. *Jama*, 275, 1557-62.
- LIEBERMAN, R., PADELETTI, L., SCHREUDER, J., JACKSON, K., MICHELUCCI, A., COLELLA, A., EASTMAN, W., VALSECCHI, S. & HETTRICK, D. A. 2006. Ventricular pacing lead location alters systemic hemodynamics and left ventricular function in patients with and without reduced ejection fraction. *J Am Coll Cardiol*, 48, 1634-41.
- LIM, P., BUAKHAMSRI, A., POPOVIC, Z. B., GREENBERG, N. L., PATEL, D., THOMAS, J. D. & GRIMM, R. A. 2008. Longitudinal strain delay index by speckle tracking imaging: a new marker of response to cardiac resynchronization therapy. *Circulation*, 118, 1130-7.
- LINDE, C., ABRAHAM, W. T., GOLD, M. R., ST JOHN SUTTON, M., GHIO, S. & DAUBERT, C. 2008. Randomized trial of cardiac resynchronization in mildly symptomatic heart failure patients and in asymptomatic patients with left ventricular dysfunction and previous heart failure symptoms. *J Am Coll Cardiol*, 52, 1834-43.
- LLOYD-JONES, D. M., LARSON, M. G., LEIP, E. P., BEISER, A., D'AGOSTINO, R. B., KANNEL, W. B., MURABITO, J. M., VASAN, R. S., BENJAMIN, E. J. & LEVY, D. 2002. Lifetime risk for developing congestive heart failure: the Framingham Heart Study. *Circulation*, 106, 3068-72.
- MAGGIONI, A. P., ANKER, S. D., DAHLSTROM, U., FILIPPATOS, G., PONIKOWSKI, P., ZANNAD, F., AMIR, O., CHIONCEL, O., LEIRO, M. C., DROZDZ, J., ERGLIS, A., FAZLIBEGOVIC, E., FONSECA, C., FRUHWALD, F., GATZOV, P., GONCALVESOVA, E., HASSANEIN, M., HRADEC, J., KAVOLIUNIENE, A., LAINSCAK, M., LOGEART, D., MERKELY, B., METRA, M., PERSSON, H., SEFEROVIC, P., TEMIZHAN, A., TOUSOULIS, D. & TAVAZZI, L. 2013a. Are hospitalized or ambulatory patients with heart failure treated in accordance with European Society of Cardiology guidelines? Evidence from 12,440 patients of the ESC Heart Failure Long-Term Registry. *Eur J Heart Fail*, 15, 1173-84.
- MAGGIONI, A. P., DAHLSTROM, U., FILIPPATOS, G., CHIONCEL, O., CRESPO LEIRO, M., DROZDZ, J., FRUHWALD, F., GULLESTAD, L., LOGEART, D., FABBRI, G., URSO, R., METRA, M., PARISSIS, J., PERSSON, H., PONIKOWSKI, P., RAUCHHAUS, M., VOORS, A. A., NIELSEN, O. W., ZANNAD, F. & TAVAZZI, L. 2013b. EURObservational Research Programme: regional differences and 1-year follow-up results of the Heart Failure Pilot Survey (ESC-HF Pilot). *Eur J Heart Fail*, 15, 808-17.
- MAHADEVAN, G., DAVIS, R. C., FRENNEAUX, M. P., HOBBS, F. D., LIP, G. Y., SANDERSON, J. E. & DAVIES, M. K. 2008. Left ventricular ejection fraction: are the revised cut-off points for defining systolic dysfunction sufficiently evidence based? *Heart*, 94, 426-8.
- MAISEL, A., MUELLER, C., ADAMS, K., JR., ANKER, S. D., ASPROMONTE, N., CLELAND, J. G., COHEN-SOLAL, A., DAHLSTROM, U., DEMARIA, A., DI SOMMA, S., FILIPPATOS, G. S., FONAROW, G. C., JOURDAIN, P., KOMAJDA, M., LIU, P. P., MCDONAGH, T., MCDONALD, K., MEBAZAA, A., NIEMINEN, M. S., PEACOCK, W. F., TUBARO, M., VALLE, R., VANDERHYDEN, M., YANCY, C. W., ZANNAD, F. & BRAUNWALD, E.

2008. State of the art: using natriuretic peptide levels in clinical practice. *Eur J Heart Fail*, 10, 824-39.
- MALINOWSKI, K. 1998. Interindividual comparison of different sensor principles for rate adaptive pacing. *Pacing Clin Electrophysiol*, 21, 2209-13.
- MANCINI, D. M., EISEN, H., KUSSMAUL, W., MULL, R., EDMUNDS, L. H., JR. & WILSON, J. R. 1991. Value of peak exercise oxygen consumption for optimal timing of cardiac transplantation in ambulatory patients with heart failure. *Circulation*, 83, 778-86.
- MANGIAFICO, S., COSTELLO-BOERRIGTER, L. C., ANDERSEN, I. A., CATALIOTTI, A. & BURNETT, J. C., JR. 2013. Neutral endopeptidase inhibition and the natriuretic peptide system: an evolving strategy in cardiovascular therapeutics. *Eur Heart J*, 34, 886-893c.
- MANN, D. L. 2002. Inflammatory mediators and the failing heart: past, present, and the foreseeable future. *Circ Res*, 91, 988-98.
- MANOLIS, A. S. 2006. The deleterious consequences of right ventricular apical pacing: time to seek alternate site pacing. *Pacing Clin Electrophysiol*, 29, 298-315.
- MANT, J., DOUST, J., ROALFE, A., BARTON, P., COWIE, M. R., GLASZIOU, P., MANT, D., MCMANUS, R. J., HOLDER, R., DEEKS, J., FLETCHER, K., QUME, M., SOHANPAL, S., SANDERS, S. & HOBBS, F. D. 2009. Systematic review and individual patient data meta-analysis of diagnosis of heart failure, with modelling of implications of different diagnostic strategies in primary care. *Health Technol Assess*, 13, 1-207, iii.
- MARBURGER, C. T., BRUBAKER, P. H., POLLOCK, W. E., MORGAN, T. M. & KITZMAN, D. W. 1998. Reproducibility of cardiopulmonary exercise testing in elderly patients with congestive heart failure. *Am J Cardiol*, 82, 905-9.
- MARCUS, J. T., GAN, C. T., ZWANENBURG, J. J., BOONSTRA, A., ALLAART, C. P., GOTTE, M. J. & VONK-NOORDEGRAAF, A. 2008. Interventricular mechanical asynchrony in pulmonary arterial hypertension: left-to-right delay in peak shortening is related to right ventricular overload and left ventricular underfilling. *J Am Coll Cardiol*, 51, 750-7.
- MARINSKIS, G., VAN ERVEN, L., BONGIORNI, M. G., LIP, G. Y., PISON, L. & BLOMSTROM-LUNDQVIST, C. 2012. Practices of cardiac implantable electronic device follow-up: results of the European Heart Rhythm Association survey. *Europace*, 14, 423-5.
- MARSAN, N. A., BLEEKER, G. B., YPENBURG, C., GHIO, S., VAN DE VEIRE, N. R., HOLMAN, E. R., VAN DER WALL, E. E., TAVAZZI, L., SCHALIJ, M. J. & BAX, J. J. 2008. Real-time three-dimensional echocardiography permits quantification of left ventricular mechanical dyssynchrony and predicts acute response to cardiac resynchronization therapy. *J Cardiovasc Electrophysiol*, 19, 392-9.
- MARSAN, N. A., WESTENBERG, J. J., YPENBURG, C., VAN BOMMEL, R. J., ROES, S., DELGADO, V., TOPS, L. F., VAN DER GEEST, R. J., BOERSMA, E., DE ROOS, A., SCHALIJ, M. J. & BAX, J. J. 2009. Magnetic resonance imaging and response to cardiac resynchronization therapy: relative merits of left ventricular dyssynchrony and scar tissue. *Eur Heart J*, 30, 2360-7.
- MARTIN, D. O., DAY, J. D., LAI, P. Y., MURPHY, A. L., NAYAK, H. M., VILLAREAL, R. P., WEINER, S., KRAUS, S. M., STOLEN, K. Q. & GOLD, M. R. 2012. Atrial support pacing in heart failure: results from the multicenter PEGASUS CRT trial. *J Cardiovasc Electrophysiol*, 23, 1317-25.
- MASAKI, H., IMAIZUMI, T., ANDO, S., HIROOKA, Y., HARADA, S., MOMOHARA, M., NAGANO, M. & TAKESHITA, A. 1993. Production of chronic congestive heart failure by rapid ventricular pacing in the rabbit. *Cardiovasc Res*, 27, 828-31.

- MAYOSI, B. M., LITTLE, F. & MILLAR, R. N. 1999. Long-term survival after permanent pacemaker implantation in young adults: 30 year experience. *Pacing Clin Electrophysiol*, 22, 407-12.
- MCMEEKIN, J. D., LAUTNER, D., HANSON, S. & GULAMHUSEIN, S. S. 1990. Importance of heart rate response during exercise in patients using atrioventricular synchronous and ventricular pacemakers. *Pacing Clin Electrophysiol*, 13, 59-68.
- MCMURRAY, J. J., ADAMOPOULOS, S., ANKER, S. D., AURICCHIO, A., BOHM, M., DICKSTEIN, K., FALK, V., FILIPPATOS, G., FONSECA, C., GOMEZ-SANCHEZ, M. A., JAARSMA, T., KOBER, L., LIP, G. Y., MAGGIONI, A. P., PARKHOMENKO, A., PIESKE, B. M., POPESCU, B. A., RONNEVIK, P. K., RUTTEN, F. H., SCHWITTER, J., SEFEROVIC, P., STEPINSKA, J., TRINDADE, P. T., VOORS, A. A., ZANNAD, F. & ZEHER, A. 2012. ESC Guidelines for the diagnosis and treatment of acute and chronic heart failure 2012: The Task Force for the Diagnosis and Treatment of Acute and Chronic Heart Failure 2012 of the European Society of Cardiology. Developed in collaboration with the Heart Failure Association (HFA) of the ESC. *Eur Heart J*, 33, 1787-847.
- MCMURRAY, J. J., PACKER, M., DESAI, A. S., GONG, J., LEFKOWITZ, M. P., RIZKALA, A. R., ROULEAU, J. L., SHI, V. C., SOLOMON, S. D., SWEDBERG, K. & ZILE, M. R. 2014. Angiotensin-neprilysin inhibition versus enalapril in heart failure. *N Engl J Med*, 371, 993-1004.
- MERCHANT, F. M., JONES, P., WEHRENBURG, S., LLOYD, M. S. & SAXON, L. A. 2014. Incidence of defibrillator shocks after elective generator exchange following uneventful first battery life. *J Am Heart Assoc*, 3, e001289.
- MEYER, K., WESTBROOK, S., SCHWAIBOLD, M., HAJRIC, R., PETERS, K. & ROSKAMM, H. 1997. Short-term reproducibility of cardiopulmonary measurements during exercise testing in patients with severe chronic heart failure. *Am Heart J*, 134, 20-6.
- MEZZANI, A., CORRA, U., BOSIMINI, E., GIORDANO, A. & GIANNUZZI, P. 2003. Contribution of peak respiratory exchange ratio to peak VO₂ prognostic reliability in patients with chronic heart failure and severely reduced exercise capacity. *Am Heart J*, 145, 1102-7.
- MILASINOVIC, G., TSCHELIESSNIGG, K., BOEHMER, A., VANCURA, V., SCHUCHERT, A., BRANDT, J., WIGGENHORN, C., HOFMAN, M. & SPERZEL, J. 2008. Percent ventricular pacing with managed ventricular pacing mode in standard pacemaker population. *Europace*, 10, 151-5.
- MILLER, R. J., HOWLETT, J. G., EXNER, D. V., CAMPBELL, P. M., GRANT, A. D. & WILTON, S. B. 2015. Baseline Functional Class and Therapeutic Efficacy of Common Heart Failure Interventions: A Systematic Review and Meta-analysis. *Can J Cardiol*, 31, 792-9.
- MILLS, R. W., CORNELUSSEN, R. N., MULLIGAN, L. J., STRIK, M., RADEMAKERS, L. M., SKADSBERG, N. D., VAN HUNNIK, A., KUIPER, M., LAMPERT, A., DELHAAS, T. & PRINZEN, F. W. 2009. Left ventricular septal and left ventricular apical pacing chronically maintain cardiac contractile coordination, pump function and efficiency. *Circ Arrhythm Electrophysiol*, 2, 571-9.
- MIYAMURA, M. & HONDA, Y. 1972. Oxygen intake and cardiac output during maximal treadmill and bicycle exercise. *J Appl Physiol*, 32, 185-8.
- MLYNARSKI, R., WLODYKA, A. & KARGUL, W. 2009. Changes in the mental and physical components of the quality of life for patients six months after pacemaker implantation. *Cardiol J*, 16, 250-3.
- MOLLEMA, S. A., BLEEKER, G. B., VAN DER WALL, E. E., SCHALIJ, M. J. & BAX, J. J. 2007. Usefulness of QRS duration to predict response to cardiac resynchronization therapy in patients with end-stage heart failure. *Am J Cardiol*, 100, 1665-70.

- MOND, H. G., HILLOCK, R. J., STEVENSON, I. H. & MCGAVIGAN, A. D. 2007. The right ventricular outflow tract: the road to septal pacing. *Pacing Clin Electrophysiol*, 30, 482-91.
- MOND, H. G., WICKHAM, G. G. & SLOMAN, J. G. 2012. The Australian history of cardiac pacing: memories from a bygone era. *Heart Lung Circ*, 21, 311-9.
- MONTALESCOT, G., PITT, B., LOPEZ DE SA, E., HAMM, C. W., FLATHER, M., VERHEUGT, F., SHI, H., TURGONYI, E., ORRI, M., VINCENT, J. & ZANNAD, F. 2014. Early eplerenone treatment in patients with acute ST-elevation myocardial infarction without heart failure: the Randomized Double-Blind Reminder Study. *Eur Heart J*, 35, 2295-302.
- MORITA, H., SEIDMAN, J. & SEIDMAN, C. E. 2005. Genetic causes of human heart failure. *J Clin Invest*, 115, 518-26.
- MOSS, A. J., HALL, W. J., CANNOM, D. S., DAUBERT, J. P., HIGGINS, S. L., KLEIN, H., LEVINE, J. H., SAKSENA, S., WALDO, A. L., WILBER, D., BROWN, M. W. & HEO, M. 1996. Improved survival with an implanted defibrillator in patients with coronary disease at high risk for ventricular arrhythmia. Multicenter Automatic Defibrillator Implantation Trial Investigators. *N Engl J Med*, 335, 1933-40.
- MOSS, A. J., HALL, W. J., CANNOM, D. S., KLEIN, H., BROWN, M. W., DAUBERT, J. P., ESTES, N. A., 3RD, FOSTER, E., GREENBERG, H., HIGGINS, S. L., PFEFFER, M. A., SOLOMON, S. D., WILBER, D. & ZAREBA, W. 2009. Cardiac-resynchronization therapy for the prevention of heart-failure events. *N Engl J Med*, 361, 1329-38.
- MOSS, A. J., SCHUGER, C., BECK, C. A., BROWN, M. W., CANNOM, D. S., DAUBERT, J. P., ESTES, N. A., 3RD, GREENBERG, H., HALL, W. J., HUANG, D. T., KAUTZNER, J., KLEIN, H., MCNITT, S., OLSHANSKY, B., SHODA, M., WILBER, D. & ZAREBA, W. 2012. Reduction in inappropriate therapy and mortality through ICD programming. *N Engl J Med*, 367, 2275-83.
- MOSTERD, A. & HOES, A. W. 2007. Clinical epidemiology of heart failure. *Heart*, 93, 1137-46.
- MURAKAMI, Y., TSUBOI, N., INDEN, Y., YOSHIDA, Y., MUROHARA, T., IHARA, Z. & TAKAMI, M. 2010. Difference in percentage of ventricular pacing between two algorithms for minimizing ventricular pacing: results of the IDEAL RVP (Identify the Best Algorithm for Reducing Unnecessary Right Ventricular Pacing) study. *Europace*, 12, 96-102.
- MURPHY, R. T., SIGURDSSON, G., MULAMALLA, S., AGLER, D., POPOVIC, Z. B., STARLING, R. C., WILKOFF, B. L., THOMAS, J. D. & GRIMM, R. A. 2006. Tissue synchronization imaging and optimal left ventricular pacing site in cardiac resynchronization therapy. *Am J Cardiol*, 97, 1615-21.
- MYERS, J., BUCHANAN, N., WALSH, D., KRAEMER, M., MCAULEY, P., HAMILTON-WESSLER, M. & FROELICHER, V. F. 1991. Comparison of the ramp versus standard exercise protocols. *J Am Coll Cardiol*, 17, 1334-42.
- MYERS, J. & FROELICHER, V. F. 1990. Optimizing the exercise test for pharmacological investigations. *Circulation*, 82, 1839-46.
- MYERS, J. & GULLESTAD, L. 1998. The role of exercise testing and gas-exchange measurement in the prognostic assessment of patients with heart failure. *Curr Opin Cardiol*, 13, 145-55.
- MYERS, J., GULLESTAD, L., VAGELOS, R., DO, D., BELLIN, D., ROSS, H. & FOWLER, M. B. 2000. Cardiopulmonary exercise testing and prognosis in severe heart failure: 14 mL/kg/min revisited. *Am Heart J*, 139, 78-84.
- NAGELE, H., DODECK, J., BEHRENS, S., AZIZI, M., HASHAGEN, S., EISERMANN, C. & CASTEL, M. A. 2008. Hemodynamics and prognosis after primary cardiac resynchronization system implantation compared to "upgrade" procedures. *Pacing Clin Electrophysiol*, 31, 1265-71.

- NAGLE, F. J., BALKE, B. & NAUGHTON, J. P. 1965. Gradational step tests for assessing work capacity. *J Appl Physiol*, 20, 745-8.
- NAHLAWI, M., WALIGORA, M., SPIES, S. M., BONOW, R. O., KADISH, A. H. & GOLDBERGER, J. J. 2004. Left ventricular function during and after right ventricular pacing. *J Am Coll Cardiol*, 44, 1883-8.
- NATIONAL CLINICAL GUIDELINE, C. 2010. National Institute for Health and Clinical Excellence: Guidance. *Chronic Heart Failure: National Clinical Guideline for Diagnosis and Management in Primary and Secondary Care: Partial Update*. London: Royal College of Physicians (UK)
- National Clinical Guideline Centre.
- NELSON, G. S., BERGER, R. D., FETICS, B. J., TALBOT, M., SPINELLI, J. C., HARE, J. M. & KASS, D. A. 2000. Left ventricular or biventricular pacing improves cardiac function at diminished energy cost in patients with dilated cardiomyopathy and left bundle-branch block. *Circulation*, 102, 3053-9.
- NERY, P. B., FERNANDES, R., NAIR, G. M., SUMNER, G. L., RIBAS, C. S., MENON, S. M., WANG, X., KRAHN, A. D., MORILLO, C. A., CONNOLLY, S. J. & HEALEY, J. S. 2010. Device-related infection among patients with pacemakers and implantable defibrillators: incidence, risk factors, and consequences. *J Cardiovasc Electrophysiol*, 21, 786-90.
- NICE. 2005. *Dual-chamber pacemakers for symptomatic bradycardia due to sick sinus syndrome and/or atrioventricular block* [Online]. Available: <http://www.nice.org.uk/guidance/TA88/history> [Accessed 05 Jan 2016].
- NIELSEN, J. C., ANDERSEN, H. R., THOMSEN, P. E., THUESEN, L., MORTENSEN, P. T., VESTERLUND, T. & PEDERSEN, A. K. 1998. Heart failure and echocardiographic changes during long-term follow-up of patients with sick sinus syndrome randomized to single-chamber atrial or ventricular pacing. *Circulation*, 97, 987-95.
- NIELSEN, J. C., BOTTCHE, M., NIELSEN, T. T., PEDERSEN, A. K. & ANDERSEN, H. R. 2000. Regional myocardial blood flow in patients with sick sinus syndrome randomized to long-term single chamber atrial or dual chamber pacing--effect of pacing mode and rate. *J Am Coll Cardiol*, 35, 1453-61.
- NIEMEIJER, M. N., VAN DEN BERG, M. E., LEENING, M. J., HOFMAN, A., FRANCO, O. H., DECKERS, J. W., HEERINGA, J., RIJNBEEK, P. R., STRICKER, B. H. & EIJGELSHEIM, M. 2015. Declining incidence of sudden cardiac death from 1990-2010 in a general middle-aged and elderly population: The Rotterdam Study. *Heart Rhythm*, 12, 123-9.
- NITARDY, A., LANGRECK, H., DIETZ, R. & STOCKBURGER, M. 2009. Reduction of right ventricular pacing in patients with sinus node dysfunction through programming a long atrioventricular delay along with the DDIR mode. *Clinical Research in Cardiology*, 98, 25-32.
- O'KEEFE, J. H., JR., ABUISSA, H., JONES, P. G., THOMPSON, R. C., BATEMAN, T. M., MCGHIE, A. I., RAMZA, B. M. & STEINHAUS, D. M. 2005. Effect of chronic right ventricular apical pacing on left ventricular function. *Am J Cardiol*, 95, 771-3.
- OCCHETTA, E., BORTNIK, M., MAGNANI, A., FRANCALACCI, G., PICCININO, C., PLEBANI, L. & MARINO, P. 2006. Prevention of ventricular desynchronization by permanent para-Hisian pacing after atrioventricular node ablation in chronic atrial fibrillation: a crossover, blinded, randomized study versus apical right ventricular pacing. *J Am Coll Cardiol*, 47, 1938-45.
- OHM, O. J. & BREIVIK, K. 1978. Patients with high-grade atrioventricular block treated and not treated with a pacemaker. *Acta Med Scand*, 203, 521-8.
- OHTANI, T., MOHAMMED, S. F., YAMAMOTO, K., DUNLAY, S. M., WESTON, S. A., SAKATA, Y., RODEHEFFER, R. J., ROGER, V. L. & REDFIELD, M. M. 2012. Diastolic stiffness as assessed by diastolic wall strain is associated

- with adverse remodelling and poor outcomes in heart failure with preserved ejection fraction. *European heart journal*, 33, 1742-1749.
- OLDE NORDKAMP, L. R., KNOPS, R. E., BARDY, G. H., BLAAUW, Y., BOERSMA, L. V., BOS, J. S., DELNOY, P. P., VAN DESSEL, P. F., DRIESSEN, A. H., DE GROOT, J. R., HERRMAN, J. P., JORDAENS, L. J., KOOIMAN, K. M., MAASS, A. H., MEINE, M., MIZUSAWA, Y., MOLHOEK, S. G., VAN OPSTAL, J., TIJSSEN, J. G. & WILDE, A. A. 2012. Rationale and design of the PRAETORIAN trial: a Prospective, RANdomizEd comparison of subcuTaneOus and tRansvenous ImplANtable cardioverter-defibrillator therapy. *Am Heart J*, 163, 753-760.e2.
- OLIVETTI, G., ABBI, R., QUAINI, F., KAJSTURA, J., CHENG, W., NITAHARA, J. A., QUAINI, E., DI LORETO, C., BELTRAMI, C. A., KRAJEWSKI, S., REED, J. C. & ANVERSA, P. 1997. Apoptosis in the failing human heart. *N Engl J Med*, 336, 1131-41.
- OLSHANSKY, B., DAY, J., MCGUIRE, M., HAHN, S., BROWN, S. & LEREW, D. R. 2006. Reduction of right ventricular pacing in patients with dual-chamber ICDs. *Pacing Clin Electrophysiol*, 29, 237-43.
- OLSHANSKY, B., DAY, J. D., MOORE, S., GERING, L., ROSENBAUM, M., MCGUIRE, M., BROWN, S. & LEREW, D. R. 2007. Is dual-chamber programming inferior to single-chamber programming in an implantable cardioverter-defibrillator? Results of the INTRINSIC RV (Inhibition of Unnecessary RV Pacing With AVSH in ICDs) study. *Circulation*, 115, 9-16.
- OPREANU, M., WAN, C., SINGH, V., SALEHI, N., AHMAD, J., SZYMKIEWICZ, S. J. & THAKUR, R. K. 2015. Wearable cardioverter-defibrillator as a bridge to cardiac transplantation: A national database analysis. *J Heart Lung Transplant*, 34, 1305-9.
- OUDEJANS, I., MOSTERD, A., BLOEMEN, J. A., VALK, M. J., VAN VELZEN, E., WIELDERS, J. P., ZUITHOFF, N. P., RUTTEN, F. H. & HOES, A. W. 2011. Clinical evaluation of geriatric outpatients with suspected heart failure: value of symptoms, signs, and additional tests. *Eur J Heart Fail*, 13, 518-27.
- OUYANG, A. J., LV, Y. N., ZHONG, H. L., WEN, J. H., WEI, X. H., PENG, H. W., ZHOU, J. & LIU, L. L. 2015. Meta-analysis of digoxin use and risk of mortality in patients with atrial fibrillation. *Am J Cardiol*, 115, 901-6.
- OWAN, T. E., HODGE, D. O., HERGES, R. M., JACOBSEN, S. J., ROGER, V. L. & REDFIELD, M. M. 2006. Trends in prevalence and outcome of heart failure with preserved ejection fraction. *N Engl J Med*, 355, 251-9.
- OWAN, T. E. & REDFIELD, M. M. 2005. Epidemiology of diastolic heart failure. *Prog Cardiovasc Dis*, 47, 320-32.
- OWEN, A. & SPINALE, F. 2010. Myocardial basis for heart failure: role of the cardiac interstitium. *Heart Failure: A Companion to Braunwald's Heart Disease. 2nd ed. Philadelphia, PA: Elsevier*, 73-84.
- OZDEMIR, K., ALTUNKESER, B. B., DANIS, G., OZDEMIR, A., ULUCA, Y., TOKAC, M., TELLI, H. H. & GOK, H. 2001. Effect of the isolated left bundle branch block on systolic and diastolic functions of left ventricle. *J Am Soc Echocardiogr*, 14, 1075-9.
- PACKER, M., COATS, A. J., FOWLER, M. B., KATUS, H. A., KRUM, H., MOHACSI, P., ROULEAU, J. L., TENDERA, M., CASTAIGNE, A., ROECKER, E. B., SCHULTZ, M. K. & DEMETS, D. L. 2001. Effect of carvedilol on survival in severe chronic heart failure. *N Engl J Med*, 344, 1651-8.
- PACKER, M., GHEORGHIADU, M., YOUNG, J. B., COSTANTINI, P. J., ADAMS, K. F., CODY, R. J., SMITH, L. K., VAN VOORHEES, L., GOURLEY, L. A. & JOLLY, M. K. 1993. Withdrawal of digoxin from patients with chronic heart failure treated with angiotensin-converting-enzyme inhibitors. RADIANCE Study. *N Engl J Med*, 329, 1-7.

- PACKER, M., POOLE-WILSON, P. A., ARMSTRONG, P. W., CLELAND, J. G., HOROWITZ, J. D., MASSIE, B. M., RYDEN, L., THYGESEN, K. & URETSKY, B. F. 1999. Comparative effects of low and high doses of the angiotensin-converting enzyme inhibitor, lisinopril, on morbidity and mortality in chronic heart failure. ATLAS Study Group. *Circulation*, 100, 2312-8.
- PAGE, E., COHEN-SOLAL, A., JONDEAU, G., DOUARD, H., ROUL, G., KANTELIP, J. P. & BUSSIÈRE, J. L. 1994. Comparison of treadmill and bicycle exercise in patients with chronic heart failure. *Chest*, 106, 1002-6.
- PAKARINEN, S. & TOIVONEN, L. 2013. Minimizing ventricular pacing by a novel atrioventricular (AV) delay hysteresis algorithm in patients with intact or compromised intrinsic AV conduction and different atrial and ventricular lead locations. *Ann Med*, 45, 438-45.
- PALMIERI, V., DAHLOF, B., DEQUATTRO, V., SHARPE, N., BELLA, J. N., DE SIMONE, G., PARANICAS, M., FISHMAN, D. & DEVEREUX, R. B. 1999. Reliability of echocardiographic assessment of left ventricular structure and function: the PRESERVE study. Prospective Randomized Study Evaluating Regression of Ventricular Enlargement. *J Am Coll Cardiol*, 34, 1625-32.
- PANDEY, A., GARG, S., KHUNGER, M., DARDEN, D., AYERS, C., KUMBHANI, D. J., MAYO, H. G., DE LEMOS, J. A. & BERRY, J. D. 2015. Dose-Response Relationship Between Physical Activity and Risk of Heart Failure: A Meta-Analysis. *Circulation*, 132, 1786-94.
- PARENT, A. 2004. Giovanni Aldini: from animal electricity to human brain stimulation. *Can J Neurol Sci*, 31, 576-84.
- PARENT, A. 2005. Duchenne De Boulogne: a pioneer in neurology and medical photography. *Can J Neurol Sci*, 32, 369-77.
- PARK, R. C., LITTLE, W. C. & O'ROURKE, R. A. 1985. Effect of alteration of left ventricular activation sequence on the left ventricular end-systolic pressure-volume relation in closed-chest dogs. *Circ Res*, 57, 706-17.
- PASIPOULARIDES, A. 2014. Galen, father of systematic medicine. An essay on the evolution of modern medicine and cardiology. *Int J Cardiol*, 172, 47-58.
- PEHRSSON, S. K., HJEMDAHL, P., NORDLANDER, R. & ASTROM, H. 1988. A comparison of sympathoadrenal activity and cardiac performance at rest and during exercise in patients with ventricular demand or atrial synchronous pacing. *Br Heart J*, 60, 212-20.
- PERRINS, E. J., MORLEY, C. A., CHAN, S. L. & SUTTON, R. 1983. Randomised controlled trial of physiological and ventricular pacing. *Br Heart J*, 50, 112-7.
- PFEFFER, M. A., BRAUNWALD, E., MOYE, L. A., BASTA, L., BROWN, E. J., JR., CUDDY, T. E., DAVIS, B. R., GELTMAN, E. M., GOLDMAN, S., FLAKER, G. C. & ET AL. 1992. Effect of captopril on mortality and morbidity in patients with left ventricular dysfunction after myocardial infarction. Results of the survival and ventricular enlargement trial. The SAVE Investigators. *N Engl J Med*, 327, 669-77.
- PIEPOLI, M., CLARK, A. L., VOLTERRANI, M., ADAMOPOULOS, S., SLEIGHT, P. & COATS, A. J. 1996. Contribution of muscle afferents to the hemodynamic, autonomic, and ventilatory responses to exercise in patients with chronic heart failure: effects of physical training. *Circulation*, 93, 940-52.
- PIEPOLI, M. F. & COATS, A. J. 2013. The 'skeletal muscle hypothesis in heart failure' revised. *Eur Heart J*, 34, 486-8.
- PIEPOLI, M. F., GUAZZI, M., BORIANI, G., CICOIRA, M., CORRA, U., DALLA LIBERA, L., EMDIN, M., MELE, D., PASSINO, C., VESCOVO, G., VIGORITO, C., VILLANI, G. Q. & AGOSTONI, P. 2010. Exercise intolerance in chronic heart failure: mechanisms and therapies. Part I. *Eur J Cardiovasc Prev Rehabil*, 17, 637-42.
- PINSKY, D. J., AHERN, D., WILSON, P. B., KUKIN, M. L. & PACKER, M. 1990. How Many Exercise Tests Are Needed to Minimize The Placebo Effect of

- Serial Testing In Patients with Chronic Heart Failure? *Journal of Cardiopulmonary Rehabilitation and Prevention*, 10, 108.
- PIOGER, G., LENY, G., NITZSCHE, R. & RIPART, A. 2007. AAsafeR limits ventricular pacing in unselected patients. *Pacing Clin Electrophysiol*, 30 Suppl 1, S66-70.
- PITT, B., REMME, W., ZANNAD, F., NEATON, J., MARTINEZ, F., RONIKER, B., BITTMAN, R., HURLEY, S., KLEIMAN, J. & GATLIN, M. 2003. Eplerenone, a selective aldosterone blocker, in patients with left ventricular dysfunction after myocardial infarction. *N Engl J Med*, 348, 1309-21.
- PITT, B., ZANNAD, F., REMME, W. J., CODY, R., CASTAIGNE, A., PEREZ, A., PALENSKY, J. & WITTES, J. 1999. The effect of spironolactone on morbidity and mortality in patients with severe heart failure. Randomized Aldactone Evaluation Study Investigators. *N Engl J Med*, 341, 709-17.
- PONIKOWSKI, P., VOORS, A. A., ANKER, S. D., BUENO, H., CLELAND, J. G., COATS, A. J., FALK, V., GONZALEZ-JUANATEY, J. R., HARJOLA, V. P., JANKOWSKA, E. A., JESSUP, M., LINDE, C., NIHOYANNOPOULOS, P., PARISSIS, J. T., PIESKE, B., RILEY, J. P., ROSANO, G. M., RUILOPE, L. M., RUSCHITZKA, F., RUTTEN, F. H. & VAN DER MEER, P. 2016. 2016 ESC Guidelines for the diagnosis and treatment of acute and chronic heart failure: The Task Force for the diagnosis and treatment of acute and chronic heart failure of the European Society of Cardiology (ESC). Developed with the special contribution of the Heart Failure Association (HFA) of the ESC. *Eur J Heart Fail*.
- POOLE-WILSON, P. A., CLELAND, J. G., DI LENARDA, A., HANRATH, P., KOMAJDA, M., METRA, M., W, J. R., SWEDBERG, K. & TORP-PEDERSEN, C. 2002. Rationale and design of the carvedilol or metoprolol European trial in patients with chronic heart failure: COMET. *Eur J Heart Fail*, 4, 321-9.
- POOLE-WILSON, P. A., SWEDBERG, K., CLELAND, J. G., DI LENARDA, A., HANRATH, P., KOMAJDA, M., LUBSEN, J., LUTIGER, B., METRA, M., REMME, W. J., TORP-PEDERSEN, C., SCHERHAG, A. & SKENE, A. 2003a. Comparison of carvedilol and metoprolol on clinical outcomes in patients with chronic heart failure in the Carvedilol Or Metoprolol European Trial (COMET): randomised controlled trial. *Lancet*, 362, 7-13.
- POOLE-WILSON, P. A., URETSKY, B. F., THYGESEN, K., CLELAND, J. G., MASSIE, B. M. & RYDEN, L. 2003b. Mode of death in heart failure: findings from the ATLAS trial. *Heart*, 89, 42-8.
- POOLE, J. E., GLEVA, M. J., MELA, T., CHUNG, M. K., USLAN, D. Z., BORGE, R., GOTTIPATY, V., SHINN, T., DAN, D., FELDMAN, L. A., SEIDE, H., WINSTON, S. A., GALLAGHER, J. J., LANGBERG, J. J., MITCHELL, K. & HOLCOMB, R. 2010. Complication rates associated with pacemaker or implantable cardioverter-defibrillator generator replacements and upgrade procedures: results from the REPLACE registry. *Circulation*, 122, 1553-61.
- PRINZEN, F. W., HUNTER, W. C., WYMAN, B. T. & MCVEIGH, E. R. 1999. Mapping of regional myocardial strain and work during ventricular pacing: experimental study using magnetic resonance imaging tagging. *J Am Coll Cardiol*, 33, 1735-42.
- PRINZEN, F. W. & PESCHAR, M. 2002. Relation between the pacing induced sequence of activation and left ventricular pump function in animals. *Pacing Clin Electrophysiol*, 25, 484-98.
- PRIORI, S. G., BLOMSTROM-LUNDQVIST, C., MAZZANTI, A., BLOM, N., BORGGREFE, M., CAMM, J., ELLIOTT, P. M., FITZSIMONS, D., HATALA, R., HINDRICKS, G., KIRCHHOF, P., KJELDSEN, K., KUCK, K. H., HERNANDEZ-MADRID, A., NIKOLAOU, N., NOREKVAL, T. M., SPAULDING, C. & VAN VELDHUISEN, D. J. 2015. 2015 ESC Guidelines for the management of patients with ventricular arrhythmias and the

- prevention of sudden cardiac death: The Task Force for the Management of Patients with Ventricular Arrhythmias and the Prevention of Sudden Cardiac Death of the European Society of Cardiology (ESC). Endorsed by: Association for European Paediatric and Congenital Cardiology (AEPC). *Eur Heart J*, 36, 2793-867.
- PURERFELLNER, H., BRANDT, J., ISRAEL, C., SHELDON, T., JOHNSON, J., TSCHELIESSNIGG, K., SPERZEL, J., BORIANI, G., PUGLISI, A. & MILASINOVIC, G. 2008. Comparison of two strategies to reduce ventricular pacing in pacemaker patients. *Pacing Clin Electrophysiol*, 31, 167-76.
- RAATIKAINEN, M. J., ARNAR, D. O., ZEPPENFELD, K., MERINO, J. L., LEVYA, F., HINDRIKS, G. & KUCK, K. H. 2015. Statistics on the use of cardiac electronic devices and electrophysiological procedures in the European Society of Cardiology countries: 2014 report from the European Heart Rhythm Association. *Europace*, 17 Suppl 1, i1-75.
- RAMANATHAN, C., GHANEM, R. N., JIA, P., RYU, K. & RUDY, Y. 2004. Noninvasive electrocardiographic imaging for cardiac electrophysiology and arrhythmia. *Nat Med*, 10, 422-8.
- RAPHAEL, C. E., FINEGOLD, J. A., BARRON, A. J., WHINNETT, Z. I., MAYET, J., LINDE, C., CLELAND, J. G., LEVY, W. C. & FRANCIS, D. P. 2015. The effect of duration of follow-up and presence of competing risk on lifespan-gain from implantable cardioverter defibrillator therapy: who benefits the most? *Eur Heart J*, 36, 1676-88.
- RATHORE, S. S., WANG, Y. & KRUMHOLZ, H. M. 2002. Sex-based differences in the effect of digoxin for the treatment of heart failure. *N Engl J Med*, 347, 1403-11.
- REDFIELD, M. M., JACOBSEN, S. J., BURNETT, J. C., JR., MAHONEY, D. W., BAILEY, K. R. & RODEHEFFER, R. J. 2003. Burden of systolic and diastolic ventricular dysfunction in the community: appreciating the scope of the heart failure epidemic. *Jama*, 289, 194-202.
- REDIKER, D. E., EAGLE, K. A., HOMMA, S., GILLAM, L. D. & HARTHORNE, J. W. 1988. Clinical and hemodynamic comparison of VVI versus DDD pacing in patients with DDD pacemakers. *Am J Cardiol*, 61, 323-9.
- RELEVO, R. 2012. *Effective Search Strategies for Systematic Reviews of Medical Tests*, Rockville (MD), Agency for Healthcare Research and Quality (US).
- REY, J. L., QUENUM, S. & HERO, M. 2012. Effect of a pacing mode preserving spontaneous AV conduction on ventricular pacing burden and atrial arrhythmias. *Pacing Clin Electrophysiol*, 35, 580-5.
- RIAHI, S., NIELSEN, J. C., HJORTSHOJ, S., THOMSEN, P. E., HOJBERG, S., MOLLER, M., DALSGAARD, D., NIELSEN, T., ASKLUND, M., FRIIS, E. V., CHRISTENSEN, P. D., SIMONSEN, E. H., ERIKSEN, U. H., JENSEN, G. V., SVENDSEN, J. H., TOFF, W. D., HEALEY, J. S. & ANDERSEN, H. R. 2012. Heart failure in patients with sick sinus syndrome treated with single lead atrial or dual-chamber pacing: no association with pacing mode or right ventricular pacing site. *Europace*, 14, 1475-82.
- RIBATTI, D. 2009. William Harvey and the discovery of the circulation of the blood. *J Angiogenes Res*, 1, 3.
- RINGER, S. 1883. A further Contribution regarding the influence of the different Constituents of the Blood on the Contraction of the Heart. *J Physiol*, 4, 29-42.3.
- ROBERTS, E., LUDMAN, A. J., DWORZYNSKI, K., AL-MOHAMMAD, A., COWIE, M. R., MCMURRAY, J. J. & MANT, J. 2015. The diagnostic accuracy of the natriuretic peptides in heart failure: systematic review and diagnostic meta-analysis in the acute care setting. *Bmj*, 350, h910.
- RODRIGUEZ, L. M., TIMMERMANS, C., NABAR, A., BEATTY, G. & WELLENS, H. J. 2003. Variable patterns of septal activation in patients with left bundle branch block and heart failure. *J Cardiovasc Electrophysiol*, 14, 135-41.

- ROSEN, B. D., FERNANDES, V. R., NASIR, K., HELLE-VALLE, T., JEROSCH-HEROLD, M., BLUEMKE, D. A. & LIMA, J. A. 2009. Age, increased left ventricular mass, and lower regional myocardial perfusion are related to greater extent of myocardial dyssynchrony in asymptomatic individuals: the multi-ethnic study of atherosclerosis. *Circulation*, 120, 859-66.
- ROSENQVIST, M., BRANDT, J. & SCHULLER, H. 1986. Atrial versus ventricular pacing in sinus node disease: a treatment comparison study. *Am Heart J*, 111, 292-7.
- ROSENQVIST, M., BRANDT, J. & SCHULLER, H. 1988. Long-term pacing in sinus node disease: effects of stimulation mode on cardiovascular morbidity and mortality. *Am Heart J*, 116, 16-22.
- ROSSO, R., MEDI, C., TEH, A. W., HUNG, T. T., FELDMAN, A., LEE, G. & MOND, H. G. 2010. Right ventricular septal pacing: a comparative study of outflow tract and mid ventricular sites. *Pacing Clin Electrophysiol*, 33, 1169-73.
- RUSCHITZKA, F., ABRAHAM, W. T., SINGH, J. P., BAX, J. J., BORER, J. S., BRUGADA, J., DICKSTEIN, K., FORD, I., GORCSAN, J., 3RD, GRAS, D., KRUM, H., SOGAARD, P. & HOLZMEISTER, J. 2013. Cardiac-resynchronization therapy in heart failure with a narrow QRS complex. *N Engl J Med*, 369, 1395-405.
- RUSSELL, K., OPDAHL, A., REMME, E. W., GJESDAL, O., SKULSTAD, H., KONGSGAARD, E., EDVARDBSEN, T. & SMISETH, O. A. 2010. Evaluation of left ventricular dyssynchrony by onset of active myocardial force generation: a novel method that differentiates between electrical and mechanical etiologies. *Circ Cardiovasc Imaging*, 3, 405-14.
- RUSSELL, K., SMISETH, O. A., GJESDAL, O., QVIGSTAD, E., NORSENG, P. A., SJAASTAD, I., OPDAHL, A., SKULSTAD, H., EDVARDBSEN, T. & REMME, E. W. 2011. Mechanism of prolonged electromechanical delay in late activated myocardium during left bundle branch block. *Am J Physiol Heart Circ Physiol*, 301, H2334-43.
- RUSSO, C., JAUBERT, M. P., JIN, Z., HOMMA, S. & DI TULLIO, M. R. 2012. Intra- and interobserver reproducibility of left ventricular mechanical dyssynchrony assessment by real time three-dimensional echocardiography. *Echocardiography*, 29, 598-607.
- SABA, S., MAREK, J., SCHWARTZMAN, D., JAIN, S., ADELSTEIN, E., WHITE, P., OYENUGA, O. A., ONISHI, T., SOMAN, P. & GORCSAN, J., 3RD 2013. Echocardiography-guided left ventricular lead placement for cardiac resynchronization therapy: results of the Speckle Tracking Assisted Resynchronization Therapy for Electrode Region trial. *Circ Heart Fail*, 6, 427-34.
- SANDERS, G. D., HLATKY, M. A. & OWENS, D. K. 2005. Cost-effectiveness of implantable cardioverter-defibrillators. *N Engl J Med*, 353, 1471-80.
- SAVOURE, A., FROHLIG, G., GALLEY, D., DEFAYE, P., REUTER, S., MABO, P., SADOUL, N., AMBLARD, A., LIMOUSIN, M. & ANSELME, F. 2005. A new dual-chamber pacing mode to minimize ventricular pacing. *Pacing Clin Electrophysiol*, 28 Suppl 1, S43-6.
- SCHUNKERT, H., KONIG, I. R., KATHIRESAN, S., REILLY, M. P., ASSIMES, T. L., HOLM, H., PREUSS, M., STEWART, A. F., BARBALIC, M., GIEGER, C., ABSHER, D., AHERRAHROU, Z., ALLAYEE, H., ALTSHULER, D., ANAND, S. S., ANDERSEN, K., ANDERSON, J. L., ARDISSINO, D., BALL, S. G., BALMFORTH, A. J., BARNES, T. A., BECKER, D. M., BECKER, L. C., BERGER, K., BIS, J. C., BOEKHOLDT, S. M., BOERWINKLE, E., BRAUND, P. S., BROWN, M. J., BURNETT, M. S., BUYSSCHAERT, I., CARLQUIST, J. F., CHEN, L., CICHON, S., CODD, V., DAVIES, R. W., DEDOUSSIS, G., DEHGHAN, A., DEMISSIE, S., DEVANEY, J. M., DIEMERT, P., DO, R., DOERING, A., EIFERT, S., MOKHTARI, N. E., ELLIS, S. G., ELOSUA, R., ENGERT, J. C., EPSTEIN, S. E., DE FAIRE, U.,

- FISCHER, M., FOLSOM, A. R., FREYER, J., GIGANTE, B., GIRELLI, D., GRETARSDOTTIR, S., GUDNASON, V., GULCHER, J. R., HALPERIN, E., HAMMOND, N., HAZEN, S. L., HOFMAN, A., HORNE, B. D., ILLIG, T., IRIBARREN, C., JONES, G. T., JUKEMA, J. W., KAISER, M. A., KAPLAN, L. M., KASTELEIN, J. J., KHAW, K. T., KNOWLES, J. W., KOLOVOU, G., KONG, A., LAAKSONEN, R., LAMBRECHTS, D., LEANDER, K., LETTRE, G., LI, M., LIEB, W., LOLEY, C., LOTERY, A. J., MANNUCCI, P. M., MAOUCHE, S., MARTINELLI, N., MCKEOWN, P. P., MEISINGER, C., MEITINGER, T., MELANDER, O., MERLINI, P. A., MOOSER, V., MORGAN, T., MUHLEISEN, T. W., MUHLESTEIN, J. B., MUNZEL, T., MUSUNURU, K., NAHRSTAEDT, J., NELSON, C. P., NOTHEN, M. M., OLIVIERI, O., et al. 2011. Large-scale association analysis identifies 13 new susceptibility loci for coronary artery disease. *Nat Genet*, 43, 333-8.
- SCHUSTER, I., HABIB, G., JEGO, C., THUNY, F., AVIERINOS, J. F., DERUMEAUX, G., BECK, L., MEDAIL, C., FRANCESCHI, F., RENARD, S., FERRACCI, A., LEFEVRE, J., LUCCIONI, R., DEHARO, J. C. & DJIANE, P. 2005. Diastolic asynchrony is more frequent than systolic asynchrony in dilated cardiomyopathy and is less improved by cardiac resynchronization therapy. *J Am Coll Cardiol*, 46, 2250-7.
- SCHWAAB, B., FROHLIG, G., ALEXANDER, C., KINDERMANN, M., HELLWIG, N., SCHWERDT, H., KIRSCH, C. M. & SCHIEFFER, H. 1999. Influence of right ventricular stimulation site on left ventricular function in atrial synchronous ventricular pacing. *J Am Coll Cardiol*, 33, 317-23.
- SCIARRETTA, S., PALANO, F., TOCCI, G., BALDINI, R. & VOLPE, M. 2011. Antihypertensive treatment and development of heart failure in hypertension: a Bayesian network meta-analysis of studies in patients with hypertension and high cardiovascular risk. *Arch Intern Med*, 171, 384-94.
- SCIRICA, B. M., MORROW, D. A., CANNON, C. P., RAY, K. K., SABATINE, M. S., JAROLIM, P., SHUI, A., MCCABE, C. H. & BRAUNWALD, E. 2006. Intensive statin therapy and the risk of hospitalization for heart failure after an acute coronary syndrome in the PROVE IT-TIMI 22 study. *J Am Coll Cardiol*, 47, 2326-31.
- SHAMIM, W., FRANCIS, D. P., YOUSUFUDDIN, M., VARNEY, S., PIEOPLI, M. F., ANKER, S. D. & COATS, A. J. 1999. Intraventricular conduction delay: a prognostic marker in chronic heart failure. *Int J Cardiol*, 70, 171-8.
- SHARMA, A. D., RIZO-PATRON, C., HALLSTROM, A. P., O'NEILL, G. P., ROTHBART, S., MARTINS, J. B., ROELKE, M., STEINBERG, J. S. & GREENE, H. L. 2005. Percent right ventricular pacing predicts outcomes in the DAVID trial. *Heart Rhythm*, 2, 830-4.
- SHAW, D. B., KEKWICK, C. A., VEALE, D., GOWERS, J. & WHISTANCE, T. 1985. Survival in second degree atrioventricular block. *Br Heart J*, 53, 587-93.
- SHEN, W. K., HAMMILL, S. C., HAYES, D. L., PACKER, D. L., BAILEY, K. R., BALLARD, D. J. & GERSH, B. J. 1994. Long-term survival after pacemaker implantation for heart block in patients > or = 65 years. *Am J Cardiol*, 74, 560-4.
- SHEN, W. K., HAYES, D. L., HAMMILL, S. C., BAILEY, K. R., BALLARD, D. J. & GERSH, B. J. 1996. Survival and functional independence after implantation of a permanent pacemaker in octogenarians and nonagenarians. A population-based study. *Annals of Internal Medicine*, 125, 476-80.
- SHIMANO, M., TSUJI, Y., YOSHIDA, Y., INDEN, Y., TSUBOI, N., ITOH, T., SUZUKI, H., MURAMATSU, T., OKADA, T., HARATA, S., YAMADA, T., HIRAYAMA, H., NATTEL, S. & MUROHARA, T. 2007. Acute and chronic effects of cardiac resynchronization in patients developing heart failure with long-term pacemaker therapy for acquired complete atrioventricular block. *Europace*, 9, 869-74.

- SHIMIZU, M., MYERS, J., BUCHANAN, N., WALSH, D., KRAEMER, M., MCAULEY, P. & FROELICHER, V. F. 1991. The ventilatory threshold: method, protocol, and evaluator agreement. *Am Heart J*, 122, 509-16.
- SHIMONY, A., EISENBERG, M. J., FILION, K. B. & AMIT, G. 2012. Beneficial effects of right ventricular non-apical vs. apical pacing: a systematic review and meta-analysis of randomized-controlled trials. *Europace*, 14, 81-91.
- SHUKLA, H. H., HELLKAMP, A. S., JAMES, E. A., FLAKER, G. C., LEE, K. L., SWEENEY, M. O. & LAMAS, G. A. 2005. Heart failure hospitalization is more common in pacemaker patients with sinus node dysfunction and a prolonged paced QRS duration. *Heart Rhythm*, 2, 245-51.
- SILVERMAN, M. E. & FYE, W. B. 2006. John A. MacWilliam: Scottish pioneer of cardiac electrophysiology. *Clin Cardiol*, 29, 90-2.
- SIMS, D. B., MIGNATTI, A., COLOMBO, P. C., URIEL, N., GARCIA, L. I., EHLERT, F. A. & JORDE, U. P. 2011. Rate responsive pacing using cardiac resynchronization therapy in patients with chronotropic incompetence and chronic heart failure. *Europace*, 13, 1459-63.
- SINGH, J. P., KLEIN, H. U., HUANG, D. T., REEK, S., KUNISS, M., QUESADA, A., BARSHESET, A., CANNOM, D., GOLDENBERG, I., MCNITT, S., DAUBERT, J. P., ZAREBA, W. & MOSS, A. J. 2011. Left ventricular lead position and clinical outcome in the multicenter automatic defibrillator implantation trial-cardiac resynchronization therapy (MADIT-CRT) trial. *Circulation*, 123, 1159-66.
- SLATTON, M. L., IRANI, W. N., HALL, S. A., MARCOUX, L. G., PAGE, R. L., GRAYBURN, P. A. & EICHHORN, E. J. 1997. Does digoxin provide additional hemodynamic and autonomic benefit at higher doses in patients with mild to moderate heart failure and normal sinus rhythm? *J Am Coll Cardiol*, 29, 1206-13.
- SOHAIB, S. M., FINEGOLD, J. A., NIJGER, S. S., HOSSAIN, R., LINDE, C., LEVY, W. C., SUTTON, R., KANAGARATNAM, P., FRANCIS, D. P. & WHINNETT, Z. I. 2015. Opportunity to increase life span in narrow QRS cardiac resynchronization therapy recipients by deactivating ventricular pacing: evidence from randomized controlled trials. *JACC Heart Fail*, 3, 327-36.
- SOLER-SOLER, J. & PERMANYER-MIRALDA, G. 1994. How do changes in lifestyle complement medical treatment in heart failure? *Br Heart J*, 72, S87-91.
- SOLIS, J., MCCARTY, D., LEVINE, R. A., HANDSCHUMACHER, M. D., FERNANDEZ-FRIERA, L., CHEN-TOURNOUX, A., MONT, L., VIDAL, B., SINGH, J. P., BRUGADA, J., PICARD, M. H., SITGES, M. & HUNG, J. 2009. Mechanism of decrease in mitral regurgitation after cardiac resynchronization therapy: optimization of the force-balance relationship. *Circ Cardiovasc Imaging*, 2, 444-50.
- SPANN, J. F., BUCCINO, R. A., SONNENBLICK, E. H. & BRAUNWALD, E. 1967. Contractile state of cardiac muscle obtained from cats with experimentally produced ventricular hypertrophy and heart failure. *Circulation Research*, 21, 341-354.
- SPRAGG, D. D. & KASS, D. A. 2006. Pathobiology of left ventricular dyssynchrony and resynchronization. *Prog Cardiovasc Dis*, 49, 26-41.
- STAMBLER, B. S., ELLENBOGEN, K., ZHANG, X., PORTER, T. R., XIE, F., MALIK, R., SMALL, R., BURKE, M., KAPLAN, A., NAIR, L., BELZ, M., FUENZALIDA, C., GOLD, M., LOVE, C., SHARMA, A., SILVERMAN, R., SOGADE, F., VAN NATTA, B., WILKOFF, B. L. & INVESTIGATORS, R. 2003. Right ventricular outflow versus apical pacing in pacemaker patients with congestive heart failure and atrial fibrillation. *Journal of Cardiovascular Electrophysiology*, 14, 1180-6.
- STEINBECK, G., ANDRESEN, D., SEIDL, K., BRACHMANN, J., HOFFMANN, E., WOJCIECHOWSKI, D., KORNACEWICZ-JACH, Z., SREDNIWA, B.,

- LUPKOVICS, G., HOFGARTNER, F., LUBINSKI, A., ROSENQVIST, M., HABETS, A., WEGSCHEIDER, K. & SENEGES, J. 2009. Defibrillator implantation early after myocardial infarction. *N Engl J Med*, 361, 1427-36.
- STEINBERG, B. A., AL-KHATIB, S. M., EDWARDS, R., HAN, J., BARDY, G. H., BIGGER, J. T., BUXTON, A. E., MOSS, A. J., LEE, K. L., STEINMAN, R., DORIAN, P., HALLSTROM, A., CAPPATO, R., KADISH, A. H., KUDENCHUK, P. J., MARK, D. B., INOUE, L. Y. & SANDERS, G. D. 2014. Outcomes of implantable cardioverter-defibrillator use in patients with comorbidities: results from a combined analysis of 4 randomized clinical trials. *JACC Heart Fail*, 2, 623-9.
- STEINBERG, J. S., FISCHER, A., WANG, P., SCHUGER, C., DAUBERT, J., MCNITT, S., ANDREWS, M., BROWN, M., HALL, W. J., ZAREBA, W. & MOSS, A. J. 2005. The clinical implications of cumulative right ventricular pacing in the multicenter automatic defibrillator trial II. *J Cardiovasc Electrophysiol*, 16, 359-65.
- STEINHAUS, D. 2008. Fifty years of pacemaker advancements. *J Cardiovasc Transl Res*, 1, 252-3.
- STELKEN, A. M., YOUNIS, L. T., JENNISON, S. H., MILLER, D. D., MILLER, L. W., SHAW, L. J., KARGL, D. & CHAITMAN, B. R. 1996. Prognostic value of cardiopulmonary exercise testing using percent achieved of predicted peak oxygen uptake for patients with ischemic and dilated cardiomyopathy. *J Am Coll Cardiol*, 27, 345-52.
- STEVENSON, L. W., STEIMLE, A. E., FONAROW, G., KERMANI, M., KERMANI, D., HAMILTON, M. A., MORIGUCHI, J. D., WALDEN, J., TILLISCH, J. H., DRINKWATER, D. C. & ET AL. 1995. Improvement in exercise capacity of candidates awaiting heart transplantation. *J Am Coll Cardiol*, 25, 163-70.
- STEWART, G. C., WEINTRAUB, J. R., PRATIBHU, P. P., SEMIGRAN, M. J., CAMUSO, J. M., BROOKS, K., TSANG, S. W., ANELLO, M. S., NGUYEN, V. T., LEWIS, E. F., NOHRIA, A., DESAI, A. S., GIVERTZ, M. M. & STEVENSON, L. W. 2010. Patient expectations from implantable defibrillators to prevent death in heart failure. *J Card Fail*, 16, 106-13.
- STEWART, S., MACINTYRE, K., HOLE, D. J., CAPEWELL, S. & MCMURRAY, J. J. 2001a. More 'malignant' than cancer? Five-year survival following a first admission for heart failure. *Eur J Heart Fail*, 3, 315-22.
- STEWART, S., MACINTYRE, K., MACLEOD, M. M., BAILEY, A. E., CAPEWELL, S. & MCMURRAY, J. J. 2001b. Trends in hospitalization for heart failure in Scotland, 1990-1996. An epidemic that has reached its peak? *Eur Heart J*, 22, 209-17.
- STUART, R. J., JR. & ELLESTAD, M. H. 1980. National survey of exercise stress testing facilities. *Chest*, 77, 94-7.
- SULKE, N., CHAMBERS, J., DRITSAS, A. & SOWTON, E. 1991. A randomized double-blind crossover comparison of four rate-responsive pacing modes. *J Am Coll Cardiol*, 17, 696-706.
- SUN, X. G., HANSEN, J. E., GARATACHEA, N., STORER, T. W. & WASSERMAN, K. 2002. Ventilatory efficiency during exercise in healthy subjects. *Am J Respir Crit Care Med*, 166, 1443-8.
- SUNG, R. K. & FOSTER, E. 2011. Assessment of systolic dyssynchrony for cardiac resynchronization therapy is not clinically useful. *Circulation*, 123, 656-62.
- SUSKIN, N., SHETH, T., NEGASSA, A. & YUSUF, S. 2001. Relationship of current and past smoking to mortality and morbidity in patients with left ventricular dysfunction. *J Am Coll Cardiol*, 37, 1677-82.
- SUTTON, M. G., PLAPPERT, T., HILPISCH, K. E., ABRAHAM, W. T., HAYES, D. L. & CHINCHOY, E. 2006. Sustained reverse left ventricular structural remodeling with cardiac resynchronization at one year is a function of etiology: quantitative Doppler echocardiographic evidence from the

- Multicenter InSync Randomized Clinical Evaluation (MIRACLE). *Circulation*, 113, 266-72.
- SUWA, M., ITO, T., OTAKE, Y., KOBASHI, A., HIROTA, Y. & KAWAMURA, K. 1998. Effect of beta-blocker treatment in dilated cardiomyopathy with bradyarrhythmias. *Jpn Circ J*, 62, 765-9.
- SWEDBERG, K., KOMAJDA, M., BOHM, M., BORER, J. S., FORD, I., DUBOST-BRAMA, A., LEREBOURS, G. & TAVAZZI, L. 2010. Ivabradine and outcomes in chronic heart failure (SHIFT): a randomised placebo-controlled study. *Lancet*, 376, 875-85.
- SWEENEY, M. O., BANK, A. J., NSAH, E., KOULLICK, M., ZENG, Q. C., HETRICK, D., SHELDON, T. & LAMAS, G. A. 2007. Minimizing ventricular pacing to reduce atrial fibrillation in sinus-node disease. *N Engl J Med*, 357, 1000-8.
- SWEENEY, M. O., ELLENBOGEN, K. A., CASAVANT, D., BETZOLD, R., SHELDON, T., TANG, F., MUELLER, M. & LINGLE, J. 2005. Multicenter, prospective, randomized safety and efficacy study of a new atrial-based managed ventricular pacing mode (MVP) in dual chamber ICDs. *J Cardiovasc Electrophysiol*, 16, 811-7.
- SWEENEY, M. O., HELLKAMP, A. S., ELLENBOGEN, K. A., GREENSPON, A. J., FREEDMAN, R. A., LEE, K. L. & LAMAS, G. A. 2003. Adverse effect of ventricular pacing on heart failure and atrial fibrillation among patients with normal baseline QRS duration in a clinical trial of pacemaker therapy for sinus node dysfunction. *Circulation*, 107, 2932-7.
- SWEENEY, M. O., HELLKAMP, A. S., ELLENBOGEN, K. A. & LAMAS, G. A. 2008. Reduced ejection fraction, sudden cardiac death, and heart failure death in the mode selection trial (MOST): implications for device selection in elderly patients with sinus node disease. *J Cardiovasc Electrophysiol*, 19, 1160-6.
- SWEENEY, M. O. & PRINZEN, F. W. 2006. A new paradigm for physiologic ventricular pacing. *J Am Coll Cardiol*, 47, 282-8.
- SWEENEY, M. O., SHEA, J. B., FOX, V., ADLER, S., NELSON, L., MULLEN, T. J., BELK, P., CASAVANT, D. & SHELDON, T. 2004. Randomized pilot study of a new atrial-based minimal ventricular pacing mode in dual-chamber implantable cardioverter-defibrillators. *Heart Rhythm*, 1, 160-7.
- TANAKA, H., NESSER, H. J., BUCK, T., OYENUGA, O., JANOSI, R. A., WINTER, S., SABA, S. & GORCSAN, J., 3RD 2010. Dyssynchrony by speckle-tracking echocardiography and response to cardiac resynchronization therapy: results of the Speckle Tracking and Resynchronization (STAR) study. *Eur Heart J*, 31, 1690-700.
- TANG, A. S., WELLS, G. A., TALAJIC, M., ARNOLD, M. O., SHELDON, R., CONNOLLY, S., HOHNLOSER, S. H., NICHOL, G., BIRNIE, D. H., SAPP, J. L., YEE, R., HEALEY, J. S. & ROULEAU, J. L. 2010. Cardiac-resynchronization therapy for mild-to-moderate heart failure. *N Engl J Med*, 363, 2385-95.
- THACKRAY, S. D., WITTE, K. K., NIKITIN, N. P., CLARK, A. L., KAYE, G. C. & CLELAND, J. G. 2003. The prevalence of heart failure and asymptomatic left ventricular systolic dysfunction in a typical regional pacemaker population. *Eur Heart J*, 24, 1143-52.
- THAMBO, J. B., BORDACHAR, P., GARRIGUE, S., LAFITTE, S., SANDERS, P., REUTER, S., GIRARDOT, R., CREPIN, D., REANT, P., ROUDAUT, R., JAIS, P., HAISSAGUERRE, M., CLEMENTY, J. & JIMENEZ, M. 2004. Detrimental ventricular remodeling in patients with congenital complete heart block and chronic right ventricular apical pacing. *Circulation*, 110, 3766-72.
- THEBAULT, C., DONAL, E., MEUNIER, C., GERVAIS, R., GERRITSE, B., GOLD, M. R., ABRAHAM, W. T., LINDE, C. & DAUBERT, J. C. 2012. Sites of left and right ventricular lead implantation and response to cardiac

- resynchronization therapy observations from the REVERSE trial. *Eur Heart J*, 33, 2662-71.
- THEUNS, D. A., SMITH, T., HUNINK, M. G., BARDY, G. H. & JORDAENS, L. 2010. Effectiveness of prophylactic implantation of cardioverter-defibrillators without cardiac resynchronization therapy in patients with ischaemic or non-ischaemic heart disease: a systematic review and meta-analysis. *Europace*, 12, 1564-70.
- THIBAUT, B., HAREL, F., DUCHARME, A., WHITE, M., ELLENBOGEN, K. A., FRASURE-SMITH, N., ROY, D., PHILIPPON, F., DORIAN, P., TALAJIC, M., DUBUC, M., GUERRA, P. G., MACLE, L., RIVARD, L., ANDRADE, J. & KHAIRY, P. 2013. Cardiac resynchronization therapy in patients with heart failure and a QRS complex <120 milliseconds: the Evaluation of Resynchronization Therapy for Heart Failure (LESSER-EARTH) trial. *Circulation*, 127, 873-81.
- THIBAUT, B., SIMPSON, C., GAGNE, C. E., BLIER, L., SENARATNE, M., MCNICOLL, S., STUGLIN, C., WILLIAMS, R., PINTER, A., KHAYKIN, Y. & NITZSCHE, R. 2009. Impact of AV conduction disorders on SafeR mode performance. *Pacing Clin Electrophysiol*, 32 Suppl 1, S231-5.
- TOFF, W. D., CAMM, A. J. & SKEHAN, J. D. 2005. Single-chamber versus dual-chamber pacing for high-grade atrioventricular block. *N Engl J Med*, 353, 145-55.
- TOFF, W. D., SKEHAN, J. D., DE BONO, D. P. & CAMM, A. J. 1997. The United Kingdom pacing and cardiovascular events (UKPACE) trial. United Kingdom Pacing and Cardiovascular Events. *Heart*, 78, 221-3.
- TOPS, L. F., SCHALIJ, M. J. & BAX, J. J. 2009. The effects of right ventricular apical pacing on ventricular function and dyssynchrony implications for therapy. *Journal of the American College of Cardiology*, 54, 764-76.
- TOPS, L. F., SCHALIJ, M. J., HOLMAN, E. R., VAN ERVEN, L., VAN DER WALL, E. E. & BAX, J. J. 2006. Right ventricular pacing can induce ventricular dyssynchrony in patients with atrial fibrillation after atrioventricular node ablation. *Journal of the American College of Cardiology*, 48, 1642-8.
- TOPS, L. F., SUFFOLETTO, M. S., BLEEKER, G. B., BOERSMA, E., VAN DER WALL, E. E., GORCSAN, J., 3RD, SCHALIJ, M. J. & BAX, J. J. 2007. Speckle-tracking radial strain reveals left ventricular dyssynchrony in patients with permanent right ventricular pacing. *J Am Coll Cardiol*, 50, 1180-8.
- TORP-PEDERSEN, C., METRA, M., SPARK, P., LUKAS, M. A., MOULLET, C., SCHERHAG, A., KOMAJDA, M., CLELAND, J. G., REMME, W., DI LENARDA, A., SWEDBERG, K. & POOLE-WILSON, P. A. 2007. The safety of amiodarone in patients with heart failure. *J Card Fail*, 13, 340-5.
- TRAPPE, H. J., KLEIN, H., FRANK, G. & LICHTLEN, P. R. 1988. Rate-responsive pacing as compared to fixed-rate VVI pacing in patients after ablation of the atrioventricular conduction system. *Eur Heart J*, 9, 642-8.
- TRAVILL, C. M., WILLIAMS, T. D., PATE, P., SONG, G., CHALMERS, J., LIGHTMAN, S. L., SUTTON, R. & NOBLE, M. I. 1992. Haemodynamic and neurohumoral response in heart failure produced by rapid ventricular pacing. *Cardiovasc Res*, 26, 783-90.
- TSE, H. F. & LAU, C. P. 1997. Long-term effect of right ventricular pacing on myocardial perfusion and function. *J Am Coll Cardiol*, 29, 744-9.
- TSE, H. F., SIU, C. W., LEE, K. L., FAN, K., CHAN, H. W., TANG, M. O., TSANG, V., LEE, S. W. & LAU, C. P. 2005. The incremental benefit of rate-adaptive pacing on exercise performance during cardiac resynchronization therapy. *J Am Coll Cardiol*, 46, 2292-7.
- TSE, H. F., YU, C., WONG, K. K., TSANG, V., LEUNG, Y. L., HO, W. Y. & LAU, C. P. 2002. Functional abnormalities in patients with permanent right

- ventricular pacing: the effect of sites of electrical stimulation. *J Am Coll Cardiol*, 40, 1451-8.
- UKKONEN, H., BEANLANDS, R. S., BURWASH, I. G., DE KEMP, R. A., NAHMIAS, C., FALLEN, E., HILL, M. R. & TANG, A. S. 2003. Effect of cardiac resynchronization on myocardial efficiency and regional oxidative metabolism. *Circulation*, 107, 28-31.
- VALLS-BERTAULT, V., FATEMI, M., GILARD, M., PENNEC, P. Y., ETIENNE, Y. & BLANC, J. J. 2004. Assessment of upgrading to biventricular pacing in patients with right ventricular pacing and congestive heart failure after atrioventricular junctional ablation for chronic atrial fibrillation. *Europace*, 6, 438-43.
- VAMOS, M., ERATH, J. W. & HOHNLOSER, S. H. 2015. Digoxin-associated mortality: a systematic review and meta-analysis of the literature. *Eur Heart J*, 36, 1831-8.
- VAN BOMMEL, R. J., MARSAN, N. A., DELGADO, V., BORLEFFS, C. J., VAN RIJNSOEVER, E. P., SCHALIJ, M. J. & BAX, J. J. 2011. Cardiac resynchronization therapy as a therapeutic option in patients with moderate-severe functional mitral regurgitation and high operative risk. *Circulation*, 124, 912-9.
- VAN BOMMEL, R. J., YPENBURG, C., BORLEFFS, C. J., DELGADO, V., MARSAN, N. A., BERTINI, M., HOLMAN, E. R., SCHALIJ, M. J. & BAX, J. J. 2010. Value of tissue Doppler echocardiography in predicting response to cardiac resynchronization therapy in patients with heart failure. *Am J Cardiol*, 105, 1153-8.
- VAN DER VELDEN, J., KLEIN, L., ZAREMBA, R., BOONTJE, N., HUYBREGTS, M., STOOKER, W., EIJSMAN, L., DE JONG, J., VISSER, C. & VISSER, F. 2001. Effects of calcium, inorganic phosphate, and pH on isometric force in single skinned cardiomyocytes from donor and failing human hearts. *Circulation*, 104, 1140-1146.
- VAN GELDER, I. C., GROENVELD, H. F., CRIJNS, H. J., TUININGA, Y. S., TIJSSEN, J. G., ALINGS, A. M., HILLEGE, H. L., BERGSMAN-KADIJK, J. A., CORNEL, J. H., KAMP, O., TUKKIE, R., BOSKER, H. A., VAN VELDHUISEN, D. J. & VAN DEN BERG, M. P. 2010. Lenient versus strict rate control in patients with atrial fibrillation. *N Engl J Med*, 362, 1363-73.
- VAN GELDORP, I. E., VERNOOY, K., DELHAAS, T., PRINS, M. H., CRIJNS, H. J., PRINZEN, F. W. & DIJKMAN, B. 2010. Beneficial effects of biventricular pacing in chronically right ventricular paced patients with mild cardiomyopathy. *Europace*, 12, 223-9.
- VAN HEEREBEEK, L., BORBÉLY, A., NIESSEN, H. W., BRONZWAER, J. G., VAN DER VELDEN, J., STIENEN, G. J., LINKE, W. A., LAARMAN, G. J. & PAULUS, W. J. 2006. Myocardial structure and function differ in systolic and diastolic heart failure. *Circulation*, 113, 1966-1973.
- VAN THIELEN, G., PAELINCK, B. P., BECKERS, P., VRINTS, C. J. & CONRAADS, V. M. 2008. Rate response and cardiac resynchronisation therapy in chronic heart failure: higher cardiac output does not acutely improve exercise performance: a pilot trial. *Eur J Cardiovasc Prev Rehabil*, 15, 197-202.
- VAN VELDHUISEN, D. J., BROUWER, J., MAN IN 'T VELD, A. J., DUNSELMAN, P. H., BOOMSMA, F. & LIE, K. I. 1995. Progression of mild untreated heart failure during six months follow-up and clinical and neurohumoral effects of ibopamine and digoxin as monotherapy. DIMT Study Group. Dutch Ibopamine Multicenter Trial. *Am J Cardiol*, 75, 796-800.
- VANERIO, G., VIDAL, J. L., FERNANDEZ BANIZI, P., BANINA AGUERRE, D., VIANA, P. & TEJADA, J. 2008. Medium- and long-term survival after pacemaker implant: Improved survival with right ventricular outflow tract pacing. *Journal of Interventional Cardiac Electrophysiology*, 21, 195-201.

- VARMA, N. 2008. Left ventricular conduction delays induced by right ventricular apical pacing: effect of left ventricular dysfunction and bundle branch block. *J Cardiovasc Electrophysiol*, 19, 114-22.
- VASAN, R. S., BENJAMIN, E. J. & LEVY, D. 1995. Prevalence, clinical features and prognosis of diastolic heart failure: an epidemiologic perspective. *J Am Coll Cardiol*, 26, 1565-74.
- VASSALLO, J. A., CASSIDY, D. M., MILLER, J. M., BUXTON, A. E., MARCHLINSKI, F. E. & JOSEPHSON, M. E. 1986. Left ventricular endocardial activation during right ventricular pacing: effect of underlying heart disease. *J Am Coll Cardiol*, 7, 1228-33.
- VATANKULU, M. A., GOKTEKIN, O., KAYA, M. G., AYHAN, S., KUCUKDURMAZ, Z., SUTTON, R. & HENEIN, M. 2009. Effect of long-term resynchronization therapy on left ventricular remodeling in pacemaker patients upgraded to biventricular devices. *American Journal of Cardiology*, 103, 1280-4.
- VELAZQUEZ, E. J., LEE, K. L., JONES, R. H., AL-KHALIDI, H. R., HILL, J. A., PANZA, J. A., MICHLER, R. E., BONOW, R. O., DOENST, T., PETRIE, M. C., OH, J. K., SHE, L., MOORE, V. L., DESVIGNE-NICKENS, P., SOPKO, G. & ROULEAU, J. L. 2016. Coronary-Artery Bypass Surgery in Patients with Ischemic Cardiomyopathy. *N Engl J Med*, 374, 1511-20.
- VERNOOY, K., VERBEEK, X. A., PESCHAR, M., CRIJNS, H. J., ARTS, T., CORNELUSSEN, R. N. & PRINZEN, F. W. 2005. Left bundle branch block induces ventricular remodelling and functional septal hypoperfusion. *Eur Heart J*, 26, 91-8.
- VICTOR, F., MABO, P., MANSOUR, H., PAVIN, D., KABALU, G., DE PLACE, C., LECLERCQ, C. & DAUBERT, J. C. 2006. A randomized comparison of permanent septal versus apical right ventricular pacing: short-term results. *J Cardiovasc Electrophysiol*, 17, 238-42.
- VLAY, S. C. 2006. Right ventricular outflow tract pacing: practical and beneficial. A 9-year experience of 460 consecutive implants. *Pacing Clin Electrophysiol*, 29, 1055-62.
- WANG, Y. Y. L., WANG, S. H., JAN, M. Y. & WANG, W. K. 2012. Past, Present, and Future of the Pulse Examination (脈診 mài zhěn). *J Tradit Complement Med*, 2, 164-85.
- WASHAM, J. B., STEVENS, S. R., LOKHNYGINA, Y., HALPERIN, J. L., BREITHARDT, G., SINGER, D. E., MAHAFFEY, K. W., HANKEY, G. J., BERKOWITZ, S. D., NESSEL, C. C., FOX, K. A., CALIFF, R. M., PICCINI, J. P. & PATEL, M. R. 2015. Digoxin use in patients with atrial fibrillation and adverse cardiovascular outcomes: a retrospective analysis of the Rivaroxaban Once Daily Oral Direct Factor Xa Inhibition Compared with Vitamin K Antagonism for Prevention of Stroke and Embolism Trial in Atrial Fibrillation (ROCKET AF). *Lancet*, 385, 2363-70.
- WEBER, K. T. & JANICKI, J. S. 1985. Cardiopulmonary exercise testing for evaluation of chronic cardiac failure. *Am J Cardiol*, 55, 22a-31a.
- WEBER, K. T., KINASEWITZ, G. T., JANICKI, J. S. & FISHMAN, A. P. 1982. Oxygen utilization and ventilation during exercise in patients with chronic cardiac failure. *Circulation*, 65, 1213-23.
- WILENSKY, R. L., YUDELMAN, P., COHEN, A. I., FLETCHER, R. D., ATKINSON, J., VIRMANI, R. & ROBERTS, W. C. 1988. Serial electrocardiographic changes in idiopathic dilated cardiomyopathy confirmed at necropsy. *Am J Cardiol*, 62, 276-83.
- WILKOFF, B. L. 2001. Should all patients receive dual chamber pacing ICDs? The rationale for the DAVID trial. *Curr Control Trials Cardiovasc Med*, 2, 215-217.
- WILKOFF, B. L., COOK, J. R., EPSTEIN, A. E., GREENE, H. L., HALLSTROM, A. P., HSIA, H., KUTALEK, S. P. & SHARMA, A. 2002. Dual-chamber pacing or ventricular backup pacing in patients with an implantable defibrillator: the

- Dual Chamber and VVI Implantable Defibrillator (DAVID) Trial. *Jama*, 288, 3115-23.
- WILLENHEIMER, R., VAN VELDHUISEN, D. J., SILKE, B., ERDMANN, E., FOLLATH, F., KRUM, H., PONIKOWSKI, P., SKENE, A., VAN DE VEN, L., VERKENNE, P. & LECHAT, P. 2005. Effect on survival and hospitalization of initiating treatment for chronic heart failure with bisoprolol followed by enalapril, as compared with the opposite sequence: results of the randomized Cardiac Insufficiency Bisoprolol Study (CIBIS) III. *Circulation*, 112, 2426-35.
- WILMORE, J. H., STANFORTH, P. R., TURLEY, K. R., GAGNON, J., DAW, E. W., LEON, A. S., RAO, D. C., SKINNER, J. S. & BOUCHARD, C. 1998. Reproducibility of cardiovascular, respiratory, and metabolic responses to submaximal exercise: the HERITAGE Family Study. *Med Sci Sports Exerc*, 30, 259-65.
- WILSON, J. R., DOUGLAS, P., HICKEY, W. F., LANOCE, V., FERRARO, N., MUHAMMAD, A. & REICHEK, N. 1987. Experimental congestive heart failure produced by rapid ventricular pacing in the dog: cardiac effects. *Circulation*, 75, 857-67.
- WILSON, J. R., HANAMANTHU, S., CHOMSKY, D. B. & DAVIS, S. F. 1999. Relationship between exertional symptoms and functional capacity in patients with heart failure. *J Am Coll Cardiol*, 33, 1943-7.
- WILTON, S. B., EXNER, D. V., HEALEY, J. S., BIRNIE, D., ARNOLD, M. O., SAPP, J. L., THIBAUT, B., SIMPSON, C. S., TUNG, S., CRYSTAL, E., SIVAKUMARAN, S., KHAYKIN, Y., YETISIR, E., WELLS, G. & TANG, A. S. 2014. Left ventricular lead position and outcomes in the Resynchronization-Defibrillation for Ambulatory Heart Failure Trial (RAFT). *Can J Cardiol*, 30, 413-9.
- WINDECKER, S., KOLH, P., ALFONSO, F., COLLET, J. P., CREMER, J., FALK, V., FILIPPATOS, G., HAMM, C., HEAD, S. J., JUNI, P., KAPPETEIN, A. P., KASTRATI, A., KNUUTI, J., LANDMESSER, U., LAUFER, G., NEUMANN, F. J., RICHTER, D. J., SCHAUERTE, P., SOUSA UVA, M., STEFANINI, G. G., TAGGART, D. P., TORRACCA, L., VALGIMIGLI, M., WIJNS, W. & WITKOWSKI, A. 2014. 2014 ESC/EACTS Guidelines on myocardial revascularization: The Task Force on Myocardial Revascularization of the European Society of Cardiology (ESC) and the European Association for Cardio-Thoracic Surgery (EACTS) Developed with the special contribution of the European Association of Percutaneous Cardiovascular Interventions (EAPCI). *Eur Heart J*, 35, 2541-619.
- WITTE, K. K. 2014. BLOCK-HF: a game changer or a step too far? *Heart*, 100, 361-2.
- WITTE, K. K., NIKITIN, N. P., PARKER, A. C., VON HAEHLING, S., VOLK, H. D., ANKER, S. D., CLARK, A. L. & CLELAND, J. G. 2005. The effect of micronutrient supplementation on quality-of-life and left ventricular function in elderly patients with chronic heart failure. *Eur Heart J*, 26, 2238-44.
- WITTE, K. K., PIPES, R. R., NANTHAKUMAR, K. & PARKER, J. D. 2006. Biventricular pacemaker upgrade in previously paced heart failure patients--improvements in ventricular dyssynchrony. *J Card Fail*, 12, 199-204.
- WITTE, K. K., THACKRAY, S. D., NIKITIN, N. P., CLELAND, J. G. & CLARK, A. L. 2003. The effects of alpha and beta blockade on ventilatory responses to exercise in chronic heart failure. *Heart*, 89, 1169-73.
- WOKHLU, A., REA, R. F., ASIRVATHAM, S. J., WEBSTER, T., BROOKE, K., HODGE, D. O., WISTE, H. J., DONG, Y., HAYES, D. L. & CHA, Y. M. 2009. Upgrade and de novo cardiac resynchronization therapy: impact of paced or intrinsic QRS morphology on outcomes and survival. *Heart Rhythm*, 6, 1439-47.

- WRIGHT, J. T., JR., WILLIAMSON, J. D., WHELTON, P. K., SNYDER, J. K., SINK, K. M., ROCCO, M. V., REBOUSSIN, D. M., RAHMAN, M., OPARIL, S., LEWIS, C. E., KIMMEL, P. L., JOHNSON, K. C., GOFF, D. C., JR., FINE, L. J., CUTLER, J. A., CUSHMAN, W. C., CHEUNG, A. K. & AMBROSIUS, W. T. 2015. A Randomized Trial of Intensive versus Standard Blood-Pressure Control. *N Engl J Med*, 373, 2103-16.
- XIAO, H. B., BRECKER, S. J. & GIBSON, D. G. 1992. Effects of abnormal activation on the time course of the left ventricular pressure pulse in dilated cardiomyopathy. *Br Heart J*, 68, 403-7.
- XIAO, H. B., LEE, C. H. & GIBSON, D. G. 1991. Effect of left bundle branch block on diastolic function in dilated cardiomyopathy. *Br Heart J*, 66, 443-7.
- YADAV, R., JASWAL, A., CHENNAPRAGADA, S., KAMATH, P., HIREMATH, S. M., KAHALI, D., ANAND, S., SOOD, N. K., MISHRA, A., MAKKAR, J. S. & KAUL, U. 2016. Effectiveness of Ventricular Intrinsic Preference (VIP) and Ventricular AutoCapture (VAC) algorithms in pacemaker patients: Results of the validate study. *J Arrhythm*, 32, 29-35.
- YAMAMOTO, K., BURNETT, J. C., JR., BERMUDEZ, E. A., JOUGASAKI, M., BAILEY, K. R. & REDFIELD, M. M. 2000. Clinical criteria and biochemical markers for the detection of systolic dysfunction. *J Card Fail*, 6, 194-200.
- YAP, S. C., SCHAER, B. A., BHAGWANDIEN, R. E., KUHNE, M., DABIRI ABKENARI, L., OSSWALD, S., SZILI-TOROK, T., STICHERLING, C. & THEUNS, D. A. 2014. Evaluation of the need of elective implantable cardioverter-defibrillator generator replacement in primary prevention patients without prior appropriate ICD therapy. *Heart*, 100, 1188-92.
- YASUNOBU, Y., OUDIZ, R. J., SUN, X. G., HANSEN, J. E. & WASSERMAN, K. 2005. End-tidal PCO₂ abnormality and exercise limitation in patients with primary pulmonary hypertension. *Chest*, 127, 1637-46.
- YOUSAF, F., COLLERTON, J., KINGSTON, A., KENNY, A., DAVIES, K., JAGGER, C., ROBINSON, L., KIRKWOOD, T. B. & KEAVNEY, B. 2012. Prevalence of left ventricular dysfunction in a UK community sample of very old people: the Newcastle 85+ study. *Heart*, 98, 1418-23.
- YU, C. C., LIU, Y. B., LIN, M. S., WANG, J. Y., LIN, J. L. & LIN, L. C. 2007. Septal pacing preserving better left ventricular mechanical performance and contractile synchronism than apical pacing in patients implanted with an atrioventricular sequential dual chamber pacemaker. *Int J Cardiol*, 118, 97-106.
- YU, C. M., ABRAHAM, W. T., BAX, J., CHUNG, E., FEDEWA, M., GHIO, S., LECLERCQ, C., LEON, A. R., MERLINO, J., NIHOYANNOPOULOS, P., NOTABARTOLO, D., SUN, J. P. & TAVAZZI, L. 2005a. Predictors of response to cardiac resynchronization therapy (PROSPECT)--study design. *Am Heart J*, 149, 600-5.
- YU, C. M., BLEEKER, G. B., FUNG, J. W., SCHALIJ, M. J., ZHANG, Q., VAN DER WALL, E. E., CHAN, Y. S., KONG, S. L. & BAX, J. J. 2005b. Left ventricular reverse remodeling but not clinical improvement predicts long-term survival after cardiac resynchronization therapy. *Circulation*, 112, 1580-6.
- YU, C. M., CHAN, Y. S., ZHANG, Q., YIP, G. W., CHAN, C. K., KUM, L. C., WU, L., LEE, A. P., LAM, Y. Y. & FUNG, J. W. 2006. Benefits of cardiac resynchronization therapy for heart failure patients with narrow QRS complexes and coexisting systolic asynchrony by echocardiography. *J Am Coll Cardiol*, 48, 2251-7.
- ZANNAD, F., MCMURRAY, J. J., KRUM, H., VAN VELDHUISEN, D. J., SWEDBERG, K., SHI, H., VINCENT, J., POCOOCK, S. J. & PITT, B. 2011. Eplerenone in patients with systolic heart failure and mild symptoms. *N Engl J Med*, 364, 11-21.
- ZANON, F., BACCHIEGA, E., RAMPIN, L., AGGIO, S., BARACCA, E., PASTORE, G., MAROTTA, T., CORBUCCI, G., RONCON, L., RUBELLO, D. &

- PRINZEN, F. W. 2008. Direct His bundle pacing preserves coronary perfusion compared with right ventricular apical pacing: a prospective, cross-over mid-term study. *Europace*, 10, 580-7.
- ZAPHIRIOU, A., ROBB, S., MURRAY-THOMAS, T., MENDEZ, G., FOX, K., MCDONAGH, T., HARDMAN, S. M., DARGIE, H. J. & COWIE, M. R. 2005. The diagnostic accuracy of plasma BNP and NTproBNP in patients referred from primary care with suspected heart failure: results of the UK natriuretic peptide study. *Eur J Heart Fail*, 7, 537-41.
- ZELIS, R., NELLIS, S. H., LONGHURST, J., LEE, G. & MASON, D. T. 1975. Abnormalities in the regional circulations accompanying congestive heart failure. *Prog Cardiovasc Dis*, 18, 181-99.
- ZELLER, T., BLANKENBERG, S. & DIEMERT, P. 2012. Genomewide association studies in cardiovascular disease—an update 2011. *Clinical chemistry*, 58, 92-103.
- ZHANG, X. H., CHEN, H., SIU, C. W., YIU, K. H., CHAN, W. S., LEE, K. L., CHAN, H. W., LEE, S. W., FU, G. S., LAU, C. P. & TSE, H. F. 2008. New-onset heart failure after permanent right ventricular apical pacing in patients with acquired high-grade atrioventricular block and normal left ventricular function. *J Cardiovasc Electrophysiol*, 19, 136-41.
- ZIFF, O. J., LANE, D. A., SAMRA, M., GRIFFITH, M., KIRCHHOF, P., LIP, G. Y., STEEDS, R. P., TOWNEND, J. & KOTECHA, D. 2015. Safety and efficacy of digoxin: systematic review and meta-analysis of observational and controlled trial data. *Bmj*, 351, h4451.
- ZILE, M. R., BLAUSTEIN, A. S., SHIMIZU, G. & GAASCH, W. H. 1987. Right ventricular pacing reduces the rate of left ventricular relaxation and filling. *J Am Coll Cardiol*, 10, 702-9.
- ZISHIRI, E. T., WILLIAMS, S., CRONIN, E. M., BLACKSTONE, E. H., ELLIS, S. G., ROSELLI, E. E., SMEDIRA, N. G., GILLINOV, A. M., GLAD, J. A., TCHOU, P. J., SZYMKIEWICZ, S. J. & CHUNG, M. K. 2013. Early risk of mortality after coronary artery revascularization in patients with left ventricular dysfunction and potential role of the wearable cardioverter defibrillator. *Circ Arrhythm Electrophysiol*, 6, 117-28.