



Megardon, G., Ludwig, C., & Sumner, P. (2017). Trajectory curvature in saccade sequences: spatiotopic influences vs. residual motor activity. *Journal of Neurophysiology*, *118*(2), 1310-1320.
<https://doi.org/10.1152/jn.00110.2017>

Peer reviewed version

Link to published version (if available):
[10.1152/jn.00110.2017](https://doi.org/10.1152/jn.00110.2017)

[Link to publication record in Explore Bristol Research](#)
PDF-document

This is the author accepted manuscript (AAM). The final published version (version of record) is available online via APS at <http://jn.physiology.org/content/118/2/1310>. Please refer to any applicable terms of use of the publisher.

University of Bristol - Explore Bristol Research

General rights

This document is made available in accordance with publisher policies. Please cite only the published version using the reference above. Full terms of use are available:
<http://www.bristol.ac.uk/pure/about/ebr-terms>

1 Trajectory curvature in saccade se-
2 quences: spatiotopic influences vs
3 residual motor activity.

4 Authors:

5 **Affiliations:**

6 Geoffrey Megardon^{1,3}, Casimir Ludwig² and Petroc Sumner³

7 1- Cardiff University Brain Research Imagery Centre, School of Psychology, Cardiff
8 University, Maindy Road, Cardiff, CF24 4HQ, UK

9 2- School of Experimental Psychology, University of Bristol, 12a Priory Road, Bris-
10 tol BS8 1TU, UK

11 3- School of Psychology, Cardiff University, Tower Building, 70 Park Place, Cardiff,
12 CF10 3AT, UK

13

14 **Contact Mails:**

15 geoffrey.megardon@gmail.com

16 C.Ludwig@bristol.ac.uk

17 sumnerp@cardiff.ac.uk

18

19 **Abbreviated Title:**

20 Trajectory curvature in saccade sequences

21

22

23

24

25

26

27 **Abstract:**

28 *When decisions drive saccadic eye movements, traces of the decision process can be in-*
29 *ferred from the movement trajectories. For example, saccades can curve away from dis-*
30 *tractor stimuli, which was thought to reflect cortical inhibition biasing activity in the Su-*
31 *perior Colliculus. Recent neurophysiological work does not support this theory, and two*
32 *recent models have replaced top-down inhibition with lateral interactions in the Superior*
33 *Colliculus or neural fatigue in the brainstem Saccadic Burst Generator. All current mod-*
34 *els operate in retinotopic coordinates and are based on single saccade paradigms. In or-*
35 *der to extend these models to sequences of saccades, we assessed whether and how sac-*
36 *cade curvature depends on previously fixated locations and the direction of previous sac-*
37 *cades. With a two-saccade paradigm, we first demonstrated that second saccades curved*
38 *away from the initial fixation stimulus. Furthermore, by varying the time from fixation*
39 *offset and the intersaccadic duration, we distinguished the extent of curvature originat-*
40 *ing from the spatiotopic representation of the previous fixation location or residual mo-*
41 *tor activity of the previous saccade. Results suggest that both factors drive curvature, and*
42 *we discuss how these effects could be implemented in current models. In particular, we*
43 *propose that the collicular retinotopic maps receive an excitatory spatiotopic update*
44 *from the Lateral Interparial region (LIP).*

45 **New & Noteworthy:**

46 Saccades curve away from locations of previous fixation

47 Varying stimulus timing demonstrates effects of both 1) spatiotopic representation
48 and 2) motor residual activity from previous saccades.

49 Spatiotopic effect can be explained if current models are augmented with an excitatory
50 top-down spatiotopic signal.

51

52 Introduction

53 Most actions are made in sequence and typically involve the selection of one target, at
54 the expense of irrelevant information. Response trajectories are known to reflect the
55 dynamics of this decision process. For instance, the curvature of arm movements can
56 reveal distractor interference (Howard and Tipper 1997; Tipper et al. 1997; Welsh et
57 al. 1999; Chieffi et al. 2001; Chang and Abrams 2004; Welsh and Elliott 2004) and in-
58 decision or preference reversal in multi-alternative tasks (Freeman and Ambady 2010;
59 Koop and Johnson 2011, 2013). Saccadic eye movements—although traditionally con-
60 sidered ballistic—may curve towards a distractor item if the target selection has not
61 yet been fully resolved so that a distractor-related activity is still present in the oculo-
62 motor areas at saccade onset (McPeck et al. 2003; McPeck 2006). Moreover, saccades
63 may curve away from distractor items and this is correlated with lower neural dis-
64 charge at the distractor location in the Superior Colliculus (SC) compared to when the
65 distractor is not present (McPeck et al. 2003; see their Figure 5). This phenomenon was
66 initially thought to reflect the inhibition of distracting information (Howard and Tip-
67 per 1997; Tipper et al. 2001; McSorley et al. 2004). Consistent with this explanation,
68 transient deactivation of a locus in SC of monkeys can cause saccade curvature away
69 from the corresponding locus in space (Aizawa and Wurtz 1998; Quaia and Optican
70 1998), and in humans, early saccades were observed to curve toward the distractor,
71 while late saccades curved away from the distractor, reflecting the putative time-
72 course of top-down inhibition (McSorley 2006; Walker et al. 2006; Zoest et al. 2012).

73 However recent neurophysiological findings challenge this account (White et al. 2012).
74 In this study, monkeys were required to perform a simple saccadic task whilst ignoring
75 any distractor. In trials when the distractor appeared before the target and for which
76 saccades curve away from the distractor, White et al. (2012) expected to observe the
77 trace of top-down inhibition at the distractor loci while the monkey was waiting for
78 the target to appear. Contrary to these expectations, no trace of inhibition was ob-
79 served during that interval in the SC. Note that this surprising finding does not contra-
80 dict the earlier observations of McPeck et al. (2003; 2006), in which less activity at dis-
81 tractor location was reported during the saccade-related discharge. White et al. (2012)

82 did report a similar result *after* target onset. However, there seems to be no clear ana-
83 tomical candidate to send precise and spatially-tuned inhibition to the SC. Because of
84 that and the lack of computational model that implement it, some authors have argued
85 that top-down inhibition is essentially a “deus ex machina” which explains the devia-
86 tion away using an unexplained mechanism (Kruijne et al. 2014).

87 There are currently two computational models that account for curvature away from a
88 non-target signal without top-down inhibition. Wang and colleagues proposed that the
89 curvature originates from local lateral interactions in the intermediate layer of the SC
90 (SCi) (Wang et al. 2012; Wang and Theeuwes 2014). Alternatively, Kruijne and col-
91 leagues proposed an explanation based on a short term depression in the neurons
92 driving the eye muscles—downstream from Superior Colliculus (Kruijne et al. 2014).
93 These models will be described in more detail in the General Discussion. For now, we
94 note two key features that are also shared with the top-down inhibition theory. First
95 these models operate entirely in retinotopic coordinates; hence, they currently do not
96 account for spatiotopic influences (i.e. signals that remain in world coordinates). Sec-
97 ondly these models were built to explain single-saccade paradigms, and currently do
98 not account for any deviation influence arising from previous saccades. Our study aims
99 to address the presence of both influences in a two-saccade paradigm in order to direct
100 potential extensions of the current models to account for sequences of saccades.

101 Studies of free viewing or visual search have shown that, in sequences of saccades,
102 previously fixated locations may influence saccadic behavior in a spatiotopic frame
103 and in an automatic way (Klein and MacInnes 1999; Sogo and Takeda 2006; Smith and
104 Henderson 2011, 2011; Bays and Husain 2012). One obvious example is Inhibition of
105 Return (Posner and Cohen 1984; Sumner 2006), where it can take longer to initiate
106 saccades directed back to a previously fixated location compared to other directions
107 (Klein and MacInnes 1999; Hooge and Frens 2000; Hooge et al. 2005; Ludwig et al.
108 2009; Farrell et al. 2010). However, it is currently unclear whether and in what way
109 IoR and saccade curvature are related. Godijn and Theeuwes (2004) suggested that
110 saccadic curvature and (covert) IoR are based on different mechanisms. Importantly,
111 another set of studies, using single-saccade paradigms, have suggested that saccades

112 tend to curve *away* from memorized stimuli either in retinotopic space (Theeuwes et
113 al. 2005) or in object-centered space (Boon et al. 2014). Furthermore, curvature away
114 was found from the representation of the distractor location in previous trials (Van der
115 Stigchel and Theeuwes 2006). This work highlights that past stimuli can influence the
116 trajectory of the current saccade and that this influence is not necessarily coded in ret-
117 inotopic space. That naturally paves the way for exploring the effect of memory traces
118 in sequences of saccades.

119 In this regard, the study of saccade trajectories during visual search is relevant (Sogo
120 and Takeda 2006). These authors demonstrated that saccades tend to curve away from
121 the spatiotopic representation of previous fixation zones and suggest an effect of the 3
122 last fixation zones. However, these results could support either spatiotopic representa-
123 tions of previous stimuli, or motor residual activity from the direction of previous sac-
124 cades. Indeed, it has been suggested that saccades can allow for residual activity to
125 persist in the motor map after their completion—particularly, that motor residual ac-
126 tivity would facilitate successive saccades in the same direction (Klein and MacInnes
127 1999; Anderson et al. 2008; Smith and Henderson 2009, 2011; Wang et al. 2011). In
128 other words, in Sogo and Takeda (2006), the current saccade might curve away from
129 the previous fixation because the vector of the previous saccade was, by definition,
130 pointing away from that previous fixation, and this vector remains partially active or
131 facilitated.

132 A more direct test for the effect of automatic spatiotopic representations on saccade
133 curvature was performed recently by Jonikaitis and Belopolsky (2014). Participants
134 executed two saccades: the first rightward or leftward while the second was upward
135 or downward. Before the initiation of the first saccade, a distractor briefly occurred to
136 the left or to the right of the vector of the second saccade, so that the first saccade dis-
137 sociates the retinotopic and spatiotopic locations of that distractor. Curvature in the
138 second saccade appeared to depend on the spatiotopic location—they deviate leftward
139 for the rightward distractor and vice versa—and thus may challenge purely retinotop-
140 ic views of saccade trajectory curvatures. However, there is still room for a retinotopic
141 explanation of Jonikaitis and Belopolsky's data. First, both models can produce larger

142 deviation with larger inter-stimulus distances (more detailed in Discussion). Second, if
143 there is some residual motor activity caused by the first saccade, this would induce a
144 deviation in the direction of the first saccade (see **Figure 2B**). Consider how these two
145 factors might interact, with illustration of a “right-then-up” trial. A distractor to the
146 right of the second saccade vector must appear in a more eccentric location from the
147 initial fixation point than a distractor to the left of the second saccade vector. Retino-
148 topically, both distractors are rightward, predicting leftward curvature, but the most
149 eccentric stimulus can produce stronger curvature in the models. In parallel, the as-
150 sumption of residual motor activity from the first saccade would add an equal tenden-
151 cy of rightward curvature to both situations. It is plausible that for a leftward distrac-
152 tor (which has a weak influence), the residual motor activity would be dominant, lead-
153 ing to curvature to the right while, for a rightward distractor (which has a strong influ-
154 ence), the residual motor activity would *not* prevail, resulting in curvature to the left.
155 Thus, Jonikaitis and Bolopolsky (2014)’s data could be explained by a particular com-
156 bination of these retinotopic effects.

157 In order to extend the work of Jonikaitis and Bolopolsky (2014) and Sogo et al. (2006)
158 and test without ambiguity the influence of spatiotopic representations and motor re-
159 sidual activity, we developed a simple two-saccade paradigm without any distractor.
160 First, we established that the second saccade in our sequence curves away from the
161 location of the initial fixation stimulus, consistent with either of these mechanisms.
162 Second, we distinguished these mechanisms through varying the time of the second
163 saccade onset from 1) the fixation offset and 2) the first saccade offset.

164

165 Method

166 Participants

167 Fourteen observers (25-30 years old, nine male) with normal or corrected vision, par-
168 ticipated in this experiment, which was performed with approval from the ethics
169 committee of Cardiff University School of Psychology. All but one (the first author)
170 were naïve to the purpose of the experiment and received payment for their time.

171

172 Procedure and Stimuli

173 There were three types of trials: control trials, single stimulus trial, and double stimu-
174 lus trials, which will be described below. The control trials were present in case we
175 needed a reference to compute the curvature of saccades. It turned out we did not
176 need such a reference, so these trials are not considered in our analyses and report.
177 The single stimulus trials were used to prevent the participant anticipating a second
178 saccade, and are also not analyzed. A participant would complete two experimental
179 sessions of approximately 1 hour, separated by at least one night. Each session con-
180 sisted of setting the chair and chin-rest for the participant to sit comfortably; a 13-
181 point calibration of the Eyelink 2000 Eye tracker; 160 control trials; 640 trials mixing
182 randomly single-stimulus and double-stimuli trials. A break was suggested to the par-
183 ticipant every 200 trials, and re-calibration was conducted every 400 trials.

184 **Figure 1A** and **B** summarize the spatial and temporal configuration of the stimuli. For
185 single and double stimulus trials, the participant was required to fixate a “+” fixation
186 cross (F in **Figure 1**) of radius 0.2° on the screen. The fixation cross could appear ei-
187 ther on the left or on the right of the screen, along the horizontal axis. The participant
188 pressed the space bar to confirm fixation after which the fixation cross disappeared at
189 a random time drawn from a uniform distribution $U(500 \text{ ms}, 1100 \text{ ms})$. Following an
190 optional gap target $S1$ was presented: a circular stimulus of radius 0.4° . It could appear
191 either on the top or the bottom of the screen, along the vertical axis. In the double

192 stimuli trials, the presentation of S_1 was followed by the presentation of S_2 which was
193 the vertical mirror image of S_1 with an angular distance of 60° (i.e., using the Fixation
194 as origin, if S_1 is at -30° of directional angle, S_2 will be at 30°). S_1 and S_2 were always at
195 13.5° of eccentricity from fixation on both single and double step trials. In the control
196 trials, the participants were simply making saccades from S_1 to S_2 locations and vice
197 versa.

198 As justified in the next section, we manipulated the Gap and S_1 durations in a 2x2 de-
199 sign (short/long S_1 and short/long Gap). For short S_1 trials, S_1 duration was randomly
200 taken from a uniform distribution between 250 ms and 450 ms, while for long S_1 trials
201 it was taken between 550 ms and 750 ms, so that duration could not be anticipated
202 even when the short duration had passed. For short Gap trials, the Gap duration was
203 randomly selected from a uniform distribution between 0 ms to 200 ms while for long
204 Gap trials, the Gap duration was picked between 300 ms to 500 ms. Note that the
205 change in duration between short and long conditions is the same for Gap duration
206 and S_1 duration (300 ms). Each condition had an equal number of trials and these
207 were randomly inter-mixed, independently for each participant.

208 All code for running the experiment, the data and analysis scripts can be found on the
209 Open Science Framework at <https://osf.io/t96t2>.

210

211 Hypotheses: Predicted effects of spatiotopic representations or residu-
212 al retinotopic motor activity.

213 Our pilot studies made us confident that the second saccade would observably curve
214 away from the previously fixated stimulus (as will be demonstrated in Results below).
215 However, such curvature could be equally explained by a spatiotopic representation of
216 the previous fixation, or residual motor activity from the first saccade (**Figure 2A** and
217 **B**). Our experiment was designed to discriminate between these mechanisms by sepa-
218 rately adjusting S_1 and Gap durations in a 2x2 design.

219 Importantly, we assumed that the curvature of the saccade is proportional to the sum
220 of the effect of both mechanisms. **Figure 2C** illustrates this point for the case where the
221 effect of the previous fixation (F) and the effect of the residual activity (M) both de-
222 crease with time.

223 **Figure 2C** shows that the effect of motor residual is affected by the time between Sac-
224 cade 2 and Saccade 1, while the effect of the previous fixation depends on the time be-
225 tween Saccade 2 and Fixation offset. On the one hand, increasing the Gap duration pro-
226 longes the time between Saccade 2 and Fixation offset while keeping the intersaccadic
227 interval (between Saccade 1 and Saccade 2) unchanged (we will test the extent to
228 which this assumption holds below). In other words, Gap duration can be used to test
229 for an effect of the previous fixation (F) only. On the other hand, increasing S1 duration
230 extends both the intersaccadic interval and the time between Saccade 2 and Fixation
231 offset, which affects both the effect of the previous fixation (F) and motor residual ac-
232 tivity (M). In other words, S1 duration *cannot* be used on its own to test an effect of
233 residual motor activity (M).

234 This can be solved by choosing carefully a 2x2 design with short/long S1 durations
235 and short/long Gap durations. **Figure 3** illustrates, for each condition, the inter-
236 saccadic intervals, the time since Fixation offset and how the time course of the effect
237 of both motor residual activity (M) and previous fixation (F) would affect the curvature
238 of Saccade 2 (last row). We chose the durations of S1 and Gap so that the combinations
239 “*long Gap / short S1*” and “*short Gap / long S1*” both give a similar time between Sac-
240 cade 2 and Fixation offset (we will assess the extent to which this assumption holds
241 below). Thus, in these conditions, mainly the intersaccadic interval is changed, allow-
242 ing us to test for an effect of motor residual activity (see dark gray lines in last row,
243 column 1, Hypothesis 1). An effect of Fixation only (see light gray line in last row, col-
244 umn 2, Hypothesis 2) would lead to an effect of Gap and S1 duration, but no difference
245 between the conditions “*long Gap / short S1*” and “*short Gap / long S1*”. Finally, an ef-
246 fect of both Fixation and motor residual activity would lead to an effect of Gap and S1
247 duration and a difference between the conditions “*long Gap / short S1*” and “*short Gap*
248 */ long S1*” (column 3, Hypothesis 3). Importantly, similar effects were predicted with

249 linear decays and increase functions while the effect sizes varied with the parameters
250 of the functions (more figures and source code accessible online).

251 It is noteworthy that we do not assume any direction concerning the time course of the
252 effects and our paradigm is tailored to inform us on their direction. In **Figure 3**, if the
253 motor residual activity increases with time, then the related trend line (dark gray line
254 in last row) will have a positive slope. Similarly, if the effect of Fixation increases with
255 time, then the related trend lines (light gray line in last row) will have a positive slope.

256 Importantly, if the effect of Fixation and of the motor residual activity progresses in the
257 same direction over time, an alternative way to check for an effect of motor residual
258 activity is to test whether the effect of S1 duration is greater than the effect of Gap du-
259 ration (rather than equal, see **Figure 3**, column 3, last row). That is due to the fact that
260 a change of S1 duration affects both the effects of Fixation and motor residual activity
261 (as seen with **Figure 2**).

262 To summarize, our paradigm can discriminate between three hypotheses in addition
263 to the null hypothesis. **Hypothesis 1**: only the residual motor activity of the previous
264 saccade has an effect. **Hypothesis 2**: only the spatiotopic representation of the previ-
265 ous fixation has an effect. **Hypothesis 3**: both the spatiotopic representation and re-
266 sidual motor activity have an effect. It can also differentiate between an increasing and
267 a decreasing time course of each effect.

268

269 Data Analysis

270 A saccade was marked for analysis if the acceleration was greater than $6,000 \text{ }^\circ.\text{s}^{-2}$, the
271 absolute velocity was larger to $10^\circ.\text{s}^{-1}$ and the amplitude was larger than 5.4° . A trial
272 was rejected if: no saccade was made, or two saccades were made to reach a stimulus,
273 the reaction time or intersaccadic time was shorter than 80 ms, a saccade duration was
274 longer than 150 ms, or a saccade contained eye positions outside the screen or missing
275 data.

276 In our experimental design, the selection of one hypothesis (see previous section 0)
277 over another may be based on the *absence* of an effect (i.e. a null effect). The Bayesian
278 framework provides one way to assess the graded evidence in favor or against the in-
279 fluence of some experimental factor (Wagenmakers 2007; Rouder et al. 2009; Morey
280 and Rouder 2011). Thus, we employed the Bayes Factor framework for analysis of our
281 data (Rouder et al. 2012; specifically the R package BayesFactor; Rouder and Morey
282 2012). Furthermore, Bayes Factors are very useful in order to test models against each
283 other and/or select the best model as they penalize complexity (Raftery 1995).

284 The analysis proceeded in three steps. First, we demonstrate that the second saccades
285 curved away from the spatiotopic location of the Fixation stimulus (replicating pilot
286 experiments that showed this on a small sample of participants). We simply selected,
287 based on the Bayes Factor (BF), the best model that explains the initial deviation (see
288 **Figure 4** for the precise measure) among models combining effects of Participant and
289 Fixation side. That analysis used the trial-by-trial initial deviations of the participants
290 (~125 data points per participant per condition).

291 In a second step, we checked that the assumptions we made on the consistency of sac-
292 cade latencies and durations across conditions were met. Importantly, we needed to
293 make sure that: 1) the time onset of Saccade 2 since the Fixation offset is similar be-
294 tween the conditions shortGap/longS1 and longGap/shortS1; 2) the intersaccadic time
295 is similar between shortGap and longGap conditions. We used within-subject Bayesi-
296 an 2x2 ANOVAs to check these requirements.

297 In a third step, we tested the hypotheses outlined in the previous section to discrimi-
298 nate the effect of motor residual activity from the effect of the spatiotopic representa-
299 tion of the previous fixation. For simplicity and better readability of the results, we col-
300 lapsed the data so that we obtained the mean difference in initial deviation between
301 the conditions Fixation left and Fixation right (abbreviated to IDD_{LR}) for each partici-
302 pant and each condition (i.e. Gap/S1 durations). To test an effect of the Fixation, we
303 ran a Bayesian top-down analysis that assesses the importance of Gap and S1 duration
304 in explaining our data. Specifically, a full model that considers all the variables and in-
305 teractions is tested against models that omit each of the independent variables (Δ Gap,

306 $\Delta S1$), random variables (Participant), and their interactions (see Figure 7 and **Table**
307 **1**). Thus, the full model we used was the following general linear model:

308 $IDD_{LR} \sim S1.Duration + Gap.Duration + Participant + S1.Duration:Gap.Duration +$
309 $S1.Duration:Participant + Gap.Duration:Participant +$
310 $S1.Duration:Gap.Duration:Participant.$

311 Then, to assess an effect of the motor residual activity of the previous saccade, we test-
312 ed the effect direction between shortS1/longGap and longS1/shortGap and whether
313 the effect size of S1 duration is greater than the effect size of Gap duration.

314 We matched the BFs with the interpretation tags of Raftery (1995; see also Kass and
315 Raftery 1995). These tags are written in italics. For readers preferring null hypothesis
316 significance tests, these can be found on the OSF repository and support the same con-
317 clusion.

318

319

320 Results

321 The average rejection rate of trials was 27 % (the rejection rules can be found in sec-
322 tion 0. We rejected in total 3 participants based on their proportion of rejected trials
323 (greater than 40%; we aimed to get at least 50 data points in each cell of the design to
324 allow for robust estimates of measures of central tendency of latency, duration, and
325 curvature), concluding that the gap was too disruptive to their performance (anticipa-
326 tory saccades) or that the eye-tracker was not recording properly (missing data).

327 Saccade curvature away from the previous fixation point

328 **Figure 4** reveals that the second saccade clearly curves away from the initial fixation
329 position at the participant level (left subplot) and at the participant average level
330 (right subplot). The inset of the right subplot shows the mean saccade deviation at 20
331 ms from saccade onset, averaged over the participants, with 95% confidence intervals.

332 Clearly, the deviations are significantly more rightward when the fixation is on the left
333 (brighter bars) and more leftward when the fixation is on the right (darker bars).
334 These impressions of the data were confirmed by the Bayes Factor analysis—the mod-
335 el that includes Fixation side and Participant was unambiguously better than the mod-
336 el with Participant only (BF > 1000). The model with an interaction between Partici-
337 pant and Fixation side was classed as the best model (BF > 1000 against the main ef-
338 fect model) suggesting inter-individual differences in the effect of Fixation side.

339

340 Intersaccadic intervals and second saccade latency

341 It is worth recalling that a good data set for testing our hypotheses should show:

- 342 1. An effect of S1 Duration but no effect of Gap Duration on the intersaccadic inter-
343 val,
- 344 2. A similar distribution of the time interval between Fixation offset and Saccade 2
345 onset when comparing “*long S1 / short Gap*” with “*short S1 / long Gap*” conditions.

346 The data broadly met those requirements. **Figure 5A** shows the latency of the second
347 saccade relative to the first saccade offset. A Bayesian 2x2 within-subject ANOVA on
348 the intersaccadic intervals, revealed an effect of Gap Duration (BF >1000 against a Gap
349 Duration omission). However, this effect is very small compared to the effect of S1 Du-
350 ration— i.e., 9 times smaller (267 ms against 31 ms on average). **Figure 5B** shows the
351 latency of the second saccade relative to fixation offset. Again, although a Bayesian t-
352 test reveals a difference in the time from Fixation Offset when comparing “*short Gap /*
353 *long S1*” with “*long Gap / short S1*” (BF > 1000 against null slope), this difference is 10
354 times smaller than the main effects of S1 Duration and Gap Duration (301 ms for Gap
355 Duration, 272 ms for S1 Duration against 30 ms for the analyzed slope).

356

357

358 Testing the Origin of the Fixation Side Effect

359 **Figure 6** presents a summary of the data that can be compared directly to the predic-
360 tions presented in **Figure 3**. At first glance, there seems to be an effect of Gap and S1
361 duration, which suggests an effect of the previous fixation, while the conditions short
362 S1/long Gap and long S1/short Gap look different, which suggests an effect of the mo-
363 tor residual activity of the previous fixation. The general pattern of results support a
364 decreasing time course of both effects.

365

366 **Table 1** shows the results of the Bayesian Top-down analysis. The polarity tag *in favor*
367 means that to omit the variable is detrimental to the full model— i.e. the evidence is *in*
368 *favor* of an effect of the variable. Matching the BFs with the interpretation tags of Raft-
369 ery (1995), we can see that there is *positive* evidence in favor of an effect of both Gap
370 and S1 durations. The model is also improved by including some differences between
371 participants in the effect of S1 duration. The best model reported by the analysis is the
372 following:

373 $IDD_{LR} \sim S1.Duration + Gap.Duration + Participant + Participant:S1.Duration$

374 Where IDD_{LR} stands for the difference in initial deviation between the conditions Fixa-
375 tion Left and Fixation Right. Thus, our analysis, by suggesting an effect of both Gap and
376 S1 duration, is supportive of an effect of the spatiotopic representation of the previous
377 fixation (see **Figure 3**, last row). To test the direction of the effect of Gap (longGap –
378 shortGap), we ran a one-sided paired t-test on the distributions for longGap and short
379 Gap conditions. When tested against the null, the BF of the effect of Gap being positive
380 is 0.06 (+0.1%) while the BF of being negative is of 20.7 (+0%). Overall, the BF of be-
381 ing negative against being positive is very strong (combined BF = 20.7/0.06 = 321). We
382 read the combined BF as very strong evidence of an asymmetry favoring negative val-
383 ues; that is supportive of a decrease of the Fixation effect over time.

384

385 Now that we have strong evidence for an effect of the spatiotopic representation of the
386 Fixation, we need to discriminate between Hypothesis 2 (Effect of Fixation only) and
387 Hypothesis 3 (Effect of Fixation and motor residual activity).

388 As explained in section 0, more tests are needed to assess the effect of the motor re-
389 sidual activity of the previous saccade. One way is to compare the longS1/shortGap
390 and shortS1/longGap conditions (see **Figure 3**, last row, dark gray lines), so we ran a
391 paired one-sided t-test on their distributions. When tested against the null, the BF of
392 $(\text{longS1/shortGap} - \text{shortS1/longGap} < 0)$ is 1.26 while the BF of $(\text{longS1/shortGap} -$
393 $\text{shortS1/longGap} > 0)$ was 0.14. In other words, our data does not provide enough evi-
394 dence to distinguish between no effect and decreasing effect of motor residual activity
395 over time (i.e. the time since fixation being controlled). However, the data contains
396 positive evidence against an increasing effect. That asymmetry between the two t-test
397 leads the combined BF testing for the effect being negative rather than positive to be
398 $1.26/0.14 = 9$, which is positive evidence in support of a decreasing effect. Hence, alt-
399 hough we would need more data to settle unambiguously whether there is a decreas-
400 ing effect, the asymmetry between the two t-test is an encouraging result.

401 As there is some evidence that the fixation effect and the motor residual effect go in the
402 same direction over time (or, at least, not in opposite directions), we expect the effect
403 size of S1 to be greater than the effect size of Gap if a motor residual activity is indeed
404 present (see section 0). We computed the distribution of non-standardized effect sizes
405 for S1 (i.e. short S1 – long S1) and for Gap (i.e. short Gap – long Gap) and we ran a one-
406 sided paired t-test on them. We are here mostly interested in (S1 effect > Gap effect)
407 against the null (S1 effect = Gap effect), for which the BF is 2.89. That represents weak
408 evidence in favor of an effect of motor residual activity.

409 Finally, **Figure 7** illustrates the difference in effect size by sampling these effects from
410 the posterior distribution of the best model. When comparing the two subplots, the
411 effect of S1 duration appears to be greater, but also more variable than the effect of
412 Gap duration. Recall that, under Hypothesis 3, S1 duration effect would be the sum of
413 the effect of Fixation and motor residual activity, while Gap duration effect only de-
414 pends on the effect of Fixation. This sum of two effects would lead to a greater effect

415 and greater variance for S1 duration. In other words, the posterior distribution is such
416 as expected under Hypothesis 3.

417 To conclude, the data provide some support for **Hypothesis 3** over **Hypothesis 2**
418 while rejecting **Hypothesis 1**. In other words, the curvature away that we observed is
419 caused by both a spatiotopic representation of the previously fixated location and a
420 motor residual activity from the previous saccade. Furthermore, the effect of the pre-
421 vious fixation and of the motor residual activity decreases with time in the interval un-
422 der consideration here.

423

424

425 Discussion

426 Analyzing trajectory curvature during a sequence of saccades allowed us to answer
427 whether there is a need to extend recent computational models of saccade curvatures
428 that are based on retinotopic brain regions (Kruijne et al. 2014; Wang and Theeuwes
429 2014). These models that were built to explain trajectory curvatures in single-saccade
430 paradigm and thus could not predict influence of 1) the spatiotopic representation of
431 previous stimuli and/or 2) previous saccades on the current saccade trajectory that
432 may happen during sequence of saccades. Using a two-saccade paradigm, we demon-
433 strated an influence of both these factors and suggested that their influence decreases
434 with time. Such a decreasing time course is expected for a residual motor signal, but it
435 might be surprising for a memorized, spatiotopic representation. Indeed, previous
436 studies that tested the spatiotopic representation of peripheral stimuli at a shorter
437 time scale than ours reported increasing curvature with time (Jonikaitis and Belopol-
438 sky 2014). However our results are in agreement with work that tested the represen-
439 tation of previous fixations—as in our experiment—at a similar time scale as ours
440 (Sogo and Takeda 2006; see their Figure 8). In the next sections, we will discuss how
441 the current models of saccade curvature can be updated in order to explain our results.

442 Prediction of Kruijne et al. (2014)'s model

443 The model of Kruijne et al. (2014) is based on fatigue (resembling Short Term Depres-
444 sion, a decrease in the neuronal sensitivity following sustained input) occurring in the
445 brainstem. They assume one neural population per saccadic direction (left, right, up,
446 down) and a fatigue mechanism in the Long-Lead-Burst neurons (LLBNs). The LLBNs
447 are known not to be inhibited by the omnipause neurons between saccades (Scudder
448 et al. 2002)). In addition a visually evoked signal on the SC can activate the LLBNs
449 (Rodgers et al. 2006). Consequently, the idea of Kruijne et al. (2014) is that a distractor
450 would activate the LLBNs and fatigue specifically the neurons coding for a saccade to
451 the distractor. That fatigue would modify the trajectory of the next saccade: a distrac-
452 tor placed on the right of the target would fatigue the right LLBNs: the imbalance
453 would cause a curvature to the left for the next saccade. As the SC connections to
454 LLBNs are stronger for eccentric positions, the fatigue caused to the LLBNs would in-
455 crease with distractor eccentricity, resulting in a stronger curvature (in line with Van
456 der Stigchel et al., 2007). With the same logic, the model assumes that a long presenta-
457 tion of the distractor would also increase the fatigue of the LLBNs. Their theory is ra-
458 ther appealing in the way in which it explains the major phenomena that top-down
459 inhibition control was given credit for.

460 In our experiment, however, such a fatigue mechanism driven by visual stimuli would
461 predict either no curvature or a curvature *toward* the previous fixation point depend-
462 ing on the time scale of the fatigue. For instance, as stimulus S1 is foveal shortly before
463 the second saccade, a short-term fatigue would affect equally all four LLBN popula-
464 tions, leading to no curvature. Alternatively,, in trials where S1 appears toward the
465 right, for instance, a long-term fatigue from S1 could still affect the right LLBNs during
466 the second saccade: the second saccade should curve toward the left, towards the pre-
467 vious fixation. In any case, these predictions are opposite to what we observed.

468 Prediction of Wang et al. (2012, 2014)'s model

469 The model of Wang et al. (2012; 2014) is based on hypothetical spatial interactions
470 and winner-take-all selection occurring between stimuli on the Superior Colliculus
471 (SC) map. These spatial interactions assumed that the SC is reducible to a Dynamic
472 Neural Field with a Mexican hat kernel. The Mexican hat (MH) kernel defines three in-
473 teraction zones centered around the stimulus input locus: a circular attraction zone, a
474 ring repelling zone and a no-interaction zone (Amari 1977). Because of these, the locus
475 of a peak of activity on the SC map can deviate from the locus of its related stimulus
476 input. Furthermore, it is the locus of one of these peaks that will determine the sac-
477 cadic vector through a winner-take-all selection. With this simple attraction/repulsion
478 mechanism between stimulus representations, Wang et al. (2012; 2014) successfully
479 explained the relationship between initial deviations in saccade trajectory and distrac-
480 tor-target separation observed in the previous literature, notably based on McSorley et
481 al. (2009)'s data and on a meta-analysis across 12 data sets. Furthermore, considering
482 that a fixated stimulus also evoked a MH activation of the SC, they predicted and
483 demonstrated experimentally that the timing of the fixation stimulus can affect the tra-
484 jectory of saccades curving away from a distractor (Wang and Theeuwes 2014). This
485 influence is explained by a Fixation-Target repelling effect interacting with a Target-
486 Distractor repelling effect while the timing of the fixation stimulus varies the strength
487 of the former effect.

488 This demonstration of their theory is elegant, however, to place the Mexican hat kernel
489 and the fixation representation specifically in the SC without external updates pre-
490 vents their model in its *current* state from explaining our results. With retinotopic in-
491 puts, both S1 and the Fixation stimulus would participate in shaping a MH profile cen-
492 tered on the rostral pole (i.e. fixation zone) of the SC (note that S1 is in the fixation
493 zone after saccade 1). This MH profile would vary in strength according to Gap and S1
494 durations, and would result in different deviation of S2's representation from the ros-
495 tral pole. This predicts slight changes ($< 0.2^\circ$ in Wang and Theeuwes 2014) in the am-
496 plitude of Saccade 2, but no changes in curvature.

497 Proposed model updates

498 We believe that our work does not disqualify the main mechanisms of the recent mod-
499 els, however, it calls to augment them with additional mechanisms.

500 The large dependence of saccadic curvature on the time since the previous saccade, is
501 likely to partly originate from a saccade-related residual activity in the Superior Collic-
502 ulus, as assumed by the work of other authors (Soetens et al. 1985; Anderson et al.
503 2008; Wang et al. 2011). The model of Kruijne et al. (2014) and Wang et al. (2012,
504 2014) did not consider motor residual activity from previous saccades because they
505 were both developed to explain results from single-saccade paradigms. Concerning
506 Kruijne et al. (2014), it might be difficult to reconcile the inhibitory effect of a fatigue
507 mechanism with the excitatory effect of a motor residual activity. For instance, motor
508 residual activity in the SC could cause fatigue in the LLBNs and lead to the reverse ef-
509 fect of what we observed— i.e. a deviation toward the initial Fixation stimulus. One
510 solution would be to treat saccade-evoked activation of LLBNs differently from stimuli-
511 evoked activation of the LLBNs. This could translate to the different types of neurons
512 in the SC, respectively the motor-related and visual-related neurons. In a revised ver-
513 sion of the model, the former would produce residual activity without fatigue in the
514 LLBNs, whilst the latter would produce fatigue in the LLBNs by the time the critical
515 saccade occurs.

516 In the model of Wang et al. (2012, 2014), the motor residual activity should not conflict
517 with the current mechanisms. Neural field models—such as in Kruijne et al. and Wang
518 et al. —generate automatically decaying residual activity after input offset because of
519 the decay time constant (10-50 ms) they use. In fact, that kind of residual activity was
520 used to explain several behavioral data sets on overt Inhibition of Return (IoR, Wang et
521 al. 2011). Nevertheless, if motor residual activity is subject to Mexican Hat spatial in-
522 teractions, there will be a similar problem as in the model of Kruijne et al. (2014).

523 While the participant is fixating S1 and preparing to move to S2, the residual activity of
524 Saccade 1 will push the activity related to S2 toward the initial Fixation point and lead
525 to deviation *toward* the initial Fixation point. To avoid this, the addition of motor re-

526 sidual activity needs to be independent from spatial interactions, and may, for in-
527 stance, take place in the LLBNs or another layer of the SC.

528 Our experiment also provides evidence for a curvature away from the spatiotopic rep-
529 resentation of a previous fixation stimulus. A second revision of the models could then
530 add either a satellite structure, which would send spatiotopic signals to the SC/LLBN,
531 or a feedback mechanism, which would automatically shift the SC's signal when a sac-
532 cade occurred (find more discussion in the next section). It is important to note here
533 that the spatiotopic signal would project on the SC/LLBN with *excitatory* connections.
534 That may at first seem contradictive with the top-down inhibition theory, but it is not.
535 Indeed, in both the models of Wang et al. (2012, 2014) and Kruijine et al. (2014), the
536 curvature away is explained by local suppression (i.e., lateral inhibition or neural fa-
537 tigue) generated indirectly by an excitatory signal (i.e. a visual stimulus). In short, only
538 an *excitatory* signal can activate the inhibitory mechanism that causes the curvature
539 away in these models. To have fixation-related inputs from satellite bodies would echo
540 evidence that there are several mechanisms of fixation-related inhibition, including
541 cortical mechanisms (Sumner et al. 2006).

542 An Excitatory Spatiotopic Signal from the Lateral Intraparietal Area

543 One possible source for a top-down spatiotopic excitatory signal is the Posterior Pariet-
544 al Cortex (PPC) that connects to the SC mainly through the Lateral Intraparietal area
545 (Paré and Wurtz 1997). Using a double-step paradigm, Heide et al. (1995) have shown
546 that patients with damage to the PPC are impaired in executing their second saccade
547 when the second target is extinguished before the first saccade is initiated. In that situ-
548 ation, the second target has to be memorized and its retinal representation on the SC
549 needs to be shifted in accordance with the first saccade vector (that is the spatiotopic
550 update). Interestingly, patients with damage to the dorsolateral prefrontal cortex
551 (DPFC) or to the Frontal Eye Field (FEF) did not show such impairment (see also
552 (Rivaud et al. 1994; Schiller and Chou 1998). Finally, predictive remapping of a target
553 has been shown to occur in LIP (as well as the FEF), so that neurons respond to a tar-
554 get that will be in their receptive field after a saccade is completed (Goldberg and

555 Bruce 1990; Goldberg et al. 1990; Duhamel et al. 1992; Umeno and Goldberg 1997;
556 Kusunoki and Goldberg 2003). Neurophysiological work has demonstrated that such
557 predictive activations also occur in specific cells of the SCi, i.e., the quasivisual cells
558 (Mays and Sparks 1980; Walker et al. 1995). These findings support the possibility of a
559 spatiotopic excitatory update of the SCi: notably the LIP/FEF would be projecting pref-
560 erentially to the quasivisual neurons that, in turn, would reflect the activity of the
561 LIP/FEF.

562

563 Conclusion

564 We conclude that both residual activity from previous saccades and spatiotopic repre-
565 sentation of previously fixated stimuli can influence the trajectory of the current sac-
566 cade. This influence is translated into a trajectory curvature away from the previously
567 fixated stimulus. These findings call for current retinotopic models of curvature to up-
568 date and take into account spatiotopic representations and the motor history. We sug-
569 gest that the Lateral Intraparietal area would be a good candidate to provide excitatory
570 spatiotopic signal to the SC.

571

572 Acknowledgements

573 GM was supported by Cardiff University. CL was supported by the Engineering & Phys-
574 ical Sciences Research Council (Cross-Disciplinary Interfaces grant EP/I032622/1). PS
575 was supported by the ESRC (ES/K002325/1).

576 References

- 577 **Aizawa H, Wurtz RH.** Reversible inactivation of monkey superior colliculus. I. Curva-
578 ture of saccadic trajectory. *J Neurophysiol* 79: 2082–2096, 1998.
- 579 **Amari S.** Dynamics of pattern formation in lateral-inhibition type neural fields. *Biol*
580 *Cybern* 27: 77–87, 1977.

- 581 **Anderson AJ, Yadav H, Carpenter RHS.** Directional Prediction by the Saccadic Sys-
582 tem. *Curr Biol* 18: 614–618, 2008.
- 583 **Bays PM, Husain M.** Active inhibition and memory promote exploration and search of
584 natural scenes. *J Vis* 12: 8–8, 2012.
- 585 **Boon PJ, Theeuwes J, Belopolsky AV.** Updating visual–spatial working memory dur-
586 ing object movement. *Vision Res* 94: 51–57, 2014.
- 587 **Chang SW, Abrams RA.** Hand movements deviate toward distracters in the absence of
588 response competition. *J Gen Psychol* 131: 328–344, 2004.
- 589 **Chieffi S, Ricci M, Carlomagno S.** Influence of visual distractors on movement trajec-
590 tory. *Cortex* 37: 389–405, 2001.
- 591 **Cousineau D.** Confidence intervals in within-subject designs: A simpler solution to
592 Loftus and Masson’s method. *Tutor Quant Methods Psychol* 1: 42–45, 2005.
- 593 **Duhamel JR, Colby CL, Goldberg ME.** The updating of the representation of visual
594 space in parietal cortex by intended eye movements. *Science* 255: 90–92, 1992.
- 595 **Farrell S, Ludwig CJ, Ellis LA, Gilchrist ID.** Influence of environmental statistics on
596 inhibition of saccadic return. *Proc Natl Acad Sci* 107: 929–934, 2010.
- 597 **Freeman J, Ambady N.** MouseTracker: Software for studying real-time mental pro-
598 cessing using a computer mouse-tracking method. *Behav Res Methods* 42: 226–241,
599 2010.
- 600 **Goldberg ME, Bruce CJ.** Primate frontal eye fields. III. Maintenance of a spatially accu-
601 rate saccade signal. *J Neurophysiol* 64: 489–508, 1990.
- 602 **Goldberg ME, Colby CL, Duhamel J-R.** Representation of Visuomotor Space in the Pa-
603 rietal Lobe of the Monkey. *Cold Spring Harb Symp Quant Biol* 55: 729–739, 1990.
- 604 **Heide W, Blankenburg M, Zimmermann E, Kömpf D.** Cortical control of double-step
605 saccades: Implications for spatial orientation. *Ann Neurol* 38: 739–748, 1995.
- 606 **Hooge ITC, Frens MA.** Inhibition of saccade return (ISR): spatio-temporal properties
607 of saccade programming. *Vision Res* 40: 3415–3426, 2000.
- 608 **Hooge ITC, Over EA, van Wezel RJ, Frens MA.** Inhibition of return is not a foraging
609 facilitator in saccadic search and free viewing. *Vision Res* 45: 1901–1908, 2005.
- 610 **Howard LA, Tipper SP.** Hand deviations away from visual cues: Indirect evidence for
611 inhibition. *Exp Brain Res* 113: 144–152, 1997.

- 612 **Jonikaitis D, Belopolsky AV.** Target-Distractor Competition in the Oculomotor System
613 Is Spatiotopic. *J Neurosci* 34: 6687–6691, 2014.
- 614 **Kass RE, Raftery AE.** Bayes factors. *J Am Stat Assoc* 90: 773–795, 1995.
- 615 **Klein RM, MacInnes WJ.** Inhibition of return is a foraging facilitator in visual search.
616 *Psychol Sci* 10: 346–352, 1999.
- 617 **Koop GJ, Johnson JG.** Response dynamics: A new window on the decision process.
618 *Judgm Decis Mak* 6: 750, 2011.
- 619 **Koop GJ, Johnson JG.** The response dynamics of preferential choice. *Cognit Psychol* 67:
620 151–185, 2013.
- 621 **Kruijne W, Van der Stigchel S, Meeter M.** A model of curved saccade trajectories:
622 Spike rate adaptation in the brainstem as the cause of deviation away. *Brain Cogn* 85:
623 259–270, 2014.
- 624 **Kusunoki M, Goldberg ME.** The time course of perisaccadic receptive field shifts in
625 the lateral intraparietal area of the monkey. *J Neurophysiol* 89: 1519–1527, 2003.
- 626 **Ludwig CJ, Farrell S, Ellis LA, Gilchrist ID.** The mechanism underlying inhibition of
627 saccadic return. *Cognit Psychol* 59: 180–202, 2009.
- 628 **Mays LE, Sparks DL.** Dissociation of visual and saccade-related responses in superior
629 colliculus neurons. *J Neurophysiol* 43: 207–232, 1980.
- 630 **McPeck RM.** Incomplete Suppression of Distractor-Related Activity in the Frontal Eye
631 Field Results in Curved Saccades. *J Neurophysiol* 96: 2699–2711, 2006.
- 632 **McPeck RM, Han JH, Keller EL.** Competition Between Saccade Goals in the Superior
633 Colliculus Produces Saccade Curvature. *J Neurophysiol* 89: 2577–2590, 2003.
- 634 **McSorley E.** Time Course of Oculomotor Inhibition Revealed by Saccade Trajectory
635 Modulation. *J Neurophysiol* 96: 1420–1424, 2006.
- 636 **McSorley E, Haggard P, Walker R.** Distractor modulation of saccade trajectories: spa-
637 tial separation and symmetry effects. *Exp Brain Res* 155: 320–333, 2004.
- 638 **McSorley E, Haggard P, Walker R.** The spatial and temporal shape of oculomotor in-
639 hibition. *Vision Res* 49: 608–614, 2009.
- 640 **Morey RD, Rouder JN.** Bayes factor approaches for testing interval null hypotheses.
641 *Psychol Methods* 16: 406, 2011.
- 642 **Paré M, Wurtz RH.** Monkey posterior parietal cortex neurons antidromically activated
643 from superior colliculus. *J Neurophysiol* 78: 3493–3497, 1997.

- 644 **Posner MI, Cohen Y.** Components of visual orienting. *Atten Perform X Control Lang*
645 *Process* 32: 531–556, 1984.
- 646 **Quaia C, Optican LM.** Commutative saccadic generator is sufficient to control a 3-D
647 ocular plant with pulleys. *J Neurophysiol* 79: 3197–3215, 1998.
- 648 **Raftery AE.** Bayesian model selection in social research. *Sociol Methodol* 25: 111–164,
649 1995.
- 650 **Rivaud S, Müri RM, Gaymard B, Vermersch AI, Pierrot-Deseilligny C.** Eye move-
651 ment disorders after frontal eye field lesions in humans. *Exp Brain Res* 102: 110–120,
652 1994.
- 653 **Rodgers CK, Munoz DP, Scott SH, Paré M.** Discharge properties of monkey tecto-
654 reticular neurons. *J Neurophysiol* 95: 3502–3511, 2006.
- 655 **Rouder JN, Morey RD.** Default Bayes factors for model selection in regression. *Multi-*
656 *var Behav Res* 47: 877–903, 2012.
- 657 **Rouder JN, Morey RD, Speckman PL, Province JM.** Default Bayes factors for ANOVA
658 designs. *J Math Psychol* 56: 356–374, 2012.
- 659 **Rouder JN, Speckman PL, Sun D, Morey RD, Iverson G.** Bayesian t tests for accepting
660 and rejecting the null hypothesis. *Psychon Bull Rev* 16: 225–237, 2009.
- 661 **Schiller PH, Chou I-ha.** The effects of frontal eye field and dorsomedial frontal cortex
662 lesions on visually guided eye movements. *Nat Neurosci* 1: 248–253, 1998.
- 663 **Scudder CA, Kaneko CR, Fuchs AF.** The brainstem burst generator for saccadic eye
664 movements. *Exp Brain Res* 142: 439–462, 2002.
- 665 **Smith TJ, Henderson JM.** Facilitation of return during scene viewing. *Vis Cogn* 17:
666 1083–1108, 2009.
- 667 **Smith TJ, Henderson JM.** Does oculomotor inhibition of return influence fixation
668 probability during scene search? *Atten Percept Psychophys* 73: 2384–2398, 2011.
- 669 **Soetens E, Boer LC, Hueting JE.** Expectancy or automatic facilitation? Separating se-
670 quential effects in two-choice reaction time. *J Exp Psychol Hum Percept Perform* 11:
671 598–616, 1985.
- 672 **Sogo H, Takeda Y.** Effect of previously fixated locations on saccade trajectory during
673 free visual search. *Vision Res* 46: 3831–3844, 2006.
- 674 **Sumner P.** Inhibition versus attentional momentum in cortical and collicular mecha-
675 nisms of IOR. *Cogn Neuropsychol* 23: 1035–1048, 2006.

- 676 **Sumner P, Nachev P, Castor-Perry S, Isenman H, Kennard C.** Which visual pathways
677 cause fixation-related inhibition? *J Neurophysiol* 95: 1527–1536, 2006.
- 678 **Theeuwes J, Olivers CN, Chizk CL.** Remembering a location makes the eyes curve
679 away. *Psychol Sci* 16: 196–199, 2005.
- 680 **Tipper SP, Howard LA, Jackson SR.** Selective reaching to grasp: Evidence for distrac-
681 tor interference effects. *Vis Cogn* 4: 1–38, 1997.
- 682 **Tipper SP, Howard LA, Paul MA.** Reaching affects saccade trajectories. *Exp Brain Res*
683 136: 241–249, 2001.
- 684 **Umeno MM, Goldberg ME.** Spatial processing in the monkey frontal eye field. I. Pre-
685 dictive visual responses. *J Neurophysiol* 78: 1373–1383, 1997.
- 686 **Van der Stigchel S, Meeter M, Theeuwes J.** The spatial coding of the inhibition
687 evoked by distractors. *Vision Res* 47: 210–218, 2007.
- 688 **Van der Stigchel S, Theeuwes J.** Our eyes deviate away from a location where a dis-
689 tractor is expected to appear. *Exp Brain Res* 169: 338–349, 2006.
- 690 **Wagenmakers E-J.** A practical solution to the pervasive problems of p values. *Psychon*
691 *Bull Rev* 14: 779–804, 2007.
- 692 **Walker MF, Fitzgibbon EJ, Goldberg ME.** Neurons in the monkey superior colliculus
693 predict the visual result of impending saccadic eye movements. *J Neurophysiol* 73:
694 1988–2003, 1995.
- 695 **Walker R, McSorley E, Haggard P.** The control of saccade trajectories: Direction of
696 curvature depends on prior knowledge of target location and saccade latency. *Percept*
697 *Psychophys* 68: 129–138, 2006.
- 698 **Wang Z, Kruijne W, Theeuwes J.** Lateral interactions in the superior colliculus pro-
699 duce saccade deviation in a neural field model. *Vision Res* 62: 66–74, 2012.
- 700 **Wang Z, Satel J, Trappenberg TP, Klein RM.** Aftereffects of saccades explored in a
701 dynamic neural field model of the superior colliculus. *J Eye Mov Res* 4: 1–16, 2011.
- 702 **Wang Z, Theeuwes J.** Distractor Evoked Deviations of Saccade Trajectory Are Modu-
703 lated by Fixation Activity in the Superior Colliculus: Computational and Behavioral Ev-
704 idence. *PLoS ONE* 9: e116382, 2014.
- 705 **Welsh TN, Elliott D.** Movement trajectories in the presence of a distracting stimulus:
706 Evidence for a response activation model of selective reaching. *Q J Exp Psychol Sect A*
707 57: 1031–1057, 2004.

708 **Welsh TN, Elliott D, Weeks DJ.** Hand deviations toward distractors Evidence for re-
709 sponse competition. *Exp Brain Res* 127: 207–212, 1999.

710 **White BJ, Theeuwes J, Munoz DP.** Interaction between visual-and goal-related neu-
711 ronal signals on the trajectories of saccadic eye movements. *J Cogn Neurosci* 24: 707–
712 717, 2012.

713 **Zoest W van, Donk M, Van der Stigchel S.** Stimulus-salience and the time-course of
714 saccade trajectory deviations. *J Vis* 12: 16, 2012.

715

716

717

718

719

720

721

722

723

724

725 Figure Captions

726 **Figure 1: Description of the Stimulus Presentation.** The expressions F , S_1 and S_2 refer
727 to the Fixation Cross, stimulus 1 and stimulus 2, respectively. The expression ΔGap refers
728 to the duration of the gap between F and S_1 while $\Delta S1$ refers to the duration of $S1$
729 presentation. In A, only one of the Fixation stimuli — $F(\text{left})$ or $F(\text{right})$ — is shown dur-
730 ing a trial. The lines in gray and dashed gray are used to highlight the relative positions
731 between stimuli and were not presented to the participant.

732

733 **Figure 2: Predicted Effect of the Spatiotopic Representation of the Previous Fixa-**
734 **tion (F) and of the Motor Residual Activity from Saccade 1 (M) on Saccade 2's cur-**
735 **vature.** Although both mechanisms are expected to curve the second saccade (dashed
736 black line, in A and B) away from the previously fixated location, their time courses can

737 be used to distinguish between them (C). **In A**, the saccade curvature would be caused by
738 the memorized representation of F(left) (depicted as a black Gaussian gradient) while **in**
739 **B**, the saccade curvature would be caused by a residual trace of the Saccade 1 vector
740 (thick black arrow; the dotted gray curve is Saccade 1) during the execution of Saccade 2
741 (dotted black line). **In C**, we highlight that the time course of each mechanism is attached
742 to a different event in the trial. The time course of the effect of F (bright gray curve) is
743 linked to the Fixation offset (bright gray dashed vertical line). The time course of the ef-
744 fect of M (dark gray curve) is linked to Saccade 1 offset (dark dashed vertical line). Final-
745 ly, the curvature of Saccade 2 depends on the sum of the effect of F and M (white dots f
746 and m) at the time of Saccade 2 onset (thick black vertical line). In **Figure 3**, we will see
747 that varying Gap and S1 duration can allow us to distinguish between the two mecha-
748 nisms.

749

750 **Figure 3: How our Paradigm Distinguishes the Effects of Motor Residual Activity**
751 **(M) and of the Spatiotopic Representation of the Previous Fixation (F).** The para-
752 digm design can differentiate between an effect of F and M, and also between increasing
753 and decreasing time courses. **Row 1-4:** Each row represents a condition of our paradigm
754 while Columns 1 consider a time dependent effect of M with no effect of F and Columns 2
755 consider a time dependent effect of F with no effect of M. Column 3 considers an effect of
756 both F and M. The subplots used a similar representation as seen in **Figure 2C**. The effect
757 of M and F are represented, respectively by dark and bright gray curves (exponential
758 based in this example). The small gray boxes at the bottom represent the stimuli timing.
759 The bright dashed line, the dark dashed line and the solid thick line represents, respec-
760 tively the Fixation offset, the Saccade 1 offset and the Saccade 2 onset. The white dot is
761 particularly important as it represents the effect of M and F at Saccade 2 onset. **Row 5**
762 summarizes the height of the white dot in row 1-4 (i.e. the effect of M and F on Saccade
763 2's curvature at Saccade 2 onset) for each condition. A positive number denotes a curva-
764 ture away from previous fixation. It is important to note that the trend in condition
765 shortS1/longGap and longS1/shortGap (depicted with two dots linked by a black line) is
766 a good marker of an effect of M. This marker of M will not be affected if there is an effect
767 of F in any direction (i.e. if we sum the bars in Column 1 and 2 with the bars of Columns 3
768 or 4). Similarly, an effect of Gap duration (depicted with two dots linked by bright line) is
769 a good marker of an effect of F. Finally, if there is an effect of both M and F that goes in
770 the same direction (e.g. decreasing), the effect size of S1 duration should be greater than
771 the effect size of Gap duration.

772

773 **Figure 4: Effect of fixation side on the second saccade curvature.** The dark solid
774 curves and bars are associated with the condition where the Fixation was on the right,
775 while the brighter ones are associated with the left condition. **Left Panel:** the plot is
776 made from the data of one participant. The thin curves represent the distance from the
777 straight line (i.e. deviation) of the second saccade over time for each trial, per condition.
778 The thick and solid curves represent the average deviation across trials, per condition.

779 *The thick dashed line is the mean deviation across both left and right conditions. Nega-*
780 *tive values are on the left of the straight line while positive values correspond to the right.*
781 *The **initial deviation** reported in this paper corresponds to the deviation measured at 20*
782 *ms from the saccade onset (indicated by the horizontal dash line). From the histograms*
783 *of the initial deviation (bottom), it can be observed that the saccade in the right condi-*
784 *tion (dark bars) are deviating more leftward than the bright curves (bright bars). **Right***
785 *Panel: the solid dark and solid bright curves represent the average deviation from the*
786 *participant mean across all participants, when, respectively, the Fixation was presented*
787 *on the right and on the left. The vertical thick dashed lines in the left and right panels*
788 *represent the same thing; that is the participant average across left and right conditions.*

789

790 **Figure 5: Interaction Boxplots for the Inter-saccadic time between Saccade 1 and**
791 **Saccade 2 and for the time interval between Saccade 2 onset and Fixation offset.**

792 *Note that a within-subject correction (Cousineau 2005) was applied to the data to illus-*
793 *trate that the analysis treated the participant as a random effect. In both A and B, the*
794 *lower and upper hinges correspond to the first and third quartiles. The lower and upper*
795 *whisker extend from the hinge to the lowest/highest value within 1.5 times the inter-*
796 *quartile range, so that the trials beyond these whiskers—plotted as points—can be con-*
797 *sidered as outliers of a normal distribution. The lines are connecting the mean of the dis-*
798 *tributions.*

799

800 **Figure 6: Summary of the Analyzed Data.** Error bars display the within-subject 95%
801 confidence intervals. Note that IDD_{LR} stands for the difference in initial deviation between
802 the conditions Fixation Left and Fixation Right.

803

804 **Figure 7: Estimation of the non-standardized effect size of Gap and S1 duration on**
805 **IDD_{LR}** (i.e. the difference in initial deviation between Left and Right Fixation conditions).
806 We plotted the distribution of the non-standardized effect size of S1 and Gap duration
807 from sampling 10,000 points from the posterior distribution of the best model (see main
808 text). Two observations can be made: 1) both S1 and Gap duration have a negative effect
809 on IDD_{LR} (i.e. as we increase Gap or S1 duration, the distribution shift leftward), and 2)
810 the effect of Gap duration on IDD_{LR} seems smaller than the effect of S1 duration. **Top:**
811 Kernel density bandwidth of 3.816e-03. **Bottom:** kernel density bandwidth of 1.533e-03.

812

813 Tables

814 **Table 1:** Bayes factor top-down analysis on Initial Difference in Deviation (Left-Right).

| | Effect of Omission | BF or 1/BF | Polarity | Interpretation Tag |
|-----|---|--------------|----------|--------------------|
| [1] | $\Delta\text{Gap}:\Delta\text{S1}:\text{Participant}$ | 1.02 ±5.26% | none | weak |
| [2] | $\Delta\text{Gap}:\text{Participant}$ | 3.88 ±4.26% | against | positive |
| [3] | $\Delta\text{S1}:\text{Participant}$ | >1000 ±4.65% | in favor | very strong |
| [4] | $\Delta\text{Gap}:\Delta\text{S1}$ | 2.37 ±5.96% | against | weak |
| [5] | Participant | >1000 ±5.19% | in favor | very strong |
| [6] | ΔGap | 5.1 ±6.07% | in favor | positive |
| [7] | ΔS1 | 4 ±4.46% | in favor | positive |

815 *Note. We inversed (1/BF) the BFs less than 1 for easier reading. We add a Polarity col-*
816 *umn that tells if the evidence is against or in favor of an effect of the omitted variable. BF*
817 *against the full model: $IDD_{LR} \sim \Delta\text{S1} + \Delta\text{Gap} + \text{Participant} + \Delta\text{S1}:\Delta\text{Gap} + \Delta\text{S1}:\text{Participant}$*
818 *+ $\Delta\text{Gap}:\text{Participant} + \Delta\text{S1}:\Delta\text{Gap}:\text{Participant}$. Where IDD_{LR} stands for the difference in ini-*
819 *tial deviation between the conditions Fixation Left and Fixation Right.*

820

821

822

823

A - Stimuli Spatial Organization

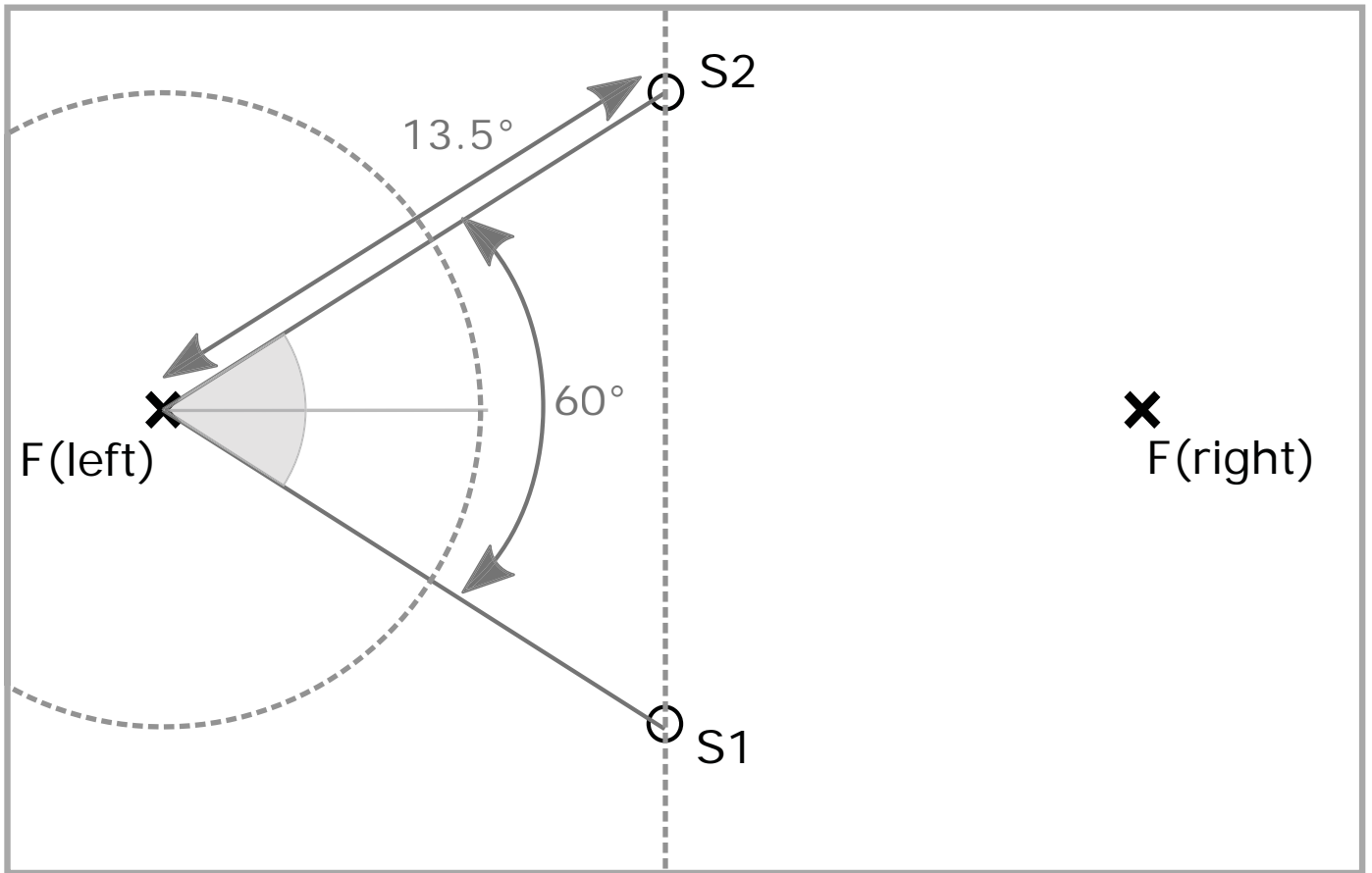

B - Stimuli Time Onset-Offset

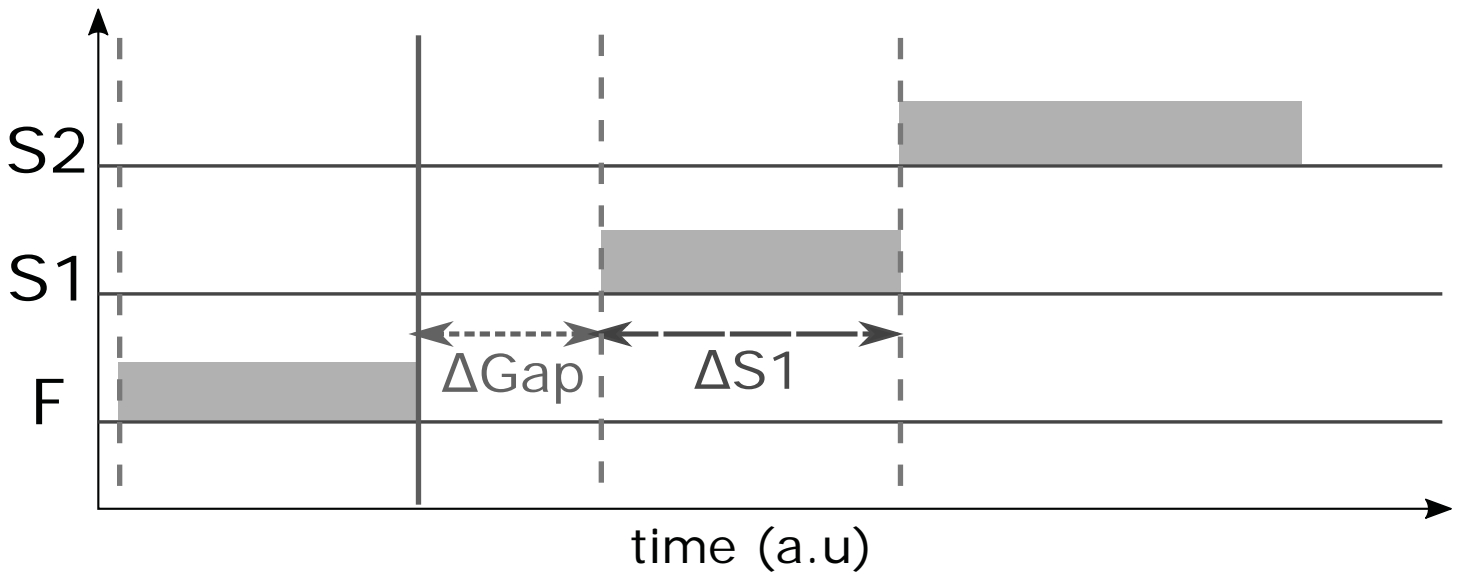

A Spatiotopic Representation of the Previous Fixation (F)

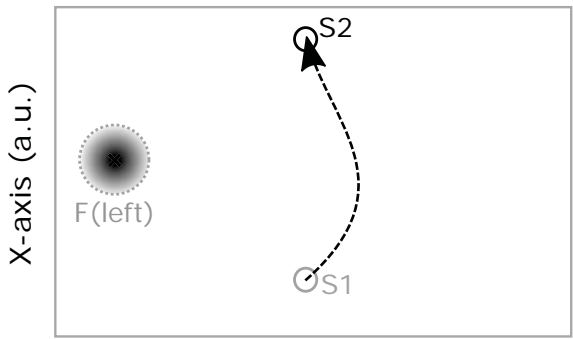

B Motor Residual Activity (M)

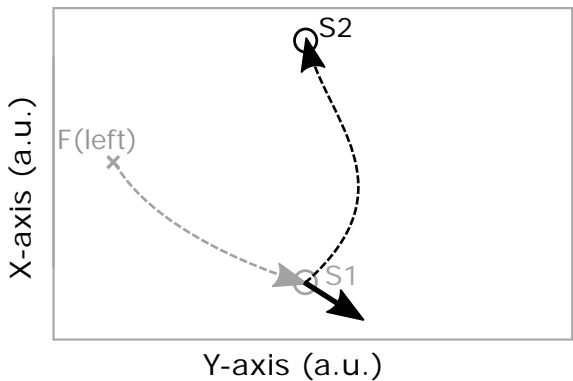

C Example of Time Course of F and M Effects Through a Trial

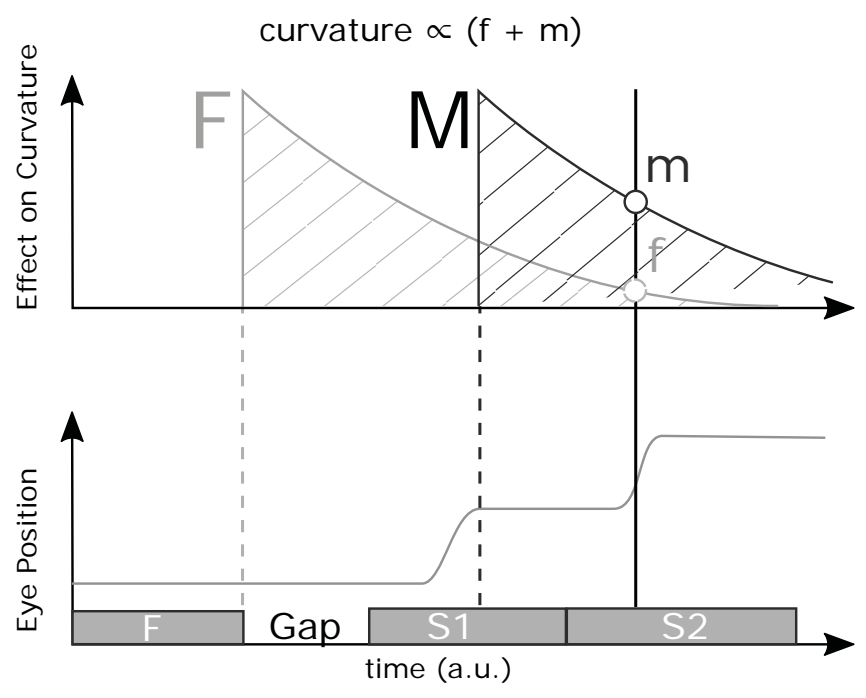

Time Courses for the Different Conditions

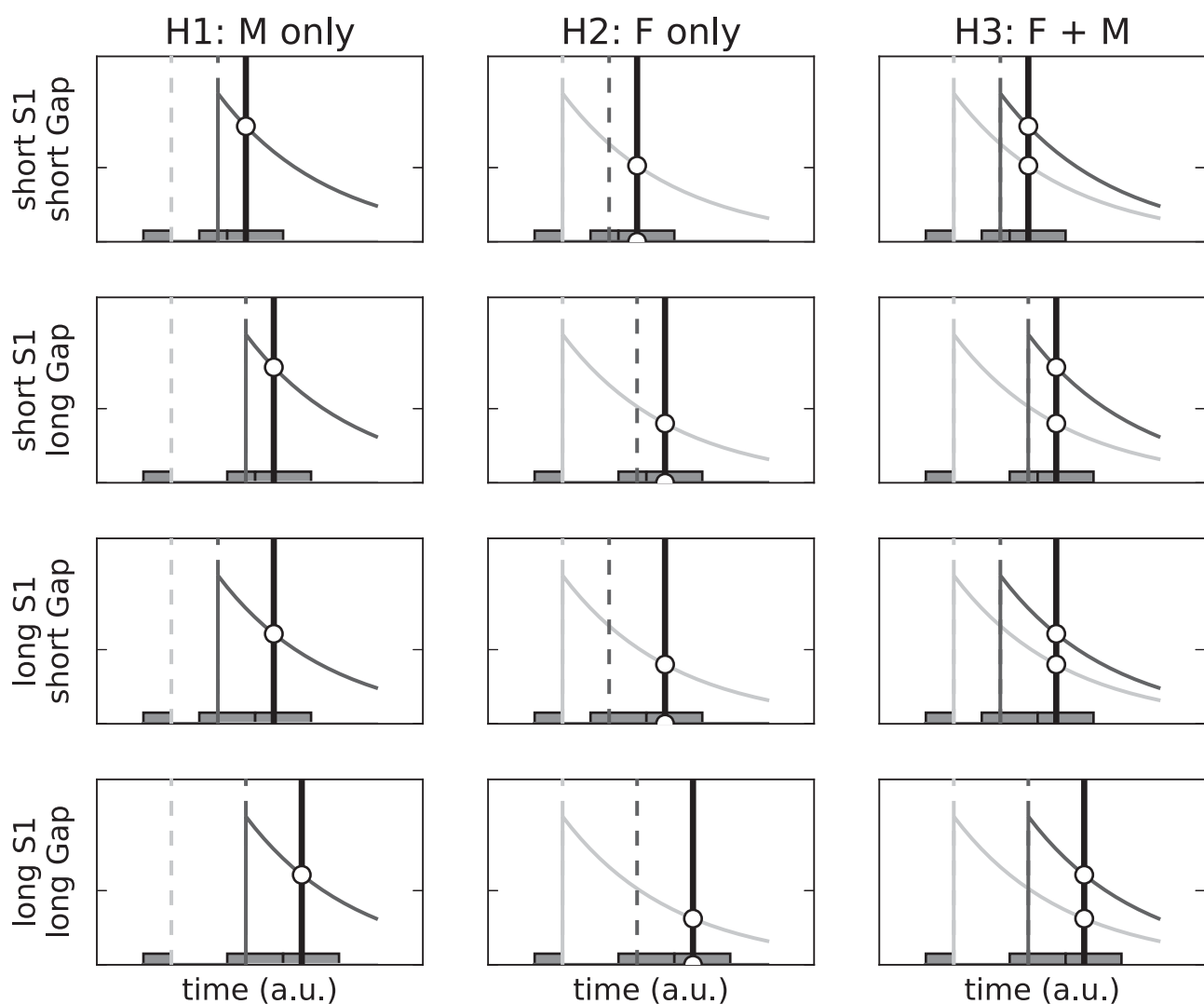

Predicted Effect on Saccade Curvature

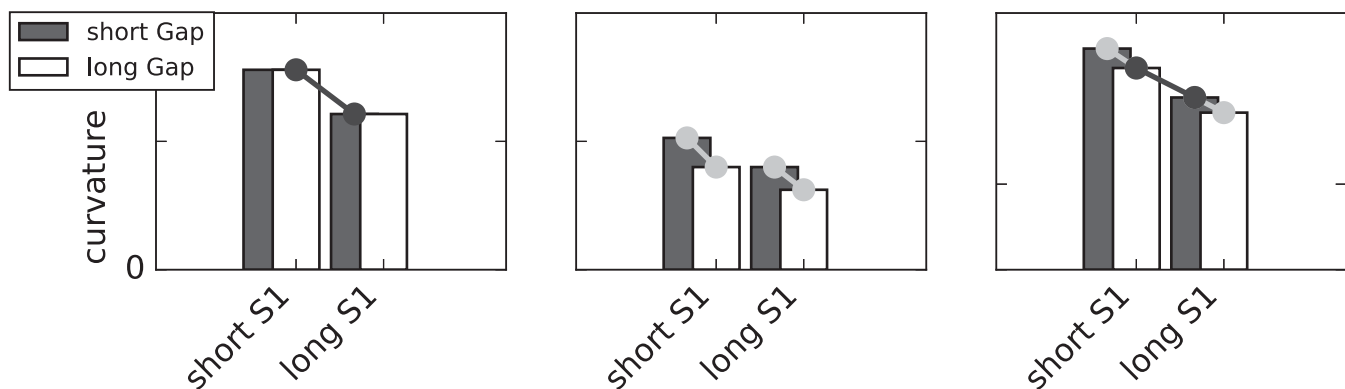

Participant F1

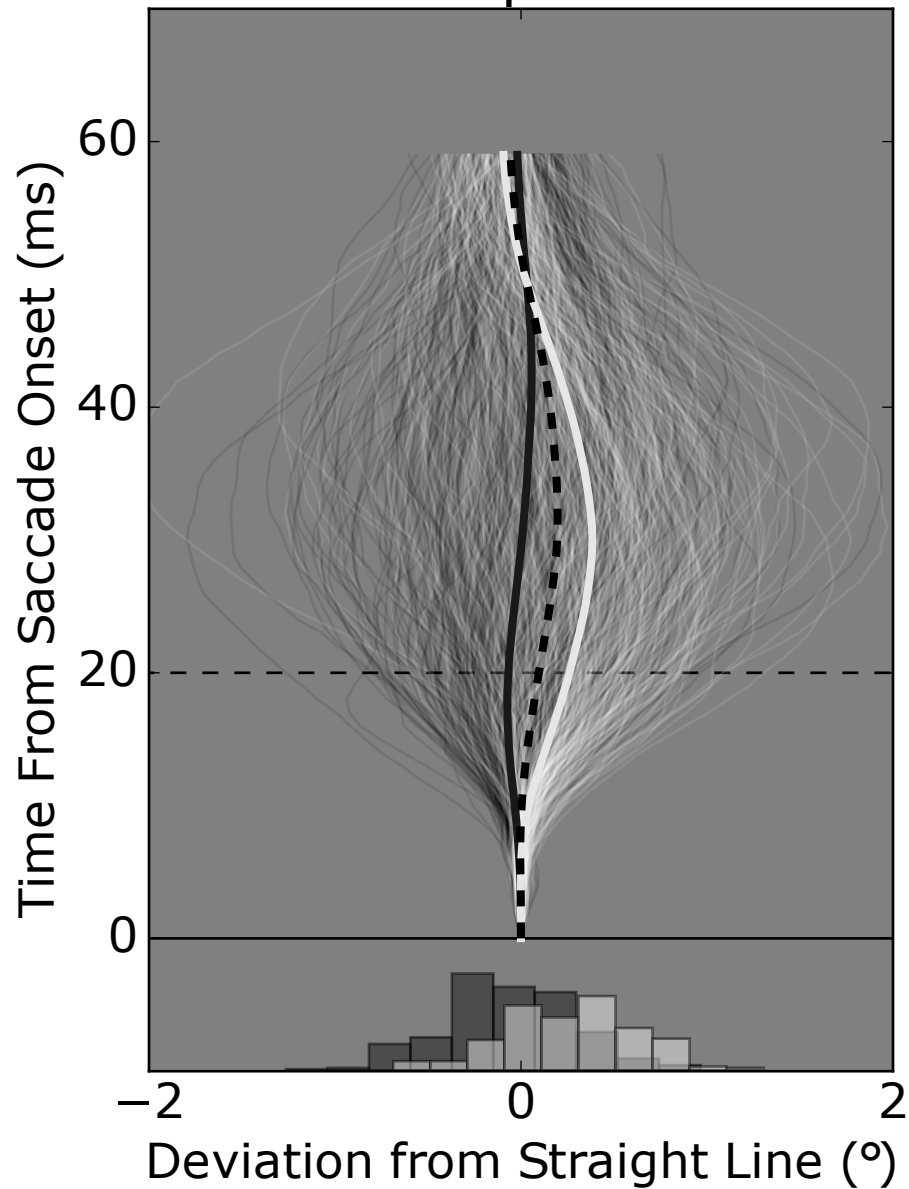

All Participants

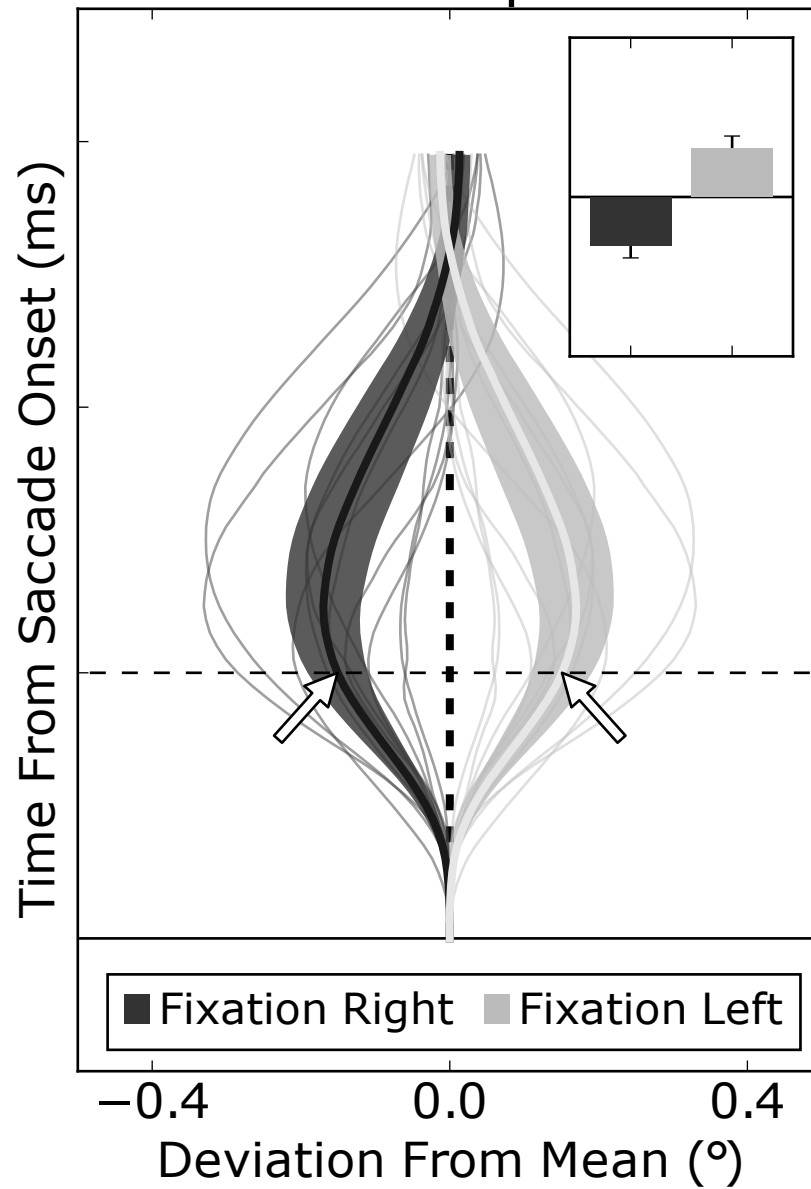

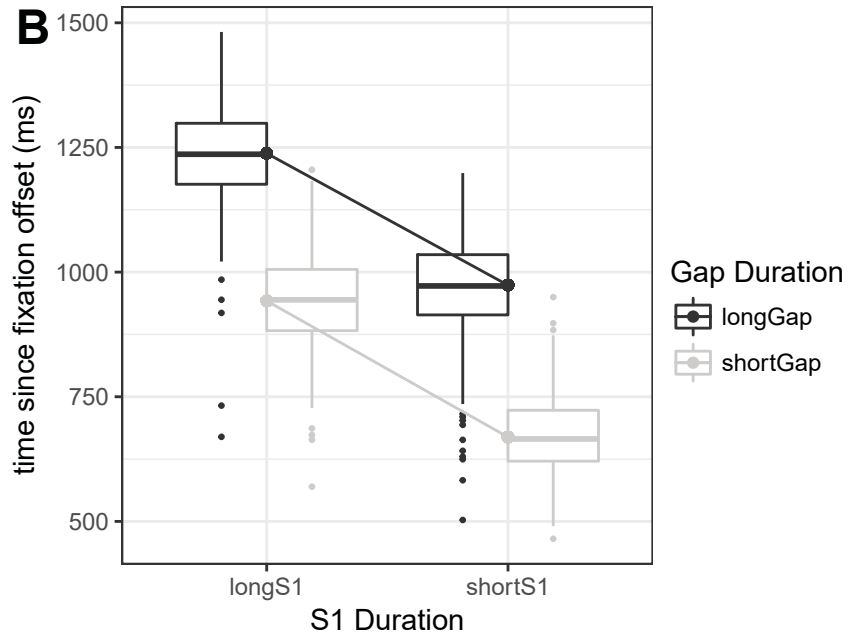
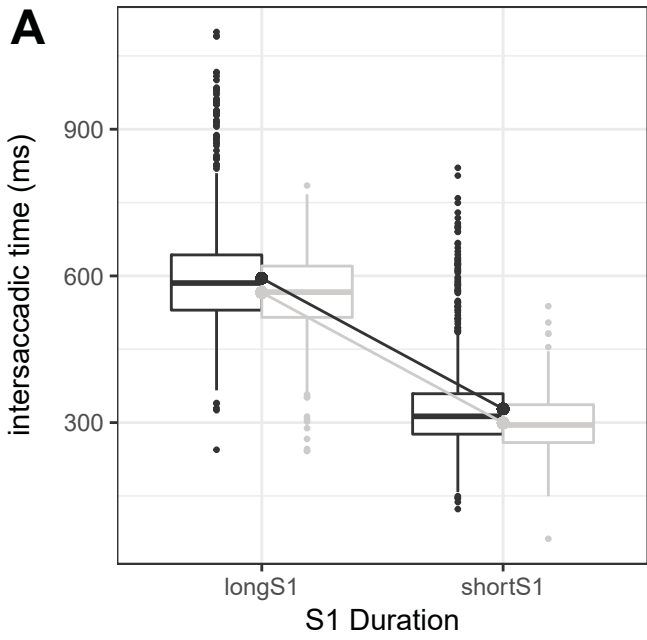

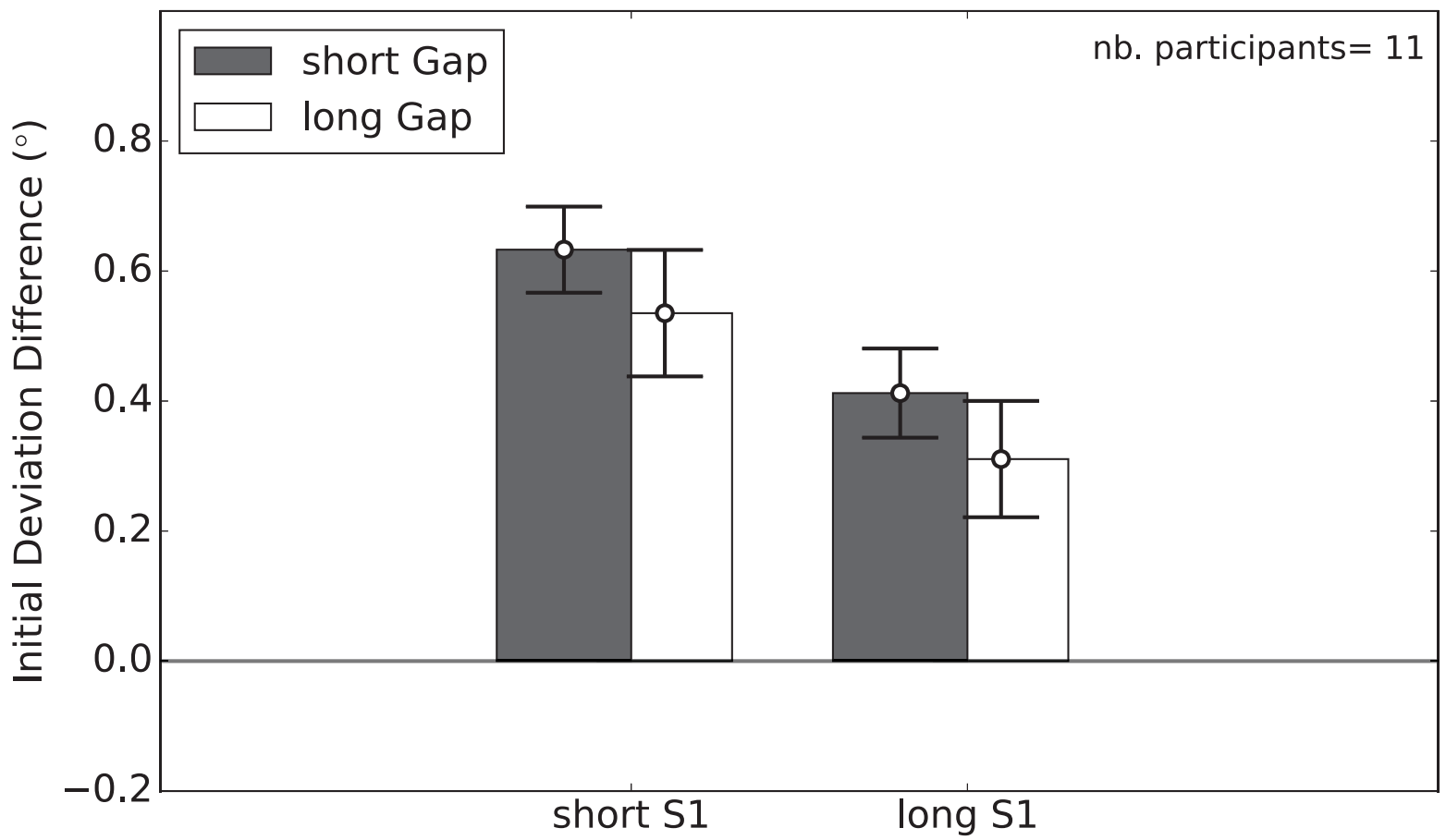

Posterior Distribution of the initial Deviation for S1 duration

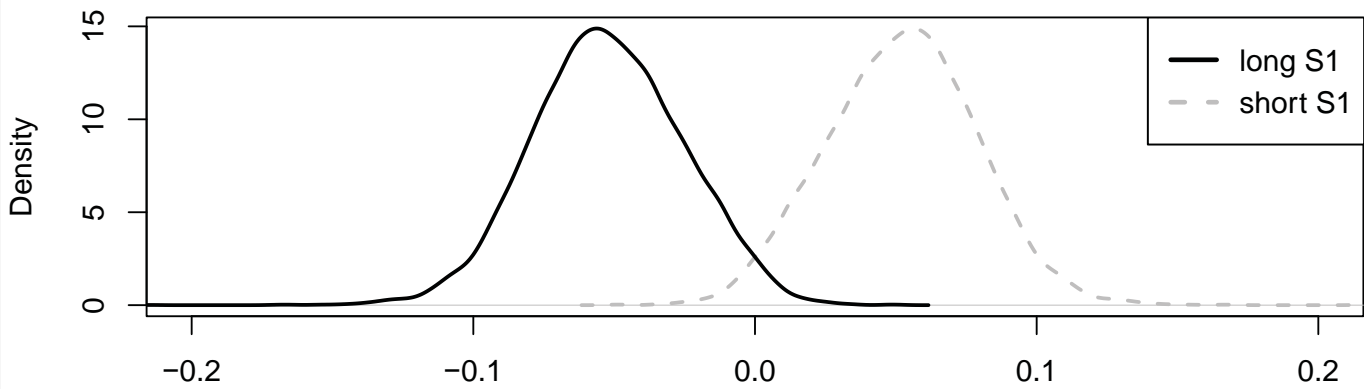

Posterior Distribution of the initial Deviation for Gap duration

