



UNIVERSITY OF LEEDS

This is a repository copy of *Principal stress rotation under bidirectional simple shear loadings*.

White Rose Research Online URL for this paper:
<http://eprints.whiterose.ac.uk/122561/>

Version: Accepted Version

Article:

Li, Y, Yang, Y, Yu, H-S et al. (1 more author) (2018) Principal stress rotation under bidirectional simple shear loadings. *KSCE Journal of Civil Engineering*, 22 (5). pp. 1651-1660. ISSN 1226-7988

<https://doi.org/10.1007/s12205-017-0822-4>

© 2017, Korean Society of Civil Engineers. This is an author produced version of a paper published in *KSCE Journal of Civil Engineering*. The final publication is available at Springer via <https://doi.org/10.1007/s12205-017-0822-4>. Uploaded in accordance with the publisher's self-archiving policy.

Reuse

Items deposited in White Rose Research Online are protected by copyright, with all rights reserved unless indicated otherwise. They may be downloaded and/or printed for private study, or other acts as permitted by national copyright laws. The publisher or other rights holders may allow further reproduction and re-use of the full text version. This is indicated by the licence information on the White Rose Research Online record for the item.

Takedown

If you consider content in White Rose Research Online to be in breach of UK law, please notify us by emailing eprints@whiterose.ac.uk including the URL of the record and the reason for the withdrawal request.



eprints@whiterose.ac.uk
<https://eprints.whiterose.ac.uk/>

Specialized field: Geotechnical Engineering

Title: Principal Stress Rotation under Bidirectional Simple Shear Loadings

Authors: Li, Yao¹; Yang, Yunming²; Yu, Hai-Sui³; Roberts, Gethin⁴

Affiliations:

¹ Lecturer, School of Highway, Chang'an University. Formerly PhD student at International Doctoral Innovation Centre, The University of Nottingham Ningbo China. Middle Section of Nan Er Huan Road, Xi'an, China. E-mail: Yao.Li@chd.edu.cn

² Associate Professor, Department of Civil Engineering, Ningbo Nottingham New Materials Institute, The University of Nottingham Ningbo China, 199 Taikang East Road, Ningbo, China. Tel: +86 (0)574 88182407. Fax: +86 (0)574 88180175. E-mail: Ming.yang@nottingham.edu.cn

³ Professor, School of civil engineering, University of Leeds, Leeds LS2 9JT, UK. E-mail: h.yu@leeds.ac.uk

⁴ Professor, Department of Civil Engineering, The University of Nottingham Ningbo China, 199 Taikang East Road, Ningbo, China. E-mail: Gethin.roberts@nottingham.edu.cn

*Corresponding author: Yang, Yunming, Tel: +86 (0)574 88182407. Fax: +86 (0)574 88180175. E-mail: Ming.yang@nottingham.edu.cn

ABSTRACT

Previous researches have indicated the non-coaxiality of sand in unidirectional simple shear tests, in which the direction of the principal axes of stresses does not coincide with the corresponding principal axes of strain rate tensors. Due to the limitation of apparatus that most of testing facilities can only add shear stress in one direction, the influence of stress history on the noncoaxiality of sand is not fully considered in previous tests. In this study, the effect of stress history on the non-coaxiality of sand is systematically studied by using the first commercially available Variable Direction Dynamic Cyclic Simple Shear system (VDDCSS). Samples of Leighton Buzzard sand (Fraction B) are first consolidated under a vertical confining stress and consolidation shear stress, and then sheared by a drained monotonic shear stress. Angle (θ) between the consolidation shear stress and the drained monotonic shear stress is varied from 0° to 180° , with an interval of 30° . The change of principal axes of stresses is predicted by well-established equations, and the principal axis of strain rate is calculated using recorded data. Results show that the level of non-coaxiality is increased by the increasing θ , especially at the initial stage of drained shearing.

Keywords

Principal stress rotation, noncoaxial behavior, simple shear, sand, orientation of principal stress

1. INTRODUCTION

In classical theory of plasticity, the principal axes of stresses and plastic strain rate are generally coincident (Hill, 1950). However, numerous studies have suggested that in granular materials these principal axes often do not coincide (Roscoe et al, 1967; Drescher and de Jong, 1972; Arthur et al, 1977; Budhu, 1979; Yu, 2006). Generally, this deviation between these axes decreases with increasing shear stress level (Gutierrez et al, 1991), and these axes coincide after maximum shear stress ratio or minimum volume is reached (Roscoe, 1967; Oda and Konishi, 1974). Hence, the non-coaxiality has been considered as a crucial factor in understanding soil behavior and developing constitutive soil models. In numerical studies, results show that geotechnical designs without considering the non-coaxiality may be unsafe (Yu and Yuan, 2006; Yang and Yu, 2006).

In geotechnical testing, several apparatuses have been widely used in investigating the principal stress rotation, such as the hollow cylinder apparatus, direct shear apparatus, and direct simple shear apparatus. There are a huge number of experimental data available by using these facilities under various loading conditions. For example, Roscoe et al. (1967) reported the non-coaxiality in simple shear tests, and showed that the level of non-coaxiality is very significant at the initial stage of shearing and the level of the non-coaxiality is decreased at a higher shear strain. Wong and Arthur (1986) observed the non-coaxiality in direct shear tests, and the greatest deviation between the two axes is greater than 30° under the continuous rotation of the principal stress axes. Miura et al. (1986) observed the non-coaxiality in both monotonic and rotational shear tests, and reported that the non-coaxiality is a result of the initial anisotropy of sand. Similar tests conducted by Gutierrez et al. (1991) showed that the direction of plastic strain increment depends on the direction and magnitude of stress, and the direction of stress increment. However, the effect of direction and magnitude of stress cannot be systematically studied by using these apparatuses. This is due to the limitation of these apparatuses, in which only one shear stress can be exerted on a soil sample. In most geotechnical problems, soil is often subjected to shear stresses acting in different directions, such as in embankments under earthquake strike. The gravity of an embankment generates a static driving force acting along the slope, and an horizontal earthquake strike generates another shear stress acting in a random direction.

Over the last few decades, many efforts have been focused on the laboratory testing using a bidirectional simple shear apparatus (Jaime, 1975.; Casagrande and Rendon, 1978. and Ishihara and Yamazaki, 1980; Boulanger et al, 1993; DeGroot et al, 1993; Rutherford, 2012). Unfortunately, only few apparatuses can successfully control the boundary condition. This is mainly due to the difficulties in designing an apparatus that can perform multi-directional shearing, and there are many serious problems on existing bi-directional simple shear apparatus, such as rocking and pinching problem (Ishihara and Yamazaki, 1980). In addition, these apparatuses developed by researchers have not been widely used.

A limited number of NGI-type bidirectional simple shear apparatuses have been used to investigate the effect of consolidation shear stress (static driving shear stress) on the undrained shear behavior (Boulanger et al, 1993; DeGroot et al, 1993; Biscontin, 2001; Kammerer, 2002; Rutherford, 2012). In these studies, the static driving shear stress is introduced to duplicate the stress state of the soil under a slope or foundation, and its magnitude depends on the inclination of a slope or structure weight respectively. Static (monotonic) undrained shear stress represents horizontal forces like ice loading on an

offshore arctic gravity structure, and cyclic undrained shear stress represents seismic loadings like transverse earthquake strike. DeGroot et al (1993), Biscontin (2001) and Rutherford (2012) studied the effect of consolidation shear stress on clay in monotonic bidirectional simple shear tests. Boulanger et al (1991a, 1991b), Boulanger and Seed (1995) and Kammerer (2002) studied the effect of consolidation shear stress on sand in cyclic bidirectional simple shear tests. In these studies, specimens are first consolidated under a vertical stress and shear stresses along different directions, and then sheared in undrained condition along a fixed direction. Results in these studies show that the angle between consolidation shear stress and shear stress has a significant effect on stress-strain responses. The lowest strength occurs in tests with angles around 90° , and the highest strength is at 0° . In addition, Kammerer (2002) concluded that the rotation of principal stress and stress reversal have a profound influence on excess pore water generation and the development of shear strain. However, in those bidirectional simple shear tests, the non-coaxiality is not considered. This is due to the difficulties in interpreting the stress state in the NGI-type simple shear tests.

In NGI-type simple shear apparatuses, including the NGI-type bidirectional simple shear, there is a salient limitation: the horizontal stress cannot be accurately measured. Although many studies have been focused on measuring the lateral stress using highly instrumented simple shear devices in NGI-type simple shear apparatuses, the measured results are not satisfactory (Roscoe, 1970; Budhu, 1979; Airey et al., 1985; Airey and Wood, 1987). On the contrary, in another type of simple shear apparatus, Cambridge-type simple shear apparatus, the complete distribution of boundary stresses are measured by an array of load cells, and then corresponding stress state can be computed (Budhu 1979 and Wood et al 1979). However, the complexity of performing a test using the apparatus limited the use of the Cambridge-type apparatus. In addition, due to the geometry of sample and constrains in the Cambridge-type simple shear apparatus, bidirectional shear loadings cannot be added (Kammerer, 2002). As a result, the less complex and expensive NGI-type simple shear apparatus is more popular in geotechnical testing. To determine the stress state in NGI-type simple shear testing, several interpretation methods have been proposed and tested (Budhu, 1979; Wood et al, 1980; Budhu, 1988; Kang, 2015), and the method described by Budhu (1979) shows a good agreement with the measured values in Cambridge-type device.

The aim of this study is to investigate the non-coaxiality in bidirectional simple shear tests on sand. The first commercially available NGI-type multidirectional simple shear apparatus is used in this study. This new apparatus is manufactured by GDS (Global Digital Systems) Instruments Ltd. UK, and GDS has solved many problems in previously apparatus developed at universities, such as the nonuniformity problem, rocking and pinching problem. It is an NGI-type bidirectional simple shear apparatus, and shear stresses in any horizontal directions can be exerted on a sample. By using the stress state interpretation method described by Budhu (1975), the level of non-coaxiality under sloping conditions is studied. In this study, Leighton Buzzard sand Fraction B is tested in drained monotonic simple shear tests, with consolidation shear stresses in different magnitudes and directions. The effect of vertical stress, relative density, and stress history on the shear behavior and non-coaxiality are systematically analyzed.

2. THE SIMPLE SHEAR TESTS

2.1 Testing Facility and Material

In the VDDCSS, shear stress can be applied by stress-control or strain-control method. Instead of additional hydraulic power packs, pressure controllers or control boxes, the VDDCSS uses three electro-mechanical actuators which helps the equipment operate more stably. Vertical (normal) stress on the cylindrical soil specimen is applied by a vertical actuator, and horizontal (shear) stresses are applied by two prependicular horizontal actuators. The secondary shear actuator that prependicular to the primary shear actuator enables the VDDCSS to apply shear stress in any horizontal directions, as shown in Figure 1. More details of this apparatus are introduced by Li et al. (2017a).

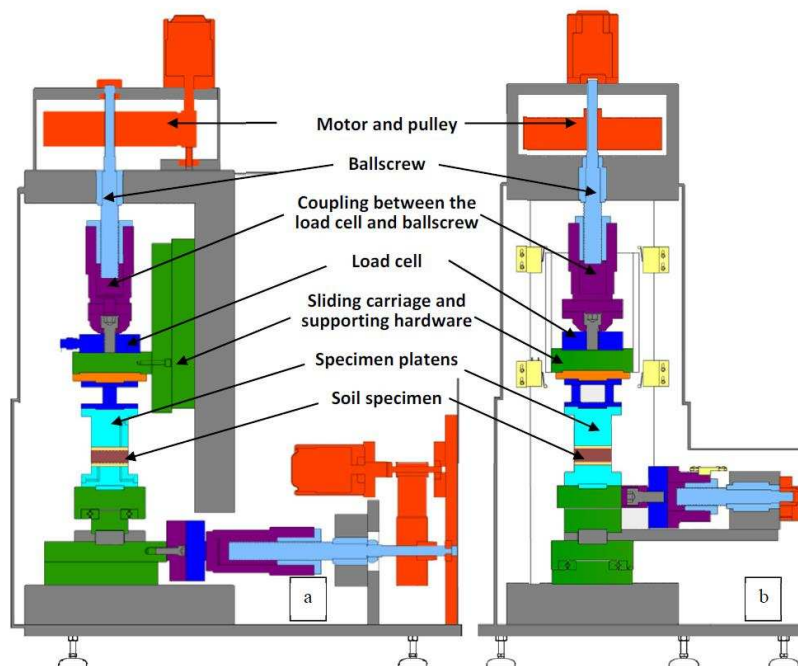

Figure 1: Schematic diagram of operation mechanism (a) XZ plane, (b) YZ plane (Li et al., 2017a)

Cylindrical specimens with the height of 17 mm and diameter of 70 mm are tested. The high diameter to height ratio minimizes the non-uniformity of stress and strain (Boulanger and Seed, 1995; Kim, 2009). A stack of low-friction Teflon coated rings with 1 mm high each is placed outside membrane of the specimen. Figure 2 shows the sectional details of a soil specimen.

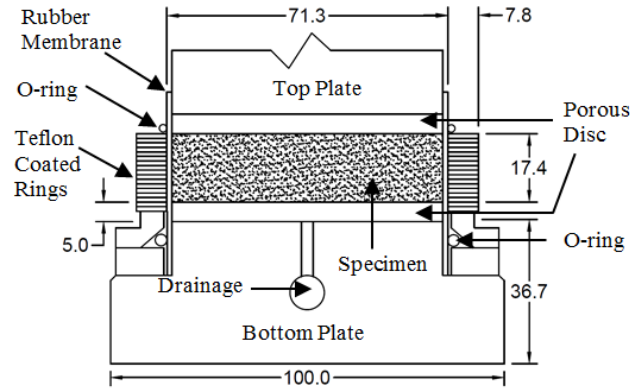

Figure 2 Sectional details of a specimen (Li et al., 2017a)

Leighton Buzzard sand (Fraction B) is used in this study. Figure 3 shows its grading curve . Its maximum and minimum void ratios are 0.79 and 0.46, respectively (Alsaydalani and Clayton, 2014). It has been extensively studied by numerous research institutes including Nottingham Centre for Geomechanics (NCG) (Cai, 2011; Yang, 2013). Samples are prepared by dry deposition technique (Li et al., 2017b).

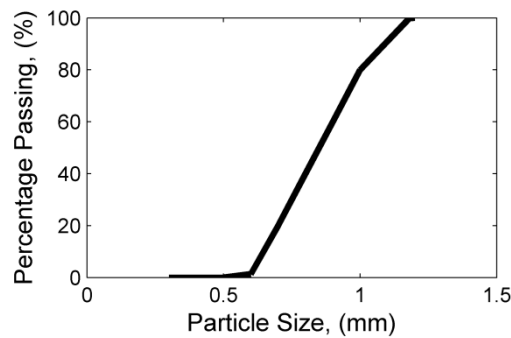

Figure 3 Grading curve of Leighton Buzzard sand (Fraction B) (Li et al., 2017)

A static shear stress is exerted on a specimen during consolidation, followed by the second drained shear stress until failure of the sample, as shown in Figure 4. Depending on the tests, the direction of the consolidation shear stress varies at different tests, from 0° to 180° with an interval of 30° . The second drained shear is always along x direction, and the shearing rate is at 0.1 mm/min. In the following test results presented, the shear strain means that along x direction unless specified otherwise. Two different magnitudes of shear stress during consolidation are considered in all directions, which gives a ratio to the initial vertical stress, named as the consolidation shear ratio (CSR), at 0.1 and 0.2, respectively. Table 1 summarizes the details of performed tests. All tests are terminated after the effective vertical stress drops below 10 percent of the initial vertical stress. This is because the existence of shear stress prevents the effective vertical stress from reaching zero (Ishihara & Yamazaki, 1980; Kammerer, 2002).

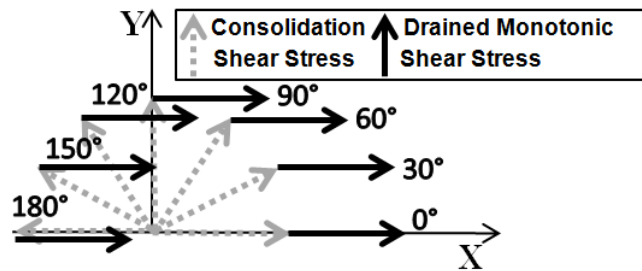

Figure 4 Stress paths of tests with different stress histories

Table.1 Test conditions of drained simple shear tests

Test series	Relative Density (Dr, %)	Vertical Stress (σ_{vc} , kPa)	Direction of the consolidation shear stress (θ , °)	Magnitude of shear consolidation (CSR)
Effect of vertical stress	68	100	N/A	0
		200		
		400		
Effect of relative density	30	200	N/A	0
	48			
	67			
Tests with Various Directions of Shear Consolidations	68	200	0	0.1
			30	
			60	
			90	
			120	
			150	
			180	

2.2 Interpretation of Stress State in Uni-Directional Simple Shear Tests

Several approaches have been developed for interpreting the stress state in traditional NGI-type simple shear testing. The first approach assumes that the horizontal plane of the apparatus x-y is the plane of maximum stress obliquity, as shown in Figure 5 (a). This approach implies that the maximum principal stress axis is $(\pi/4+\phi/2)$ to the vertical direction. However, previous experiments show that the value of ψ is never reached, and the horizontal plane of the apparatus x-y is not the plane of maximum stress obliquity (Budhu, 1988). The second approach assumes that the horizontal plane of the apparatus is the plane of maximum shear stress, as shown in Figure 5 (b). This indicates that the two conjugate shear plane at $\phi/2$ and $(\pi/4- \phi /2)$ must be satisfied in Mohr-Coulomb criterion, which gives a ψ of 45° .

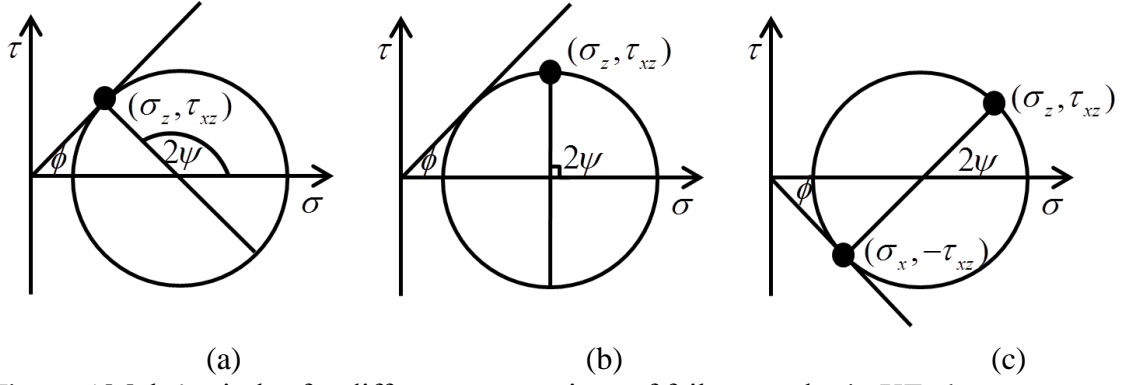

Figure 5 Mohr's circles for different assumptions of failure modes in XZ plane

The third method of predicting stress state in a NGI-type simple shear apparatus is built on the experimental results using Cambridge-type simple shear apparatus (Stroud, 1971; Budhu, 1980, Wood, 1979; Kang et al., 2015). This method is adopted to interpret the stress state in this study, and it is named as Cambridge-NGI method in this paper. In a series of constant load tests with different stress paths, stress levels and relative densities using 14/25 Leighton Buzzard sand, the normalized shear stress ($\frac{\tau}{\sigma_{vc}}$) is found proportional to $\tan \psi$, as shown in

Figure 6, in which τ is the measured shears tress, σ_{vc} is the vertical stress and ψ is the inclination angle of principal stress to the vertical. Wood et al. (1979) shows that,

$$\frac{\tau}{\sigma_{vc}} = k \tan \psi \quad (1)$$

In which k is a constant. This relation gives a Mohr circle as shown in Figure 5 (c). Principal stresses and horizontal stress in the NGI-type simple shear apparatus can be formulated from the Mohr circle:

$$\sigma_1 = \frac{k\sigma_v^2 + \tau^2}{k\sigma_v} \quad (2)$$

$$\sigma_3 = (1-k)\sigma_v \quad (3)$$

$$\sigma_x = \frac{\tau^2}{k\sigma_v} + (1-k)\sigma_v \quad (4)$$

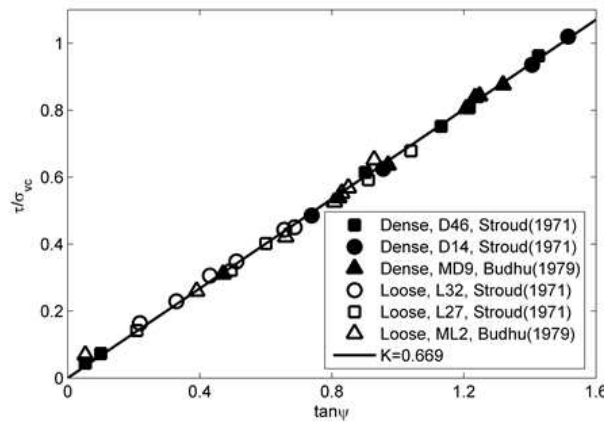

Figure 6 Linear relation between $\frac{\tau}{\sigma_{vc}}$ and $\tan \psi$

The interpreted stress state shows a good agreement with measured data in Cambridge-type simple shear (Budhu, 1979). In the Cambridge-NGI method, the physical meaning of k is not clear, and it may relate to the interparticle friction angle (Budhu, 1979; Oda, 1974). Budhu (1979) proposed an experimental method to determine the value of k . This method assumes that the principal axes of stresses and strain increment coincide at maximum normalized shear stress, which gives:

$$k = \left| \frac{\tau_{\max}}{\sigma_{vc}} \cot \xi \right| \quad (5)$$

In which ξ is the rotation angle of principal axes of strain increment. In constant load tests, σ_{vc} is a constant value, τ_{\max} is a measured value. ξ can be determined by considering a Mohr's circle of strain increment as shown in Figure 7. It can be seen in the Figure 7, when the volumetric strain reaches its maximum value ($\dot{\epsilon}_z=0$), $2\xi=90^\circ$, indicating the maximum angle of ξ is 45° . This method gives a reasonable prediction for the results of Cole (1967), Stroud (1971), and Budhu (1979). Using the Cambridge-NGI method, the degree of non-coaxiality, in terms of deviation between principal axes of stresses and strain increment can be determined. However there are several uncertainties of this method that limit the use of this method. The linear relation between $\frac{\tau}{\sigma_{vc}}$ and $\tan \psi$ is found in constant load tests, so

this method cannot be directly used in constant volume tests. This method is only tested on Leighton buzzard sand, there is no reference for tests using other materials.

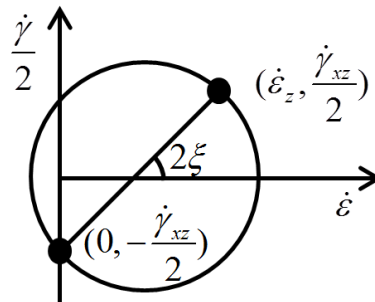

Figure 7 Mohr's circle of strain increment in XZ plane

3. RESULTS

The effect of confining stress (σ_{vc}) and relative density (Dr) on the shear behaviour are presented first, which provides a fundamental understanding of drained shear behaviour. Then the effect of stress history is demonstrated. In each series of tests, the change of non-coaxiality is discussed, with the focus on the rotation of principal axes of stresses (ψ) and strain increment (ξ), using the Cambridge-NGI method. There are two ways of interpreting the stress state in multidirectional simple shear tests using the Cambridge-NGI method. One way is to focus on the shear stress in the direction of the drained monotonic shear stress, and the other way is to interpret the stress state in terms of total shear stress.

3.1 The Effect of Confining Stress

In this series of tests, the relative density of samples is carefully controlled at around 48% after consolidation, and vertical confining stresses are 100 kPa, 200 kPa, and 400 kPa, respectively. Figure 8 shows the development of the normalized shear stress. At the same

relative density, the increasing effective vertical stress decreases the peak normalized shear stress, and the peak normalized shear stress is reached at around the shear strain of 40% for all the tests. Figure 9 shows the development of volumetric strain. The test with the effective vertical stress of 100 kPa shows dilative tendency, in which the volumetric strain decreases after reaching the shear strain of 15%. The tests with 200 kPa and 400 kPa effective vertical stresses show contractive behaviour during shearing. Generally, increasing vertical stress increases the contractive tendency, and results in a greater volumetric strain.

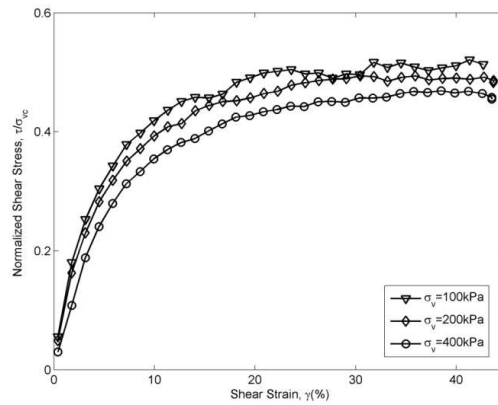

Figure 8 Development of the normalized shear stresses under different vertical stresses

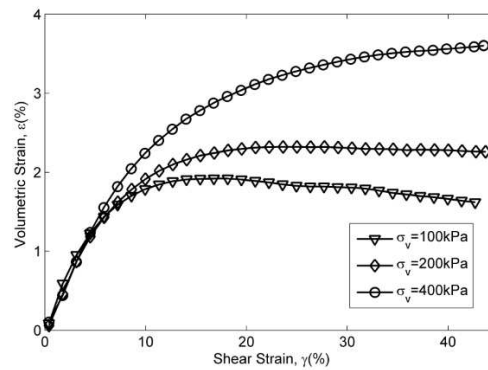

Figure 9 Development of volumetric strains under different vertical stresses

Figure 10 plots the log of normalized shear modulus versus the log of shear strain under different effective vertical stresses. The normalized shear modulus is decreased by the increasing effective vertical stress, especially at the initial stage of shearing. Figure 11 shows the rotation of the principal axes of stresses and strain increment under different effective vertical stresses. It should be noted that the rotation of the principal axis of strain increment is similar in each test. As a result, only one group of strain increment data is included in the Figure 11 for a better presentation of results. At the beginning of shearing, the difference between the principal axes of stresses and strain increment is around 30° , and then the difference decreases with shearing. It is obvious that within the shear strain of 10%, the difference between the principal axes of stresses and strain increment decreases dramatically. In the test with an effective vertical stress of 100 kPa, the difference between these axes decreases the fastest compared with the other two tests, and these axes coincide at the shear strain of 20%. In the tests with 200 kPa effective vertical stress, the difference between these axes decreases more slowly than that in the test with an effective vertical stress of 100 kPa, and these axes coincide at 25% of shear strain. In the test with an effective vertical stress of 400 kPa, the difference between these axes decreases the slowest, and these axes coincide at the shear strain of 40%. Generally, increasing effective vertical stress increases the level of

non-coaxiality, and increases the shear strain when the principal axes of stresses and strain increment coincide.

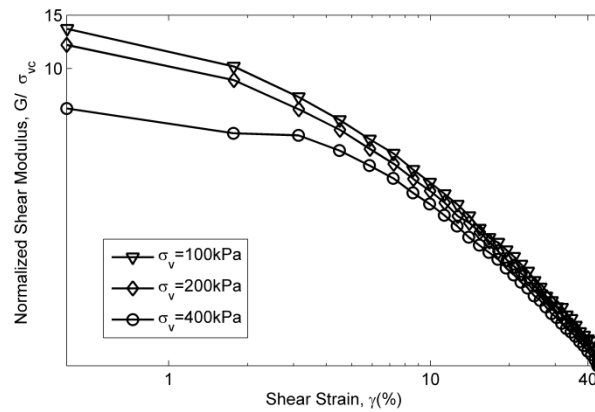

Figure 10 Normalized shear modulus versus shear strain under different vertical stresses

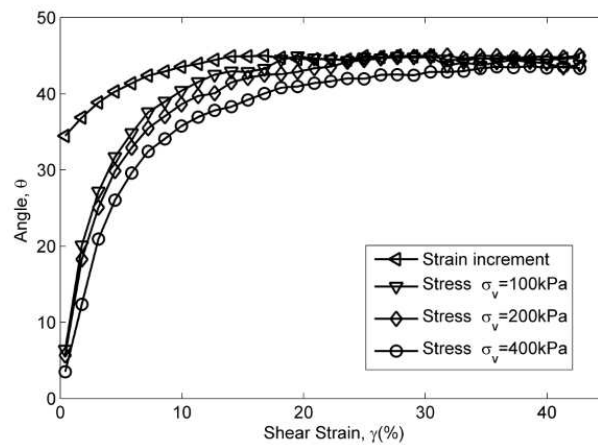

Figure 11 Rotation of principal axes of stresses and strain increment under different vertical stresses

3.2 Effect of Relative Density

In this series of tests, the vertical stress is constant, and the relative density is different in each test, which are 30%, 48% and 67%, respectively. Figure 12 shows the development of the normalized shear stress. Under the same effective vertical stress, increasing relative density increases the normalized shear stress, and the peak normalized shear stress is reached at around the shear strain of 30% for all the tests. Figure 13 shows the development of volumetric strain. The test with a relative density of 68% shows dilative behaviour, and the volumetric strain decreases after reaching the shear strain of 15%. The test with a relative density of 48% and 30% shows contractive behaviour during shearing. Generally, increasing the relative density increases the dilative tendency and results in a smaller peak volumetric strain.

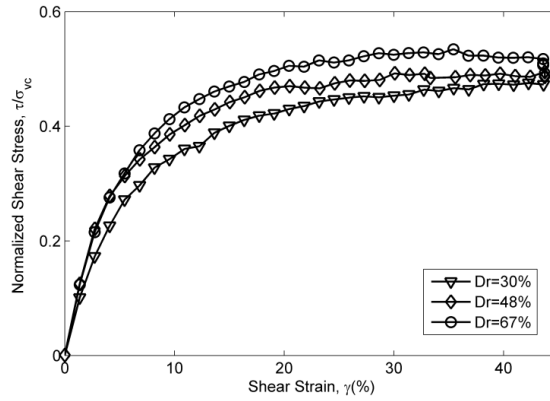

Figure 12 Development of the normalized shear stress at different relative densities

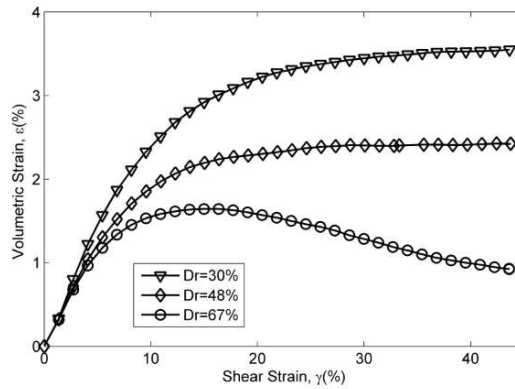

Figure 13 Development of volumetric strain under at different relative densities

Figure 14 plots the log of normalized shear modulus versus the log of shear strain under different relative densities. The normalized shear modulus is increased by the increasing relative density. However, the difference is not significant. Figure 15 shows the rotation of principal axes of stresses and strain increment at different relative densities. It should be noted that although tests with the 30% and 67% relative densities show different volumetric strain development, the rotation of the principal axis of strain increment is still similar. This is due to the volumetric strain increment being small after reaching the peak volumetric strain. As a result, only one group of strain increment data is included in the Figure 15 for a better presentation of results. The difference between the principal axes of stresses and strain increment decreases from 35° to 10° within the shear strain of 10%. In the test with a relative density of 67%, the difference between these axes decreases the fastest compared with the other two types of tests, and these axes coincide at the shear strain of 18%. In the tests with a relative density of 48%, the difference between these axes decreases more slowly than that in the test with a relative density of 67%, and these axes coincide at the shear strain of 27%. In the test with a relative density of 30%, the difference between these axes decreases the slowest and these axes coincide at the shear strain of 40%. Generally, increasing relative density decreases the non-coaxiality. As a result, the principal axes of stresses and strain increment coincide at a smaller shear strain.

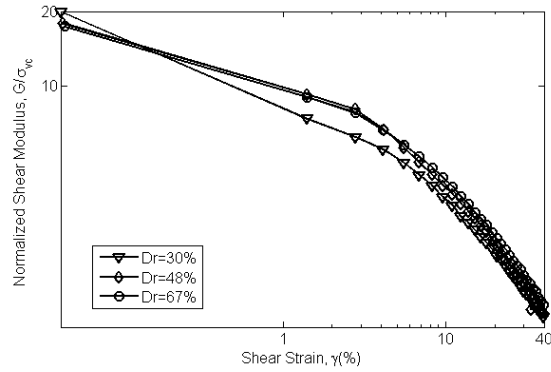

Figure 14 Normalized shear modulus versus shear strain under different relative densities

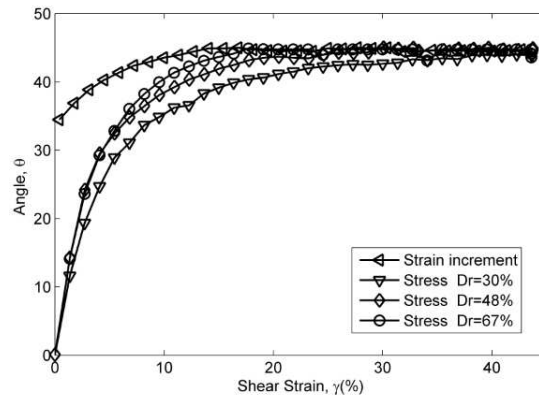

Figure 15 Rotation of principal axes of stresses and strain increment at different relative densities

3.3 Effect of Stress History

In this series of tests, consolidation shear stresses with different directions are added on samples during consolidation, and then samples are sheared in the direction along the x axis of the apparatus. $CSR=0.1$ is used in this series of tests under a 200 kPa vertical confining stress, in which the CSR is the magnitude of consolidation shear stress ratio ($\frac{\tau_{hc}}{\sigma_{vc}}$).

Bi-directional shear stress is interpreted by taking the shear stress in the shearing direction or total shear stress using NGI-Cambridge method introduced in the literature review. It should be noted that the method was first introduced for uni-directional simple shear tests. In previous cyclic tests in uni-directional simple shear tests, the method predicts correctly the stress state, in which the principal stress rotates repeatedly in each cycle (Budhu, 1979). In this study, using monotonic simple tests, the principal stress rotates much slower than that in cyclic tests. As a result, it is reasonable to assume that the NGI-Cambridge method can predict the stress state in bi-directional simple shear tests. To better evaluate the method in bi-directional simple shear tests, shear stress in the shearing direction and total shear stress are both considered. As the change of shear stress in the shearing direction is the main focus in practice, shear stress in the shearing direction (the X direction of the VDDCSS) is first presented in this study, and then total shear stress is introduced for comparison.

Figure 16 shows the development of the normalized shear stress in different stress paths at $CSR=0.1$. Although the tests with different stress paths start at different normalized shear stress, stress-strain behaviours show a similar trend. At the initial period of shearing, the shear stresses in tests with small angles are greater than those in tests with greater angles.

However, the differences of shear stresses among tests with different stress paths decrease with the increasing shear strain, meaning the shear stress in tests with large angles increase more quickly. Tests with the angle of 60°, 90° and 120° failed in the y direction before reaching the peak shear stress, and a large strain is suddenly developed in that direction at failure and caused an emergency stop of the VDDCSS. Other tests reach the peak normalized shear stress at around the shear strain of 30%, and the peak normalized shear stresses are the same. In addition, it is obvious in the tests with the angles of 150° and 180°, the shear stress increases faster during shear reversal at the beginning of shearing.

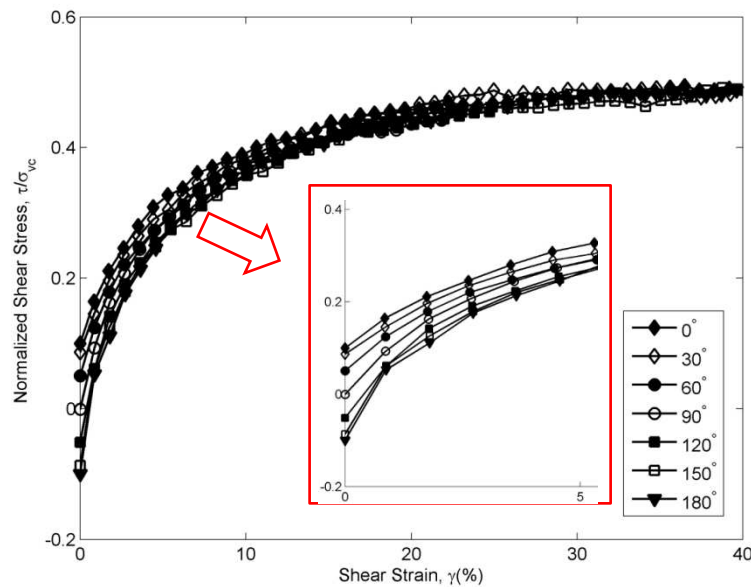

Figure 16 Development of the normalized shear stress in different stress paths at CSR=0.1

If one takes into account the shear stress and shear strain in the Y direction, total shear stress and total shear strain can be obtained by combining the components in X and Y directions, using equation 6 and 7.

$$\tau_T = \sqrt{\tau_x^2 + \tau_y^2} \quad (6)$$

$$\gamma_T = \sqrt{\gamma_x^2 + \gamma_y^2} \quad (7)$$

In which, τ_T is total shear stress and γ_T is total shear strain. Figure 17 shows the development of total shear stress in tests with different stress paths at CSR=0.1. It can be seen that the stress-strain behaviour are different when taking into account the shear stress and shear strain in the Y direction, especially at the initial period of shearing, as shown in Figure 16 and 17. In Figure 17, at the initial stage of shearing, all tests have the same initial total shear stress, and then the total shear stress develops differently in tests with different stress paths. The general trend of total shear stress development among tests with different stress paths is similar to those in tests without considering the shear stress in the Y direction.

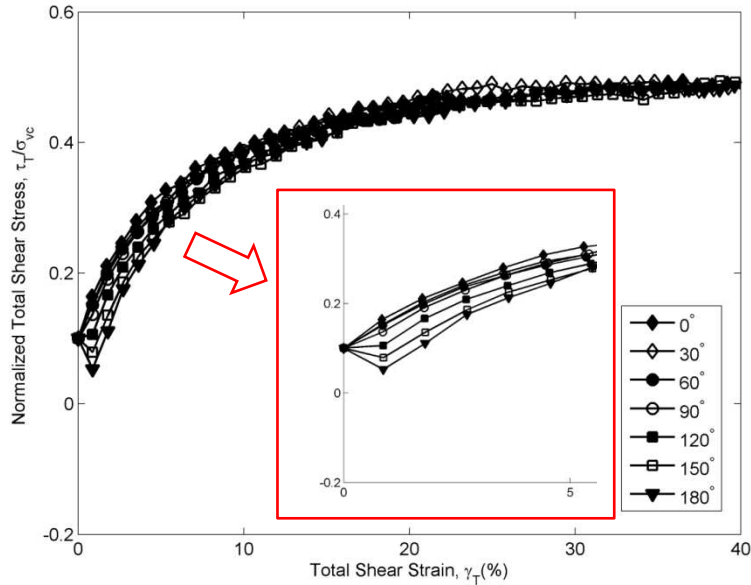

Figure 17 Development of the normalized total shear stress in different stress paths at CSR=0.1

Figure 18 shows the development of volumetric strain in different stress paths at CSR=0.1. It is obvious in the tests with the angles of 150° and 180° that the volumetric strain increases slower during shear reversal at the beginning of shearing. The tests with the angle of 0° and 30° reach the peak volumetric strain first, and have the smallest volumetric strain among all tests. The tests with the angles of 120° and 150° have the greatest volumetric strain. This is due to the difference in obtaining a stable soil fabric in tests with different directions of consolidation shear stresses (Kammerer, 2002). Tests with small angles reach the stable soil fabric quickly, while the tests with the angles of 120° and 150° need longer time to form the stable soil fabric. In the tests with the angles of 120° and 150°, the magnitudes of stress reversal and consolidation shear stress perpendicular to shearing direction are greater than those in the tests with the angles of 0° and 30°. Generally, the combined effect of stress reversal and consolidation shear stress perpendicular to shearing direction extends the time required to form stable soil fabric.

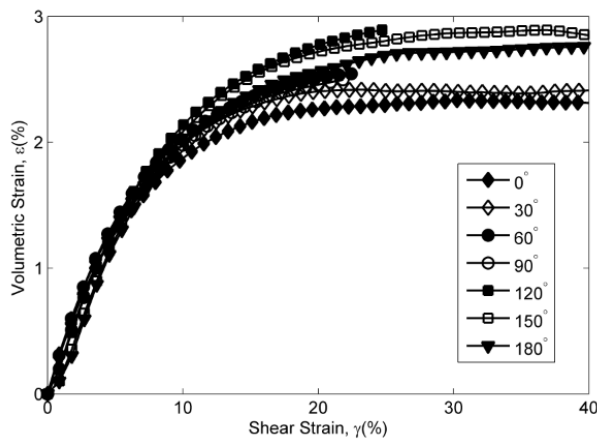

Figure 18 Development of volumetric strain in different stress paths at CSR=0.1

Figure 19 plots the log of normalized shear modulus versus the log of shear strain in tests with different stress paths under at CSR=0.1. The normalized shear modulus is similar in

each test. It can be found that the shear modulus is increased by the increasing angle, however, the difference is not significant. Figure 20 shows the rotation of the principal axes of stresses and strain increment in different stress paths at CSR=0.1. The greatest difference between principal axes of stresses and strain increment is 45° in the test with the angle of 180° , and the smallest difference of these axes is 25° in the test with the angle of 0° . The stress path shows its significant effect on the non-coaxiality, especially at small shear strain, in which the increasing angle increases the level of non-coaxiality. It is obvious that the difference of these axes decreases faster in tests with greater angles. As a result, these axes coincide at around 27% shear strain for all tests, meaning the effect of stress paths on non-coaxiality is decreased by the increasing shear strain. The faster rotation of principal stress in tests with greater angles is consistent with the faster growth of shear stress and greater shear modulus. Similar results are obtained using the total stress-total strain method, as shown in the Figure 21.

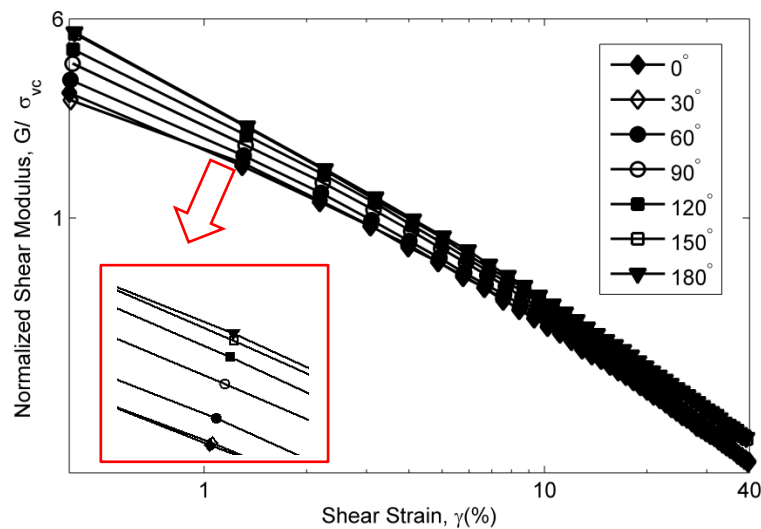

Figure 19 Normalized shear modulus versus shear strain in tests with different stress paths under the CSR=1.

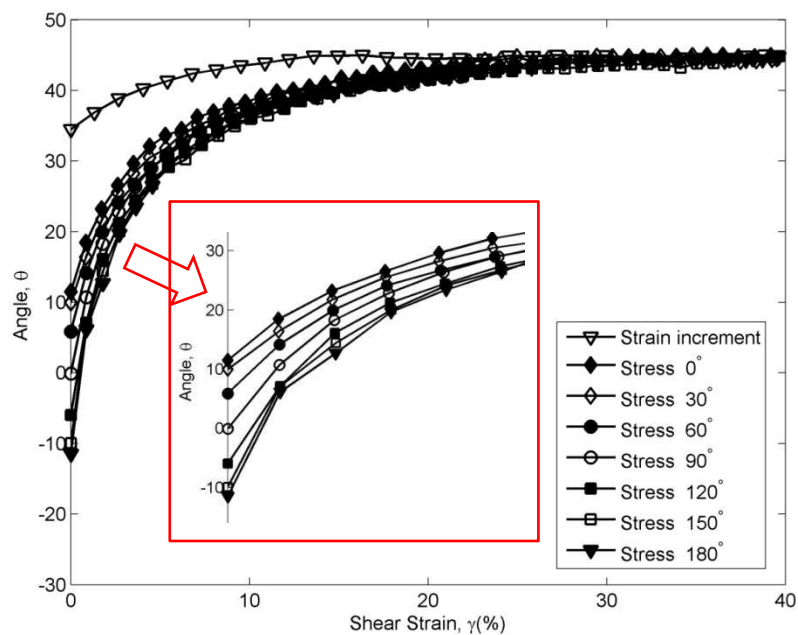

Figure 20 Rotation of principal axes of stresses and strain increment in different stress paths at CSR=0.1

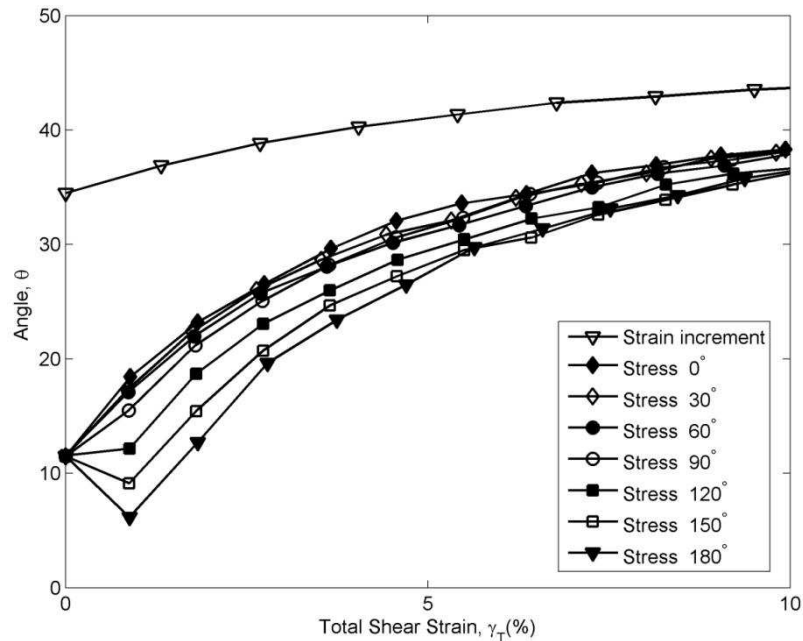

Figure 21 Rotation of principal axes of total stress and total strain increment in different stress paths at CSR=0.1

4. CONCLUSIONS

In this paper, drained unidirectional and bidirectional simple shear tests are conducted to study the effects of vertical stress, relative density, and stress history on shear behaviour. Shear modulus and non-coaxiality are analyzed and discussed in each series of tests. The non-coaxiality is determined based on the difference between rotation of principal stress and strain increment, and the rotation angle of principal stress is calculated using the method described by Budhu(1979). The findings from the study are:

1. Increasing vertical confining stress decreases the normalized shear strength and shear modulus, and increases the level of non-coaxiality determined by the angle differences between principal axes of stresses and strain increment at the initial stage of shearing.. As a result, the principal axes of stresses and strain increment coincide at a greater shear strain.
2. Increasing relative density increases the shear strength and shear modulus, and decreases the level of the non-coaxiality. As a result, the principal axes of stresses and strain increment coincide at a smaller shear strain.
3. In the tests with different shear paths, the angle (θ) between the consolidation shear stress and the drained monotonic shear stress varies from 0° to 180° , with an interval of 30° . The shear strength in the shearing direction generally decreases from 0° tests to 90° tests, and then increases from 90° tests to 180° tests. The shear modulus and level of non-coaxiality are increased by the increasing angle.
4. In the Cambridge-NGI method, using the shear stress in the shearing direction and total shear stress, give a similar result on the change of non-coaxiality, although the shear strengths are different using the two ways of interpretation.

ACKNOWLEDGEMENTS

This research is supported by National Natural Science Foundation of China (NSFC Contract No. 11172312/A020311) and the International Doctoral Innovation Centre (IDIC) scholarship scheme. These supports are appreciated. We also greatly acknowledge the support from Ningbo Education Bureau, Ningbo Science and Technology Bureau, China's MoST and the University of Nottingham. The work is also partially supported by EPSRC grant no EP/L015463/1

REFERENCES

- Airey, D. W., and Wood, D. M. (1987). "An evaluation of direct simple shear tests on clay." *Geotechnique*, Vol. 37, No. 1, pp. 25–35, DOI:10.1680/geot.1987.37.1.25.
- Airey, D. W., Budhu, M., and Wood, D. M. (1985). *Some aspects of the behaviour of soils in simple shear*. Developments in Soil Mechanics and Foundation Engineering 2, Elsevier, London, England.
- Alsaydalani, M., and Clayton, C. (2014). "Internal fluidization in granular soils." *Journal of Geotechnical and Geoenvironmental Engineering*, Vol. 140, No. 3, pp.1-10, DOI:10.1061/(ASCE)GT.1943-5606.0001039.
- Arthur, J. R. F., Chua, K. S., and Dunstan, T. (1977). "Induced anisotropy in a sand." *Geotechnique*, Vol 33, pp. 215-226, DOI: 10.1680/geot.1977.27.1.13.
- Biscontin G. (2001). *Modeling the dynamic behavior of lightly overconsolidated soil deposits on submerged slopes*. University of California, Berkeley, California.
- Boulanger, R. W., and Seed, R. B. (1995). "Liquefaction of sand under bidirectional monotonic and cyclic loading." *Journal of Geotechnical Engineering*, Vol. 121, No.12, pp. 870-878, DOI: 10.1061/(ASCE)0733-9410(1995)121:12(870).
- Boulanger, R. W., Chan, C. K., Seed, H. B., and Seed, R. B. (1993). "A low-compliance bi-directional cyclic simple shear apparatus." *Geotechnical Testing Journal*, Vol. 16, No. 1, pp. 36-45, DOI: 10.1520/GTJ10265J.
- Boulanger, R. W., Seed, R. B., and Chan, C. K. (1991a). "Effects of Initial Static Driving Shear Stresses on the Liquefaction Behavior of Saturated Cohesionless Soils." Rep. No. UCB/GT/91-01, University of California, Berkeley.
- Boulanger, R. W., Seed, R. B., Chan, C. K., Seed, H. B., and Sousa, J. B. (1991b). "Liquefaction behavior of saturated sands under uni-directional and bi-directional monotonic and cyclic simple shear loading." Rep. No. UCB/GT-91/08, University of California, Berkeley.
- Budhu, M. (1979). *Simple Shear Deformation of Sands*. Ph.D. thesis, Cambridge University, Cambridge, United Kingdom.
- Budhu, M. (1988). "A new simple Shear apparatus." *Geotechnical Testing Journal*. Vol. 11, No. 4, pp. 281-287, DOI: 10.1520/GTJ10660J.

- Cai, Y.Y. (2010), An experimental study of non-coaxial soil behaviour using hollow cylinder testing. Ph.D. thesis, the University of Nottingham, United Kingdom.
- Casagrande, A., and Rendon, F. (1978). "Gyratory shear apparatus, design, testing procedures." Tech. Rep. S-78-i5, Corps of Engineers Waterways Experiment Station, Vicksburg, Miss.
- Cole, E. R. L. (1967). The behavior of soils in the simple shear apparatus. Ph.D. thesis, Cambridge University, Cambridge, United Kingdom.
- DeGroot, D. J., Germaine, J. T., and Ladd, C. C. (1993). "The multidirectional direct simple shear apparatus." *Geotechnical Testing Journal*, Vol. 16, No. 3, pp. 283-295, DOI: 10.1520/GTJ10049J.
- DeGroot, D. J., Ladd, C. C., and Germaine, J. T. (1996). "Undrained multidirectional direct simple shear behavior of cohesive soil." *Journal of geotechnical engineering*, Vol. 122, No. 2, pp. 91-98, DOI: 10.1061/(ASCE)0733-9410(1996)122:2(91).
- Drescher, A., and de Josselin de Jong, G. (1972). "Photoelastic verification of a mechanical model for the flow of a granular material." *Journal of the Mechanics and Physics of Solids*, Vol. 20, No. 5, pp. 337-340.
- Dyvik, R., Berre, T., Lacasse, S., and Raadim, B. (1987). "Comparison of truly undrained and constant volume direct simple shear tests." *Geotechnique*, Vol. 37, No. 1, pp. 3-10, DOI: <http://dx.doi.org/10.1680/geot.1987.37.1.3>
- Finn, W. D. L. (1985). "Aspects of constant volume cyclic simple shear." *Advances in the art of testing soils under cyclic conditions*, ASCE Convention, Detroit, pp. 74-98.
- Gutierrez, M., Ishihara, K., and Towhata, I. (1991). "Flow theory for sand during rotation of principal stress direction." *Soils and Foundations*, Vol. 31, No. 4, pp. 121-132, DOI: 10.3208/sandf1972.31.4_121.
- Hill, R. (1950). *The mathematical theory of plasticity*, Clarendon Press, Oxford.
- Ishihara, K. (1993). "Liquefaction and flow failure during earthquake" *Geotechnique*, Vol. 43, No. 3, pp. 351-415, DOI: [10.1680/geot.1993.43.3.351](https://doi.org/10.1680/geot.1993.43.3.351).
- Ishihara, K., and Yamazaki, F. (1980). "Cyclic simple shear tests on saturated sand in multi-directional loading." *Soils and Foundations*, Vol. 20, No. 1, pp. 45-59, DOI: 10.3208/sandf1972.20.45.
- Jaime, A. (1975). "A two-direction cyclic shear apparatus." *5th Pan American Conference on Soil Mechanics and Foundation Engineering*, Buenos Aires, Argentina, Vol. II, PP. 395-402.
- Kammerer, A. (2002), Undrained response of Monterey 0/30 sand under multidirectional cyclic simple shear loading conditions. Ph.D thesis, University of California, Berkeley, California.
- Kim, Y. S. (2009). "Static simple shear characteristics of Nak-dong river clean sand." *KSCE Journal of Civil Engineering*, Vol. 13, No. 6, pp. 389-401, DOI: 10.1007/s12205-009-0389-9.
- Li, Y., Yang, Y., Yu, H., Roberts, G. (2017a). "Monotonic direct simple shear tests on sand under multidirectional loading." *International Journal of Geomechanics*, Vol. 17, No. 1, pp. 1-10, DOI: 10.1061/(ASCE)GM.1943-5622.0000673.

- Li, Y., Yang, Y., Yu, H., Roberts, G. (2017b). "Effect of Sample Reconstitution Methods on the Behaviors of Granular Materials under Shearing." *ASTM Journal of Testing and Evaluation* . (Accepted)
- Miura, K., Miura, S., and Toki, S. (1986). "Deformation behaviour of anisotropic dense sand under principal stress axis rotation." *Soils and Foundations*, Vol. 26, No. 1, pp. 36–52, DOI: 10.3208/sandf1972.26.36.
- Oda, M., and Konishi, J. (1974). "Microscopic deformation mechanism of granular material in simple shear." *Soils and foundations*, Vol.14, pp. 25-38, DOI: 10.3208/sandf1972.14.4_25.
- Roscoe, K. H. (1970). "The influence of strains in soil mechanics." *Geotechnique*, Vol. 20, No. 2, pp. 129–170, DOI: 10.1680/geot.1970.20.2.129.
- Roscoe, K. H., Bassett, R. H., and Cole, E. R. L. (1967). "Principal axes observed during simple shear of a sand." *Proc., Geotechnical Conf. on Shear Strength Properties of Natural Soils and Rocks, Norwegian Geotechnical Society, Oslo*, pp. 231–237.
- Rutherford, C. J. (2012). Development of a multi-directional direct simple shear testing device for characterization of the cyclic shear response of marine clays. Ph.D. thesis, Texas A&M University, Texas.
- Sivathayalan, S., and Ha, D. (2011). "Effect of static shear stress on the cyclic resistance of sands in simple shear loading." *Canadian Geotechnical Journal*, Vol. 48. No. 10, pp. 1471-1484, DOI: 10.1139/T11-056.
- Stroud, M. A. (1971). *The Behavior of Sand at Low Stress Levels in the Simple Shear Apparatus*. Ph.D. thesis, Cambridge University, Cambridge, United Kingdom.
- Wong, R. K. S., and Arthur, J. R. F. (1986). "Sand sheared by stresses with cyclic variation in direction." *Geotechnique*, Vol. 36, No. 2, pp. 215–226,.
- Yang, L.T. (2013). Experimental study of soil anisotropy using hollow cylinder testing. Ph.D. thesis, the University of Nottingham, United Kingdom.
- Yang, Y., and Yu, H.-S. (2006). "Application of a non-coaxial soil model in shallow foundations." *Geomechanics and Geoengineering*, Vol. 1, No. 2, pp. 139–150, DOI: 10.1080/17486020600777101
- Yu, H.-S. (2006). *Plasticity and geotechnics*, Springer, New York.
- Yu, H.-S., and Yuan, X. (2006). "On a class of non-coaxial plasticity models for granular soils." *Proceedings of the Royal Society A*, Vol. 462, No. 2067, pp. 725–748, DOI: 10.1098/rspa.2005.1590.