

UNIVERSITY *of* York

This is a repository copy of *Certolizumab pegol and secukinumab for treating active psoriatic arthritis following inadequate response to disease-modifying antirheumatic drugs : a systematic review and economic evaluation*.

White Rose Research Online URL for this paper:
<https://eprints.whiterose.ac.uk/122272/>

Version: Published Version

Article:

Corbett, Mark orcid.org/0000-0002-5937-1493, Chehadah, Fadi, Biswas, Mousumi orcid.org/0000-0001-6781-7400 et al. (8 more authors) (2017) Certolizumab pegol and secukinumab for treating active psoriatic arthritis following inadequate response to disease-modifying antirheumatic drugs : a systematic review and economic evaluation. Health technology assessment. pp. 1-326. ISSN 2046-4924

<https://doi.org/10.3310/hta21560>

Reuse

Items deposited in White Rose Research Online are protected by copyright, with all rights reserved unless indicated otherwise. They may be downloaded and/or printed for private study, or other acts as permitted by national copyright laws. The publisher or other rights holders may allow further reproduction and re-use of the full text version. This is indicated by the licence information on the White Rose Research Online record for the item.

Takedown

If you consider content in White Rose Research Online to be in breach of UK law, please notify us by emailing eprints@whiterose.ac.uk including the URL of the record and the reason for the withdrawal request.

Certolizumab pegol and secukinumab for treating active psoriatic arthritis following inadequate response to disease-modifying antirheumatic drugs: a systematic review and economic evaluation

Mark Corbett, Fadi Chehadah, Mousumi Biswas, Thirimon Moe-Byrne, Stephen Palmer, Marta Soares, Matthew Walton, Melissa Harden, Pauline Ho, Nerys Woolacott and Laura Bojke



**National Institute for
Health Research**

Certolizumab pegol and secukinumab for treating active psoriatic arthritis following inadequate response to disease-modifying antirheumatic drugs: a systematic review and economic evaluation

Mark Corbett,¹ Fadi Chehadah,² Mousumi Biswas,¹
Thirimon Moe-Byrne,¹ Stephen Palmer,²
Marta Soares,² Matthew Walton,¹ Melissa Harden,¹
Pauline Ho,³ Nerys Woolacott^{1*} and Laura Bojke²

¹Centre for Reviews and Dissemination, University of York, York, UK

²Centre for Health Economics, University of York, York, UK

³The Kellgren Centre for Rheumatology, Central Manchester and Manchester Children's University Hospitals Trust, Manchester, UK

*Corresponding author

Declared competing interests of authors: none

Published October 2017

DOI: 10.3310/hta21560

This report should be referenced as follows:

Corbett M, Chehadah F, Biswas M, Moe-Byrne T, Palmer S, Soares M, *et al.* Certolizumab pegol and secukinumab for treating active psoriatic arthritis following inadequate response to disease-modifying antirheumatic drugs: a systematic review and economic evaluation. *Health Technol Assess* 2017;**21**(56).

Health Technology Assessment is indexed and abstracted in *Index Medicus/MEDLINE*, *Excerpta Medica/EMBASE*, *Science Citation Index Expanded (SciSearch®)* and *Current Contents®/Clinical Medicine*.

ISSN 1366-5278 (Print)

ISSN 2046-4924 (Online)

Impact factor: 4.236

Health Technology Assessment is indexed in MEDLINE, CINAHL, EMBASE, The Cochrane Library and the Clarivate Analytics Science Citation Index.

This journal is a member of and subscribes to the principles of the Committee on Publication Ethics (COPE) (www.publicationethics.org/).

Editorial contact: journals.library@nhr.ac.uk

The full HTA archive is freely available to view online at www.journalslibrary.nhr.ac.uk/hta. Print-on-demand copies can be purchased from the report pages of the NIHR Journals Library website: www.journalslibrary.nhr.ac.uk

Criteria for inclusion in the *Health Technology Assessment* journal

Reports are published in *Health Technology Assessment* (HTA) if (1) they have resulted from work for the HTA programme, and (2) they are of a sufficiently high scientific quality as assessed by the reviewers and editors.

Reviews in *Health Technology Assessment* are termed 'systematic' when the account of the search appraisal and synthesis methods (to minimise biases and random errors) would, in theory, permit the replication of the review by others.

HTA programme

The HTA programme, part of the National Institute for Health Research (NIHR), was set up in 1993. It produces high-quality research information on the effectiveness, costs and broader impact of health technologies for those who use, manage and provide care in the NHS. 'Health technologies' are broadly defined as all interventions used to promote health, prevent and treat disease, and improve rehabilitation and long-term care.

The journal is indexed in NHS Evidence via its abstracts included in MEDLINE and its Technology Assessment Reports inform National Institute for Health and Care Excellence (NICE) guidance. HTA research is also an important source of evidence for National Screening Committee (NSC) policy decisions.

For more information about the HTA programme please visit the website: <http://www.nets.nhr.ac.uk/programmes/hta>

This report

The research reported in this issue of the journal was commissioned and funded by the HTA programme on behalf of NICE as project number 15/06/04. The protocol was agreed in January 2016. The assessment report began editorial review in September 2016 and was accepted for publication in March 2017. The authors have been wholly responsible for all data collection, analysis and interpretation, and for writing up their work. The HTA editors and publisher have tried to ensure the accuracy of the authors' report and would like to thank the reviewers for their constructive comments on the draft document. However, they do not accept liability for damages or losses arising from material published in this report.

This report presents independent research funded by the National Institute for Health Research (NIHR). The views and opinions expressed by authors in this publication are those of the authors and do not necessarily reflect those of the NHS, the NIHR, NETSCC, the HTA programme or the Department of Health. If there are verbatim quotations included in this publication the views and opinions expressed by the interviewees are those of the interviewees and do not necessarily reflect those of the authors, those of the NHS, the NIHR, NETSCC, the HTA programme or the Department of Health.

© Queen's Printer and Controller of HMSO 2017. This work was produced by Corbett *et al.* under the terms of a commissioning contract issued by the Secretary of State for Health. This issue may be freely reproduced for the purposes of private research and study and extracts (or indeed, the full report) may be included in professional journals provided that suitable acknowledgement is made and the reproduction is not associated with any form of advertising. Applications for commercial reproduction should be addressed to: NIHR Journals Library, National Institute for Health Research, Evaluation, Trials and Studies Coordinating Centre, Alpha House, University of Southampton Science Park, Southampton SO16 7NS, UK.

Published by the NIHR Journals Library (www.journalslibrary.nhr.ac.uk), produced by Prepress Projects Ltd, Perth, Scotland (www.prepress-projects.co.uk).

Health Technology Assessment Editor-in-Chief

Professor Hywel Williams Director, HTA Programme, UK and Foundation Professor and Co-Director of the Centre of Evidence-Based Dermatology, University of Nottingham, UK

NIHR Journals Library Editor-in-Chief

Professor Tom Walley Director, NIHR Evaluation, Trials and Studies and Director of the EME Programme, UK

NIHR Journals Library Editors

Professor Ken Stein Chair of HTA and EME Editorial Board and Professor of Public Health, University of Exeter Medical School, UK

Professor Andrée Le May Chair of NIHR Journals Library Editorial Group (HS&DR, PGfAR, PHR journals)

Dr Martin Ashton-Key Consultant in Public Health Medicine/Consultant Advisor, NETSCC, UK

Professor Matthias Beck Chair in Public Sector Management and Subject Leader (Management Group), Queen's University Management School, Queen's University Belfast, UK

Dr Tessa Crilly Director, Crystal Blue Consulting Ltd, UK

Dr Eugenia Cronin Senior Scientific Advisor, Wessex Institute, UK

Dr Peter Davidson Director of the NIHR Dissemination Centre, University of Southampton, UK

Ms Tara Lamont Scientific Advisor, NETSCC, UK

Dr Catriona McDaid Senior Research Fellow, York Trials Unit, Department of Health Sciences, University of York, UK

Professor William McGuire Professor of Child Health, Hull York Medical School, University of York, UK

Professor Geoffrey Meads Professor of Wellbeing Research, University of Winchester, UK

Professor John Norrie Chair in Medical Statistics, University of Edinburgh, UK

Professor John Powell Consultant Clinical Adviser, National Institute for Health and Care Excellence (NICE), UK

Professor James Raftery Professor of Health Technology Assessment, Wessex Institute, Faculty of Medicine, University of Southampton, UK

Dr Rob Riemsma Reviews Manager, Kleijnen Systematic Reviews Ltd, UK

Professor Helen Roberts Professor of Child Health Research, UCL Institute of Child Health, UK

Professor Jonathan Ross Professor of Sexual Health and HIV, University Hospital Birmingham, UK

Professor Helen Snooks Professor of Health Services Research, Institute of Life Science, College of Medicine, Swansea University, UK

Professor Jim Thornton Professor of Obstetrics and Gynaecology, Faculty of Medicine and Health Sciences, University of Nottingham, UK

Professor Martin Underwood Director, Warwick Clinical Trials Unit, Warwick Medical School, University of Warwick, UK

Please visit the website for a list of members of the NIHR Journals Library Board:
www.journalslibrary.nihr.ac.uk/about/editors

Editorial contact: journals.library@nihr.ac.uk

Abstract

Certolizumab pegol and secukinumab for treating active psoriatic arthritis following inadequate response to disease-modifying antirheumatic drugs: a systematic review and economic evaluation

Mark Corbett,¹ Fadi Chehadah,² Mousumi Biswas,¹ Thirimon Moe-Byrne,¹ Stephen Palmer,² Marta Soares,² Matthew Walton,¹ Melissa Harden,¹ Pauline Ho,³ Nerys Woolacott^{1*} and Laura Bojke²

¹Centre for Reviews and Dissemination, University of York, York, UK

²Centre for Health Economics, University of York, York, UK

³The Kellgren Centre for Rheumatology, Central Manchester and Manchester Children's University Hospitals Trust, Manchester, UK

*Corresponding author nerys.woolacott@york.ac.uk

Background: Several biologic therapies are approved by the National Institute for Health and Care Excellence (NICE) for psoriatic arthritis (PsA) patients who have had an inadequate response to two or more synthetic disease-modifying antirheumatic drugs (DMARDs). NICE does not specifically recommend switching from one biologic to another, and only ustekinumab (UST; STELARA®, Janssen Pharmaceuticals, Inc., Horsham, PA, USA) is recommended after anti-tumour necrosis factor failure. Secukinumab (SEC; COSENTYX®, Novartis International AG, Basel, Switzerland) and certolizumab pegol (CZP; CIMZIA®, UCB Pharma, Brussels, Belgium) have not previously been appraised by NICE.

Objective: To determine the clinical effectiveness and cost-effectiveness of CZP and SEC for treating active PsA in adults in whom DMARDs have been inadequately effective.

Design: Systematic review and economic model.

Data sources: Fourteen databases (including MEDLINE and EMBASE) were searched for relevant studies from inception to April 2016 for CZP and SEC studies; update searches were run to identify new comparator studies.

Review methods: Clinical effectiveness data from randomised controlled trials (RCTs) were synthesised using Bayesian network meta-analysis (NMA) methods to investigate the relative efficacy of SEC and CZP compared with comparator therapies. A de novo model was developed to assess the cost-effectiveness of SEC and CZP compared with the other relevant comparators. The model was specified for three subpopulations, in accordance with the NICE scope (patients who have taken one prior DMARD, patients who have taken two or more prior DMARDs and biologic-experienced patients). The models were further classified according to the level of concomitant psoriasis.

Results: Nineteen eligible RCTs were included in the systematic review of short-term efficacy. Most studies were well conducted and were rated as being at low risk of bias. Trials of SEC and CZP demonstrated clinically important efficacy in all key clinical outcomes. At 3 months, patients taking 150 mg of SEC [relative risk (RR) 6.27, 95% confidence interval (CI) 2.55 to 15.43] or CZP (RR 3.29, 95% CI 1.94 to 5.56)

were more likely to be responders than patients taking placebo. The NMA results for the biologic-naive subpopulations indicated that the effectiveness of SEC and CZP relative to other biologics and each other was uncertain. Limited data were available for the biologic-experienced subpopulation. Longer-term evidence suggested that these newer biologics reduced disease progression, with the benefits being similar to those seen for older biologics. The de novo model generated incremental cost-effectiveness ratios (ICERs) for three subpopulations and three psoriasis subgroups. In subpopulation 1 (biologic-naive patients who had taken one prior DMARD), CZP was the optimal treatment in the moderate–severe psoriasis subgroup and 150 mg of SEC was optimal in the subgroups of patients with mild–moderate psoriasis or no concomitant psoriasis. In subpopulation 2 (biologic-naive patients who had taken two or more prior DMARDs), etanercept (ETN; ENBREL®, Pfizer Inc., New York City, NY, USA) is likely to be the optimal treatment in all subgroups. The ICERs for SEC and CZP versus best supportive care are in the region of £20,000–30,000 per quality-adjusted life-year (QALY). In subpopulation 3 (biologic-experienced patients or patients in whom biologics are contraindicated), UST is likely to be the optimal treatment (ICERs are in the region of £21,000–27,000 per QALY). The optimal treatment in subpopulation 2 was sensitive to the choice of evidence synthesis model. In subpopulations 2 and 3, results were sensitive to the algorithm for Health Assessment Questionnaire–Disability Index costs. The optimal treatment is not sensitive to the use of biosimilar prices for ETN and infliximab (REMICADE®, Merck Sharp & Dohme, Kenilworth, NJ, USA).

Conclusions: SEC and CZP may be an effective use of NHS resources, depending on the subpopulation and subgroup of psoriasis severity. There are a number of limitations to this assessment, driven mainly by data availability.

Future work: Trials are needed to inform effectiveness of biologics in biologic-experienced populations.

Study registration: This study is registered as PROSPERO CRD42016033357.

Funding: The National Institute for Health Research Health Technology Assessment programme.

Contents

List of tables	xi
List of figures	xxv
Glossary	xxvii
List of abbreviations	xxxiii
Plain English summary	xxxvii
Scientific summary	xxxix
Chapter 1 Background	1
Description of health problem	1
Diagnosis	1
Epidemiology	2
Measurement of disease	2
Current service provision	3
Description of the technology under assessment	4
Chapter 2 Definition of the decision problem	5
Previous National Institute for Health and Care Excellence appraisals	5
Overall aims and objectives of assessment	5
Chapter 3 Assessment of clinical effectiveness	7
Methods for reviewing clinical effectiveness	7
<i>Search strategies</i>	7
<i>Inclusion criteria</i>	7
<i>Data extraction</i>	9
<i>Quality assessment</i>	9
<i>Methods of data synthesis</i>	10
Quantity and quality of the identified evidence	10
Characteristics of the randomised controlled trials included in the systematic review of short-term efficacy	11
<i>Risk-of-bias assessments</i>	22
<i>Short-term efficacy of secukinumab</i>	22
<i>FUTURE 2 trial</i>	32
<i>ERASURE and FIXTURE trials</i>	39
<i>CLEAR trial</i>	40
<i>Summary</i>	41
<i>Efficacy at 12–24 weeks in the RAPID PsA full-trial population</i>	46
<i>Efficacy in the RAPID-PsA biologic-naïve and biologic-experienced subgroups</i>	46
<i>Other efficacy results</i>	47
<i>Summary</i>	48
Evaluating the secukinumab and certolizumab pegol trial results in comparison with other treatments	48
Long-term effectiveness	52
<i>Open-label extension studies</i>	52

Review of anti-tumour necrosis factor patient registry studies	61
<i>Drug survival and anti-tumour necrosis factor switching</i>	61
Review of the natural history of psoriatic arthritis: registry and cohort study data	67
Review of adverse effects of certolizumab pegol, secukinumab and comparators	70
<i>Randomised trials of certolizumab pegol or secukinumab for psoriatic arthritis</i>	70
<i>Open-label extensions of randomised controlled trials of certolizumab pegol and secukinumab</i>	70
<i>Reviews of safety outcomes for other biologics</i>	71
<i>Recent large observational studies</i>	73
<i>Summary</i>	73
Chapter 4 Evidence synthesis: relative efficacy of treatments	75
Framework of analyses	75
Psoriatic Arthritis Response Criteria response	78
<i>Subpopulation: biologic naive</i>	78
<i>Subpopulation: biologic experienced</i>	84
Health Assessment Questionnaire-Disability Index changes conditional on Psoriatic Arthritis Response Criteria response/non-response	86
<i>Subpopulation: biologic naive</i>	86
<i>Subpopulation: biologic experienced</i>	88
Psoriasis Area and Severity Index response	88
<i>Subpopulation: biologic naive</i>	88
<i>Subpopulation: biologic experienced</i>	94
American College of Rheumatology response	96
<i>Subpopulation: biologic naive</i>	96
<i>Subpopulation: biologic experienced</i>	100
Limitations	102
Summary of findings of relative efficacy from network meta-analysis	102
<i>Biologic-naive patients</i>	102
<i>Biologic-experienced patients</i>	103
Chapter 5 Assessment of existing cost-effectiveness evidence	105
Methods	105
Results	105
<i>Identified published studies</i>	105
<i>Review of the existing published cost-effectiveness studies</i>	106
<i>Critique of company submissions</i>	114
<i>Cost-effectiveness results from the company submissions</i>	128
Relevance of submitted cost-effectiveness evidence for National Institute for Health and Care Excellence decision-making: summary and motivation for de novo model	132
Chapter 6 Independent economic assessment	135
Introduction	135
Methods	135
<i>Overview</i>	135
<i>Model structure and assumptions</i>	136
<i>Patient characteristics</i>	138
<i>Choice of intervention and comparators</i>	140
<i>Withdrawal from treatment and the natural history of psoriatic arthritis</i>	141
<i>Sources of effectiveness data</i>	143
<i>Mortality</i>	148
<i>Sources of utility data</i>	148
<i>Sources of resource utilisation and costs data</i>	149

<i>Scenario analyses</i>	154
<i>Analytic methods</i>	154
<i>Probabilistic sensitivity analysis</i>	155
Results	155
<i>Results of the base-case cost-effectiveness analysis</i>	155
<i>Results of the scenario analyses</i>	163
<i>Results from the probabilistic sensitivity analysis</i>	166
<i>External validation of results</i>	174
Discussion of the York model	175
Chapter 7 Assessment of factors relevant to the NHS and other parties	177
Chapter 8 Discussion	179
Statement of principal findings	179
<i>Strengths and limitations of the assessment</i>	180
<i>Uncertainties</i>	181
Chapter 9 Conclusions	183
Implications for service provision	183
Suggested research priorities	183
Acknowledgements	185
References	187
Appendix 1 Database search strategies	199
Appendix 2 Inclusion and exclusion criteria of the included studies	219
Appendix 3 Detailed evidence synthesis	225
Appendix 4 Search strategy for cost-effectiveness studies	279
Appendix 5 Quality assessment checklists for company-submitted models	291
Appendix 6 Clinical effectiveness inputs applied in the company models	295
Appendix 7 R code for the updated York model	299
Appendix 8 Cost-effectiveness results using infliximab and etanercept biosimilar prices, subpopulation 2	301
Appendix 9 Estimating health-related quality of life for the updated York model	303
Appendix 10 Search strategy for utility studies	305
Appendix 11 Identifying additional psoriatic arthritis health state costs	307
Appendix 12 Metaregression results	309
Appendix 13 Results from alternative scenarios	311
Appendix 14 Quality assessment checklists for published cost-effectiveness models	319

List of tables

TABLE 1 The Classification Criteria for Psoriatic Arthritis	2
TABLE 2 Trial durations (including open-label extensions) and dosing regimens of key interventions studied	12
TABLE 3 Treatment doses studied in the review of short-term efficacy	15
TABLE 4 Baseline population characteristics of the included randomised trials	17
TABLE 5 Previous and concomitant treatment details for the included studies	23
TABLE 6 Risk-of-bias judgements for randomised trials (for time points before early escape crossover)	26
TABLE 7 Ongoing trials of SEC in patients with active PsA	32
TABLE 8 Psoriatic Arthritis Response Criteria, ACR and HAQ-DI responses in the FUTURE 2 trial	33
TABLE 9 Psoriasis Area and Severity Index response rates in the FUTURE 2 trial	33
TABLE 10 Psoriatic Arthritis Response Criteria and ACR response rates for biologic-naive and biologic-experienced subgroups in the FUTURE 2 trial	34
TABLE 11 Psoriasis Area and Severity Index response rates for biologic-naive and biologic-experienced subgroups in the FUTURE 2 trial	35
TABLE 12 Relative risks for key dichotomous outcomes in the FUTURE 2 trial: 150 or 300 mg of SEC vs. placebo	36
TABLE 13 Health Assessment Questionnaire-Disability Index changes based on PsARC responder status in the FUTURE 2 trial	38
TABLE 14 Health Assessment Questionnaire-Disability Index changes based on PsARC responder status for biologic-naive and biologic-experienced subgroups in the FUTURE 2 trial	39
TABLE 15 Efficacy in treating dactylitis and enthesitis in the FUTURE 2 trial	40
TABLE 16 Efficacy outcomes in the ERASURE and FIXTURE trials at 12 weeks	40
TABLE 17 Efficacy outcomes in the CLEAR trial at 16 weeks for the subgroup of PsA patients	41
TABLE 18 Psoriatic Arthritis Response Criteria, ACR and HAQ-DI responses in the RAPID-PsA trial	42
TABLE 19 Psoriasis Area and Severity Index response rates in the RAPID-PsA trial	43

TABLE 20 The RAPID-PsA trial ACR 20 response rates at 12 weeks for subgroups of previous DMARD use	43
TABLE 21 Biologic-naive and biologic-experienced subgroup PsARC, ACR and HAQ-DI results in the RAPID-PsA trial at 12 weeks	43
TABLE 22 Biologic-naive and biologic-experienced subgroup PASI response rates in the RAPID-PsA trial at 12 weeks	44
TABLE 23 Biologic-naive and biologic-experienced PsARC, ACR and HAQ-DI subgroup results from the RAPID-PsA trial at 24 weeks	44
TABLE 24 Biologic-naive and biologic-experienced PASI subgroup results from the RAPID-PsA trial at 24 weeks	44
TABLE 25 Relative risks for key outcomes in the RAPID-PsA trial: 200 or 400 mg of CZP vs. placebo	45
TABLE 26 The RAPID-PsA trial HAQ-DI changes from baseline based on PsARC responder status	46
TABLE 27 The HAQ-DI changes based on PsARC responder status for biologic-naive and biologic-experienced subgroups in the RAPID-PsA trial	47
TABLE 28 Efficacy in treating dactylitis and enthesitis in the RAPID-PsA trial	48
TABLE 29 Unadjusted RRs (compared with placebo) across the trials included in the evidence synthesis	49
TABLE 30 Efficacy results for the FUTURE 2 trial at 52 weeks	53
TABLE 31 Efficacy results for the FUTURE 1 trial at 52 weeks and 104 weeks	54
TABLE 32 Long-term efficacy results for Rapid-PsA trial at 216 weeks	55
TABLE 33 Open-label extension studies of other therapies for PsA	57
TABLE 34 Registry studies reporting data on anti-TNF drug survival and switching	62
TABLE 35 Registries reporting the effects of anti-TNF treatment on HAQ-DI and radiographic progression	65
TABLE 36 Registries reporting on natural history of PsA	68
TABLE 37 Results of a meta-analysis of safety outcomes for CZP	72
TABLE 38 List of comparators included in evidence synthesis	75
TABLE 39 Evidence on PsARC, HAQ-DI conditional on PsARC, PASI and ACR, by trial	77
TABLE 40 Summary of trial-specific data in the biologic-naive subpopulation for PsARC response	79

TABLE 41 Key assumptions of models implemented for the evidence synthesis of PsARC response	81
TABLE 42 Network meta-analysis results of PsARC response: log-ORs (median) of treatments analysed (including the studies of Genovese <i>et al.</i> and Mease <i>et al.</i>) in the biologic-naive subpopulation	82
TABLE 43 Network meta-analysis results: probability of PsARC response and ORs by treatments in the biologic-naive subpopulation	84
TABLE 44 Summary of trial-specific data in the biologic-experienced subpopulation for PsARC response outcome	85
TABLE 45 Network meta-analysis results of PsARC response: probability of a PsARC response, ORs and treatment effects on a log-scale in the biologic-experienced subpopulation	86
TABLE 46 The HAQ-DI changes conditional on PsARC response and non-response by trials and treatments in the biologic-naive subpopulation: observed data	87
TABLE 47 Network meta-analysis results of HAQ-DI score changes (median) conditional on PsARC response and non-response in the biologic-naive subpopulation	89
TABLE 48 The HAQ-DI score changes conditional on PsARC response and non-response by trials and treatments in the biologic-experienced subpopulation: observed data	90
TABLE 49 Network meta-analysis results of evidence synthesis of HAQ-DI changes conditional on PsARC response and non-response in biologic-experienced subpopulation	91
TABLE 50 Summary of trial-specific data in the biologic-naive subpopulation for PASI response outcome	92
TABLE 51 Summary of models implemented for evidence synthesis of the PASI response	93
TABLE 52 Network meta-analysis results of the PASI response: treatment effects (median) on a probit scale in the biologic-naive subpopulation	93
TABLE 53 Network meta-analysis results of the PASI response: probability of achieving PASI 50, PASI 75 and PASI 90 in the biologic-naive subpopulation	94
TABLE 54 Summary of trial-specific data in the biologic-experienced subpopulation for PASI response outcome	95
TABLE 55 Network meta-analysis results of the PASI response: probability of achieving PASI 50, PASI 75, PASI 90 and treatment effects in the biologic-experienced subpopulation	96
TABLE 56 Summary of trial-specific data in the biologic-naive subpopulation for ACR response outcome	97

TABLE 57 Key assumptions of models implemented for evidence synthesis of ACR response	98
TABLE 58 Network meta-analysis results of ACR response: treatment effects (median) on a probit scale in a biologic-naive subpopulation	99
TABLE 59 Network meta-analysis results of ACR response: probability of achieving ACR 20, ACR 50 and ACR 70 responses in a biologic-naive subpopulation	100
TABLE 60 Summary of trial-specific data in a biologic-experienced subpopulation for ACR response outcome	101
TABLE 61 Network meta-analysis results of ACR response: probability of achieving ACR 20, ACR 50 and ACR 70 responses, and treatment effects in a biologic-experienced subpopulation	102
TABLE 62 Baseline patient characteristics used in the York model	109
TABLE 63 Psoriasis (PASI) costs applied in the York model	111
TABLE 64 Summary of cost-effectiveness results from the published studies and NICE TAs	114
TABLE 65 Summary of the Novartis and UCB Pharma models	115
TABLE 66 Baseline characteristics in subpopulations 1–3 (UCB Pharma)	123
TABLE 67 Baseline characteristics in subpopulations 1–3 (Novartis)	123
TABLE 68 Discontinuation rates applied in sensitivity analysis (Novartis)	124
TABLE 69 Utility algorithms used in the CSs	126
TABLE 70 Health Assessment Questionnaire-Disability Index and PASI costs applied in the Novartis model	127
TABLE 71 Health Assessment Questionnaire-Disability Index and PASI costs applied in the UCB Pharma model	128
TABLE 72 Base-case results for subpopulation 1 (biologic naive, one prior DMARD): the UCB Pharma submission	128
TABLE 73 Base-case results for subpopulation 1 (biologic naive, one prior DMARD): the Novartis submission	129
TABLE 74 UCB Pharma's base-case ICER results for subpopulation 2 (biologic naive, one or more prior DMARDs)	129
TABLE 75 Novartis' base-case ICER results for subpopulation 2 (biologic naive, two or more prior DMARDs)	130
TABLE 76 UCB Pharma's base-case ICER results for subpopulation 3 (biologic experienced)	131

TABLE 77 Novartis' base-case ICER results for subpopulation 3 (biologic experienced)	131
TABLE 78 Summary of data inputs for the York model	139
TABLE 79 Effectiveness data utilised in the economic model	145
TABLE 80 Probabilities of PsARC and PASI 75 responses at 3 months: independent analysis	147
TABLE 81 Probabilities of PsARC and PASI 75 responses at 3 months: metaregression, shrunken estimates	147
TABLE 82 Intervention-related costs applied in the updated York model	149
TABLE 83 Summary of drug acquisition, administration and monitoring costs used in the economic model	150
TABLE 84 Number of vials administered for each treatment	150
TABLE 85 Distribution of weights used to determine INF vials required	151
TABLE 86 Acquisition costs used in the updated York model	151
TABLE 87 Administration costs used in the updated York model	152
TABLE 88 Initiation and monitoring resource use and costs	152
TABLE 89 Costs (£) assigned for PASI 75 non-responders and patients not receiving biologics	153
TABLE 90 Treatment effects from the independent analysis for moderate–severe psoriasis, subpopulation 1: fully incremental cost-effectiveness analysis	156
TABLE 91 Treatment effects from the independent analysis for mild–moderate psoriasis, subpopulation 1: fully incremental cost-effectiveness analysis	156
TABLE 92 Treatment effects from the independent analysis for no concomitant psoriasis, subpopulation 1: fully incremental cost-effectiveness analysis	157
TABLE 93 Summary of differences between independent and metaregression approaches, subpopulation 1	158
TABLE 94 Treatment effects from the independent analysis for moderate–severe psoriasis, subpopulation 2: fully incremental cost-effectiveness analysis	158
TABLE 95 Treatment effects from the independent analysis for mild–moderate psoriasis, subpopulation 2: fully incremental cost-effectiveness analysis	159
TABLE 96 Treatment effects from the independent analysis for no concomitant psoriasis, subpopulation 2: fully incremental cost-effectiveness analysis	160

TABLE 97 Summary of differences between independent and metaregression approaches, subpopulation 2	160
TABLE 98 Moderate–severe psoriasis, subpopulation 3: fully incremental cost-effectiveness analysis	161
TABLE 99 Mild–moderate psoriasis, subpopulation 3: fully incremental cost-effectiveness analysis	161
TABLE 100 No concomitant psoriasis, subpopulation 3: fully incremental cost-effectiveness analysis	161
TABLE 101 Moderate–severe psoriasis, subpopulation 4, contraindicated: fully incremental cost-effectiveness analysis	162
TABLE 102 Mild–moderate psoriasis, subpopulation 4, contraindicated: fully incremental cost-effectiveness analysis	162
TABLE 103 No concomitant psoriasis, subpopulation 4, contraindicated: fully incremental cost-effectiveness analysis	163
TABLE 104 Summary of differences between base-case models and alternative scenarios, subpopulation 1	163
TABLE 105 Summary of differences between base-case models and alternative scenarios, subpopulation 2	164
TABLE 106 Summary of differences between base-case models and alternative scenarios, subpopulation 3	165
TABLE 107 Moderate–severe psoriasis, subpopulation 4, secondary failures: fully incremental cost-effectiveness analysis	165
TABLE 108 Mild–moderate psoriasis, subpopulation 4, secondary failures: fully incremental cost-effectiveness analysis	166
TABLE 109 No concomitant psoriasis, subpopulation 4, secondary failures: fully incremental cost-effectiveness analysis	166
TABLE 110 Treatment effects from the independent analysis for moderate–severe psoriasis, subpopulation 1: fully incremental cost-effectiveness PSA	167
TABLE 111 Treatment effects from the independent analysis for mild–moderate psoriasis, subpopulation 1: fully incremental cost-effectiveness PSA	167
TABLE 112 Treatment effects from the independent analysis for no concomitant psoriasis, subpopulation 1: fully incremental cost-effectiveness PSA	167
TABLE 113 Summary of differences for the PSA results between independent and metaregression approaches, subpopulation 1	168
TABLE 114 Treatment effects from the independent analysis for moderate–severe psoriasis, subpopulation 2: fully incremental cost-effectiveness PSA	168

TABLE 115 Treatment effects from the independent analysis for mild–moderate psoriasis, subpopulation 2: fully incremental cost-effectiveness PSA	169
TABLE 116 Treatment effects from independent analysis for no concomitant psoriasis, subpopulation 2: fully incremental cost-effectiveness PSA	170
TABLE 117 Summary of differences for the PSA results between independent and metaregression approaches, subpopulation 2	170
TABLE 118 Moderate–severe psoriasis, subpopulation 3: fully incremental cost-effectiveness PSA	171
TABLE 119 Mild–moderate psoriasis, subpopulation 3: fully incremental cost-effectiveness PSA	171
TABLE 120 No concomitant psoriasis, subpopulation 3: fully incremental cost-effectiveness PSA	171
TABLE 121 The 12- and 24-week full population results across recent trials that used an early escape at 16 weeks design	226
TABLE 122 Key assumptions of models implemented for evidence synthesis of PsARC response	229
TABLE 123 Description of models and underlying assumptions for PsARC response	230
TABLE 124 Results of PsARC response: log-ORs (median) of treatments analysed (including Genovese <i>et al.</i> and Mease <i>et al.</i> studies) in the biologic-naive subpopulation	231
TABLE 125 Results of PsARC response: log-ORs (median) of treatments analysed (excluding Genovese <i>et al.</i> and Mease <i>et al.</i> studies) in the biologic-naive subpopulation	232
TABLE 126 Result of PsARC response: baseline effect (log-odds) in the biologic-naive subpopulation	232
TABLE 127 Results of model A1: treatment effects (treatment, independent; studies, fixed effect)	233
TABLE 128 Results of model B1: treatment effects (metaregression; treatment, independent; studies, fixed effect)	233
TABLE 129 Results of model C1: treatment effects (metaregression; treatment, equal I class; studies, fixed effect)	234
TABLE 130 Results of model C2: treatment effects (metaregression; treatment, APR = independent, other biologics = equal I class; studies, fixed effect)	234
TABLE 131 Results of model C3: treatment effects [metaregression; treatment, APR = independent, equal I class (ILs, anti-TNFs); studies, fixed effect, including all studies]	234

TABLE 132 Results of model D1: treatment effects (metaregression; treatment, APR = independent, other biologics = exchangeable I class; studies, fixed effect, including all studies)	235
TABLE 133 Results of model D2: treatment effects [metaregression; treatment, APR = independent, exchangeable I class (ILs, anti-TNFs); studies: fixed effect, including all studies]	235
TABLE 134 Results of model A1: treatment effects (treatment, independent; studies, fixed effect, excluding Genovese <i>et al.</i> and Mease <i>et al.</i>)	236
TABLE 135 Results of model B1: treatment effects (metaregression; treatment, independent; studies, fixed effect, excluding Genovese <i>et al.</i> and Mease <i>et al.</i>)	236
TABLE 136 Results of model C1: treatment effects (metaregression; treatment, equal I class; studies, fixed effect, excluding Genovese <i>et al.</i> and Mease <i>et al.</i>)	237
TABLE 137 Results of model C2: treatment effects (metaregression; treatment, APR = independent, other biologics = equal I class; studies, fixed effect, excluding Genovese <i>et al.</i> and Mease <i>et al.</i>)	237
TABLE 138 Results of model C3: treatment effects (metaregression; treatment, APR = independent, equal I class (ILs, anti-TNFs); studies, fixed effect, excluding Genovese <i>et al.</i> and Mease <i>et al.</i>)	237
TABLE 139 Results of model D1: treatment effects (metaregression; treatment, APR = independent, exchangeable I class; studies, fixed effect, excluding Genovese <i>et al.</i> and Mease <i>et al.</i>)	238
TABLE 140 Results of model D2: treatment effects [metaregression; treatment, APR = independent, exchangeable I class (ILs, anti-TNFs); studies, fixed effect, excluding Genovese <i>et al.</i> and Mease <i>et al.</i>]	238
TABLE 141 Comparison of evidence synthesis of PsARC responses in the CSs (Novartis and UCB Pharma), a previous MTA and the current AG	240
TABLE 142 Key assumptions in the synthesis models for PsARC responses in the CSs (Novartis and UCB Pharma), a previous MTA and the current AG	241
TABLE 143 Comparison of probability of PsARC response in Novartis' submission, a previous MTA and the current AG in the biologic-naive subpopulation	242
TABLE 144 Comparison of PsARC response (ORs) at 12 weeks between UCB Pharma's submission and the current AG in the biologic-naive subpopulation	242
TABLE 145 Description of the models and underlying assumptions for HAQ-DI changes conditional on PsARC response	244
TABLE 146 Results of HAQ-DI score changes (median) conditional on PsARC response and non-response in biologic-naive subpopulation	245
TABLE 147 Results of model E1: treatment effects (treatment, independent; difference between PR/TNR/TR and PNR pooled using fixed effects)	246

TABLE 148 Results of model E2: treatment effects [treatment, exchangeable I class (ILs, anti-TNF), APR = independent; difference between PR/TNR/TR and PNR pooled using fixed effects]	247
TABLE 149 Results of model E3: treatment effects [treatment, equal I class (ILs, anti-TNF), APR = independent; difference between PR/TNR/TR and PNR pooled using fixed effects]	248
TABLE 150 Comparison of evidence synthesis of HAQ-DI score changes conditional on PsARC response/non-response in UCB Pharma's submission, a previous MTA and the current AG	248
TABLE 151 The HAQ-DI score changes conditional on PsARC response model results in the biologic-naive subpopulation	249
TABLE 152 Summary of models implemented for evidence synthesis of PASI response	253
TABLE 153 Description of models and underlying assumptions for PASI response and ACR response	253
TABLE 154 Results of PASI response: treatment effects (median) on a probit scale in the biologic-naive subpopulation	254
TABLE 155 Results of model F1: treatment effects (on a probit scale) and the different cut-off points (PASI 50, PASI 75 and PASI 90)	255
TABLE 156 Results of model G1: treatment effects (on a probit scale) and the different cut-off points (PASI 50, PASI 75 and PASI 90)	255
TABLE 157 Results of model G2: treatment effects (on a probit scale) and the different cut-off points (PASI 50, PASI 75 and PASI 90)	256
TABLE 158 Comparison of evidence synthesis of PASI responses in the CSs (Novartis and UCB Pharma), a previous MTA and the current AG	257
TABLE 159 Key assumptions in the synthesis models for PASI responses in the CSs (Novartis and UCB Pharma), a previous MTA and the current AG	258
TABLE 160 Comparison of PASI response in the CSs (Novartis and UCB Pharma), a previous MTA and the current AG in the biologic-naive subpopulation	258
TABLE 161 Comparison of PASI response in the UCB Pharma submission and the current AG in the biologic-experienced subpopulation	261
TABLE 162 Key assumptions of models implemented for evidence synthesis of ACR response	264
TABLE 163 Description of models and underlying assumptions for ACR response	265
TABLE 164 Results of ACR response: treatment effects (median) on a probit scale in the biologic-naive subpopulation	266

TABLE 165 Results of model H1: treatment effects (on a probit scale) and the different cut-off points (ACR 20, ACR 50 and ACR 70)	267
TABLE 166 Results of model I1: treatment effects (on a probit scale) and the different cut-off points (ACR 20, ACR 50 and ACR 70)	267
TABLE 167 Results of model J1: treatment effects (on a probit scale) and the different cut-off points (ACR 20, ACR 50 and ACR 70)	268
TABLE 168 Results of model J2: treatment effects (on a probit scale) and the different cut-off points (ACR 20, ACR 50 and ACR 70)	268
TABLE 169 Results of model J3: treatment effects (on a probit scale) and the different cut-off points (ACR 20, ACR 50 and ACR 70)	269
TABLE 170 Results of model K1: treatment effects (on a probit scale) and the different cut-off points (ACR 20, ACR 50 and ACR 70)	269
TABLE 171 Results of model K2: treatment effects (on a probit scale) and the different cut-off points (ACR 20, ACR 50 and ACR 70)	270
TABLE 172 Comparison of evidence synthesis of ACR responses in CSs (Novartis and UCB Pharma), the previous MTA and the current AG	271
TABLE 173 Key assumptions in the synthesis models for ACR responses in CSs (Novartis and UCB Pharma), the previous MTA and the current AG	272
TABLE 174 Comparison of ACR response in the CSs (Novartis and UCB Pharma), the previous MTA and the current AG in the biologic-naive subpopulation	273
TABLE 175 Comparison of ACR response in UCB Pharma submission and the current AG in the biologic-experienced subpopulation	275
TABLE 176 Response parameters applied in model for subpopulation 1: UCB Pharma	295
TABLE 177 Response parameters applied in model for subpopulation 1: Novartis	295
TABLE 178 Health Assessment Questionnaire-Disability Index score change according to the PsARC response for subpopulation 1: UCB Pharma	295
TABLE 179 Health Assessment Questionnaire-Disability Index score change according to the PsARC response for subpopulation 1: Novartis	295
TABLE 180 Response parameters applied in model for subpopulation 1: UCB Pharma	296
TABLE 181 Response parameters applied in model for subpopulation 2: Novartis	296
TABLE 182 Health Assessment Questionnaire-Disability Index score change according to the PsARC response for subpopulation 2: UCB Pharma	297

TABLE 183 Health Assessment Questionnaire-Disability Index score change according to the PsARC response for subpopulation 2: Novartis	297
TABLE 184 Response parameters applied in model for subpopulation 3: UCB Pharma	297
TABLE 185 Response parameters applied in model for subpopulation 3: Novartis	298
TABLE 186 Health Assessment Questionnaire-Disability Index score change according to the PsARC response for subpopulation 3: UCB Pharma	298
TABLE 187 Health Assessment Questionnaire-Disability Index score change according to the PsARC response for subpopulation 3: Novartis	298
TABLE 188 Treatment effects from independent analysis for moderate–severe psoriasis, subpopulation 2: fully incremental cost-effectiveness analysis, biosimilar prices	301
TABLE 189 Treatment effects from independent analysis for mild–moderate psoriasis, subpopulation 2: fully incremental cost-effectiveness analysis, biosimilar prices	302
TABLE 190 Treatment effects from independent analysis for no concomitant psoriasis, subpopulation 2: fully incremental cost-effectiveness analysis, biosimilar prices	302
TABLE 191 Full results of Wyeth’s linear regressions of utility vs. HAQ-DI, PASI and HAQ-DI × PASI	303
TABLE 192 Utilities papers screened for inclusion	304
TABLE 193 Treatment effects from metaregression for moderate–severe psoriasis, subpopulation 1: fully incremental cost-effectiveness analysis	309
TABLE 194 Treatment effects from metaregression for mild–moderate psoriasis, subpopulation 1: fully incremental cost-effectiveness analysis	309
TABLE 195 Treatment effects from metaregression for no concomitant psoriasis, subpopulation 1: fully incremental cost-effectiveness analysis	309
TABLE 196 Treatment effects from metaregression for moderate–severe psoriasis, subpopulation 2: fully incremental cost-effectiveness analysis	310
TABLE 197 Treatment effects from metaregression analysis for mild–moderate psoriasis, subpopulation 2: fully incremental cost-effectiveness analysis	310
TABLE 198 Treatment effects from metaregression for no concomitant psoriasis, subpopulation 2: fully incremental cost-effectiveness analysis	310
TABLE 199 Treatment effects from independent analysis for moderate–severe psoriasis, subpopulation 1: fully incremental cost-effectiveness analysis, subpopulation-specific baseline HAQ-DI score	311

TABLE 200 Treatment effects from independent analysis for mild–moderate psoriasis, subpopulation 1: fully incremental cost-effectiveness analysis, subpopulation-specific baseline HAQ-DI score	311
TABLE 201 Treatment effects from independent analysis for no concomitant psoriasis, subpopulation 1: fully incremental cost-effectiveness analysis, subpopulation-specific baseline HAQ-DI score	311
TABLE 202 Treatment effects from independent analysis for moderate–severe psoriasis, subpopulation 2: fully incremental cost-effectiveness analysis, subpopulation-specific baseline HAQ-DI score	311
TABLE 203 Treatment effects from independent analysis for mild–moderate psoriasis, subpopulation 2: fully incremental cost-effectiveness analysis, subpopulation-specific baseline HAQ-DI score	312
TABLE 204 Treatment effects from independent analysis for no concomitant psoriasis, subpopulation 2: fully incremental cost-effectiveness analysis, subpopulation-specific baseline HAQ-DI score	312
TABLE 205 Treatment effects from independent analysis for moderate–severe psoriasis, subpopulation 3: fully incremental cost-effectiveness analysis, subpopulation-specific baseline HAQ-DI score	312
TABLE 206 Treatment effects from independent analysis for mild–moderate psoriasis, subpopulation 3: fully incremental cost-effectiveness analysis, subpopulation-specific baseline HAQ-DI score	312
TABLE 207 Treatment effects from independent analysis for no concomitant psoriasis, subpopulation 3: fully incremental cost-effectiveness analysis, subpopulation-specific baseline HAQ-DI score	313
TABLE 208 Treatment effects from independent analysis for moderate–severe psoriasis, subpopulation 2: fully incremental cost-effectiveness analysis, HAQ-DI costs from Poole <i>et al.</i>	313
TABLE 209 Treatment effects from independent analysis for mild–moderate psoriasis, subpopulation 2: fully incremental cost-effectiveness analysis, HAQ-DI costs from Poole <i>et al.</i>	313
TABLE 210 Treatment effects from independent analysis for no concomitant psoriasis, subpopulation 2: fully incremental cost-effectiveness analysis, HAQ-DI costs from Poole <i>et al.</i>	314
TABLE 211 Treatment effects from independent analysis for moderate–severe psoriasis, subpopulation 3: fully incremental cost-effectiveness analysis, HAQ-DI costs from Poole <i>et al.</i>	314
TABLE 212 Treatment effects from independent analysis for mild–moderate psoriasis, subpopulation 3: fully incremental cost-effectiveness analysis, HAQ-DI costs from Poole <i>et al.</i>	314

TABLE 213 Treatment effects from independent analysis for no concomitant psoriasis, subpopulation 3: fully incremental cost-effectiveness analysis, HAQ-DI costs from Poole <i>et al.</i>	314
TABLE 214 Treatment effects from independent analysis for moderate–severe psoriasis, subpopulation 2: fully incremental cost-effectiveness analysis, withdrawal scenario 1	315
TABLE 215 Treatment effects from independent analysis for mild–moderate psoriasis, subpopulation 2: fully incremental cost-effectiveness analysis, withdrawal scenario 1	315
TABLE 216 Treatment effects from independent analysis for no concomitant psoriasis, subpopulation 2: fully incremental cost-effectiveness analysis, withdrawal scenario 1	315
TABLE 217 Treatment effects from independent analysis for moderate–severe psoriasis, subpopulation 3: fully incremental cost-effectiveness analysis, withdrawal scenario 1	315
TABLE 218 Treatment effects from independent analysis for mild–moderate psoriasis, subpopulation 3: fully incremental cost-effectiveness analysis, withdrawal scenario 1	316
TABLE 219 Treatment effects from independent analysis for no concomitant psoriasis, subpopulation 3: fully incremental cost-effectiveness analysis, withdrawal scenario 1	316
TABLE 220 Treatment effects from independent analysis for moderate–severe psoriasis, subpopulation 2: fully incremental cost-effectiveness analysis, withdrawal scenario 2	316
TABLE 221 Treatment effects from independent analysis for mild–moderate psoriasis, subpopulation 2: fully incremental cost-effectiveness analysis, withdrawal scenario 2	316
TABLE 222 Treatment effects from independent analysis for no concomitant psoriasis, subpopulation 2: fully incremental cost-effectiveness analysis, withdrawal scenario 2	317
TABLE 223 Treatment effects from independent analysis for moderate–severe psoriasis, subpopulation 3: fully incremental cost-effectiveness analysis, withdrawal scenario 2	317
TABLE 224 Treatment effects from independent analysis for mild–moderate psoriasis, subpopulation 3: fully incremental cost-effectiveness analysis, withdrawal scenario 2	317
TABLE 225 Treatment effects from independent analysis for no concomitant psoriasis, subpopulation 3: fully incremental cost-effectiveness analysis, withdrawal scenario 2	317

List of figures

FIGURE 1 Flow chart showing the number of studies identified and eligible for inclusion	10
FIGURE 2 Forest plot of the efficacy of 300 mg of SEC vs. placebo for PASI 75 at 12 weeks in PsA patients with moderate–severe psoriasis	41
FIGURE 3 Long-term response rates in the FUTURE 2 trial SEC patients who were (a) ACR 20, (b) ACR 50 or (c) ACR 70 responders at 16 weeks	53
FIGURE 4 Long-term response rates in the FUTURE 2 trial SEC patients who were (a) PASI 50, (b) PASI 75 or (c) PASI 90 responders at 16 weeks	53
FIGURE 5 Long-term response rates in the RAPID-PsA trial CZP patients who were (a) ACR 20, (b) ACR 50 or (c) ACR 70 responders at 12 weeks	56
FIGURE 6 Long-term response rates in the RAPID-PsA trial CZP patients who were (a) PASI 50, (b) PASI 75 or (c) PASI 90 responders at 12 weeks	56
FIGURE 7 Network of evidence (not outcome or subgroup specific)	76
FIGURE 8 Schematic of the York model	107
FIGURE 9 Illustration of the progression of arthritis for a patient successfully maintained on a biologic, a patient without a biologic and a patient who withdraws at 5 years, as implemented in the York model	110
FIGURE 10 Overview of the UCB Pharma model structure	116
FIGURE 11 Overview of the Novartis model structure	117
FIGURE 12 Illustration of HAQ-DI score change for patients responding to a biologic treatment in the UCB Pharma model	118
FIGURE 13 Interventions and comparators according to subpopulations (UCB Pharma)	120
FIGURE 14 Interventions and comparators according to subpopulations (Novartis)	120
FIGURE 15 Overview of the model structure	137
FIGURE 16 Treatment sequences in subpopulation 1	141
FIGURE 17 Treatment sequences in subpopulation 2	142
FIGURE 18 Treatment sequences in subpopulation 3	142
FIGURE 19 Utility corresponding to alternative HAQ-DI trajectories	148

FIGURE 20 Range of values and distributions for PASI 75 response for the treatments	169
FIGURE 21 The PsARC response in the biologic-naive subpopulation: plot of trial-specific observed log-odds of placebo responses and ORs on log-scale (all 13 trials)	227
FIGURE 22 The PsARC response in the biologic-naive subpopulation: plot of trial-specific observed log-odds of placebo responses and ORs on log-scale (excluding Mease <i>et al.</i> and Genovese <i>et al.</i>)	228

Glossary

Adverse effect An abnormal or harmful effect, such as death, a physical symptom or visible illness, caused by, and attributable to, exposure to a chemical (e.g. a drug). An effect may be classed as adverse if it causes functional or anatomical damage or irreversible change in the homeostasis of the organism, or if it increases the susceptibility of the organism to another chemical or biological stress.

American College of Rheumatology improvement criteria Measures of the improvement in disease severity based on threshold percentage improvements of 20%, 50% or 70%. To meet the criteria, a reduction in the tender joint count and swollen joint count and an improvement in at least three out of the five additional measures (patient and physician global health assessment, pain, disability and levels of an acute-phase reactant) are required.

Anti-tumour necrosis factor/biologic experienced Previously treated with a biologic therapy.

Anti-tumour necrosis factor/biologic naive Not previously treated with a biologic therapy.

Apremilast An orally administered small-molecule drug that inhibits an enzyme involved in tumour necrosis factor production. Apremilast (Otezla®, Celgene Corporation, Summit, NJ, USA) is not a biologic therapy.

Arthritis A disorder involving inflammation of the joint(s), but which is often taken to include all joint disorders. Joints can be permanently damaged through the disease process of arthritis.

Articular Of or relating to joints.

Between-study variance A measure of statistical heterogeneity that depends on the scale of the outcome measured. It represents the variation in reported study effects over and above the variation expected given the within-study variation.

Biological therapy (biologic) Any pharmaceutical product derived from biological sources. Biologics used in the treatment of psoriatic arthritis treatment are generally monoclonal antibodies that bind to, and inactivate, immune cell-signalling molecules (e.g. tumour necrosis factor and interleukins), thereby dampening the inflammatory response.

Biosimilar An imitation biological medical product (such as an anti-tumour necrosis factor) usually marketed by a manufacturer other than the manufacturer of the original biological product once a patent has expired. It should be similar to the original licensed product in terms of safety and efficacy.

C-reactive protein A protein found in the blood, the concentration of which is raised by inflammation, for example in rheumatoid arthritis, and the level of which is used as a measure of disease activity.

Ciclosporin A medication originally developed to prevent the immune system from rejecting transplanted organs but which has also proved helpful in treating psoriasis.

Confidence interval The typical ('classical' or 'frequentist') definition is the range within which the 'true' value (e.g. size of effect of an intervention) would be expected to lie if sampling could be repeated a large number of times (e.g. 95% or 99%).

Cost–benefit analysis An economic analysis that converts the effects or consequences of interventions into the same monetary terms as the costs and compares them using a measure of net benefit or a cost–benefit ratio.

Cost-effectiveness analysis An economic analysis that expresses the effects or consequences of interventions on a single dimension. This would normally be expressed in ‘natural’ units (e.g. cases cured, life-years gained). The difference between interventions in terms of costs and effects is typically expressed as an incremental cost-effectiveness ratio (e.g. the incremental cost per life-year gained).

Cost–utility analysis The same as a cost-effectiveness analysis, but the effects or consequences of interventions are expressed in generic units of health gain, usually quality-adjusted life-years.

Credible interval In Bayesian statistics, a posterior probability interval estimation that incorporates problem-specific contextual information from the prior distribution. It is used for a purpose similar to that of a confidence interval in frequentist statistics.

Crohn’s disease An inflammatory condition of the digestive tract; rheumatic diseases are often associated with it and ulcerative colitis is related to it.

Dactylitis Inflammation of an entire digit caused by simultaneous joint and tendon inflammation.

Deviance information criterion A model fit statistic and used for Bayesian model comparison. The model with the smallest deviance information criterion is estimated to be the model that would best predict a replicate data set that has the same structure as that currently observed.

Disease-modifying antirheumatic drugs Drugs capable of modifying the progression of rheumatic disease. The term is, however, applied to what are now considered to be traditional (or conventional) disease-modifying drugs, in particular sulfasalazine, methotrexate and ciclosporin, as well as azathioprine, cyclophosphamide, antimalarials, penicillamine and gold. The newer agent leflunomide is also a disease-modifying antirheumatic drug. Biologics are not generally referred to as disease-modifying antirheumatic drugs, although occasionally biological disease-modifying antirheumatic drugs may be used.

Dominated A term, used in this report in the cost-effectiveness sections, that describes a treatment associated with higher costs and a lower number of quality-adjusted life-years than another treatment.

Enthesitis Inflammation of the region where tendons and ligaments attach to the bone (enthesis).

Erythrocyte sedimentation rate One of the tests designed to measure the degree of inflammation.

EuroQol-5 Dimensions questionnaire A standardised instrument for measuring generic health-related quality of life, used in the computation of the number of quality-adjusted life-years gained.

Extendedly dominated A term, used in this report in the cost-effectiveness sections, to describe a strategy in which the incremental cost-effectiveness ratio is higher than that of the next most effective strategy. Therefore, an extendedly dominated strategy produces additional gains in effectiveness at incremental costs higher than those of the next most effective strategy.

Fixed-effect model A statistical model that stipulates that the units under analysis (e.g. people in a trial or study in a meta-analysis) are the ones of interest, and thus constitute the entire population of units. Only within-study variation is taken to influence the uncertainty of results (as reflected in the confidence interval) of a meta-analysis using a fixed-effect model.

Health Assessment Questionnaire-Disability Index A self-administered questionnaire measuring an individual's physical disability and pain. It scores ability to perform various activities between 0 (without any difficulty) and 3 (unable to do). It is reported as an average of all activity scores.

Heterogeneity In systematic reviews, the variability or differences between studies in the estimates of effects. A distinction is sometimes made between 'statistical heterogeneity' (differences in the reported effects), 'methodological heterogeneity' (differences in study design) and 'clinical heterogeneity' (differences between studies in key characteristics of the participants, interventions or outcome measures).

Intention-to-treat analysis An analysis in which all the participants in a trial are analysed according to the intervention to which they were allocated, whether they received it or not.

Leeds Dactylitis Index A measure of swelling between digital joints. A dactylometer is used to measure the circumference of an affected digit, and the contralateral unaffected digit, and the ratio of the circumferences is calculated. If both hands are affected, a standard reference is used to calculate the ratio. A difference in circumference of $\geq 10\%$ defines a finger with dactylitis. The tenderness of each digit is also taken into account to generate a score for each. If multiple digits are affected, the scores for each are added together.

Leeds Enthesitis Index A measure of tenderness over six tendon attachment sites (enthuses). It also includes an assessment for soft tissue swelling. It is scored from 0 to 6.

Methotrexate One of the oldest chemotherapy drugs used in the treatment of cancer and autoimmune diseases, such as rheumatoid and psoriatic arthritis.

Modified total Sharp score One of several radiological assessments used to measure joint damage in psoriatic arthritis. This method grades all joints of the hand separately for erosions and joint space narrowing for 64 and 52 joints (out of a maximum score of 149), respectively, with higher scores representing greater damage. The total Sharp score is modified to include other joints in the assessment.

Monoclonal antibody An antibody produced using a single clone of cells with affinity for one particular antigen.

Network meta-analysis (Synonyms: mixed treatment comparison, indirect treatment comparison.) Used when there is insufficient direct evidence linking two interventions, this is a type of meta-analysis comparing three or more different treatments using both direct comparison within randomised controlled trials and indirect comparison between trials based on a common comparator (such as placebo).

Non-steroidal anti-inflammatory drug Any of a large range of drugs in the aspirin family, prescribed for different kinds of arthritis, that reduces inflammation and controls pain, swelling and stiffness.

Placebo An inactive substance or procedure administered to a patient, usually to compare its effects with those of a real drug or other intervention, but sometimes for the psychological benefit to the patient through a belief that she/he is receiving treatment.

Plaque psoriasis The most common form of psoriasis, also known as psoriasis vulgaris, characterised by red, raised lesions covered by silvery scales. About 80% of patients with psoriasis have this type.

Psoriasis A chronic skin disease characterised by inflammation and scaling. Scaling occurs when cells in the outer layer of skin are produced faster than normal and build up on the skin's surface. It is thought to be caused by a disorder of the immune system.

Psoriasis Area and Severity Index A measure of the extent of skin affected and of the redness, scaliness and thickness of psoriatic plaques. Response is presented as PASI 50, PASI 75 or PASI 90, the number being the percentage reduction in Psoriasis Area and Severity Index score from baseline.

Psoriatic arthritis A disease characterised by stiffness, pain and swelling in the joints, especially of the hands and feet. It affects about 30% of people with psoriasis. Early diagnosis and treatment can help inhibit the progression of joint deterioration.

Psoriatic Arthritis Response Criteria response An improvement of at least 30% in the tender or swollen joint count as well as a 1-point improvement on a 5-point scale of the patient's and/or physician's assessment. The National Institute for Health and Care Excellence defines a response as an improvement in two or more of the four assessment criteria (with no worsening of any of these four measures).

Quality-adjusted life-year An index of health gain according to which survival duration is weighted or adjusted by the patient's quality of life during the survival period. It has the advantage of incorporating changes in both quantity (mortality) and quality (morbidity) of life.

Quality of life A concept incorporating all the factors that might have an impact on an individual's life, including factors such as the absence of disease or infirmity as well as other factors that might affect that individual's physical, mental and social well-being.

Random-effects model A statistical model sometimes used in meta-analysis in which both within-study sampling error (variance) and between-studies variation are included in the assessment of the uncertainty (confidence interval) of the results of a meta-analysis.

Randomised controlled trial (Synonym: randomised clinical trial.) An experiment in which investigators randomly allocate eligible people to intervention groups to receive or not receive one or more interventions that are being compared.

Relative risk (Synonym: risk ratio.) The ratio of risk in the intervention group to the risk in the control group. The risk (proportion, probability or rate) is the ratio of people with an event in a group to the total number in the group. A relative risk of 1 indicates no difference between comparison groups. In the case of undesirable outcomes, a relative risk of < 1 indicates that the intervention was effective in reducing the risk of that outcome.

Remission A lessening or abatement of the symptoms of a disease.

Residual deviance An analysis used for model comparison and goodness of fit. It is equal to the deviance for a given model minus the deviance for a saturated model. A saturated model is one in which all of the predictions from the model are equal to the observed data values. Total residual deviance should approximate the number of data points for a good fit.

Rheumatoid arthritis A chronic autoimmune disease characterised by pain, stiffness, inflammation, swelling, and, sometimes, destruction of joints.

Sensitivity analysis An analysis used to determine how sensitive the results of a study or systematic review are to changes in how it was done. It is used to assess how robust the results are to uncertain decisions or assumptions about the data and the methods that were used.

Short Form questionnaire-36 items A patient-reported survey of general health status.

Statistical significance An estimate of the probability of an association (effect) as large as or larger than what is observed in a study occurring by chance, usually expressed as a p -value.

Subpopulation 1 Patients who are biologic naive but have tried one previous conventional disease-modifying antirheumatic drug.

Subpopulation 2 Patients who are biologic naive but have tried two or more previous conventional disease-modifying antirheumatic drugs.

Subpopulation 3 Patients who are biologic experienced.

Tender joint count and swollen joint count Assessment of the condition of 28 joints important to functional status. Used in the calculation of several composite disease activity scores such as Disease Activity Score 28.

Tumour necrosis factor alpha A cell signalling molecule (cytokine) involved in the inflammatory response pathway, known to be fundamental to the pathological processes causing psoriasis and psoriatic arthritis. Plays a key role in onset and persistence of joint and skin inflammation.

List of abbreviations

ACR	American College of Rheumatology	CS	company submission
ACR 20	20% improvement in the American College of Rheumatology criteria	CZP	certolizumab pegol
ACR 50	50% improvement in the American College of Rheumatology criteria	DA	deterministic analysis
ACR 70	70% improvement in the American College of Rheumatology criteria	DANBIO	Danish Database for Biological Therapies
ADA	adalimumab	DARE	Database of Abstracts of Reviews of Effects
ADEPT	ADalimumab Effectiveness in Psoriatic arthritis Trial	DIC	deviance information criterion
AE	adverse event	DMARD	disease-modifying antirheumatic drug
AG	Assessment Group	EQ-5D	EuroQol-5 Dimensions
APR	apremilast	ERASURE	Efficacy of Response and Safety of Two Fixed Secukinumab Regimens in Psoriasis
BNF	<i>British National Formulary</i>	ERG	Evidence Review Group
BSA	body surface area	ESR	erythrocyte sedimentation rate
BSC	best supportive care	ETN	etanercept
BSR	British Society for Rheumatology	EULAR	European League Against Rheumatism
BSRBR	British Society for Rheumatology Biologics Register	FIXTURE	Full Year Investigative Examination of Secukinumab vs. Etanercept Using Two Dosing Regimens to Determine Efficacy in Psoriasis
CASPAR	Classification Criteria for Psoriatic Arthritis	FUTURE	Efficacy at 24 Weeks and Long Term Safety, Tolerability and Efficacy up to 2 Years of Secukinumab (AIN457) in Patients With Active Psoriatic Arthritis
cDMARD	conventional disease-modifying antirheumatic drug		
CDSR	Cochrane Database of Systematic Reviews		
CENTRAL	Cochrane Central Register of Controlled Trials	GO-REVEAL	Golimumab – A Randomized Evaluation of Safety and Efficacy in Subjects with Psoriatic Arthritis Using a Human Anti-TNF Monoclonal Antibody
CI	confidence interval	GOL	golimumab
CLEAR	Efficacy of Secukinumab Compared to Ustekinumab in Patients with Plaque-type Psoriasis	GP	general practitioner
CPCI-S	Conference Proceedings Citation Index – Science	HAQ-DI	Health Assessment Questionnaire-Disability Index
CrI	credible interval		
CRP	C-reactive protein		

LIST OF ABBREVIATIONS

HR	hazard ratio	PASI 90	90% reduction in the Psoriasis Area and Severity Index
HRQoL	health-related quality of life	PNR	placebo non-responder
HTA	Health Technology Assessment	PR	placebo responder
i.v.	intravenous	PRESTA	Psoriasis Randomized Etanercept study in Subjects with psoriaTic Arthritis
ICER	incremental cost-effectiveness ratio	PsA	psoriatic arthritis
IL	interleukin	PSA	probabilistic sensitivity analysis
IMPACT	Infliximab Multinational Psoriatic Arthritis Controlled Trial	PsARC	Psoriatic Arthritis Response Criteria
INF	infliximab	PSSRU	Personal Social Services Research Unit
ITT	intention to treat	PSUMMIT	Study of the Safety and Effectiveness of Ustekinumab in Patients With Psoriatic Arthritis
LDI	Leeds Dactylitis Index	QALY	quality-adjusted life-year
LEI	Leeds Enthesitis Index	RA	rheumatoid arthritis
LOCF	last observation carried forward	RAPID-PsA	Certolizumab Pegol in Subjects With Adult Onset Active and Progressive Psoriatic Arthritis
MeSH	medical subject heading	RCT	randomised controlled trial
MIMS	online and print prescribing database for health professionals	RR	relative risk
MTA	multiple technology appraisal	SAE	serious adverse event
mTSS	modified total Sharp score	SCI	Science Citation Index
MTX	methotrexate	SD	standard deviation
NHS EED	NHS Economic Evaluation Database	SE	standard error
NICE	National Institute for Health and Care Excellence	SEC	secukinumab
NMA	network meta-analysis	SF-36	Short Form questionnaire-36 items
NOAR	Norfolk Arthritis Register	SJC	swollen joint count
NOR-DMARD	Norwegian Antirheumatic Drug Register	SoC	standard of care
NSAID	non-steroidal anti-inflammatory drug	SPIRIT-P1	Study of Ixekizumab in Participants With Active Psoriatic Arthritis
OR	odds ratio	STA	single technology appraisal
PALACE	Psoriatic Arthritis Long-term Assessment of Clinical Efficacy	TA	technology appraisal
PASI	Psoriasis Area and Severity Index	TB	tuberculosis
PASI 50	50% reduction in the Psoriasis Area and Severity Index	THIN	The Health Improvement Network
PASI 75	75% reduction in the Psoriasis Area and Severity Index	TJC	tender joint count

TNF	tumour necrosis factor	UST	ustekinumab
TNF- α	tumour necrosis factor alpha	VAS	visual analogue scale
TNR	treatment non-responder	YODA	Yale University Open Data Access
TR	treatment responder		

Note

This monograph is based on the Technology Assessment Report produced for NICE. The full report contained a considerable number of data that were deemed confidential. The full report was used by the Appraisal Committee at NICE in their deliberations. The full report with each piece of confidential data removed and replaced by the statement 'confidential information (or data) removed' is available on the NICE website: www.nice.org.uk.

The present monograph presents as full a version of the report as is possible while retaining readability, but some sections, sentences, tables and figures have been removed. Readers should bear in mind that the discussion, conclusions and implications for practice and research are based on all the data considered in the original full NICE report.

Plain English summary

Psoriatic arthritis (PsA) is an inflammatory disease that involves both skin (psoriasis) and joints. It can greatly reduce a person's quality of life. For patients who have severe active PsA who have not responded sufficiently to conventional treatments, the National Institute for Health and Care Excellence (NICE) currently recommends a number of effective biologic therapies. The purpose of this project was to assess the benefits, harms and cost-effectiveness of two new biologic therapies – certolizumab pegol (CZP; CIMZIA®, UCB Pharma, Brussels, Belgium) and secukinumab (SEC; COSENTYX®, Novartis International AG, Basel, Switzerland) – and to compare them with existing therapies.

We identified and analysed all of the data from relevant clinical trials. The results showed that both CZP and SEC are effective therapies for improving the symptoms of PsA. Although side effects might result from these treatments, they are uncommon. It is not clear which, if any, of the many biologic therapies is best, although SEC seems particularly good at improving psoriasis symptoms.

Economic modelling found that these new biologics can be considered a cost-effective use of NHS resources when compared with the other therapies currently recommended by NICE for treating PsA. Which treatment is most cost-effective depends on which previous treatments a patient has tried and not responded to, the severity of the psoriasis symptoms, and the price of the treatment. Some of the study's results were somewhat limited because not enough relevant clinical trial data were available.

Scientific summary

Background

Psoriatic arthritis (PsA) is a chronic, immune-mediated inflammatory arthritis, closely associated with psoriasis of the skin and nails, that typically affects joints in the hands, feet and spine. It can cause joint damage so early diagnosis and treatment is important. Current practice typically involves early use of non-steroidal anti-inflammatory drugs followed by disease-modifying antirheumatic drugs (DMARDs), if necessary. When conventional disease-modifying antirheumatic drugs (cDMARDs) are ineffective, biologic therapies may be used; for example, anti-tumour necrosis factor (TNF) biologics such as etanercept [(ETN); ENBREL®; Pfizer Inc., New York City, NY, USA], infliximab [(INF) REMICADE®; Merck Sharp & Dohme, Kenilworth, NJ, USA], adalimumab [(ADA) HUMIRA®; AbbVie Inc., North Chicago, IL, USA] and golimumab [(GOL) SIMPONI®; Merck Sharp & Dohme, Kenilworth, NJ, USA] are approved by the National Institute for Health and Care Excellence (NICE) for patients who have had an inadequate response to two or more DMARDs. Ustekinumab [(UST) STELARA®; Janssen Pharmaceuticals, Inc., Horsham, PA, USA], which is an anti-interleukin (IL)-12/23 – a different kind of biologic therapy to anti-TNFs – is also recommended as a possible treatment, specifically when DMARDs have not worked well enough, provided that treatment with anti-TNFs is not suitable, or the patient has had an anti-TNF before. NICE does not specifically recommend switching anti-TNF treatments other than the guidance for UST and switching decisions can vary depending on local guidelines. The newer biologics, secukinumab [(SEC) COSENTYX®; Novartis International AG, Basel, Switzerland; an anti-IL-17] and certolizumab pegol [(CZP) CIMZIA®; UCB Pharma, Brussels, Belgium; an anti-TNF], have not previously been appraised by NICE for treating PsA.

Objective

To determine the clinical effectiveness and cost-effectiveness of CZP and SEC within their marketing authorisations for treating active PsA in adults in whom DMARDs have been inadequately effective.

Methods

For the systematic review of clinical efficacy, randomised controlled trials (RCTs) were eligible, including open-label extensions. Adverse events (AEs) data were sought from existing safety reviews of biologics. Patient registry studies (of patients taking biologics) and studies of natural history of disease (in patients not taking biologics) were also sought. Eligible studies were of adults with PsA. The treatments of interest were SEC and CZP with the relevant comparators being ETN, INF, ADA, GOL, UST, apremilast (APR; Otezla®, Celgene Corporation, Summit, NJ, USA) and placebo.

Fourteen databases (including MEDLINE and EMBASE) were searched for relevant studies from inception to April 2016 for CZP and SEC studies; update searches were run to identify new comparator studies. Clinical effectiveness data from RCTs were synthesised using Bayesian network meta-analysis (NMA) methods to formally investigate the relative efficacy of SEC and CZP compared with the other active comparators. Analyses were conducted on four outcomes: Psoriatic Arthritis Response Criteria (PsARC); Health Assessment Questionnaire-Disability Index (HAQ-DI), conditional on PsARC response; Psoriasis Area and Severity Index (PASI); and American College of Rheumatology improvement criteria. Results from other studies were summarised narratively.

Methods of cost-effectiveness review

A systematic review was undertaken to identify published evidence on the cost-effectiveness of CZP and SEC in PsA. This also includes the company submissions (CSs) from Novartis (SEC) and UCB Pharma (CZP). The systematic review also includes a broader assessment of published decision-analytic models for relevant comparators INF, ETN, ADA, GOL and UST. The differences in the model structures and assumptions used across the studies were examined to identify any important differences in approaches and areas of remaining uncertainty.

Methods of economic modelling

A de novo decision-analytic model was developed to estimate the cost-effectiveness of SEC and CZP compared with other relevant comparators including ETN, INF, ADA, GOL, UST and best supportive care (BSC) for the treatment of adult PsA. A different set of comparators are defined according to each subpopulation of interest. Here BSC includes the use of cDMARDs. The cost-effectiveness model takes the form of a lifetime (40 years) Markov cohort model, developed using the R programming language (The R Foundation for Statistical Computing, Vienna, Austria). Outcomes are expressed using quality-adjusted life-years (QALYs). The parameters of the model were obtained from published literature, manufacturers' reported data and the results of the evidence synthesis. Probabilistic sensitivity analysis (PSA) was used to explore decision uncertainty.

Although the model shares a number of important characteristics with the previous York model [Rodgers M, Epstein D, Bojke L, Yang H, Craig D, Fonseca T, *et al.* Etanercept, infliximab and adalimumab for the treatment of psoriatic arthritis: a systematic review and economic evaluation. *Health Technol Assess* 2011;**15**(10)], several significant changes have also been implemented. These include:

- incorporation of subsequent biologic treatments following primary lack of response or secondary failure
- three subpopulations specified in the NICE scope for this appraisal
- three subgroups according to the level of concomitant psoriasis.

Results of the clinical effectiveness review

Nineteen eligible RCTs were included in the systematic review of short-term efficacy. Most studies were well conducted and were rated as being at low risk of bias.

Short-term efficacy in pivotal randomised controlled trials

Four eligible trials were of SEC and one was of CZP. Results from the pivotal RCTs of SEC and CZP demonstrated their short-term efficacy. Both therapies were associated with statistically significant improvements in all key clinical outcomes. At 3 months, patients taking SEC (150 or 300 mg) were around six times more likely to show 50% improvement in the American College of Rheumatology criteria (ACR 50) – an important clinical outcome to patients – than patients taking placebo. Patients taking CZP were around three times more likely to be ACR 50 responders than placebo patients. Clinically important improvements in activities of daily living (as assessed using HAQ-DI) were also evident for both therapies, particularly in patients who were PsARC responders. Both SEC and CZP also significantly improved measures of health-related quality of life and the resolution of enthesitis and dactylitis.

However, when the populations from these two trials were split into subgroups based on previous biologic experience, the results for the biologic-experienced subgroups became difficult to interpret. This was because of the low numbers of placebo-treated patients (and placebo events) and the differences in placebo response rates across subgroups. A further complication is that the evidence for CZP does not include patients who failed to respond to a first anti-TNF. Although SEC and, probably, CZP are efficacious in both subgroups, it is not possible to make robust conclusions about any difference in efficacy of these drugs across these subgroups.

Subgroup results from PsA patients recruited to trials of patients with quite severe psoriasis suggested that SEC may be particularly efficacious in treating the psoriasis symptoms of PsA.

Short-term efficacy compared with other therapies from network meta-analyses

The trials identified to inform a comparison of SEC and CZP with other therapies were performed across a 15-year period and variation in the placebo response was evident for some important outcomes: larger placebo response rates were seen in the more recent trials. There was also important variation across trials with regard to patients' previous use of a biologic therapy: subgroups of biologic-experienced patients were recruited only in more recent trials. The NMAs were therefore performed on the biologic-naïve and biologic-experienced subpopulations separately, and included models that adjusted for, and explored, the different rates of placebo response across trials.

Across all outcomes, the NMA results for the biologic-naïve subpopulation indicated that, although SEC and CZP were effective, their relative effectiveness compared with ETN, ADA, GOL and INF and with each other was uncertain (the rankings of treatment varied with outcome and analysis). However, both agents did seem consistently more effective than APR. The results indicate that SEC and INF are the most effective in terms of PASI response.

Only SEC and UST could be included in the analyses of the biologic-experienced subpopulation. The results showed that, across all outcomes analysed, both SEC and UST were significantly more effective than placebo. Most of the results suggested SEC may be better than UST. However, the patient numbers in this subpopulation were quite low; the results were therefore uncertain (with wide overlapping credible intervals).

Long-term efficacy

Results from open-label trial extension studies that radiographically assessed joint damage indicated that, after 2 years of treatment, CZP effectively reduced disease progression with the benefits appearing similar to those observed in the open-label studies of the other biologics. Fewer result details were available for SEC at 2 years, although the results also indicated effective reduction in radiographic disease progression. Meaningful treatment comparisons of longer-term data for other outcomes were difficult to undertake as a result of the variation in both time points assessed and in methodological approaches used for data analyses. (Confidential information has been removed.)

Results from other studies

Patient registry studies suggested that, although patients benefit from a second or further anti-TNFs, the expected benefit from anti-TNFs diminishes after switching, with a reduced chance of response and reduced drug survival. The paucity of observational data on the natural history of PsA meant that it was difficult to produce accurate estimates of yearly disease progression rates in patients not receiving anti-TNF therapy.

The results from three systematic reviews of AEs suggested that CZP was associated with statistically significantly more serious AEs and serious infections than placebo. Although the safety data for SEC appear promising, there is still some uncertainty regarding the safety of this drug.

Results of the cost-effectiveness evaluation

Cost-effectiveness reported in existing published studies and manufacturer submissions

No previously published cost-effectiveness studies of SEC or CZP for PsA were identified. The companies submitted de novo analyses for SEC (Novartis) and CZP (UCB Pharma).

For the broader set of comparators, the systematic search of published literature identified nine studies that met the inclusion criteria for the cost-effectiveness review, including seven UK studies, only one of which was not directly related to a previous NICE technology appraisal (TA). All of these models employed similar model structures to that originally proposed by Rodgers *et al.* [Rodgers M, Epstein D, Bojke L, Yang H, Craig D, Fonseca T, *et al.* Etanercept, infliximab and adalimumab for the treatment of psoriatic arthritis: a systematic review and economic evaluation. *Health Technol Assess* 2011; **15**(10)] for TA199 (the previous York model). The main differences between these models are in relation to the comparators and associated evidence base, which has altered since TA199, rather than in terms of major structural differences. The choice of optimal treatment, ETN, is consistent across the published models.

The manufacturers' models are the only studies that directly assess the decision problem in relation to the new interventions [i.e. the positioning of SEC and CZP across the pathway for PsA (biologic-naive and biologic-experienced populations)]. Both have a similar structure to the previous York model. However, there are a number of key differences, including the comparators included in each of the subpopulations; clinical evidence used and the methods employed in the evidence synthesis; the source of cost data for HAQ-DI and PASI data; and the rate of withdrawal for patients who have initially responded to biologic therapy and baseline characteristics in terms of HAQ-DI and particularly PASI scores. Neither submission reports a list price analysis, instead reporting results using confidential Patient Access Scheme prices.

Cost-effectiveness results from de novo modelling

The de novo model, which addressed many of the issues of earlier published models, generated incremental cost-effectiveness ratios (ICERs) for three subpopulations according to the position in the pathway of treatment and three subgroups according to severity of psoriasis:

- For subpopulation 1 (one prior DMARD): in the moderate–severe subgroup, the pairwise ICERs for CZP and 300 mg of SEC compared with BSC are £20,870 and £26,064 per QALY, respectively. In the fully incremental analysis, the ICER for 300 mg of SEC compared with CZP is £134,783; therefore, CZP is likely to be the optimal treatment. In the mild–moderate psoriasis group, the pairwise ICERs for CZP and 150 mg of SEC compared with BSC are £23,052 and £21,772 per QALY, respectively. In the fully incremental analysis, CZP is dominated by 150 mg of SEC and, therefore, 150 mg of SEC is likely to be the optimal treatment. In the no concomitant psoriasis subgroup, pairwise ICERs for 150 mg of SEC and CZP compared with BSC are £23,928 and £24,774 per QALY, respectively. In the fully incremental analysis, the ICER for CZP compared with 150 mg of SEC is £346,785 and, therefore, 150 mg of SEC is likely to be the optimal treatment.
- For subpopulation 2 (two or more prior DMARDs): in the moderate–severe subgroup, the pairwise ICERs for CZP and 300 mg of SEC compared with BSC are £21,564 and £29,569 per QALY, respectively. In the fully incremental analysis, 300 mg of SEC is dominated and CZP is extendedly dominated. Of the remaining non-dominated alternatives, ETN is likely to be the optimal treatment, with an ICER of £21,215 compared with GOL. For the mild–moderate psoriasis subgroup, the pairwise ICERs for CZP and 150 mg of SEC compared with BSC are £24,103 and £22,032 per QALY, respectively. In the fully incremental analysis, CZP and GOL are dominated and ADA is extendedly dominated. Of the remaining non-dominated alternatives, ETN is likely to be the optimal treatment, with an ICER of £23,256 per QALY compared with 150 mg of SEC. For the no concomitant psoriasis subgroup, the individual pairwise ICERs for CZP and 150 mg of SEC compared with BSC are £24,103 and £22,032 per QALY, respectively. ETN is likely to be the optimal treatment in this subgroup with an ICER of £23,883 compared with BSC (fully incremental analysis).
- For subpopulation 3 (biologic experienced): in the moderate–severe subgroup, the individual pairwise ICER for 300 mg of SEC compared with BSC is £36,013. In the fully incremental analysis, the ICER for UST versus BSC is £21,684 per QALY and the ICER for 300 mg of SEC is £85,013 per QALY. In the mild–moderate subgroup the pairwise ICER for 300 mg of SEC compared with BSC is £40,639. In the fully incremental analysis, the ICER for UST versus BSC is £24,510 per QALY and the ICER for 300 mg of SEC versus UST is £97,713 per QALY. In the no concomitant subgroup the pairwise ICER for 300 mg of SEC compared with BSC is £44,774. In the fully incremental analysis, the ICER for UST versus BSC is £26,797 per QALY and the ICER for 300 mg of SEC versus UST is £111,927 per QALY.

The model also explores a number of uncertainties through the use of scenario analysis, and found that:

- The optimal treatment in subpopulation 2 was sensitive to the choice of evidence synthesis model.
- In the contraindicated subgroup (subpopulation 4), UST appears to be the most cost-effective treatment in patients with moderate–severe psoriasis (ICER of £19,969 compared with BSC); however, in those with mild–moderate psoriasis or no concomitant psoriasis, 150 mg of SEC appears to be the most cost-effective treatment (ICERs of £19,349 and £22,334 compared with BSC for these two subgroups, respectively).

- In the biologic-experienced subgroup including only secondary failures, CZP seems to be cost-effective compared with BSC, with ICERs of £16,573, £19,113 and £20,973 for the moderate–severe, mild–moderate and no concomitant psoriasis group, respectively.
- The optimal treatment is not sensitive to the use of biosimilar prices for ETN and INF.
- In subpopulation 1, the optimal treatment is consistent across the two scenarios for baseline HAQ-DI score, base-case assumption (1.22) and using a subpopulation-specific baseline HAQ-DI score.
- In subpopulations 2 and 3, aside from the use of the Poole *et al.* (Poole CD, Lebmeier M, Ara R, Rafia R, Currie CJ. Estimation of health care costs as a function of disease severity in people with psoriatic arthritis in the UK. *Rheumatology* 2010;**49**:1949–56) HAQ-DI costs, the optimal treatment is consistent across all scenarios (subpopulation-specific baselines and alternative withdrawal rates).

The PSA demonstrated that, despite the ICERs being broadly consistent between the deterministic analysis and the means of the PSA, there is considerable decision uncertainty regarding the optimal treatment, at both £20,000 and £30,000 per QALY thresholds.

Discussion

The key strengths of the systematic review are the rigorous methods used and the breadth of the types of study included. The updated York model confers several advantages over current published cost-effectiveness studies, namely the inclusion of the three subpopulations according to the position in the pathway of treatment, the explicit consideration of the severity of concomitant psoriasis and the modelling of subsequent treatments following primary non-response or secondary failure. The York model also facilitates a more consistent basis for evaluating CZP and SEC by ensuring comparability of methods and inputs.

Conclusions

The NMA results for the biologic-naïve subpopulation indicated that, although SEC and CZP were effective across all outcomes after 3 months' therapy, their relative effectiveness compared with other biologics and with each other was uncertain. The results of the economic model indicated that CZP and SEC may be an effective use of NHS resources, depending on the subpopulation (based on prior treatments) and subgroup (according to psoriasis severity). There were a number of limitations to the assessment, mostly driven by data availability issues.

Suggested research priorities

Adequately powered trials are needed to better inform the efficacy of biologics in biologic-experienced populations. Further research is required to better elucidate the impact of biologics on radiographic disease progression and HAQ-DI in the long term.

Study registration

This study is registered as PROSPERO CRD42016033357.

Funding

Funding for this study was provided by the Health Technology Assessment programme of the National Institute for Health Research.

Chapter 1 Background

Description of health problem

Psoriatic arthritis (PsA) is a chronic autoimmune disease closely associated with psoriasis of the skin and nails, but distinct from rheumatoid arthritis (RA). PsA is one of a family of inflammatory arthritis disorders called spondyloarthritis (or spondyloarthropathy), which also includes ankylosing spondylitis.¹ PsA is closely linked with inflammatory bowel disease, especially the form called Crohn's disease.² Although any joint may be affected, PsA typically affects joints in the hands, feet and spine. Its course may be erratic, with flare-ups and remissions, but it can cause joint damage if it is not treated. Early diagnosis is important to avoid damage to joints.³ Symptoms of arthritis include inflamed (swollen), stiff and painful joints; and psoriasis symptoms include patchy, raised red areas of inflamed skin with scaling.⁴

The symptoms of psoriatic arthritis are similar to those of other forms of arthritis. The difference between PsA and RA is that the pattern of joint involvement is commonly asymmetrical, and involves the distal interphalangeal joints (in the hands and feet) and nail lesions. The following terms are used to present the patterns of PsA: oligoarthritis (four or fewer affected joints; 22–37% of patients); polyarthritis (five or more affected joints; 36–41% of patients); arthritis of distal interphalangeal joints (< 20% of patients); spondylitis (7–23% of patients); and arthritis mutilans (approximately 4% of patients).^{5,6} Most patients with PsA will have developed psoriasis first (i.e. joint complications occur around 10 years after initial diagnosis of psoriasis), although joint involvement appears first in 19% of patients and concurrently with psoriasis in 16% of cases.⁷

As PsA can affect both skin and joints, it can result in significant quality-of-life impairment, joint deformity and psychosocial disability.^{7,8} A recent survey of patients with RA, PsA and axial spondyloarthritis found that disease burden in terms of patient-reported outcome measures was similar in PsA and axial spondyloarthritis patients, but significantly lower for the RA patients.⁹ The physical and psychosocial problems experienced by patients affect their ability to perform paid work and everyday tasks; PsA has a substantial economic impact on the UK health-care system as a result of direct health-care costs as well as indirect costs, such as reduced work capacity.¹⁰

Patients with PsA have a 60% higher risk of premature mortality than the general population, with cardiovascular disease being the leading cause of death.^{11–13} The estimated reduction in life expectancy for patients with PsA is approximately 3 years,¹⁴ with a standardised mortality ratio of 1.62. A Canadian outpatient clinic study reported that mortality due to cardiovascular disease was 30% higher in patients with PsA than that in the general population.¹²

Diagnosis

It is difficult to define PsA because there are no precise diagnostic criteria or diagnostic markers.¹⁵ In general, diagnoses are primarily based on patient symptoms and physical examination. In most cases, Moll and Wright's 1973 criteria¹⁶ have been used for diagnosis. Several classification criteria have been introduced since Moll and Wright's criteria, but none has been widely accepted or validated. In 2006, the multicentre Classification Criteria for Psoriatic Arthritis (CASPAR) study developed new classification criteria that are simple and have both a high sensitivity and a high specificity; they are currently a preferred method to define cases of PsA (*Table 1*).¹⁷

TABLE 1 The Classification Criteria for Psoriatic Arthritis

To meet the CASPAR, a patient must have inflammatory articular disease (joint, spine or enthesal) with three points or more from the following five categories¹⁷

1. Evidence of psoriasis	Current psoriasis, ^a defined as psoriatic skin or scalp disease present today as judged by a rheumatologist or dermatologist A personal history of psoriasis, defined as a history of psoriasis that may be obtained from a patient, family physician, dermatologist, rheumatologist or other qualified health-care provider A family history of psoriasis, defined as a history of psoriasis in a first- or second-degree relative according to patient report
2. Psoriatic nail dystrophy	Typical psoriatic nail dystrophy, including onycholysis, pitting and hyperkeratosis, observed on current physical examination
3. Negative test result for rheumatoid factor	A negative test result for the presence of rheumatoid factor by any method except latex but preferably by an enzyme-linked immunosorbent assay or nephelometry, according to the local laboratory reference range
4. Dactylitis	Either current dactylitis, defined as swelling of an entire digit, or a history of dactylitis recorded by a rheumatologist
5. Radiographic evidence of juxta-articular new bone formation	Defined as ill-defined ossification near joint margins (but excluding osteophyte formation) on plain radiographs of the hand or foot

a Current psoriasis is assigned a score of 2; all other features are assigned a score of 1.

Epidemiology

The exact prevalence of PsA is unknown, but estimates vary from 0.3% to 1% of the population. It has been estimated that in England, in 2013, there were around 53,900–161,600 people with PsA. PsA affects men and women equally, in contrast to RA, which is more common in women.¹⁸

Psoriatic arthritis can develop at any time, including childhood,¹⁹ but normally it appears between the ages of 30 and 55 years.¹⁸ Its development is a complex process involving both environmental and genetic factors.^{20–22} Studies show a stronger genetic or family link to PsA than to other autoimmune rheumatic diseases. Around 40% of people who are diagnosed with PsA and psoriasis also have family members affected by the disease.²

Measurement of disease

In 2016, the Group for Research and Assessment of Psoriasis and the Psoriatic Arthritis Outcome Measures in Rheumatology Organisation PsA working group updated the core set of domains to be assessed in clinical trials to reflect both patient and physician priorities. The domain set includes musculoskeletal disease activity (which now includes enthesitis, dactylitis and spine symptoms, in addition to peripheral arthritis), skin disease activity, patient global assessment, pain, physical function, health-related quality of life (HRQoL), fatigue and systemic inflammation. Four new items were added to the research agenda: stiffness, independence, treatment burden and sleep.²³

Many trials of PsA have used 20% improvement in the American College of Rheumatology criteria (ACR 20) as the primary outcome;²⁴ the American College of Rheumatology (ACR) criteria were, however, developed to assess RA. The other outcome assessment tools that have commonly been used in clinical trials are:

- the Psoriatic Arthritis Response Criteria (PsARC), a multidomain measure which has similarities with ACR criteria but which was developed specifically for PsA
- the Psoriasis Area and Severity Index (PASI), to assess psoriasis

- the Health Assessment Questionnaire-Disability Index (HAQ-DI), to assess function (activities of daily living)
- various measures of enthesitis, dactylitis and radiographic progression of disease.

However, there are issues with some assessment tools:

- HAQ-DI concentrates on physical disability, which may not adequately capture disability in patients with predominantly skin disease. Consequently, there is less change in the context of treatment that has a predominant effect on the skin and not the joints.²⁵
- PASI has poor sensitivity to change and responsiveness when skin psoriasis is < 10% of body surface area (BSA) involvement. Furthermore, it has been stated that the correlation with quality-of-life measures is poor.²⁶ In addition, it is time-consuming and not practically very feasible in daily clinical practice.
- PsARC identifies only relative changes from baseline and overestimates the number of responders.²⁷ In general, PsARC placebo response rates are higher than other composite measures.²⁸

Current service provision

If PsA is not treated early, the inflammation can affect the whole body, which may lead to lasting joint and tissue damage.² The clinical management of PsA therefore aims to suppress joint, tendon and ligament inflammation, and to manage the skin symptoms of the disease. Current practice involves early diagnosis and early use of non-steroidal anti-inflammatory drugs (NSAIDs) and/or intra-articular corticosteroid injections. In patients who do not respond to these treatments, disease-modifying antirheumatic drugs (DMARDs) are then used [most commonly beginning with methotrexate (MTX)]. When conventional disease-modifying antirheumatic drugs (cDMARDs) are ineffective, or not tolerated, biologic therapies may be used; for example, anti-tumour necrosis factor (TNF) therapies, such as etanercept [(ETN) ENBREL®; Pfizer Inc., New York City, NY, USA], infliximab [(INF) REMICADE®; Merck Sharp & Dohme, Kenilworth, NJ, USA], adalimumab [(ADA) HUMIRA®; AbbVie Inc., North Chicago, IL, USA] and golimumab [(GOL) SIMPONI®; Merck Sharp & Dohme, Kenilworth, NJ, USA]. These anti-TNFs are approved by the National Institute for Health and Care Excellence (NICE). Anti-TNFs have been shown to slow the progression of joint damage when assessed radiographically.^{29,30} Ustekinumab [(UST) STELARA®; Janssen Pharmaceuticals, Inc., Horsham, PA, USA] – a different type of biologic therapy to anti-TNFs [being an interleukin (IL)-12/23 inhibitor] – is also recommended as a possible treatment, specifically when DMARDs have not worked well enough, provided that treatment with anti-TNFs is not suitable, or the patient has had an anti-TNF before. Apremilast [(APR) Otezla®; Celgene Corporation, Summit, NJ, USA], a phosphodiesterase 4 inhibitor, is not currently approved by NICE.

Current NICE guidance relates to the treatment of patients who have had an inadequate response to two or more cDMARDs (administered either individually or in combination). The British Society for Rheumatology (BSR)'s guidelines make a provision for using a biologic after one DMARD in the presence of adverse prognostic factors; these are defined as five or more swollen joints in association with an elevated C-reactive protein (CRP) concentration for more than 3 months and structural joint damage due to disease.³¹ Not all patients respond to an initial anti-TNF treatment, and in some patients the response diminishes over time. One observational study showed that one-third of PsA patients had switched to a second anti-TNF because of a lack of efficacy and side effects.³² NICE does not specifically recommend switching anti-TNFs other than the guidance for UST, and switching decisions may depend on local Clinical Commissioning Group guidelines: in some parts of the country patients are allowed to switch from one anti-TNF to another.

Quite often PsA goes undetected and is sometimes not recognised and diagnosed by dermatologists or general practitioners (GPs). In the UK, rheumatologists manage the majority of patients with PsA, but patients with less severe joint disease may be managed by a dermatologist. However, patients with severe problems with joints and skin will tend to be managed by both rheumatologists and dermatologists.

Description of the technology under assessment

Certolizumab pegol (CZP; CIMZIA[®], UCB Pharma, Brussels, Belgium) is a biologic therapy (a monoclonal antibody that targets TNF) that is administered subcutaneously. Anti-TNFs target the activation of tumour necrosis factor alpha (TNF- α) and subsequently activation of downstream inflammatory processes, and as such have the potential to offer symptom control as well as altering disease progression. CZP in combination with MTX has a marketing authorisation in the UK for treating active PsA in adults when the response to previous DMARD therapy has been inadequate. CZP can be given as monotherapy if MTX cannot be tolerated or when continued treatment with MTX is inappropriate.

Secukinumab (SEC; COSENTYX[®], Novartis International AG, Basel, Switzerland), which is also administered subcutaneously, is a different type of biologic therapy to CZP, being a monoclonal antibody that targets the IL-17A cytokine molecule (rather than targeting TNF). SEC, alone or in combination with MTX, is indicated for the treatment of active PsA in adult patients when the response to previous DMARD therapy has been inadequate. SEC also has marketing authorisation from the European Medicines Agency for the treatment of ankylosing spondylitis and moderate–severe plaque psoriasis.

Chapter 2 Definition of the decision problem

The decision problem relates to the optimal use of CZP and SEC within their marketing authorisations for treating active PsA in adults for whom DMARDs have been inadequately effective. Evaluations are made at the following points in the treatment pathway:

- patients who have only received one prior non-biological DMARD
- patients whose disease has inadequately responded to at least two DMARDs
- patients whose disease has inadequately responded to both DMARDs and biological therapies.

Previous National Institute for Health and Care Excellence appraisals

There have been no previous NICE technology appraisals (TAs) of CZP or SEC for PsA, although there have been several appraisals of other biologics for PsA: TA199³³ (ETN, INF and ADA), TA220³⁴ (GOL) and TA340³⁵ (UST). APR, which is not a biologic, is not currently recommended by NICE.

A number of key areas of uncertainty and potential limitations of the evidence base were identified from the previous appraisals. These include:

- a lack of direct head-to-head trial evidence evaluating the relative efficacy and safety of the biologics
- some limitations in the external validity of the trial populations (i.e. the trial populations had some differences from populations seen in routine clinical practice)
- a lack of patient registry data for PsA
- the long-term effectiveness of biologics in controlling disease activity
- the prescription cost of biologics and the cost of treating psoriasis at different levels of severity
- the progression of (HAQ-DI) score (a measure of patient function) in patients on and off treatment, and the length of time biologics are assumed to be effective
- long-term progression of PsA with and without biologics
- a lack of an optimal outcome measure for PsA
- the rate of treatment withdrawal and the adverse effects associated with the long-term use of biologics
- a lack of evidence on the efficacy and safety of the sequential use of biologics.

This assessment has considered and attempted to address these limitations and areas of uncertainty using relevant evidence where available.

Overall objective of assessment

To determine the clinical effectiveness and cost-effectiveness within the NHS of CZP and SEC within their marketing authorisations for treating active PsA in adults for whom DMARDs have been inadequately effective.

Chapter 3 Assessment of clinical effectiveness

This report contains reference to confidential information provided as part of the NICE appraisal process. This information has been removed from the report and the results, discussions and conclusions of the report do not include the confidential information. These sections are clearly marked in the report.

Methods for reviewing clinical effectiveness

Search strategies

The literature search aimed to identify all relevant randomised controlled trials (RCTs) of CZP and SEC, and the comparators ETN, ADA, INF, GOL, APR and UST for the treatment of PsA.

The searches for CZP and SEC for PsA were not restricted by date. However, as ETN, ADA, INF, GOL, APR and UST for PsA had been subject to previous TAs, updated searches were performed based on the search dates of these previous TAs.

The search strategy was developed in MEDLINE (via Ovid) and then adapted for use in the other resources searched. The strategy included terms for PsA combined, using the Boolean operator AND, with terms for the eight treatments. No language or geographical limits were applied. A study design search filter to limit retrieval to RCTs was used where available.

Search strategies were developed by an information specialist with input from the project team. The MEDLINE search strategy was checked by a second information specialist. The searches were carried out during December 2015 and then updated on 28 April 2016 to capture more recent studies.

The following databases were searched: MEDLINE, MEDLINE In-Process & Other Non-Indexed Citations, Cochrane Central Register of Controlled Trials (CENTRAL), Cochrane Database of Systematic Reviews (CDSR), Database of Abstracts of Reviews of Effects (DARE), EMBASE, Health Technology Assessment (HTA) database, PubMed, and the Science Citation Index (SCI).

In addition, the following resources were searched for ongoing, unpublished or grey literature: ClinicalTrials.gov, Conference Proceedings Citation Index – Science (CPCI-S), EU Clinical Trials Register, PROSPERO and the World Health Organization's International Clinical Trials Registry Platform portal.

As DARE ceased at the end of March 2015, additional searches for systematic reviews were carried out in MEDLINE and EMBASE to ensure that any relevant systematic reviews were identified.

Full search strategies can be found in *Appendix 1*.

Inclusion criteria

Two reviewers independently screened all titles and abstracts. Full manuscripts of any titles/abstracts that were relevant were obtained, where possible, and the relevance of each study was assessed by two reviewers according to the inclusion criteria, described below. Any discrepancies were resolved by involving a third reviewer. Studies available only as abstracts were also included.

Study design

Randomised or quasi-RCTs were eligible for the review of clinical efficacy and safety. For the eligible interventions (see *Interventions*), all open-label extension studies of RCTs were included. For the comparators (see *Comparators*), open-label extensions were identified and listed with the main focus being on those studies that reported data relating to the longest duration of follow-up available for each individual comparator.

To evaluate the adverse effect profiles of the different biologics, the eligible study designs were systematic reviews that covered a range of diseases and large observational studies in patients with PsA.

Prospective registry studies that included PsA patients receiving biologics were eligible to provide data on treatment adherence, treatment withdrawal, and the rates and efficacy of switching to new biologics (i.e. sequential use). Potentially relevant registry studies were sought and identified, with a focus on those deemed to be most clinically relevant and appropriate to the UK setting. This decision was based on an examination of study characteristics and discussion with our clinical adviser.

Studies were also sought on the longer-term natural history of PsA in populations that have not taken a biologic therapy.

Interventions

Certolizumab pegol and SEC were eligible at their licensed doses (see *Table 2*). Studies comparing these two treatments with each other were also eligible.

Comparators

The relevant comparators were:

- placebo
- DMARDs: MTX, sulfasalazine, leflunomide, hydroxychloroquine, azathioprine and ciclosporin
- biologic therapies: ADA, ETN, GOL, INF and UST, including any licensed biosimilars
- APR
- best supportive care (BSC).

Biologics and APR may have been used with or without concomitant DMARDs. Only studies that included treatments used at their licensed dose were eligible. Head-to-head trials of the five biologic comparators (and biosimilars) and APR were eligible, but were anticipated to be rare. Therefore, to allow comparisons of active treatments via network meta-analysis (NMA), the biologic comparators and APR could also have been compared with either placebo or a DMARD.

Participants

For the evaluation of the effectiveness of CZP and SEC, the included studies were of adults with active PsA for whom DMARDs had been inadequately effective.

Outcomes

For CZP and SEC, studies reporting any of the following outcomes were eligible:

- disease activity, using the following multidomain measures: PsARC, ACR 20, 50% improvement in the American College of Rheumatology criteria (ACR 50) and 70% improvement in the American College of Rheumatology criteria (ACR 70)
- functional capacity (assessed using HAQ-DI)
- radiographic assessment of disease progression
- response of psoriatic skin lesions (assessed using PASI)
- measures of dactylitis, enthesitis and tendonitis
- mortality
- HRQoL, assessed using EuroQoL-5 Dimensions (EQ-5D) or Short Form questionnaire-36 items (SF-36)
- adverse effects of treatment, focusing on the key adverse events (AEs) identified from previous studies of biologics: malignancies, serious infections, reactivation of latent tuberculosis (TB), injection site reactions and withdrawals due to AEs.

Randomised controlled trials of comparators needed to report at least one of the following: PsARC, ACR 20/50/70, PASI 50 (50% reduction in PASI), PASI 75 (75% reduction in PASI), PASI 90 (90% reduction in PASI) or HAQ-DI score.

For patient registry studies, treatment adherence, treatment withdrawal, and the rates and efficacy of switching to new biologics (i.e. sequential use) were the key outcomes of interest, and particularly those which were identified as being useful to inform parameters in the economic model.

Data extraction

For SEC and CZP, data were extracted from published papers and abstracts supplemented by data from the manufacturer submissions (when they were not available from other sources). Data were extracted from previous single technology appraisal (STA) or multiple technology appraisal (MTA) reports for studies of ETN, INF, ADA, GOL, UST and APR. When missing or further information on the trials of these treatments was needed, data were extracted either from the relevant published trial reports or from reviews.^{36–39} Some data may have been missing in the original TAs because of commercial- or academic-in-confidence restrictions; and some of these data may have subsequently been published. Data for UST at the 12-week time point were extracted from the full clinical study reports of PSUMMIT (Study of the Safety and Effectiveness of Ustekinumab in Patients With Psoriatic Arthritis) 1 and 2 trials, which were accessed via the Yale University Open Data Access (YODA) project. For APR, although only the Psoriatic Arthritis Long-term Assessment of Clinical Efficacy (PALACE) 1 trial has been published, data from the PALACE 2 and 3 trials were extracted from STA documents on NICE's website. All data for these treatments were extracted by one reviewer and then checked for any transcription errors by a second reviewer.

For the dichotomous responder outcomes (PsARC, ACR 20/50/70 and PASI 50/75/90), intention-to-treat (ITT) baseline denominators (i.e. the number of patients randomised for each trial arm) were used, with patients assumed to be non-responders where data were missing. This explains why there is a small difference in the ADalimumab Effectiveness in Psoriatic arthritis Trial (ADEPT) denominators used between this current MTA, the previous MTA and the manufacturers' submissions (the last two used the 'modified ITT' data whereby patients had to have received at least one dose of study treatment).

Data on study design, participant characteristics, efficacy outcomes and quality were extracted by one reviewer using a standardised data extraction form and independently checked by a second reviewer for the SEC and CZP trials. Disagreements were resolved through consensus. For the comparator treatments, most of the data were copied (from previous reports) by one reviewer and then checked for any transcription errors by a second reviewer.

Attempts were made, where possible, to contact authors for missing data. Data from studies with multiple publications were extracted and reported as a single study. For the open-label extension studies of comparator treatments, only the data relating to the latest time point were extracted. Data were also extracted from the manufacturers' submissions when they were not available from other sources.

Quality assessment

The quality of the RCTs was assessed using a modified version of the Cochrane risk-of-bias tool, which incorporated an assessment of baseline imbalance.⁴⁰ The assessments of baseline imbalance were made based on evidence from a systematic review of predictors of treatment response to anti-TNFs.⁴¹ The review identified several possible such predictors in patients with PsA, although none was identified as being conclusive owing to the limited number of studies and the heterogeneity of response measures. We looked at baseline CRP concentration, age and sex. The characteristics of young age, male sex and high CRP concentration may be predictive of a better response. Risk-of-bias assessments were performed by one reviewer and checked independently by a second reviewer. Any disagreements were resolved through consensus or by involvement of a third reviewer if necessary. Open-label extension studies were less formally evaluated. This was based on assessing imputation methods, the patient withdrawal criteria used and the clinical relevance of any treatment stopping/changing rules.

Methods of data synthesis

The study characteristics and quality assessment results were tabulated and summarised narratively. Where possible, the clinical effectiveness data for the PsARC, ACR, PASI and HAQ-DI outcomes were synthesised using Bayesian NMA methods (see *Chapter 4*). For other outcomes, or for studies not included in the NMAs, studies were either summarised narratively or pooled using pairwise meta-analysis methods.

Quantity and quality of the identified evidence

A total of 1761 records were retrieved from the original December 2015 electronic database searches. The searches were updated on 28 April 2016, with a further 200 records available for screening. After screening titles and abstracts, full copies of 182 papers were assessed for inclusion in the review.

Two RCTs were excluded at the abstract stage for using unlicensed dosages (50 mg of ETN twice weekly,⁴² and 20 and 40 mg of APR⁴³). Two RCTs were excluded at the full-paper stage: one did not report subgroup results for PsA⁴⁴ and the other included only patients who were naive to MTX.⁴⁵ The FUTURE [Efficacy at 24 Weeks and Long Term Safety, Tolerability and Efficacy up to 2 Years of Secukinumab (AIN457) in Patients With Active PsA] 1 trial of SEC was excluded from the RCT short-term efficacy review as it used an unlicensed, very high, loading dose. It was, however, included as an open-label extension study as the impact of the initial high loading dose would probably be negligible at later time points.⁴⁶ Fifty open-label studies of comparator treatments were excluded as they did not relate to the latest (longest) duration of follow-up.

Details of the numbers of other eligible full publications or conference abstracts that relate to open-label studies of the included RCTs and patient registry or safety studies are presented in *Figure 1*.

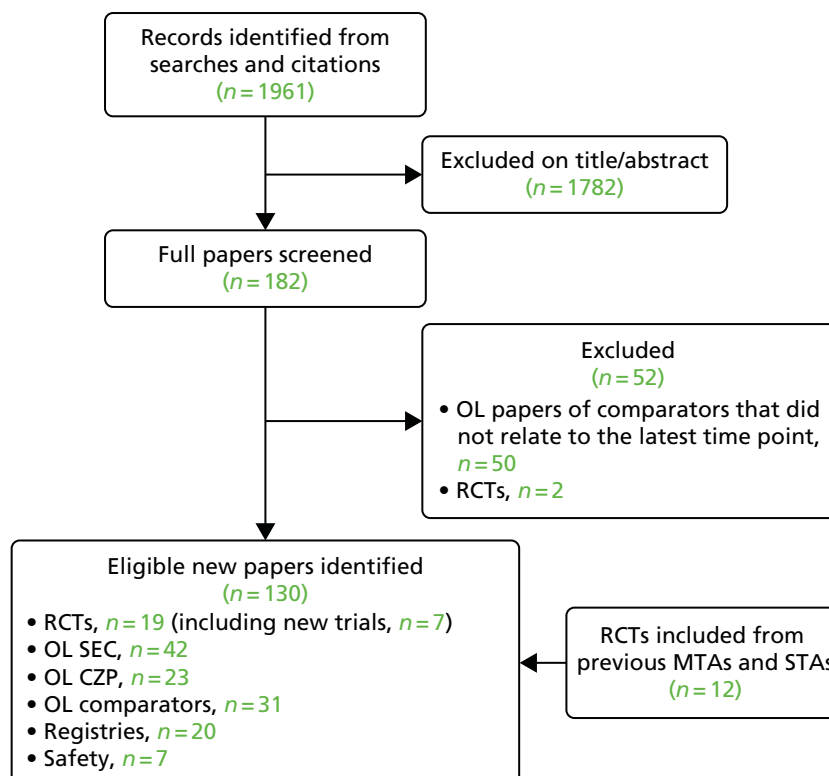

FIGURE 1 Flow chart showing the number of studies identified and eligible for inclusion. OL, open label.

Characteristics of the randomised controlled trials included in the systematic review of short-term efficacy

Of the 19 included RCTs, 17 were placebo controlled: one of CZP,⁴⁷ three of SEC (two of which were reported in one publication),^{48,49} one of GOL,⁵⁰ two of INF,^{51,52} two of ETN,^{53,54} three of ADA,⁵⁵⁻⁵⁷ two of UST^{58,59} and three of APR.^{60,61} The FUTURE 1 trial of SEC was excluded from the RCT short-term efficacy review as it used an unlicensed, and very high, loading dose.⁴⁶

Two trials compared active treatments: one compared SEC with UST^{62,63} and one compared INF, ETN and ADA.⁶⁴

Most studies were conducted mainly in Europe and North America. All but two^{53,64} were multicentre trials. Details of the trial durations, different phases and the dosing regimens of the main interventions studied are presented in *Table 2*. Details of all interventions studied are presented in *Table 3*. For some trials we excluded individual treatment arms from the systematic review (see *Table 3*). This was as a result of the doses not being licensed or recommended in the populations studied. Some included trials were excluded from the NMAs because of the populations being different from the other trial populations (see *Table 3*).

The design of many trials typically included a fully blinded, placebo-controlled phase followed by an 'early escape' crossover phase (from placebo to an active treatment) for non-responders, then finally crossover to active treatment for the remaining placebo participants. Non-response in this context related to failure to achieve prespecified minimum improvements (ranging between 5% and 20%) in tender joint count (TJC) and swollen joint count (SJC). All the trials using an early escape design ran for 16 weeks before patients were eligible for early escape. Trials then entered open-label extension phases (see *Long-term effectiveness*).

Table 4 describes the population characteristics of the included trials. Where available, this includes subgroup characteristics for patients who had never previously taken a biologic (i.e. biologic-naïve populations) and patients who *had* previously taken a biologic (i.e. biologic-experienced populations). Biologic-experienced patients were available only for the more recent trials (those of SEC, CZP, UST and APR); in the earlier trials such patients were not eligible to participate. Trial sample sizes varied, with earlier trials tending to be smaller than more recent trials. Variation in sample size was also evident within treatments: the two trials of ETN had populations of 60 and 205,^{53,54} and the three trials of ADA had populations of 100, 207 and 315.^{55-57,67} The duration of PsA ranged from 3 to 12 years across trials; the shortest durations (reported as medians) came from the UST PSUMMIT trials^{58,59,66} and the longest (reported as means) came from the Infliximab Multinational Psoriatic Arthritis Controlled Trial (IMPACT).^{51,52} The duration of psoriasis ranged from 11 to 23 years, although this information was not available for the FUTURE 2⁴⁸ SEC and RAPID-PsA⁴⁷ (Certolizumab Pegol in Subjects With Adult Onset Active and Progressive Psoriatic Arthritis) CZP trials. Although not reported in all trials, baseline CRP concentration levels were difficult to interpret as they appeared to have slightly skewed distributions, with means (range 10–31 mg/l) being generally higher than medians (range 7–15 mg/l).

Notwithstanding this limited heterogeneity, many key patient characteristics were broadly similar across trials, including mean ages (which ranged from 45 to 51 years), the proportion of male participants (around 50% for most trials), and TJCs and SJCs (TJC, range 18–29; SJC, range 9–18); an exception was the three-arm head-to-head trial, which had notably lower TJC and SJC.⁶⁴ The population in this trial, along with the PsA populations from the large SEC psoriasis trials,⁴⁹ also had markedly higher baseline PASI scores than the other trials (typically around two to three times higher). The FUTURE 2 SEC trial had slightly higher baseline PASI scores than the other trials, most notably in the 150 mg treatment arm. The PsA populations from two of the SEC psoriasis trials⁴⁹ also had lower baseline HAQ-DI scores (range 0.5–0.8 units) than the other trials (range 0.9–1.6 units). In light of these differences, the characteristics of the PsA patients in the SEC psoriasis trials were deemed to be too dissimilar to the other trials to be included in the NMAs. There were three of these psoriasis trials: Efficacy of Response and Safety of Two Fixed Secukinumab Regimens in Psoriasis

TABLE 2 Trial durations (including open-label extensions) and dosing regimens of key interventions studied

Main study reference and treatments studied	Eligible licensed dosing regimens (with timings)	Duration of truly randomised and blinded phase (before any treatment crossover)		Latest time point with available result data	Anticipated time to response: information from SPC
			Crossover details		
FUTURE 2; ⁴⁸ SEC	150-mg subcutaneous injection at weeks 0, 1, 2 and 3 followed by monthly maintenance dosing from week 4. For patients with concomitant moderate–severe plaque psoriasis or who are anti-TNF inadequate responders, the recommended dose is 300 mg (given as two 150-mg injections)	16 weeks	Week 16: PNRs (not achieving $\geq 20\%$ improvement from baseline in TJC and SJC) re-randomised to 150 or 300 mg every 4 weeks. Week 24: PRs re-randomised to 150 or 300 mg every 4 weeks	52 weeks	Clinical response is usually achieved within 16 weeks of treatment. Consideration should be given to discontinuing treatment in patients who have shown no response by 16 weeks of treatment. Some patients with an initial partial response may subsequently improve with continued treatment beyond 16 weeks
FIXTURE; ⁴⁹ SEC and ETN ERASURE; ⁴⁹ SEC	For patients with concomitant moderate–severe plaque psoriasis or who are anti-TNF inadequate responders, the recommended SEC dose is 300 mg	12 weeks	At 12 weeks PNRs were re-randomised to 150 or 300 mg of SEC	52 weeks	
CLEAR; ^{62,63} SEC and UST	SEC: for patients with concomitant moderate–severe plaque psoriasis or who are anti-TNF inadequate responders, the recommended dose is 300 mg UST: 45 mg at week 0, week 4 and every 12 weeks	52 weeks, but data currently available only for up to 16 weeks	No crossovers	52 weeks	
RAPID-PsA; ⁴⁷ CZP	200-mg subcutaneous injection Loading dose: 2 × 200 mg at weeks 0, 2 and 4 Maintenance dose: 200 mg every 2 weeks Alternative maintenance dose once clinical response is confirmed can be considered: 400 mg every 4 weeks	16 weeks	Placebo patients failing to achieve $\geq 10\%$ improvement in both TJC and SJC at both weeks 14 and 16 were re-randomised to 200 or 400 mg at week 16. At week 24 the remaining placebo patients were re-randomised to 200 or 400 mg	216 weeks	Clinical response is usually achieved within 12 weeks of treatment. Continued therapy should be carefully reconsidered in patients who show no evidence of therapeutic benefit within the first 12 weeks of treatment

Main study reference and treatments studied	Eligible licensed dosing regimens (with timings)	Duration of truly randomised and blinded phase (before any treatment crossover)	Crossover details	Latest time point with available result data	Anticipated time to response: information from SPC
PALACE 1, PALACE 2 and PALACE 3; ^{60,61,65} APR	30 mg twice daily, oral tablets	16 weeks	At week 16, patients without $\geq 20\%$ reduction in SJC and TJC were required to be re-randomised equally to either APR dose if initially randomised to placebo or remained on their initial APR dose. At week 24, all remaining placebo-treated patients were switched to APR	104 weeks (PALACE 1)	During pivotal trials the greatest improvement was observed within the first 24 weeks of treatment. If a patient shows no evidence of therapeutic benefit after 24 weeks, treatment should be reconsidered. The patient's response to treatment should be evaluated on a regular basis
PSUMMIT 1; ⁵⁸ UST	45-mg subcutaneous injection followed by a 45-mg dose 4 weeks later, and then every 12 weeks	16 weeks	At week 16, patients with $< 5\%$ improvement in TJC/SJC entered blinded early escape (placebo to 45 mg, 45 to 90 mg, 90 to 90 mg). At week 24, all remaining patients in the placebo group received 45 mg of UST, which they continued at week 28 and every 12 weeks thereafter	108 weeks for safety and 100 weeks for efficacy evaluation	Consideration should be given to discontinuing treatment in patients who have shown no response up to 28 weeks of treatment
PSUMMIT 2; ^{59,66} UST	45 mg at week 0, week 4, and every 12 weeks	16 weeks	At week 16, patients with $< 5\%$ improvement in TJC/SJC entered blinded early escape (placebo to 45 mg, 45 to 90 mg, 90 to 90 mg). At week 24, all remaining patients in the placebo group received 45 mg of UST	100 weeks	
GO-REVEAL; ⁵⁰ GOL	50 mg once monthly, subcutaneous injection	16 weeks	At week 16, patients with $< 10\%$ improvement in both TJC and SJC entered blinded early escape (placebo to 50 mg, 50 to 100 mg, 100 to 100 mg). Open label from week 24 (in which all patients were eligible for GOL)	256 weeks	Clinical response is usually achieved within 12–14 weeks of treatment (after three or four doses). Continued therapy should be reconsidered in patients who show no evidence of therapeutic benefit within this time period
ADEPT; ⁵⁵ ADA	40 mg every other week, subcutaneous injection	24 weeks	Open label from 24 weeks (in which all patients were eligible for ADA)	144 weeks	Clinical response is usually achieved within 12 weeks of treatment. Continued therapy should be carefully reconsidered in a patient not responding within this time period
SPIRIT-P1; ^{57,67} ADA	40 mg every other week, subcutaneous injection	NR	NR	NR	

continued

TABLE 2 Trial durations (including open-label extensions) and dosing regimens of key interventions studied (*continued*)

Main study reference and treatments studied	Eligible licensed dosing regimens (with timings)	Duration of truly randomised and blinded phase (before any treatment crossover)	Crossover details	Latest time point with available result data	Anticipated time to response: information from SPC
Genovese <i>et al.</i> , 2007; ⁵⁶ ADA	40 mg every other week, subcutaneous injection	12 weeks	Open label from 12 weeks (in which all patients were eligible for ADA)	24 weeks	
IMPACT; ⁵¹ INF	5 mg/kg, i.v. infusion followed by additional 5 mg/kg infusion doses at 2 and 6 weeks after the first infusion, then every 8 weeks	16 weeks	At week 16 patients initially assigned to receive placebo crossed over to receive 5 mg/kg INF	98 weeks	NR
IMPACT 2; ⁵² INF	5 mg/kg, i.v. infusion followed by additional 5 mg/kg infusion doses at 2 and 6 weeks after the first infusion, then every 8 weeks	16 weeks	At week 16 placebo patients with < 10% improvement in both TJC and SJC received 5 mg/kg of INF. Open label from 24 weeks (in which all patients were eligible for INF)	54 weeks	
Mease <i>et al.</i> , 2004; ⁵⁴ ETN	25 mg twice weekly, subcutaneous injection	24 weeks	Open label from 24 weeks (in which all patients were eligible for ETN)	104 weeks	Clinical response is usually achieved within 12 weeks of treatment.
Mease <i>et al.</i> , 2000; ⁵³ ETN	25 mg twice weekly, subcutaneous injection	12 weeks	Open label from 12 weeks (in which all patients were eligible for ETN)	36 weeks	Continued therapy should be carefully reconsidered in a patient not responding within this time period
Atteno <i>et al.</i> , 2010; ⁶⁴ INF, ETN and ADA	5 mg/kg every 6–8 weeks of INF; 25 mg of ETN twice weekly; 40 mg of ADA every other week	52 weeks (blinding not feasible)	No crossovers	52 weeks	See details for trials of INF, ETN and ADA

CLEAR, Efficacy of Secukinumab Compared to Ustekinumab in Patients with Plaque-type Psoriasis; ERASURE, Efficacy of Response and Safety of Two Fixed Secukinumab Regimens in Psoriasis; FIXTURE, Full Year Investigative Examination of Secukinumab vs. Etanercept Using Two Dosing Regimens to Determine Efficacy in Psoriasis; GO-REVEAL, Golimumab – A Randomized Evaluation of Safety and Efficacy in Subjects with Psoriatic Arthritis Using a Human Anti-TNF Monoclonal Antibody; i.v., intravenous; NR, not reported; PNR, placebo non-responder; PR, placebo responder; RAPID-PsA, Certolizumab Pegol in Subjects With Adult Onset Active and Progressive Psoriatic Arthritis; SJC, swollen joint count; SPC, Summary of Product Characteristics; SPIRIT-P1, Study of Ixekizumab in Participants With Active Psoriatic Arthritis; TJC, tender joint count.

TABLE 3 Treatment doses studied in the review of short-term efficacy

Trial	Trialled treatments and doses	Doses included in the review	Dose included in the NMA	Comments
FUTURE 2 ⁴⁸	75 mg of SEC; 150 mg of SEC; 300 mg of SEC; placebo	150 mg of SEC; 300 mg of SEC; placebo	150 mg of SEC; 300 mg of SEC; placebo	75 mg is not a licensed dose for PsA
ERASURE ⁴⁹	150 mg of SEC; 300 mg of SEC; placebo	300 mg of SEC; placebo	–	The severity of psoriasis seen in the population studied in this trial (> 30% BSA involvement) suggests that the 150-mg arm results have very limited relevance to clinical practice (as these patients are likely to receive 300 mg). Excluded from NMA as baseline PASI and HAQ-DI scores very different from other trials
FIXTURE ⁴⁹	50 mg of ETN twice weekly; 150 mg of SEC; 300 mg of SEC; placebo	300 mg of SEC; placebo	–	The severity of psoriasis seen in the population studied in this trial (> 30% BSA involvement) suggests that the 150-mg arm results have very limited relevance to clinical practice (as these patients are likely to receive 300 mg). Excluded from NMA as baseline PASI and HAQ-DI scores very different from other trials. 50 mg of ETN twice weekly excluded as not a licensed dose in PsA
CLEAR ⁶²	300 mg of SEC; 45 or 90 mg ^a of UST	300 mg of SEC; 45 or 90 mg of UST	–	Baseline characteristics within the subgroup with PsA were not reported, therefore it is not clear how severe the psoriasis is within this subgroup. Excluded from the NMA based on high mean PASI scores in whole-trial population
SPIRIT-P1 ^{57,67}	80 mg of IXE every 2 weeks; 80 mg of IXE every 4 weeks; 40 mg of ADA; placebo	40 mg of ADA; placebo	40 mg of ADA; placebo	IXE is not an eligible treatment for this review
RAPID-PsA ⁴⁷	200 mg of CZP every 2 weeks; 400 mg of CZP every 4 weeks; placebo	200 mg of CZP every 2 weeks; 400 mg of CZP every 4 weeks; placebo	200 mg of CZP every 2 weeks; 400 mg of CZP every 4 weeks; placebo	
PALACE 1 ⁶⁰	20 mg of APR; 30 mg of APR; placebo	30 mg of APR; placebo	30 mg of APR; placebo	20 mg is not a licensed dose
PALACE 2 ⁶⁵	20 mg of APR; 30 mg of APR; placebo	30 mg of APR; placebo	30 mg of APR; placebo	20 mg is not a licensed dose
PALACE 3 ⁶⁵	20 mg of APR; 30 mg of APR; placebo	30 mg of APR; placebo	30 mg of APR; placebo	20 mg is not a licensed dose
PSUMMIT 2 ⁵⁹	45 mg of UST; 90 mg of UST; placebo	45 mg of UST; placebo	45 mg of UST; placebo	The 90-mg arm was excluded as it was not administered as per the licence for all patients

continued

TABLE 3 Treatment doses studied in the review of short-term efficacy (*continued*)

Trial	Trialed treatments and doses	Doses included in the review	Dose included in the NMA	Comments
PSUMMIT 1 ⁶⁶	45 mg of UST; 90 mg of UST; placebo	45 mg of UST; placebo	45 mg of UST; placebo	The 90-mg arm was excluded as it was not administered as per the licence
Atteno <i>et al.</i> 2010 ⁶⁴	25 mg of ETN; 5 mg/kg INF; 40 mg of ADA	25 mg of ETN; 5 mg/kg INF; 40 mg of ADA	–	Excluded from the NMA – only 1 year of data are available
GO-REVEAL ⁵⁰	50 mg of GOL; 100 mg of GOL; placebo	50 mg of GOL; placebo	50 mg of GOL; placebo	The 100-mg arm was excluded as it was not administered as per the licence
Genovese <i>et al.</i> , 2007 ⁵⁶	40 mg of ADA; placebo	40 mg of ADA; placebo	40 mg of ADA; placebo	–
ADEPT ⁵⁵	40 mg of ADA; placebo	40 mg of ADA; placebo	40 mg of ADA; placebo	–
IMPACT ⁵¹	5 mg/kg INF; placebo	5 mg/kg INF; placebo	5 mg/kg INF; placebo	–
IMPACT 2 ⁵²	5 mg/kg INF; placebo	5 mg/kg of INF; placebo	5 mg/kg INF; placebo	–
Mease <i>et al.</i> , 2004 ⁵⁴	25 mg of ETN; placebo	25 mg of ETN; placebo	25 mg of ETN; placebo	–
Mease <i>et al.</i> , 2000 ⁵³	25 mg of ETN; placebo	25 mg of ETN; placebo	25 mg of ETN; placebo	–
<i>Trials excluded from the main review of short-term efficacy</i>				
FUTURE 1 ⁴¹	150 mg of SEC; placebo	–	–	Excluded: used unlicensed loading dose. Safety data from the manufacturer submission are eligible though
PRESTA ⁴²	50 mg of ETN twice weekly; 50 mg of ETN once weekly	–	–	Excluded on comparator: not a placebo-controlled trial and 50 mg of ETN twice weekly is not a licensed dose
Schett <i>et al.</i> , 2012 ⁴³	20 mg of APR; 40 mg of APR; placebo	–	–	Excluded: did not include licensed dose (30 mg of APR)
CLEAR, Efficacy of Secukinumab Compared to Ustekinumab in Patients with Plaque-type Psoriasis; ERASURE, Efficacy of Response and Safety of Two Fixed Secukinumab Regimens in Psoriasis; FIXTURE, Full Year Investigative Examination of Secukinumab vs. Etanercept Using Two Dosing Regimens to Determine Efficacy in Psoriasis; GO-REVEAL, Golimumab – A Randomized Evaluation of Safety and Efficacy in Subjects with Psoriatic Arthritis Using a Human Anti-TNF Monoclonal Antibody; IXE, ixekizumab; PRESTA, Psoriasis Randomized Etanercept study in Subjects with psoriatic Arthritis; RAPID-PsA, Certolizumab Pegol in Subjects With Adult Onset Active and Progressive Psoriatic Arthritis; SPIRIT-P1, Study of Ixekizumab in Participants With Active Psoriatic Arthritis.				
a Dose given as per the licence – according to patient weight.				

TABLE 4 Baseline population characteristics of the included randomised trials

Characteristic													
Trial	Trial arm	Number randomised	Age (years), mean (SD)	% male	Duration of PsA (years), mean (SD)	Duration of psoriasis (years), mean (SD)	CRP concentration (mg/l) (SD)	TJC, mean (SD)	SJC, mean (SD)	HAQ-DI, mean (SD)	PASI-evaluable patients ≥ 3% BSA (%)	PASI (0–72), mean (SD)	MTX use at randomisation (%)
FUTURE 2; ⁴⁸ all patients	150 mg of SEC	100	46.5 (11.7)	55	–	–	–	Confidential information has been removed	Confidential information has been removed	Confidential information has been removed	58 (58)	16.2 (14.3)	44
	300 mg of SEC	100	46.9 (12.6)	51	–	–	–	Confidential information has been removed	Confidential information has been removed	Confidential information has been removed	41 (41)	11.9 (8.4)	44
	Placebo	98	49.9 (12.5)	40	–	–	–	Confidential information has been removed	Confidential information has been removed	Confidential information has been removed	43 (44)	11.6 (8.3)	51
FUTURE 2; ⁴⁸ biologic experienced	SEC; for pooled doses	Confidential information has been removed	Confidential information has been removed	Confidential information has been removed	Confidential information has been removed	Confidential information has been removed	Confidential information has been removed	Confidential information has been removed	Confidential information has been removed	Confidential information has been removed	Confidential information has been removed	Confidential information has been removed	Confidential information has been removed
	Placebo	Confidential information has been removed	Confidential information has been removed	Confidential information has been removed	Confidential information has been removed	Confidential information has been removed	Confidential information has been removed	Confidential information has been removed	Confidential information has been removed	Confidential information has been removed	Confidential information has been removed	Confidential information has been removed	Confidential information has been removed
FUTURE 2; ⁴⁸ biologic naive	SEC; for pooled doses	Confidential information has been removed	Confidential information has been removed	Confidential information has been removed	Confidential information has been removed	Confidential information has been removed	Confidential information has been removed	Confidential information has been removed	Confidential information has been removed	Confidential information has been removed	Confidential information has been removed	Confidential information has been removed	Confidential information has been removed
	Placebo	Confidential information has been removed	Confidential information has been removed	Confidential information has been removed	Confidential information has been removed	Confidential information has been removed	Confidential information has been removed	Confidential information has been removed	Confidential information has been removed	Confidential information has been removed	Confidential information has been removed	Confidential information has been removed	Confidential information has been removed

continued

Trial	Trial arm	Characteristic										MTX use at randomisation (%)	
		Number randomised	Age (years), mean (SD)	% male	Duration of PsA (years), mean (SD)	Duration of psoriasis (years), mean (SD)	CRP concentration (mg/l) (SD)	TJC, mean (SD)	SJC, mean (SD)	HAQ-DI, mean (SD)	PASI-evaluable patients ≥ 3% BSA (%)		PASI (0–72), mean (SD)
RAPID-PsA, ⁴⁷ biologic experienced	Pooled CZP	Confidential information has been removed	Confidential information has been removed	Confidential information has been removed	Confidential information has been removed	Confidential information has been removed	Confidential information has been removed	Confidential information has been removed	Confidential information has been removed	Confidential information has been removed	Confidential information has been removed	Confidential information has been removed	Confidential information has been removed
	Placebo	Confidential information has been removed	Confidential information has been removed	Confidential information has been removed	Confidential information has been removed	Confidential information has been removed	Confidential information has been removed	Confidential information has been removed	Confidential information has been removed	Confidential information has been removed	Confidential information has been removed	Confidential information has been removed	Confidential information has been removed
RAPID-PsA, ⁴⁷ biologic naive	Pooled CZP	Confidential information has been removed	Confidential information has been removed	Confidential information has been removed	Confidential information has been removed	Confidential information has been removed	Confidential information has been removed	Confidential information has been removed	Confidential information has been removed	Confidential information has been removed	Confidential information has been removed	Confidential information has been removed	Confidential information has been removed
	Placebo	Confidential information has been removed	Confidential information has been removed	Confidential information has been removed	Confidential information has been removed	Confidential information has been removed	Confidential information has been removed	Confidential information has been removed	Confidential information has been removed	Confidential information has been removed	Confidential information has been removed	Confidential information has been removed	Confidential information has been removed
RAPID-PsA, ⁴⁷ biologic experienced (≥ 3% BSA and a PASI score of > 10 units at baseline)	Pooled CZP	Confidential information has been removed	Confidential information has been removed	Confidential information has been removed	Confidential information has been removed	Confidential information has been removed	Confidential information has been removed	Confidential information has been removed	Confidential information has been removed	Confidential information has been removed	Confidential information has been removed	Confidential information has been removed	Confidential information has been removed
	Placebo	Confidential information has been removed	Confidential information has been removed	Confidential information has been removed	Confidential information has been removed	Confidential information has been removed	Confidential information has been removed	Confidential information has been removed	Confidential information has been removed	Confidential information has been removed	Confidential information has been removed	Confidential information has been removed	Confidential information has been removed
RAPID-PsA, ⁴⁷ biologic naive (≥ 3% BSA and a PASI score of > 10 units at baseline)	Pooled CZP	Confidential information has been removed	Confidential information has been removed	Confidential information has been removed	Confidential information has been removed	Confidential information has been removed	Confidential information has been removed	Confidential information has been removed	Confidential information has been removed	Confidential information has been removed	Confidential information has been removed	Confidential information has been removed	Confidential information has been removed
	Placebo	Confidential information has been removed	Confidential information has been removed	Confidential information has been removed	Confidential information has been removed	Confidential information has been removed	Confidential information has been removed	Confidential information has been removed	Confidential information has been removed	Confidential information has been removed	Confidential information has been removed	Confidential information has been removed	Confidential information has been removed
PALACE 1 ^{60,69}	30 mg of APR	168	51.4 (11.7)	45	8.1 (8.1)	16.50 (12.3)	8.4 (10.2)	23.1 (14.5)	12.8 (7.8)	1.2 (0.6)	82 (49)	9.2 (9.7)	52
	Placebo	168	51.1 (12.1)	52	7.3 (7.1)	15.7 (13.0)	11 (14.4)	23.3 (15.2)	12.8 (8.8)	1.2 (0.6)	68 (41)	9.1 (9.5)	54

continued

TABLE 4 Baseline population characteristics of the included randomised trials (continued)

Characteristic													
Trial	Trial arm	Number randomised	Age (years), mean (SD)	% male	Duration of PsA (years), mean (SD)	Duration of psoriasis (years), mean (SD)	CRP concentration (mg/l) (SD)	TJC, mean (SD)	SJC, mean (SD)	HAQ-DI, mean (SD)	PASI-evaluable patients ≥ 3% BSA (%)	PASI (0–72), mean (SD)	MTX use at randomisation (%)
PALACE 2 ^{61,65,69}	30 mg of APR	162	50.5 (11.2)	41	6.8 (7.6)	18.7 (14.5)	–	21.8 (16.8)	10.3 (8.1)	1.2 (0.6)	–	7.8 (7.3)	70
	Placebo	159	51.2 (11.0)	47	7.8 (8.3)	17.8 (13.9)	–	18.0 (13.5)	9.2 (6.6)	1.2 (0.6)	–	8.6 (10.0)	59
PALACE 3 ^{61,65,69}	30 mg of APR	167	49.9 (11.4)	47	7.5 (7.6)	17.1 (12.1)	–	20.9 (14.4)	11.6 (8.7)	1.2 (0.6)	–	7.9 (6.3)	50
	Placebo	169	49.5 (11.6)	46	6.8 (6.5)	17.8 (13.3)	–	18.3 (14.9)	11.1 (7.9)	1.2 (0.6)	–	7.6 (7.2)	54
PSUMMIT 2, ^{59,66} all patients	45 mg of UST	103	49.0 (40, 56) ^c	47	5.3 (2.3, 12.2) ^c	13.3 (5.0, 24.4) ^c	13.0 (4.5, 36.3) ^c	22 (15, 33) ^c	12 (8, 19) ^c	1.4 (0.8, 1.9) ^c	80 (78)	8.6 (4.5, 18.3) ^c	52
	90 mg of UST	105	48.0 (41, 57) ^c	47	4.5 (1.7, 10.3) ^c	11.3 (4.5, 21.4) ^c	10.1 (4.8, 19.8) ^c	22 (14, 36) ^c	11 (7, 17) ^c	1.3 (0.8, 1.9) ^c	81 (77)	8.8 (4.5, 18.0) ^c	50
	Placebo	104	48.0 (38.5–56.0) ^c	49	5.5 (2.3–12.2) ^c	11.4 (6.0–22.0) ^c	8.5 (4.6, 22.0) ^c	21 (11–30) ^c	11 (7–18) ^c	1.3 (0.8–1.8) ^c	80 (77)	7.9 (4.5–16.0) ^c	47
PSUMMIT 2, ^{59,66} biologic experienced	45 mg of UST	60	49.0 (39, 55) ^c	38	7.3 (4.1, 13.7) ^c	15.5 (7.1, 24.7) ^c	15.0 (4.9, 37.0) ^c	24.0 (16.5, 40.5) ^c	14.5 (7.5, 20.5) ^c	1.4 (0.8, 2.0) ^c	–	–	–
	90 mg of UST	58	48 (40, 56) ^c	38	5.7 (2.5, 10.5) ^c	12.6 (7.3, 23.4) ^c	10.9 (6.9, 26.8) ^c	25.5 (17.0, 43.0) ^c	12.5 (7.0, 19.0) ^c	1.6 (0.9, 1.9) ^c	–	–	–
	Placebo	62	48.5 (37, 55) ^c	50	7.1 (4.1, 12.5) ^c	12.3 (8.3, 22.4) ^c	8.7 (4.2, 22.3) ^c	24.0 (12.0, 31.0) ^c	11.0 (7.0, 17.0) ^c	1.3 (0.8, 1.8) ^c	–	–	–
PSUMMIT 1 ^{58,66}	45 mg of UST	205	48.0 (39, 55) ^c	52	3.4 (1.2–9.2) ^c	12.0 (4.1–22.2) ^c	10.0 (5.9, 21.1) ^c	18 (12–28) ^c	10 (7–15) ^c	1.3 (0.8–1.8) ^c	145 (71)	7.1 (3.3–15.3) ^c	48
	90 mg of UST	204	47.0 (38.5–54.0) ^c	57	4.9 (1.7–8.3) ^c	14.1 (5.4–22.4) ^c	12.3 (6.5, 21.7) ^c	20 (12–32) ^c	10 (7–16) ^c	1.3 (0.8–1.6) ^c	149 (73)	8.4 (4.8–14.7) ^c	50
	Placebo	206	48.0 (39, 57) ^c	52	3.6 (1.0–9.7) ^c	13.1 (5.3–23.5) ^c	9.6 (6.0, 18.6) ^c	22 (13–33) ^c	12 (8–19) ^c	1.3 (0.8–1.8) ^c	146 (71)	8.8 (4.4–14.3) ^c	47
Atteno <i>et al.</i> , 2010 ⁶⁴	ETN	36	49.3 (13.4)	–	–	–	–	13	4	1.2 (0.4) ^b	–	26 (18.5) ^b	51
	ADA	34	47.5 (11.5)	–	–	–	–	13	5	1.2 (0.3) ^b	–	18 (16.5) ^b	–
	INF	30	48.5 (12.9)	–	–	–	–	12	3	1.5 (0.5) ^b	–	15 (14.8) ^b	–
GO-REVEAL ⁵⁰	50 mg of GOL	146	45.7 (10.7)	61	7.2 (6.8)	17.7 (11.9)	13 (16)	24.0 (17.1)	14.1 (11.4)	0.98 (0.65)	109 (75)	9.8 (8.6)	49
	Placebo	113	47.0 (10.6)	61	7.6 (7.9)	19.0 (12.9)	13 (16)	21.9 (14.7)	13.4 (9.8)	1.03 (0.55)	79 (70)	8.4 (7.4)	48

Characteristic													
Trial	Trial arm	Number randomised	Age (years), mean (SD)	% male	Duration of PsA (years), mean (SD)	Duration of psoriasis (years), mean (SD)	CRP concentration (mg/l) (SD)	TJC, mean (SD)	SJC, mean (SD)	HAQ-DI, mean (SD)	PASI-evaluable patients ≥ 3% BSA (%)	PASI (0–72), mean (SD)	MTX use at randomisation (%)
Genovese <i>et al.</i> , 2007 ⁵⁶	ADA	51	50.4 (11.0)	57	7.5 (7.0)	18.0 (13.2)	10 (10)	25.3 (18.3)	18.2 (10.9)	0.9 (0.5)	–	–	47
	Placebo	49	47.7 (11.3)	51	7.2 (7.0)	13.8 (10.7)	16 (17)	29.3 (18.1)	18.4 (12.1)	1.0 (0.7)	–	–	47
ADEPT ⁵⁵	ADA	153	48.6 (12.5)	56	9.8 (8.3)	17.2 (12.0)	14 (21)	23.9 (17.3)	14.3 (12.2)	1.0 (0.6)	70 (46)	7.4 (6.0)	51
	Placebo	162	49.2 (11.1)	55	9.2 (8.7)	17.1 (12.6)	14 (17)	25.8 (18.0)	14.3 (11.1)	1.0 (0.7)	70 (43)	8.3 (7.2)	50
IMPACT 2 ⁵²	INF	100	47.1 (12.8)	71	8.4 (7.2)	16.2 (11.0)	19 (21)	24.6 (14.1)	13.9 (7.9)	1.1 (0.6)	83 (83)	11.4 (12.7)	47
	Placebo	100	46.5 (11.3)	51	7.5 (7.8)	16.8 (12.0)	23 (34)	25.1 (13.3)	14.4 (8.9)	1.1 (0.6)	87 (87)	10.2 (9.0)	45
IMPACT ⁵¹	INF	52	45.7 (11.1)	58	11.7 (6.6)	16.9 (10.9)	22 (27)	23.7 (13.7)	14.6 (7.5)	1.2 (0.7)	22 (42) ^d	5.1 (5.9)	46
	Placebo	52	45.2 (9.7)	58	11 (6.6)	19.4 (11.6)	31 (38)	20.4 (12.1)	14.7 (8.2)	1.2 (0.7)	17 (33) ^d	4.2 (5.8)	65
Mease <i>et al.</i> , 2004 ⁵⁴	ETN	101	47.6	57	9.0	18.3	–	20.4 (–) ^b	15.9 (–) ^b	1.1 (–) ^b	–	–	45
	Placebo	104	47.3	45	9.2	19.7	–	22.1 (–) ^b	15.3 (–) ^b	1.1 (–) ^b	–	–	49
Mease <i>et al.</i> , 2000 ⁵³	ETN	30	46.0 (30–70) ^e	53	9.0 (1–31) ^e	19.0 (4–53) ^e	14 (7–28) ^e	22.5 (11, 32) ^b	14.0 (8, 23) ^b	1.3 (0.9, 1.6) ^b	19 (63)	10.1 (2.3–30.0) ^d	47
	Placebo	30	43.5 (24–63) ^e	60	9.5 (1–30) ^e	17.5 (2–43) ^e	12 (8–22) ^c	19.0 (10, 39) ^c	14.7 (7, 24) ^c	1.2 (0.8, 1.6) ^c	19 (63)	6.0 (1.5–17.7) ^e	47

CLEAR, Efficacy of Secukinumab Compared to Ustekinumab in Patients with Plaque-type Psoriasis; ERASURE, Efficacy of Response and Safety of Two Fixed Secukinumab Regimens in Psoriasis; FIXTURE, Full Year Investigative Examination of Secukinumab vs. Etanercept Using Two Dosing Regimens to Determine Efficacy in Psoriasis; GO-REVEAL, Golimumab – A Randomized Evaluation of Safety and Efficacy in Subjects with Psoriatic Arthritis Using a Human Anti-TNF Monoclonal Antibody; SD, standard deviation; SPIRIT-P1, Study of Ixekizumab in Participants With Active Psoriatic Arthritis.

a Subgroup data for patients with moderate–severe psoriasis and PsA.

b Main intervention studied was ixekizumab (treatment not eligible for this review).

c Median (25th, 75th percentile; or interquartile range).

d Patients with a baseline PASI score of ≥ 2.5 units.

e Median (range).

Note

Data in italics relate to redactions.

(ERASURE), Full Year Investigative Examination of Secukinumab vs. Etanercept Using Two Dosing Regimens to Determine Efficacy in Psoriasis (FIXTURE) and Efficacy of Secukinumab Compared to Ustekinumab in Patients with Plaque-type Psoriasis (CLEAR; baseline data were not available for the PsA patients in CLEAR). To be eligible for the ERASURE, FIXTURE and CLEAR trials, patients had to have moderate–severe psoriasis based on a PASI score of > 12 units and BSA involvement of $\geq 10\%$.⁴⁹ In the trials only of patients with PsA, the proportion of patients with at least moderate psoriasis (i.e. PASI-evaluable patients, defined as a BSA involvement of $\geq 3\%$) ranged between 41% and 87%.

In the FUTURE 2 (SEC)⁴⁸ and RAPID-PsA (CZP)⁴⁷ trials, the biologic-experienced and biologic-naive subgroups were broadly similar except that the biologic-experienced subgroups tended to have slightly higher TJs and SJs, and slightly longer durations of PsA.

All the trials of ETN, INF, ADA and GOL and one UST trial⁵⁸ (nine in total) excluded patients who had previously received an anti-TNF, so their populations comprised entirely biologic-naive patients (*Table 5*). In the remaining trials, where reported, the proportion of biologic-experienced patients ranged from 15% to 58%. Of the trials that allowed recruitment of biologic-experienced patients, the RAPID-PsA trial⁴⁷ was more selective than the FUTURE 2,⁴⁸ PSUMMIT 2^{59,66} and PALACE trials.^{60,61,65} RAPID-PsA⁴⁷ was the only trial that excluded patients with primary failure of a previous anti-TNF (primary failure was defined as no response within the first 12 weeks of treatment with the anti-TNF). (See *Appendix 2*, which details the eligibility criteria for all trials.) The results for the RAPID-PsA biologic-experienced subgroup may therefore be somewhat inflated when compared with the other trials reporting results for this subgroup.

Risk-of-bias assessments

The proportion of patients who took concomitant MTX ranged from 44% to 70%; most trials allowed concomitant MTX although the FIXTURE and ERASURE psoriasis trials⁴⁹ did not. The reporting of data on the number of previous DMARDs used was limited, although it appeared that most patients had tried one or two DMARDs.

The results of the risk-of-bias assessments are presented in *Table 6*. All except one^{57,67} of the trials included in the NMAs were judged as being at low overall risk of bias. Only one trial⁶⁴ was rated as being at high overall risk of bias for all outcomes, which was primarily due to lack of blinding. However, blinding would have been both difficult and impractical as the trial compared INF, ETN and ADA.⁶⁴ All the other trials were appropriately blinded. Across the trials the randomisation methods were well reported; only the head-to-head trial had unclear judgements for both sequence generation and allocation concealment.⁶⁴ The only chance imbalance of note occurred in the PSUMMIT 2 trial, in which median CRP concentration levels were higher in the 45-mg group (13 mg/l) than in the placebo group (8.5 mg/l).⁵⁹ Two of the three SEC trials in patients with psoriasis and PsA had overall judgements as being at unclear risk of bias.⁴⁹ This was because PsA subgroup data were being assessed and no details were available on missing outcome data. IMPACT 2⁵² was rated as being at high risk of bias for the PASI 75 outcome, as last observation carried forward (LOCF) was used for missing data (instead of the more conservative non-responder imputation).

Short-term efficacy of secukinumab

The clinical effectiveness evidence identified for SEC consisted of four Phase III RCTs: FUTURE 2, ERASURE, FIXTURE and CLEAR.^{48,49,62,63} The FUTURE 2 trial⁴⁸ was of patients with PsA and the ERASURE,⁴⁹ FIXTURE⁴⁹ and CLEAR trials^{62,63} were trials of patients with psoriasis and reported subgroup data for patients who also had PsA. The FUTURE 2 trial⁴⁸ provides the main evidence for SEC. FUTURE 1⁴⁶ studied a non-licensed, very high, loading dose (10 mg/kg) followed by a 150-mg maintenance dose. Although this trial was therefore not eligible to contribute data to the review of efficacy of SEC, nor to be included in the evidence synthesis, it has been used to provide supportive evidence on SEC as, unlike FUTURE 2, it reports data on radiographic progression of joint damage (see *Long-term effectiveness*). FUTURE 2⁴⁸ and ERASURE⁴⁹ compared 150 or 300 mg of SEC with placebo; FIXTURE⁴⁹ compared 150 or 300 mg of SEC with ETN (100 mg/week) and placebo; and CLEAR^{62,63} compared 300 mg of SEC with 45 or 90 mg of UST (dosing was as per licence, 45 mg in patients weighing ≤ 100 kg and 90 mg for patients weighing > 100 kg).

TABLE 5 Previous and concomitant treatment details for the included studies

Study	Interventions and dose	Number of prior DMARDs, mean	Percentage of patients with numbers of previous DMARDs	Previous biologic therapy	Concomitant treatments during trial (%)		
					Corticosteroids	NSAIDs	MTX
FUTURE 2 ⁴⁸	150 mg of SEC	–	–	0 = 63%, 1 = 26%, 2–3 = 11%	23	–	44
	300 mg of SEC	–	–	0 = 67%, 1 = 16%, 2–3 = 17%	18	–	44
	Placebo	–	–	0 = 64%, 1 = 16%, 2–3 = 19%	21	–	51
^a ERASURE ⁴⁹	300 mg of SEC	–	–	42% had a prior biologic	–	–	–
	Placebo	–	–	44% had a prior biologic	–	–	–
^a FIXTURE ⁴⁹	300 mg of SEC	–	–	22% had a prior biologic	–	–	–
	100 mg of ETN per week	–	–	18% had a prior biologic	–	–	–
	Placebo	–	–	18% had a prior biologic	–	–	–
^a CLEAR ^{62,63}	SEC	–	–	–	–	–	–
	UST	–	–	–	–	–	–
SPIRIT-P1 ^{57,67}	ADA	No data available, other than that biologic-experienced patients were excluded from the trial. This trial was reported only as conference abstracts					
	Placebo						
RAPID-PsA ⁴⁷	200 mg of CZP	–	1 = 44%, ≥ 2 = 53%	23% had a prior biologic	–	–	64
	400 mg of CZP	–	1 = 53%, ≥ 2 = 45%	17% had a prior biologic	–	–	65
	Placebo	–	1 = 54%, ≥ 2 = 44%	19% had a prior anti-TNF	–	–	62
PALACE 1 ⁶⁰	30 mg of APR	–	2% had never received a DMARD	24% had a prior biologic	–	–	52
	Placebo	–	4% had never received a DMARD	24% had a prior anti-TNF	–	–	54
PALACE 2 ^{61,65}	30 mg of APR	–	3% had never received a DMARD	14% had a prior biologic	–	–	70
	Placebo	–	1% had never received a DMARD	15% had a prior biologic	–	–	59

continued

TABLE 5 Previous and concomitant treatment details for the included studies (*continued*)

Study	Interventions and dose	Number of prior DMARDs, mean	Percentage of patients with numbers of previous DMARDs	Previous biologic therapy	Concomitant treatments during trial (%)		
					Corticosteroids	NSAIDs	MTX
PALACE 3 ^{61,65}	30 mg of APR		All patients had previously received a DMARD	26% had a prior biologic	–	–	50
	Placebo		All patients had previously received a DMARD	28% had a prior biologic	–	–	54
PSUMMIT 2 ^{59,66}	45 mg of UST	–	14% had never received a DMARD	180 (58%) had a prior anti-TNF	20	70	52
	90 mg of UST	–			15	67	50
	Placebo	–			13	74	47
PSUMMIT 1 ^{58,66}	45 mg of UST	–	20% had never received a DMARD	Biologic-experienced patients excluded	18	76	48
	90 mg of UST	–			14	74	50
	Placebo	–			16	73	47
Atteno <i>et al.</i> , 2010 ⁶⁴	ETN	–	–	Biologic-experienced patients excluded	–	–	51
	ADA	–	–		–	–	
	INF	–	–		–	–	
GO-REVEAL ⁵⁰	50 mg of GOL	–	0 = 25%, 1–2 = 69%, > 2 = 6%	Biologic-experienced patients excluded	13	75	49
	Placebo	–	0 = 25%, 1–2 = 66%, > 2 = 9%		17	78	48
Genovese <i>et al.</i> , 2007 ⁵⁶	ADA	1.7	All patients had a history of DMARD therapy	Biologic-experienced patients excluded	–	73	47
	Placebo	2.1			–	86	47
ADEPT ⁵⁵	ADA	1.5	–	Biologic-experienced patients excluded	–	–	51
	Placebo	1.5	–		–	–	50

Study	Interventions and dose	Number of prior DMARDs, mean	Percentage of patients with numbers of previous DMARDs	Previous biologic therapy	Concomitant treatments during trial (%)		
					Corticosteroids	NSAIDs	MTX
IMPACT 2 ⁵²	INF	–	0 = 17%, 1–2 = 71%, > 2 = 12%	Biologic-experienced patients excluded	15	71	47
	Placebo	–	0 = 24%, 1–2 = 67%, > 2 = 9%		10	73	45
IMPACT ⁵¹	INF	–	0 = 0%, 1 = 52%, 2–3 = 37%, > 3 = 12%	Biologic-experienced patients excluded	17	89	46
	Placebo	–	0 = 2%, 1 = 38%, 2–3 = 48%, > 3 = 12%		29	79	65
Mease <i>et al.</i> , 2004 ⁵⁴	ETN	1.6	0 = 27%, 1 = 40%, 2 = 20%	Biologic-experienced patients excluded	19	88	45
	Placebo	1.7	0 = 21%, 1 = 50%, 2 = 19%		15	83	49
Mease <i>et al.</i> , 2000 ⁵³	ETN	1.5	–	Biologic-experienced patients excluded	20	67	47
	Placebo	2.0	–		40	77	47

GO-REVEAL, Golimumab – A Randomized Evaluation of Safety and Efficacy in Subjects with Psoriatic Arthritis Using a Human Anti-TNF Monoclonal Antibody; SPIRIT-P1, Study of Ixekizumab in Participants With Active Psoriatic Arthritis.

a Subgroup data for patients with moderate–severe psoriasis and PsA.

TABLE 6 Risk-of-bias judgements for randomised trials (for time points before early escape crossover)

Drug and trial	Risk-of-bias domain							Overall judgement
	Sequence generation	Allocation concealment	Important baseline imbalance	Blinding of participants and researchers	Blinding of outcome assessment	Incomplete outcome data	Selective reporting	
SEC; FUTURE 2 ⁴⁸								
Judgement	Low	Low	Low	Low	Low	Low	Low	Low
Support	IVRS used	IVRS used	15% difference in the proportion of males although this will be a chance imbalance (based on randomisation methods)	Doses were provided in identical prefilled syringes	Doses were provided in identical prefilled syringes	More withdrawals in the placebo group but NRI and LOCF were used for missing data	Results reported for all key outcomes	
SEC; FIXTURE (subgroup) ⁴⁹								
Judgement	Low	Low	Unclear	Low	Low	Unclear	Low	Unclear
Support	IVRS used	IVRS used	No data on CRP levels	Adequate blinding (placebo controlled). Double-dummy design used as there was an active comparator arm	Adequate blinding (placebo controlled). Double-dummy design used as there was an active comparator arm	Unclear for the PsA subpopulation	Results reported for all key outcomes	
SEC; ERASURE (subgroup) ⁴⁹								
Judgement	Low	Low	Unclear	Low	Low	Unclear	Low	Unclear
Support	IVRS used	IVRS used	No data on CRP levels	Adequate blinding (placebo controlled)	Adequate blinding (placebo controlled)	Unclear for the PsA subpopulation	Results reported for all key outcomes	

Drug and trial	Risk-of-bias domain							Overall judgement
	Sequence generation	Allocation concealment	Important baseline imbalance	Blinding of participants and researchers	Blinding of outcome assessment	Incomplete outcome data	Selective reporting	
SEC; CLEAR ^{62,63}								
Judgement	Low	Low	Low	Low	Low	Low	Low	Low
Support	IVRS used	IVRS used	In the psoriasis trial as a whole, demographic and disease characteristics were similar between treatment arms ^a	Treatments looked identical	Treatments looked identical	Dropouts for the subgroup with PsA were not reported. In the psoriasis trial as a whole, there were no imbalances in dropouts between groups	Results reported for key outcomes	
ADA; SPIRIT-P1 ^{57,67}								
Judgement	Unclear	Unclear	Unclear	Low	Low	Low	Low	Unclear
Support	Randomisation sequence not reported	NR	NR	Double blind (subject, caregiver, investigator, outcomes assessor)	Double blind (subject, caregiver, investigator, outcomes assessor)	NRI was used for missing data; continuous data of inadequate responders were excluded after 16 weeks	All main outcomes reported	
CZP; RAPID-PsA ⁴⁷								
Judgement	Low	Low	Low	Low	Low	Low	Low	Low
Support	IVRS used	IVRS used	Balanced	Blinded prefilled syringes were used	Blinded prefilled syringes were used	NRI and LOCF were used for missing data	Results reported for all key outcomes	
APR; PALACE 1 ^{60,69}								
Judgement	Low	Low	Low	Low	Low	Low	Low	Low
Support	IVRS used	IVRS used	Balanced	EMA report states that identical tablets and blister cards were used in the APR psoriasis trials ^b	See blinding of participants and researchers cell	NRI and LOCF (for the sensitivity analysis only) were used	All main outcomes reported	

continued

TABLE 6 Risk-of-bias judgements for randomised trials (for time points before early escape crossover) (*continued*)

Drug and trial	Risk-of-bias domain							
	Sequence generation	Allocation concealment	Important baseline imbalance	Blinding of participants and researchers	Blinding of outcome assessment	Incomplete outcome data	Selective reporting	Overall judgement
APR; PALACE 2 ^{65,69}								
Judgement	Low	Low	Unclear	Low	Low	Low	Low	Low
Support	IVRS used	IVRS used	Data not available for individual trials	As for PALACE 1	As for PALACE 1	NRI and LOCF used. Similar withdrawal rates in pooled analysis	All main outcomes reported	
APR; PALACE 3 ^{65,69}								
Judgement	Low	Low	Unclear	Low	Low	Low	Low	Low
Support	IVRS used	IVRS used	Data not available for individual trials	As for PALACE 1	As for PALACE 1	NRI and LOCF used. Similar withdrawal rates in pooled analysis	All main outcomes reported	
UST; PSUMMIT 2 ⁵⁹								
Judgement	Low	Low	Unclear	Low	Low	Low	Low	Low
Support	IVRS used	IVRS used	Chance imbalance in median CRP levels (placebo, 8.5 mg/l, vs. 45 mg of UST, 13.0 mg/l)	Based on details in table 9 of Craig <i>et al.</i> 's 2013 UST STA ⁶⁶	Based on details in table 9 of Craig <i>et al.</i> 's 2013 UST STA ⁶⁶	Low dropout rate. NRI for ACR and PASI and LOCF for change in HAQ-DI score. Otherwise, missing data were not imputed for the rest of the outcomes	All main outcomes reported	But important imbalance, likely due to chance
UST; PSUMMIT 1 ⁶⁶								
Judgement	Low	Low	Low	Low	Low	Low	Low	Low
Support	IVRS used	IVRS used	Balanced	Based on details in table 9 of Craig <i>et al.</i> 's 2013 UST STA ⁶⁶	Based on details in table 9 of Craig <i>et al.</i> 's 2013 UST STA ⁶⁶	Low dropout rate. NRI and LOCF used	All main outcomes reported	

Drug and trial	Risk-of-bias domain							Overall judgement
	Sequence generation	Allocation concealment	Important baseline imbalance	Blinding of participants and researchers	Blinding of outcome assessment	Incomplete outcome data	Selective reporting	
INF vs. ETN vs. ADA; Atteno <i>et al.</i> , 2010 ⁶⁴								
Judgement	Unclear	Unclear	Unclear	High	High	Unclear	Unclear	High
Support	Study drugs were 'randomly given'	Study drugs were 'randomly given'	No data on CRP levels	Head-to-head trial of treatments with different regimens	Head-to-head trial of treatments with different regimens	No information on withdrawals nor on imputation methods	No prior registration	
GOL; GO-REVEAL ⁵⁰								
Judgement	Low	Low	Low	Low	Low	Low	Low	Low
Support	IVRS used	IVRS used	Balanced	Based on text in Yang <i>et al.</i> 's full STA report ⁷⁰	Based on text in Yang <i>et al.</i> 's full STA report ⁷⁰	Although there was insufficient detail on imputation methods, there were few dropouts (and balanced across groups)	All main outcomes reported	
ADA; Genovese <i>et al.</i> , 2007 ⁵⁶								
Judgement	Low	Low	Low	Low	Low	Low	Low	Low
Support	Based on details in table 10 of Rodgers <i>et al.</i> ³³	Based on details in table 10 of Rodgers <i>et al.</i> ³³	Balanced	Based on details in table 10 of Rodgers <i>et al.</i> ³³	Based on details in table 10 of Rodgers <i>et al.</i> ³³	NRI and LOCF were used for missing data	Results reported for all key outcomes	
ADA; ADEPT ⁵⁵								
Judgement	Low	Unclear	Low	Low	Low	Low	Low	Low
Support	Based on details in table 10 of Rodgers <i>et al.</i> ³³	NR	Balanced	Based on details in table 10 of Rodgers <i>et al.</i> ³³	Based on details in table 10 of Rodgers <i>et al.</i> ³³	NRI was used for missing data. In addition, similar levels of dropout across groups and similar reasons	Results reported for all key outcomes	

continued

TABLE 6 Risk-of-bias judgements for randomised trials (for time points before early escape crossover) (continued)

Drug and trial	Risk-of-bias domain							Overall judgement
	Sequence generation	Allocation concealment	Important baseline imbalance	Blinding of participants and researchers	Blinding of outcome assessment	Incomplete outcome data	Selective reporting	
INF; IMPACT 2 ⁵²								
Judgement	Low	Low	Unclear	Low	Low	High	Low	High, PASI 75; low, other outcomes
Support	Based on details in table 6 of Rodgers <i>et al.</i> ³³	Based on details in table 6 of Rodgers <i>et al.</i> ³³	20% difference in proportion of males although this will be a chance imbalance (based on randomisation methods)	Based on details in table 6 of Rodgers <i>et al.</i> ³³	Based on details in table 6 of Rodgers <i>et al.</i> ³³	NRI was used for missing PsARC and ACR 20 data. LOCF used for PASI 75. Unclear for HAQ-DI (appears to be LOCF)	Results for all key outcomes reported	
INF; IMPACT ⁵¹								
Judgement	Low	Low	Low	Low	Low	Low	Low	Low
Support	Based on details in table 6 of Rodgers <i>et al.</i> ³³	Based on details in table 6 of Rodgers <i>et al.</i> ³³	Mean CRP levels were 31 mg/l for placebo and 22 mg/l for INF ^c	Based on details in table 6 of Rodgers <i>et al.</i> ³³	Based on details in table 6 of Rodgers <i>et al.</i> ³³	Very few dropouts	Results for all key outcomes reported	Low
ETN; Mease <i>et al.</i> , 2004 ⁵⁴								
Judgement	Low	Low	Unclear	Low	Low	Low	Low	Low
Support	Based on details in table 2 of Rodgers <i>et al.</i> ³³	Based on details in table 2 of Rodgers <i>et al.</i> ³³	12% difference in proportion of males although this will be a chance imbalance (based on randomisation methods)	Based on details in table 2 of Rodgers <i>et al.</i> ³³	Based on details in table 2 of Rodgers <i>et al.</i> ³³	More withdrawals in the placebo group; NRI and LOCF were used for missing data	Results reported for all key outcomes	

Drug and trial	Risk-of-bias domain							Overall judgement
	Sequence generation	Allocation concealment	Important baseline imbalance	Blinding of participants and researchers	Blinding of outcome assessment	Incomplete outcome data	Selective reporting	
ETN; Mease <i>et al.</i> , 2000 ⁵³								
Judgement	Low	Low	Low	Low	Low	Low	Low	Low
Support	Based on details in table 2 of Rodgers <i>et al.</i> ³³	Based on details in table 2 of Rodgers <i>et al.</i> ³³	Balanced	Based on details in table 2 of Rodgers <i>et al.</i> ³³	Based on details in table 2 of Rodgers <i>et al.</i> ³³	Although LOCF was used for missing data (no NRI), there were only four dropouts, all in the placebo group	Results reported for all key outcomes	
<p>EMA, European Medicines Agency; GO-REVEAL, Golimumab – A Randomized Evaluation of Safety and Efficacy in Subjects with Psoriatic Arthritis Using a Human Anti-TNF Monoclonal Antibody; IVRS, interactive voice-/web-response system; NR, not reported; NRI, non-responder imputation; SPIRIT-P1, Study of Ixekizumab in Participants With Active Psoriatic Arthritis.</p> <p>a Baseline characteristics for the PsA subgroup were not reported.</p> <p>b Assumed to be the same for the placebo-controlled trials in PsA.</p> <p>c Medians of 14.0 and 9.9 mg/l, respectively ($p = 0.15$).</p>								

There are three relevant ongoing trials for which results are not yet available (*Table 7*).

As previously discussed, the baseline characteristics of the ERASURE, FIXTURE and CLEAR^{49,62,63} subgroup populations were different to the baseline characteristics of the other trials. The patients in these trials had much higher baseline PASI scores and notably lower baseline HAQ-DI scores than the other trials, suggesting that these patients had more severe psoriasis and less severe arthritis symptoms (see *Table 4*).

The FUTURE 2⁴⁸ and CLEAR^{62,63} trials were judged as being at a low overall risk of bias with an unclear risk of overall judgements for ERASURE⁴⁹ and FIXTURE⁴⁹ (see *Table 6*).

FUTURE 2 trial

Tables 8 and 9 show FUTURE 2 trial⁴⁸ results for the key review outcomes for the full-trial population across the 12-, 16- and 24-week time points. Results for the biologic-naive and biologic-experienced subgroups are presented in *Tables 10 and 11*. The corresponding relative risks (RRs) for the dichotomous outcomes were calculated by the Evidence Review Group (ERG) and are presented in *Table 12*.

Efficacy at 12–24 weeks in the full-trial population

For the whole-trial population, SEC was associated with statistically significant improvements in all outcomes at all time points. Patients taking SEC were around six times more likely to be ACR 50 responders – an outcome of particular clinical importance to patients – than patients taking placebo. An increase in RRs is apparent when looking across the PsARC, ACR 20, ACR 50 and ACR 70 columns in *Table 12*. These increases in RR are likely to be a consequence of the different placebo rates, with higher rates for the lower threshold outcomes (see the placebo rates in *Table 8*). The lower threshold outcomes (such as PsARC and ACR 20) appear to underestimate efficacy because the RRs tend to be diluted by the high placebo response rates. This association of higher placebo responses with lower relative efficacy was also noted across trials by outcome in the evidence synthesis and is discussed in *Chapter 4*.

FUTURE 2⁴⁸ trial patients taking 150 or 300 mg of SEC were also around six to seven times more likely to be PASI 50 responders than patients taking placebo. Efficacy was also demonstrated for the higher PASI thresholds (PASI 75 and PASI 90), with the 300-mg group having only slightly higher RRs than the 150-mg group.

TABLE 7 Ongoing trials of SEC in patients with active PsA

Trial name and ClinicalTrials.gov reference	Purpose of trial
FUTURE 3; ⁷¹ NCT01989468	To provide 24- to 52-week efficacy, safety and tolerability data, as well as up to 3-year efficacy, safety and tolerability data, in subjects with active PsA despite current or previous NSAID, DMARD therapy and/or previous anti-TNF therapy using an autoinjector. Initial data were due to be published in 2016. Estimated primary completion date: January 2018
FUTURE 4; ⁷² NCT02294227	To provide 16-week efficacy, safety and tolerability data vs. placebo to support the use of 150 mg of SEC by subcutaneous self-administration with or without a loading regimen and maintenance dosing using prefilled syringe and to assess efficacy, safety and tolerability up to 2 years in subjects with active PsA despite current or previous NSAID, non-biologic DMARD or biologic anti-TNF- α therapy. Recruitment closed (nine patients in the UK), but the study is still active. Estimated primary completion date: December 2017
FUTURE 5; ⁷³ NCT02404350	To demonstrate efficacy including effect on inhibition of progression of structural damage, safety and tolerability up to 2 years with primary focus at week 24, to support the use of SEC prefilled syringe by subcutaneous self-administration with or without loading regimen in subjects with active PsA despite current or previous NSAID, DMARD therapy and/or previous anti-TNF therapy. Patient recruitment began in 2015. Estimated primary completion date: May 2019

TABLE 8 Psoriatic Arthritis Response Criteria, ACR and HAQ-DI responses in the FUTURE 2 trial⁴⁸

Population	Drug	Time point (weeks)	Number of patients randomised	Responders, <i>n</i> (%)				HAQ-DI change from baseline (SE)
				PsARC	ACR 20	ACR 50	ACR 70	
All	300 mg of SEC	12	100	Confidential information has been removed	57 (57)	30 (30)	–	–
	150 mg of SEC		100	Confidential information has been removed	56 (56)	32 (32)	–	–
	Placebo		98	Confidential information has been removed	25 (26)	5 (5)	–	–
All	300 mg of SEC	16	100	69 (69)	57 (57)	30 (30)	–	–
	150 mg of SEC		100	72 (72)	60 (60)	32 (32)	–	–
	Placebo		98	41 (42)	18 (18)	5 (5)	–	–
All	300 mg of SEC	24	100	Confidential information has been removed	54 (54)	35 (35)	20 (20)	–0.56 (0.05)
	150 mg of SEC		100	Confidential information has been removed	51 (51)	35 (35)	21 (21)	–0.48 (0.05)
	Placebo		98	Confidential information has been removed	15 (15)	7 (7)	1 (1)	–0.31 (0.06)

SE, standard error.

TABLE 9 Psoriasis Area and Severity Index response rates in the FUTURE 2 trial⁴⁸

Population	Drug	Time point (weeks)	Number of patients with psoriasis affecting ≥ 3% of BSA	PASI response rates		
				PASI 50	PASI 75	PASI 90
All	300 mg of SEC	12	41	34 (83%)	24 (59%)	16 (39%)
	150 mg of SEC		58	48 (83%)	31 (53%)	19 (33%)
	Placebo		43	5 (12%)	2 (5%)	2 (5%)
All	300 mg of SEC	16	41	36 (88%)	–	–
	150 mg of SEC		58	48 (83%)	–	–
	Placebo		43	6 (14%)	–	–
All	300 mg of SEC	24	41	–	26 (63%)	20 (49%)
	150 mg of SEC		58	–	28 (48%)	19 (33%)
	Placebo		43	–	7 (16%)	4 (9%)

TABLE 10 Psoriatic Arthritis Response Criteria and ACR response rates for biologic-naive and biologic-experienced subgroups in the FUTURE 2 trial⁴⁸

Population	Drug	Time point (weeks)	Number of patients randomised	PsARC	ACR 20	ACR 50	ACR 70
Biologic naive	300 mg of SEC	12	Confidential information has been removed	Confidential information has been removed	Confidential information has been removed	Confidential information has been removed	Confidential information has been removed
	150 mg of SEC		Confidential information has been removed	Confidential information has been removed	Confidential information has been removed	Confidential information has been removed	Confidential information has been removed
	Placebo		Confidential information has been removed	Confidential information has been removed	Confidential information has been removed	Confidential information has been removed	Confidential information has been removed
Biologic experienced	300 mg of SEC	12	Confidential information has been removed	Confidential information has been removed	Confidential information has been removed	Confidential information has been removed	Confidential information has been removed
	150 mg of SEC		Confidential information has been removed	Confidential information has been removed	Confidential information has been removed	Confidential information has been removed	Confidential information has been removed
	Placebo		Confidential information has been removed	Confidential information has been removed	Confidential information has been removed	Confidential information has been removed	Confidential information has been removed
Biologic naive	300 mg of SEC	16	Confidential information has been removed	Confidential information has been removed	Confidential information has been removed	Confidential information has been removed	Confidential information has been removed
	150 mg of SEC		Confidential information has been removed	Confidential information has been removed	Confidential information has been removed	Confidential information has been removed	Confidential information has been removed
	Placebo		Confidential information has been removed	Confidential information has been removed	Confidential information has been removed	Confidential information has been removed	Confidential information has been removed
Biologic experienced	300 mg of SEC	16	Confidential information has been removed	Confidential information has been removed	Confidential information has been removed	Confidential information has been removed	Confidential information has been removed
	150 mg of SEC		Confidential information has been removed	Confidential information has been removed	Confidential information has been removed	Confidential information has been removed	Confidential information has been removed
	Placebo		Confidential information has been removed	Confidential information has been removed	Confidential information has been removed	Confidential information has been removed	Confidential information has been removed
Biologic naive	300 mg of SEC	24	67	–	39 (58%)	26 (39%)	15 (22%)
	150 mg of SEC		63	–	40 (63%)	28 (44%)	17 (27%)
	Placebo		63	–	10 (16%)	4 (6%)	1 (2%)

TABLE 10 Psoriatic Arthritis Response Criteria and ACR response rates for biologic-naive and biologic-experienced subgroups in the FUTURE 2 trial⁴⁸ (continued)

Population	Drug	Time point (weeks)	Number of patients randomised	PsARC	ACR 20	ACR 50	ACR 70
Biologic experienced	300 mg of SEC	24	33	–	15 (45%)	9 (27%)	5 (15%)
	150 mg of SEC		37	–	11 (30%)	7 (19%)	4 (11%)
	Placebo		35	–	5 (14%)	3 (9%)	0 (0%)

TABLE 11 Psoriasis Area and Severity Index response rates for biologic-naive and biologic-experienced subgroups in the FUTURE 2 trial⁴⁸

Population	Drug	Time point (weeks)	Number of patients with psoriasis affecting ≥ 3% of BSA	PASI 50	PASI 75	PASI 90
Biologic naive	300 mg of SEC	12	30	Confidential information has been removed	Confidential information has been removed	Confidential information has been removed
	150 mg of SEC		36	Confidential information has been removed	Confidential information has been removed	Confidential information has been removed
	Placebo		31	Confidential information has been removed	Confidential information has been removed	Confidential information has been removed
Biologic experienced	300 mg of SEC	12	11	Confidential information has been removed	Confidential information has been removed	Confidential information has been removed
	150 mg of SEC		22	Confidential information has been removed	Confidential information has been removed	Confidential information has been removed
	Placebo		12	Confidential information has been removed	Confidential information has been removed	Confidential information has been removed
Biologic naive	300 mg of SEC	16	30	–	21 (70%)	15 (50%)
	150 mg of SEC		36	–	23 (64%)	16 (44%)
	Placebo		31	–	3 (10%)	3 (10%)
Biologic experienced	300 mg of SEC	16	11	–	6 (55%)	3 (27%)
	150 mg of SEC		22	–	10 (45%)	6 (27%)
	Placebo		12	–	0 (0%)	0 (0%)
Biologic naive	300 mg of SEC	24	30	–	19 (63%)	16 (53%)
	150 mg of SEC		36	–	20 (56%)	14 (39%)
	Placebo		31	–	6 (19%)	3 (10%)
Biologic experienced	300 mg of SEC	24	11	–	7 (64%)	4 (36%)
	150 mg of SEC		22	–	8 (36%)	5 (23%)
	Placebo		12	–	1 (8%)	1 (8%)

TABLE 12 Relative risks for key dichotomous outcomes in the FUTURE 2 trial:⁴⁸ 150 or 300 mg of SEC vs. placebo

Treatment	Time point (weeks)	Population	RR (95% CI)						
			PsARC	ACR 20	ACR 50	ACR 70	PASI 50	PASI 75	PASI 90
150 mg of SEC	12	All	1.73 (1.31 to 2.29)	2.20 (1.50 to 3.21)	6.27 (2.55 to 15.43)	NR	7.12 (3.10 to 16.36)	11.49 (2.91 to 45.42)	7.04 (1.73 to 28.64)
	16		1.72 (1.32 to 2.24)	3.27 (2.09 to 5.11)	6.27 (2.55 to 15.43)	NR	5.93 (2.80 to 12.57)	NR	NR
	24		Confidential information has been removed	3.33 (2.01 to 5.51)	4.90 (2.29 to 10.50)	20.58 (2.82 to 150.06)	NR	2.97 (1.43 to 6.14)	3.52 (1.29 to 9.61)
300 mg of SEC	12	All	1.81 (1.38 to 2.38)	2.23 (1.53 to 3.26)	5.88 (2.38 to 14.53)	NR	7.13 (3.09 to 16.45)	12.59 (3.17 to 49.91)	8.39 (2.06 to 34.24)
	16		1.65 (1.26 to 2.16)	3.10 (1.98 to 4.87)	5.88 (2.38 to 14.53)	NR	6.29 (2.97 to 13.33)	NR	NR
	24		Confidential information has been removed	3.53 (2.14 to 5.81)	4.90 (2.29 to 10.50)	19.60 (2.68 to 143.24)	NR	3.90 (1.90 to 7.98)	5.24 (1.96 to 14.04)
150 mg of SEC	12	Biologic naive	Confidential information has been removed	Confidential information has been removed	Confidential information has been removed	Confidential information has been removed	Confidential information has been removed	Confidential information has been removed	Confidential information has been removed
	16		NR	Confidential information has been removed	Confidential information has been removed	Confidential information has been removed	NR	Confidential information has been removed	Confidential information has been removed
	24		Confidential information has been removed	4.00 (2.20 to 7.28)	7.00 (2.61 to 18.80)	17.00 (2.33 to 123.91)	NR	2.87 (1.32 to 6.23)	4.02 (1.27 to 12.70)

Treatment	Time point (weeks)	Population	RR (95% CI)						
			PsARC	ACR 20	ACR 50	ACR 70	PASI 50	PASI 75	PASI 90
300 mg of SEC	12	Biologic naive	Confidential information has been removed	Confidential information has been removed	Confidential information has been removed	Confidential information has been removed	Confidential information has been removed	Confidential information has been removed	Confidential information has been removed
	16		NR	Confidential information has been removed	Confidential information has been removed	Confidential information has been removed	NR	Confidential information has been removed	Confidential information has been removed
	24		Confidential information has been removed	3.67 (2.01 to 6.71)	6.11 (2.26 to 16.53)	14.10 (1.92 to 103.68)	NR	3.27 (1.52 to 7.06)	5.51 (1.79 to 17.00)
300 mg of SEC	12	Biologic experienced	Confidential information has been removed	Confidential information has been removed	Confidential information has been removed	Confidential information has been removed	Confidential information has been removed	Confidential information has been removed	Confidential information has been removed
	16		NR	Confidential information has been removed	Confidential information has been removed	Confidential information has been removed	NR	Confidential information has been removed	Confidential information has been removed
	24		Confidential information has been removed	3.18 (1.30 to 7.77)	3.18 (0.62 to 10.75)	11.65 (0.67 to 202.75)	NR	7.64 (1.11 to 52.56)	4.36 (0.57 to 33.32)

CI, confidence interval; NR, not reported.

Note

Results for the 150-mg biologic-experienced subgroup are not presented as licence states that biologic-experienced patients should take 300 mg.

All three study arms showed improvements in physical function as assessed using HAQ-DI change from baseline scores; HAQ-DI assesses a patient's ability to perform eight categories of activities of daily living. Patients taking SEC had greater reductions in HAQ-DI scores than patients taking the placebo (see *Table 8*). At 24 weeks, the difference when compared with placebo (−0.25 units) was statistically significant for 300 mg ($p = 0.004$), but the difference of −0.17 units for 150 mg did not quite reach statistical significance ($p = 0.055$).⁴⁸ The manufacturer also submitted HAQ-DI results based on PsARC responder status (*Table 13*). These results show (confidential information has been removed).

Efficacy in the biologic-naïve and biologic-experienced subgroups

Table 12 also presents RRs for the subgroups based on patients' previous use of biologics. These subgroup results are difficult to interpret for several reasons. Some of the subgroup sample sizes were particularly small: there were no placebo responders (PRs) for some outcomes in the biologic-experienced subgroup and the RR confidence intervals (CIs) were therefore extremely wide. The PASI results are effectively based on subgroups (previous biologic status) of a subgroup (patients with psoriasis covering $\geq 3\%$ of BSA). Placebo response rates also differed across subgroups (see *Evaluating the secukinumab and certolizumab pegol trial results in comparison with other treatments*). Similar subgroup issues were also seen for CZP (see *Efficacy in the RAPID-PsA biologic-naïve and biologic-experienced subgroups*).

The manufacturer also submitted HAQ-DI results based on PsARC responder status for the biologic-naïve and biologic-experienced population (*Table 14*). Again, comparisons between the two subgroups is difficult as (confidential information has been removed).

Other efficacy results

Efficacy of secukinumab with or without concomitant methotrexate

Just under half of the patients in FUTURE 2⁴⁸ took concomitant MTX. In exploratory post hoc analyses, SEC was found to be similarly efficacious whether or not patients were taking concomitant MTX.⁴⁸ For ACR 50, response rates were statistically significantly higher in the 300- and 150-mg groups than in the placebo group for both the concomitant MTX subgroup ($p = 0.001$ and $p = 0.006$, respectively) and the no concomitant MTX subgroup ($p = 0.007$ and $p < 0.0001$, respectively). Similar statistically significant differences were also reported for the ACR 20 and 70 thresholds.⁴⁸

Efficacy of secukinumab in the one prior DMARD subgroup

Data were presented in the manufacturer's submission at week 24 for efficacy in the one prior DMARD subgroup. (Confidential information has been removed.)

TABLE 13 Health Assessment Questionnaire-Disability Index changes based on PsARC responder status in the FUTURE 2 trial⁴⁸

Population	Time point (weeks)	Group, HAQ-DI change (SE)					
		Placebo		150 mg		300 mg	
		Responders	Non-responders	Responders	Non-responders	Responders	Non-responders
All	12	Confidential information has been removed	Confidential information has been removed	Confidential information has been removed	Confidential information has been removed	Confidential information has been removed	Confidential information has been removed
	16	Confidential information has been removed	Confidential information has been removed	Confidential information has been removed	Confidential information has been removed	Confidential information has been removed	Confidential information has been removed

SE, standard error.

TABLE 14 Health Assessment Questionnaire-Disability Index changes based on PsARC responder status for biologic-naive and biologic-experienced subgroups in the FUTURE 2 trial⁴⁸

Population	Time point (weeks)	Group, HAQ-DI change (SE)					
		Placebo		150 mg		300 mg	
		Responders	Non-responders	Responders	Non-responders	Responders	Non-responders
Biologic naive	12	Confidential information has been removed	Confidential information has been removed	Confidential information has been removed	Confidential information has been removed	Confidential information has been removed	Confidential information has been removed
	16	Confidential information has been removed	Confidential information has been removed	Confidential information has been removed	Confidential information has been removed	Confidential information has been removed	Confidential information has been removed
	24	Confidential information has been removed	Confidential information has been removed	Confidential information has been removed	Confidential information has been removed	Confidential information has been removed	Confidential information has been removed
Biologic experienced	12	Confidential information has been removed	Confidential information has been removed	Confidential information has been removed	Confidential information has been removed	Confidential information has been removed	Confidential information has been removed
	16	Confidential information has been removed	Confidential information has been removed	Confidential information has been removed	Confidential information has been removed	Confidential information has been removed	Confidential information has been removed
	24	Confidential information has been removed	Confidential information has been removed	Confidential information has been removed	Confidential information has been removed	Confidential information has been removed	Confidential information has been removed

SE, standard error.

Efficacy in treating dactylitis and enthesitis

At week 24, relative to placebo treatment with both 150 and 300 mg of SEC statistically significantly improved the resolution of both dactylitis (as measured via the Leeds Dactylitis Index; LDI) and enthesitis (as measured via the Leeds Enthesitis Index; LEI) (*Table 15*).

Health-related quality of life

Up to week 24, improvement in the EQ-5D overall health state (as measured by a visual analogue scale; VAS) was higher in both SEC groups (150 and 300 mg) than in the placebo group. (Confidential information has been removed.)

At week 24, self-reported quality of life and physical functioning, as measured by SF-36 Physical Component Summary score, was found to have improved more in the SEC groups than in the placebo group (SEC 150 mg, 6.39 points; SEC 300 mg, 7.25 points; placebo, 1.95 points).

Mortality

No deaths were reported during the trial.

ERASURE and FIXTURE trials

As the focus of the ERASURE and FIXTURE trials⁴⁹ was on patient populations with psoriasis (subgroups of which also had PsA), fewer outcomes that were relevant to this assessment were evaluated. Patients recruited

TABLE 15 Efficacy in treating dactylitis and enthesitis in the FUTURE 2 trial⁴⁸

Outcome	Trial arm		
	300 mg of SEC	150 mg of SEC	Placebo
Resolution of dactylitis at week 24	Confidential information has been removed; $p = 0.0021$	Confidential information has been removed; $p = 0.0056$	Confidential information has been removed
Resolution of enthesitis at week 24	Confidential information has been removed; $p = 0.0025$	Confidential information has been removed; $p = 0.0108$	Confidential information has been removed
Dactylitis count at week 16, mean change from baseline \pm SD	-2.3 ± 4.0	-3.1 ± 4.5	-0.6 ± 2.4
Enthesitis count at week 16, mean change from baseline \pm SD	-1.7 ± 1.8	-1.5 ± 2.0	-0.9 ± 2.1

SD, standard deviation.

into in the ERASURE and FIXTURE trials had more severe psoriasis but lower baseline HAQ-DI scores than the patients recruited into the FUTURE 2 trial and into the other trials included in the systematic review (see *Table 4*). The FIXTURE trial was one of the very few identified in the systematic review that compared different biologics (SEC with ETN).

Table 16 and *Figure 2* (in which data from the ERASURE and FIXTURE trials have been pooled) illustrate SEC's superiority over placebo for the PASI outcomes. In the FIXTURE trial at 12 weeks, 300 mg of SEC was statistically significantly more effective than 50 mg of ETN twice weekly in terms of patients achieving a PASI 75 response (RR 1.86, 95% CI 1.24 to 2.81) and a PASI 90 response (RR 2.42, 95% CI 1.20 to 4.88). Changes from baseline in the HAQ-DI scores were greater in SEC- and ETN-treated patients in ERASURE and FIXTURE trials than with placebo.

CLEAR trial

The CLEAR trial,^{62,63} which compared SEC with UST, was similar to the ERASURE and FIXTURE trials⁴⁹ with respect to the population studied (patients with more severe psoriasis than those recruited into the FUTURE 2 trial) and the limited data assessed and reported (in the CLEAR trial only PASI 90 and HAQ-DI scores were reported for the subgroup of patients with PsA).

TABLE 16 Efficacy outcomes in the ERASURE and FIXTURE trials at 12 weeks⁴⁹

Trial	Treatment	Number of PsA patients	PASI 50	PASI 75	PASI 90	HAQ-DI change from baseline ^a
ERASURE ⁴⁹	300 mg of SEC	57	–	38 (67%)	30 (53%)	–0.35
	150 mg of SEC	46	–	32 (70%)	20 (43%)	–0.18
	Placebo	68	–	3 (4%)	0 (0%)	–0.08
FIXTURE ⁴⁹	300 mg of SEC	50	–	36 (72%)	22 (44%)	–0.41
	150 mg of SEC	49	–	29 (59%)	19 (39%)	–0.19
	50 mg of ETN	44	–	17 (39%)	8 (18%)	–0.29
	Placebo	49	–	1 (2%)	1 (2%)	0.02

a Standard errors not reported.

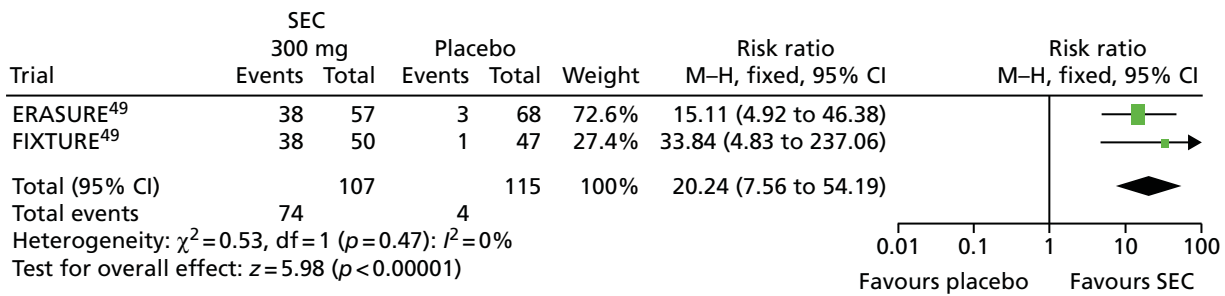

FIGURE 2 Forest plot of the efficacy of 300 mg of SEC vs. placebo for PASI 75 at 12 weeks in PsA patients with moderate–severe psoriasis.⁴⁹ df, degrees of freedom; M–H, Mantel–Haenszel.

At 16 weeks, patients treated with 300 mg of SEC had a better PASI 90 response rate than patients receiving 45 or 90 mg of UST, although the difference was not statistically significant (RR 1.23, 95% CI 0.98 to 1.55; $p=0.08$). Patients treated with 300 mg of SEC had a greater improvement in HAQ-DI score than patients receiving 45 or 90 mg of UST (*Table 17*).

Summary

The results of the FUTURE 2 trial⁴⁸ demonstrated the short-term efficacy of SEC in treating PsA. When considering the whole-trial population, SEC was associated with statistically and clinically significant improvements in all key outcomes. Patients taking SEC were around six times more likely to be ACR 50 responders – a key clinical outcome to patients – than patients taking placebo. Clinically important improvements in activities of daily living (assessed using the HAQ-DI) were also evident in patients taking SEC, particularly in patients who were PsARC responders. However, when the trial population was split into subgroups based on previous biologic experience, the resulting RRs for the biologic-experienced subgroup became difficult to interpret. This was attributable to both the low numbers of placebo patients and the differences in placebo response rates across subgroups (see *Evaluating the secukinumab and certolizumab pegol trial results in comparison with other treatments*). Although SEC is efficacious in both subgroups, it is not possible to make robust conclusions about any difference in the efficacy of SEC across these subgroups. Similar efficacy across the ACR outcomes was evident in subgroups of patients based on presence or absence of concomitant MTX, although limited data and analyses were available specifically for the one prior DMARD group. Treatment with SEC resulted in statistically significant improvements in HRQoL measures and in the resolution of both dactylitis and enthesitis.

Results from the trials of patients with more severe psoriasis demonstrated SEC's superiority over placebo in terms of psoriasis (as measured by the PASI) and function (as measured by the HAQ-DI) outcomes. SEC was also found to be significantly more effective than ETN in improving psoriasis (assessed using PASI 75 and PASI 90). However, the populations studied in these trials had quite severe psoriasis and less functional impairment (lower baseline HAQ-DI scores) than other trial populations. Their results should not therefore be generalised to more typical PsA populations.

TABLE 17 Efficacy outcomes in the CLEAR trial^{62,63} at 16 weeks for the subgroup of PsA patients

Treatment	Number of patients randomised	PASI 50	PASI 75	PASI 90	HAQ-DI change from baseline ^a
300 mg of SEC	69	–	–	55 (80%)	–0.29
45 or 90 mg of UST	54	–	–	35 (65%)	–0.13

^a Standard errors not reported.

Short-term efficacy of certolizumab pegol

One eligible RCT of CZP was identified. RAPID-PsA⁴⁷ compared 200 or 400 mg of CZP against placebo up to 24 weeks. The trial was dose blinded to 48 weeks and then open label to 216 weeks. Placebo patients who failed to achieve a 10% improvement from baseline in both swollen and tender joints at week 14 and 16 were re-randomised to active treatment at week 16. At week 24, all the remaining placebo patients were re-randomised to receive 200 or 400 mg of CZP. The RAPID-PsA⁴⁷ trial was judged as being at low overall risk of bias (see *Table 6*).

Compared with the other PsA trials, the RAPID-PsA trial was more selective in recruiting biologic-experienced patients; patients with primary failure of a previous anti-TNF were excluded (primary failure was defined as no response within the first 12 weeks of treatment with the anti-TNF).

There are no UCB Pharma-sponsored ongoing studies of CZP in patients with PsA.

Tables 18 and 19 show the RAPID-PsA trial results⁴⁷ for the key review outcomes for the full-trial population across the 12-, 16- and 24-week time points. ACR 20 results, split into subgroups according to the number of previous DMARDs taken by patients, are presented in *Table 20*. Results for the biologic-naive and biologic-experienced subgroups are presented in *Tables 21–24*. The corresponding RRs for the dichotomous outcomes were calculated by the ERG and are presented in *Table 25*.

TABLE 18 Psoriatic Arthritis Response Criteria, ACR and HAQ-DI responses in the RAPID-PsA trial⁴⁷

Population	Treatment	Time point (weeks)	Number of patients randomised	Responders, n (%)				HAQ-DI change from baseline (SE)
				PsARC	ACR 20	ACR 50	ACR 70	
All	200 mg of CZP every fortnight	12	138	101 (73)	80 (58)	50 (36)	34 (25)	-0.45 (0.56)
	400 mg of CZP once a month		135	89 (66)	70 (52)	44 (33)	17 (13)	-0.39 (0.47)
	Placebo		136	52 (38)	33 (24)	15 (11)	4 (3)	-0.16 (0.36)
All	200 mg of CZP every fortnight	16	138	–	78 (57)	–	–	–
	400 mg of CZP once a month		135	–	73 (54)	–	–	–
	Placebo		136	–	34 (25)	–	–	–
All	200 mg of CZP every fortnight	24	138	108 (78)	88 (64)	61 (44)	39 (28)	-0.52 (0.66)
	400 mg of CZP once a month		135	104 (77)	76 (56)	54 (40)	32 (24)	-0.43 (0.54)
	Placebo		136	45 (33)	32 (24)	17 (13)	6 (4)	-0.17 (0.43)

SE, standard error.

TABLE 19 Psoriasis Area and Severity Index response rates in the RAPID-PsA trial⁴⁷

Population	Treatment	Time point (weeks)	Number of patients with psoriasis affecting $\geq 3\%$ BSA	PASI 50	PASI 75	PASI 90
All	200 mg of CZP every fortnight	12	90	62 (69%)	42 (47%)	20 (22%)
	400 mg of CZP once a month		76	48 (63%)	36 (47%)	15 (20%)
	Placebo		86	23 (27%)	12 (14%)	4 (5%)
All	200 mg of CZP every fortnight	24	90	67 (74%)	56 (62%)	42 (47%)
	400 mg of CZP once a month		76	55 (72%)	46 (61%)	27 (36%)
	Placebo		86	24 (28%)	13 (15%)	5 (6%)

TABLE 20 The RAPID-PsA trial⁴⁷ ACR 20 response rates at 12 weeks for subgroups of previous DMARD use

Population	Treatment	Number of patients randomised	ACR 20
Previous use of one DMARD	200 mg of CZP every fortnight	61	42 (69%)
	400 mg of CZP once a month	72	42 (58%)
	Placebo	74	22 (30%)
Previous use of two or more DMARDs	200 mg of CZP every fortnight	73	38 (52%)
	400 mg of CZP once a month	60	28 (47%)
	Placebo	60	11 (18%)

TABLE 21 Biologic-naive and biologic-experienced subgroup PsARC, ACR and HAQ-DI results in the RAPID-PsA trial⁴⁷ at 12 weeks

Population	Drug	Number of patients randomised	PsARC	ACR 20	ACR 50	ACR 70	HAQ-DI change from baseline (SE)
Biologic naive	CZP combined	Confidential information has been removed	Confidential information has been removed	Confidential information has been removed	Confidential information has been removed	Confidential information has been removed	Confidential information has been removed
	Placebo	Confidential information has been removed	Confidential information has been removed	Confidential information has been removed	Confidential information has been removed	Confidential information has been removed	Confidential information has been removed
Biologic experienced	CZP combined	Confidential information has been removed	Confidential information has been removed	Confidential information has been removed	Confidential information has been removed	Confidential information has been removed	Confidential information has been removed
	Placebo	Confidential information has been removed	Confidential information has been removed	Confidential information has been removed	Confidential information has been removed	Confidential information has been removed	Confidential information has been removed

SE, standard error.

TABLE 22 Biologic-naive and biologic-experienced subgroup PASI response rates in the RAPID-PsA trial⁴⁷ at 12 weeks

Population	Drug	Number of patients with psoriasis affecting $\geq 3\%$ BSA	PASI 50	PASI 75	PASI 90
Biologic naive	CZP combined	130	80 (62%)	56 (43%)	25 (19%)
	Placebo	66	18 (27%)	11 (17%)	3 (5%)
Biologic experienced	CZP combined	36	30 (83%)	22 (61%)	10 (28%)
	Placebo	20	5 (25%)	1 (5%)	1 (5%)

TABLE 23 Biologic-naive and biologic-experienced PsARC, ACR and HAQ-DI subgroup results from the RAPID-PsA trial⁴⁷ at 24 weeks

Population	Drug	Time point (weeks)	Number of patients randomised	PsARC	ACR 20	ACR 50	ACR 70	HAQ-DI change from baseline (SE)
Biologic naive	CZP combined	24	219	170 (78%)	132 (60%)	91 (42%)	57 (26%)	-0.45 (0.6)
	Placebo		110	59 (54%)	29 (26%)	16 (15%)	5 (5%)	-0.2 (0.45)
Biologic experienced	CZP combined	24	Confidential information has been removed	Confidential information has been removed	Confidential information has been removed	Confidential information has been removed	Confidential information has been removed	Confidential information has been removed
	Placebo		Confidential information has been removed	Confidential information has been removed	Confidential information has been removed	Confidential information has been removed	Confidential information has been removed	Confidential information has been removed

SE, standard error.

TABLE 24 Biologic-naive and biologic-experienced PASI subgroup results from the RAPID-PsA trial⁴⁷ at 24 weeks

Population	Drug	Time point (weeks)	Number of patients with psoriasis affecting $\geq 3\%$ BSA	PASI 50	PASI 75	PASI 90
Biologic naive	CZP combined	24	130	89 (68%)	73 (56%)	48 (37%)
	Placebo		66	20 (30%)	13 (20%)	5 (8%)
Biologic experienced	CZP combined	24	36	33 (92%)	29 (81%)	21 (58%)
	Placebo		20	4 (20%)	0 (0%)	0 (0%)

TABLE 25 Relative risks for key outcomes in the RAPID-PsA trial:⁴⁷ 200 or 400 mg of CZP vs. placebo

Dose	Time point (weeks)	Population	RR (95% CI)						
			PsARC	ACR 20	ACR 50	ACR 70	PASI 50	PASI 75	PASI 90
200 mg every fortnight	12	All	1.91 (1.51 to 2.42)	2.39 (1.72 to 3.32)	3.29 (1.94 to 5.56)	8.38 (3.06 to 12.39)	2.58 (1.77 to 3.75)	3.34 (1.89 to 5.91)	4.78 (1.70 to 13.41)
	16		NR	2.26 (1.63 to 3.13)	NR	NR	NR	NR	NR
	24		2.37 (1.83 to 3.05)	2.71 (1.95 to 3.76)	3.54 (2.18 to 5.73)	6.41 (2.80 to 14.64)	2.67 (1.86 to 3.83)	4.12 (2.43 to 6.97)	8.03 (3.33 to 19.33)
400 mg every 4 weeks	12	All	1.72 (1.35 to 2.20)	2.14 (1.52 to 3.00)	2.96 (1.73 to 5.05)	4.28 (1.48 to 12.39)	2.36 (1.60 to 3.49)	3.39 (1.91 to 6.04)	4.24 (1.47 to 12.23)
	16		NR	2.16 (1.55 to 3.01)	NR	NR	NR	NR	NR
	24		2.33 (1.80 to 3.01)	2.39 (1.71 to 3.35)	3.20 (1.96 to 5.23)	5.37 (2.32 to 12.43)	2.59 (1.80 to 3.74)	4.00 (2.35 to 6.82)	6.11 (2.48 to 15.07)
Combined arms	12	Biologic naive	Confidential information has been removed	Confidential information has been removed	Confidential information has been removed	Confidential information has been removed	Confidential information has been removed	Confidential information has been removed	Confidential information has been removed
	24		Confidential information has been removed	Confidential information has been removed	Confidential information has been removed	Confidential information has been removed	Confidential information has been removed	Confidential information has been removed	Confidential information has been removed
Combined arms	12	Biologic experienced	Confidential information has been removed	Confidential information has been removed	Confidential information has been removed	Confidential information has been removed	Confidential information has been removed	Confidential information has been removed	Confidential information has been removed
	24		Confidential information has been removed	Confidential information has been removed	Confidential information has been removed	Confidential information has been removed	Confidential information has been removed	Confidential information has been removed	Confidential information has been removed

NR, not reported.

Efficacy at 12–24 weeks in the RAPID PsA full-trial population

For the full-trial population, the RRs in *Table 25* are for comparisons of the different CZP regimens (200 mg every 2 weeks or 400 mg every 4 weeks) with placebo, across the 12-, 16- and 24-week time points and across the PsARC, ACR and PASI outcomes. For the subgroup analyses (based on previous biologic status), combined data from the two CZP arms were used to calculate RRs.

For the full-trial population, when compared with placebo, CZP was associated with statistically significant improvements in all outcomes at all time points (for which data were available). Patients taking CZP were around three times more likely to be ACR 50 responders than patients taking placebo. Similar to the pattern seen with the SEC FUTURE 2 trial⁴⁸ results, an increase in RRs is apparent as the outcome thresholds (for achieving a response) increase across the PsARC, ACR and PASI outcomes (see *Table 25*). Again, these increases are likely to be a consequence of the different placebo rates, with higher rates of placebo response in the lower threshold outcomes.

The RAPID-PsA trial⁴⁷ patients taking CZP were around two-and-a-half times more likely to be PASI 50 responders than patients taking placebo. Efficacy was also demonstrated in the results for the higher PASI thresholds. Improvements in physical function, as assessed using HAQ-DI change from baseline scores, were also seen, with the difference being reported as being statistically significant ($p < 0.001$) at 24 weeks.⁴⁷ The manufacturer also submitted HAQ-DI results based on PsARC responder status (*Table 26*). (Confidential information has been removed.)

Efficacy in the RAPID-PsA biologic-naïve and biologic-experienced subgroups

Table 25 presents RRs for subgroups based on patients' previous use of biologics. When comparing results for all outcomes across subgroups the efficacy of CZP appears somewhat better in the biologic-experienced subgroup than in the biologic-naïve subgroup; this trial evidence is contrary to evidence from large patient registries suggesting that effectiveness may decrease with each new anti-TNF taken (see *Drug survival and anti-tumour necrosis factor switching*). The differences between subgroups observed in the RAPID-PsA trial⁴⁷ are likely to have been influenced by two factors. First, there is a problem with sample size, with low numbers of placebo patients and PRs in the biologic-experienced subgroup. There is therefore considerable uncertainty about these estimates, which is reflected in the very wide CIs. Second, there is a notable difference in placebo response rates between the two subgroups (see *Table 21* and *Evaluating the secukinumab and certolizumab pegol trial results in comparison with other treatments*). Furthermore, as detailed previously in *Characteristics of the randomised controlled trials included in the systematic review of short-term efficacy*, the RAPID-PsA trial excluded patients with primary failure of a previous biologic, so the subgroups were not as different as they could have been (other trials did not exclude primary failures).

TABLE 26 The RAPID-PsA trial⁴⁷ HAQ-DI changes from baseline based on PsARC responder status

Population	Time point (weeks)	Group, HAQ-DI change (SD)					
		Placebo		200 mg		400 mg	
		Responders	Non-responders	Responders	Non-responders	Responders	Non-responders
All	12	Confidential information has been removed	Confidential information has been removed	Confidential information has been removed	Confidential information has been removed	Confidential information has been removed	Confidential information has been removed
	24	Confidential information has been removed	Confidential information has been removed	Confidential information has been removed	Confidential information has been removed	Confidential information has been removed	Confidential information has been removed

SD, standard deviation.

The manufacturer also submitted HAQ-DI results based on PsARC responder status for the biologic-naive and biologic-experienced populations (*Table 27*). (Confidential information has been removed.)

Other efficacy results

Efficacy of certolizumab pegol with or without concomitant methotrexate

Results were not reported for subgroups based specifically on MTX use, although results were reported based on concomitant use of a DMARD (which was mostly MTX). Concomitant DMARD use did not seem to affect ACR 20 (57% with vs. 50% without) or PsARC (68% with vs. 73% without) response rates to CZP (combined dose) at week 12.⁴⁷

Efficacy of certolizumab pegol in the one prior DMARD subgroup

When compared with placebo, at weeks 12 and 24, CZP was associated with statistically significantly better ACR 20 response rates ($p < 0.001$); 207 patients who had received one prior DMARD were included in the analysis.⁴⁷ Data in the manufacturer's submission showed that (confidential information has been removed).

Efficacy in treating dactylitis and enthesitis

At week 24, patients treated with CZP achieved statistically significant improvements in dactylitis (assessed using the LDI) when compared with placebo-treated patients; statistically significant improvements in enthesitis, as assessed using the LEI, were also seen in the CZP group (*Table 28*).

Health-related quality of life

At week 12, EQ-5D VAS scores were higher in CZP-treated groups (confidential information has been removed).

In addition, at week 24, there was a significant improvement with pooled CZP in all domains of the SF-36, including both the physical (confidential information has been removed) and mental components (confidential information has been removed), regardless of the dose regimen and prior TNF inhibitor status. (Confidential information has been removed.)

TABLE 27 The HAQ-DI changes based on PsARC responder status for biologic-naive and biologic-experienced subgroups in the RAPID-PsA trial⁴⁷

Population	Time point (weeks)	Group, HAQ-DI change (SD)					
		Placebo		200 mg		400 mg	
		Responders	Non-responders	Responders	Non-responders	Responders	Non-responders
Biologic naive	12	Confidential information has been removed	Confidential information has been removed	Confidential information has been removed	Confidential information has been removed	Confidential information has been removed	Confidential information has been removed
	24	Confidential information has been removed	Confidential information has been removed	Confidential information has been removed	Confidential information has been removed	Confidential information has been removed	Confidential information has been removed
Biologic experienced	12	Confidential information has been removed	Confidential information has been removed	Confidential information has been removed	Confidential information has been removed	Confidential information has been removed	Confidential information has been removed
	24	Confidential information has been removed	Confidential information has been removed	Confidential information has been removed	Confidential information has been removed	Confidential information has been removed	Confidential information has been removed

SD, standard deviation.

TABLE 28 Efficacy in treating dactylitis and enthesitis in the RAPID-PsA trial⁴⁷

Treatment	Outcome, mean change from baseline at week 24	
	Dactylitis count \pm SD	Enthesitis count \pm SD
200 mg of CZP	-40.7 ± 34.6 ; $p \leq 0.003$	-2.0 ± 1.8 ; $p < 0.001$
400 mg of CZP	-53.5 ± 69.1 ; $p < 0.001$	-1.8 ± 1.9 ; $p \leq 0.003$
Placebo	-22.0 ± 46.9	-1.1 ± 1.8

SD, standard deviation.

Mortality

Two deaths were reported during the 24 weeks: one was in the 200-mg group and one was in the 400-mg group. The trial investigators considered both deaths to be unrelated to study medication.

Summary

The results of the RAPID-PsA trial⁴⁷ demonstrated the short-term efficacy of CZP in treating PsA. When considering the full-trial population, CZP was associated with statistically significant improvements in all key outcomes. When the trial population was split into subgroups based on previous biologic experience, the results became difficult to compare (as was seen in the FUTURE 2 trial). The small number of placebo patients in the biologic-experienced subgroup coupled with higher placebo response rates in the biologic-naïve subgroup meant that it was not possible to make reliable conclusions about the difference in the efficacy of CZP across these subgroups. Furthermore, patients with primary failure of a previous biologic were excluded from the RAPID-PsA trial, so estimates of efficacy may have been slightly inflated when comparisons were made with other trials that recruited biologic-experienced patients (e.g. FUTURE 2⁴⁸ and PSUMMIT 2^{59,66}). Similar efficacy across the ACR and PsARC outcomes was seen in subgroups of patients based on presence or absence of a concomitant DMARD and (confidential information has been removed). Treatment with CZP resulted in statistically significant improvements in HRQoL measures and in the resolution of both dactylitis and enthesitis.

Evaluating the secukinumab and certolizumab pegol trial results in comparison with other treatments

In order to more fully evaluate the clinical efficacy of SEC and CZP, the trial results of these two newer biologics need to be compared with each other and with the results of the older biologics (and APR). However, this is not straightforward for two reasons. First, there is variation across trials with respect to previous biologic use.

- The populations recruited to clinical trials have changed over time, with earlier trials excluding biologic-experienced patients and later trials including such patients.
- The RAPID-PsA trial was more selective than the FUTURE 2,⁴⁸ PSUMMIT 2^{59,66} and PALACE trials^{60,61,65} in recruiting its biologic-experienced patients: only in RAPID-PsA were patients with primary failure of a previous biologic excluded (see *Characteristics of the randomised controlled trials included in the systematic review of short-term efficacy*).

Second, placebo response rates have increased markedly over time across the trials included in this review. This issue is key when interpreting RRs because, although RRs are easy to interpret clinically, their ceilings (maximum values) are limited by baseline response rates. For example, in the FUTURE 2 trial⁴⁸ the placebo response rate for PsARC was (confidential information has been removed) in the biologic-naïve subgroup. This high rate meant that the maximum possible RR would be (confidential information has been removed); this maximum result is lower than some of the *actual* RRs for other biologics presented in *Table 29*, which

TABLE 29 Unadjusted RRs (compared with placebo) across the trials included in the evidence synthesis

Trial name	Treatment	Time point (weeks)	Population	RR (95% CI)						
				PsARC	ACR 20	ACR 50	ACR 70	PASI 50	PASI 75	PASI 90
FUTURE 2 ⁴⁸	300 mg of SEC	12	All	Confidential information has been removed	2.23 (1.53 to 3.26)	Confidential information has been removed	NR	7.13 (3.09 to 16.45)	12.59 (3.17 to 49.91)	8.39 (2.06 to 34.24)
	150 mg of SEC	12	All	Confidential information has been removed	2.20 (1.50 to 3.21)	Confidential information has been removed	NR	7.12 (3.10 to 16.36)	11.49 (2.91 to 45.42)	7.04 (1.73 to 28.64)
	300 mg of SEC	12	Biologic naive	Confidential information has been removed	Confidential information has been removed	Confidential information has been removed	Confidential information has been removed	Confidential information has been removed	Confidential information has been removed	6.20 (1.15 to 25.40)
	150 mg of SEC	12	Biologic naive	Confidential information has been removed	Confidential information has been removed	Confidential information has been removed	Confidential information has been removed	Confidential information has been removed	Confidential information has been removed	5.60 (1.37 to 22.91)
	300 mg of SEC	12	Biologic experienced	Confidential information has been removed	Confidential information has been removed	Confidential information has been removed	Confidential information has been removed	Confidential information has been removed	Confidential information has been removed	9.78 (0.59 to 162.47)
	150 mg of SEC	12	Biologic experienced	Confidential information has been removed	Confidential information has been removed	Confidential information has been removed	Confidential information has been removed	Confidential information has been removed	Confidential information has been removed	7.22 (0.44 to 117.84)
SPIRIT-P1 ^{57,67}	ADA	12	All	NR	1.65 (1.18 to 2.32)	6.30 (2.54 to 15.59)	38.82 (2.37 to 635.80)	NR	5.21 (2.50 to 10.85)	14.78 (2.01 to 108.77)
RAPID-PsA ⁴⁷	CZP 200 mg	12	All	Confidential information has been removed	2.39 (1.72 to 3.32)	3.29 (1.94 to 5.56)	8.38 (3.06 to 22.97)	2.58 (1.77 to 3.75)	3.34 (1.89 to 5.91)	4.78 (1.70 to 13.41)
	CZP 400 mg	12	All	Confidential information has been removed	2.14 (1.52 to 3.00)	2.96 (1.73 to 5.05)	4.28 (1.48 to 12.39)	2.36 (1.60 to 3.49)	3.39 (1.91 to 6.04)	4.24 (1.47 to 12.23)

continued

TABLE 29 Unadjusted RRs (compared with placebo) across the trials included in the evidence synthesis (*continued*)

Trial name	Treatment	Time point (weeks)	Population	RR (95% CI)						
				PsARC	ACR 20	ACR 50	ACR 70	PASI 50	PASI 75	PASI 90
	CZP combined	12	Biologic naive	Confidential information has been removed	Confidential information has been removed	Confidential information has been removed	Confidential information has been removed	Confidential information has been removed	Confidential information has been removed	5.56 (0.77 to 40.30)
	CZP combined	12	Biologic experienced	Confidential information has been removed	Confidential information has been removed	Confidential information has been removed	Confidential information has been removed	Confidential information has been removed	Confidential information has been removed	4.70 (2.01 to 11.01)
PALACE 1 ^{60,61}	APR	16	All	1.56 (1.17 to 2.07)	2.00 (1.39 to 2.89)	2.70 (1.35 to 5.40)	3.50 (0.74 to 16.60)	2.71 (1.50 to 4.91)	4.98 (1.53 to 16.18)	NR
PALACE 2 ^{61,65}	APR	16	All	1.44 (1.10 to 1.90)	1.70 (1.15 to 5.52)	2.09 (0.93 to 4.69)	1.96 (0.18 to 21.43)	3.17 (1.69 to 5.96)	8.17 (1.95 to 34.14)	NR
PALACE 3 ^{61,65}	APR	16	All	1.94 (1.46 to 2.58)	2.22 (1.54 to 3.20)	1.81 (0.97 to 3.35)	1.52 (0.44 to 5.28)	1.71 (1.10 to 2.64)	2.83 (1.26 to 6.35)	NR
PSUMMIT 2 ^{59,66}	45 mg of UST	12	Biologic naive	NR	2.08 (1.01 to 4.28)	1.63 (0.42 to 6.39)	2.93 (0.32 to 27.06)	NR	14.17 (2.00 to 100.35)	NR
PSUMMIT 2 ^{59,66}	45 mg of UST	24	Biologic naive	1.47 (0.92 to 2.34)	1.87 (1.08 to 3.26)	2.93 (0.85 to 10.08)	1.95 (0.38 to 10.10)	NR	5.83 (1.93 to 17.67)	NR
	45 mg of UST	12	Biologic experienced	NR	2.64 (1.33 to 5.23)	9.30 (1.21 to 71.19)	9.30 (0.51 to 169.03)	NR	15.91 (2.18 to 116.14)	NR
	45 mg of UST	24	Biologic experienced	2.13 (1.32 to 3.44)	2.53 (1.27 to 5.03)	2.33 (0.76 to 7.15)	3.10 (0.33 to 28.98)	NR	22.73 (3.18 to 162.50)	NR
	45 mg of UST	12	All	1.65 (1.18 to 2.31)	2.38 (1.44 to 3.91)	3.53 (1.20 to 10.38)	7.07 (0.89 to 56.44)	7.29 (3.52 to 15.07)	15.50 (3.84 to 62.60)	16.00 (2.17 to 117.80)
	45 mg of UST	24	All	1.80 (1.28 to 2.52)	2.16 (1.39 to 3.36)	2.60 (1.13 to 5.95)	2.36 (0.63 to 8.86)	NR	10.25 (3.85 to 27.28)	NR

Trial name	Treatment	Time point (weeks)	Population	RR (95% CI)						
				PsARC	ACR 20	ACR 50	ACR 70	PASI 50	PASI 75	PASI 90
PSUMMIT 1 ⁵⁸	45 mg of UST	12	Biologic naive	1.62 (1.31 to 2.01)	1.94 (1.43 to 2.64)	3.47 (1.83 to 6.60)	2.68 (0.72 to 9.96)	NR	4.34 (2.48 to 7.58)	NR
	45 mg of UST	24	Biologic naive	1.50 (1.21 to 1.86)	1.86 (1.38 to 2.50)	2.85 (1.72 to 4.70)	5.02 (1.96 to 12.87)	2.89 (2.06 to 4.05)	5.22 (3.22 to 8.47)	NR
GO-REVEAL ⁵⁰	50 mg of GOL	14	All (biologic naive)	3.45 (2.39 to 4.99)	5.73 (3.10 to 10.57)	17.03 (4.22 to 68.75)	13.93 (1.89 to 102.80)	6.52 (3.16 to 13.47)	15.94 (3.98 to 63.84)	32.67 (2.01 to 530.63)
Genovese <i>et al.</i> , 2007 ⁵⁶	ADA	12	All (biologic naive)	1.86 (1.10 to 3.13)	2.50 (1.21 to 5.15)	13.00 (1.77 to 95.73)	15.00 (0.88 to 255.86)	NR	NR	NR
ADEPT ⁵⁵	ADA	12	All (biologic naive)	2.37 (1.77 to 3.16)	4.05 (2.71 to 6.06)	9.53 (4.22 to 21.51)	31.76 (4.39 to 230.09)	5.00 (2.77 to 9.03)	11.33 (3.65 to 35.17)	43.00 (2.66 to 695.98)
IMPACT 2 ⁵²	INF	14	All (biologic naive)	2.85 (2.03 to 4.01)	5.27 (2.95 to 9.44)	12.00 (3.82 to 37.70)	15.00 (2.02 to 111.42)	8.91 (4.57 to 17.38)	27.78 (6.99 to 110.35)	72.31 (4.50 to 1160.52)
IMPACT ⁵¹	INF	16	All (biologic naive)	3.55 (2.05 to 6.13)	6.80 (2.89 to 16.01)	49.00 (3.06 to 784.91)	31.00 (1.90 to 504.77)	33.00 (2.15 to 505.75)	22.73 (1.46 to 353.35)	12.47 (0.77 to 201.07)
Mease <i>et al.</i> , 2004 ⁵⁴	ETN	12	All (biologic naive)	2.35 (1.72 to 3.21)	3.86 (2.39 to 6.23)	9.78 (3.62 to 26.41)	23.68 (1.41 to 396.59)	NR	NR	NR
Mease <i>et al.</i> , 2000 ⁵³	ETN	12	All (biologic naive)	3.71 (1.91 to 7.21)	5.50 (2.15 to 14.04)	15.00 (2.11 to 106.49)	9.00 (0.51 to 160.07)	2.00 (0.72 to 5.54)	11.00 (0.65 to 185.70)	NR

GO-REVEAL, Golimumab – A Randomized Evaluation of Safety and Efficacy in Subjects with Psoriatic Arthritis Using a Human Anti-TNF Monoclonal Antibody; NR, not reported; SPIRIT-P1, Study of Ixekizumab in Participants With Active Psoriatic Arthritis.

compares unadjusted RRs across the trials in the NMAs. Comparisons between treatments using odds ratios (ORs) and that adjust for the varying placebo rates were therefore necessary (see *Chapter 4*).

Examination of the trial baseline characteristics across trials offers no clear reason as to why placebo response rates in biologic trials have increased over time. The PsARC placebo response rates increased most markedly from 2013 onwards, starting with the PSUMMIT trials.^{60,61,65} One theory is that patient and clinician expectations have increased over time (i.e. more caution and lower expectations when the first biologics were trialled, and more confidence about the likely benefits in more recent trials). Subjective patient- and clinician-reported outcomes such as PsARC and ACR may be prone to such expectation effects. This theory might also explain why, within trials, higher placebo response rates are observed in the biologic-naïve subgroups than in biologic-experienced subgroups, where treatment expectations might be lower. Coupled with this is the trend – beginning with the PSUMMIT trials – for increases in the number of active treatment arms offered in trials: typically there was one active arm in the early trials and two or more active arms in more recent trials (e.g. the FUTURE 2 SEC trial had three active treatment arms: 75, 150 and 300 mg). Patients in the more recent trials might therefore also be more confident and optimistic about the likelihood that they are receiving an active treatment.

Ideally the different treatments would be compared in head-to-head trials. However, only one trial identified in the systematic review compared two or more biologics directly in a PsA population. The Atteno *et al.* trial⁶⁴ compared INF, ETN and ADA. It reported that patients on INF and ADA showed the greatest improvement in terms of PASI (statistically significantly better than ETN), whereas patients on ETN showed the greatest improvement in TJC (statistically significantly better than INF and ADA) and HAQ-DI (statistically significantly better than ADA). However, the reliability of this study's results are limited somewhat by its small size (100 patients were randomised in total). This trial also did not report its methods clearly (see *Table 6*), and was rated as being at high risk of bias (although blinding would be difficult to achieve in such a trial). Finally, by reporting results only at the 52-week time point, the results of this trial could not be included in our NMAs.

Long-term effectiveness

Open-label extension studies

Long-term efficacy of secukinumab

The Novartis submission to NICE for the appraisal in 2016 reported long-term data for both FUTURE 1⁴⁶ (to 104 weeks) and FUTURE 2⁴⁸ (to 52 weeks) trials. Although the FUTURE 1 trial⁴⁶ was not eligible for the systematic review of efficacy because it initiated the randomised phase of the study with a non-licensed high loading dose (10 mg/kg), it did use a 150-mg maintenance dose and so can be considered to provide useful long-term data. Importantly, this trial reported radiographic efficacy outcomes (at 2 years); the FUTURE 2 trial⁴⁸ did not report radiographic efficacy outcomes.

FUTURE 2

Of the FUTURE 2 trial⁴⁸ patients originally randomised to 150 or 300 mg of SEC, by week 52, 22 (11%) had withdrawn for any reason, 10 of whom withdrew as a result of an AE or loss of efficacy. In the FUTURE 2 trial,⁴⁸ most of the dichotomous data reported in the submission used non-responder imputations for missing data; a mixed-effects repeated measures model was used for continuous outcomes. There were no stopping rules up to week 52, so non-responding patients could keep taking SEC thus allowing the possibility of achievement of much later responses than would be viable in the NHS. For time points *after* week 52, the protocol stated that subjects who are deemed not to be benefiting from the study treatment based on lack of improvement or worsening of their symptoms should discontinue the study. However, results for post-week 52 time points are not yet available. Results for key review outcomes at week 52 are presented in *Table 30*. The outcomes suggest that SEC continues to be an effective treatment for PsA at this later time point.

TABLE 30 Efficacy results for the FUTURE 2 trial⁴⁸ at 52 weeks

Outcome	Trial arm	
	300 mg of SEC	150 mg of SEC
ACR response, <i>n</i>	100	100
% ACR 20	64	64
% ACR 50	44	39
% ACR 70	24	20
PASI response ($\geq 3\%$ BSA), <i>n</i>	41	58
% PASI 75	73	57
% PASI 90	56	43
PsARC response, <i>n</i>	100	100
% PsARC response	Confidential information has been removed	Confidential information has been removed
HAQ-DI, <i>n</i>	100	100
Mean (SD)	-0.56 (0.05)	-0.47 (0.05)
SF-36, <i>n</i>	100	100
Mean (SD)	Confidential information has been removed	Confidential information has been removed

SD, standard deviation.

Longer-term efficacy in FUTURE 2 trial patients who were responders at 16 weeks

In the NHS, patients will typically be allowed 16 weeks to achieve a response, after which SEC may be stopped in non-responding patients. The Assessment Group (AG) requested results specifically for patients who are responders at 16 weeks to inform what happens to this group of patients in the longer term. The results (Figures 3 and 4) indicate that for the lower threshold outcomes – such as ACR 20 and PASI 50 – response rates remain high from week 16 to week 52. As the outcome thresholds increase, response rates become more variable over time and there is generally a greater decrease in response rates than the lower threshold outcomes. Around 70% of patients on 150 mg still achieve an ACR 50 response at week 52, and around 55% still achieve an ACR 70 (see Figure 3); the corresponding results for PASI 75 and PASI 90 are around 85% and around 70%, respectively (see Figure 4).

FUTURE 1

Of the FUTURE 1 trial⁴⁶ patients originally randomised to receive 75 or 150 mg of SEC or placebo, 15% had withdrawn at week 52 for any reason, of which 6% of withdrawals were the result of an AE or loss of efficacy.⁴⁶ At week 104, 79% of patients remained in the study. Here, we report only on the long-term efficacy of 150 mg of SEC. Results at 52 weeks are similar to those seen in the FUTURE 2 trial,⁴⁸ observed data were also available at 2 years (Table 31).

FIGURE 3 Long-term response rates in the FUTURE 2⁴⁸ trial SEC patients who were (a) ACR 20, (b) ACR 50 or (c) ACR 70 responders at 16 weeks. (Confidential information has been removed.)

FIGURE 4 Long-term response rates in the FUTURE 2⁴⁸ trial SEC patients who were (a) PASI 50, (b) PASI 75 or (c) PASI 90 responders at 16 weeks. (Confidential information has been removed.)

TABLE 31 Efficacy results for the FUTURE 1 trial⁴⁶ at 52 weeks and 104 weeks

Outcome	Time point, 150 mg of SEC	
	52 weeks	104 weeks ^a
ACR response, <i>n</i>	202	153
% ACR 20	60	74
% ACR 50	43	46
% ACR 70	24	28
PASI response ($\geq 3\%$ BSA), <i>n</i>	108	82
% PASI 75	77	83
% PASI 90	59	70
Dactylitis (LDI), <i>n</i>	104	–
% resolution of dactylitis	69	–
Enthesitis (LEI), <i>n</i>	126	–
% resolution of enthesitis	66	–
HAQ-DI, <i>n</i>	202	153
Mean (SE)	–0.41 (0.04)	–0.42 (–)
SF-36, <i>n</i>	202	152
Mean (SE)	5.89 (0.54)	5.94 (–)

–, not available; SE, standard error.

^a Observed data.

Radiographic progression of joint damage

In the FUTURE 1 trial,⁴⁶ at week 52 the observed population comprised 189 of the 202 patients randomised to 150 mg; this group had a mean Sharp/van der Heijde change from baseline score of 0.37 points.

At 104 weeks, 85% of patients treated with 150 mg of SEC had no radiographic progression – defined as a change in Sharp/van der Heijde score of ≤ 0.5 units – between baseline and week 104. This result was based on the observed population ($n = 166$).

Long-term efficacy of certolizumab pegol

The UCB Pharma submission reported long-term efficacy data for the RAPID-PsA trial⁴⁷ at time points up to around 4 years (216 weeks). By week 96, 20% of the 273 patients originally randomised to CZP had withdrawn from the study; 13.5% of the total cohort had withdrawn as a result of an AE or loss of efficacy. Non-responder imputations were used for dichotomous outcomes and LOCF was used for most of the continuous outcomes (except for radiographic progression).

At week 96 the ACR 20, 50 and 70 response rates were 64%, 50% and 35%, respectively,⁷⁴ and were (confidential information has been removed). PASI 75 and 90 response rates were 53% and 44% at week 96;⁷⁴ and (confidential information has been removed).

(Confidential information has been removed.) The improvement in HAQ-DI score from baseline was maintained (confidential information has been removed). Efficacy results for the overall population together with the biologic-naive and biologic-experienced subgroups are presented in *Table 32*.

FIGURE 5 Long-term response rates in the RAPID-PsA trial⁴⁷ CZP patients who were (a) ACR 20, (b) ACR 50 or (c) ACR 70 responders at 12 weeks. (Confidential information has been removed.)

FIGURE 6 Long-term response rates in the RAPID-PsA trial⁴⁷ CZP patients who were (a) PASI 50, (b) PASI 75 or (c) PASI 90 responders at 12 weeks. (Confidential information has been removed.)

Radiographic progression of joint damage

At week 96, the modified total Sharp score (mTSS) non-progressor rate (non-progression defined as mTSS change from baseline of ≤ 0.5 points) was 87%. This was based on observed data for the combined CZP groups: 218 of the 273 randomised. For patients randomised to CZP (combined group), the mean level of progression was 0.14 points [standard error (SE) 0.09 points], which is below the 0.5-point non-progression cut-off point. Subgroup analyses indicated that patients (randomised to CZP) with a baseline mTSS of > 3.5 points had a slightly greater radiographic progression at week 96 than patients with a baseline mTSS of ≤ 3.5 points [mean 0.24 points (SE 0.19 points) for a mTSS of > 3.5 vs. mean 0.07 points (SE 0.04 points) for a mTSS of ≤ 3.5 points].

Efficacy of other therapies

Methods and result details relating to the latest time point for which long-term data were available for GOL, ETN, ADA, INF, UST and APR are presented in *Table 33*.

The Golimumab – A Randomized Evaluation of Safety and Efficacy in Subjects with Psoriatic Arthritis Using a Human Anti-TNF Monoclonal Antibody (GO-REVEAL) study⁷⁵ reported results at 5 years using the originally randomised ITT groups. Across the groups the proportion of responders ranged from 63% to 70% for ACR 20, from 43% to 51% for ACR 50 and from 61% to 72% for PASI 75. Mean changes from baseline in the modified Sharp/van der Heijde score ranged from 0.1 to 0.3 units. Clinically important improvements in HAQ-DI scores (a decrease of ≥ 0.3 units) were seen for 52–58% of randomised patients. The use of concomitant MTX at baseline did not affect ACR 20 or PASI 75, but did appear to reduce radiographic progression when a comparison was made with patients who did not use concomitant MTX at baseline. Although some method details were not fully clear, it appeared that the data imputations used were not conservative enough. For example, it seems that LOCF was used for patients who stopped treatment as a result of an AE (so a patient responding well to treatment but who discontinued treatment early in the study as a result of an AE was counted as a responder at 5 years). In addition, it was unclear whether or not there were any stopping rules – such as how long non-responders were allowed to remain on treatment – which raises further uncertainties about the study's applicability to clinical practice.

The follow-up for the Mease *et al.* ETN trial⁵⁴ extended to 2 years and consisted of three phases: the 24-week initial randomised phase, an optional 24-week maintenance therapy phase (according to randomised assignment) and a 48-week open-label phase. Most results were given as percentages and it was not fully clear what the denominator was for some results. Several results were presented only as graphs. Very few data were provided on reasons for withdrawal from the study and HAQ-DI results were not reported. The ACR response results were similar to those seen in the GO-REVEAL trial (at 5 years), although the proportions of PASI 75 responders were markedly lower.

The ADEPT ADA trial⁷⁸ was extended to 2.75 years for radiographic progression outcomes and to 2 years for other outcomes. The ACR 50 results were similar to those seen for the ETN and GOL open-label studies. PASI 75 results were only presented in a graph; the response was around 60% ($n = 128$), which is similar to the GO-REVEAL trial's PASI 75 result at 5 years. Non-responders could increase their dose from 40 mg every other week (the recommended dose) to 40 mg weekly; this occurred in 54 (19%) patients. The use of LOCF imputation for missing data for the ACR, PASI and PsARC outcomes is different (potentially much less conservative) from the imputations used in the placebo-controlled phase, where non-responder imputations were used. This is likely to have inflated the response rates in the open-label phase. The results for HAQ-DI

TABLE 33 Open-label extension studies of other therapies for PsA

Original trial name with relevant OL reference(s); treatment and dose; and latest time point ^a	Number of patients	Analysis and imputation methods used by the study authors	Main results (ITT data extracted where possible)						Key withdrawal data
GO-REVEAL, ^{75,76} 50 or 100 mg of GOL (at investigator's discretion); 5 years	Of 405 randomised (placebo, <i>n</i> = 113; 50 mg of GOL, <i>n</i> = 146; 100 mg of GOL, <i>n</i> = 146), 279 (69%) were still on treatment at 5 years	It appeared that LOCF was used except for lack of efficacy discontinuations, where NRI was used and radiographic scores where observed data were used (<i>n</i> = 267)	At 5 years:						126/405 (31%) stopped treatment: 50 as a result of an AE and 23 because of lack of efficacy
			Trial arm	Modified SHS score^b (SD)	HAQ-DI (SD)	ACR 20	ACR 50	PASI 75^c	
			Placebo/50 mg of GOL	0.3 (3.8)	0.7 (0.6)	71/113 (63%)	49/113 (43%)	48/79 (61%)	
			50 mg of GOL	0.3 (4.2)	0.6 (0.6)	96/146 (66%)	70/146 (48%)	67/109 (61%)	
			100 mg of GOL	0.1 (2.7)	0.6 (0.6)	102/146 (70%)	74/146 (51%)	78/108 (72%)	
Mease <i>et al.</i> , 2004; ⁷⁷ 25 mg of ETN twice weekly; up to 2 years	Of 205 randomised (placebo, <i>n</i> = 104; ETN, <i>n</i> = 101), 169 took part in the extended study	Analyses were based on observed populations. All analyses were performed on the subset of patients who had radiographic data for the 2-year assessment (<i>n</i> = 141: placebo/ETN, <i>n</i> = 70; ETN, <i>n</i> = 71)	At up to 2 years:						44/205 (21%) stopped treatment: 14 in RCT phase, nine in maintenance phase and 21 in OL phase. Three patients withdrew from OL phase because of an AE
			Trial arm	mTSS^b	PsARC	ACR 20	ACR 50	PASI 75^c	
			Placebo/ETN	0.5	≈80%	63%	49%	≈38% of 102 patients	
			ETN	-0.38	≈80%	64%	44%		

continued

TABLE 33 Open-label extension studies of other therapies for PsA (continued)

Original trial name with relevant OL reference(s); treatment and dose; and latest time point ^a	Number of patients	Analysis and imputation methods used by the study authors	Main results (ITT data extracted where possible)	Key withdrawal data																								
ADEPT; ⁷⁸ 40 mg of ADA every other week, patients without $\geq 20\%$ improvement in TJC and SJC after 12 weeks of OL phase could increase to 40 mg per week; 2 years, 2.75 years for radiographic data	Of 313 randomised (placebo, $n = 162$; ADA, $n = 151$), 289 completed 24-week RCT, of which 285 chose to enrol in the extended study	Most analyses were based on a modified ITT population (any patients who had received a dose in either study phase, $n = 298$) with LOCF imputation	<p>At 2 years (2.75 years for mTSS):</p> <table border="1"> <thead> <tr> <th>Trial arm</th> <th>mTSS^b (SD)</th> <th>HAQ-DI^b (SD)</th> <th>PsARC</th> <th>ACR 20</th> <th>ACR 50</th> </tr> </thead> <tbody> <tr> <td>Placebo/ADA</td> <td>0.9 (6.4), $n = 128$</td> <td rowspan="2">-0.3 (0.5)</td> <td rowspan="2">188/298 (63%)</td> <td rowspan="2">161/298 (54%)</td> <td rowspan="2">127/298 (43%)</td> </tr> <tr> <td>ADA</td> <td>0.5 (4.2), $n = 115$</td> </tr> </tbody> </table>	Trial arm	mTSS ^b (SD)	HAQ-DI ^b (SD)	PsARC	ACR 20	ACR 50	Placebo/ADA	0.9 (6.4), $n = 128$	-0.3 (0.5)	188/298 (63%)	161/298 (54%)	127/298 (43%)	ADA	0.5 (4.2), $n = 115$	44/285 stopped treatment in the OL phase: 10 as a result of AEs; and 12 because of lack of efficacy										
Trial arm	mTSS ^b (SD)	HAQ-DI ^b (SD)	PsARC	ACR 20	ACR 50																							
Placebo/ADA	0.9 (6.4), $n = 128$	-0.3 (0.5)	188/298 (63%)	161/298 (54%)	127/298 (43%)																							
ADA	0.5 (4.2), $n = 115$																											
IMPACT; ⁷⁹ 5 mg/kg of INF; up to 2 years	104 patients took part in the RCT. 78 out of the 87 patients who completed the first year continued to enrol in the extended 2-year study	Analyses were based on the 78 patients who entered year 2 (analysed as one group)	<p>At 98 weeks:</p> <table border="1"> <thead> <tr> <th>Trial arm</th> <th>Modified SHS score^b (SD)</th> <th>PsARC</th> <th>ACR 20</th> <th>ACR 50</th> <th>PASI 75^d</th> </tr> </thead> <tbody> <tr> <td>Placebo/INF</td> <td>1.2 (8.7), $n = 43$</td> <td>52/104 (50%)</td> <td>48/104 (46%)</td> <td>35/104 (34%)</td> <td>64% ($n = \text{unclear}$)</td> </tr> </tbody> </table>	Trial arm	Modified SHS score ^b (SD)	PsARC	ACR 20	ACR 50	PASI 75 ^d	Placebo/INF	1.2 (8.7), $n = 43$	52/104 (50%)	48/104 (46%)	35/104 (34%)	64% ($n = \text{unclear}$)	26 patients withdrew over the 2 years: 12 as a result of AEs; and three because of lack of efficacy												
Trial arm	Modified SHS score ^b (SD)	PsARC	ACR 20	ACR 50	PASI 75 ^d																							
Placebo/INF	1.2 (8.7), $n = 43$	52/104 (50%)	48/104 (46%)	35/104 (34%)	64% ($n = \text{unclear}$)																							
PSUMMIT 1; ^{80,81} 45 or 90 mg of UST every 12 weeks; 100 weeks	615 randomised (placebo, $n = 206$; 45 mg of UST, $n = 205$; 90 mg of UST, $n = 204$) and 598 received at least one dose of UST	Analyses were based on ITT populations using LOCF and NRI for most analyses. Missing radiographic data between week 52 and week 100 were imputed using linear extrapolation (if data were available for two time points), otherwise the median change in the total scores from all patients within the MTX stratification was used	<p>At 100 weeks:</p> <table border="1"> <thead> <tr> <th>Trial arm</th> <th>Total SHS score^b (SD)</th> <th>HAQ-DI (SD)^b</th> <th>ACR 20</th> <th>ACR 50</th> <th>PASI 75^c</th> </tr> </thead> <tbody> <tr> <td>Placebo/45 mg of UST</td> <td>2.3 (12.6), $n = 189$</td> <td>-0.36 (0.51)</td> <td>111/206 (54%)</td> <td>66/206 (32%)</td> <td>78/136 (57%)</td> </tr> <tr> <td>45 mg of UST</td> <td>1.0 (3.8)</td> <td>-0.36 (0.56)</td> <td>101/205 (49%)</td> <td>69/205 (34%)</td> <td>87/145 (60%)</td> </tr> <tr> <td>90 mg of UST</td> <td>1.2 (5.1)</td> <td>-0.45 (0.6)</td> <td>112/204 (55%)</td> <td>81/204 (40%)</td> <td>92/149 (62%)</td> </tr> </tbody> </table>	Trial arm	Total SHS score ^b (SD)	HAQ-DI (SD) ^b	ACR 20	ACR 50	PASI 75 ^c	Placebo/45 mg of UST	2.3 (12.6), $n = 189$	-0.36 (0.51)	111/206 (54%)	66/206 (32%)	78/136 (57%)	45 mg of UST	1.0 (3.8)	-0.36 (0.56)	101/205 (49%)	69/205 (34%)	87/145 (60%)	90 mg of UST	1.2 (5.1)	-0.45 (0.6)	112/204 (55%)	81/204 (40%)	92/149 (62%)	By week 88 (last dose), 125 patients (20.3%) had discontinued treatment: 31 as a result of an AE; and 40 because of lack of efficacy
Trial arm	Total SHS score ^b (SD)	HAQ-DI (SD) ^b	ACR 20	ACR 50	PASI 75 ^c																							
Placebo/45 mg of UST	2.3 (12.6), $n = 189$	-0.36 (0.51)	111/206 (54%)	66/206 (32%)	78/136 (57%)																							
45 mg of UST	1.0 (3.8)	-0.36 (0.56)	101/205 (49%)	69/205 (34%)	87/145 (60%)																							
90 mg of UST	1.2 (5.1)	-0.45 (0.6)	112/204 (55%)	81/204 (40%)	92/149 (62%)																							

Original trial name with relevant OL reference(s); treatment and dose; and latest time point ^a	Number of patients	Analysis and imputation methods used by the study authors	Main results (ITT data extracted where possible)			Key withdrawal data
PALACE 1, ^{61,82} 30 mg of APR twice daily, oral tablets; 2 years	504 patients were randomised (placebo, <i>n</i> = 168; 20 mg of APR, <i>n</i> = 168; 30 mg of APR, <i>n</i> = 168). 101 patients received 30 mg of APR continuously for 2 years (observed population)	Analyses were based on the observed population for the extension period	At 104 weeks:			8.2% discontinued treatment as a result of AEs between weeks 0 and 52 and 1.5% between weeks 53 and 104
			Trial arm	HAQ-DI^b	ACR 20	
			30 mg of APR	-0.43, <i>n</i> = 101	67/168 (40%)	21/71 (29.6%)

GO-REVEAL, Golimumab – A Randomized Evaluation of Safety and Efficacy in Subjects with Psoriatic Arthritis Using a Human Anti-TNF Monoclonal Antibody; NRI, non-responder imputation; SHS, Sharp/van der Heijde; OL, open label.

a With published results.
b Change from RCT baseline.
c In patients with a $\geq 3\%$ BSA involvement.
d Patients with a baseline PASI score of ≥ 2.5 units.

remained very stable throughout the 2 years. These open-label HAQ-DI results are similar to the placebo-controlled, fully blinded 24-week phase in which HAQ-DI scores remained the same between week 12 and week 24 in both the ADA and the placebo groups.

The UST PSUMMIT 1 trial^{80,81} was extended to 108 weeks, with efficacy data evaluated at 100 weeks. The change from baseline Sharp/van der Heijde radiographic progression scores varied across the three treatment groups. The change from baseline HAQ-DI results ranged between -0.36 and -0.45 units, similar to the ADA study results.

For INF, IMPACT⁷⁹ was extended to 98 weeks. The data for all patients were summarised as one group (as for the ADA open-label study). At 98 weeks, 46% and 34% were ACR 20 and ACR 50 responders, respectively. The mean change in the modified Sharp/van der Heijde score was 1.2 units, which is similar to the results in the UST PSUMMIT 1.^{80,81} However, the result was based on 41% of the initial 104 patients. The authors also acknowledged that the 2-year radiographic progression result may have reflected non-linear progression of damage, with more damage occurring in earlier disease stages. Mean changes from baseline were not available for the HAQ-DI.

For APR, the PALACE 1 trial^{61,82} was extended to 2 years. There were no separate results for the patients at 104 weeks who were in the placebo group at the beginning of the trial. In the 30-mg group, at 2 years 40% of patients were ACR 20 responders and 30% were PASI 75 responders. The HAQ-DI result may be an overestimate, as it was based on data from patients remaining in the study at 2 years (i.e. observed data). No data were reported on any radiographic progression outcomes.

Summary

The uncontrolled nature of open-label extension studies means that it is often very difficult to determine the magnitude of effects that can be ascribed only to active treatment; results should generally be viewed with much more caution than the results of the earlier randomised controlled study phases. Furthermore, it is not straightforward to compare long-term results across different treatments because of the variation in outcomes and time points reported. There is also variation in the methodological approaches used for analyses and for imputing missing data. Additionally, most studies did not report whether or not there were any treatment stopping rules, and it is likely that the decisions made regarding continuation of treatment were not reflective of those used in the NHS, limiting the applicability of many of these results. For example, in the open-label ADEPT⁷⁸ non-responders after 12 weeks had their dose doubled – the opposite of what would be expected in practice (when treatment with ADA would have been stopped).

With these caveats in mind, the results relating specifically to those patients who were responders at 12 or 16 weeks appear to be the most clinically relevant and useful (for the dichotomous outcomes), although such data were available only for CZP and SEC (confidential information has been removed).

The available data on disease progression based on radiographic assessments of joint damage indicate that, after 2 years of treatment, CZP effectively reduces disease progression, with results being similar to those observed in the open-label studies of the other anti-TNFs. For SEC, fewer result details were available at 2 years, although the results also indicated effective reduction in radiographic disease progression.

For long-term HAQ-DI results, missing data were often imputed using LOCF, which is not the most conservative of approaches for this outcome. Notwithstanding this, the results suggest that HAQ-DI gains remain stable in PsA patients treated with biologics. The 2-year open-label HAQ-DI results from ADEPT were similar to the placebo-controlled, fully blinded 24-week phase in which HAQ-DI scores remained the same between week 12 and week 24 in both the ADA and the placebo groups. This stability of HAQ-DI scores over time was also seen in the open-label studies of CZP (data up to 4 years) and SEC (data to 1 year).

Withdrawal rates as a result of AEs or loss of efficacy were low in both the FUTURE 2⁴⁸ (5% at 52 weeks) and RAPID-PsA⁴⁷ trials (around 10% at 52 weeks).

Review of anti-tumour necrosis factor patient registry studies

Drug survival and anti-tumour necrosis factor switching

The database of references, which resulted from the searches for RCTs, was also screened to identify registries containing PsA patients and the corresponding publication output. The results of this search were supplemented by separate searches for the output of the identified patient registries reporting information on their PsA cohorts. A library of 165 potentially relevant studies was assembled and screened fully, from which there were 12 studies^{83–93} reporting data on drug survival and switching of anti-TNF treatments. The populations of all 12 studies were defined as having clinically diagnosed PsA. These studies are presented in *Table 34*.

These studies were all retrospective analyses of prospective patient registers from primarily European countries (10 studies^{83–86,88,90–94}), along with one Australian study⁸⁹ and another from the USA.⁸⁷ The majority of patients in each of the registries had been treated with ETN, ADA or INF; two of the studies named other anti-TNF- α treatments, GOL and CZP, but neither had sufficient data to provide individual drug survival information for these.

Drug survival was reported in a number of ways: as the number of patients remaining on treatment at a given time point; as the proportion of patients remaining on treatment at each time point; or as the median duration patients remained on treatment.

Treatment withdrawal rates in patients who had switched anti-TNFs were reported in three studies.^{83,94,95} The Danish Database for Biological Therapies (DANBIO) registry⁹⁴ reported up to three sequential anti-TNFs, with 548 patients who had switched treatment once, and 189 patients who had switched treatment twice. The UK's British Society for Rheumatology Biologics Register (BSRBR)⁸³ also reported drug survival rates for its population of 178 one-time switchers over 2 years, whereas the 95 switchers in the Norwegian Antirheumatic Drug Register (NOR-DMARD)⁹⁵ were followed for 3 years.

For the first course of anti-TNF treatment, the proportion of patients remaining on treatment ranged from 60% to 88% at 1 year, from 57% to 81% at 2 years and from 55% to 73% at 3 years. Three studies reported first anti-TNF drug survival rates for ≥ 5 years: (1) the BSRBR study,⁸⁴ in which 47% of patients were still on the initial anti-TNF treatment at 5 years; (2) the Southern Sweden Antirheumatic Therapy Group study,⁸⁵ which reported 5-year survival of around 40%; and (3) the study conducted by another Swedish registry, Antirheumatic Therapies In Sweden,⁸⁶ which reported 6-year first anti-TNF drug survival of 37% and 8-year survival of 32%.

The median first anti-TNF survival time across all anti-TNFs was reported as 2.5–2.9 years.^{87,88} One study reported this separately by anti-TNF: ETN, 2.62 years; ADA, 4.21 years; and INF, 1.92 years.⁸⁹

Drug survival was consistently lower in patients who switched anti-TNF than in those who did not. The DANBIO⁹⁴ register had the largest population of switchers; the median drug survival for a first anti-TNF was 2.2 (95% CI 1.9 to 2.5) years, whereas median drug survival for a second anti-TNF was 1.3 years (95% CI 1.0 to 1.6 years) ($n = 548$), and was 1.1 years (95% CI 0.7 to 1.5 years) ($n = 189$) for those on a third anti-TNF.

There is some evidence suggesting that drug survival varies between types of anti-TNF; both the Australian Rheumatology Association Database register and the BSRBR study report rates for individual therapies, and both indicate that ADA and ETN are associated with considerably higher survival rates than INF. Two studies reported the impact of concomitant MTX or other DMARDs.^{85,87} One reported a small increase in drug survival at 1 year (from 65% to 80%), but this effect was diminished at 3 years (from 55% to 60%) and 5 years (from 37.5% to 40%).⁸⁵ The other study reported that median drug survival time for anti-TNF- α monotherapy was 30.8 months, compared with 32.4 months for combination therapy (anti-TNF + MTX or DMARD).⁸⁷

TABLE 34 Registry studies reporting data on anti-TNF drug survival and switching

Publication (first author and year of publication)	Registry name	Number of patients (length of follow-up)	Population	Anti-TNFs included	Drug survival data	Reason for discontinuation																									
Carmona <i>et al.</i> , 2006 ⁹¹	BIOBADASER	570 (5 years; 963.6 patient-years)	PsA	ETN, ADA and INF	As a proportion, anti-TNF- α survival was 0.88 (95% CI 0.84 to 0.90) at 1 year; 0.81 (95% CI 0.77 to 0.84) at 2 years; and 0.73 (95% CI 0.67 to 0.78) at 3 years	Not split by diagnosis																									
Chen <i>et al.</i> , 2014 ⁸⁹	ARAD	286 (10 years)	PsA	ETN, ADA and INF	Median survival time: ETN ($n = 110$), 2.62 years (95% CI 1.10 to 4.45 years); ADA ($n = 144$), 4.21 years; INF ($n = 23$), 1.92 years (95% CI 0.96 to 2.88 years)	<table border="1"> <thead> <tr> <th>Trial arm</th> <th>Any (%)</th> <th>LoE (%)</th> <th>AE (%)</th> </tr> </thead> <tbody> <tr> <td>ETN</td> <td>41</td> <td>20.5</td> <td>8</td> </tr> <tr> <td>ADA</td> <td>35</td> <td>17.7</td> <td>11.5</td> </tr> <tr> <td>INF</td> <td>70</td> <td>29.6</td> <td>11.1</td> </tr> </tbody> </table>	Trial arm	Any (%)	LoE (%)	AE (%)	ETN	41	20.5	8	ADA	35	17.7	11.5	INF	70	29.6	11.1									
Trial arm	Any (%)	LoE (%)	AE (%)																												
ETN	41	20.5	8																												
ADA	35	17.7	11.5																												
INF	70	29.6	11.1																												
Fagerli <i>et al.</i> , 2014 ⁹⁰	NOR-DMARD	439 (3 years; 547 patient-years)	PsA	ETN, ADA, INF, GOL and CZP	<p>The proportion of non-switchers ($n = 344$) remaining on their first anti-TNF-α after 1 year was 0.83; at 3 years it was 0.71. The 1-year survival for all patients on their first anti-TNF-α was 0.74. The proportion of those patients who switched to a different anti-TNF-α ($n = 95$) remaining on second treatment for 1 year was 0.56; the 3-year survival was 0.36</p> <p>Response rate at 3 months:</p> <table border="1"> <thead> <tr> <th rowspan="2">Response</th> <th colspan="2">Non-switchers (%)</th> <th colspan="2">Switchers (%)</th> <th rowspan="2">p-value switchers first vs. second</th> </tr> <tr> <th>First</th> <th>Second</th> <th>First</th> <th>Second</th> </tr> </thead> <tbody> <tr> <td>ACR 20</td> <td>64.4</td> <td>45.8</td> <td>22.5</td> <td>NS</td> </tr> <tr> <td>ACR 50</td> <td>40.0</td> <td>30.5</td> <td>12.5</td> <td>NS</td> </tr> <tr> <td>ACR 70</td> <td>32.2</td> <td>23.7</td> <td></td> <td>0.04</td> </tr> </tbody> </table>	Response	Non-switchers (%)		Switchers (%)		p -value switchers first vs. second	First	Second	First	Second	ACR 20	64.4	45.8	22.5	NS	ACR 50	40.0	30.5	12.5	NS	ACR 70	32.2	23.7		0.04	NR
Response	Non-switchers (%)		Switchers (%)		p -value switchers first vs. second																										
	First	Second	First	Second																											
ACR 20	64.4	45.8	22.5	NS																											
ACR 50	40.0	30.5	12.5	NS																											
ACR 70	32.2	23.7		0.04																											
Fagerli <i>et al.</i> , 2014 ⁸⁴	BSRBR	666 (5 years)	PsA	ETN, ADA and INF	After 5 years, 46.8% of patients were still on an initial anti-TNF- α treatment	<table border="1"> <thead> <tr> <th>LoE</th> <th>AE</th> <th>Other/missing</th> </tr> </thead> <tbody> <tr> <td>35.3%</td> <td>28.8%</td> <td>35.9%</td> </tr> </tbody> </table>	LoE	AE	Other/missing	35.3%	28.8%	35.9%																			
LoE	AE	Other/missing																													
35.3%	28.8%	35.9%																													

Publication (first author and year of publication)	Registry name	Number of patients (length of follow-up)	Population	Anti-TNFs included	Drug survival data	Reason for discontinuation			
						LoE	AE		
Glintborg <i>et al.</i> , 2011 ⁸⁸	DANBIO	764 (9 years; 2135 patient-years)	PsA	ETN, ADA and INF	The proportion of the cohort remaining on the same anti-TNF- α after 1 year was 0.70, and 0.57 at 2 years. The median drug survival was 2.9 years	23%	12%		
Glintborg <i>et al.</i> , 2013 ⁹⁴	DANBIO	1422; 548 switchers (10 years)	PsA	ETN, ADA, INF, GOL, CZP and other non-anti-TNF biologics	The median survival time for patients on their first course of treatment was 2.2 years (95% CI 1.9 to 2.5 years). Second course ($n = 548$), drug survival was 1.3 years (95% CI 1.0 to 1.6 years). Third course ($n = 189$), median survival was 1.1 years (95% CI 0.7 to 1.5 years). The median drug survival of first anti-TNF- α among switchers was 0.7 years (95% CI 0.6 to 0.8 years)	Course of treatment			
						First	6	26	16
						Second	55	28	15
						Third	55	33	14
Glintborg <i>et al.</i> , 2014 ⁹²	DANBIO and ICEBIO	462 (< 10 years; 1185 patient-years)	PsA (patients on INF)	INF (variable dose)	The 1-year drug survival for INF patients was 59.5% across both registers. Dose did not affect drug survival or treatment response	25%	29%		
Iannone <i>et al.</i> , 2015 ⁹³	GISEA	328 (2 years)	PsA	ETN, ADA and INF	The 2-year overall drug survival was 0.67	NR			
Kristensen <i>et al.</i> , 2008 ⁸⁵	SSATG	261 (7 years)	PsA	ETN, ADA and INF	Kaplan–Meier graph estimates of drug survival were:	Risk of AE lower with concomitant MTX			
						Treatment (proportion of patients remaining on treatment)			
						Time point	Anti-TNF- α only	Anti-TNF- α + MTX	
						1 year	0.65	0.8	
						3 years	0.55	0.6	
						5 years	0.375	0.4	

continued

TABLE 34 Registry studies reporting data on anti-TNF drug survival and switching (*continued*)

Publication (first author and year of publication)	Registry name	Number of patients (length of follow-up)	Population	Anti-TNFs included	Drug survival data	Reason for discontinuation				
Mease <i>et al.</i> , 2015 ⁸⁷	CORRONA	497 (7 years)	PsA	ETN, ADA and INF	The median survival time of patients being treated with anti-TNF- α monotherapy was 30.8 months, and for those being treated with combination therapy (anti-TNF + MTX or DMARD) was 32.4 months	NR				
Saad <i>et al.</i> , 2009 ⁸³	BSRBR	566 (3 years)	PsA	ETN, ADA and INF	Time point (proportion of patients remaining on treatment)		LoE	AE		
					Treatment	1 year	2 years	3 years	9.5%	10%
					Total first anti-TNF- α	0.82	0.70	0.59		
					ETN (<i>n</i> = 316)	0.86	0.79	0.65		
					ADA (<i>n</i> = 88)	0.91	0.70	0.66		
					INF (<i>n</i> = 162)	0.71	0.52	0.43		
Switchers (<i>n</i> = 178)	0.74	0.66	–							
Simard <i>et al.</i> , 2011 ⁸⁶	ARTIS	1417 (9 years)	PsA	NR	The Kaplan–Meier graph estimates of survival following treatment with a first anti-TNF- α were 0.75 at 1 year, 0.63 at 2 years, 0.5 at 4 years, 0.37 at 6 years and 0.32 at 8 years	LoE	AE			
						9.4%	8.2%			

ARAD, Australian Rheumatology Association Database; ARTIS, Antirheumatic Therapies In Sweden; BIOBADASER, Spanish Society of Rheumatology Registry for AEs of Biological Therapies in Rheumatic Diseases; BSRBR, British Society for Rheumatology Biologics Register; CORRONA, Consortium of Rheumatology Researchers of North America; GISEA, Italian Group for the Study of Early Arthritis; ICEBIO, Icelandic Database for Biological Therapies; LoE, lack of efficacy; NOR-DMARD, Norwegian Antirheumatic Drug Register; NR, not reported; NS, not significant; SSATG, Southern Sweden Antirheumatic Therapy Group.

Reasons for discontinuation of treatment varied widely between studies, due in part to the inconsistency of observation period duration. Across all registries, between 20% and 35% of patients withdrew from treatment because of a lack of efficacy and, generally, a smaller proportion withdrew as a result of AEs. The frequency of occurrence of AEs was linked to the types of anti-TNF used and whether or not patients received concomitant MTX, which was generally found to reduce AE frequency when MTX subgroups were analysed.

Only one study reported an analysis of response rates; this was based on the 3-month response rates from the NOR-DMARD ($n = 439$).⁹⁰ A retrospective comparison of response rates in switchers and non-switchers found that switchers had a lower response rate to the first anti-TNF: for ACR 50, 30.5% compared with 40%. In addition, the response to the second anti-TNF was lower than to the first: 22.5% (compared with 30.5%, although this difference was not statistically significant). The same pattern was seen for ACR 20 and 70 and, for the latter, the difference reached statistical significance.

In summary, across all relevant studies, those patients who switched treatment had a shorter median drug survival time, also showing a continuously smaller proportion of patients remaining on each subsequent treatment option. This may reflect a lack of improvement in treatment response after switching biologic; however, there are limited direct data on the effect of sequential treatments on relevant outcome measures. The proportion of patients withdrawing from treatment because of a lack of effect also seems to increase with the number of times a patient switches anti-TNF therapy. The registry data suggest that, although patients can benefit from a second (or further) anti-TNF, the expected benefit from anti-TNFs diminishes after switching, with a reduced chance of response and reduced drug survival.

Effect of anti-tumour necrosis factors on radiographic progression and Health Assessment Questionnaire-Disability Index score

Four patient registry studies that provided longitudinal data on the effect of anti-TNFs on HAQ-DI scores were identified, one of which also reported on radiographic progression. The results of these are presented in *Table 35*.

TABLE 35 Registries reporting the effects of anti-TNF treatment on HAQ-DI and radiographic progression

Publication (first author and year of publication)	Study description	Findings														
Eder <i>et al.</i> , 2014 ⁹⁶	Up to 4 years of radiographic progression in 65 patients treated with anti-TNF- α compared with 70 patients treated with MTX alone in the University of Toronto cohort. Only patients with bone erosions at baseline were included	At the first assessment after baseline (1–2 years): MTX group, 68% developed a new erosion in at least one joint, 80% of patients exhibited radiographic progression; anti-TNF- α group, 56.4% had a new eroded joint and 58.9% had radiographic progression At the 2- to 4-year assessment: MTX group, 84% developed a new erosion, 88% had radiographic progression; anti-TNF- α group, 75% had a new eroded joint and 61% with radiographic progression														
		<table border="1"> <thead> <tr> <th rowspan="2">Time point</th> <th colspan="2">Treatment, HAQ-DI score (units)</th> </tr> <tr> <th>Anti-TNF-α</th> <th>MTX</th> </tr> </thead> <tbody> <tr> <td>Baseline</td> <td>0.9 \pm 0.7</td> <td>0.7 \pm 0.7</td> </tr> <tr> <td>1–2 years</td> <td>0.6 \pm 0.6</td> <td>0.6 \pm 0.6</td> </tr> <tr> <td>3–4 years</td> <td>0.6 \pm 0.6</td> <td>0.7 \pm 0.7</td> </tr> </tbody> </table>	Time point	Treatment, HAQ-DI score (units)		Anti-TNF- α	MTX	Baseline	0.9 \pm 0.7	0.7 \pm 0.7	1–2 years	0.6 \pm 0.6	0.6 \pm 0.6	3–4 years	0.6 \pm 0.6	0.7 \pm 0.7
Time point	Treatment, HAQ-DI score (units)															
	Anti-TNF- α	MTX														
Baseline	0.9 \pm 0.7	0.7 \pm 0.7														
1–2 years	0.6 \pm 0.6	0.6 \pm 0.6														
3–4 years	0.6 \pm 0.6	0.7 \pm 0.7														
		continued														

TABLE 35 Registries reporting the effects of anti-TNF treatment on HAQ-DI and radiographic progression (*continued*)

Publication (first author and year of publication)	Study description	Findings																														
Fagerli <i>et al.</i> , 2014 ⁹⁰	Analysis of the effect of MTX co-medication in 440 PsA patients in the NOR-DMARD	The study found no difference in treatment response between those on anti-TNF- α monotherapy and those with concomitant MTX. Mean cohort HAQ-DI was recorded as 0.7 units at baseline, 0.39 units at 3 months and 0.38 units at 6 months. Mean change from baseline at 3 months = 0.31 units																														
Glintborg <i>et al.</i> , 2011 ⁸⁸	Analysis of long-term anti-TNF treatment response data from the DANBIO register ($n = 658$). Measured by HAQ-DI over 5 years	<table border="1"> <thead> <tr> <th>Time point</th> <th>HAQ-DI score (units)</th> <th>Number of patients</th> </tr> </thead> <tbody> <tr> <td>Baseline</td> <td>1.0</td> <td>658</td> </tr> <tr> <td>2 weeks</td> <td>0.75</td> <td>275</td> </tr> <tr> <td>6 weeks</td> <td>0.6</td> <td>366</td> </tr> <tr> <td>6 months</td> <td>0.6</td> <td>406</td> </tr> <tr> <td>1 year</td> <td>0.4</td> <td>318</td> </tr> <tr> <td>2 years</td> <td>0.4</td> <td>229</td> </tr> <tr> <td>3 years</td> <td>0.3</td> <td>127</td> </tr> <tr> <td>4 years</td> <td>0.3</td> <td>104</td> </tr> <tr> <td>5 years</td> <td>0.5</td> <td>45</td> </tr> </tbody> </table>	Time point	HAQ-DI score (units)	Number of patients	Baseline	1.0	658	2 weeks	0.75	275	6 weeks	0.6	366	6 months	0.6	406	1 year	0.4	318	2 years	0.4	229	3 years	0.3	127	4 years	0.3	104	5 years	0.5	45
		Time point	HAQ-DI score (units)	Number of patients																												
		Baseline	1.0	658																												
		2 weeks	0.75	275																												
		6 weeks	0.6	366																												
		6 months	0.6	406																												
		1 year	0.4	318																												
		2 years	0.4	229																												
3 years	0.3	127																														
4 years	0.3	104																														
5 years	0.5	45																														
Glintborg <i>et al.</i> , 2013 ⁹⁴	DANBIO ($n = 1422$; 548 switchers) (10 years). PsA (ETN, ADA, INF, GOL, CZP and other non-anti-TNF biologics)	<table border="1"> <thead> <tr> <th rowspan="2">Anti-TNF course of treatment</th> <th colspan="3">Time point, median HAQ-DI score (units) (IQR)</th> </tr> <tr> <th>0 months</th> <th>3 months</th> <th>6 months</th> </tr> </thead> <tbody> <tr> <td>First ($n = 1422$)</td> <td>1 (0.5–1.5)</td> <td>0.6 (0.1–1.1)</td> <td>0.6 (0.1–1.0)</td> </tr> <tr> <td>Second ($n = 548$)</td> <td>1.1 (0.6–1.6)</td> <td>0.9 (0.4–1.5)</td> <td>0.9 (0.4–1.4)</td> </tr> <tr> <td>Third ($n = 189$)</td> <td>1.4 (0.9–2.9)</td> <td>1.0 (0.6–1.5)</td> <td>1.3 (0.5–1.6)</td> </tr> </tbody> </table>	Anti-TNF course of treatment	Time point, median HAQ-DI score (units) (IQR)			0 months	3 months	6 months	First ($n = 1422$)	1 (0.5–1.5)	0.6 (0.1–1.1)	0.6 (0.1–1.0)	Second ($n = 548$)	1.1 (0.6–1.6)	0.9 (0.4–1.5)	0.9 (0.4–1.4)	Third ($n = 189$)	1.4 (0.9–2.9)	1.0 (0.6–1.5)	1.3 (0.5–1.6)											
		Anti-TNF course of treatment		Time point, median HAQ-DI score (units) (IQR)																												
			0 months	3 months	6 months																											
		First ($n = 1422$)	1 (0.5–1.5)	0.6 (0.1–1.1)	0.6 (0.1–1.0)																											
Second ($n = 548$)	1.1 (0.6–1.6)	0.9 (0.4–1.5)	0.9 (0.4–1.4)																													
Third ($n = 189$)	1.4 (0.9–2.9)	1.0 (0.6–1.5)	1.3 (0.5–1.6)																													
Saad <i>et al.</i> , 2010 ⁹⁷	Evaluation of the effect of anti-TNF therapies on quality of life and functional status in the BSRBR cohort of 596 PsA patients	<table border="1"> <thead> <tr> <th>Time point</th> <th>Median HAQ-DI score (units) (IQR)</th> <th>Number of patients</th> </tr> </thead> <tbody> <tr> <td>Baseline</td> <td>1.88 (1.38–2.25)</td> <td>562</td> </tr> <tr> <td>6 months</td> <td>1.25 (0.63–1.88)</td> <td>424</td> </tr> <tr> <td>12 months</td> <td>1.38 (0.63–2.00)</td> <td>382</td> </tr> <tr> <td>18 months</td> <td>1.38 (0.63–2.00)</td> <td>344</td> </tr> </tbody> </table>	Time point	Median HAQ-DI score (units) (IQR)	Number of patients	Baseline	1.88 (1.38–2.25)	562	6 months	1.25 (0.63–1.88)	424	12 months	1.38 (0.63–2.00)	382	18 months	1.38 (0.63–2.00)	344															
		Time point	Median HAQ-DI score (units) (IQR)	Number of patients																												
		Baseline	1.88 (1.38–2.25)	562																												
		6 months	1.25 (0.63–1.88)	424																												
12 months	1.38 (0.63–2.00)	382																														
18 months	1.38 (0.63–2.00)	344																														

IQR, interquartile range.

One study⁹⁶ reported on radiographic progression; a comparison of anti-TNF and MTX found an inhibitory effect of anti-TNF on radiographic progression over 4 years of observation. Radiographic progression was measured in terms of newly forming erosions and change in a modified Steinbrocker score; radiographic progression according to both measures was significantly more prevalent in the MTX group at each follow-up assessment.

Four studies^{88,90,96,97} reported on disease progression in terms of HAQ-DI score for between 6 months and 5 years at varying frequency. Eder *et al.*⁹⁶ compared HAQ-DI score change in 70 patients treated with MTX and 65 patients on an anti-TNF, finding no significant difference in HAQ-DI score between the groups at the two assessments at up to 4 years from baseline. The HAQ-DI score was measured in 658 patients receiving anti-TNFs for 5 years in the largest cohort⁸⁸ (the DANBIO register). The baseline mean HAQ-DI score was 1.0 unit, decreasing to 0.3 units by 3 years, and increasing to 0.5 units at 5 years. This suggests sustained long-term improvement of functional status during anti-TNF treatment, although the number of patients at each time point after the 6-month assessment decreased significantly. Therefore, the trend of improving HAQ-DI scores observed in this study is potentially due to a higher attrition of patients, with greater functional impairment skewing the data. The third study on HAQ-DI change is from the NOR-DMARD,⁹⁰ and showed an improvement in HAQ-DI score from 0.7 units at baseline to 0.39 units at 3 months, and 0.38 units at 6 months. This study also found no significant difference in HAQ-DI response in patients receiving MTX compared with those on biologics alone. The BSRBR⁹⁷ study followed an initial cohort of 562 patients on biologics for 18 months. This group of patients appears to have had more advanced disease (12 years since onset) and poorer functional status than those in the other included studies, with a median baseline HAQ-DI score of 1.88 units (95% CI 1.38 to 2.25 units). There is a 0.63-unit decrease in HAQ-DI score between baseline and 6 months of treatment, representing what the authors describe as a clinically important improvement. The median HAQ-DI score then increases to and remains at 1.38 units (95% CI 0.63 to 2.00 units) at both the 12- and 18-month assessments. Disease duration at the time of treatment initiation in the BSRBR study was more than twice that in two of the aforementioned studies on the HAQ-DI, showing that significant improvements in functional status are achievable using anti-TNF therapy in advanced cases of PsA.

Treatment with anti-TNFs appears to yield significant improvement in radiographic progression and long-term HAQ-DI score change in patient registry studies, although it is not clear to what extent the treatment is responsible for the reduction in mean cohort HAQ-DI score over time. Estimation of HAQ-DI score change using measures more robust to attrition bias or profiling those lost to follow-up based on disease severity would have given a truer representation of HAQ-DI score change in these cohorts. The paucity of radiographic data in these registry studies is perhaps surprising given the significance of radiographic damage as a measure of disease progression and treatment effects. This lack of published data may be because few of these registries were set up to record PsA-specific outcomes, and there has historically been little consensus on a method for objectively taking and scoring joint radiographs in this disease. It may be that HAQ-DI was usually preferred as an acceptable and standardised proxy for assessing bone erosion and, as a patient-reported outcome measure, can be cheaply and routinely recorded without the need for specialist assessment.

Review of the natural history of psoriatic arthritis: registry and cohort study data

A total of four publications^{33,98-100} analysing patterns of natural disease progression in registries or long-term cohort data were found and are shown in *Table 36*. These were reviewed in order to gain an understanding of the manner in which disease progresses in patients who do not receive anti-TNF therapy, despite being eligible for treatment. Owing to the now ubiquitous nature of anti-TNFs and only recent recognition of PsA as a separate and distinct form of arthritis, information on the long-term uncontrolled progression of the disease is scarce. Two of the studies^{33,100} found in the literature search were different analyses of the same data set derived from the Norfolk Arthritis Register (NOAR): one was a 2-year prospective cohort study⁹⁹ and the other a retrospective analysis of a Canadian single-site patient registry.⁹⁸

The studies explore changes in functional disability in terms of HAQ-DI score and bone erosion as measures of disease activity and progression over time. There is a great deal of variability between the three cohorts under observation in terms of both baseline characteristics and patterns of disease. It should be noted that disease classification of the NOAR cohort^{99,100} was performed retrospectively and both

TABLE 36 Registries reporting on natural history of PsA

Publication (first author and year of publication)	Study description	Population characteristics	Findings
Husted <i>et al.</i> , 2005 ⁹⁸	Analysed long-term change in physical function of PsA patients enrolled in the University of Toronto PsA cohort. Patients were assigned to one of three disability states depending on physical function and transition between states was recorded over time. 341 patients were observed for up to 10 years	Anti-TNF-naive PsA patients: male, $n = 201$; female, $n = 140$; age (mean), 45.9 years; duration of PsA (mean), 10.6 years; PASI (mean), 7.1 ± 9.7 units; baseline HAQ-DI score, 0.69 ± 0.67 units	Patients adhered to one of three longitudinal patterns: 46% remained stable [28% of patients remained in the 'no disability' state (HAQ-DI < 0.5 units)], 12% 'moderate' (0.5–1.5 units), and 6% in 'severe disability' (1.51–3 units) throughout the study. 26.7% made a single change to a lower or higher disability group, reflecting steady improvement or deterioration, and 27.3% experienced two or more transitions between states of disability. Mean time between assessments was 1.29 years. Mean change in HAQ-DI between consecutive assessments in deteriorating patients was +0.55 units, and was -0.57 units in improving patients. Greater age was related to slower improvement of HAQ-DI score in the moderate and severe disability groups. Decline in disability was slower in males than in females, and time since diagnosis was related to more frequent transition between disability states. No association was found between PASI score and transition between disability states
Kane <i>et al.</i> , 2003 ⁹⁹	Analysis of 2-year prospective study of 129 PsA patients at St Vincent's University Hospital Early Arthritis Clinic, Dublin, Ireland	Anti-TNF-naive PsA patients: median PsA symptom duration was 9.9 months and mean age at presentation was 41.2 years. Baseline HAQ-DI score was 0.71 units. 12% of patients were on DMARDs and 11% on corticosteroids	The proportion of patients on DMARDs increased to 59% at the 1-year assessment, and was 56% at 2 years. Mean HAQ-DI score decreased from 0.71 to 0.4 units at both 1- and 2-year assessments and measures of joint swelling also decreased. DMARD-free remission at 1 and 2 years was 12% and 11%, respectively. Measures of radiographic progression all increased from baseline to 2 years and mean Sharp erosion score increased from 1.2 units (SD 2.9 units) at baseline to 3 units (SD 5.2 units) at 2 years
Morgan <i>et al.</i> , 2007 ¹⁰⁰	Analysis of HAQ-DI score change over 5 years in 79 patients with inflammatory arthritis plus psoriasis in the NOAR data set	Patients with inflammatory polyarthritis plus psoriasis: Male, $n = 36$; female, $n = 43$; age (median), 51.2 years; baseline HAQ-DI score, 0.625 units (IQR 0.25–1.375 units); DMARD use, 16.5%	After 5 years, the median cohort HAQ-DI score had increased from 0.625 to 0.75 units. 54% of the patients had used DMARDs over the observational period
Rodgers <i>et al.</i> , 2011 ³³	Analysis of HAQ-DI score change over 5 years in the NOAR data set using inclusion criteria specific to eligibility for treatment with biologics (uncontrolled and have tried two or more DMARDs)	Included in the analysis were patients with inflammatory polyarthritis plus psoriasis, three or more tender joints and three or more swollen joints, and previous use of two or more DMARDs	Patients meeting the eligibility criteria at baseline ($n = 27$) had a HAQ-DI score of 1.55 units and for the first 2 years this changed by -0.060 units per year. Between years 3 and 5, the HAQ-DI score changed by +0.077 units per year in those meeting the eligibility criteria ($n = 52$)

IQR, interquartile range; SD, standard deviation.

studies analysing the 79 patients emphasise that they are unlikely to be representative of PsA patients, preferring instead to refer to them as having polyarthritis plus psoriasis. The Morgan *et al.*¹⁰⁰ study analysed the change in median cohort HAQ-DI score over 5 years in 79 patients, finding an increase of 0.125 units over the observation period, indicating a small increase of 0.025 units in HAQ-DI score every year. The patients in this analysis may or may not have been treated with DMARDs over this period. The analysis in Rodgers *et al.*³³ includes only those patients who had previously received two or more DMARDs at each time point, finding an annual HAQ-DI score change of -0.060 units per year over the first 2 years ($n = 24$), and an annual increase of 0.077 units over years 3 to 5 ($n = 52$). This represents a faster progression of disease than that found in the Morgan *et al.*¹⁰⁰ study, but is inconsistent and derived from a small cohort of varying size.

A prospective cohort study of progression in early arthritis carried out by Kane *et al.*⁹⁹ found that HAQ-DI score changed from 0.71 units at baseline to 0.4 units at 1 year and remained as such until the end of the 2-year observation period, representing a decrease of 0.31 units. This decrease is likely to be explained by the increase in uptake of DMARDs, as 12% of patients were receiving DMARD treatment at baseline, compared with 59% at 1 year and 56% at 2 years. This was the only study that recorded radiographic progression, finding consistent increases across all measures between baseline and 2 years, despite the simultaneous drop in HAQ-DI score. The Sharp erosion score increased from 1.2 units at baseline to 3 units at 2 years, demonstrating how HAQ-DI score change may not reflect progressive radiographic damage, particularly during early disease.

The study by Husted *et al.*⁹⁸ was the longest and largest study of natural history of PsA, with 341 patients included and observed for up to 10 years. This study found that the patient population exhibited several patterns of disease progression, rather than just universal consistent deterioration over time. Patients were assigned to one of three disability states based on their HAQ-DI score. These were as follows: 'no disability' (a HAQ-DI score of < 0.5 units), 'moderate disability' (a HAQ-DI score of 0.5–1.5 units) and 'severe disability' (a HAQ-DI score of 1.51–3.0 units). The transition of patients between groups was recorded over the course of the observation period to ascertain the direction of change in their symptoms. Forty-six per cent remained in the same disability group over the course of the study, with 28% of these in the no disability state, 12% in the moderate state and 6% in the severely disabled state. A total of 26.7% of patients made a single transition between disability groups, reflecting steady improvement or deterioration, and 27.3% experienced two or more transitions between disability states. Although this methodology may reveal broad patterns of disease progression, it appears to be insensitive to change within groups and weights HAQ-DI score change near thresholds more highly (e.g. a patient with a baseline HAQ-DI score at the lower end of a Markov group can experience a significant worsening of their disability without progressing into the next group). Mean HAQ-DI score change between consecutive assessments was 0.55 units (± 0.32 units) for those moving from a lower to a higher state and -0.57 units (± 0.36 units) for those moving to a lower state, with assessments being on average 1.29 years apart. In those patients who did not move between groups, the mean HAQ-DI score change was -0.002 units (± 0.215 units). A more complete picture of patterns of disease progression would have been possible had there been more Markov states. The mean HAQ-DI change for the majority of patients at any one time was effectively zero, but this may conceal significant within-group changes in either direction. Greater age was associated with a slower improvement in HAQ-DI score in those in the moderate and severe disability groups, and disability worsened more slowly in males than in females. Time since PsA diagnosis was related to more frequent transition between disability states, and there was no association between PASI score and transition between disability states. In summary, this study indicates that functional disability (as measured via the HAQ-DI) in PsA is generally stable over time in the majority of patients, but there are groups who exhibit patterns of more rapidly worsening or improving symptoms at certain periods, with some experiencing fluctuating deterioration and improvement over time.

Owing to the paucity of observational data on natural history of PsA, it is difficult to produce accurate estimates of yearly disease progression rates without anti-TNF therapy. None of the included studies can claim to provide accurate long-term estimates on uncontrolled disease progression. It is clear from the

largest cohort that functional disability deteriorates over time, but the course of HAQ-DI progression is not constant or predictable. Therefore, it is unclear if an average rate of HAQ-DI change is a useful statistic, as this change is neither constant nor generalisable to the patient population. The Kane *et al.* study⁹⁹ does show that, despite reductions in functional disability in early-stage disease under DMARD therapy, radiographic progression continues to occur, which theoretically will ultimately result in worsening disability in the long term; however, because of the lack of large and long-term observational studies, HAQ-DI change over time in uncontrolled PsA is yet to be properly measured.

Review of adverse effects of certolizumab pegol, secukinumab and comparators

Randomised trials of certolizumab pegol or secukinumab for psoriatic arthritis

Secukinumab: FUTURE 2

During the 16-week placebo-controlled period, AEs were reported in 54% and 58% of patients in the pooled SEC and placebo groups, respectively. The most frequently reported AEs up to 16 weeks in any SEC group (vs. placebo) were upper respiratory tract infection [(confidential information has been removed) vs. 7%], nasopharyngitis [(confidential information has been removed) vs. 8%], headache [(confidential information has been removed) vs. 4%], nausea [(confidential information has been removed) vs. 4%], diarrhoea [(confidential information has been removed) vs. 3%] and urinary tract infection [(confidential information has been removed) vs. 4%]. Rates of infections and infestations were similar across treatment groups (27% on any SEC dose vs. 31% placebo), and no cases of active TB were reported.

The majority of AEs that occurred up to week 16 were mild [(confidential information has been removed) of AEs on any SEC dose and (confidential information has been removed) on placebo] or moderate [(confidential information has been removed) AEs on any SEC dose and (confidential information has been removed) on placebo] in severity. Severe AEs were reported in five patients (1.7% of pooled SEC population), compared with none in patients on placebo. Around 3% of patients in the SEC groups reported non-fatal serious adverse events (SAEs), compared with 2% on placebo. More patients in the placebo group than in the pooled SEC group discontinued study treatment as a result of an AE (confidential information has been removed).

Certolizumab pegol: RAPID-PsA

During the 24-week period, the incidence of drug-related AEs was 26% in the pooled CZP group and 27% in the placebo group and they were mostly of mild intensity (51% pooled CZP vs. 54% placebo) or moderate intensity (30% pooled CZP vs. 36% placebo). The incidence of serious AEs was 6.6% in the pooled CZP group and 4.4% in the placebo group. The incidence of SAEs was 5.8% in the CZP 200 mg group and 9.6% in the CZP 400 mg group.

(Confidential information has been removed.) The most common serious AEs were infections (confidential information has been removed).

Open-label extensions of randomised controlled trials of certolizumab pegol and secukinumab

Secukinumab: FUTURE 2

By the 52-week time point, the most common AEs experienced in patients receiving 300 mg were infection and infestations (79 cases per 100 patient-years), upper respiratory tract infection (18 per 100 patient-years) and nasopharyngitis (14 per 100 patient-years). The rate of discontinuation as a result of AEs in patients who received at least one dose of 150 mg of SEC was 2%. No deaths were reported.

Secukinumab: FUTURE 1

At week 104, 79% of patients remained in the open-label extension study. Infections and infestations were the most common AEs reported, occurring at a rate of 68 per 100 patient-years. Malignant or unspecified tumours occurred at a rate of 0.3 per 100 patient-years, and major adverse cardiac event rates occurred at a rate of 0.7 per 100 patient-years. No cases of active TB or suicide were reported. At week 52 the rate of discontinuation as a result of AEs was 3.9%.

Pooled safety analysis of plaque psoriasis and psoriatic arthritis trials

A conference abstract reported a pooled safety analysis for seven Phase III SEC trials: five plaque psoriasis trials {ERASURE, FIXTURE, SCULPTURE [Efficacy and Safety of Subcutaneous Secukinumab (AIN457) for Moderate to Severe Chronic Plaque-type Psoriasis Assessing Different Doses and Dose Regimens], FEATURE (First Study of Secukinumab in Pre-filled Syringes in Subjects With Chronic Plaque-type Psoriasis: Response at 12 Weeks) and JUNCTURE (Judging the Efficacy of Secukinumab in Patients With Psoriasis Using AutoiNjector: a Clinical Trial Evaluating Treatment Results)} and two PsA trials (FUTURE 1 and FUTURE 2).¹⁰¹ All trials except FUTURE 2 contributed data up to (at least) 52 weeks; FUTURE had data up to 24 weeks. A total of 3928 patients received at least one dose of SEC (3225 patient-years of exposure; mean exposure 299.8 days for SEC and 105.7 days for placebo). Exposure-adjusted incidence rates per 100 patient-years for SEC and placebo were, respectively, 241 and 329 for AEs, 8 and 10 days for SAEs, and 93 and 94 for infections/infestations. Around 3% of patients treated with SEC discontinued treatment as a result of an AE. Nasopharyngitis and upper respiratory tract infections were the most commonly reported events.

Four deaths occurred in patients treated with SEC (one intracranial haemorrhage, one cardiorespiratory arrest, one alcohol intoxication and one of unknown cause); all the deaths were deemed unrelated to the SEC according to the investigators. There were two (0.05%) cases of suicidality with SEC: one attempted suicide and one case of suicidal ideation.

Certolizumab pegol: RAPID-PsA

In the open-label extension study, 393 patients had been exposed to CZP by week 96 (total exposure 606 patient-years). At week 96, the incidence of overall treatment-emergent AEs was 87.8% (345/393 patients; 330 per 100 patient-years). The rate of SAEs was 17% (67 patients; 14.5 per 100 patient-years). Around 4% of patients reported a serious infection (16 cases; 3.3 per 100 patient-years) and 14.2% of patients reported an upper respiratory tract infection (56 patients; 13.7 per 100 patient-years), with no cases of active TB. Malignancies were reported in 1% of patients (four patients; 0.7 per 100 patient-years).

By 96 weeks, 9.2% of patients had experienced an AE leading to withdrawal and six patients (1.5%) had experienced an AE leading to death (two cardiac disorders, one sudden death, one case of breast cancer, one case of sepsis and one lymphoma). According to the investigator, neither cardiac events was considered to be related to the study medication.

Reviews of safety outcomes for other biologics

Six relevant reviews of AEs were identified from the searches. The key results for three of these reviews^{33,102,103} have been summarised in a recently published HTA journal publication of a MTA of anti-TNFs for ankylosing spondylitis and non-radiographic axial spondyloarthritis.¹⁰⁴

The Cochrane systematic review and NMA of AEs of nine biologics in adults with any disease (except human immunodeficiency virus infection/acquired immunodeficiency syndrome) used data from 160 RCTs ($n = 48,676$) and 46 open-label extension studies ($n = 11,954$).¹⁰² The most frequently studied disease in the included trials was RA. When compared with control treatments, only INF and CZP were statistically significantly associated with AEs. INF was associated with higher rates of total AEs [number needed to harm 13, 95% credible interval (CrI) 8 to 505] and withdrawals because of AEs (number needed to harm 10, 95% CrI 5 to 30). CZP was associated with higher rates of serious infections (number needed to harm 12, 95% CrI 4 to 79) and SAEs (number needed to harm 18, 95% CrI 9 to 162). An individual patient data meta-analysis ($n = 22,904$ from 74 RCTs) examining short-term cancer risk associated with ETN, INF and

ADA found no increase in risk of cancers excluding non-melanoma skin cancer (RR 0.99, 95% CI 0.61 to 1.68) when considering all three anti-TNFs together.¹⁰³ However, a doubling in the risk of non-melanoma skin cancer was found, with 332 events per 100,000 person-years in the control group and 655 events per 100,000 person-years in the anti-TNF group [hazard ratio (HR) 2.02, 95% CI 1.11 to 3.95]. NICE TA199³³ included a review of studies (including both randomised and non-randomised studies) of the adverse effects of ETN, INF and ADA. The rates of SAEs covered a broadly similar range across the three anti-TNFs. However, all estimates were derived from a highly heterogeneous group of studies in terms of patients, study design and treatment regimens so reliable estimates of the relative rate of SAEs for each anti-TNF could not be made.³³

Of the three more recent reviews identified,^{105–107} two were reported only as conference abstracts.^{105,106} A Danish guideline panel performed a NMA of SAEs from 87 RCTs ($n = 27,333$) of biologics for inflammatory arthritis (RA, PsA and spondyloarthritis).¹⁰⁵ The conference abstract reported the odds of a SAE to be statistically significantly higher for CZP than for placebo (OR 1.6, 95% CI 1.19 to 2.16). Treatment with CZP was also statistically significantly more likely to result in SAEs than treatment with GOL (OR 2.02, 95% CI 1.26 to 3.25), ETN (OR 1.70, 95% CI 1.15 to 2.51) or ADA (OR 1.44, 95% CI 1.02 to 2.02). The other conference abstract reported a 2014 systematic review and meta-analysis on the safety profile of CZP in patients with an immune-mediated inflammatory disease.¹⁰⁶ The review identified 18 RCTs with 6992 participants; the results, presented in *Table 37*, also highlight the increased risk of SAEs associated with CZP (compared with 'control'), particularly the risk of infectious SAEs.

A review published in 2012 examined the safety of anti-TNFs for treating psoriasis and PsA and focused mainly on data from European patient registries of biologics used across a range of diseases (mostly RA).¹⁰⁷ It was (at least) partly funded by Pfizer, the manufacturer of ETN, and it did not appear to be systematic in its methods of selection, critical appraisal and synthesis of the included studies. It concluded that the safety profile of monoclonal antibodies (INF and ADA) seems generally less favourable than that of ETN, particularly in terms of infections, cancer and hepatotoxicity. The conclusion for infections appeared largely to be based on a BSRBR analysis, specifically on lower respiratory tract infections, even though a previous BSRBR study reported no difference in the risk of infection between ADA, ETN and INF.¹⁰⁸ The conclusion for cancer appeared to be based on an analysis of a small number (38) of lymphomas in a case-control study derived from the French Registry of Infections and Lymphoma in Patients Treated With TNF- α

TABLE 37 Results of a meta-analysis of safety outcomes for CZP⁴⁷

Type of event	Risk ratio vs. control (95% CI)
Overall AEs	1.07 (1.03 to 1.10)
Overall SAEs	1.58 (1.31 to 1.92)
Overall ADRs	1.20 (1.05 to 1.38)
Infectious SAEs	2.14 (1.34 to 3.43)
Injection site reactions	2.01 (0.95 to 4.29)
Neoplasms	1.18 (0.59 to 2.39)
TB	2.90 (0.73 to 11.43)
Withdrawals as a result of AEs	1.19 (0.96 to 1.47)
Fatal AEs	2.08 (0.83 to 5.17)
Infectious AEs	1.21 (1.09 to 1.34)
Upper respiratory tract infections	1.33 (1.15 to 1.53)

ADR, adverse drug reaction.

Antagonists (the data were collected between 2004 and 2006).¹⁰⁹ The conclusion for hepatotoxicity was based on a very small number of case reports.

Recent large observational studies

One recent observational study on the safety of biologics in patients with PsA was identified. It was an Israeli retrospective cohort study based on a health services database, which reported on 3128 patients between 2002 and 2013. The study examined the association between traditional DMARDs or anti-TNFs and infection by the herpes zoster virus (shingles). There were 182 cases of herpes zoster infection in 20,096 person-years. The risk of herpes zoster infection significantly increased in patients treated with a combination of an anti-TNF and a traditional DMARD, but did not increase significantly with each of these types of therapy alone.¹¹⁰

Summary

Safety assessments of new treatments can sometimes be limited in systematic reviews of RCTs because of the small number of trials and relatively short follow-up durations for which data are available. Where available, safety data from trials relating to the same treatment for other indications are therefore sometimes evaluated. For this review, more data from trials of other patient populations were available for CZP than for SEC. The results from three systematic reviews^{105–107} (which looked specifically at AEs) suggested that CZP was associated with statistically significantly more SAEs and serious infections than placebo. SEC was not included in these systematic reviews of AEs, probably as a result of the limited availability of data at the time. Although the safety data for SEC appear promising, the fairly small number of trials for which data are currently available means there is still some uncertainty regarding its safety.

Chapter 4 Evidence synthesis: relative efficacy of treatments

The effectiveness of SEC and CZP has been summarised in *Chapter 3*. Results for the main outcome measures, ACR, PsARC, PASI, HAQ-DI and HAQ-DI conditional on PsARC, for all the comparator agents (ETN, ADA, INF, GOL, UST and APR), have also been presented. These data indicate that all these agents demonstrate statistically significant clinical efficacy in PsA. In order to determine the relative efficacy of these agents it would be ideal to have the results from good-quality adequately powered RCTs comparing active treatments with one another. However, as the evidence base is made up almost entirely of comparisons with placebo, statistical methods for making indirect comparisons, such as a NMA, should be considered. NMA enables the comparison of multiple treatments using both direct comparisons of interventions within RCTs and indirect comparisons across trials based on a common comparator.¹¹¹ As suggested by the term, NMA needs a 'network of evidence' to be established between all of the interventions of interest. The drugs being evaluated here all have a common comparator: placebo. It is this common comparator that allows the network between SEC, CZP and all the active comparators to be established and to provide information on the benefits of these agents relative to placebo and each other. The relevant comparators included in the evidence base are presented in *Table 38* and the basic network diagram is presented in *Figure 7*.

Four separate outcomes were considered. Three outcomes were included in the NMA to inform the economic model: PsARC response; change of HAQ-DI score conditional on PsARC response; and PASI 50, PASI 75 and PASI 90 responses. In addition, ACR 20, ACR 50 and ACR 70 responses were analysed, as ACR response is the primary outcome in most of the included trials. Trials with data suitable for the NMA are identified in *Table 39*. Data from the 12-week time point were used, when available, otherwise data relating to the closest time point after 12 weeks were used (normally 14 or 16 weeks). Not all trials provided data for all of the outcomes analysed.

Framework of analyses

The evidence synthesis was undertaken using WinBUGS (version 1.4.3; MRC Biostatistics Unit, Cambridge, UK). WinBUGS is a Bayesian analysis software tool that, through the use of Markov chain Monte Carlo methods, evaluates posterior distributions for the parameters of interest given likelihood functions derived from data and prior probabilities (uninformative priors were used throughout). There were few individual studies on each treatment; therefore, fixed-effect models were used across studies in all analyses. Parameter estimates

TABLE 38 List of comparators included in evidence synthesis

Treatments, description	Treatments, abbreviation	Class of therapy
150 mg of SEC	SEC150	Anti-IL
300 mg of SEC	SEC300	Anti-IL
400 mg of CZP	CZP	Anti-TNF
45 mg of UST	UST	Anti-IL
50 mg of GOL	GOL	Anti-TNF
40 mg of ADA	ADA	Anti-TNF
5 mg/kg of INF	INF	Anti-TNF
25 mg of ETN	ETN	Anti-TNF
30 mg of APR	APR	APR

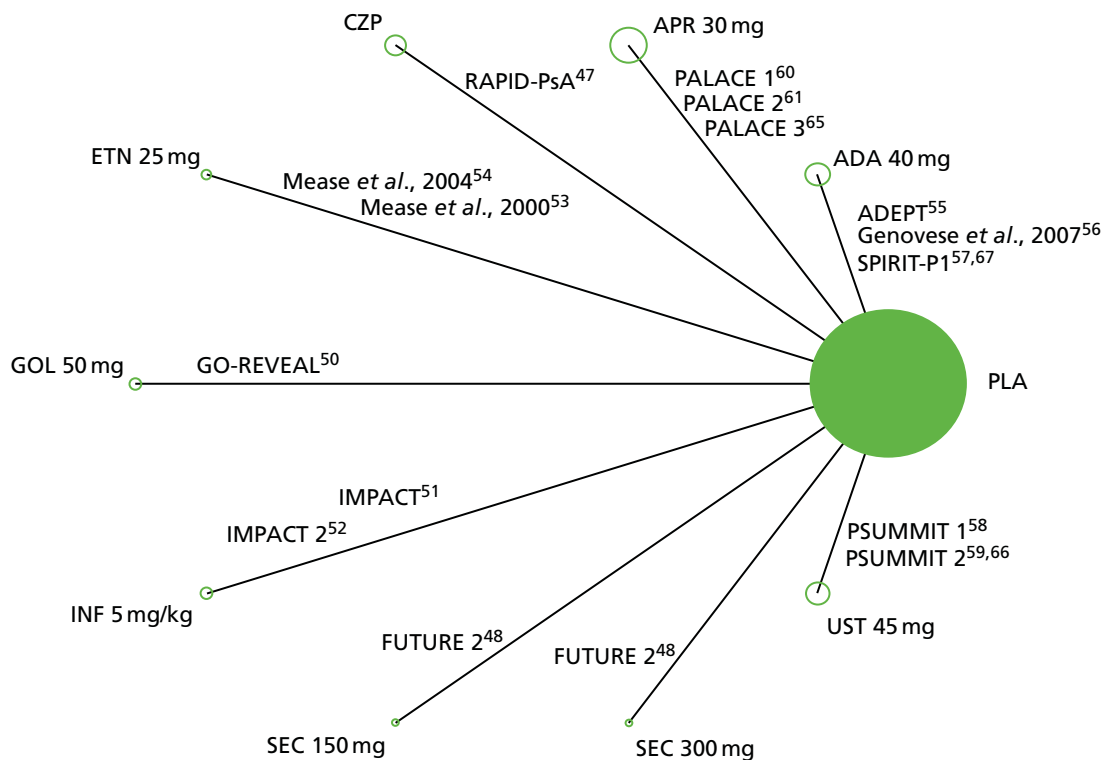

FIGURE 7 Network of evidence (not outcome or subgroup specific). PLA, placebo.

for all functional parameters were reported from the models. These differ by outcome, and further details are presented in *Methods*. Treatment effects were expressed in relation to placebo. Owing to the sparse evidence imposing a high level of uncertainty over estimates of functional parameters, point estimates are medians throughout. Some models assumed exchangeability across treatments within a class, that is, different treatments of the same class were assumed to be similar, rather than equal. Within such models we reported the relative effectiveness estimates for each treatment (called shrunken estimates), rather than the class means, allowing us to represent any residual differences across treatments.

The validity of a NMA depends on an assumption of homogeneity/exchangeability between all the trials included in the network [i.e. that there are no essential differences between the methods, populations and interventions being studied, and that any differences are a result of chance (as in a standard meta-analysis)]. The lack of homogeneity/exchangeability between studies involving one of the treatments of interest and studies involving the other treatments of interest may generate inconsistency. Checking for consistency in the current network was not possible because of the lack of trials that directly compare active agents. Our examination of the study details and patient characteristics (see *Chapter 3, Characteristics of the randomised controlled trials included in the systematic review of short-term efficacy*) identified that the trials of the newer agents (SEC, CZP, UST and APR) included biologic-experienced patients as well as biologic-naïve patients. Given that it is evident from large observational data sets (see *Chapter 3, Review of anti-tumour necrosis factor patient registry studies*) that efficacy response rates in biologic-experienced patients are lower than in biologic-naïve patients, it was considered inappropriate to conduct an 'all-patients' NMA for any outcome, and that, instead, biologic-naïve and biologic-experienced patients should be analysed separately. Therefore, separate analyses (separate networks) for treatment-naïve and treatment-experienced patients were constructed for each of the four outcomes: one each for PsARC, HAQ-DI conditional on PsARC, PASI 50, 75 and 90, and ACR 20, 50 and 70 responses. A summary of the trials reporting data on each of these outcomes is presented in *Table 39*. It should be noted that the NICE scope¹¹² for the present appraisal subdivides biologic-naïve patients into those who have not responded to one cDMARD and those who have not responded to two cDMARDs. However, sufficient data were not available for these further levels of subgroup analysis.

TABLE 39 Evidence on PsARC, HAQ-DI conditional on PsARC, PASI and ACR, by trial

Trial	Publication year	Active treatment	Outcome											
			PsARC			HAQ-DI score conditional on PsARC			PASI 50, PASI 75 and PASI 90			ACR 20, ACR 50 and ACR 70		
			Naive	Experienced	Time point (weeks)	Naive	Experienced	Time point (weeks)	Naive	Experienced	Time point (weeks)	Naive	Experienced	Time point (weeks)
FUTURE 2 ⁴⁸	2015	SEC	Yes	Yes	12	Yes	Yes	12	Yes	Yes	12	Yes	Yes	12
RAPID-PsA ⁴⁷	2014	CZP	Yes	Yes ^a	12	Yes	Yes ^a	12	Yes	Yes ^a	12	Yes	Yes ^a	12
PSUMMIT 1 ^{58,66}	2013	UST	Yes		24	Yes ^b		24	Yes		12	Yes		12
PSUMMIT 2 ^{59,66}	2014	UST	Yes	Yes	24		Yes	24	Yes	Yes	12	Yes		12
GO-REVEAL ⁵⁰	2009	GOL	Yes		14	Yes		14	Yes		14	Yes		14
Genovese <i>et al.</i> , 2007 ⁵⁶	2007	ADA	Yes		12	Yes		12				Yes		12
ADEPT ⁵⁵	2005	ADA	Yes		12	Yes		12	Yes		12	Yes		12
IMPACT 2 ⁵²	2005	INF	Yes		14	Yes		14	Yes		14	Yes		14
IMPACT ⁵¹	2005	INF	Yes		16	Yes		16	Yes		16	Yes		16
Mease <i>et al.</i> , 2004 ⁵⁴	2004	ETN	Yes		12	Yes		12				Yes		12
Mease <i>et al.</i> , 2000 ⁵³	2000	ETN	Yes		12				Yes		12	Yes		12
PALACE 1 ^{60,61}	2014	APR	Yes		16	Yes		16	Yes		16	Yes		16
PALACE 2 ^{61,65}	2014	APR	Yes		16	Yes		16	Yes		16	Yes		16
PALACE 3 ^{61,65}	2014	APR	Yes		16	Yes		16	Yes		16	Yes		16
SPIRIT-P1 ^{57,67}	2015	ADA							Yes		12	Yes		12

a CZP treatment-experienced data not included in the NMA as the definition of treatment-experienced patients in this trial was different from that in other trials (see *Chapter 3, Characteristics of the randomised controlled trials included in the systematic review of short-term efficacy*).

b Pooled data.

As discussed in *Chapter 3, Evaluating the secukinumab and certolizumab pegol trial results in comparison with other treatments*, another important difference between the included trials is the observed results in the placebo arms, particularly for PsARC (see *Table 40*), PASI outcomes (see *Table 50*) and ACR (see *Table 56*). Our investigations on trial designs and patient characteristics did not identify any clear reasons for such differences, other than that placebo response rates appear to have increased over time. This observation (termed ‘placebo creep’) has been made in several other areas of clinical research and its impact on indirect treatment comparisons has been discussed.¹¹³ In the current review, across all trials, the PsARC placebo response rates are high, but are much higher in more recently conducted trials, and this has implications when interpreting unadjusted effect estimates. This is because the ceilings (maximum values) of RRs are limited by baseline response rates. For example, in the FUTURE 2 trial,⁴⁸ the placebo response rate for PsARC in the biologic-naïve subgroup was (confidential information has been removed), which meant that the maximum possible RR would be (confidential information has been removed); this maximum result is lower than some of the actual RRs for other biologics (see *Table 40*). Higher placebo rates therefore appear to dilute effect estimates somewhat. This is also demonstrated by the examining the RRs moving up the ACR outcome thresholds from ACR 20 to ACR 70, which generally increase (see *Table 29*). However, it is not clear exactly how these varying placebo rates will affect treatment effects when calculated using ORs. The evidence synthesis – which was based on ORs – therefore explored a potential relationship between baseline risk and relative effectiveness. The NMA explored scenarios where a metaregression on baseline risk (i.e. placebo response) was implemented for PsARC, PASI and ACR outcomes, which imposes an interaction effect between baseline risk and relative effectiveness.¹¹⁴ Further details of these analyses are presented below. Given that HAQ-DI scores are modelled conditional on PsARC response, such an interaction effect was deemed to be less relevant, and a metaregression model was not implemented on HAQ-DI.

Psoriatic Arthritis Response Criteria response

Subpopulation: biologic naïve

Data

For the biologic-naïve population, trial-specific PsARC response data were available from 14 trials^{47,48,50–56,58–61,65,66} of nine active treatments (150 mg of SEC, 300 mg of SEC, CZP, UST, GOL, ADA, INF, ETN and APR), and all treatments were compared with placebo (*Table 40*).

The nine active treatments were categorised into three classes (anti-TNF, anti-IL and APR). Outcome data for GOL, INF and APR at 14–16 weeks, and for UST at 24 weeks, were included in the analysis and assumed equivalent to outcomes at 12 weeks. The inclusion of the 24-week PsARC data for UST was based on an assumption that they fairly reflected the 12-week results (subgroup results for PsARC at 12 weeks in the PSUMMIT 2 trial^{59,66} were not available, although 12-week data for the full population were available); this issue is discussed further in *Appendix 3, Data used for the ustekinumab (PSUMMIT) trials*. The trial-specific data included in the PsARC response analysis are presented in *Table 40*.

Methods

The NMA implemented separate models for the pooling of treatment effects and of placebo responses. We first implemented a model with independent treatment effects across treatments. Then a number of alternative models were implemented to explore the possibility of placebo response, and, within this, whether or not there was similarity between treatment effects for treatments of the same class.

Exploring placebo response as a treatment effect modifier

An examination of individual trial results suggests that studies presenting higher placebo rates report lower relative effectiveness estimates (see *Appendix 3, Detailed methods for the biologic-naïve subpopulation*). In addition, recent trials, which evaluate newer treatments, also tend to show higher placebo response rates. For example, a recent study on 300 mg of SEC showed a placebo response rate of 46% (the FUTURE 2 trial⁴⁸), which is much higher than that reported in an earlier study evaluating ETN, of 23% (Mease *et al.*⁵³).

TABLE 40 Summary of trial-specific data in the biologic-naive subpopulation for PsARC response

Trial	Treatment arm	PsARC response						OR (95% CI)	RR (95% CI)
		Treatment arms			Placebo				
		r ^a	n ^b	%	r ^a	n ^b	%		
FUTURE 2 ⁴⁸	300 mg of SEC	Confidential information has been removed	Confidential information has been removed	Confidential information has been removed	Confidential information has been removed	Confidential information has been removed	Confidential information has been removed	3.19 (1.80 to 5.66)	1.59 (1.17 to 2.15)
FUTURE 2 ⁴⁸	150 mg of SEC	Confidential information has been removed	Confidential information has been removed	Confidential information has been removed	Confidential information has been removed	Confidential information has been removed	Confidential information has been removed	3.17 (1.77 to 5.67)	1.59 (1.17 to 2.16)
RAPID-PsA ⁴⁷	CZP	Confidential information has been removed	Confidential information has been removed	Confidential information has been removed	Confidential information has been removed	Confidential information has been removed	Confidential information has been removed	2.98 (2.00 to 4.44)	1.61 (1.28 to 2.04)
PSUMMIT 1 ⁵⁸	UST	115	205	56	77	206	37	2.14 (1.51 to 3.03)	1.50 (1.21 to 1.86)
PSUMMIT 2 ^{59,66}	UST	24	43	56	16	42	38	2.05 (0.96 to 4.40)	1.47 (0.92 to 2.34)
GO-REVEAL ⁵⁰	GOL	107	146	73	24	113	21	10.17 (6.13 to 16.88)	3.45 (2.39 to 4.99)
Genovese <i>et al.</i> , 2007 ⁵⁶	ADA	26	51	51	14	51	27	2.75 (1.29 to 5.86)	1.86 (1.10 to 3.13)
ADEPT ⁵⁵	ADA	94	153	61	42	162	26	4.55 (2.97 to 6.97)	2.37 (1.77 to 3.16)
IMPACT 2 ⁵²	INF	77	100	77	27	100	27	9.05 (5.39 to 15.20)	2.85 (2.03 to 4.01)
IMPACT ⁵¹	INF	39	52	75	11	52	21	11.18 (5.17 to 24.19)	3.55 (2.05 to 6.13)
Mease <i>et al.</i> , 2004 ⁵⁴	ETN	73	101	72	32	104	31	5.87 (3.57 to 9.65)	2.35 (1.72 to 3.21)
Mease <i>et al.</i> , 2000 ⁵³	ETN	26	30	87	7	30	23	21.36 (8.05 to 56.68)	3.71 (1.91 to 7.21)
PALACE 1 ^{60,61}	APR	78	168	46	50	168	30	2.05 (1.35 to 3.10)	1.56 (1.17 to 2.07)
PALACE 2 ^{61,65}	APR	78	162	48	53	159	33	1.86 (1.23 to 2.80)	1.44 (1.10 to 1.90)
PALACE 3 ^{61,65}	APR	88	167	53	46	169	27	2.98 (1.97 to 4.51)	1.94 (1.46 to 2.58)

a Number of PsARC responders.
b Number randomised.

Our investigations regarding trial designs and patient characteristics did not identify a clear reason for such differences, although placebo response rates appear to have increased over time. We investigated the effect of placebo response as a potential treatment effect modifier. It should be noted that the source of any relationship between placebo response and treatment effect is unclear, and the reader should interpret the results carefully and with caution.

To account for the differences in placebo response rates across the trials, a metaregression was undertaken. The baseline risk estimated for each trial within the synthesis model was used as the adjustment covariate. This allows for uncertainty in the estimation of baseline risk to be considered in the adjustment alongside any correlation with the log-ORs. Note that the baseline risk is expressed as the log-odds of PsARC response in the placebo arm. As typical of metaregression, the relationship between the treatment effect and baseline risk is defined by an interaction term (beta).

Within the independent treatment-effects analysis, beta is estimated by comparing the treatment effects across multiple studies on the same treatment with different placebo response rates. Within the evidence base, not all treatments present with multiple trials. Thus, only a subset of treatments contribute evidence to estimate beta: ADA (ADEPT⁵⁵ and Genovese *et al.*⁵⁶), ETN (Mease *et al.*^{53,54}) and APR (the PALACE 1,^{60,61} PALACE 2^{61,65} and PALACE 3^{61,65} trials). This limitation in the evidence base meant that the beta had to be assumed to be independent of treatment (i.e. equal for all treatments). Moreover, the evidence base also showed that studies on the same treatment report reasonably similar placebo response rates. This may limit the validity of inferences over beta. For example, the Genovese *et al.*⁵⁶ and ADEPT⁵⁵ studies report placebo response rates of 27% and 26%, respectively, whereas across the whole set of studies the placebo response range from 21% to (confidential information has been removed).

As inferences on beta are drawn from differences between trials, the smallest difference in placebo rates corresponds to the maximum possible influential difference in reported treatment effects. The two trials on ADA (ADEPT⁵⁵ and Genovese *et al.*⁵⁶) illustrate this perfectly: the small (1%) difference in placebo response is associated with a 10% difference in response rate in the treatment group (from 51% to 61%). These data are thus influential to estimates of beta. Of the studies that contribute to inferences on beta, two trials have the smallest sample size of the whole set of trials: Mease *et al.*⁵³ (ETN) and Genovese *et al.*⁵⁶ (ADA). Given this, a sensitivity analysis excluding both Mease *et al.*⁵³ and Genovese *et al.*⁵⁶ was performed and effects on the estimate of beta ascertained (see *Appendix 3, Detailed methods for the biologic-naive subpopulation* for a more detailed account of the methods).^{53,56}

Exploring treatment effects as class

In the context of an adjusted model for placebo response, we explored the possibility of there being class effects. Three different class groupings were considered: all treatments as a single class; all biologics as a class with APR separate; and, to reflect the pharmacology, anti-TNFs grouped, ILs grouped and APR separate. Additionally, for the last two groupings, we explored two within-class assumptions: assuming treatments within a class to have equal effectiveness and, alternatively, that treatments within a class have similar (exchangeable) effectiveness. Fixed effects across studies were assumed for all models. We did not consider models assuming exchangeability between classes.

Summary of all treatment effect models explored

All models implemented for the evidence synthesis of PsARC response are presented in *Table 41*. The models are numbered for ease of reference. Details of the models are presented in *Appendix 3, Detailed methods for the biologic-naive subpopulation*.

Model A1 considers the effectiveness of treatments as independent of each other. Model B1 considers the relative effectiveness of the alternative treatments as independent of each other, but that they all depend on the response in the placebo arm. Models C1, C2 and C3 consider the treatments as equal in terms of their effectiveness within class, but dependent on the effect of the placebo arm. Models D1 and D2 assume the treatments to have a similar, but not equal, effectiveness that is dependent on the effect of

TABLE 41 Key assumptions of models implemented for the evidence synthesis of PsARC response

Sets of analysis	Study	Treatment	Metaregression	Class
A1	FE	Independent	No baseline adjustment	No class effect
B1	FE	Independent	Common interaction term with log-odds of response in placebo arm	No class effect
C1	FE	Equal I class	Common interaction term with log-odds of response in placebo arm	Independent class effect: class = {all treatments}
C2	FE	Equal I class, remaining treatments independent ^a		Independent class effect: class = APR independent {all remaining biologics}
C3	FE	Equal I class, remaining treatments independent ^a		Independent class effect: class = {anti-TNFs, ILs}; APR independent
D1	FE	Exchangeable I class, remaining treatments independent ^a	Common interaction term with log-odds of response in placebo arm	Independent class effect: class = APR independent {all other biologics}
D2	FE	Exchangeable I class, remaining treatments independent ^a		Independent class effect: class = {anti-TNFs, ILs}; APR independent

FE, fixed effect.

a APR independent.

the placebo arm; this model introduces more flexibility than assuming treatment effects to be equal (models C2 and C3), but does not fully assume treatments to differ as in model A1. It allows for differences between the effectiveness of treatments that we may not be able to explain but that we should consider.

As stated earlier, sensitivity analysis around the adjustment for placebo response were performed: sets of analyses (models A1, B1, C1, C2, C3, D1 and D2) were conducted for PsARC response, excluding the Mease *et al.*⁵³ and Genovese *et al.*⁵⁶ trials.

Network meta-analysis results

Treatment effect models

Table 42 presents results of the treatment effects of PsARC response on the log-odds scale. Results are presented for all the alternative models with measures of goodness of fit. There were no issues with convergence. More detailed results of the models (A1, B1, C1, C2, C3, D1 and D2) are presented in Appendix 3, *Detailed results for the biologic-naïve subpopulation* (ORs as well as log-odds, together with means, medians and 95% CIs are presented).

The unadjusted model A1 indicates an appropriate model fit (with residual deviance close to the number of data points informing the model). The placebo response-adjusted model B1 fits well compared with the unadjusted model A1 [it presents a smaller deviance information criterion (DIC) and residual deviance, but not significantly so, as the difference in DIC is < 5 points].¹¹⁵ Model B1 imposes an association between the log-odds of placebo response and treatment effect. The estimated beta implies that a trial with a higher odds of a placebo response is expected to report smaller treatment effects. Consider 300 mg of SEC in unadjusted model A1: the treatment effect is evaluated at 1.178, but the studies on this treatment have a higher log-odds of placebo response than those on other anti-TNFs. The treatment effects reported in the adjusted model assume all treatments were trialled with the same baseline risk. Thus, after adjustment

TABLE 42 Network meta-analysis results of PsARC response: log-ORs (median) of treatments analysed (including the studies of Genovese *et al.*⁵⁶ and Mease *et al.*⁵³) in the biologic-naive subpopulation

		No	Yes	Yes	Yes	Yes	Yes	Yes	Yes	Yes	Yes	Yes	Yes	Yes	
		Ind	Ind	= I class	= I class	= I class	~ I class ^a	~ I class ^a							
		No	No	{All}	{APR, other}	{IL, TNF, APR}	{APR, other}	{ILs, TNFs, APR}							
	Log-odds placebo	A1	r	B1	r	C1	r	C2	r	C3	r	D1	r	D2	r
300 mg of SEC	-0.16	1.178	5	2.110	1							1.844	3	1.833	3
150 mg of SEC	-0.16	1.175	6	2.104	2					1.285	2	1.839	4	1.822	4
UST	-0.51	0.758	9	1.187	7							1.197	8	1.174	8
CZP	-0.28	1.094	7	1.837	5	1.278	1	1.565	1			1.722	5	1.716	5
GOL	-1.32	2.339	1	1.619	6							1.692	6	1.712	6
ADA	-1.02	1.401	4	1.081	8					1.648	1	1.201	7	1.201	7
INF	-1.15	2.296	2	1.870	4							1.853	2	1.875	1
ETN	-0.99	2.043	3	1.917	3							1.856	1	1.872	2
APR	-0.85	0.813	8	0.765	9			0.756	2	0.779	3	0.769	9	0.771	9
Beta (mean)	-			-1.471		-0.498		-1.692		-1.061		-1.264		-1.225	
Residual deviance ^b		29.9		27.2		59.24		46.8		47.5		27.8		27.9	
DIC		193.1		190.5		N/A ^c		203.8		199.1		190.0		190.3	

= I class, equal class effect; ~ I class, exchangeable class effect; ind, independent treatment effect; N/A, not applicable; pD, posterior mean of the deviance minus the deviance of the posterior means; r, ranking of treatments according to point estimates.

a Shrunken estimates.

b Compared with 27 data points.

c N/A as the model C1 does not fit well and estimated lower 'posterior mean of the deviance' than the 'deviance of the posterior means', which resulted in a negative pD and a lower DIC, therefore we only use residual deviance as model fit statistics for model C1.

with the placebo response in model B1, the treatment effect estimate for 300 mg of SEC is higher (2.110). This is why the results (and rankings) generated by model B1 are very different from the observed trial results and results generated by the model A1.

Although the assumptions imposed by the placebo-adjusted model may be difficult to justify, or counteract, the limitations in the evidence base that underlie inferences also limit interpretation. First, the distinction between treatment effects and placebo effect is unclear. This is because newer treatments tested under higher placebo response rates show lower treatment effects, whereas older treatments tested under lower placebo response rates show higher treatment effects. There is also limited evidence on the effects of different placebo response rates for the newer treatments (SEC and CZP), as these drugs were studied in a single trial each.

We have further explored treatment effects as class. Model C1, which assumes that all treatments are equal, does not fit well with the existing data as it shows a much increased residual deviance. Models C2 and C3, which assume treatment equal within their class (model C2 separates APR from other drugs and model C3 separates ILs, anti-TNFs and APR), also do not fit well with the existing data, resulting in higher residual deviance and DIC. Models D1 and D2, however, relax the assumption of equality and apply a class effect where treatments within a class are assumed to be similar, not equal. These models fit equally well when compared with model B1 (similar DIC and residual deviance).

In all models exploring treatment effects as a class, the interaction term (beta) is negative. Among the best-fitting models (B1, D1 and D2), the more negative interaction term is observed in model B1. The interaction terms are similar between models D1 and D2.

In sensitivity analyses, we explored the effect of excluding the studies of Genovese *et al.*⁵⁶ and Mease *et al.*⁵³ on the placebo interactions (see *Appendix 3, Detailed results for the biologic-naive subpopulation* for details). The results showed that the beta is still negative, although of lower absolute value.^{53,56}

Preferred models

The unadjusted model A1 fits the data as well as any of the other models and generates results that reflect the observed results of individual trials. Alternatively, we considered a model adjusted for placebo response. Despite no clear rationale for why placebo response rate should affect the treatment effect, when allowing for such an association (model B1), lower treatment effects are expected with higher placebo response rates. The results (and rankings) attained with model B1 are very different to those evaluated in model A1, and depend on the credibility of the association assumed. Regarding possible class effects, the analyses found that an assumption of equal class effect for the treatments does not produce a better-fitting model (models C1, C2 and C3) than assuming independent treatment effects (models A1 and B1) or similar treatment effects (models D1 and D2). There was little difference in goodness-of-fit statistics (DIC and residual deviance) between models D1 and D2, and we consider the exchangeable class effect model (D2), which utilised two classes (anti-IL and anti-TNF) with APR separate, to be the most clinically plausible.^{53,56} Hence, we consider models A1 and D2^{53,56} to be our preferred models for the economic model in *Chapter 6*. Given the limited effect in sensitivity analysis, the Genovese *et al.*⁵⁶ and Mease *et al.*⁵³ studies were included in the preferred models.

A comparison of these analyses with those presented in the company submissions (CSs; Novartis and UCB Pharma) and those in the previous MTA (Rodgers *et al.*³³) is presented in *Appendix 3, Comparison of the network meta-analysis of Psoriatic Arthritis Response Criteria responses in the company submissions (Novartis and UCB Pharma), a previous multiple technology appraisal (Rodgers et al.) and the current Assessment Group*.

Table 43 presents the probability and ORs for PSARC response from these preferred models.

TABLE 43 Network meta-analysis results: probability of PsARC response and ORs by treatments in the biologic-naive subpopulation

Treatment	Not adjusted for placebo response, independent treatment (model A1)		Adjusted for placebo response, class effects assumed ^a (model D2)	
	Probability, median (95% CrI)	OR, median (95% CrI)	Probability, median (95% CrI)	OR, median (95% CrI)
Placebo	0.31 (0.26 to 0.36)		0.31 (0.26 to 0.36)	
300 mg of SEC	0.59 (0.40 to 0.76)	3.25 (1.56 to 6.89)	0.73 (0.57 to 0.86)	6.25 (3.15 to 13.31)
150 mg of SEC	0.59 (0.40 to 0.76)	3.24 (1.54 to 6.96)	0.73 (0.57 to 0.86)	6.18 (3.10 to 13.30)
UST	0.49 (0.38 to 0.60)	2.13 (1.49 to 3.07)	0.59 (0.48 to 0.70)	3.24 (2.25 to 4.86)
CZP	0.57 (0.44 to 0.69)	2.99 (1.88 to 4.81)	0.71 (0.60 to 0.81)	5.56 (3.59 to 9.11)
GOL	0.82 (0.71 to 0.90)	10.37 (5.87 to 18.98)	0.71 (0.58 to 0.81)	5.54 (3.23 to 9.06)
ADA	0.64 (0.53 to 0.75)	4.06 (2.70 to 6.21)	0.60 (0.49 to 0.69)	3.33 (2.30 to 4.70)
INF	0.81 (0.71 to 0.89)	9.93 (5.91 to 17.06)	0.74 (0.63 to 0.83)	6.52 (4.18 to 10.04)
ETN	0.77 (0.65 to 0.86)	7.71 (4.53 to 13.58)	0.74 (0.64 to 0.82)	6.50 (4.38 to 9.85)
APR	0.50 (0.41 to 0.59)	2.26 (1.73 to 2.94)	0.49 (0.41 to 0.57)	2.16 (1.76 to 2.64)

^a Shrunken estimates presented here.

The NMA that does not adjust for the placebo response finds that SEC is more effective than CZP, and both are more effective than UST and APR, but both are somewhat less effective than all comparator anti-TNFs. After adjusting for the unexplained increase in placebo rates seen in more recent trials (and, hence, of newer agents), and under a class effect that allows for exchangeability for treatments within each class, the probability of a response with SEC remains slightly higher than with CZP and both remain more effective than UST and APR, but now their probability of response is similar to, or only slightly less than, that of the anti-TNF comparators.

These results indicate that, although SEC and CZP are effective in terms of the PsARC outcome, the relative effectiveness of these biologics compared with ETN, ADA, GOL, UST and INF and with each other, is uncertain. Both agents do seem to be more effective than APR.

Subpopulation: biologic experienced

For the biologic-experienced population, trial-specific PsARC response data were available from three trials for three active treatments (300 mg of SEC, CZP and UST), all compared with placebo.^{47,48,59,66} However, the data from the CZP trial were not included in the analysis, as the RAPID-PsA trial excluded patients with primary failures of a prior anti-TNF (i.e. no response within the first 12 weeks of treatment) from being recruited in its biologic-experienced population and so is not comparable to the other two trials. The data included in the NMA for treatment-experienced patients are presented in *Table 44*.

The NMA conducted for the synthesis of data in the biologic-experienced population is equal to that implemented in the treatment-naive population: treatment effects are assumed to be independent and the model assumed fixed effects across trials. The evidence for the biologic-experienced subpopulation was sparse. The results of the analysis are presented in the *Table 45*. The result shows that the probability of a PsARC response is higher with SEC than with UST, but the CrIs overlap and the difference is likely to be insignificant. The results are comparable to the observed data (compare *Tables 44* and *45*) and consistent with those of the biologic-naive subpopulation (compare *Tables 43* and *45*).

TABLE 44 Summary of trial-specific data in the biologic-experienced subpopulation for PsARC response outcome

Trial	Treatment arm	PsARC response						OR (95% CI)	RR (95% CI)
		Treatment arms			Placebo				
		<i>r</i> ^a	<i>n</i> ^b	%	<i>r</i> ^a	<i>n</i> ^b	%		
FUTURE 2 ⁴⁸	300 mg of SEC	Confidential information has been removed	60	55	Confidential information has been removed	16	Confidential information has been removed	5.75 (2.38 to 13.89)	2.44 (1.38 to 4.31)
PSUMMIT 2 ^{59,66}	UST	33	60	55	Confidential information has been removed	16	Confidential information has been removed	3.51 (1.75 to 7.04)	2.13 (1.32 to 3.44)

a Number of PsARC responders.

b Number randomised.

TABLE 45 Network meta-analysis results of PsARC response: probability of a PsARC response, ORs and treatment effects on a log-scale in the biologic-experienced subpopulation

Treatment	Probability of PsARC response, median (95% CrI)	OR, median (95% CrI)	Treatment effects (log-odds), median (95% CrI)
Placebo	0.266 (0.19 to 0.36)		-1.013 (-1.48 to -0.58)
300 mg of SEC	0.686 (0.41 to 0.88)	6.033 (2.15 to 18.39)	1.797 (0.77 to 2.91)
UST	0.566 (0.35 to 0.76)	3.559 (1.68 to 7.76)	1.279 (0.53 to 2.07)
Residual deviance ^a	4.07		
DIC	24.62		

a Compared four data points.

Health Assessment Questionnaire-Disability Index changes conditional on Psoriatic Arthritis Response Criteria response/non-response

Subpopulation: biologic naive

Data

For the biologic-naive population, HAQ-DI changes conditional on PsARC responses were available for nine active treatments (150 mg of SEC, 300 mg of SEC, CZP, UST, GOL, ADA, INF, ETN and APR) from 13 trials (see *Table 39*).^{47,48,50–52,54–56,58–61,65,66} The data for HAQ-DI change conditional on PsARC response are presented in *Table 46*.

Outcome data for GOL and INF at 14–16 weeks, and for UST at 24 weeks, were included in the analysis and assumed equivalent to outcomes at 12 weeks. The rationale for the inclusion of the 24-week data for UST is discussed in *Appendix 3, Data used for the ustekinumab (PSUMMIT) trials*. The observed data indicate that HAQ-DI changes conditional on PsARC response do vary by treatment, ranging between (confidential information has been removed) (300 mg of SEC, FUTURE 2 trial⁴⁸) and -0.290 (APR, PALACE 3 trial^{61,65}). The observed HAQ-DI changes conditional on PsARC non-response in treatments range between (confidential information has been removed) (150 mg of SEC, FUTURE 2 trial⁴⁸) and -0.049 (GOL, GO-REVEAL trial⁵⁰).

For the placebo arms, the observed HAQ-DI changes conditional on PsARC response and non-response differ between trials [ranging between (confidential information has been removed) (FUTURE 2 trial⁴⁸) and -0.160 (IMPACT 2⁵²) for response, and from (confidential information has been removed) (RAPID-PsA trial⁴⁷) to 0.070 (IMPACT 2⁵²) for non-response].

The observed HAQ-DI changes conditional on PsARC response and non-response with treatments are greater than with placebo in all trials.

Methods

We consider three models to estimate the HAQ-DI changes conditional on PsARC responder or non-responder status. A detailed description of the model and underlying assumptions are presented in *Appendix 3, Detailed methods for the biologic-naive subpopulation*. The model E1 considers that treatments are independent and considers fixed effects across studies. Models E2 and E3 apply a class effect comprising three groups: anti-TNFs, ILs and APR. This class effect reflects the best-fitting class effect model for PsARC (see *Network meta-analysis results*). The model E2 assumes that the treatments are similar within class (exchangeable) and considers fixed effects across studies; and model E3 considers that the treatments are equal within class and considers fixed effects across studies.

TABLE 46 The HAQ-DI changes conditional on PsARC response and non-response by trials and treatments in the biologic-naive subpopulation: observed data

Trial	Treatment	HAQ-DI changes conditional on PsARC response				HAQ-DI changes conditional on PsARC non-response			
		Treatment arm		Placebo arm		Treatment arm		Placebo arm	
		Mean	SE	Mean	SE	Mean	SE	Mean	SE
FUTURE 2 ⁴⁸	150 mg of SEC	Confidential information has been removed	Confidential information has been removed	Confidential information has been removed	Confidential information has been removed	Confidential information has been removed	Confidential information has been removed	Confidential information has been removed	Confidential information has been removed
FUTURE 2 ⁴⁸	300 mg of SEC	Confidential information has been removed	Confidential information has been removed			Confidential information has been removed	Confidential information has been removed		
RAPID-PsA ⁴⁷	CZP	Confidential information has been removed	Confidential information has been removed	Confidential information has been removed	Confidential information has been removed	Confidential information has been removed	Confidential information has been removed	Confidential information has been removed	Confidential information has been removed
PSUMMIT 1 + PSUMMIT 2 ^{58,59,66}	UST	-0.487	0.05	-0.260	0.04	-0.097	0.05	-0.001	0.03
GO-REVEAL ⁵⁰	GOL	-0.424	0.07	-0.286	0.05	-0.049	0.06	0.023	0.02
ADEPT ⁵⁵	ADA	-0.500	0.05	-0.313	0.08	-0.120	0.05	0.026	0.04
Genovese <i>et al.</i> , 2007 ⁵⁶	ADA	-0.423	0.08	-0.177	0.06	-0.150	0.09	-0.057	0.05
IMPACT 2 ⁵²	INF	-0.580	0.06	-0.160	0.10	-0.110	0.06	0.070	0.04
IMPACT ⁵¹	INF	-0.650	0.09	-0.270	0.14	-0.200	0.09	0.020	0.05
Mease <i>et al.</i> , 2004 ⁵⁴	ETN	-0.635	0.06	-0.258	0.01	-0.196	0.07	-0.002	0.04
PALACE 1 ^{60,61}	APR	-0.460	0.05	-0.320	0.07	-0.070	0.05	0.000	0.04
PALACE 2 ^{61,65}	APR	-0.330	0.06	-0.220	0.07	-0.120	0.05	0.010	0.04
PALACE 3 ^{61,65}	APR	-0.290	0.05	-0.250	0.06	-0.080	0.05	0.000	0.03

Network meta-analysis results

The results are presented as absolute changes in HAQ-DI score in relation to baseline (*Table 47*). More detailed results are presented in *Appendix 3, Detailed results for the biologic-naive subpopulation*.

The model fit statistics (DIC) indicate that neither class effect model (E2 or E3) is a better fit for the data than the unadjusted, independent treatments model (E1). The class effect models had similar fits, but the one that allowed exchangeability within classes (E2) was considered to be the most clinically plausible. For the purposes of the economic model, in *Chapter 6*, models E1 and E2 were the preferred models.

The results from the two preferred models are similar. The results from the unadjusted independent treatment effects model found that significant reductions in mean HAQ-DI score were achieved with response to all nine treatments and response to placebo. However, patients who responded to placebo achieved a lower level of improvement in the HAQ-DI score than those who responded to active treatment. Furthermore, the improvement in response to placebo is below the minimally important difference for PsA of -0.35 .¹¹⁶

The median conditional on response HAQ-DI change was highest with INF and ETN, followed by 300 mg of SEC, but 150 mg of SEC and CZP were worse than all treatments except for APR.

Subpopulation: biologic experienced

For the biologic-experienced population, HAQ-DI changes conditional on PsARC responses were available for three active treatments (300 mg of SEC, CZP and UST) from three trials.^{47,48,59,66} However, the data from the CZP trial were not included in the analysis as the biologic-experienced population in the RAPID-PsA trial is not comparable to that in the other two trials^{48,59,66} (see *Psoriatic Arthritis Response Criteria response, Subpopulation: biologic experienced*). The data included in the NMA for treatment-experienced patients are presented in *Table 48*.

Outcome data at 24-week were included in the analysis and assumed equivalent to outcomes at 12 weeks [see *Appendix 3, Data used for the ustekinumab (PSUMMIT) trials*]. The observed data indicate that, as in the treatment-naive subgroup, HAQ-DI changes conditional on PsARC response do vary by treatments. The observed HAQ-DI changes conditional on PsARC response and non-response in placebo arms differ between trials. The observed HAQ-DI changes conditional on PsARC response and non-response with treatments are greater than placebo in all trials.

The NMA conducted for the synthesis of data in the biologic-experienced population is equal to that implemented in the treatment-naive population: treatment effects are assumed to be independent and the model assumed fixed effects across trials. No class effect assumption was made for this subgroup analysis. The results are presented as absolute changes in HAQ-DI score in relation to baseline (*Table 49*). These results are generally comparable with the observed estimates from the primary studies.

The results from the independent treatment effects model found that significant reductions in mean HAQ-DI score were achieved with response to SEC and UST, and response to placebo. As for the biologic-naive patients, those who responded to placebo achieved a lower level of improvement in the HAQ-DI score than those who responded to active treatments. Furthermore, the improvement in responders to placebo is below the minimally important difference for PsA of -0.35 .¹¹⁶

Psoriasis Area and Severity Index response

Subpopulation: biologic naive

Data

For the biologic-naive population, PASI response data were available for nine active treatments (150 mg of SEC, 300 mg of SEC, CZP, UST, GOL, ADA, INF, ETN and APR) from 13 trials⁴⁷⁻⁶⁷ (see *Table 2*). A brief

TABLE 47 Network meta-analysis results of HAQ-DI score changes (median) conditional on PsARC response and non-response in the biologic-naive subpopulation

Treatment	Independent treatment		Exchangeable I class {ILs, TNFs, APR}		Equal I class {ILs, TNFs, APR}		PsARC response vs. non-response					
	FE		FE		FE		E1	r ^b	E2 ^a	r ^b	E3	r ^b
Study	PsARC response	PsARC non-response	PsARC response	PsARC non-response	PsARC response	PsARC non-response	E1	r ^b	E2 ^a	r ^b	E3	r ^b
Placebo	-0.26		-0.26		-0.25		-0.26	10	-0.26	10	-0.25	4
150 mg of SEC	-0.39	-0.08	-0.44	-0.09			-0.31	8	-0.35	8		
300 mg of SEC	-0.55	-0.05	-0.51	-0.08	-0.47	-0.08	-0.49	1	-0.43	3	-0.39	1
UST	-0.49	-0.10	-0.48	-0.09			-0.39	4	-0.39	4		
CZP	-0.43	-0.07	-0.47	-0.12			-0.36	6	-0.35	7		
GOL	-0.44	-0.06	-0.49	-0.11	-0.52	-0.13	-0.38	5	-0.37	5	-0.39	1
ADA	-0.49	-0.13	-0.50	-0.13			-0.36	7	-0.37	6		
INF	-0.66	-0.20	-0.60	-0.14			-0.46	2	-0.46	1		
ETN	-0.64	-0.20	-0.59	-0.14			-0.44	3	-0.45	2		
APR	-0.36	-0.09	-0.36	-0.09	-0.36	-0.09	-0.27	9	-0.27	9	-0.27	3
DIC	-126.0		-133.0		-131.4							

FE, fixed effect.

a Shrunken estimates.

b Ranking of treatments according to point estimates.

TABLE 48 The HAQ-DI score changes conditional on PsARC response and non-response by trials and treatments in the biologic-experienced subpopulation: observed data

Trial	Treatment	HAQ-DI changes conditional on PsARC response				HAQ-DI changes conditional on PsARC non-response			
		Treatment arm		Placebo arm		Treatment arm		Placebo arm	
		Mean	SE	Mean	SE	Mean	SE	Mean	SE
FUTURE 2 ⁴⁸	300 mg of SEC	Confidential information has been removed	Confidential information has been removed	Confidential information has been removed	Confidential information has been removed	Confidential information has been removed	Confidential information has been removed	Confidential information has been removed	Confidential information has been removed
PSUMMIT 2 ^{59,66}	UST	-0.315	0.11	-0.146	0.09	0.007	0.13	0.010	0.05

TABLE 49 Network meta-analysis results of evidence synthesis of HAQ-DI changes conditional on PsARC response and non-response in biologic-experienced subpopulation

Treatment	HAQ-DI changes in PsARC response in relation to PNR			HAQ-DI changes in PsARC non-response in relation to PNR		
	Mean	Median	95% CrI	Mean	Median	95% CrI
Placebo/baseline effect	-0.134	-0.134	-0.288 to 0.021			
300 mg of SEC	-0.385	-0.385	-0.624 to -0.145	-0.431	-0.430	-0.880 to 0.014
UST	-0.320	-0.320	-0.552 to -0.086	0.003	0.002	-0.269 to 0.274
DIC	-8.10					

PNR, placebo non-responder.

summary of PASI responses in different trials is presented in *Table 50*. Outcomes at 14 and 16 weeks were included in the analysis and assumed to be equivalent to outcomes at 12 weeks. Data from the 12-week time point were used for the two PSUMMIT trials. Not all patients who were randomised to trials were eligible for the PASI evaluation, and the proportion of PASI-evaluable patients differed between trials, ranging between 42% and 84% in treatment arms and between 31% and 87% in placebo arms. All trials reported PASI 50 and PASI 75, except the PSUMMIT 2 and SPIRIT-P1 (Study of Ixekizumab in Participants With Active Psoriatic Arthritis) trials,^{57,59,66,67} which did not report PASI 50. A few trials did not report PASI 90 (i.e. the PALACE trials,^{60,61,65} Mease *et al.*⁵³ and PSUMMIT 2^{59,66}).

Methods

The NMA for PASI utilised a framework of analysis that evaluated the probability of PASI responses in different categories of PASI thresholds (50/75/90) within a single model.¹¹⁷ The single model included all categories of PASI and generated a single effect estimate for each treatment and also probabilities of achieving PASI 50, PASI 75 and PASI 90.

Reflecting the analyses on PsARC, alternative assumptions were tested in two analyses. The first analysis assumed independent treatment effects and did not include any metaregression for placebo effects (model F1). As the number of trials to inform each treatment effect was small, a fixed-effect model was used. In a second analysis, we explored the impact on treatment effects of adjusting for placebo responses [i.e. baseline effects (metaregression model)]. As can be seen in *Table 50*, there were large differences between trials for PASI responses in the placebo arms, ranging between 0% (in IMPACT⁵¹) and 27% (in RAPID-PsA⁴⁷). The IMPACT⁵¹ had a very small sample size and reported 0% response in the placebo arm and 100% response in the treatment arm, which lead to very extreme values for placebo adjustment. Therefore, IMPACT⁵¹ could not be included in the metaregression analysis. Unlike the analysis for PsARC, for PASI, we did not assume a class effect as the evidence from individual trials does not support such an assumption. *Table 51* presents the key assumptions for the models implemented for the PASI response. The detailed model assumptions are presented in *Appendix 3, Detailed methods for the biologic-naive subpopulation*.

Model F1 considers that treatments are independent of each other and assumes fixed effects on cut-off points/thresholds. Model G1 considers the same assumption as model F1, but IMPACT⁵¹ was excluded from the analysis. Model G2 assumes that treatments are independent of each other, but treatment effects are adjusted with the trial-specific baseline effects assuming a common interaction term (beta).

Network meta-analysis results

Table 52 presents the results of the treatment effects for the PASI responses estimated from the three models with measures of goodness of fit. There were no issues with convergence.

TABLE 50 Summary of trial-specific data in the biologic-naive subpopulation for PASI response outcome

Trial	Treatment	PASI evaluated: <i>n</i> (%) of patients randomised to treatment	PASI responses in treatment arm, <i>n</i> (%)			PASI evaluated: <i>n</i> (%) of patients randomised to placebo	PASI responses in placebo arm, <i>n</i> (%)		
			PASI 50	PASI 75	PASI 90		PASI 50	PASI 75	PASI 90
FUTURE 2 ⁴⁸	300 mg of SEC	Confidential information has been removed	Confidential information has been removed	Confidential information has been removed	Confidential information has been removed	Confidential information has been removed	Confidential information has been removed	Confidential information has been removed	Confidential information has been removed
FUTURE 2 ⁴⁸	150 mg of SEC	Confidential information has been removed	Confidential information has been removed	Confidential information has been removed	Confidential information has been removed				
RAPID-PsA ⁴⁷	CZP	Confidential information has been removed	Confidential information has been removed	Confidential information has been removed	Confidential information has been removed	Confidential information has been removed	Confidential information has been removed	Confidential information has been removed	Confidential information has been removed
PSUMMIT 1 ⁵⁸	UST	145 (71)	89 (61)	56 (39)	28 (19)	146 (71)	31 (21)	13 (9)	6 (4)
GO-REVEAL ⁵⁰	GOL	109 (75)	63 (58)	44 (40)	22 (20)	79 (70)	7 (9)	2 (3)	0 (0)
ADEPT ⁵⁵	ADA	69 (45)	50 (72)	34 (49)	21 (30)	69 (43)	10 (14)	3 (4)	0 (0)
IMPACT 2 ⁵²	INF	83 (83)	68 (82)	53 (64)	34 (41)	87 (87)	8 (9)	2 (2)	0 (0)
IMPACT ⁵¹	INF	22 (42)	22 (100)	15 (68)	8 (36)	16 (31)	0 (0)	0 (0)	0 (0)
Mease <i>et al.</i> 2000 ⁵³	ETN	19 (63)	8 (42)	5 (26)	NA	19 (63)	4 (21)	0 (0)	NA
PALACE 1 ^{60,61}	APR	82 (49)	36 (44)	18 (22)	NA	68 (40)	11 (16)	3 (4)	NA
PALACE 2 ^{61,62}	APR	77 (48)	33 (43)	17 (22)	NA	74 (47)	10 (14)	2 (3)	NA
PALACE 3 ^{61,65}	APR	90 (54)	38 (42)	20 (22)	NA	89 (53)	22 (25)	7 (8)	NA
SPIRIT-P1 ^{57,67}	ADA	68 (67)	NA	23 (34)	15 (22)	67 (63)	NA	5 (7)	1 (1)
PSUMMIT 2 ^{59,66}	UST	36 (84)	NA	17 (47)	NA	30 (71)	NA	1 (3)	NA

NA, not available.

TABLE 51 Summary of models implemented for evidence synthesis of the PASI response

Sets of analyses	Study	Treatment	Metaregression	Thresholds (i.e. cut-off points)	Baseline effect for metaregression
F1	FE	Independent	No baseline adjustment	FE	–
G1	FE	Independent	No baseline adjustment	FE	–
G2	FE	Independent	Common interaction term with baseline effect	FE	Adjusted with trial-specific baseline effects

FE, fixed effect.

TABLE 52 Network meta-analysis results of the PASI response: treatment effects (median) on a probit scale in the biologic-naïve subpopulation

Placebo-adjusted metaregression	No	No	Yes			
Treatments	Independent	Independent	Independent			
Cut-off points	FE	FE	FE			
	F1	r^a	G1	r^a	G2	r^a
Placebo	1.024	–	0.983	–	1.015	–
300 mg of SEC	–1.936	2	–1.932	2	–1.864	1
150 mg of SEC	–1.870	3	–1.865	3	–1.798	2
CZP	–0.875	7	–0.873	7	–1.424	4
UST	–1.134	6	–1.131	6	–1.342	6
GOL	–1.645	4	–1.635	4	–1.141	7
ADA	–1.477	5	–1.476	5	–1.422	5
INF	–2.412	1	–2.276	1	–1.798	2
ETN	–0.798	8	–0.797	8	–0.849	8
APR	–0.749	9	–0.748	9	–0.815	9
Beta	–	–	–	–	–1.310	–
Residual deviance	76.6 ^b	–	62.5 ^c	–	58.4 ^c	–
DIC	318.9	–	297.2	–	293.7	–

FE, fixed effect.

a Ranking of treatments according to point estimates.

b Compared 65 data points.

c Compared 61 data points.

The results of models G1 and F1 are similar, except for a small effect on the estimate of effect for INF; therefore, model F1 is the preferred unadjusted model, as it does not exclude any trial evidence. In model G2, the DIC and residual deviance are lower than in model G1, indicating that the model fits well with the existing data and the data support the assumption of adjustment with baseline effects.

Table 53 shows the probability of achieving PASI 50, PASI 75 and PASI 90 from the preferred treatment-unadjusted and -adjusted model in the biologic-naïve population.

TABLE 53 Network meta-analysis results of the PASI response: probability of achieving PASI 50, PASI 75 and PASI 90 in the biologic-naive subpopulation

Treatment	Independent treatment, median probability of achieving response (95% CrI)					
	Unadjusted for placebo response (model F1)			Adjusted for placebo response (model G2)		
	PASI 50	PASI 75	PASI 90	PASI 50	PASI 75	PASI 90
Placebo	0.153 (0.13 to 0.18)	0.054 (0.04 to 0.07)	0.015 (0.01 to 0.02)	0.155 (0.12 to 0.19)	0.055 (0.04 to 0.07)	0.016 (0.01 to 0.02)
300 mg of SEC	0.819 (0.61 to 0.94)	0.627 (0.38 to 0.84)	0.405 (0.19 to 0.67)	0.801 (0.62 to 0.91)	0.604 (0.40 to 0.78)	0.384 (0.21 to 0.58)
150 mg of SEC	0.801 (0.59 to 0.93)	0.603 (0.36 to 0.82)	0.380 (0.18 to 0.63)	0.783 (0.60 to 0.90)	0.579 (0.38 to 0.75)	0.359 (0.19 to 0.54)
CZP	0.441 (0.31 to 0.59)	0.231 (0.14 to 0.36)	0.097 (0.05 to 0.18)	0.657 (0.50 to 0.82)	0.429 (0.29 to 0.63)	0.231 (0.13 to 0.41)
UST	0.544 (0.44 to 0.65)	0.317 (0.23 to 0.42)	0.149 (0.09 to 0.22)	0.627 (0.52 to 0.74)	0.398 (0.30 to 0.52)	0.207 (0.14 to 0.31)
GOL	0.732 (0.58 to 0.86)	0.514 (0.35 to 0.68)	0.297 (0.17 to 0.47)	0.548 (0.36 to 0.70)	0.322 (0.17 to 0.48)	0.154 (0.07 to 0.27)
ADA	0.675 (0.55 to 0.78)	0.448 (0.32 to 0.58)	0.242 (0.15 to 0.36)	0.657 (0.54 to 0.76)	0.429 (0.32 to 0.55)	0.231 (0.15 to 0.33)
INF	0.918 (0.84 to 0.96)	0.789 (0.67 to 0.88)	0.593 (0.44 to 0.73)	0.782 (0.61 to 0.88)	0.578 (0.39 to 0.73)	0.358 (0.20 to 0.52)
ETN	0.411 (0.15 to 0.72)	0.209 (0.05 to 0.50)	0.084 (0.01 to 0.29)	0.434 (0.20 to 0.69)	0.227 (0.08 to 0.47)	0.095 (0.02 to 0.26)
APR	0.391 (0.31 to 0.49)	0.195 (0.14 to 0.27)	0.077 (0.05 to 0.12)	0.420 (0.33 to 0.52)	0.216 (0.16 to 0.30)	0.090 (0.06 to 0.14)

The results of the unadjusted NMA for the PASI, as a single outcome or as separate categorical variables, show that all treatments are more effective than placebo. The difference between treatments is uncertain, with wide CrIs that mostly overlap with each other. The results show that patients taking INF have the highest probability of achieving PASI 50, PASI 75 and PASI 90 responses. However, after adjustment for placebo, 300 mg of SEC has the highest probability of response. The probabilities for CZP changed between the models. It appears to be less efficacious than all other treatments, except APR and ETN, in achieving PASI responses in the unadjusted model. However, in the adjusted model, it appears to be more efficacious than GOL, UST, APR and ETN, and similar to ADA. The estimated probabilities from the analysis reflect fairly closely those from the primary studies, indicating that the model fits the data well.

Subpopulation: biologic experienced

For the biologic-experienced population, trial-specific PASI response data were available for three active treatments (300 mg of SEC, CZP and UST) from three trials,^{47,48,59,66} but, as for the other outcomes, the data from the CZP trial were not included in the analysis as the biologic-experienced population in the RAPID-PsA trial⁴⁷ is not comparable to the population in the other two trials^{48,59,66} (see *Psoriatic Arthritis Response Criteria response, Subpopulation: biologic experienced*). The data included in the NMA for the treatment-experienced patients are presented in *Table 54*.

In the FUTURE 2 trial,⁴⁸ only a small proportion of patients were eligible for the PASI evaluations; 33% in the treatment arm and 34% in the placebo arm. The small sample size and associated lack of events in this placebo arm increase uncertainty in the analysis.

A NMA was conducted under the same specification as used in model F1 (independent treatments, unadjusted biologic-naive analysis). Because the data were sparse, no adjustment was undertaken for this subgroup analysis. The results of the analysis are presented in *Table 55*.

TABLE 54 Summary of trial-specific data in the biologic-experienced subpopulation for PASI response outcome

Trial	Treatment	PASI evaluated: <i>n</i> (%) of patients randomised to treatment	PASI responses in treatment arm, <i>n</i> (%)			PASI evaluated: <i>n</i> (%) of patients randomised to placebo	PASI responses in placebo arm, <i>n</i> (%)		
			PASI 50	PASI 75	PASI 90		PASI 50	PASI 75	PASI 90
FUTURE 2 ⁴⁸	300 mg of SEC	Confidential information has been removed	Confidential information has been removed	Confidential information has been removed	Confidential information has been removed	Confidential information has been removed	Confidential information has been removed	Confidential information has been removed	Confidential information has been removed
PSUMMIT 2 ^{59,66}	UST	44 (73)	NA	14 (32)	NA	50 (81)	NA	1 (2)	NA
NA, not available.									

TABLE 55 Network meta-analysis results of the PASI response: probability of achieving PASI 50, PASI 75, PASI 90 and treatment effects in the biologic-experienced subpopulation

Treatment/parameter	Treatment effects on a probit scale, median (95% CrI)	Response, median probability of achieving response (95% CrI)		
		PASI 50	PASI 75	PASI 90
Placebo	1.354 (0.59 to 2.19)	0.088 (0.01 to 0.28)	0.012 (0.00 to 0.06)	0.002 (0.00 to 0.02)
300 mg of SEC	-2.509 (-4.01 to -1.23)	0.875 (0.46 to 1.00)	0.598 (0.23 to 0.89)	0.365 (0.08 to 0.75)
UST	-1.659 (-2.73 to -0.83)	0.628 (0.29 to 0.89)	0.279 (0.07 to 0.61)	0.120 (0.01 to 0.42)
PASI 50	–			
PASI 75	0.870 (0.28 to 1.84)			
PASI 90	1.484 (0.70 to 2.56)			
Residual deviance ^a	5.99			
DIC	26.75			

– not available.
a Compared six data points.

The result shows that the probability of achieving a PASI response in all categories is much higher with SEC than with UST, although the estimates are highly uncertain, with wide CrIs that overlap with each other. The results are fairly comparable with observed data.

American College of Rheumatology response

Subpopulation: biologic naive

Data

For the biologic-naive population, evidence on ACR response was available for nine active treatments (150 mg of SEC, 300 mg of SEC, UST, CZP, GOL, ADA, INF, ETN and APR) from 15 trials.^{47,48,50–61,65–67}

A brief summary of the ACR responses in the different trials is presented in *Table 56*. Outcomes at 14 and 16 weeks were included in the analysis and assumed to be equivalent to outcomes at 12 weeks. All 15 trials reported all three categories of ACR response (20/50/70).

Methods

As ACR is, like PASI, a categorical variable (ACR 20, ACR 50 and ACR 70), the NMA for ACR utilised a similar framework of analysis to that used to estimate the probability of PASI responses: all categories of ACR were within a single model which generated a single effect estimate for each treatment and also probabilities of achieving an ACR 20, ACR 50 and ACR 70.

Analogously to the analyses on PsARC, sets of alternative analyses were conducted for ACR response outcomes. We explored the effect of differences in trial-specific placebo responses on treatment effect by undertaking a metaregression. In the context of an adjusted model for placebo response, we explored the possibility of there being class effects. Three different class groupings were considered: all treatments as a single class; all biologics as a class with APR separate; and, to reflect the pharmacology, anti-TNFs grouped, ILs grouped and APR separate. In addition, we explored two within-class assumptions: assuming treatments within a class to have equal effectiveness and, alternatively, assuming that those treatments within a class have similar (exchangeable) effectiveness. Fixed effects across studies were assumed for all models. We have not considered models assuming exchangeability between classes.

TABLE 56 Summary of trial-specific data in the biologic-naive subpopulation for ACR response outcome

Trial	Treatment	ACR responses													
		Treatment arm							Placebo arm						
		<i>n</i> ^a	<i>r</i> ^b	%	<i>r</i> ^b	%	<i>r</i> ^b	%	<i>n</i> ^a	<i>r</i> ^b	%	<i>r</i> ^b	%	<i>r</i> ^b	%
FUTURE 2 ⁴⁸	300 mg of SEC	Confidential information has been removed	Confidential information has been removed	Confidential information has been removed	Confidential information has been removed	Confidential information has been removed	Confidential information has been removed	Confidential information has been removed	Confidential information has been removed	Confidential information has been removed	Confidential information has been removed	Confidential information has been removed	Confidential information has been removed	Confidential information has been removed	Confidential information has been removed
FUTURE 2 ⁴⁸	150 mg of SEC	Confidential information has been removed	Confidential information has been removed	Confidential information has been removed	Confidential information has been removed	Confidential information has been removed	Confidential information has been removed	Confidential information has been removed	Confidential information has been removed	Confidential information has been removed	Confidential information has been removed	Confidential information has been removed	Confidential information has been removed	Confidential information has been removed	Confidential information has been removed
PSUMMIT 1 ⁵⁸	UST	205	85	41	38	19	8	4	206	44	21	11	5	3	1
PSUMMIT 2 ^{59,66}	UST	43	17	40	5	12	3	7	42	8	19	3	7	1	2
RAPID-PsA ⁴⁷	CZP	Confidential information has been removed	Confidential information has been removed	Confidential information has been removed	Confidential information has been removed	Confidential information has been removed	Confidential information has been removed	Confidential information has been removed	Confidential information has been removed	Confidential information has been removed	Confidential information has been removed	Confidential information has been removed	Confidential information has been removed	Confidential information has been removed	Confidential information has been removed
GO-REVEAL ⁵⁰	GOL	146	74	51	44	30	18	12	113	10	9	2	2	1	1
Genovese <i>et al.</i> , 2007 ⁵⁶	ADA	51	20	39	13	25	7	14	51	8	16	1	2	0	0
ADEPT ⁵⁵	ADA	153	88	58	54	35	30	20	162	23	14	6	4	1	1
SPIRIT-P1 ^{57,67}	ADA	101	52	51	30	30	18	18	106	33	31	5	5	0	0
IMPACT 2 ⁵²	INF	100	58	58	36	36	15	15	100	11	11	3	3	1	1
IMPACT ⁵¹	INF	52	34	65	24	46	15	29	52	5	10	0	0	0	0
Mease <i>et al.</i> , 2004 ⁵⁴	ETN	101	60	59	38	38	11	11	104	16	15	4	4	0	0
Mease <i>et al.</i> , 2000 ⁵³	ETN	30	22	73	15	50	4	13	30	4	13	1	3	0	0
PALACE 1 ^{60,61}	APR	168	64	38	27	16	7	4	168	32	19	10	6	2	1
PALACE 2 ^{61,65}	APR	162	52	32	17	10	2	1	159	30	19	8	5	1	1
PALACE 3 ^{61,65}	APR	167	68	41	25	15	6	4	169	31	18	14	8	4	2

a Number randomised.
b Number of ACR responses.

Summary of all treatment effect models explored

All models implemented for the evidence synthesis of an ACR response are presented in *Table 57*. Detailed coding of the models is presented in *Appendix 3, Detailed methods for the biologic-naïve subpopulation*.

Model H1 considers that the treatments are independent of each other. Model I1 considers the relative effectiveness of the alternative treatments as independent of each other, but that they all depend on the response in the placebo arm. Model J1 considers the treatments as equal in terms of their effectiveness, but dependent on the effect of the placebo arm. Models J2 and J3 consider the treatments as equal in terms of their effectiveness within class, but dependent on the effect of the placebo arm. Models K1 and K2 assume the treatments to have a similar, but not equal, effectiveness and to be dependent on the effect of the placebo arm.

Network meta-analysis results

Table 58 presents the results of the treatment effects for ACR responses estimated from the seven models with measures of goodness of fit. There were no issues with convergence.

The placebo response-adjusted model I1 fits well compared with the unadjusted model H1 (smaller DIC and residual deviance), but is not significantly better. In addition, the results (rankings) generated by model I1 are very different from the observed trial results. Models J1, J2 and J3 do not fit well with the existing data, resulting in a significantly higher residual deviance and DIC. Both models K1 and K2 fit as well as the unadjusted model H1 (similar DIC and residual deviance).

Among all the placebo response-adjusted models, models I1, K1 and K2 show similar DIC and residual deviance, which means that these three models fit the existing data equally well, although not significantly better than the unadjusted model.

The interaction term (beta) is negative in all models, which means that higher placebo response rates in trials are associated with higher treatment effects, demonstrating that adjustment for heterogeneity in the placebo responses across trials was required. The interaction term varies between models, but is similar between models K1 and K2.

TABLE 57 Key assumptions of models implemented for evidence synthesis of ACR response

Sets of analysis	Study	Treatment	Metaregression	Class
H1	FE	Independent	No baseline adjustment	No class effect
I1	FE	Independent	Common interaction term with baseline effect	No class effect
J1	FE	Equal I class	Common interaction term with baseline effect	Independent class effect: class = {all treatments}
J2	FE	Equal I class, remaining treatments independent ^a		Independent class effect: class = APR independent {all remaining biologics}
J3	FE	Equal I class, remaining treatments independent ^a		Independent class effect: class = {anti-TNFs, ILs}; APR independent
K1	FE	Exchangeable I class, remaining treatments independent ^a	Common interaction term with baseline effect	Independent class effect: class = APR independent {all other biologics}
K2	FE	Exchangeable I class, remaining treatments independent ^a		Independent class effect: class = {anti-TNFs, ILs}; APR independent

FE, fixed effect.

^a APR independent.

TABLE 58 Network meta-analysis results of ACR response: treatment effects (median) on a probit scale in a biologic-naive subpopulation

Placebo-adjusted metaregression	No	Yes	Yes	Yes	Yes	Yes	Yes	Yes						
Treatments	Ind	Ind	= I class {all}	= I class {APR, other}	= I class {ILs, TNFs, APR}	~ I class ^a (APR, other)	~ I class ^a (ILs, TNFs, APR)							
Cut-off points	FE	FE	FE	FE	FE	FE	FE	FE						
	H1	r ^b	I1	r ^b	J1	r ^b	J2	r ^b	J3	r ^b	K1	r ^b	K2	r ^b
Placebo	0.952		0.961		0.882		0.966		0.966		0.963		0.961	
300 mg of SEC	-0.914	6	-1.397	2							-1.274	2	-1.236	3
150 mg of SEC	-0.932	5	-1.415	1			-1.094	1	-1.095	1	-1.283	1	-1.246	2
UST	-0.570	8	-0.722	8							-0.750	8	-0.732	8
CZP	-0.811	7	-1.265	3	-0.830	1					-1.193	5	-1.176	5
GOL	-1.429	2	-0.918	7							-1.010	7	-1.040	7
ADA	-1.072	4	-1.126	6					-0.609	2	-1.121	6	-1.124	6
INF	-1.617	1	-1.212	5							-1.246	3	-1.269	1
ETN	-1.362	3	-1.214	4							-1.215	4	-1.228	4
APR	-0.509	9	-0.592	9			-0.610	2	-0.014	3	-0.581	9	-0.576	9
Beta (mean)			-1.276		1.327		-1.627		-1.621		-1.099		-1.018	
Residual deviance ^c	120.0		119.1		156.1		148.3		148.3		120.0		120.4	
DIC	482.22		480.94		511.66		503.43		503.37		480.90		481.1	

= I class, equal class effect; ~ I class, exchangeable class effect; FE, fixed effect; ind, independent treatment effect.

a Shrunken estimates.

b Ranking of active treatments according to point estimates.

c Compared with 92 data points.

Preferred models

The unadjusted model, H1, fits the data as well as any of the other models and generates results that reflect the observed results. Considering the placebo-adjusted models, model I1-generated results (rankings) are very different from the observed trial results and the results generated by model H1. Using an assumption of equal class effect for the treatments does not produce a better-fitting model (models J1, J2, J3) than assuming independent treatment effects (models H1, I1), or similar (exchangeable) treatment effects (models K1, K2). In addition, there was a little difference in the goodness-of-fit statistics (DIC and residual deviance) between models K1 and K2, and we consider the exchangeable class effect model, which utilised two classes (anti-ILs and anti-TNFs) with APR separate, to be the most clinically plausible. Hence, our preferred models are models H1 and K2. Note that the economic model uses PsARC; thus, these results were not implemented in the economic model in *Chapter 6*.

Table 59 presents the probabilities of achieving ACR 20, ACR 50 and ACR 70 responses in a biologic-naive population from the preferred models, H1 and K2.

The results of the unadjusted NMA for ACR, as a single outcome or as separate categorical variables, show that all treatments are more effective than placebo. The difference between treatments is uncertain, with wide CrIs that mostly overlap with each other. The results show that patients taking INF have the highest probability of achieving ACR 20, ACR 50 and ACR 70 responses. The probabilities for SEC are

TABLE 59 Network meta-analysis results of ACR response: probability of achieving ACR 20, ACR 50 and ACR 70 responses in a biologic-naive subpopulation

Treatment	Not adjusted for placebo response, independent treatment (model H1)			Adjusted for placebo response, class effects assumed ^a (model K2)		
	ACR 20, median (95% CrI)	ACR 50, median (95% CrI)	ACR 70, median (95% CrI)	ACR 20, median (95% CrI)	ACR 50, median (95% CrI)	ACR 70, median (95% CrI)
Placebo	0.17 (0.15 to 0.19)	0.05 (0.04 to 0.06)	0.01 (0.01 to 0.02)	0.17 (0.15 to 0.19)	0.05 (0.04 to 0.06)	0.01 (0.01 to 0.02)
300 mg of SEC	0.49 (0.33 to 0.64)	0.24 (0.14 to 0.38)	0.09 (0.04 to 0.18)	0.61 (0.46 to 0.75)	0.35 (0.22 to 0.50)	0.16 (0.08 to 0.27)
150 mg of SEC	0.49 (0.34 to 0.65)	0.25 (0.14 to 0.39)	0.10 (0.04 to 0.19)	0.61 (0.46 to 0.75)	0.35 (0.22 to 0.51)	0.16 (0.08 to 0.27)
UST	0.35 (0.27 to 0.44)	0.15 (0.10 to 0.21)	0.05 (0.03 to 0.08)	0.41 (0.34 to 0.49)	0.19 (0.14 to 0.25)	0.07 (0.04 to 0.10)
CZP	0.44 (0.34 to 0.55)	0.21 (0.14 to 0.30)	0.08 (0.04 to 0.13)	0.58 (0.49 to 0.69)	0.33 (0.24 to 0.43)	0.14 (0.09 to 0.22)
GOL	0.68 (0.55 to 0.80)	0.43 (0.30 to 0.57)	0.21 (0.12 to 0.33)	0.53 (0.40 to 0.66)	0.28 (0.18 to 0.40)	0.11 (0.06 to 0.19)
ADA	0.55 (0.47 to 0.62)	0.29 (0.23 to 0.36)	0.12 (0.09 to 0.17)	0.56 (0.50 to 0.63)	0.31 (0.26 to 0.37)	0.13 (0.10 to 0.17)
INF	0.75 (0.65 to 0.83)	0.50 (0.39 to 0.62)	0.27 (0.18 to 0.38)	0.62 (0.51 to 0.72)	0.36 (0.26 to 0.47)	0.17 (0.10 to 0.24)
ETN	0.66 (0.55 to 0.76)	0.40 (0.29 to 0.52)	0.19 (0.12 to 0.29)	0.61 (0.51 to 0.69)	0.35 (0.27 to 0.43)	0.16 (0.11 to 0.21)
APR	0.33 (0.27 to 0.39)	0.13 (0.10 to 0.17)	0.04 (0.03 to 0.06)	0.35 (0.30 to 0.41)	0.15 (0.12 to 0.19)	0.05 (0.03 to 0.07)

a Probabilities estimated from the shrunken estimates.

lower than those for INF, ETN, GOL and ADA. After adjustment for placebo, the probabilities for 300 mg of SEC and 150 mg of SEC increase and are very similar to those for INF. The probabilities of achieving ACR 20, ACR 50 and ACR 70 responses with CZP varied between the models: in the unadjusted model the probabilities were higher than only those for APR and UST, but after adjustment they were also higher than those for GOL, ADA and UST.

Subpopulation: biologic experienced

For the biologic-experienced population, trial-specific ACR response data were available for three active treatments (300 mg of SEC, CZP and UST) from three trials,^{47,48,59,66} but, as for the other outcomes, the data from the CZP trial were not included in the analysis as the biologic-experienced population in the RAPID-PsA trial is not comparable to the populations of the other two trials.^{48,59,66} The data included in the NMA for treatment-experienced patients are presented in *Table 60*.

The NMA model was similar to model H1: independent treatment effects in the biologic-naive subpopulation. Owing to the lack of data, no adjustment was undertaken for this subgroup analysis.

The results of the analysis are presented in *Table 61* and show that the probabilities of achieving an ACR response in all categories are slightly higher with UST than with SEC, although the differences are insignificant. The results are fairly comparable to the observed data (compare *Tables 60* and *61*).

TABLE 60 Summary of trial-specific data in a biologic-experienced subpopulation for ACR response outcome

Trial	Treatment	ACR responses																	
		Treatment arm									Placebo arm								
		<i>n</i>	ACR 20			ACR 50			ACR 70			<i>n</i>	ACR 20			ACR 50			ACR 70
	1.1.1	<i>r</i>	%	1.1.2	<i>r</i>	%	<i>r</i>	%		1.1.3	<i>r</i>	%	1.1.4	<i>r</i>	%	1.1.5	<i>r</i>	%	
FUTURE 2 ⁴⁸	2, 300 mg of SEC	Confidential information has been removed	Confidential information has been removed	Confidential information has been removed	Confidential information has been removed	Confidential information has been removed	Confidential information has been removed	Confidential information has been removed	Confidential information has been removed	Confidential information has been removed	Confidential information has been removed	Confidential information has been removed	Confidential information has been removed	Confidential information has been removed	Confidential information has been removed	Confidential information has been removed	Confidential information has been removed	Confidential information has been removed	Confidential information has been removed
PSUMMIT 2 ^{59,66}	3, UST	60	23	38	9	15	4	7	62	9	15	1	2	0	0				

TABLE 61 Network meta-analysis results of ACR response: probability of achieving ACR 20, ACR 50 and ACR 70 responses, and treatment effects in a biologic-experienced subpopulation

Treatment/parameter	Treatment effects on a probit scale, median (95% CrI)	ACR response, median probability (95% CrI)		
		ACR 20	ACR 50	ACR 70
Placebo	1.06 (0.76 to 1.38)	0.14 (0.08 to 0.22)	0.03 (0.01 to 0.06)	0.01 (0.00 to 0.02)
300 mg of SEC	-0.71 (-1.36 to -0.08)	0.36 (0.19 to 0.57)	0.11 (0.04 to 0.25)	0.03 (0.01 to 0.11)
UST	-0.85 (-1.34 to -0.37)	0.42 (0.26 to 0.59)	0.14 (0.06 to 0.27)	0.05 (0.01 to 0.12)
ACR 20	-			
ACR 50	0.85 (0.62 to 1.13)			
ACR 70	1.47 (1.10 to 1.92)			
Residual deviance ^a	11.33			
DIC	45.85			

a Compared 11 data points.

Limitations

Data were sparse; there were few studies in each treatment [a maximum of three studies in two treatments (ADA^{55-57,67} and APR^{60,61,65})]. For this reason, we were not able to fit random-effect models, especially when considering placebo adjustment. Hence, fixed-effect models were used in all analyses.

Summary of findings of relative efficacy from network meta-analysis

The NMA was conducted to formally investigate the relative efficacy of SEC and CZP and the other active comparators. Analyses were conducted on four outcomes: PsARC, HAQ-DI conditional on PsARC response, PASI and ACR. Analyses were not run for the full-trial populations because of the heterogeneity across trials, but instead were performed separately for the biologic-naive and biologic-experienced subgroups. The data suggest the rate of placebo response to be a potential source of heterogeneity within the biologic-naive population networks, despite there being no clear rationale for such an effect. For this reason, we explored models that adjust for the placebo response, alongside unadjusted models.

Biologic-naive patients

In terms of PsARC response, the results indicated that, although SEC and CZP are effective, the relative effectiveness of these biologics compared with ETN, ADA, GOL and INF, and with each other, is uncertain, although both agents do seem to be more effective than APR.

In terms of HAQ-DI conditional on PsARC response, the results from the preferred adjusted model were similar to the independent treatment effect analysis. The results from the unadjusted independent treatment effects model showed that significant reductions in mean HAQ-DI score were achieved with response to all nine treatments and response to placebo, although the improvement in response to placebo is below the minimum clinically significant threshold for PsA of -0.35.¹¹⁶ The median HAQ-DI score change was highest with INF and ETN, followed by 300 mg of SEC, but 150 mg of SEC and CZP were worse than all treatments except for APR.

The results of the unadjusted NMA for PASI, as a single outcome or as separate categorical variables, indicated that all treatments were more effective than placebo. The difference between treatments was uncertain, with wide CrIs that mostly overlap with each other. The results showed that patients treated with INF have the highest probability of achieving PASI 50, PASI 75 and PASI 90 responses. However, after

adjustment for placebo, 300 mg of SEC has the highest probability of response. The probabilities for CZP changed between the models. It appears to be less efficacious than all other treatments, except APR and ETN, in achieving PASI responses in the unadjusted model. However, in the adjusted model, CZP appears to be more efficacious than GOL, UST, APR and ETN, and similar to ADA.

Similarly, for ACR responses, differences between treatments were uncertain, with wide CIs that mostly overlapped with each other. The unadjusted results suggested that patients taking SEC or CZP had lower probabilities of a response than those for INF, ETN, GOL and ADA. After adjustment for placebo response, the probabilities of a response for both SEC and CZP increased; those for SEC were very similar to those for INF.

Biologic-experienced patients

The evidence for the biologic-experienced subpopulation is very sparse with only two trials evaluating two treatments. Hence, only two treatments (SEC and UST) could be included in these analyses. The results showed that, across all outcomes analysed, both SEC and UST were significantly more effective than placebo. Most of the results suggested SEC may be better than UST, although the results were uncertain with wide overlapping CIs.

Chapter 5 Assessment of existing cost-effectiveness evidence

The purpose of this section is to review the existing evidence on the cost-effectiveness of CZP and SEC within their marketing authorisations for treating active PsA in adults for whom DMARDs have been inadequately effective. The review includes published cost-effectiveness studies and the CSs from Novartis (SEC) and UCB Pharma (CZP). The review also includes a broader assessment of published decision-analytic models for relevant comparators. The differences in the model structures and assumptions used across the studies are examined to identify any important differences in approaches and areas of remaining uncertainty. The findings from the review also provide the basis for the development of a new decision-analytic model reported in *Chapter 6*.

Methods

To identify published economic evidence for CZP and SEC, a broad range of studies was considered for inclusion in the assessment of cost-effectiveness, including economic evaluations conducted alongside trials, modelling studies and analyses of administrative databases. Only full economic evaluations that compared two or more options and considered both costs and consequences (including cost-effectiveness, cost-utility and cost-benefit analyses) were included.

A broader review of economic evidence for the comparator treatments (INF, ETN, ADA, GOL and UST) was also undertaken. The objective was to summarise the modelling approaches, and assumptions, employed in previous studies, and to identify any important differences that may have arisen since the previous MTA (TA199³³). As the focus of the broader review related to modelling approaches and assumptions, only decision-analytic modelling studies were included. The broader review also provides an important basis to identify common areas and potential differences between the approaches previously used for the comparator treatments and those employed by UCB Pharma and Novartis for the specific technologies being considered in this appraisal. The broader review also helped inform the conceptualisation of the de novo model presented in *Chapter 6*.

The following databases were searched for relevant published literature: Cochrane Controlled Trials Register, EMBASE, Health Economic Evaluations Databases, MEDLINE, National Research Register, NHS Economic Evaluation Database (NHS EED), PsycINFO and the SCI. The full details of the main search strategy for this review are presented in *Appendix 4*. The searches for CZP and SEC for PsA were not restricted by date. The searches for the broader comparator review were date restricted to identify studies published since the previous MTA report for ADA, ETN and INF (TA199³³). Additional hand-searching of related TAs (TA199,³³ TA220¹¹⁸ and TA340⁶⁶) was also undertaken. Two reviewers assessed all obtained titles and abstracts for inclusion, with any discrepancies resolved by discussion.

In addition, Novartis and UCB Pharma submitted evidence on the cost-effectiveness of CZP and SEC. These submissions were reviewed and the approaches and findings compared with those found in the review of previously published studies. The quality of the cost-effectiveness studies for CZP and SEC was also assessed according to a checklist updated from that developed by Drummond *et al.*¹¹⁹

Results

Identified published studies

No previously published cost-effectiveness studies of SEC for PsA were identified. Two conference abstracts were identified evaluating the cost-effectiveness of CZP for PsA in Greece and Romania.^{120,121} Further

details were not provided on request from the corresponding authors and so these abstracts were subsequently excluded from further consideration. Given the lack of previously published studies, only the CSs are considered for SEC and CZP.

The systematic search of published literature identified nine studies^{33–36,66,122–124} that met the inclusion criteria for the cost-effectiveness review for the broader set of comparators. From the nine studies, seven UK studies were identified.^{33–36,66,122} Three of the UK studies were reports from the independent AG/ERG for the previous NICE appraisals of ETN, INF and ADA (TA199³³), GOL (TA220¹¹⁸) and UST (TA340⁶⁶). A further three studies were the subsequent journal publications based on the reports for TA199,¹²² TA220³⁴ and TA340.³⁵ The final UK study identified was a more recent study that aimed to update the systematic review, synthesis and model previously conducted as part of TA199.¹²² This study was funded by Pfizer.³⁶

Of the two non-UK studies, one evaluated the cost-effectiveness of UST for PsA in Russia¹²³ and the other evaluated the cost-effectiveness of a mixture of biologic treatments to treat moderate–severe PsA in Germany.¹²⁴ Both of these studies were available only as conference abstracts. Further details were requested from the authors but were not provided and hence these two studies were excluded from the review.

Review of the existing published cost-effectiveness studies

The review starts with an overview of the seven UK studies identified in relation to the broader set of comparators and then considers the de novo analyses submitted by the companies for SEC and CZP.

Summary of published studies for comparator treatments

Of the seven published studies included in the broader review of comparators,^{33–36,66,122} six were directly related to three previous NICE TAs: TA199,³³ TA220¹¹⁸ and TA340.⁶⁶ All of these publications employed a similar modelling approach to that originally proposed by Rodgers *et al.*³³ for TA199 (hereafter referred to as the 'York model'). The only study identified that was not directly related to a previous NICE TA was that by Cawson *et al.*³⁶ This study also used a very similar approach to the previous York model. Hence, the main differences between these studies lie in relation to the comparators and associated evidence base which have altered since TA199, rather than in terms of major structural differences. As the provenance of the modelling approach used in all these studies can be related back to the York model, only the York model is described in full in the following section. The key differences in the other published studies are subsequently summarised.

Summary of the York model (TA199)

The York model is a cohort Markov model (*Figure 8*), built using the R software package (The R Foundation for Statistical Computing, Vienna, Austria). The model was developed to estimate the costs and quality-adjusted life-years (QALYs) of three biologics (ETN, INF or ADA), over a lifetime horizon (40 years), compared with palliative care alone. The model adopts the perspective of the UK NHS and Personal Social Services. The price year assumed for costs is 2008/9 and the annual discount rate is 3.5%,¹²⁵ for both costs and QALYs.

The model structure is based on an understanding of the disease process and how this should be modelled to determine cost-effectiveness.¹²⁶ The model is based on a two part structure:

1. initial response period (short-term model used to determine initial response rate and treatment continuation decision)
2. post-response period [longer-term model used to characterise the natural history of the disease (i.e. without biologics) and the impact of biologics while on therapy and when therapy is stopped].

Patients receiving biologics and who meet the response criteria during the initial response period continue on their biologic treatment in the post-response period. Biologics are withdrawn in non-responders and these patients are assumed to move on to palliative care alone. Changes in the HAQ-DI and PASI scores are used to quantitatively model the short- and longer-term cost and quality-of-life implications (estimated using QALYs) of the use of biologics versus palliative care alone.

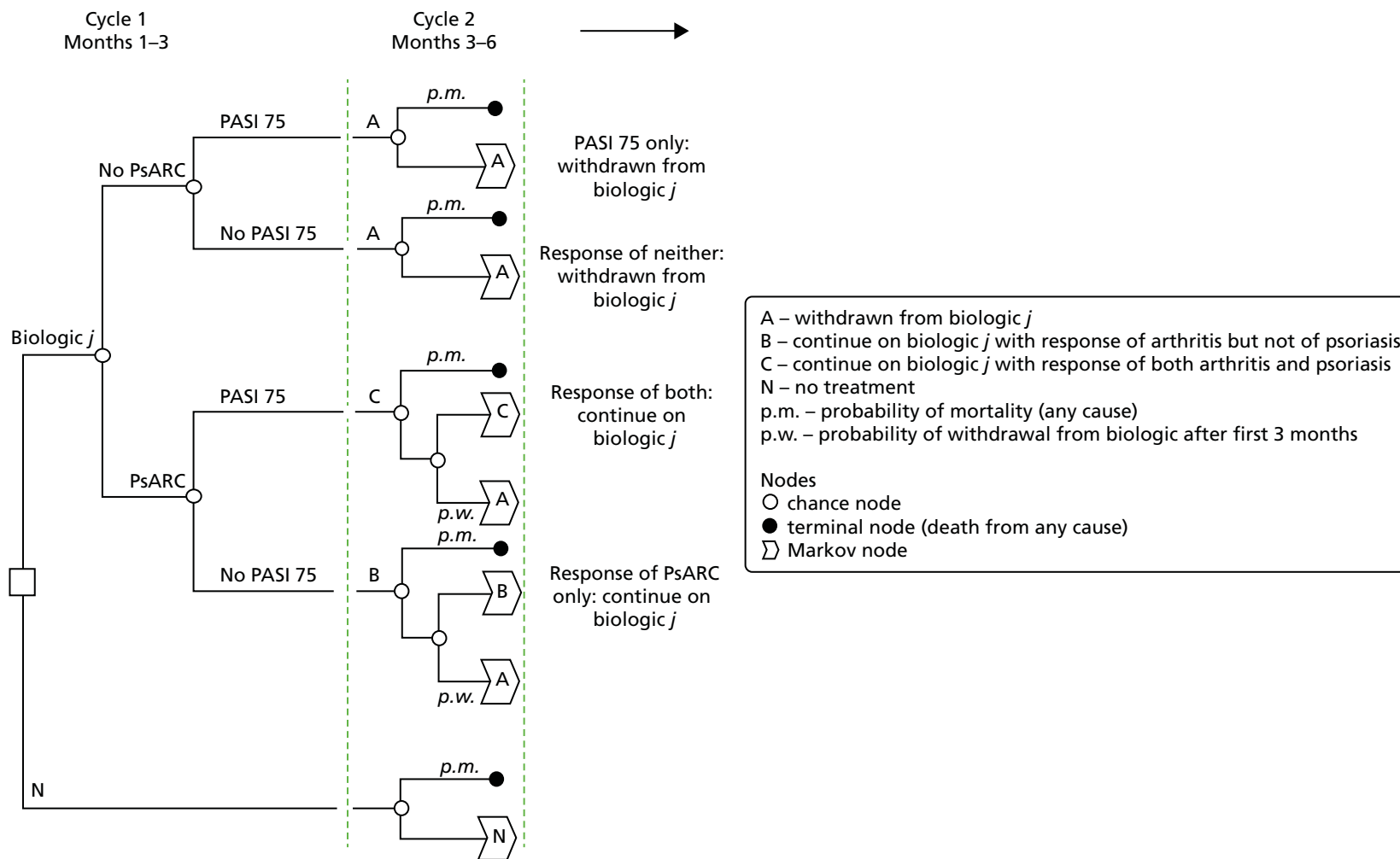

FIGURE 8 Schematic of the York model.³³

Initial (primary) response to the drug is defined using PsARC for joints and the PASI 75 for psoriasis, based on BSR¹²⁷ and British Association of Dermatologists¹²⁸ guidelines. As two response variables are considered (PsARC and PASI), there are four possible outcomes in the initial response period: (1) skin response only; (2) joints response only; (3) response of both; and (4) response of neither. In the base-case analysis, only joint (PsARC) response is used to determine treatment continuation. Alternative response rules are explored in separate scenarios: skin (PASI 75) response only, and response for both measures (PsARC and PASI 75).

The time point for the assessment of response is assumed to occur at 'around 3 months' or between 12 and 16 weeks. Although differences in the recommended time points for assessing initial response were identified by the authors based on the licences and between guideline-making bodies, a common time point was subsequently assumed. This was justified based on the authors' conclusions that there appeared to be a lack of a clinically meaningful difference in the biologics' response rates for joint disease or psoriasis between approximately 12 and 24 weeks.

In the decision model, the change in HAQ-DI score compared with baseline is conditional on whether or not a PsARC response was achieved and the specific biologic treatment received. During the initial 3-month response period, the model assumes that patients on biologics have some improvement in their HAQ-DI score, even if they do not reach the PsARC threshold. Patients who do not achieve the required level of response during the first 3 months are withdrawn from therapy, and are assumed to follow the same HAQ-DI score trajectory after withdrawal as patients who had palliative care only.

The model assumes that patients who achieve a PASI 75 response will gain at least a 75% improvement in psoriasis compared with baseline PASI score. Patients who do not achieve a PASI 75 response will also have some proportionate gain in PASI score while they continue taking a biologic, although this will be less than a 75% improvement. The distribution of PASI scores observed in the trials was reflected within the model by utilising the PASI 50, PASI 75 and PASI 90 data to determine the change in PASI score for PASI 75 responders and non-responders.

Following an initial response to biologic therapy, the model assumed that patients maintain the initial improvement in HAQ-DI score for the remaining period of time on that therapy. This assumption was justified based on evidence from an elicitation exercise with clinical experts and supported by data on HAQ-DI and HRQoL from biologics registers and radiographic information supplied by the manufacturers of biologics. It was also assumed that patients maintain the improvement in PASI score while on biologic therapy.

The model assumes that no patients withdraw as a result of AEs in the first 3 months. The authors noted that, as responses in the RCTs are reported on an ITT basis, including withdrawal during the first 3 months would constitute double counting. The model includes an ongoing risk of withdrawal from biologic therapy over the longer term as a result of a lack of continuing efficacy ('secondary non-response'), AEs or other reasons. The rate of withdrawal after 3 months is assumed to be independent of the HAQ-DI and PASI scores, to be independent of whether the initial response was for both psoriasis and arthritis or just arthritis and to be constant over time.

On withdrawal of a biologic treatment, it is assumed that the mean PASI returns to its initial score at baseline (rebound equal to initial gain). The authors acknowledged that there was more uncertainty about change in HAQ-DI score associated with withdrawal (rebound). In the base-case analysis it is assumed that rebound is equal to initial gain. Other scenarios (rebound less than initial gain and rebound equal to natural history) were explored using sensitivity analyses.

Patient characteristics in the York model

Table 62 shows the baseline characteristics used in the York model. Patients were assumed to fulfil the BSR guidelines and criteria specified for commencing biologics (i.e. that their PsA has not responded to adequate trials of at least two standard DMARDs, administered either individually or in combination).

TABLE 62 Baseline patient characteristics used in the York model

Characteristic	Assumed value
Age (years)	47
Weight (kg)	60–80
Baseline HAQ-DI score (units)	1.05
Baseline PASI score (units)	7.5

SD, standard deviation.

The model cohort is assumed to be aged 47 years at the start of the model, and it is assumed that at least 7 years has passed since the diagnosis of PsA, based on the average characteristics of participants in the included RCTs. The mean baseline HAQ-DI score at the start of the model is assumed to be 1.05 units and patients are assumed to have mild–moderate psoriasis with a PASI score of 7.5 units, based on the average HAQ-DI and PASI baseline scores in the RCTs. The mean body weight is assumed to be between 60 and 80 kg based on the mean adult weight of the general population for men and women.

Alternative subgroups were explored in scenario analyses based on different baseline HAQ-DI and PASI scores:

- an alternative, more severe HAQ-DI of 1.8 units, which is the mean HAQ-DI score of patients entering the BSRBR⁸³
- no skin involvement, with a PASI score of 0 units (Smith *et al.*¹²⁸ stated that 50% of patients with PsA starting biologics in clinical practice would have mild or no skin involvement)
- moderate–severe psoriasis, with a PASI score of 12.5 units (Smith *et al.*¹²⁸ stated that 25% of patients with PsA starting biologics in clinical practice would have a baseline PASI of > 10 units).

Choice of intervention and comparators in the York model

Infliximab, ETN, ADA and palliative care were included, reflecting the licensed biologic treatments available when TA199¹²² was conducted. Palliative care was assumed to represent conventional care without biologic treatment.

Sequencing of treatments in the York model

In the base-case analysis, patients who are withdrawn from treatment (primary non-response or secondary withdrawal) were assumed to receive palliative care alone. A separate exploratory scenario assessed the cost-effectiveness of a further biologic treatment used as a second line of therapy (biologic experienced), if the first biologic is withdrawn. This scenario considered two subgroups: failure of first biologic as a result of AEs and failure because of efficacy.

In the absence of RCT data on these subgroups, treatment response and withdrawal rates for these subgroups were estimated from observational data for RA patients from the BSRBR. In the case of a patient who failed first-line therapy because of a lack of efficacy, the RR of failing the second-line therapy because of a lack of efficacy increases by 2.7 (95% CI 2.1 to 3.4). If a patient fails first-line therapy because of an AE, then the risk of failing the second-line therapy for AEs increases by 2.3 (95% CI 1.9 to 2.9).

Natural history of psoriatic arthritis in the York model

Psoriatic arthritis is a progressive disease and patients with untreated PsA may have persistent inflammation and progressive joint damage (see *Chapter 2*). This was reflected in the York model by applying a constant rate of HAQ-DI increase to patients receiving palliative care alone (*Figure 9*). The increase in HAQ-DI score was applied to characterise the natural history of HAQ-DI (i.e. without biologic treatment) and was

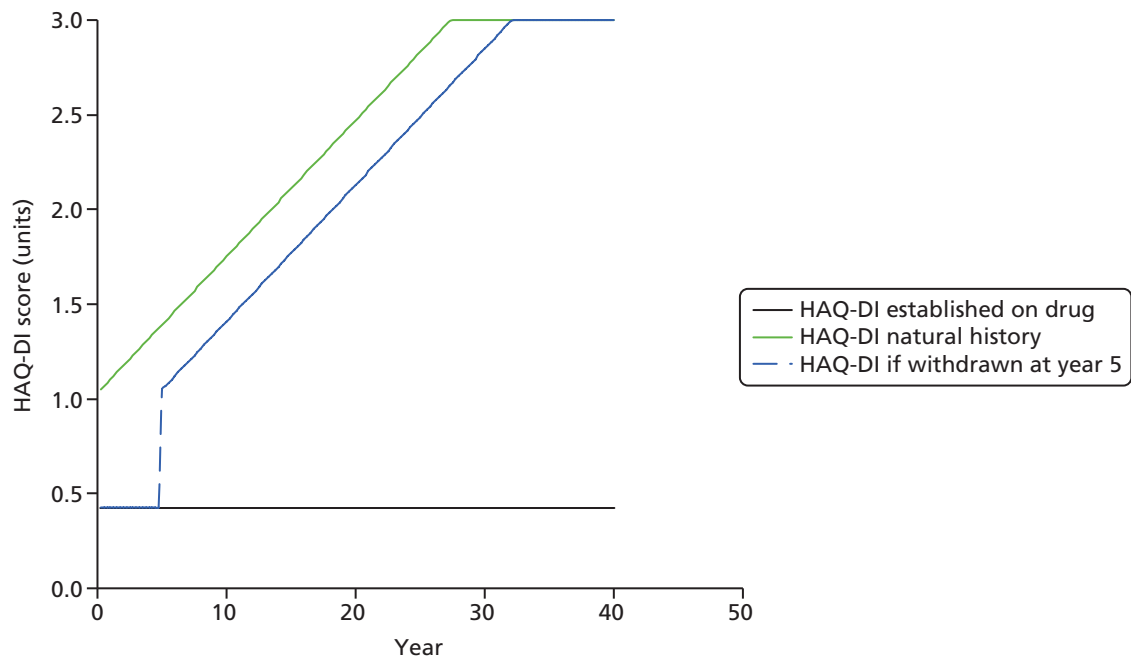

FIGURE 9 Illustration of the progression of arthritis for a patient successfully maintained on a biologic, a patient without a biologic and a patient who withdraws at 5 years, as implemented in the York model.³³

estimated as 0.018 units in a 3-month cycle, based on data from the NOAR. *Figure 9* graphically shows how the HAQ-DI progression assumptions (on and off treatment) were applied in the York model.

For the psoriasis component of PsA, it was assumed that the PASI score does not worsen over time (off treatment), which was stated to be consistent with clinical evidence.

Sources and synthesis of effectiveness data in the York model

The effectiveness of the alternative treatments was estimated using a NMA. The network of evidence was based on six trials that have a common comparator (placebo).³³ Three different synthesis models were specified to allow relevant outcomes for the economic model to be synthesised: PsARC response at 12–16 weeks; change in HAQ-DI score conditional on a PsARC response; and the probability of achieving PASI 50, PASI 75 and PASI 90 responses.

In the decision model, the change in HAQ-DI score compared with baseline is conditional on PsARC response status. It is uncertain whether the change in HAQ-DI score is the same for all PsARC treatment responders (TRs) or depends on the particular biologic treatment received. In the base case, the change in HAQ-DI score depended on PsARC response and the individual biologic treatment, whereas alternative scenarios (i.e. HAQ-DI score change the same for all PsARC responders) were assessed within the sensitivity analysis.

A placebo or expectation effect, which is the improvement reported for patients in the placebo arms of the RCTs, is uncertain and may not be reproducible in clinical practice. In the base case, the mean change in HAQ-DI score across the placebo arms of the RCTs was discounted from the change in HAQ-DI score for patients using biologics. This was applied in the decision model by deducting the change in HAQ-DI score in the placebo arm, weighted by the PsARC response in that arm, from the HAQ-DI score change in the treatment arm. A similar adjustment is made for the expected change in PASI score. An alternative scenario was conducted assuming that the response rate to treatment in the RCTs is fully generalisable to general practice and, therefore, no adjustment for placebo/expectancy effects is made.

Data on time to withdrawal from first biologic were separately synthesised using a meta-analysis of five European registry studies, one of which was the UK BSRBR.⁸³ The estimated annual probability of withdrawing from the biologic treatment after the first cycle is 0.165; therefore, patients who achieve an initial PsARC response will, on average, remain on biologic drugs for just over 6 years in the model ($1/0.165 = 6.06$ years). This was assumed to be identical for all biologics.

The base-case model uses a published estimate of the additional mortality risk in PsA (Wong *et al.*¹²).

Sources of utility data used in the York model

Quality-adjusted life-years were determined by estimating health utilities as a function of HAQ-DI and PASI. The York model used an equation based on an ordinary least squares regression of patient-level data from one of the companies (Wyeth) submitting evidence for TA199.¹²² It was stated that similar results were obtained from separate trials across each of the three companies, indicating that the relationship between HAQ-DI, PASI and utility appears stable across independent clinical trials. *Equation 1* shows the algorithm used in the base-case analysis of the York model:

$$\text{Expected utility} = 0.897 - 0.298 \times \text{HAQ} - 0.004 \times \text{PASI}. \quad (1)$$

Summary of resource utilisation and costs data used in the York model

The costs of acquiring the drugs and of their administration and monitoring were obtained from the BSR guidelines for the use of biologics and national prices and tariffs. The base case assumes that vial sharing is not permitted for INF and, therefore, separate scenarios regarding the use of three or four vials per patient were considered according to different weight assumptions.

Health-care costs increase with severity of both arthritis and psoriasis. Health state costs associated with HAQ-DI were derived from data from a UK-based study by Kobelt *et al.*¹²⁹ including 916 patients suffering from RA and followed up for between 5 and 9 years. Direct health-care resources were collected prospectively for all patients for hospitalisations, surgical interventions and RA medications. Based on this study, Bansback *et al.*¹³⁰ separately applied a linear regression model to estimate the relationship between HAQ-DI score and resource use (*Equation 2*). The regression estimates were subsequently reduced by 15% to account for expenditure on DMARDs and to avoid double counting other drug acquisition costs which were separately estimated.

$$\text{Direct cost per 3-month period} = 342 + 103.5 \times \text{HAQ-DI}. \quad (2)$$

As the Kobelt *et al.*¹²⁹ study includes only RA patients, separate costs were estimated for treating mild–moderate psoriasis in patients who do not use biologics, or who do not respond to biologics, from NHS unit costs of phototherapy and a UK RCT. For patients with moderate or severe psoriasis, costs were obtained from a Dutch RCT (see Hartman *et al.*¹³¹) and adjusted to UK price levels. These costs were assigned to patients based on whether or not a PASI 75 response was achieved (*Table 63*).

TABLE 63 Psoriasis (PASI) costs applied in the York model

State	Level of psoriasis, 3-month cost (£)	
	Mild–moderate	Moderate–severe
On anti-TNF- α with PASI 75 response	16	16
On anti-TNF- α without PASI 75 response	198	566
Not on anti-TNF- α therapy	198	566

Cost-effectiveness results from the York model

The summary results from the York model are those which are reported in the Final Appraisal Determination document for TA199.¹³² The results of the base-case model reported that INF was the most effective strategy taking into account both joint and skin effects (QALYs = 7.3), followed by ETN (QALYs = 7.0) and ADA (QALYs = 6.6). In terms of costs, INF was the most costly treatment (£88,442), followed by ETN (£74,841) and ADA (£68,638). The incremental cost-effectiveness ratio (ICER) for ETN compared with palliative care was £17,853 per QALY. The ICER for INF compared with ETN was around £44,326 per QALY. ADA was extendedly dominated. Of the three biologic therapies, ETN had the highest probability of being cost-effective at a threshold between £20,000 (probability = 44%) and £30,000 (probability = 48%) per QALY.

The results of the subgroup analysis showed that biologics appear slightly less cost-effective if the baseline HAQ-DI score is 1.8 (high), although the ICER for ETN remained below £20,000 per QALY. In patients with a negligible baseline psoriasis (i.e. PASI = 0 units), ETN was the most cost-effective strategy, with an ICER of £18,512 per QALY compared with palliative care. The ICER of INF versus ETN increased to £64,744 per QALY and ADA remained extendedly dominated. However, for a cohort in which the baseline PASI score was moderate to severe (PASI of 12.5 units rather than 7.5 units), ADA was no longer extendedly dominated. The ICER of ADA versus palliative care was £16,310 per QALY. The ICER of ETN versus ADA was £19,319 per QALY and the ICER of INF versus ETN was £27,778 per QALY.

In the scenario considering the cost-effectiveness of biologics, used as a second course of therapy after a first biologic has failed for PsA patients with mild–moderate skin disease, the ICERs depend on which drug was used as first-line therapy and is therefore ineligible for use as second line. For patients failing ETN, ADA has an ICER of < £20,000 and INF is around £25,000 per QALY. The ICERs were reported to be broadly similar for people whose PsA failed to respond to first-line therapy because of adverse effects and those whose disease failed first-line therapy because of inefficacy.

Summary of key differences in modelling approaches from other published studies

As described in *Summary of published studies for comparator treatments*, following the development of the York model for TA199,³³ three further models were developed comparing different sets of interventions. The model developed for TA220⁷⁰ compared ETN, INF, ADA, GOL and palliative care in a biologic-naive population. The model developed for TA340⁶⁶ compared ETN, INF, ADA, GOL, UST and palliative care in biologic-naive and biologic-experienced populations. The model developed by Cawson *et al.*³⁶ compared ETN, INF, ADA, GOL and palliative care in a biologic-naive population.

The model structure used in each of the three models is broadly the same as the York model. There were some minor variations in the duration of the response period, in particular extending this up to 24 weeks in TA220⁷⁰ to reflect the longer response period for UST in line with its licence, but generally all models have a similar underlying structure and use PsARC as the main response measure.

One key difference between the models concerns the different sets of interventions that have been compared. The sequence of published studies closely follows the licensing of additional TNF- α inhibitors after TA199³³ (GOL) and new biologic alternatives (UST). As a result, the scope of each study has been extended to include these additional licensed treatments. With the exception of the UST (TA340⁶⁶), the majority of studies have focused on evaluating the relative cost-effectiveness of the alternative TNF- α inhibitors in a biologic-naive population and all have been consistent in assuming that biologics are started only following the failure of at least two DMARDs (individually or in combination, in line with BSR guidelines). However, as one of the RCTs for UST included patients with and without prior exposure to TNF- α inhibitors, the decision problem for TA340⁶⁶ was subsequently broadened to reflect these different populations. For the TNF- α inhibitor-exposed (experienced) population, UST was compared with conventional management only, because at the time of the submission there were no RCTs of TNF- α inhibitors in this population. Analyses were based on clinical effectiveness evidence from the TNF- α inhibitor-exposed subpopulation of the PSUMMIT 2 trial.

As new interventions have been included, subsequent modelling studies have been based on revised NMAs incorporating new RCT evidence for the interventions being assessed in each appraisal (GOL in TA220⁷⁰ and UST in TA340⁶⁶). However, the synthesis approaches and methodologies applied across the studies remains consistent with that applied in the York model. The only exception to this is the comparison of UST with conventional care in the TNF- α inhibitor-exposed subpopulation, which was based on subgroup results from the PSUMMIT 2 trial. For this subpopulation a NMA was not considered feasible because of the lack of RCT evidence for the comparator treatments.

The main approaches to estimating longer-term costs and QALYs employ similar methodologies and assumptions across the studies identified. The main difference in relation to costs concerns the link to PASI. Estimates of PASI costs applied in the GOL and UST appraisals (TA220⁷⁰ and TA340⁶⁶) were derived from a clinician survey and used to estimate the expected difference in cost per additional unit change in PASI score. This contrasts with the approach used in the York model, which distinguished costs on the basis of PASI 75 response. Although different utility algorithms have been applied in each of the models (TA220⁷⁰ and TA340⁶⁶ used patient-level data from each company's trials), these have reported similar coefficients for HAQ-DI and PASI to those applied in the York model. All studies have also routinely reported results based on the utility estimates used in the York model in separate scenarios.

With the exception of TA220 (GOL),⁷⁰ all models have used the same assumptions and data sources to model the natural history and progression of PsA [i.e. assuming a constant PASI score and a linear increase (worsening) of HAQ-DI score over time]. In TA220 (GOL)⁷⁰ and TA340,⁶⁶ the annual rate of change per year was derived from an alternative source, the Leeds NESPAR study. However, the estimate is broadly similar to the estimate applied in the York model and other published models (0.0719 per year compared with 0.077 per year in the York model). All published studies have used the same estimate (16.5% per annum) concerning longer-term withdrawal of biologic treatment due to lack of efficacy.

Comparison of cost-effectiveness results from published models

Given the different interventions and effectiveness data utilised in each of the models, it is not surprising that each generates different costs and QALYs, resulting in different ICERs for the various options being compared (*Table 64*). However, there appeared a number of findings which were consistent across the separate studies. Consistently, ETN appeared to represent the most cost-effective strategy based on fully incremental ICER calculations, with an ICER ranging between £16,426 and £17,853 per additional QALY versus palliative (i.e. conventional) care. In addition, INF was reported to be the most effective and costly strategy with the exception of TA220,⁷⁰ where INF was reported to have the same effectiveness as ETN. There is greater variation across the studies in terms of the ICERs reported for INF versus palliative care than for other comparisons. The ICERs for INF versus palliative range between £20,789 and £40,943 per QALY. These differences appear largely as a result of differences in assumptions related to dosing for INF based on body weight. In all fully incremental comparisons, treatments other than ETN and INF were reported to be either dominated or extendedly dominated. The majority of studies reported that the ICER for INF versus ETN (the next less effective and non-dominated strategy) ranged between £44,326 and £268,107 per QALY. In contrast, INF was reported to be dominated by ETN in TA220 (i.e. same effectiveness but higher cost).⁷⁰

Technology Appraisal 340 included a separate analysis of a biologic-experienced population for UST. In this analysis UST was reported to be cost-effective compared with BSC (ICER around £25,000) in the biologic-experienced/-ineligible population. UST was subsequently approved by NICE for this population, highlighting the importance of considering the impact of broader treatment pathways for PsA for future studies.

Analysis of subgroups, according to psoriasis involvement, has been consistently done via deterministic sensitivity analysis in TA199, TA220 and TA340, specifying a negligible or more severe PASI score.

TABLE 64 Summary of cost-effectiveness results from the published studies and NICE TAs

NICE TA and published studies			
^a TA199: ³³ Rodgers <i>et al.</i> ³³ and Bojke <i>et al.</i> ¹²²	^a TA220: ⁷⁰ Cummins <i>et al.</i> ¹³³ and Yang <i>et al.</i> ³⁴	^a TA340: ⁶⁶ Craig <i>et al.</i> ⁶⁶ and O'Connor <i>et al.</i> ³⁵	Cawson <i>et al.</i> ³⁶
Only fully incremental ICERs presented. The ICER of ETN compared with palliative care was £17,853 and the ICER of INF compared with ETN was £44,326 per QALY. ADA is extendedly dominated	Pairwise ICERs presented vs. palliative care and fully incremental comparisons presented	Pairwise ICERs presented vs. palliative care and fully incremental comparisons presented. Separate analyses presented for TNF- α inhibitor-naive and TNF- α inhibitor-experienced populations. ERG alternative model estimates presented below including UST PAS	Pairwise ICERs presented vs. palliative care and fully incremental comparisons presented
Of the three biologic therapies, ETN has the highest probability of being cost-effective at a threshold between £20,000 and £30,000 per QALY	Pairwise ICERs vs. palliative care (company corrected): <ul style="list-style-type: none"> • ADA = £18,824 • GOL = £19,993 • ETN = £17,177 • INF = £23,578 Fully incremental ICERs: <ul style="list-style-type: none"> • ETN vs. palliative care = £17,177 per QALY • ADA and GOL extendedly dominated • INF dominated by ETN 	Pairwise ICERs vs. palliative care – naive (ERG alternative model including UST PAS): <ul style="list-style-type: none"> • UST = £21,857 • ADA = £29,915 • ETN = £17,809 • GOL = £19,213 • INF = £40,943 Fully incremental ICERs – naive (ERG alternative model including UST PAS): <ul style="list-style-type: none"> • ETN vs. palliative care = £17,809 per QALY • INF vs. ETN = £268,107 per QALY • UST and GOL dominated • ADA extendedly dominated Experienced patients (ERG alternative model including UST PAS): <ul style="list-style-type: none"> • UST vs. palliative care = £25,393 per QALY 	Pairwise ICERs vs. palliative care: <ul style="list-style-type: none"> • ADA = £17,222 • GOL = £17,435 • ETN = £16,426 • INF = £20,789 Fully incremental ICERs: <ul style="list-style-type: none"> • ETN vs. palliative care = £16,426 per QALY • INF vs. ETN = £62,527 per QALY • GOL dominated • ADA extendedly dominated

PAS, Patient Access Scheme.

^a ICERs reported for TA199, TA220 and TA340 based on the preferred assumptions of the committee from Final Appraisal Determination documents.

Critique of company submissions

Two de novo economic models were submitted by the companies (Novartis and UCB Pharma) as part of this TA. The main features of the models are summarised in *Table 65* and critiqued in the sections following this. Quality assessment checklists for the two submissions are presented in *Appendix 5*.

Model structure and assumptions

The two company models have a similar structure to the York model, reflecting both the initial short-term (response period) and long-term (maintenance) phases (*Figures 10* and *11*). Within the short-term response period, treatment response is assessed within a decision tree in the Novartis submission, and within a Markov cohort model in the UCB Pharma submission. Both submissions characterise the long-term phase (modelled via changes in HAQ-DI and PASI scores) using a Markov cohort model. This longer-term phase is 40 years in the Novartis model and 50 years in the UCB Pharma model. Both models are built in Microsoft Excel® (Microsoft Corporation, Redmond, WA, USA).

TABLE 65 Summary of the Novartis and UCB Pharma models

CS		
Feature	Novartis	UCB Pharma
Comparators	<p>These are specified according to the subpopulations considered:</p> <ol style="list-style-type: none"> <i>Biologic naive (one prior DMARD)</i>: 150 mg of SEC, SoC (25 mg per week of MTX) <i>Biologic naive (two or more prior DMARDs)</i>: 150 mg of SEC, CZP, ADA, ETN, INF, GOL and SoC <i>Biologic experienced</i>: 300 mg of SEC, CZP, UST and SoC 	<p>These are specified according to the subpopulations considered:</p> <ol style="list-style-type: none"> <i>Biologic naive (one prior DMARD)</i>: CZP, cDMARD <i>Biologic naive (one or more prior DMARDs)</i>: CZP, 150 mg of SEC, ADA, ETN, INF, GOL <i>Biologic experienced</i>: CZP, 300 mg of SEC, UST and a mix of treatments defined as MTX, other cDMARDs and palliation (antirheumatics)
Model structure	<p>Short-term (3-month) decision tree, leading into a long-term (40-year) Markov cohort model</p> <p>Response at 3 months defined using both PsARC and PASI 75. Responders enter the maintenance phase and can switch to SoC as a result of death or withdrawal from treatment</p> <p>Disease progression, through PASI and HAQ-DI, are linked to costs and utilities. For patients on treatment, HAQ-DI and PASI scores remain constant from 12 weeks</p> <p>For patients who withdraw from treatment, PASI and HAQ-DI scores both rebound back to the baseline value in the cycle after stopping active treatment. Patients on SoC experienced a linear increase in their HAQ-DI score of 0.018 units for each cycle</p>	<p>Cohort Markov model. Three periods:</p> <ol style="list-style-type: none"> short term, in which the initial response to treatment is determined (12 or 24 weeks depending on the treatment) treatment continuation (up to 36 weeks post initial response) long-term (50 years) <p>PsARC is used to determine response. Responders enter the maintenance phase and can switch to another treatment as a result of loss of efficacy or for other reasons. Initial non-responders switch to the next line of treatment immediately after the initial period</p> <p>Disease progression, through PASI and HAQ-DI, is linked to costs and utilities. For patients on treatment, HAQ-DI and PASI scores remain constant. For patients who withdraw from treatment, PASI score rebounds back to the baseline value in the cycle after stopping active treatment, but HAQ-DI score rebounds to a worse position</p> <p>Patients on SoC experienced a linear increase in their HAQ-DI score of 0.018 units for each cycle</p>
Sequencing	<p>Not addressed in the base-case analysis. Included as a scenario in which patients move to a subsequent 'basket' of biologics before switching to SoC. This was applied only in the anti-TNF-naive population</p>	<p>Full sequence model of biologics followed by the mix of palliation, the sequence differs based on the subpopulation, ranging from one line to three lines of treatments. Switching can only occur in the first 4 years, after which patients remain on treatment indefinitely, accounting for mortality</p>
Patient inputs	<p>Homogeneous cohort using average characteristics from the FUTURE 2 trial:⁴⁸ baseline HAQ-DI score = (confidential information has been removed); baseline PASI score = (confidential information has been removed). These baseline values were applied to each of the three subpopulations</p>	<p>Homogeneous cohort using average characteristics from the RAPID-PsA trial:⁴⁷</p> <ul style="list-style-type: none"> <i>Biologic naive (one prior DMARD)</i>: baseline HAQ-DI score = (confidential information has been removed); baseline PASI score = (confidential information has been removed) <i>Biologic naive (one or more prior DMARDs)</i>: for anti-TNF-naive population baseline HAQ-DI score = 1.29 units; baseline PASI score = 11.58 units <i>Biologic experienced</i>: baseline HAQ-DI score = 1.37 units; baseline PASI score = (confidential information has been removed)

continued

TABLE 65 Summary of the Novartis and UCB Pharma models (*continued*)

Feature	CS	
	Novartis	UCB Pharma
Sources of effectiveness evidence and synthesis	See <i>Sources and synthesis of effectiveness and Appendix 6</i>	See <i>Sources and synthesis of effectiveness and Appendix 6</i>
Sources of cost data	MIMS 2016 ¹³⁴ and BNF 2015 ¹³⁵ for acquisition costs and doses required for treatments. PSSRU ¹³⁶ and <i>NHS Reference Costs 2014 to 2015</i> ¹³⁷ for administration and monitoring costs Health state costs were estimated based on Kobelt <i>et al.</i> ¹²⁹	MIMS 2016 ¹³⁴ and BNF 2015 ¹³⁵ for acquisition costs and doses required for treatments. PSSRU ¹³⁶ and <i>NHS Reference Costs 2014 to 2015</i> ¹³⁷ for administration and monitoring costs Health state costs were estimated based on Poole <i>et al.</i> ¹³⁸
Utilities	Algorithm derived from patient-level data of FUTURE 2 ⁴⁸ in which utility is a function of HAQ-DI, PASI, age, sex and anti-TNF response state The algorithm from the York model was also applied in a scenario analysis	Algorithm derived from patient-level data of the RAPID-PsA trial ⁴⁷ in which utility is a function of HAQ-DI and PASI The algorithm from the York model was also applied in a scenario analysis

BNF, *British National Formulary*; MIMS, online and print prescribing database for health professionals; PSSRU, Personal Social Services Research Unit; SoC, standard of care.

FIGURE 10 Overview of the UCB Pharma model structure. (Confidential information has been removed.)

Although both submissions share a similar underlying structure, there are important differences in the base-case approaches of each company in terms of the definition and timing of the response assessment:

- In the UCB Pharma base-case model, response is defined in terms of PsARC alone. The base case also assumes that PsARC response is assessed at 24 weeks both for CZP and for all other comparators. The use of 24 weeks contrasts with previously published studies reviewed for the comparator treatments, which have consistently assumed that this assessment would occur at around 3 months (12–16 weeks). The main exception in previous studies has been for UST, for which a 24-week time point has been used, in accordance with its marketing authorisation. The justification provided by UCB Pharma for choosing a common time point of 24 weeks for all treatments was based on the European League Against Rheumatism (EULAR) Treat to Target 2013 recommendations, which state that a maximum of 6 months is recommended for reaching the treatment target. However, the submission from UCB Pharma also notes that the same recommendations also advise that therapy should be adapted earlier than 6 months if no significant reduction in disease activity is observed. The UCB Pharma submission does not explicitly discuss the proportion of patients in whom its therapy would be adapted earlier than the 24-week time point, nor is there any discussion of the potential biases that could arise by assuming that therapy is adapted only after 24 weeks. However, a separate scenario in which the initial response was assessed at 12 weeks both for CZP and for other comparators (including UST) was explored as part of a scenario analysis. Patients are then further stratified according to PASI 75 response/no PASI 75 response. This stratification is not assumed in the base case to alter the decision to continue treatment, but allows alternative cost and utility assumptions to be applied according to PsARC response status.

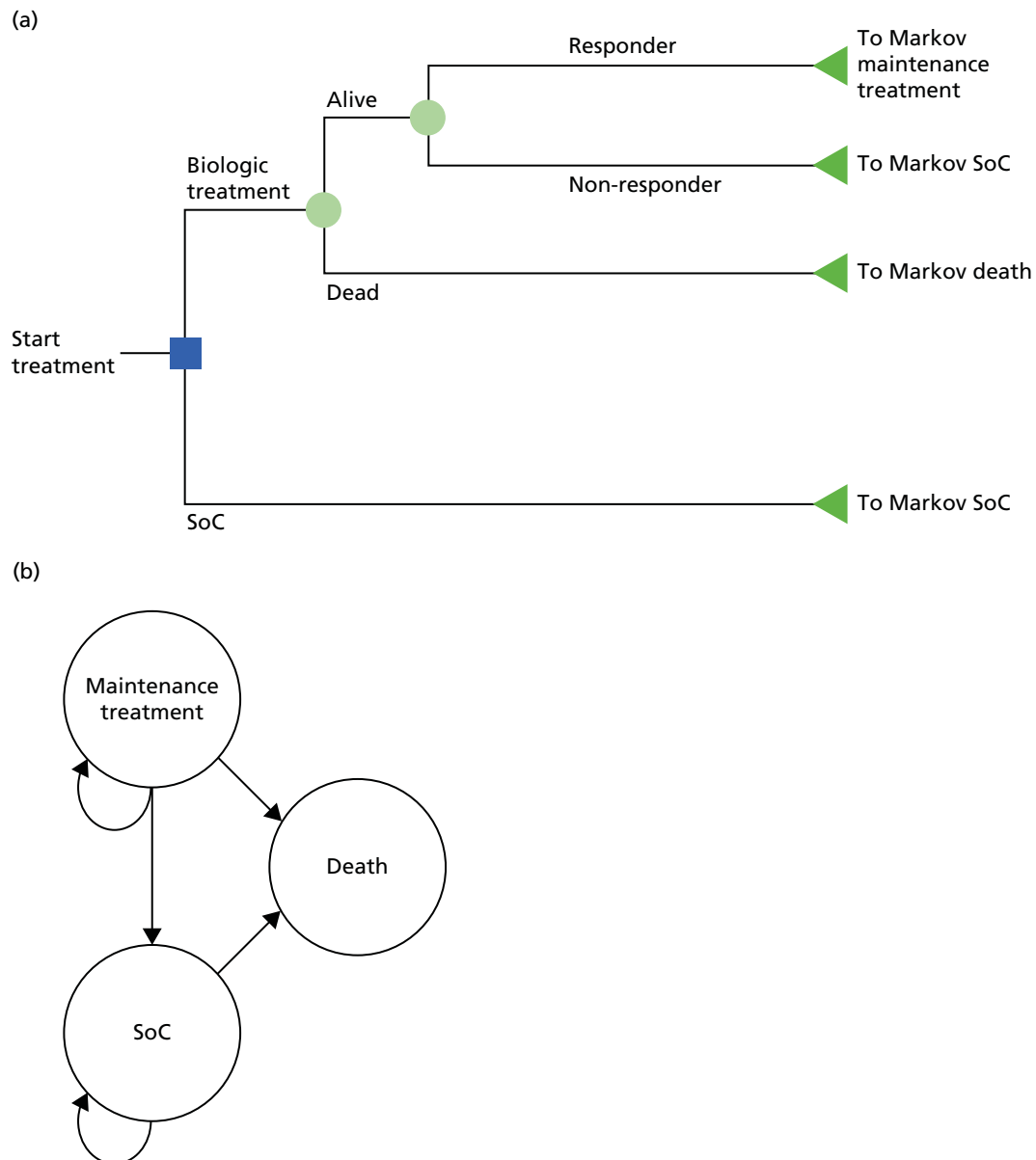

FIGURE 11 Overview of the Novartis model structure. (a) Decision tree structure; and (b) Markov model structure (base case). SoC, standard of care.

- In the Novartis model, patients are defined as responders if both a PsARC and PASI 75 response are achieved at 12 weeks (or 24 weeks for UST). The model also includes additional scenarios in which either PASI or PsARC only is used to determine a patient's initial response. Although the company notes that the SEC Summary of Product Characteristics recommends a 16-week assessment point, a 12-week time point is assumed for SEC based on consistency with BSR/British Health Professionals in Rheumatology guidelines and previous NICE appraisals.

In both models, HAQ-DI score changes are based on a treatment-specific rate of change conditional on PsARC response status. However, important differences were evident between the companies, in the approaches and assumptions applied in their models:

- In the UCB Pharma model, HAQ-DI score change for CZP is based on the week 4 data from the RAPID-PsA trial. UCB Pharma justifies this assumption on the basis that the RAPID-PsA trial⁴⁷ showed minimal further change in HAQ-DI score between weeks 4 and 24. In the absence of HAQ-DI data over time for the other comparators, a similar assumption was made for the comparators. An alternative

assumption was explored as part of a scenario analysis in which the highest rate of change (or 'best') HAQ-DI score change for the comparators is achieved only at 24 weeks. These assumptions are applied in the UCB Pharma model to the treatment response period (24 weeks in the base case). Beyond 24 weeks, it is also assumed that there is continued improvement in HAQ-DI score up to week 36 post initial response. UCB Pharma justifies this additional period of HAQ-DI score improvement based on continued improvement over this period observed in the RAPID-PsA trial.⁴⁷ In the absence of data, a similar assumption is applied to all the comparators. After 36 weeks it is assumed that HAQ-DI score remains constant for patients for the remainder of the period on treatment. *Figure 12* illustrates the separate intervals over which different assumptions are applied for patients responding to biological treatment in the UCB Pharma submission.

- In the Novartis model, HAQ-DI score change data were derived directly from data reported during the 12- to 16-week time period included in its main NMA and were assumed to remain constant from 12 weeks onwards for patients who remained on treatment. This approach is consistent with the assumption made in the previous York model.

In both models the change in PASI score is derived from the distribution of PASI responses. The approaches followed by each company are consistent with the approach and assumptions of the York model.

The two submissions also account for the correlation between PASI 75 and PsARC using a similar method to the York model. However, both companies source data on the correlation coefficients from their own trial data as opposed to the data used in the York model.

Both submissions also incorporate an adjustment to HAQ-DI and PASI scores in order to account for possible 'placebo' or 'expectation' effects in order to generalise the treatment effects from the RCTs to routine practice. The methods of adjustment follow the same approach as the York model, by reducing the change in HAQ-DI score for biologics by the weighted average of change in HAQ-DI score for PsARC responders and non-responders across the standard of care (SoC) arm. A similar approach is followed for PASI. Consequently, SoC patients were not assumed to experience any HAQ-DI or PASI score improvement in the models.

The Novartis model assumes that, when a treatment is withdrawn, patients rebound to their baseline HAQ-DI score (i.e. rebound equal to gain) and that their HAQ-DI score continues to deteriorate in line with the natural history of HAQ-DI (i.e. a constant monthly rate of HAQ-DI deterioration). In contrast, the UCB Pharma submission assumes that the HAQ-DI trajectory of patients switching to a subsequent treatment initially rebounds to a higher (i.e. worse) HAQ-DI value than the original baseline.

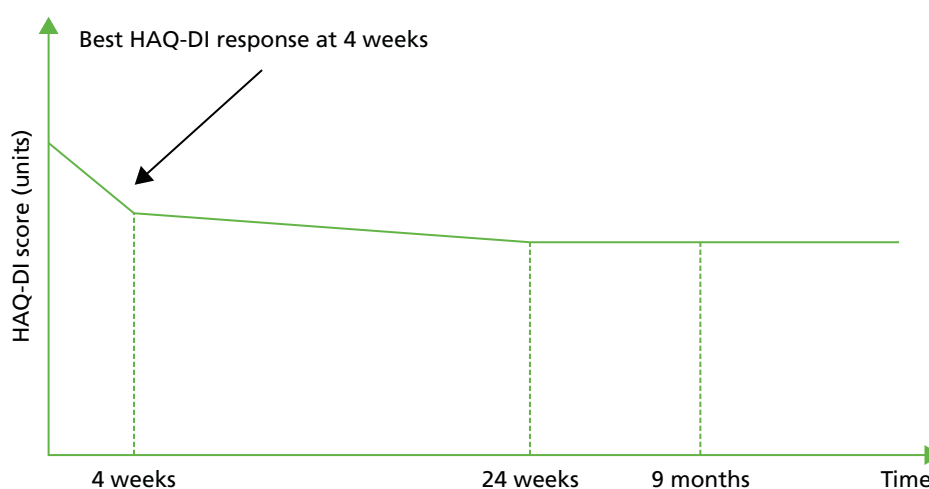

FIGURE 12 Illustration of HAQ-DI score change for patients responding to a biologic treatment in the UCB Pharma model.

The two submissions include a sex-specific multiplier effect for PsA mortality. The Novartis submission applied the RRs reported in Wong *et al.*¹² (1.65 and 1.59 for men and women, respectively) to life tables from the general population. The impact of these multiplier effects was assessed by removing the effects in a scenario analysis. In the UCB Pharma submission, a standardised mortality ratio of 1.36 was applied for males and females.¹⁴ This represents an updated analysis of the cohort from Wong *et al.*¹²

Intervention and comparators

According to the BSR guidelines, biologic treatments should be considered for patients with active PsA who have inadequately responded to two previous conventional disease-modifying antirheumatic drugs.¹²⁷ However, in accordance with the NICE scope¹¹² and the licences for SEC and CZP, the two submissions have addressed three different subpopulations, including the one prior non-biologic DMARD population. The three subpopulations specified in the NICE scope are:

1. subpopulation 1 (biologic naive, one prior DMARD): people who have received one prior non-biologic DMARD
2. subpopulation 2 (biologic naive, two or more prior DMARDs): people whose disease has not responded adequately to at least two prior non-biologic DMARDs
3. subpopulation 3 (biologic experienced or contraindicated): people whose disease has not responded adequately to non-biologic DMARDs and not adequately responded to biological therapies (including ETN, ADA, INF and GOL), or for whom biologic therapies are contraindicated.

There are two areas where the CSs appear to deviate from the specified NICE scope.¹¹² First, subpopulation 2 is subsequently defined by UCB Pharma as all biologic-naive people. Hence, subpopulation 2 is presented by UCB Pharma as an expansion of subpopulation 1 (i.e. representing one or more prior DMARDs). In contrast, the Novartis submission specifies subpopulation 2 in accordance with the NICE scope (i.e. inadequate response to at least two DMARDs). Second, both companies focus on the biologic-experienced population for subpopulation 3. Hence, neither company separately considers people in whom biologic therapies (including ETN, ADA, INF and GOL) are contraindicated.

The interventions and comparators in both submissions are specified separately for each of the three subpopulations. Conceptually there are important differences between the submissions in terms of the scope of the models and the approaches used to model the interventions and comparators:

- The UCB Pharma model has been developed to assess the cost-effectiveness of the interventions in the context of a treatment pathway and, hence, explicitly considers subsequent treatment lines by modelling separate sequences. The length and composition of the sequences differ across each of the three subpopulations.
- The base-case model from Novartis for each subpopulation focuses on each specific point in the pathway (i.e. the point that a decision to initiate a new intervention would be made for each subpopulation) and does not attempt to formally model the sequences of subsequent treatments. Instead, the impact of further treatment and associated sequences is explored as part of a separate scenario and is presented as an exploratory analysis. Novartis justifies this approach given the limitations in the data available to model sequencing of treatments and the lack of formal guidelines concerning the order in which biologics should be used sequentially.

The interventions and comparators in each subpopulation are summarised in *Figure 13* (UCB Pharma) and *Figure 14* (Novartis). The figures illustrate the different approaches employed by the companies and the focus on the entire pathway (sequences and different lines) in the UCB Pharma submission compared with the approach used by Novartis in its base case.



FIGURE 13 Interventions and comparators according to subpopulations (UCB Pharma). (a) Subpopulation 1 (biologic naive, one prior DMARD); (b) subpopulation 2 (all biologic naive, one or more prior DMARDs); and (c) subpopulation 3 (biologic experienced).

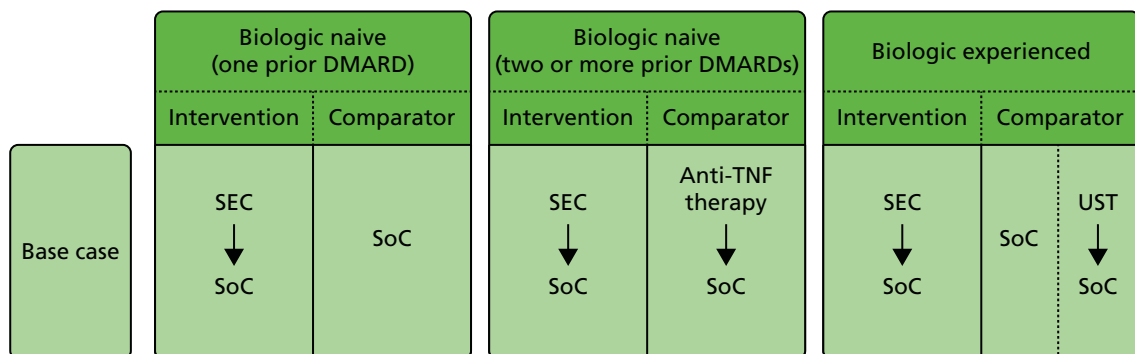

FIGURE 14 Interventions and comparators according to subpopulations (Novartis).

Subpopulation 1: biologic naive (one prior DMARD)

In the UCB Pharma model, two sequences are compared in subpopulation 1:

1. sequence 1: first line (CZP) → second line (TNF) → third line (UST) → last line (mix)
2. sequence 2: first line (cDMARD) → second line (TNF) → third line (UST) → last line (mix).

The sequences differ in terms of the first-line therapy (CZP or cDMARDs) and the subsequent lines of therapies (up to three further lines) in both sequences are assumed to be identical. Primary and secondary failures to first-line therapy are assumed to move onto a second-line treatment comprising a mixture of four TNF- α inhibitors (ETN, INF, ADA and GOL). The mixture of the four TNF- α inhibitors is modelled assuming an equal market share (25%) and costs and outcomes are estimated as the weighted sum. Following failure of the mixture of TNFs, patients are assumed to move onto UST as a third-line treatment before moving onto the last line (mix). The last line (mix) is defined as a mixture of cDMARDs (base case: MTX = 58.8%, leflunomide = 1.5%, sulfasalazine, 2.9% MTX sodium) and palliation (34.6%).

The UCB Pharma submission states that, although SEC is also a relevant comparator in this subpopulation (i.e. a third sequence starting with SEC), the lack of published clinical evidence specifically on the one prior DMARD subpopulation precluded SEC from being formally included.

In the Novartis model, the intervention assessed in subpopulation 1 is 150 mg of SEC and the comparator is SoC (defined as 100% use of MTX, dose 25 mg per week). Similarly, the lack of published clinical evidence specifically on the one prior DMARD subpopulation precluded CZP from being formally included in the Novartis submission. Following primary or secondary treatment failure of SEC, patients are assumed to move to SoC (MTX) without further biologic treatment.

Although 300 mg of SEC is the licensed dose for biologic-experienced patients with concomitant moderate–severe psoriasis, Novartis stated three reasons why the 300-mg dose was included for biologic-naive patients (subpopulations 1 and 2):

1. the use of 300 mg of SEC for moderate–severe psoriasis is already recommended based on a separate appraisal in this indication
2. no comparator data for biologic-naive PsA patients with concomitant moderate–severe psoriasis were reported to be available
3. the subgroup of biologic-naive patients with concomitant moderate–severe psoriasis in the FUTURE 2 trial⁴⁸ was too small to appropriately inform model inputs.

Subpopulation 2: biologic naive (one or more prior DMARDs, UCB Pharma; two or more prior DMARDs, Novartis)

In the UCB Pharma model, three main sequences are compared in subpopulation 2:

1. sequence 1: first line (CZP) → second line (UST) → last line (mix)
2. sequence 2: first line (TNF) → second line (UST) → last line (mix)
3. sequence 3: first line (SEC) → second line (UST) → last line (mix).

The sequences start with CZP, other TNF- α inhibitors (ETN, INF, ADA and GOL) or SEC. In contrast to subpopulation 1, the four other TNF- α inhibitors are evaluated as alternative first-line treatments. Hence, sequence 2 actually comprises four separate sequences with ETN, INF, ADA or GOL specified as the first-line treatment. The six sequences assessed in subpopulation 2 are thus:

1. sequence 1: first line (CZP) → second line (UST) → last line (mix)
2. sequence 2: first line (ETN) → second line (UST) → last line (mix)
3. sequence 3: first line (INF) → second line (UST) → last line (mix)
4. sequence 4: first line (ADA) → second line (UST) → last line (mix)

5. sequence 5: first line (GOL) → second line (UST) → last line (mix)
6. sequence 6: first line (SEC) → second line (UST) → last line (mix).

Primary and secondary failures to first-line treatment are assumed to subsequently move onto UST before moving onto 'mix' (similarly defined as in subpopulation 1 as a mixture of cDMARDs and palliation).

The UCB Pharma model does not separately model the 150- and 300-mg doses of SEC for subpopulation 2. Instead, a single SEC sequence is modelled based on a weighted approach according to prevalence of moderate–severe plaque psoriasis in subpopulation 2 and assuming that 53.7% of patients would have a PASI score of > 10 units at baseline. The proportion used as the basis for weighting is referenced to an academic-in-confidence study and no further details are reported. The weighting is discussed only in the context of costing and, hence, it is unclear whether or not the efficacy estimates for SEC were similarly weighted.

In the Novartis model, the treatment assessed in subpopulation 2 is 150 mg of SEC and five TNF- α inhibitors (CZP, ETN, INF, ADA and GOL). Primary and secondary failures are assumed to subsequently move onto SoC without biologic therapy (100% use of MTX, dose 25 mg per week).

The Novartis submission also considers a separate scenario (exploratory analysis) for subpopulation 2 in which it is assumed that patients can move onto a mixed biologic therapy, prior to moving to SoC. The mixed biologic treatment therapy comprises a mix of all biologics other than that received at first line. This mixed strategy is assigned a weighted average efficacy, costs and AE incidence rates. The weights assumed are not formally specified, but appear to be based on a similar approach to that taken by UCB Pharma (i.e. assuming each has the same market share). Two scenarios were considered in which either the same first-line efficacy is assumed for the mixed biologic therapy or a 20% decline in efficacy for HAQ-DI, PsARC and PASI response while on second-line therapy.

Available biosimilars for ETN and INF are also included in the two submissions as part of separate scenario analyses.

Subpopulation 3: biologic experienced

In the UCB Pharma model, four sequences are compared in subpopulation 3:

1. sequence 1: first line (CZP) → last line (mix)
2. sequence 2: first line (300 mg of SEC) → last line (mix)
3. sequence 3: first line (UST) → last line (mix)
4. sequence 4: first line (mix).

In common with the other subpopulations, the sequences for subpopulation 3 differ in terms of the first-line therapy (CZP, 300 mg of SEC, UST or mix), and the subsequent line of therapy (mix – comprising a mixture of cDMARDs and palliative care) is assumed to be identical. The SEC sequence is modelled based on the 300-mg dose in accordance with the licensed dose for biologic-experienced patients.

In the Novartis model, the intervention assessed in subpopulation 3 is 300 mg of SEC, and UST and SoC are included as separate comparators. The Novartis submission does not discuss why CZP is not included as a separate comparator for subpopulation 3. Following primary or secondary treatment failure of SEC or UST, patients are assumed to move to SoC without further biologic treatment (i.e. MTX).

Patient characteristics

The UCB Pharma submission uses the RAPID-PsA trial⁴⁷ and specifies different baseline characteristics for the three subpopulations. In the Novartis submission, baseline characteristics were reported to be similar across subgroups in the FUTURE 2 trial⁴⁸ and, hence, the same values were assigned to all patient characteristics apart from PASI score.

Tables 66 and 67 report the values applied in the two company models. The subpopulations are broadly similar in terms of age and weight; however, there are some differences in terms of baseline HAQ-DI and PASI scores assumed across the separate models. The UCB Pharma submission applies an increasing baseline mean HAQ-DI score across subpopulations 1–3, which contrasts with the same HAQ-DI score applied across the three subpopulations in the Novartis submission. There appears to be more variation in the baseline PASI scores between the submissions, with mean PASI scores assumed to be > 10 units and ≤ 10 units, respectively, in the UCB Pharma and Novartis submissions for each of the subpopulations.

The differences in the mean PASI scores appear to be an important source of variation between the two submissions. By assuming a mean PASI score of > 10 units, the UCB Pharma base-case results relate to an 'average' PsA patient with concomitant moderate–severe psoriasis (i.e. ≥ 3% of BSA affected and a PASI score of > 10 units). In contrast, the Novartis base-case results relate to an 'average' PsA patient with concomitant mild–moderate psoriasis (≥ 3% of BSA affected and a PASI score of ≤ 10 units). These differences are likely to have an impact on subsequent costs and outcomes, most importantly in terms of the appropriate dosing and costs assumed for SEC (i.e. 150 or 300 mg depending on the presence and severity of concomitant psoriasis) in the naive subpopulations (i.e. subpopulations 1 and 2).

The UCB Pharma submission presents separate deterministic sensitivity analyses based on different PASI scores. These sensitivity analyses were presented for two alternative baseline PASI scores (0 and 12.5 units). These sensitivity analyses essentially reflect separate subgroups without concomitant psoriasis (mean PASI score = 0 units), and a subgroup with concomitant moderate–severe psoriasis (mean PASI score = 12.5 units). The Novartis model does not present separate subgroup results or sensitivity analyses in relation to the baseline PASI score.

TABLE 66 Baseline characteristics in subpopulations 1–3 (UCB Pharma)

Feature	Subpopulation		
	1	2	3
Age (years), mean	Confidential information has been removed	47	49
% female	Confidential information has been removed	55.6	53.8
Weight (kg), mean (SD)	Confidential information has been removed	84 (18)	87 (20)
HAQ-DI score (units), mean	Confidential information has been removed	1.29	1.37
PASI score (units), mean	Confidential information has been removed	11.58	12.04

SD, standard deviation.

TABLE 67 Baseline characteristics in subpopulations 1–3 (Novartis)

Feature	Subpopulation		
	1	2	3
Age (years), mean	47.96	47.96	47.96
% female	51.6	51.6	51.6
Weight (kg), mean (SD)	87.11 (19.66)	87.11 (19.66)	87.11 (19.66)
HAQ-DI score (units), mean	Confidential information has been removed	Confidential information has been removed	Confidential information has been removed
PASI score (units), mean	Confidential information has been removed	Confidential information has been removed	Confidential information has been removed

SD, standard deviation.

Given that PASI is directly observable and because the severity of concomitant psoriasis means that different SEC dosages are appropriate for the separate subgroups (i.e. 150 mg of SEC for naive patients without concomitant psoriasis or with concomitant mild–moderate psoriasis and 300 mg of SEC for experienced patients and for naive patients with concomitant moderate–severe psoriasis), it would appear more appropriate for both companies to have more explicitly modelled the three specific subgroups within each of the subpopulations as opposed to assuming a single ‘average’ PsA patient or cohort. These three subgroups are:

1. PsA without concomitant psoriasis
2. PsA with concomitant mild–moderate psoriasis ($\geq 3\%$ of BSA and a PASI score of ≤ 10 units)
3. PsA with concomitant moderate–severe psoriasis ($\geq 3\%$ of BSA and a PASI score of > 10 units).

Withdrawal from treatment and the natural history of psoriatic arthritis

Following treatment failure and withdrawal, the Novartis submission assumes that patients’ HAQ-DI and PASI scores will revert to the original baseline values, which is consistent with the ‘rebound equal to gain’ approach previously applied in the York model. In contrast, the UCB Pharma submission assumes that the HAQ-DI score trajectory of patients switching to a subsequent treatment initially rebounds to a higher (i.e. worse) HAQ-DI value than the original baseline. The value assumed for rebound is equal to the baseline value plus the HAQ-DI score change for the previous treatment’s PsARC non-responders. Furthermore, when switching from the second to the third line of treatment, this rebound increases further, representing the baseline plus the previous two treatments’ change in HAQ-DI score for non-PsARC responders. For example, in a treatment sequence addressing subpopulation 1, the baseline HAQ-DI score is assumed to be (confidential information has been removed); on switching to the second line of treatment, this initially increases to (confidential information has been removed), and increases further to (confidential information has been removed) and (confidential information has been removed). The UCB Pharma submission does not include any discussion or justification for this approach.

The natural progression of PsA (i.e. in the absence of biologic treatments), in terms of increasing the HAQ-DI score, is reflected in both models using the approach adopted in the York model. The two models assume that the HAQ-DI score linearly increases over time by 0.018 units every 3 months until it reaches the maximum, 3 units. This increasing HAQ-DI score is applied in conventional treatment arms of both models and to patients who subsequently move on to conventional (i.e. non-biologic) treatment.

Both the UCB Pharma and Novartis models consider the possibility that patients who initially respond to treatment may subsequently withdraw from treatment in the longer-term model. Based on safety and tolerability data from the FUTURE 1 and 2 trials (see *Chapter 4*),^{46,48} the Novartis submission derived the discontinuation rates for patients receiving 150 and 300 mg of SEC. This was (confidential information has been removed) and (confidential information has been removed) for the first year and (confidential information has been removed) and (confidential information has been removed) for subsequent years (applied until the end of the model). These values were used for all comparators in the base case and alternative values were examined in sensitivity analysis, in which withdrawal rate values were derived from different trials (*Table 68* shows these values).

TABLE 68 Discontinuation rates applied in sensitivity analysis (Novartis)

Time point	Treatment, annual discontinuation rate (%)							
	150 mg of SEC	300 mg of SEC	CZP	ETN	ADA	INF	GOL	UST
Year 1	Confidential information has been removed	Confidential information has been removed	15.1	15.6	15.0	13.9	29.5	26.1
Year 2+	Confidential information has been removed	Confidential information has been removed	15.1	15.6	15.0	8.5	29.5	11.3

The UCB Pharma model assumes an annual discontinuation rate of 16.5% for all biologic treatments. This figure is consistent with the assumption and data used to inform the York model. A further assumption was also included in the UCB Pharma model such that if a patient continued on a therapy for at least 48 months there would be no risk of longer-term withdrawal beyond this time point. This assumption was justified as a result of the lack of data reporting long-term withdrawal rates.

Sources and synthesis of effectiveness

The main clinical outcomes included in the company models were PsARC and PASI (50, 75 and 90) response, and HAQ-DI score changes conditional on PsARC response. The sources and assumptions of the effectiveness evidence used in the base case of each of the economic models are summarised in detail in *Appendix 6*. A brief overview is provided below and is specifically focused on the relationship between the meta-analyses undertaken by each company and the specific inputs and assumptions applied to each subpopulation within the economic models.

Subpopulation 1: biologic naive (one prior DMARD)

For the biologic-naïve (one prior DMARD) subpopulation, both companies used the results from post hoc subgroup analyses of the naïve subgroup (one prior DMARD) from either the RAPID-PsA (UCB Pharma)⁴⁷ or FUTURE 2 (Novartis)⁴⁸ trials to inform PsARC and PASI responses and conditional HAQ-DI scores.

Subpopulation 2: biologic naive (one or more prior DMARDs, UCB Pharma; two or more prior DMARDs, Novartis)

The PsARC and PASI responses were derived directly from the estimates of the separate NMAs undertaken by each company. The patients used for subpopulation for each NMA differed. The UCB Pharma estimates were derived from a NMA based on trials (or relevant subgroups) of biologic-naïve patients only. In the absence of subgroup data for SEC for biologic-naïve patients, UCB Pharma included a separate assumption that the effectiveness of SEC (confidential information has been removed). In contrast, Novartis used the results from its NMA based on the overall population (i.e. including both naïve and experienced patients for some trials) results for all treatments.

A variety of different sources and assumptions were used to inform HAQ-DI change scores, including results from the NMA, external published estimates and assumptions.

Subpopulation 3: biologic experienced

There were important differences in the approaches and assumptions used by each company for subpopulation 3. The UCB Pharma model included PsARC and PASI response estimates for CZP and SoC directly from a subgroup of biologic-experienced patients from the RAPID-PsA trial⁴⁷ and then applied separate assumptions for 300 mg of SEC and UST. In contrast, Novartis assumed a common reduction in the efficacy of biologic-experienced patients based on a comparison between biologic-naïve and biologic-experienced subgroups in the FUTURE 2 trial. The efficacy reductions were subsequently applied to the all-population NMA. The following reductions were applied:

- PsARC reduced by (confidential information has been removed)%
- PASI 50–74 reduced by (confidential information has been removed)%
- PASI 75–89 reduced by (confidential information has been removed)%
- PASI 90–99 reduced by (confidential information has been removed)%.

For HAQ-DI change scores, the UCB Pharma model derived data for CZP and SoC directly from the biologic-experienced subgroup of the RAPID-PsA trial⁴⁷ and used separate assumptions for UST and 300 mg of SEC. Novartis assumed the same change scores as applied to subpopulation 2.

Sources of utility data

The two manufacturers' submissions present separate utility algorithms derived from patient data in the FUTURE2⁴⁸ (Novartis) and RAPID-PsA⁴⁷ (UCB Pharma) trials. These algorithms are estimated to determine the independent contribution of HAQ-DI and PASI scores to health utilities.

Table 69 shows the parameters used in each submission, alongside the values used in the York model. The Novartis algorithm, in addition to HAQ-DI and PASI, also includes age, sex and the baseline utility as explanatory variables, together with the response status for anti-TNF treatment. This implies that a different algorithm was defined according to PsARC response status. The algorithm also accounts for the decline in utility over time by including age as a covariate. Both submissions also used the algorithm adopted by the York model within a separate scenario analysis. The UCB Pharma and York algorithms are broadly consistent; however, the Novartis algorithm predicts a much smaller coefficient for HAQ-DI score (−0.172 units as opposed to −0.298 units in the York algorithm and −0.258 units in the UCB Pharma model). This implies a much smaller utility decrement for a unit increase in HAQ-DI score.

Summary of resource utilisation and costs data

In both models, resource use and costs were categorised in terms of drug acquisition, administration and monitoring and associated health state costs (i.e. according to HAQ-DI and PASI scores). In both models, it was assumed that DMARDs were used concomitantly with all biologic treatments (58% using MTX in the UCB Pharma model and 100% using MTX in the Novartis model). AE costs were included only in the Novartis model.

Drug acquisition costs

Both models estimated the acquisition costs for CZP based on the Patient Access Scheme currently under approval. There were differences in the approaches and costs used by the companies for SEC. In the Novartis model, the acquisition costs for 150 and 300 mg of SEC were based on the Patient Access Scheme for SEC. The Novartis model also evaluated only the 300-mg dose for the biologic-experienced subpopulation and the 150-mg dose for subpopulations 1 and 2 for reasons previously outlined. In the

TABLE 69 Utility algorithms used in the CSs

Parameter	Submission		
	Novartis: FUTURE 2 ⁴⁸ (SE)	UCB Pharma: RAPID-PsA ⁴⁷ (SE)	York model (SE)
Intercept	Confidential information has been removed	Confidential information has been removed	0.897 (0.006)
HAQ-DI score	Confidential information has been removed	Confidential information has been removed	−0.298 (0.006)
PASI total score	Confidential information has been removed	Confidential information has been removed	−0.004 (0.0003)
EQ-5D coefficient	Confidential information has been removed	N/A	N/A
Anti-TNF therapy status (anti-TNF naive was used as the reference for anti-TNF therapy status)			
Inadequate responder	Confidential information has been removed	N/A	N/A
Sex (female was used as the reference)			
Male	Confidential information has been removed	N/A	N/A
Age (years)	Confidential information has been removed	N/A	N/A
N/A, not applicable.			

UCB Pharma model, the acquisition costs for SEC were based on the list prices and a weighted cost was estimated for subpopulations 1 and 2 based on the 150- and 300-mg doses, based on the proportion of patients assumed to have concomitant moderate–severe psoriasis.

Both companies used national list prices [*British National Formulary* (BNF)¹³⁹ and an online and print prescribing database for health professionals (MIMS)] for other comparators and incorporated existing Patient Access Schemes for UST and GOL. In addition, both companies used a similar approach to estimating acquisition costs for INF by assuming a normal distribution of weights to determine the required number of vials based on patient-level data in the FUTURE 2⁴⁸ [mean 87.11 kg, standard deviation (SD) 19.66 kg] and RAPID-PsA⁴⁷ (mean 84.34 kg, SD 18.77 kg) trials. The drug acquisition costs for biosimilars in both submissions were sourced from MIMS (in 2016) and were approximately 90% of the price of the originator product.

Drug administration and monitoring costs

In terms of drug administration costs, the Novartis model assumed a half-day inpatient visit for each infusion for INF (£326.46). For all other (subcutaneously administered) biologics, resource use associated with administration was based on a single 30-minute session with a specialist community nurse in the first 3-month period in order to train patients in self-administration (£37.50). No administration costs were assumed for MTX.

In contrast, the UCB Pharma model assumed a cost of £159 for each infusion for INF based on the cost of delivering a simple parenteral chemotherapy (first attendance). For all other (subcutaneously administered) biologics and MTX, the UCB Pharma model assumed a cost of £43 based on the cost of a 1-hour nurse visit at a GP practice.

Although the two submissions included the same laboratory tests for monitoring PsA patients, there were differences in the costs that are applied for these. In the UCB Pharma submission, monitoring costs were defined as laboratory tests and estimated at £117.60 for the first 3 months and £21 for the subsequent 3 months. The monitoring costs for biologics applied in the Novartis model were lower, at £79 for the first 3 months and £4.20 for the subsequent 3 months.

Adverse events

Only the Novartis submission included the resource costs of AEs. These comprised the costs of TB reactivation (£3054) and other serious infections (£1527), based on the approach used for a separate NICE appraisal for ankylosing spondylitis (see TA383¹⁰⁴).

Health Assessment Questionnaire-Disability Index and Psoriasis Area and Severity Index costs

In the Novartis submission, HAQ-DI and PASI costs were estimated using the same approach as the York model (updated to 2016 costs). *Table 70* shows the inputs used by Novartis and the previous estimates used in the York model.

TABLE 70 Health Assessment Questionnaire-Disability Index and PASI costs applied in the Novartis model

Input	Cost (£)		Unit
	York model	Novartis model	
Intercept	233	255.78	Per 3 months
Cost per HAQ-DI score change	103	113.07	Per 1-unit change per 3 months
Health states			
Uncontrolled psoriasis (PASI < 75 units)	198	217.36	Per 3 months
Controlled psoriasis (PASI ≥ 75 units)	16	17.56	Per 3 months

In the UCB Pharma submission, health state costs for HAQ-DI and PASI were derived from a separate study by Poole *et al.*¹³⁸ The Poole *et al.*¹³⁸ study utilised data from a sample of PsA patients from the BSRBR to develop a multivariate model estimating disease severity from parameters routinely available in primary care data. The multivariate model was subsequently applied to routine data from The Health Improvement Network (THIN) to link to treatment and resource costs. These costs include costs of drugs, contacts with a GP and other health-care professionals, tests, hospital outpatient attendances and inpatient admissions. The relationship between disease severity and costs, based on HAQ-DI score, was then estimated using a generalised linear model. *Table 71* shows the coefficients from the generalised linear model.

Annual costs applied in the model were estimated using the following regression:

$$\text{Annual costs} = \text{Exp}(\text{Intercept} + \text{HAQ-DI coefficient} \times \text{HAQ-DI score} + \text{Age coefficient} \times \text{Age} + \text{Interaction coefficient} \times \text{HAQ-DI score} \times \text{Age}) \quad (3)$$

An adjustment was applied in the UCB Pharma model to avoid double counting prescription costs, which accounted for 38% of the total costs in the Poole *et al.*¹³⁸ study. Hence, HAQ-DI costs were assumed to be 62% of the total costs. The final costs were then uprated to 2015 values.

The UCB Pharma submission stated that, since the costs from Poole *et al.*¹³⁸ included all medical resource use for PsA patients, adding additional PASI-related costs would result in double counting. Consequently, PASI-related costs were not included in the model base case. A sensitivity analysis including PASI-related costs was undertaken based on the method used in the York model, with costs uprated to 2015 values.

Cost-effectiveness results from the company submissions

Subpopulation 1: biologic naive (one prior DMARD)

The base-case (deterministic) results for subpopulation 1 are reported in *Tables 72* (UCB Pharma model) and *73* (Novartis model). The UCB Pharma model reports an ICER of £23,666 per QALY based on the comparison of a sequence starting with CZP and a separate sequence starting with cDMARDs. The Novartis model reports an ICER of £12,189 per QALY based on a comparison of 150 mg of SEC versus

TABLE 71 Health Assessment Questionnaire-Disability Index and PASI costs applied in the UCB Pharma model

Coefficient	Mean	SE
Intercept	3.537	0.010
HAQ-DI coefficient	2.048	0.006
Age coefficient	0.026	0.000
Interaction coefficient, for interaction between HAQ-DI and age	-0.012	0.000

TABLE 72 Base-case results for subpopulation 1 (biologic naive, one prior DMARD): the UCB Pharma submission

Treatment	Total cost (£)	Total QALYs	Incremental cost (£)	Incremental QALYs	ICER (£)
cDMARDs	Confidential information has been removed	Confidential information has been removed	Confidential information has been removed	Confidential information has been removed	-
CZP	Confidential information has been removed	Confidential information has been removed	Confidential information has been removed	Confidential information has been removed	23,666

TABLE 73 Base-case results for subpopulation 1 (biologic naive, one prior DMARD): the Novartis submission

Treatment	Total costs (£)	Total QALYs	Incremental costs (£)	Incremental QALYs	ICER (£)
SoC	Confidential information has been removed	Confidential information has been removed	Confidential information has been removed	Confidential information has been removed	–
150 mg of SEC	Confidential information has been removed	Confidential information has been removed	Confidential information has been removed	Confidential information has been removed	12,189

SoC. Neither company included both CZP and SEC as relevant comparators in this subpopulation and hence direct comparisons of CZP and SEC are not possible in this subpopulation.

There appear to be large differences in the total costs and QALYs reported for the comparator treatment across the separate models. This may be partly explained by the different model time horizons (50 years in the UCB Pharma model and 40 years in the Novartis model), the inclusion of subsequent lines of biologic therapy and the different sources of cost data for HAQ-DI and PASI. The UCB Pharma submission reports higher incremental costs and QALYs for CZP relative to the comparator treatment than does the Novartis submission for 150 mg of SEC.

Subpopulation 2: biologic naive (one or more prior DMARDs, UCB Pharma; two or more prior DMARDs, Novartis)

The base-case (deterministic) results for subpopulation 2 are reported in *Tables 74* (UCB Pharma model) and *75* (Novartis model). The UCB Pharma model reports that CZP dominates all the other treatments, including SEC. In contrast, the Novartis model reports that 150 mg of SEC dominates all the other treatments with the exception of SoC (less costly and less effective than 150 mg of SEC) and INF (more costly and more effective than 150 mg of SEC). The ICER of 150 mg of SEC versus SoC is reported in the Novartis submission to be £10,549 per QALY and the ICER of INF versus 150 mg of SEC is £220,558 per QALY.

TABLE 74 UCB Pharma's base-case ICER results for subpopulation 2 (biologic naive, one or more prior DMARDs)

Treatment	Total cost (£)	Total QALYs	Incremental costs vs. next least costly intervention (£)	Incremental QALYs vs. next least costly intervention	ICER vs. next least costly intervention (£)
CZP	Confidential information has been removed	Confidential information has been removed	Confidential information has been removed	Confidential information has been removed	–
ADA	Confidential information has been removed	Confidential information has been removed	Confidential information has been removed	Confidential information has been removed	Dominated
GOL	Confidential information has been removed	Confidential information has been removed	Confidential information has been removed	Confidential information has been removed	Dominated
ETN	Confidential information has been removed	Confidential information has been removed	Confidential information has been removed	Confidential information has been removed	Dominated
SEC	Confidential information has been removed	Confidential information has been removed	Confidential information has been removed	Confidential information has been removed	Dominated
INF	Confidential information has been removed	Confidential information has been removed	Confidential information has been removed	Confidential information has been removed	Dominated

TABLE 75 Novartis' base-case ICER results for subpopulation 2 (biologic naive, two or more prior DMARDs)

Treatment	Total cost (£)	Total QALYs	Incremental costs vs. SoC (£)	Incremental QALYs vs. SoC	ICER vs. SoC (QALYs) (£)	ICER vs. next least costly intervention (£)
SoC	Confidential information has been removed	Confidential information has been removed	Confidential information has been removed	Confidential information has been removed	–	–
150 mg of SEC	Confidential information has been removed	Confidential information has been removed	Confidential information has been removed	Confidential information has been removed	10,549	10,549
CZP	Confidential information has been removed	Confidential information has been removed	Confidential information has been removed	Confidential information has been removed	28,432	Dominated by SEC
ETN	Confidential information has been removed	Confidential information has been removed	Confidential information has been removed	Confidential information has been removed	31,280	Dominated by SEC
GOL	Confidential information has been removed	Confidential information has been removed	Confidential information has been removed	Confidential information has been removed	33,802	Dominated by SEC
ETN	Confidential information has been removed	Confidential information has been removed	Confidential information has been removed	Confidential information has been removed	32,706	Dominated by SEC
INF	Confidential information has been removed	Confidential information has been removed	Confidential information has been removed	Confidential information has been removed	53,223	220,558

As both companies included both CZP and SEC as relevant comparators in this subpopulation, a direct comparison between the submissions is possible for subpopulation 2. Both companies report their own treatment to be the most cost-effective treatment at conventional cost-effectiveness thresholds and both report that their specific treatment dominates the other. The contrasting conclusions could arise from several important differences previously noted, including (1) different NMA approaches (i.e. the use of 24-week data by UCB Pharma in the base case vs. 12- to 16-week data from Novartis); (2) different acquisition costs and dosages assumed for SEC (weighted estimate for SEC based on list price costs of 150 mg of SEC and 300 mg of SEC in the UCB Pharma submission vs. Patient Access Scheme price for 150 mg of SEC assumed in the Novartis submission); (3) inclusion of subsequent lines of biologic therapy in the UCB Pharma submission; and (4) different sources of cost data for HAQ-DI and PASI and different model horizons.

As the UCB Pharma model did not present comparisons against a strategy of no biologic therapy, it is difficult to determine the external validity of the results presented for the comparator treatments. In contrast, the Novartis submission presents both fully incremental ICERs and pairwise ICERs versus SoC. The presentation of the pairwise ICERs versus SoC provides an important basis to consider issues of cross-validation based on the consistency of the findings for the comparator treatments and those reported from the broader comparator review presented earlier in *Chapter 5*. It is notable that the ICERs reported for the comparator treatments (ADA, ETN, GOL and INF) in the Novartis submission appear higher (i.e. less favourable) than reported in previous studies. Indeed, none of these comparator treatments would appear to be cost-effective versus SoC at conventional cost-effectiveness thresholds. The reason for this difference and implications in terms of external validity is not discussed in the Novartis submission.

Subpopulation 3: biologic experienced

The base-case (deterministic) results for subpopulation 3 are reported in *Tables 76* (UCB Pharma model) and *77* (Novartis model). The UCB Pharma model reports that CZP dominates UST and 300 mg of SEC. The least costly and least effective non-dominated treatment in the UCB Pharma model is mix (i.e. a mixture of cDMARDs and palliative care). The ICER of CZP versus mix is reported to be £8894 per QALY. In contrast, the Novartis model reports that 300 mg of SEC extendedly dominates CZP and UST. The ICER of 300 mg of SEC versus SoC is reported to be £27,562 per QALY.

Similar to the conclusions reported for subpopulation 2, both companies report their own treatment to be the most cost-effective treatment at conventional cost-effectiveness thresholds and both report that their specific treatment either dominates (UCB Pharma model) or extendedly dominates (Novartis model) the other.

TABLE 76 UCB Pharma's base-case ICER results for subpopulation 3 (biologic experienced)

Treatment	Total cost (£)	Total QALYs	Incremental costs vs. next least costly alternative (£)	Incremental QALYs vs. next least costly intervention	ICER vs. next least costly intervention (£)
Mix	Confidential information has been removed	Confidential information has been removed	Confidential information has been removed	Confidential information has been removed	–
CZP	Confidential information has been removed	Confidential information has been removed	Confidential information has been removed	Confidential information has been removed	8894
UST	Confidential information has been removed	Confidential information has been removed	Confidential information has been removed	Confidential information has been removed	Dominated by CZP
300 mg of SEC	Confidential information has been removed	Confidential information has been removed	Confidential information has been removed	Confidential information has been removed	Dominated by CZP

TABLE 77 Novartis' base-case ICER results for subpopulation 3 (biologic experienced)

Treatment	Total cost (£)	Total QALYs	Incremental costs vs. SoC (£)	Incremental QALYs vs. SoC	ICER vs. SoC (QALYs) (£)	ICER vs. next least costly intervention (£)
SoC	Confidential information has been removed	Confidential information has been removed	Confidential information has been removed	Confidential information has been removed	–	–
CZP	Confidential information has been removed	Confidential information has been removed	Confidential information has been removed	Confidential information has been removed	29,538	Extendedly dominated
UST	Confidential information has been removed	Confidential information has been removed	Confidential information has been removed	Confidential information has been removed	37,228	Extendedly dominated
300 mg of SEC	Confidential information has been removed	Confidential information has been removed	Confidential information has been removed	Confidential information has been removed	27,562	27,562

The Novartis submission, again, presents both fully incremental ICERs and pairwise ICERs versus SoC for subpopulation 3. Although pairwise comparisons versus the non-biologic comparator (mix) are not presented in the UCB Pharma submission, these can be estimated for UST versus mix from the data reported in its ICER results table. As with subpopulation 2, these provide an opportunity to consider issues of cross-validation in terms of the consistency of findings for one of the comparator treatments (UST) considered in the broader review. The ICER for UST versus SoC is reported to be £37,228 per QALY in the Novartis submission, indicating that UST is not cost-effective compared with SoC at conventional cost-effectiveness thresholds. Again, this appears inconsistent with previous studies reporting the cost-effectiveness of UST in a biologic-experienced population, and the reasons and possible implications in terms of external validity are not discussed in the Novartis submission. One possible explanation is the different approaches used in the Novartis submission for the experienced population (i.e. applying a common reduction in the efficacy rate to all treatments based on a comparison between the biologic-naive and biologic-experienced subgroups based on the FUTURE 2 trial⁴⁸ data, as opposed to using the actual subgroup data reported for UST). The pairwise comparison for UST versus mix, estimated from the results presented in the UCB Pharma results table, results in an ICER of £28,068 per QALY. This appears reasonably consistent with the ICER reported in TA340³⁵ for UST (£25,393 per QALY).

Relevance of submitted cost-effectiveness evidence for National Institute for Health and Care Excellence decision-making: summary and motivation for de novo model

The CSs are the only studies that directly assess the decision problem in relation to the new interventions [i.e. the positioning of these treatments within the pathway for PsA (biologic-naive and biologic-experienced populations)]. Although the studies, in relation to the broader comparators, are helpful in terms of highlighting similarities and possible differences between the approaches being applied by the separate companies and those previously used for previous TA appraisals, they are not directly relevant to the evaluation of SEC and CZP.

In general, the structure and approaches of both models were similar in many key respects to the York model conducted for TA199³³ (ETN, ADA and INF). The main differences were:

- The timing of the initial response period was assumed to be 24 weeks in the UCB Pharma submission and 3 months (i.e. 12–16 weeks) in both the Novartis submission (with the exception of UST) and the York model. The justification provided by Novartis for assuming 3 months for the initial response period was to ensure consistency with previous NICE appraisals and BSR/British Health Professionals in Rheumatology guidelines and to maximise the data included in the NMA. UCB Pharma justified the 24-week period based on 2011 EULAR guidelines, although results were also reported as part of separate sensitivity analysis assuming a 3-month response period.
- The definition of response in the Novartis base case (PsARC and PASI) differed from that used in the base-case approaches by both UCB Pharma and the previous York model (PsARC only). The Novartis submission presented a separate sensitivity analysis assuming that response was assessed using just PsARC, and this reported only minor differences from its base case.
- The UCB Pharma base case focused on sequences and the incorporation of subsequent lines of treatments as opposed to presenting this as a separate exploratory scenario (Novartis and York models).
- In common with the York model, the Novartis model assumed that the HAQ-DI score gain reported at 3 months was the maximum reduction achieved on treatment and assumed no further change (i.e. increase or decrease) beyond this period for patients while they remained on this treatment. In contrast, the UCB Pharma model employed different assumptions during the initial 9-month treatment (i.e. that the highest rate of change is obtained at 4 weeks, but further improvements in HAQ-DI score are possible during a period of 9 months for a responding patient who remains on treatment). After 9 months, the UCB Pharma model assumed no further change beyond this period for patients while they remained on this treatment.

- Assumptions related to the rebound effect on HAQ-DI score following treatment withdrawal. The UCB Pharma submission assumes that a patient's HAQ-DI score rebounds to a worse position than the original baseline value when they switch to the next treatment. Both the Novartis and York models assume that a patient's HAQ-DI score rebounds to its original baseline value.
- The Novartis and UCB Pharma submissions include additional subpopulations (subpopulations 1 and 3), based on the broader scope for the appraisal of SEC and CZP compared with the scope of TA199.³³
- The Novartis submission estimates costs associated with HAQ-DI and PASI based on the same sources and assumptions previously used in the York model. In contrast, the UCB Pharma submission based costs on a separate study by Poole *et al.*¹³⁸ and justified this on the basis that the use of a PsA population was more appropriate than deriving costs based on a RA population and employing separate assumptions for PASI costs.
- Although UCB Pharma assumed the same annual withdrawal rate as the York model (16.5% per annum), the UCB Pharma submission applied this only to the first 4 years of a treatment. Thereafter it was assumed that no patient would withdraw. This assumption was justified by UCB Pharma based on the lack of longer-term evidence reported for withdrawal. Novartis utilised withdrawal data from its trial population (FUTURE 2 trial⁴⁸) and applied a (confidential information has been removed) per annum rate for the first year and (confidential information has been removed) for subsequent years.
- By assuming a mean PASI score of > 10 units, the UCB Pharma base-case results relate to an 'average' PsA patient with concomitant moderate–severe psoriasis (i.e. $\geq 3\%$ of BSA affected and a PASI score of > 10 units). In contrast, the Novartis base-case results relate to an 'average' PsA patient with concomitant mild–moderate psoriasis ($\geq 3\%$ of BSA affected and a PASI score of ≤ 10 units), similar to the base case in the York model. Both the UCB Pharma and York model also presented separate sensitivity analyses based on different PASI scores, which reflected subgroups of PsA patients without concomitant psoriasis and with concomitant moderate–severe psoriasis. Separate sensitivity and scenario analyses were not presented in the Novartis submission.
- The time horizon was assumed to be 40 years in the Novartis and York models and 50 years in the UCB Pharma model.

As highlighted in *Results*, drawing robust conclusions from the results reported from the separate companies is challenging given the differences noted in the approaches and data sources employed. Comparisons in subpopulation 1 are not possible as neither company included the other treatment in their comparisons. The difficulty of comparing results across subpopulations 2 and 3 are further hampered by the different assumptions made concerning the dosage of SEC included and in both subpopulations 2 and 3 based on the use of list prices for SEC in the UCB Pharma submission and Patient Access Scheme prices in the Novartis submission.

Assessments of cross-validity were possible for subpopulations 2 and 3 based on the Novartis results presented for comparator treatment and those reported in previous studies. The results from the Novartis model did not appear consistent with the cost-effectiveness reported for the comparator treatment assessed in previous NICE TAs (see TA199,³³ TA220¹³³ and TA340³⁵). A discussion of possible reasons for this difference was not provided in the Novartis submission. An assessment of cross-validity was possible only in terms of subpopulation 3 for the UCB Pharma submission. Here the reported ICER appeared reasonably consistent for the main comparator treatment (UST) and the ICER reported in the previous NICE TA (TA340³⁵).

Given the different approaches and assumptions employed by the companies, there remains considerable uncertainty regarding the cost-effectiveness of both SEC and CZP in each of the subpopulations and potential implications for the NHS. These differences make it challenging to draw robust conclusions from the current submissions, particularly given the contradictory findings reported for several of the subpopulations in terms of the relative cost-effectiveness of SEC and CZP. Furthermore, neither company incorporated the full range of interventions and comparators as stated in the NICE scope¹¹² across all three subpopulations. The following chapter describes the development of a *de novo* model that attempts to address several areas of remaining uncertainty and to apply a consistent basis for evaluating the cost-effectiveness of the full range of interventions and comparators as stated in the NICE scope¹¹² across all three subpopulations.

Chapter 6 Independent economic assessment

Introduction

The review of published models, and the CSs, show that the underlying structure used to model the cost-effectiveness of treatments for PsA has remained largely unaltered since the previous York model for TA199.³³ Despite the similarity observed across studies in terms of the model structure, important differences were identified in terms of associated assumptions and data sources. None of these can be considered unequivocally superior to the others; however, there are a number of issues with each of the currently available models (see *Chapter 5, Relevance of submitted cost-effectiveness evidence for National Institute for Health and Care Excellence decision-making: summary and motivation for de novo model*).

In terms of the previous York model, this does not consider all of the subpopulations defined in the NICE scope¹¹² for this assessment. Currently available guidance, issued by NICE on the use of biologics in PsA,¹⁴⁰ recommends that patients try two cDMARDs over a 6-month period before they can be considered for biologic treatment in accordance with current BSR guidelines. However, as defined in the NICE scope for this appraisal, three subpopulations need to be considered:

1. subpopulation 1 (biologic naive, one prior DMARD)
2. subpopulation 2 (biologic naive, two or more prior DMARDs)
3. subpopulation 3 (biologic experienced or contraindicated).

The two CSs consider these three subpopulations in their economic models; however, neither includes the full range of relevant treatments for all of the subpopulations and neither specifically considers patients contraindicated to existing biologic treatments.

In modelling the cost-effectiveness of available treatments, it is also important to consider the possibility that patients may switch to another active treatment, following primary failure (non-response) or secondary withdrawal (initial response with later withdrawal due to AE or loss of efficacy). Therefore, a key objective of the de novo model is to assess the cost-effectiveness of SEC and CZP for PsA within possible sequences of available treatments.

Methods

Overview

A decision-analytic model was developed to estimate the cost-effectiveness of SEC and CZP compared with other relevant comparators, including ETN, INF, ADA, GOL, UST and BSC for the treatment of adult PsA. BSC is defined as a mix of cDMARDs and usual care (see *Choice of intervention and comparators*). A different set of comparators are defined according to each subpopulation of interest (see *Patient characteristics*).

The cost-effectiveness model takes the form of a Markov cohort model with 3-monthly cycles, developed using R programming language (see *Appendix 7* for the full model code). A lifetime horizon (40 years) is assumed. A half-cycle correction was not applied as the cycle length is 3 months, which is relatively short and, therefore, half-cycle correction is unlikely to be required.¹¹⁹

Although the model shares a number of important characteristics with the previous York model, several significant changes have also been implemented. These include:

- The base-case model attempts to replicate ‘real-world’ clinical practice, in terms of incorporating subsequent biologic treatments following a primary lack of response or secondary failure. Ignoring these subsequent treatment lines and/or assuming patients move directly onto BSC following failure of an initial biologic treatment, could result in overly optimistic estimates of cost-effectiveness of new (and more effective) interventions. This may arise because the consequences of treatment failure are likely to be overstated compared with real-world clinical practice, as additional treatment options remain which are more cost-effective than BSC alone. Although exploratory scenarios were considered in the previous York model in relation to treatment sequences, the formal inclusion of further lines of treatment within the base model necessitated significant amendments to the previous R code.
- The model now includes the three subpopulations specified in the NICE scope¹¹² for this appraisal.
- Rather than presenting a single base case reflecting an ‘average’ PsA patient, heterogeneity in terms of baseline PASI score is now formally addressed by presenting results for three distinct subgroups within each subpopulation: (1) PsA without concomitant psoriasis; (2) PsA with concomitant mild–moderate psoriasis ($\geq 3\%$ of BSA and a PASI score of ≤ 10 units); and (3) PsA with concomitant moderate–severe psoriasis ($\geq 3\%$ of BSA and a PASI score of > 10 units). Differences in baseline PASI score were previously considered in the previous York model as part of a sensitivity analysis. However, as the decision problem differs across the specific subgroups as a result of the different licensed dosages of SEC, it was considered more appropriate to model these subgroups separately.

Outcomes are expressed using QALYs.¹⁴¹ The QALY provides a summary measure combining estimates of the remaining length of life (life-years) and its associated quality. QALYs are derived from health-related utilities by multiplying a utility value (quality of life) by the time spent with this utility (length of life). Utility values are generated from the main clinical outcomes of the disease, HAQ-DI reflecting the arthritis component and PASI representing the psoriasis element (see *Sources of utility data*). These clinical scores (HAQ-DI = 0–3 units and PASI = 0–72 units) represent the health states of the model and are also associated with health-care resource use and costs (see *Health state costs*).

The parameters of the model were obtained from published literature, data reported in the CSs and the results of the evidence synthesis in *Chapter 4*. The model adopts a NHS and Personal Social Services perspective. A price year of 2016 is assumed and a 3.5% annual discount rate is applied to costs and QALYs.¹²⁵ Probabilistic sensitivity analysis (PSA) was conducted as is reported separately from the deterministic results.

Model structure and assumptions

Figure 15 illustrates the model structure. The structure remains largely unchanged since the previous York model (see *Figure 8*). However, in the updated York model, patients who withdraw from an initial treatment during cycle 1 because of a lack of response or as a result of AEs (or later cycles for patients who initially respond) are assumed to be eligible to receive further treatments prior to moving to BSC. The subsequent treatment lines are defined separately for each of the three subpopulations (see *Choice of intervention and comparators*).

Patients enter the model and receive one of the treatments or BSC, relevant to each particular subgroup. Patients remain on treatment for 3 months (13 weeks), after which, if they respond, defined using PsARC, they continue on the treatment; otherwise they move to BSC or another biologic treatment, if the sequence allows.

The PsARC response data reported in the clinical trials (see *Chapter 4*) dichotomise patients into two groups: responders and non-responders (as a result of lack of efficacy or AEs). In accordance with current BSR guidelines (and to ensure consistency with previous NICE TAs), only PsARC response is used to determine continuation on treatment. PsARC responders/non-responders are further stratified according to PASI response status, to provide a more granular assessment of utilities and costs. PsARC and PASI

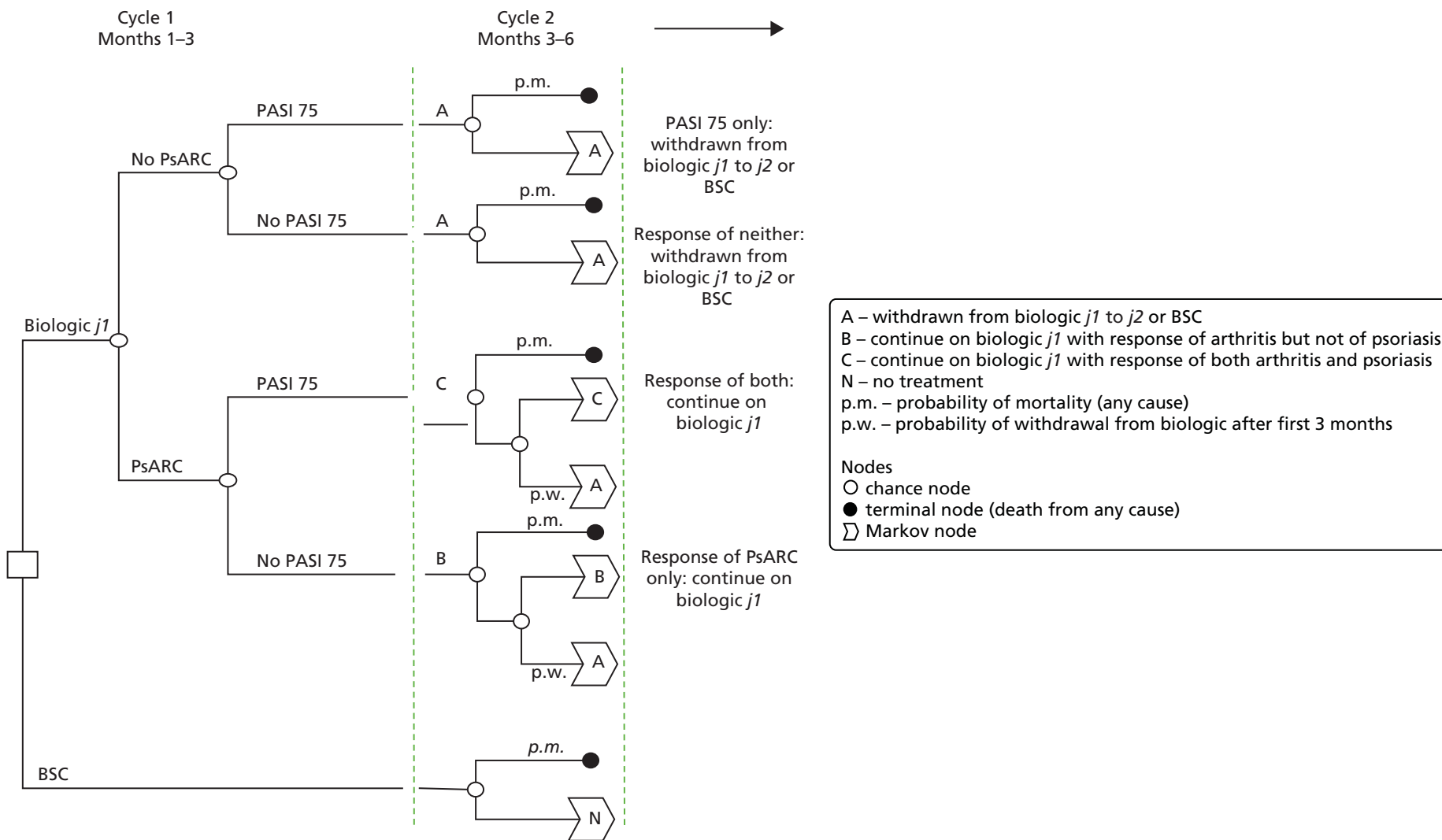

FIGURE 15 Overview of the model structure.

responses are assumed to be correlated. For consistency, the same correlation coefficient (0.4) applied in the previous York model is assumed. This value is also assumed to apply across all subpopulations, subgroups and individual treatments.

The PASI changes observed in the clinical trials are categorised according to the proportion of patients who achieve at least 50%, 75% and 90% improvement in their baseline PASI score (PASI 50, PASI 75 and PASI 90, respectively). The calculation of the expected improvement in PASI score for PASI 75 responders and non-responders is equivalent to the approach used in the previous York model.³³ That is, the new model also assumes that patients who achieve a PASI 75 response will gain at least a 75% improvement in psoriasis compared with baseline PASI score, with some achieving a 90% improvement. Similarly, patients who do not achieve a PASI 75 response may achieve PASI 50.

Functional capability, in terms of the arthritis component of the disease, is measured using the HAQ-DI. A relationship between PsARC response and HAQ-DI score is explicitly considered in the current model. The change in baseline HAQ-DI score is assumed to be conditional on PsARC response status. To ensure that the treatment effect is reproducible in the clinical practice, an adjustment for the placebo or expectation effect is applied within the new model. This adjustment follows the same methods employed in the previous York model.

An individual's HAQ-DI and PASI score determine health state costs (in addition to treatment-related costs) and QALYs; hence, the model tracks these clinical scores over time. The new model employs 'tunnel' states¹⁴² to reflect how long patients stay in a particular health state (HAQ-DI and PASI scores) and when they move (switch to another treatment) (see *Choice of intervention and comparators*). The ability to build multidimensional arrays, facilitated through the use of R, enables this functionality and the inclusion of subsequent lines of treatments, either after the initial response period or during the longer-term period.¹⁴³

After the treatment response period, responders are subject to an ongoing risk of withdrawal from treatment as a result of lack of efficacy or the occurrence of AEs (modelled together as an overall risk of withdrawal). HAQ-DI and PASI scores again change according to the second-line treatment received and associated response status. It is assumed that PsARC responders continuing on treatment after the initial 3-month response period maintain their improvement in HAQ-DI and PASI scores until subsequent withdrawal (i.e. no progression in HAQ-DI and PASI scores). Once patients withdraw from treatment to BSC, or to another biologic treatment, their HAQ-DI and PASI scores rebound to their baseline values (see *Withdrawal from treatment and the natural history of psoriatic arthritis*).

A summary of data inputs used in the model is given in *Table 78*. These are described in detail in the relevant sections that follow. The effectiveness data utilised in the model are shown separately in *Table 79* in *Sources of effectiveness data*. The variable names in both tables follow those used in the R code, reported in *Appendix 7*.

Patient characteristics

As discussed in *Overview*, the NICE scope¹¹² for this appraisal specified three specific subpopulations of interest, reflecting the various stages of the treatment pathway for adult PsA. These three subpopulations are subsequently referred to as:

1. subpopulation 1: biologic naive, one previous cDMARD
2. subpopulation 2: biologic naive, two or more previous cDMARDs
3. subpopulation 3: biologic experienced.

Within subpopulation 3, the availability of evidence relating to CZP, necessitates the specification of a further scenario analysis to address the subgroup of patients who have previously responded to biologic treatment (primary responders), but who have subsequently withdrawn as a result of loss of efficacy or the occurrence of an AE.

TABLE 78 Summary of data inputs for the York model

Description	Variable name	Mean	SE	Source/appendix
Sex: male = 1, female = 0	Male	1		
Baseline HAQ-DI score	HAQ-DIO	1.22		Mean of RCTs (see Chapter 4)
Baseline age	Age	47		Mean of RCTs (see Chapter 4)
Model time horizon cycles	num_cycles	160		Clinical opinion
Cycle length, year	CI	0.25		
Discount rate (per year)	r	0.035		UK treasury ¹⁴⁴
Utility function intercept	h0	0.897	0.006	Rodgers <i>et al.</i> , 2011 ³³
Change in utility for a 1-unit change in HAQ-DI score	h1	-0.298	0.006	
Change in utility for a 1-unit change in PASI score	h2	-0.004	0.0003	
Interaction term HAQ-DI PASI	h3	0	10 × E ⁻⁵	
Change in HAQ-DI score while on treatment per 3-month period	HAQ-DI1.d	0		Rodgers <i>et al.</i> , 2011 ³³
Change in HAQ-DI score while not on treatment per 3-month period	HAQ-DI1.w	0.018	0.007	Rodgers <i>et al.</i> , 2011 ³³
Rebound in HAQ-DI score on withdrawal (compared with HAQ-DI score at baseline) (zero means 'rebound equal to initial gain')	loss.w	0		Assumption
Intercept of regression of log-mortality vs. age in men	ln.R.g.m	-10.25	0.046	Gompertz parameters parameterising life table data for England and Wales ¹⁴⁵
Intercept of regression of log-mortality vs. age in women	ln.R.g.f	-11.10	0.046	
Change in log-mortality with additional year of age in men aged > 40 years	a.g.m	0.094	0.0006	
Change in log-mortality with additional year of age in women aged > 40 years	a.g.f	0.101	0.0006	
Standardised mortality ratio for PsA vs. general population	SMRmen SMRwomen	1.36		Ali <i>et al.</i> , 2007 ¹⁴
Log-withdrawal rate from biologics per year	ln.long.yr	-1.823	0.2044	Rodgers <i>et al.</i> , 2011 ³³
Correlation between PASI 75 and PsARC	rho.new	0.4	0.1	ADEPT ⁵⁵

In addition, in the NICE scope¹¹² for this appraisal, a further population (subpopulation 4) contraindicated to TNF- α inhibitors (including ETN, ADA, INF and GOL) was also considered for SEC. CZP was not considered within the contraindicated population on the basis that, in patients in whom other TNF- α inhibitors are contraindicated, CZP (a new TNF- α inhibitor) would probably also be contraindicated.

In the updated York model, separate versions of the model are specified, representing each of the three main subpopulations. In the base case of each of these models, the baseline age is assumed to be 47 years and mean baseline HAQ-DI score is 1.22 units. These values represent the average baseline characteristics from the included trials (see Chapter 4). Baseline weight is required for administration of INF; however, not all trials report these values. Here the weight distribution reported in the RAPID-PsA trial⁴⁷ is used (see *Treatment costs*).

As discussed in *Chapter 5*, it is also important to consider the impact of differences in baseline characteristics, in terms of HAQ-DI and, particularly, PASI scores, and the impact that these differences have on cost-effectiveness and the choice of optimal treatment. This is a particular issue in terms of the severity of concomitant psoriasis, as 300 mg of SEC, as opposed to the standard dose of 150 mg of SEC, is approved in patients with more severe psoriasis. To explore the impact of severity of the psoriasis component of the disease on cost-effectiveness, separate analyses are presented according to three concomitant psoriasis subgroups. Clinical opinion suggests that about 50% of patients who receive biologic treatment have mild or minimal concomitant psoriasis (< 3% of BSA or a PASI score of < 2.5 units), 25% have mild–moderate concomitant psoriasis (a baseline PASI score between 2.5 and 10 units) and 25% have moderate–severe concomitant psoriasis (a PASI score of > 10 units).¹²⁸ These definitions have been used as the basis for the three concomitant psoriasis subgroups formally considered here:

- no concomitant psoriasis, with a baseline PASI score of 0 units
- mild–moderate concomitant psoriasis, with a baseline PASI score of 7.3 units (the same value used in the previous York model)
- moderate–severe concomitant psoriasis, with a baseline PASI score of 12.5 units (the same value used as part of a separate sensitivity analysis presented in the previous York model).

In the absence of effectiveness data reported for these subgroups, an assumption is made that treatments are similarly effective (in relative terms) for each subgroup within the separate subpopulations. Hence, the differences in cost-effectiveness for these subgroups are driven entirely by the different baseline PASI scores and the subsequent impact on costs and outcomes of these differences.

Baseline HAQ-DI scores are assumed the same across the separate subpopulations and PASI subgroups. Differences in baseline HAQ-DI scores were considered in a separate sensitivity analysis based on estimates reported in the UCB Pharma submission.

Choice of intervention and comparators

- In subpopulation 1, only SEC, CZP and BSC are included in accordance with the NICE scope.¹¹² Based on the licence of SEC, 150 mg of SEC is included for the no-concomitant PASI and mild–moderate PASI subgroups in the naive populations and 300 mg of SEC for the severe psoriasis subgroup.
- In subpopulation 2, SEC, CZP and other TNF- α inhibitors (ETN, INF, ADA and GOL) are considered to be relevant treatment alternatives in accordance with the NICE scope. BSC includes cDMARDs according to the placebo response rates as observed in the trials and costs according to HAQ-DI and PASI health states (see *Health state costs*). Again, in accordance with the licence of SEC, 150 mg of SEC is evaluated for the no-concomitant PASI and mild–moderate PASI subgroups in the naive populations and 300 mg of SEC for the severe psoriasis subgroup.
- In subpopulation 3, 300 mg of SEC, CZP, UST and BSC (as defined above) are regarded as relevant treatment alternatives in accordance with the NICE scope.¹¹² As previously stated, as the data available for CZP inform only a subgroup of subpopulation 3, a separate analysis is conducted for CZP compared with BSC (see *Patient characteristics*).
- In the additional contraindicated subpopulation (subpopulation 4), SEC, UST and BSC (as defined above) are regarded as relevant treatment alternatives. An assumption is made for this subpopulation that patients in whom TNF- α inhibitors are contraindicated are biologic naive and hence the effectiveness data are derived from this population. In reality, it is recognised that contraindications (e.g. infection, TB activation) may arise after a TNF- α inhibitor has been tried. However, for simplicity this analysis assumes patients are biologic naive. Hence, in accordance with the licence of SEC, 150 mg of SEC is evaluated for the no-concomitant PASI and mild–moderate PASI subgroups in the naive populations and 300 mg of SEC for the severe psoriasis subgroup.

In accordance with the NICE scope¹¹² for this appraisal, APR was not included as a comparator in any of the subpopulations, as at the time this report was completed it had not been approved for use in adult PsA by NICE.

A key element of updating the previous York economic model is the formal incorporation of subsequent lines of therapy assumed within the base case. Specifically, the updated model allows for patients to move (switch) to a second treatment rather than to BSC as a result of primary non-response or secondary failure of treatment. The model also allows third- and fourth-line treatments. This functionality is enabled in the R by including tunnel states to track the HAQ-DI and PASI scores of patients who switch therapy. Tunnel states are generated for every cycle in the model (160 cycles). Further tunnel states are generated within this structure where patients can switch to a third and fourth treatment. This significantly increases the size of the Markov structure compared with the previous York model.

The length of the treatment sequence depends on the subpopulation: subpopulation 1 (biologic naive, one previous cDMARD) is eligible to receive three lines of treatment before moving to BSC; subpopulation 2 (biologic naive, two or more previous cDMARDs) is eligible to receive two lines of treatment before moving to BSC; and subpopulation 3 (biologic experienced) is eligible to receive one treatment before moving to BSC. Subpopulation 4 is assumed to be equivalent to subpopulation 3 in terms of sequencing, the only difference being the use of 150 mg of SEC as opposed to 300 mg of SEC.

The sequences of treatments are shown in *Figures 16–18* for the main subpopulations 1, 2 and 3, respectively. Only the biologic-naive populations are eligible to receive further active treatments once they have failed on their initial treatment.

- In subpopulation 1, patients may be eligible to receive further biologics. ETN is assumed to be the next biologic treatment as part of the overall sequence, on the basis that it is the lowest cost currently approved biologic and because it was consistently reported to be more cost-effective than other TNFs in previously published studies.³³ Following failure of ETN, patients are assumed to receive UST before moving onto BSC.
- In subpopulation 2, patients are assumed to subsequently receive UST (approved in the biologic-experienced population) before moving onto BSC.
- Patients in subpopulation 3 are assumed to move to BSC after failure of 300 mg of SEC, UST or CZP (secondary failures only).

Etanercept and INF are available as the originator products or biosimilars. The originator product of ETN is ENBREL and the biosimilar version is Benepali (SB4, Biogen Idec Ltd, Maidenhead, UK). The originator product of INF is REMICADE® (Janssen Pharmaceuticals/ Merck Sharp & Dohme) and the biosimilar versions are Inflectra® (Hospira UK Ltd, Maidenhead, UK), Remsima (Napp Pharmaceuticals Ltd, Cambridge, UK) and SB2 (Samsung Bioepis Co. Ltd, Seoul, Korea). In each of the base-case scenarios, the list prices for the originator products of ETN and INF are assumed. A separate analysis is presented using the prices of the biosimilar products (see *Appendix 8*). The biosimilar analysis is restricted to subpopulation 2. In this separate analysis the biosimilar versions are assumed to be equivalent to the originator products in terms of effectiveness.

Withdrawal from treatment and the natural history of psoriatic arthritis

As the psoriasis element of PsA is not progressive, it is assumed that PASI score does not increase over time for patients receiving BSC. The arthritis element of PsA is assumed to be progressive, consistent with the clinical evidence (see *Chapter 4*). Therefore, for patients not receiving biologic therapies, the HAQ-DI

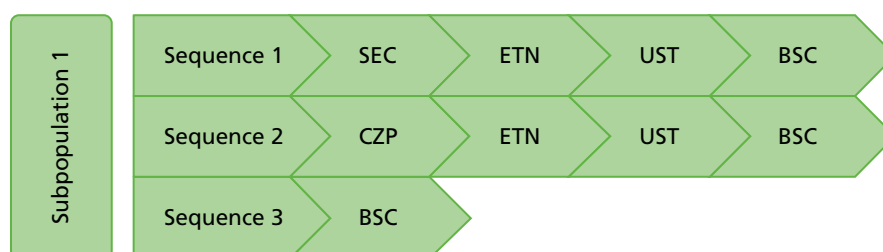

FIGURE 16 Treatment sequences in subpopulation 1.

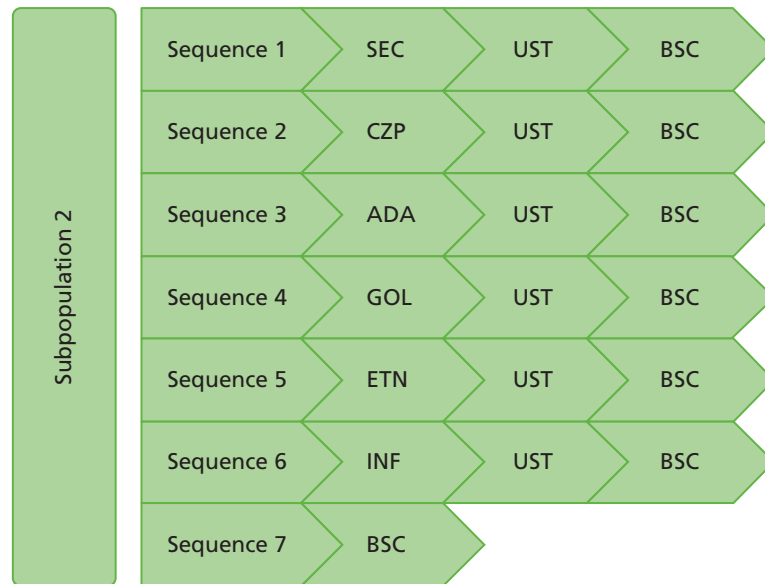

FIGURE 17 Treatment sequences in subpopulation 2.

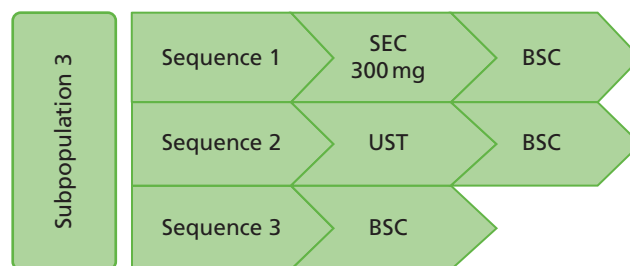

FIGURE 18 Treatment sequences in subpopulation 3.

score is assumed to worsen over time, reflecting the decrease in functional capability as the arthritis component of the disease progresses. In the absence of a more appropriate alternative identified in the review of long-term open-label data (see *Chapter 3, Open-label extension studies*) and registry data (see *Chapter 3, Review of anti-tumour necrosis factor patient registry studies*), the rate determined in the previous York model, derived from the NOAR, was utilised in the updated York model. This rate of 0.018 units per 3-month cycle is assumed to be constant over time. *Figure 12* shows the trajectory of HAQ-DI scores over time, for patients receiving BSC alone.

For PsARC responders, there is a risk of withdrawal following the first cycle of the model (3 months). This risk is due to AEs and loss of efficacy. Based on the previous York model, this probability is estimated from a meta-analysis of registry data from several countries to be -1.823 (SE 0.2044) on the log-scale, or $\exp(-1.823 + 0.5 \times 0.2044^2) = 0.165$ per year. This probability of withdrawal (0.165 per year) is assumed to be independent of HAQ-DI and PASI score in the model, relevant for all comparators and is constant over time. Alternative scenarios were specified according to those reported in the CSs (see *Scenario analyses*).

Following withdrawal, the 'rebound' of HAQ-DI and PASI scores is assumed to be equivalent to the gain. This assumption is consistent with the previous York model (see *Figure 12*). The rebound effect is assumed to happen immediately following withdrawal.

Sources of effectiveness data

The effectiveness data applied in the economic model are derived from the NMA, reported separately in *Chapter 5*. Three outcomes were included in the NMA to inform the economic model: (1) PsARC response, (2) change in HAQ-DI score conditional on PsARC response and (3) PASI 50, PASI 75 and PASI 90 responses.

The NMA implemented separate models for the pooling of treatment effects and placebo responses. A number of alternative models were implemented to explore the possibility of placebo response determining the effectiveness of alternative treatments, and also whether or not there was similarity between treatment effects for treatments of the same class. These are discussed in detail in *Chapter 5*. The following sections specify the approaches used in the economic model for each of the three outcomes.

Psoriatic Arthritis Response Criteria response

Chapter 5 details the data available for PsARC response, for each of the comparators. The NMA implemented seven alternative models for PsARC response in the naive populations (see *Table 41*).

Owing to data limitations, these could be specified only for all biologic-naive patients (i.e. not separately for subpopulations 1 and 2). Of these seven models, two were considered to be the preferred models on the basis of model fit, goodness-of-fit statistics and clinical plausibility. These are:

1. Model A1: no baseline adjustment. Assumes that the treatments are independent (fixed effect) and, therefore, utilises the baseline and treatment effects as observed in the trial.
2. Model D2: a metaregression on baseline risk (placebo response). Treatments within a class have similar (exchangeable) effectiveness and depend on the effect of the placebo arm. Shrunken estimates are reported to account for the differences between treatments. The Genovese *et al.*⁵⁶ and Mease *et al.*⁵³ trials are included.

Results for the two preferred PsARC models, in the naive population, are presented in *Table 43*. These show the median probabilities and ORs.

For the biologic-experienced population (subpopulation 3), it was not possible to conduct a metaregression because of data limitations; therefore, only independent analysis estimates are available for this subpopulation (model A1). As discussed in *Patient characteristics*, the data from the RAPID-PsA trial (CZP)⁴⁷ were not included in the analysis. Results for the biologic-experienced population are presented in *Table 45*. These show the median probabilities and ORs.

Health Assessment Questionnaire-Disability Index changes conditional on Psoriatic Arthritis Response Criteria response

Given that HAQ-DI scores are modelled conditional on PsARC response, modelling an interaction effect between baseline and treatment effect was deemed to be less relevant, and a metaregression model was not implemented on HAQ-DI (see *Chapter 4, Health Assessment Questionnaire-Disability Index conditional on Psoriatic Arthritis Response Criteria response/non-response*). Instead, three models are implemented in the biologic-naive populations (see *Chapter 4, Health Assessment Questionnaire-Disability Index changes conditional on Psoriatic Arthritis Response Criteria response/non-response, Subpopulation: biologic naive*), two of which model a class effect for treatments. Again, as a result of data limitations, these could be specified only for all biologic-naive patients. Of these three models, two were considered to be the preferred models on the basis of model fit, goodness-of-fit statistics and clinical plausibility. These are:

1. Model E1: no baseline adjustment. Assumes that the treatments are independent (fixed effect) and, therefore, utilises the baseline and treatment effects as observed in the trial.
2. Model E2: no baseline adjustment. A class effect is applied comprising three groups: anti-TNFs, ILs and APR. Treatments are similar within class (exchangeable) and there is a fixed effect across studies.

The results for the two preferred HAQ-DI change models, in the naive population, are presented in *Table 47*. These show the absolute median changes (with a more negative number representing a larger HAQ-DI score improvement).

For the biologic-experienced population (subpopulation 3), it was not possible to determine a class effect; therefore, only independent analysis estimates are available for this subpopulation (model E1). As discussed in *Chapter 4, Health Assessment Questionnaire-Disability Index conditional on Psoriatic Arthritis Response Criteria response/non-response*, the data from the RAPID-PsA trial (CZP)⁴⁷ were not included in the analysis. Results for the biologic-experienced population are presented in *Table 49*. These show the absolute median/mean HAQ-DI score changes.

Psoriasis Area and Severity Index 50, 75 and 90 responses

Chapter 5 details the data available for PASI response, for each of the comparators. The NMA utilised a framework of analysis that evaluated the probability of PASI responses in different categories of PASI thresholds (50/75/90) within a single model. For the economic model this was used to determine the probabilities of achieving PASI 50, PASI 75 and PASI 90.

The NMA implemented three alternative models for PASI response in the naive populations (see *Table 51*). Owing to data limitations, these could be specified only for all biologic-naive patients. Of these three models, two were considered to be the preferred models on the basis of model fit, goodness-of-fit statistics and clinical plausibility. These are:

1. Model F1: no baseline adjustment. Assumes that treatments are independent and fixed effect on cut-off points/thresholds.
2. Model G2: common interaction term with baseline effect. Assumes that treatments are independent, but treatment effects are adjusted with the trial-specific baseline effects assuming a common interaction term.

The results for the two preferred PASI response models, in the naive population, are presented in *Table 53*. These show the median probabilities for PASI 50, PASI 75 and PASI 90.

For the biologic-experienced population (subpopulation 3), it was not possible to determine a class effect; therefore, only independent analysis estimates are available for this subpopulation (model F1). As discussed in *Chapter 4, Psoriasis Area and Severity Index Psoriasis Area and Severity Index response*, the data from the RAPID-PsA trial (CZP)⁴⁷ were not included in the analysis. Results for the biologic-experienced population are presented in *Table 55*. These show the median/mean probabilities and ORs.

Combinations of evidence synthesis estimates utilised in the economic model

As discussed in the sections above, results are available for two alternative evidence synthesis models, for each of the three outcomes (PsARC response, change in HAQ-DI score conditional on PsARC response and PASI 50, PASI 75 and PASI 90 responses). The economic model utilises two combinations of these results for PsARC response, HAQ-DI score conditional on PsARC response and PASI response. These are:

- independent analysis: PsARC response (model A1), HAQ-DI conditional on PsARC response (model E1) and PASI response (model F1)
- metaregression: PsARC response (model D2), HAQ-DI conditional on PsARC response (model E2) and PASI response (model G2).

Table 79 presents the effectiveness data used in the updated York model. The clinical effectiveness results reported in *Chapter 4* are, on the whole, reported as medians. The economic model instead utilises the means from the NMA. The means represent the most appropriate values for the economic model in order to inform a decision regarding the expected cost-effectiveness of competing treatments.

Correlation between Psoriatic Arthritis Response Criteria and Psoriasis Area and Severity Index responses

Although treatment continuation is determined by PsARC response, the model needs to consider the proportion of those patients who achieve PASI 75 together with PsARC, as this cohort has a different PASI score, and hence incurs different costs and QALYs. Based on previously published models and the CSs,

TABLE 79 Effectiveness data utilised in the economic model

Parameter	Name	Value	Source					
Placebo responses for biologic-naïve population: treatment effects from the independent analysis								
Probability of a PsARC response	p.psarc.plac2	0.3073	See Chapter 4					
Change in HAQ-DI score given a PsARC response	HAQ-DI.resp.plac2	-0.2629						
Probability of a PASI 50 response	p.pasi.50.plac2	0.153						
Probability of a PASI 75 response	p.pasi.75.plac2	0.054						
Probability of a PASI 90 response	p.pasi.90.plac2	0.015						
Placebo responses for biologic-naïve population: treatment effects from the metaression								
Probability of a PsARC response	p.psarc.plac2	0.3073	See Chapter 4					
Change in HAQ-DI score given a PsARC response	HAQ-DI.resp.plac2	-0.2579						
Probability of a PASI 50 response	p.pasi.50.plac2	0.155						
Probability of a PASI 75 response	p.pasi.75.plac2	0.055						
Probability of a PASI 90 response	p.pasi.90.plac2	0.016						
Placebo responses for biologic-experienced population: treatment effects from the independent analysis								
Probability of a PsARC response	p.psarc.plac3	0.268	See Chapter 4					
Change in HAQ-DI score given a PsARC response	HAQ-DI.resp.plac3	-0.134						
Probability of a PASI 50 response	p.pasi.50.plac3	0.103						
Probability of a PASI 75 response	p.pasi.75.plac3	0.012						
Probability of a PASI 90 response	p.pasi.90.plac3	0.004						
		Treatment						
Description	Variable name	ETN	INF	ADA	GOL	CZP	150 mg of SEC	300 mg of SEC
Treatments' input data for biologic-naïve population: treatment effects from the independent analysis								
Probability of a PsARC response	psarc2	0.77	0.8114	0.6421	0.8168	0.5697	0.5849	0.5870
Change in HAQ-DI score in the first 3 months given no PsARC response	HAQ-DI.noresp2	-0.20	-0.1966	-0.1344	-0.0634	-0.0683	-0.0825	-0.0535
Change in HAQ-DI score in the first 3 months given a PsARC response	HAQ-DI.resp2	-0.6407	-0.66	-0.4889	-0.4385	-0.4284	-0.3947	-0.5472
Probability of a PASI 50 response	p.pasi.50_2	0.411	0.918	0.675	0.732	0.441	0.801	0.819
Probability of a PASI 75 response	pasi75_2	0.209	0.789	0.448	0.514	0.231	0.603	0.627
Probability of a PASI 90 response	p.pasi.90_2	0.084	0.593	0.242	0.297	0.097	0.380	0.405

continued

TABLE 79 Effectiveness data utilised in the economic model (continued)

Description	Variable name	Treatment						
		ETN	INF	ADA	GOL	CZP	150 mg of SEC	300 mg of SEC
Treatments' input data for biologic-naïve population: treatment effects from the metaregression								
Probability of a PsARC response	psarc2	0.74	0.74	0.60	0.71	0.71	0.73	0.73
Change in HAQ-DI score in the first 3 months given no PsARC response	HAQ-DI.noresp2	-0.15	-0.15	-0.13	-0.11	-0.12	-0.09	-0.08
Change in HAQ-DI score in the first 3 months given a PsARC response	HAQ-DI.resp2	-0.59	-0.60	-0.50	-0.48	-0.47	-0.43	-0.51
Probability of a PASI 50 response	p.pasi.50_2	0.43	0.77	0.66	0.54	0.66	0.77	0.79
Probability of a PASI 75 response	pasi75_2	0.24	0.57	0.43	0.32	0.44	0.57	0.60
Probability of a PASI 90 response	p.pasi.90_2	0.11	0.36	0.23	0.16	0.24	0.36	0.39
Description	Variable name	Treatment						
		CZP	300 mg of SEC	UST				
Treatments' input data for biologic-experienced population: treatment effects from the independent analysis								
Probability of a PsARC response	Psarc3	Confidential information has been removed		0.674	0.562			
Change in HAQ-DI score in the first 3 months given no PsARC response	HAQ-DI.noresp3	Confidential information has been removed		-0.4295	0.0015			
Change in HAQ-DI score in the first 3 months given a PsARC response	HAQ-DI.resp3	Confidential information has been removed		-0.3838	-0.32			
Probability of a PASI 50 response	p.pasi.50_3	0.56		0.875	0.628			
Probability of a PASI 75 response	pasi75_3	0.41		0.598	0.279			
Probability of a PASI 90 response	p.pasi.90_3	0.19		0.365	0.12			

a positive correlation between the two main responses in the model, PsARC and PASI 75, is included in the base-case model. The correlation coefficient value used in the model is 0.4, taken from the analysis conducted as part of the previous York model.

Table 80 shows the effect of treatment, in terms of PsARC and PASI 75 response probabilities, utilising the results from the evidence synthesis model performing independent analysis. The positive correlation columns account for the correlation between these two outcomes to generate the proportion of patients achieving joint only and joint plus skin improvement together. The no correlation columns assume independence between the two responses (no correlation coefficient applied). The no correlation columns

TABLE 80 Probabilities of PsARC and PASI 75 responses at 3 months: independent analysis

Treatment	Evidence synthesis		Correlation			
			Positive		No	
	PsARC	PASI 75	Joints only (PsARC)	Joints and skin (PsARC + PASI)	Joints only (PsARC)	Joints and skin (PSARC + PASI)
ETN	0.770	0.227	0.525	0.245	0.595	0.175
INF	0.811	0.785	0.110	0.701	0.175	0.637
ADA	0.642	0.449	0.259	0.384	0.354	0.288
GOL	0.817	0.514	0.320	0.497	0.397	0.420
CZP	0.570	0.236	0.351	0.218	0.435	0.134
150 mg of SEC	0.585	0.600	0.138	0.447	0.234	0.351
300 mg of SEC	0.587	0.623	0.126	0.461	0.221	0.366
UST ^a	0.486	0.319	0.238	0.248	0.331	0.155

^a Values for UST refer to 6 months.

are shown only for illustration here, as these values are not employed in the updated York model. Assuming a positive correlation between PsARC and PASI (the assumption in the updated York model), ETN has the highest probability of a joint only response and INF the lowest probability of a joint only response. For both a joint and skin response, INF has the highest probability and CZP the lowest probability.

Table 81 also shows the effect of treatment, in terms of PsARC and PASI 75 response probabilities, but instead utilises the evidence synthesis outcomes based on metaregression. There are some differences between the independent probabilities and the metaregression probabilities, reflecting the adjustments made to the relative effectiveness of treatments using class effect shrunken estimates in the metaregression, as opposed to relative treatments effects as observed in the trials in the independent analysis (see Chapter 4). Assuming a positive correlation between PsARC and PASI, again ETN has the highest probability of a joint only response; however, 300 mg of SEC has the lowest probability of a joint only response. For both a joint and skin response, 300 mg of SEC has the highest and ETN has the lowest probability.

TABLE 81 Probabilities of PsARC and PASI 75 responses at 3 months: metaregression, shrunken estimates

Treatment	The evidence synthesis outcome		Correlation			
			Positive		No	
	PsARC	PASI 75	Joints only (PsARC)	Joints and skin (PsARC + PASI)	Joints only (PsARC)	Joints and skin (PsARC + PASI)
ETN	0.740	0.238	0.489	0.251	0.564	0.176
INF	0.740	0.573	0.229	0.511	0.316	0.424
ADA	0.594	0.430	0.241	0.353	0.338	0.256
GOL	0.706	0.323	0.393	0.313	0.478	0.228
CZP	0.710	0.436	0.310	0.399	0.400	0.309
150 mg of SEC	0.728	0.575	0.222	0.507	0.309	0.419
300 mg of SEC	0.730	0.600	0.205	0.525	0.292	0.438
UST ^a	0.589	0.401	0.256	0.333	0.353	0.237

^a Values for UST refer to 6 months.

Mortality

All-cause mortality is incorporated by applying a risk of death during each model cycle. The mortality risk is not assumed to be structurally related to response or treatments received. Instead a common excess mortality risk is assumed for all PsA patients compared with general population mortality risks. The general population mortality risk is obtained from life tables for England and Wales and is specified separately for males and females, although the model averages across these as it does not generate results separately for males and females. Similar to the previous York model, a Gompertz function was fitted to life table data (see *Table 78*). The excess mortality risk associated with PSA is modelled assuming a HR of 1.36¹⁴ compared with the general population. This value is based on an updated analysis of the same source used in the previous York model and hence employs a different estimate from the one previously assumed.

Sources of utility data

Health utility is measured as a function of HAQ-DI and PASI. A separate search was undertaken to identify alternative utility algorithms (see *Appendix 9*). In the absence of finding any published sources reporting alternative algorithms to the one applied in the previous York model, the same algorithm was used. This algorithm is based on a linear function relating the expected utility to HAQ-DI and PASI. The same utility function is applied to all subpopulations, subgroups and treatments.

Figure 19 shows the trajectories of utility according to a patients HAQ-DI score over time, for BSC, remaining on treatment and treatment withdrawal at 5 years.

The equation below shows this relationship:

$$\text{Expected Utility} = 0.897 - 0.298 \times \text{HAQ-DI} - 0.004 \times \text{PASI}. \quad (4)$$

The utility function provided by one of the companies (Novartis) includes coefficients, namely baseline EQ-5D score, which cannot be utilised easily in the current model structure. UCB Pharma used a similar function to the previous York model but with a smaller coefficient for PASI (0.001 rather than 0.004). Given that this algorithm is very similar to the previous York model, separate scenarios, using alternative utility algorithms are not considered.

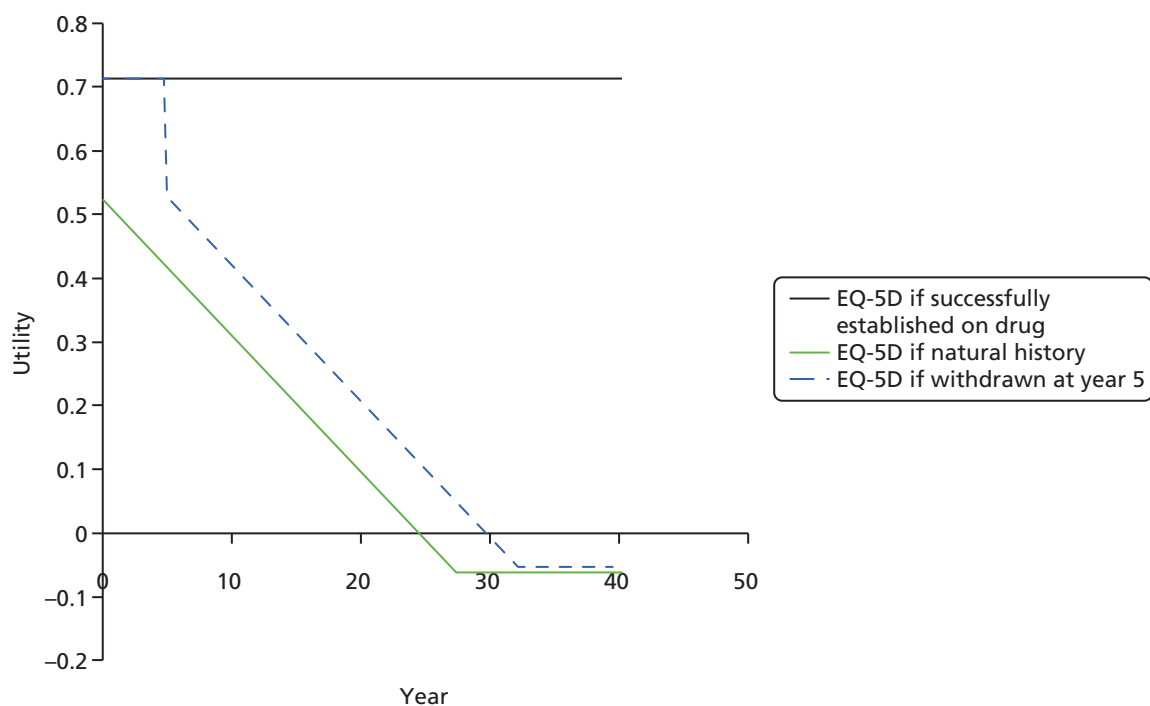

FIGURE 19 Utility corresponding to alternative HAQ-DI trajectories.

Sources of resource utilisation and costs data

Costs in the model are determined from the treatment costs (acquisition, administration and monitoring) and changes in health service utilisation driven by disease status (HAQ-DI and PASI scores). The resource use assumptions and costs applied to each of these categories are discussed in the sections below. Further searches were conducted to identify alternative sources of health state costs. The searches and results are described in *Appendix 10*.

Treatment costs

Table 82 shows the treatment-related costs applied in the updated York model. These costs are based on the list prices for SEC and CZP (biosimilar costs and Patient Access Scheme prices are used in the separate analysis). Costs are presented for the first and subsequent cycles and in terms of annual costs.

Each of the existing models (published and CSs) presents different resource use assumptions and unit costs, which are used to cost drug treatment, administration and monitoring of patients. Different assumptions have been used regarding the dosing of drugs and resource use for administration and monitoring (see *Chapter 5, Summary of resource utilisation and costs data in the York model* and *Chapter 5, Summary of resource utilisation and costs data*). The current York model sought to specify the most appropriate resource use associated with drug acquisition, administration and monitoring patients for each of the treatment options.

The resource use items from the previous York model³³ have been updated for ETN, INF and ADA, reflecting evidence from a recent appraisal in ankylosing spondylosis.¹⁰⁴ The assumptions regarding resource use for GOL have been taken from the GOL STA,⁷⁰ and the assumptions regarding the resource use for UST have been taken from the UST STA.³⁵ The resource use for SEC and CZP has been derived using the Summary of Product Characteristics, MIMS, clinical advice and BSR guidelines. The treatments' dosing schedules were obtained from the Summary of Product Characteristics found on the Electronic Medicines Compendium website.

The dose for INF was determined by a patient's weight, that is, 5 mg for each 1 kg. These weights were derived using the weight distribution reported in the RAPID-PsA trial.⁴⁷ All assumptions made regarding resource use have been validated with the clinical expert for this appraisal.

Table 83 summarises the drug acquisition, administration and monitoring costs used in the updated York model. Further details of these costs are given in the sections below.

Drug acquisition

Table 84 shows the number of vials assumed for each treatment, during the first cycle (the loading phase) and subsequent cycles. In the loading phase, 400 mg of CZP is given at weeks 0, 2 and 4. Subsequently, 200 mg is given every 2 weeks. Patients receive MTX (7.5 mg) alongside CZP, in accordance with the licence. For patients with mild–moderate psoriasis, the recommended dose of SEC is 150 mg, with initial dosing at weeks 0, 1, 2 and 3, followed by monthly maintenance dosing starting at week 4. For patients with moderate–severe psoriasis, or those who are biologic experienced, the recommended dose is 300 mg, with initial dosing at weeks 0, 1, 2 and 3, followed by monthly maintenance dosing starting at week 4. Each 300-mg dose is given as two subcutaneous injections of 150 mg.

TABLE 82 Intervention-related costs applied in the updated York model

Time period	Treatment cost (£)							
	ETN	INF	ADA	GOL	CZP	150 mg of SEC	300 mg of SEC	UST
First cycle	2541	7887	2506	2498	3784	4475	8741	4503
Subsequent cycles	2336	3672	2301	2293	2149	1832	3661	2151
Annual cost	9549	18,902	9409	9377	10,232	9972	19,722	10,957

TABLE 83 Summary of drug acquisition, administration and monitoring costs used in economic model

Treatment	Cost (£)							
	First cycle (13 weeks)				Subsequent cycles			
	Acquisition	Administration	Monitoring	Total	Acquisition	Administration	Monitoring	Total
ETN	2332	43	166	2541	2332	0	4	2336
INF	7147	574	166	7887	3395	273	4	3672
ADA	2297	43	166	2506	2297	0	4	2301
GOL	2289	43	166	2498	2289	0	4	2293
CZP	3575	43	166	3784	2145	0	4	2149
150 mg of SEC	4266	43	166	4475	1828	0	4	1832
300 mg of SEC	8532	43	166	8741	3656	0	4	3661
UST	4294	43	166	4503	2147	0	4	2151

TABLE 84 Number of vials administered for each treatment

Treatment	Number of vials	
	First cycle	Subsequent cycles
ETN	26	26
INF	Weight based	Weighted based
ADA	6.5	6.5
GOL	3	3
CZP	10	6
150 mg of SEC	7	3
300 mg of SEC	7	3
UST	2	1

For the other treatments, the following assumptions were made:

- Six and a half vials of ADA are assumed given in every 3-month cycle. This does not represent vial sharing; instead the total yearly numbers of vials is equally divided by each 3-month (13-week) cycle.
- Twenty-six vials of ETN are assumed given in the first cycle (two 25-mg prefilled syringes per week), followed by 26 vials for all subsequent cycles.
- GOL is given as a 50-mg dose once a month. In patients with a body weight of > 100 kg who do not achieve an adequate clinical response after three or four doses, the dose of GOL can be increased to 100 mg once a month. The company (Janssen Pharmaceuticals) provides this double dose at the same price as the 50-mg dose as part of an approved Patient Access Scheme.
- UST is given as an initial dose of 45 mg, followed by a 45-mg dose 4 weeks later, and then every 12 weeks thereafter. Alternatively, 90 mg may be used in patients with a body weight of > 100 kg. Similarly, the company (Janssen Pharmaceuticals) offers this double dose at an equivalent price as part of an approved Patient Access Scheme.

Infliximab is given at 0, 2 and 6 weeks, then every 8 weeks, with the number of vials administered at each time point determined by the patient's weight. Baseline weight is taken from the weight distribution reported in the RAPID-PsA trial.⁴⁷ *Table 85* shows the proportion of patients in each weight category in the RAPID-PsA trial⁴⁷ and the number of INF vials required.

The drug acquisition costs used in the current York model are shown in *Table 86*. The acquisition costs of the drugs represent the list prices in the base-case analysis. The list prices are taken from the BNF¹³⁹ and MIMS.¹³⁴ An analysis utilising non-list prices (biosimilar costs), for some of the comparators, is presented in *Appendix 8*. Biosimilar costs used are presented in *Appendix 8*. A separate analysis is also presented using the Patient Access Scheme prices for CZP and SEC as part of a separate and confidential appendix.

A separate acquisition cost was not applied to BSC and, therefore, the cost of BSC is assumed to be entirely captured in terms of health state costs. These represent the full HAQ-DI costs (without discounting the prescribing costs) and the uncontrolled psoriasis costs (see *Health state costs*).

Drug administration

For all treatments, other than INF, an administration cost was applied only on the first cycle, therefore assuming self-administration in the subsequent cycles. This was assigned a cost of a 1-hour nurse visit in a GP practice (£43) (Personal Social Services Research Unit; PSSRU¹³⁶). INF requires intravenous (i.v.) infusion and, therefore, the administration cost for INF was assumed to represent the cost of delivering simple parenteral chemotherapy at first attendance (£159; reference costs 2015¹³⁷). These costs are the same as those used in the UCB Pharma model. The administration costs assumed in the updated model are shown in *Table 87*.

TABLE 85 Distribution of weights used to determined INF vials required

Patient's weight (kg)	Number of vials required	Dose (mg)	Proportion of population
20	1	100	0.0003
40	2	200	0.0087
60	3	300	0.0878
80	4	400	0.3105
100	5	500	0.3898
120	6	600	0.1740
140	7	700	0.0273
160	8	800	0.0015

TABLE 86 Acquisition costs used in the updated York model

Treatment	Cost (£; 2016)	Source
INF (100-mg vial): Inflectra/Remsima	419.62	MIMS ¹³⁴
ETN (25-mg syringe): ENBREL	89.50	MIMS ¹³⁴
ADA (40-mg syringe): Humera	352.14	MIMS ¹³⁴
GOL (50-mg syringe; 100-mg syringe): SIMPONI	762.97; 1525.94	MIMS ¹³⁴
UST (45-mg syringe; 90-mg syringe)	2147; 2147	MIMS ¹³⁴
SEC (150-mg syringe)	609.39	MIMS ¹³⁴
CZP (200-mg syringe)	357.50	MIMS ¹³⁴
MTX (7.5 mg)	0.30	BNF ¹³⁹

TABLE 87 Administration costs used in the updated York model

Method of administration	Cost (£)	
	First cycle	Subsequent cycles
Subcutaneously	43	–
Intravenously	159	159

Initiation and monitoring

A summary of the initiation and monitoring resource use assumptions is reported *Table 88*. The resource use assumptions for laboratory testing for biologic treatment initiation and monitoring have been sourced from the previous York model and updated using the Hospital and Community Health Service Pay and Prices Index from the PSSRU.¹³⁷ These conform to guidelines from the BSR¹²⁷ for the use of biologics.

Psoriatic arthritis patients on biologic therapy are assumed to undertake a series of tests at treatment initiation and at 3 months when assessing initial treatment response [i.e. a full blood count, erythrocyte sedimentation rate (ESR) test, liver function test, urea and electrolytes test]. Additional testing is assumed to be conducted once during the initial period (i.e. chest radiography, TB Heaf test, antinuclear antibody test and a double-stranded deoxyribonucleic acid test). Patients on biologics are also assumed to visit a specialist (rheumatologist) twice during the initial 3-month period (at treatment initiation and when assessing a response). The cost of a rheumatologist visit was applied only in the first cycle. The assumption that subsequent visit costs would be encapsulated within health state costs and has been applied in similar appraisals¹⁰⁴ and in the company models. The cost of a rheumatology visit was taken from the *NHS Reference Costs 2014 to 2015*.¹³⁷

Health state costs

In order to generate an estimate of the lifetime costs for each of the treatments, estimates of resource use and costs associated with HAQ-DI and PASI are required. As reported in *Chapter 5*, the previous York model used separate studies and assumptions to estimate HAQ-DI- and PASI-related costs.

A search of the published literature was undertaken to identify alternative published evidence regarding the resource use and costs associated with the management of PsA in the UK (see *Appendix 11*). The only

TABLE 88 Initiation and monitoring resource use and costs

Item	Initiation and monitoring costs (£)		Frequency	
	First cycle	Subsequent cycles	First cycle	Subsequent cycles
Full blood count	6.18	1.54	2	0.5
ESR test	6.11	1.53	2	0.5
Liver function test	1.56	0.39	2	0.5
Urea and electrolytes test	2.86	0.72	2	0.5
Chest radiography	27.11	0.00	1	0
TB Heaf test	9.03	0.00	1	0
Antinuclear antibody test	4.81	0.00	1	0
Double-stranded DNA test	4.81	0.00	1	0
Specialist visit	103.53	0.00	1	0
Total	166.01	4.18		

DNA, deoxyribonucleic acid; ESR, erythrocyte sedimentation rate.

other published source identified in the search that specifically reported estimates of costs according to HAQ-DI and/or PASI was the study from Poole *et al.*¹³⁸ This study was used in the UCB Pharma submission and was previously described in *Chapter 5*.

The alternative approaches identified, which could be used to estimate HAQ-DI and PASI costs, represent an important area of remaining uncertainty. One potential advantage of the Poole *et al.*¹³⁸ study is that the estimates according to HAQ-DI score are derived from a sample of PsA patients as opposed to a sample of RA patients. However, Poole *et al.*¹³⁸ noted important differences in the authors' predictions, with markedly higher costs predicted for equivalent HAQ-DI scores for PsA patients than those previously reported for RA patients. Although the authors of the Poole *et al.*¹³⁸ study stated that this could indicate important differences in the economic burden associated with PsA compared with RA, they also acknowledged that the differences might simply be attributed to differences in methods and/or the requirement to predict HAQ-DI score in the THIN data set using a separate regression model from the BSRBR. A number of further limitations were also noted in Poole *et al.*,¹³⁸ including (1) the predicted HAQ-DI score did not cover the full range (0–3 units) and applying the generalised linear model to predict for the full range could result in substantial errors, particularly for the more severe event of the range; and (2) PASI data were not available in either the BSRBR or THIN data. These additional limitations are particularly important in the context of the current model, as HAQ-DI predictions are required across the full range of HAQ-DI scores and that separate PASI subgroups are modelled.

Having identified important differences in the predictions based on the separate sources and noting the potential limitations identified in the Poole *et al.*¹³⁸ study, the final HAQ-DI costs were based on the same function used in the previous York model, with costs updated to current prices. This assumption also ensures consistency across the separate NICE TAs. Despite some concerns with the Poole *et al.*¹³⁸ study, the fact that it provides the only source of costs specific to PsA makes it potentially relevant for the updated York model. The use of the Poole *et al.*¹³⁸ study is therefore explored as a separate scenario (see *Scenario analyses*).

The costs according to HAQ-DI scores address only the arthritis component of PsA; therefore, additional costs were required to capture the psoriasis element of the disease. The current York model addresses three subgroups according to psoriasis severity (see *Patient characteristics*). It was assumed patients without concomitant psoriasis would not incur additional psoriasis-related costs. In the absence of identifying any other relevant UK costing studies to inform PASI estimates for the mild–moderate and moderate–severe PASI subgroups, the same sources as in the previous York model were assumed and the same assumptions were made. Hence, the costs assumed for treating mild–moderate psoriasis in patients who do not use biologics or who do not respond to biologics (PASI 75) were based on NHS unit costs of phototherapy¹³⁷ and a UK RCT.¹⁴⁶ Similarly, for patients with moderate or severe psoriasis, costs were based on a Dutch RCT adjusted to UK price levels (see Hartman *et al.*¹³¹). Costs from the previous York model were updated to the current price year (2016).

The psoriasis-related costs applied to PASI 75 non-responders and for patients not receiving biologics are shown in *Table 89* for each of the psoriasis subgroups.

TABLE 89 Costs (£) assigned for PASI 75 non-responders and patients not receiving biologics

Cost	Psoriasis subgroups		
	Without psoriasis	Mild to moderate	Moderate to severe
Baseline PASI score	0.0	7.3	12.5
Uncontrolled psoriasis	0.0	223	638
Controlled psoriasis (PASI 75 response)	0.0	18	18

Scenario analyses

As described in *Patient characteristics*, a further subgroup of subpopulation 3 was considered as part of a separate scenario analysis. This separate scenario is presented to reflect that the data reported for CZP in biologic-experienced patients are applicable only to patients who initially responded to the previous biologic therapy (i.e. secondary failure of treatment), and are not directly comparable to the data for UST and SEC, which include primary and secondary treatment failures. This separate scenario includes only CZP and BSC. Other subgroups, in terms of extent of psoriasis (measured using PASI), are presented as part of the base-case analysis.

In addition, a number of scenarios are specified to explore the robustness of some of the assumptions made in the model, focusing on key areas where these deviate from assumptions made in the CSs:

- Applying an alternative cost function from Poole *et al.*¹³⁸
- Alternative assumptions regarding withdrawals. Two scenarios were specified: (1) the withdrawal rate for SEC is assumed to be 50% of the base-case value from year 2; and (2) all treatments are associated with a withdrawal rate equivalent to 50% of the base-case values from year 5. The first withdrawal scenario is similar to the assumption made in the Novartis model, in which lower withdrawal rates are reported for SEC in the second year of treatment. The second withdrawal scenario was undertaken to assess the robustness of the results to assumptions made regarding the constant rate of withdrawal applied in the model. Given the lack of longer-term data to inform an alternative, time-dependent withdrawal rate, an assumption was made that patients who remained on therapy at 5 years would no longer be at risk of subsequent withdrawals. This is similar to the assumption made in the UCB Pharma model, but not as extreme in that patients are still permitted to withdraw albeit at a reduced rate and from a slightly later time point (5 years as opposed to 4 years).
- Baseline HAQ-DI score according to subpopulation. Equivalent to the separate baseline HAQ-DI scores assumed in the UCB Pharma model, three separate baseline scores were applied according to the subpopulation: (confidential information has been removed) for subpopulation 1, (confidential information has been removed) for subpopulation 2 and (confidential information has been removed) for subpopulation 3.

Analytic methods

The expected costs and QALYs of the alternative treatment strategies are determined for each subpopulation and PASI subgroup and the relative cost-effectiveness of the strategies is then compared using standard decision rules, estimating ICERs as appropriate.¹⁴⁷ The ICER examines the additional cost that one strategy incurs over another and compares this with the additional benefits. The ICER estimate represents the additional cost required to generate one additional unit of health outcome (QALY). When more than two strategies are being compared, the ICERs are calculated using the following process:

- The strategies are ranked in terms of mean QALYs (from the least effective to the most effective).
- If a strategy is more costly and less effective than any previous strategy, then this strategy is said to be dominated and is excluded from the calculation of the ICERs.
- The ICERs are calculated for each successive alternative, from the least effective to the most effective; if the ICER for a given strategy is higher than that of any more effective strategy, then this strategy is ruled out on the basis of extended dominance.
- Finally, the ICERs are recalculated, excluding any strategies that are ruled out by principles of dominance or extended dominance.

The resulting ICERs then provide the basis for establishing which strategy appears optimal based on cost-effectiveness considerations, that is, which strategy (or strategies) appears to provide good value for money to the NHS. Guidance from NICE suggests that an incremental cost per additional QALY of around £20,000–30,000 is considered to represent an appropriate threshold to establish value for money to the NHS.¹²⁵

In addition to determining which strategy appears optimal based on fully incremental comparisons of all treatments simultaneously, separate pairwise ICERs are presented for each treatment versus BSC alone. These pairwise ICERs are helpful in informing assessments of cross-validity (i.e. providing a comparable basis to compare particular treatments with previously published results). These comparisons may also be informative if strategies are ruled out from the fully incremental calculations based on differences between treatments that are not considered clinically or economically significant. In this situation, comparing the pairwise ICERs for each individual treatment with a common comparator may provide further information to inform subsequent decisions.

The model was run several times, once for the main base-case analysis (for each subpopulation and PASI subgroup) and then for a number of alternative scenarios to consider alternative assumptions related to key aspects of the base-case approach (see *Scenario analysis*). Given the large number of subpopulation, subgroup and scenario combinations, it has not been possible to conduct PSA, although this functionality is included in the model.

Probabilistic sensitivity analysis

Probabilistic sensitivity analysis is used to assess the implications of parameter uncertainty (the imprecision with which input parameters are estimated), in terms of the estimates of cost-effectiveness. The uncertainty in each parameter was represented using a probability distribution and the PSA was carried out using Monte Carlo simulation. The rate of change of the HAQ-DI score while not on treatment was assigned a gamma distribution to ensure that values are strictly positive. All other uncertain parameters were assigned normal distributions using the mean and SE. The treatment effect parameters used in the model, PsARC response, conditional change in HAQ-DI score and PASI responses, utilise the convergence diagnostic and output analysis (CODA) output from the evidence synthesis models (see *Sources of effectiveness data*).

This analysis reflects the decision uncertainty associated with the optimal treatment. PSA generates distributions (20,000 iterations) of total costs and QALYs, and shows the probability that a treatment is cost-effective at thresholds of £20,000 and £30,000. This was performed for the three subpopulations, defined by the patient's position in the treatment pathway, and also on the three subgroups of concomitant psoriasis severity.

This analysis utilised the two evidence synthesis outputs: the independent and the metaregression analyses. Given the mathematically intensive operations, represented by 20,000 iterations for each version of the model, the computation time is a major challenge. This may potentially reach 2 months on a desktop machine. Therefore, there was a need to run the probabilistic model on the University of York's supercomputer. This necessitated some flexibility in the code allowing the model to be run in parallel on hundreds of processors within the supercomputer.

Results

Results of the base-case cost-effectiveness analysis

According to the three main subpopulations (biologic naive, one prior or two or more prior DMARDs; and biologic experienced), results for three separate concomitant psoriasis subgroups (baseline PASI score = 0, 7.5 or 12.5) are presented and discussed in the following sections. For ease of presentation and interpretation, individual ICER tables are presented only for the independent analysis from the evidence synthesis in the main body of the report and summary tables used to compare with the results based on metaregression approach. Individual ICER tables based on the metaregression are also reported separately in *Appendix 12*.

All results presented in *Results* are based on the list prices for SEC and CZP and the originator products for INF and ETN. Results are presented for the base-case models, according to subpopulation and psoriasis subgroup, for the scenarios as specified and the PSA. A separate confidential appendix is included which

incorporates the confidential Patient Access Scheme prices for CZP and SEC. Scenarios including biosimilar prices are also presented separately in *Appendix 8*.

Subpopulation 1: biologic naive (one prior DMARD)

The cost-effectiveness results for subpopulation 1 are shown for the three subgroups according to the level of concomitant psoriasis (moderate–severe psoriasis, mild–moderate psoriasis and no concomitant psoriasis) in *Tables 90–92*.

In the moderate–severe psoriasis subgroup (*Table 90*), 300 mg of SEC is the most effective strategy (QALYs = 8.52), followed by CZP (QALYs = 8.38) and BSC (QALYs = 5.31). In terms of costs, 300 mg of SEC is also the mostly costly strategy (£179,692) followed by CZP (£159,951) and BSC (£95,965). Based on the fully incremental ICERs, the ICER of CZP compared with BSC is £20,870 per QALY and the ICER of 300 mg of SEC compared with CZP is £134,783 per QALY.

The individual pairwise ICERs for CZP and 300 mg of SEC compared with BSC are £20,870 and £26,064 per QALY, respectively.

In the mild–moderate psoriasis group (*Table 91*), 150 mg of SEC is the most effective strategy (QALYs = 8.69), followed by CZP (QALYs = 8.68) and BSC (QALYs = 5.68). In terms of costs, CZP is now the most costly strategy (£135,946), followed by 150 mg of SEC (£132,500) and BSC (£67,000). Based on the fully incremental ICERs, CZP is dominated by 150 mg of SEC. The ICER of 150 mg of SEC compared with BSC is £21,772 per QALY.

The individual pairwise ICERs for CZP and 150 mg of SEC compared with BSC are £23,052 and £21,772 per QALY, respectively.

In the no concomitant psoriasis subgroup (*Table 92*), CZP is the most effective strategy (QALYs = 9.074), followed by 150 mg of SEC (QALYs = 9.067) and BSC (QALYs = 6.188). In terms of costs, CZP is also the most costly strategy (£122,832), followed by 150 mg of SEC (£120,303) and BSC (£51,436). Based on the fully incremental ICERs, the ICER for 150 mg of SEC compared with BSC is £23,928 per QALY and the ICER of CZP compared with 150 mg of SEC is £346,785 per QALY.

TABLE 90 Treatment effects from the independent analysis for moderate–severe psoriasis, subpopulation 1: fully incremental cost-effectiveness analysis

Treatment	Cost (£)	QALYs	Incremental cost (£)	Incremental QALYs	ICER vs. next-best option (£)	ICER vs. BSC (£)
BSC	95,965	5.312	–	–	–	–
CZP	159,951	8.377	63,987	3.066	20,870	20,870
300 mg of SEC	179,692	8.524	19,741	0.146	134,783	26,064

TABLE 91 Treatment effects from the independent analysis for mild–moderate psoriasis, subpopulation 1: fully incremental cost-effectiveness analysis

Treatment	Cost (£)	QALYs	Incremental cost (£)	Incremental QALYs	ICER vs. next best option (£)	ICER vs. BSC (£)
BSC	67,000	5.676	–	–	–	–
CZP	135,946	8.667	–	–	Dominated ^a	23,052
150 mg of SEC	132,500	8.685	65,500	3.009	21,772	21,772

^a See *Analytic methods*.

TABLE 92 Treatment effects from the independent analysis for no concomitant psoriasis, subpopulation 1: fully incremental cost-effectiveness analysis

Treatment	Cost (£)	QALYs	Incremental cost (£)	Incremental QALYs	ICER vs. next best option (£)	ICER vs. BSC (£)
BSC	51,436	6.188	–	–	–	–
150 mg of SEC	120,303	9.067	68,866	2.878	23,928	23,928
CZP	122,832	9.074	2529	0.007	346,785	24,744

The individual pairwise ICERs for 150 mg of SEC and CZP compared with BSC are £23,928 and £24,774 per QALY, respectively.

There are a number of important differences evident across the separate concomitant psoriasis subgroups for subpopulation 1. Mean costs are higher (and mean QALYs lower) for all treatments depending on the presence and severity of concomitant psoriasis, demonstrating the important contribution of psoriasis to costs and HRQoL, and to subsequent ICER estimates. The difference in mean QALYs between SEC and CZP is greatest in the moderate–severe psoriasis subgroup, with 300 mg of SEC reported to be the most effective strategy. The difference appears largely attributable to the higher average PASI responses (PASI 50, PASI 75 and PASI 90), estimated for 300 mg of SEC compared with CZP from the independent evidence synthesis. The differences in PASI outcomes become less important as the severity of concomitant psoriasis is reduced and the differences are now based on comparisons between 150 mg of SEC and CZP. The difference in QALYs between 150 mg of SEC and CZP is subsequently reduced in the mild–moderate psoriasis subgroup (QALY difference still in favour of 150 mg of SEC), and reduced again in the subgroup with no concomitant psoriasis (QALY difference now in favour of CZP). As the influence of PASI outcomes is reduced, the differences in both the PsARC response rate and the HAQ-DI change scores conditional on PsARC response between the treatments become more important. Although the PsARC response rate was estimated to be marginally higher for 150 mg of SEC than CZP (probability = 0.58 vs. 0.57), marginally higher conditional HAQ-DI changes were then estimated for CZP than 150 mg of SEC (–0.43 vs. –0.39). In the no concomitant psoriasis subgroup, in which differences in PASI response are no longer relevant, the higher conditional HAQ-DI score assumed for CZP appears to offset the higher PsARC response rate for 150 mg of SEC. However, subsequent differences in QALY outcomes appear minor between 150 mg of SEC and CZP (0.007 QALYs in favour of CZP).

In terms of the pairwise ICERs reported versus BSC, the ICERs for CZP vary between £20,870 (moderate–severe psoriasis) and £24,744 (no concomitant psoriasis) per QALY across the psoriasis subgroups. The ICERs for SEC range from £23,052 (mild–moderate psoriasis) to £26,064 per QALY (moderate–severe psoriasis). The ICERs versus BSC for SEC do not follow the same pattern as for CZP (i.e. more favourable ICERs as severity of concomitant psoriasis increases), as a result of the different dosages assumed for SEC and the higher cost of 300 mg of SEC assumed in the moderate–severe psoriasis subgroup.

Table 93 illustrates the differences between the independent analysis and the metaregression evidence synthesis for each of the subgroups in subpopulation 1 (full results are presented in Appendix 12). The pairwise ICERs for each of the treatments compared with BSC are presented along with the optimal (or most cost-effective) treatment strategy determined based on the fully incremental ICER comparisons at thresholds of £20,000 and £30,000 per QALY.

In summary, the differences in the pairwise ICERs estimated using the alternative synthesis models have only a minor effect. Furthermore, the optimal treatment remains consistent across the two evidence synthesis approaches using a threshold of £30,000 per QALY. At a threshold of £20,000 the optimal treatment changes in the moderate–severe subgroup. CZP is now the most cost-effective treatment as its ICER compared with BSC now falls below the threshold (£19,908), based on the results of the metaregression.

TABLE 93 Summary of differences between independent and metaregression approaches, subpopulation 1

NMA approach	ICERs vs. BSC (£)			Optimal treatment strategy at a threshold of	
	CZP	150 mg of SEC	300 mg of SEC	£20,000	£30,000
Moderate–severe psoriasis					
Independent analysis	20,870	–	26,064	BSC	CZP
Metaregression	19,908	–	27,033	CZP	CZP
Mild–moderate psoriasis					
Independent analysis	23,052	21,772	–	BSC	150 mg of SEC
Metaregression	22,446	21,287	–	BSC	150 mg of SEC
No concomitant psoriasis					
Independent analysis	24,744	23,928	–	BSC	150 mg of SEC
Metaregression	24,388	23,408	–	BSC	150 mg of SEC

Subpopulation 2: biologic naive (two or more prior DMARDs)

The cost-effectiveness results for subpopulation 2 are reported according to the level of concomitant psoriasis (moderate–severe psoriasis, mild–moderate psoriasis and no concomitant psoriasis) in *Tables 94–96*.

As discussed in *Choice of intervention and comparators*, it is assumed that, after failing the first biologic treatment, patients move (switch) to UST as a second-line treatment before moving to BSC. In the moderate–severe subgroup (*Table 94*), 300 mg of SEC treatment is compared in this population, as opposed to 150 mg of SEC, as the licence for SEC states that a 300-mg dose is appropriate for patients with severe psoriasis (PASI score of > 10 units). The cost-effectiveness results for this subgroup show that 300 mg of SEC is dominated by other comparators (ADA, GOL and ETN), as it incurs higher costs and results in fewer QALYs. CZP is extendedly dominated (by a linear combination of ADA and BSC). Of the remaining non-dominated alternatives, the ICER of ADA versus BSC is £20,074 per QALY, the ICER of GOL versus ADA is £20,976 per QALY, the ICER of ETN versus GOL is £21,215 per QALY and the ICER of INF is £131,716 per QALY.

TABLE 94 Treatment effects from the independent analysis for moderate–severe psoriasis, subpopulation 2: fully incremental cost-effectiveness analysis

Treatment	Cost (£)	QALYs	Incremental cost (£)	Incremental QALYs	ICER vs. next best option (£)	ICER vs. BSC (£)
BSC	95,965	5.312	–	–	–	–
CZP	137,240	7.226	–	–	Extendedly dominated ^a	21,564
300 mg of SEC	157,086	7.379	–	–	Dominated ^a	29,569
ADA	138,109	7.411	42,144	2.100	20,074	20,074
GOL	142,850	7.637	4741	0.226	20,976	20,161
ETN	144,585	7.719	1735	0.082	21,215	20,197
INF	167,126	7.890	22,541	0.171	131,716	27,599

^a See *Analytic methods*.

The individual pairwise ICERs for CZP and 300 mg of SEC compared with BSC are £21,564 and £29,569 per QALY, respectively.

Table 95 shows the results for the mild–moderate psoriasis subgroup. In this subgroup CZP is the least effective biologic treatment, generating 7.537 QALYs, whereas INF generates the highest QALYs (8.161). Fully incremental analysis shows that CZP is dominated by 150 mg of SEC, GOL is dominated by ETN, and ADA is extendedly dominated (linear combination of 150 mg of SEC and ETN). Of the remaining non-dominated alternatives, the ICER of 150 mg of SEC versus BSC is £22,032 per QALY, the ICER of ETN versus 150 mg of SEC is £23,256 per QALY and the ICER of INF versus ETN is £193,063 per QALY.

The individual pairwise ICERs for CZP and 150 mg of SEC compared with BSC are £24,103 and £22,032 per QALY, respectively.

For the no concomitant psoriasis subgroup (PASI score = 0) (Table 96), INF maintains its position as the most effective treatment (8.543 QALYs), whereas 150 mg of SEC is now the least effective option. As expected in this subgroup, the ICERs versus BSC increase compared with the mild–moderate and severe psoriasis subgroups, as a result of the benefits being driven entirely by HAQ-DI as opposed to a combination of HAQ-DI and PASI. The incremental cost-effectiveness analysis shows that GOL is dominated by ETN and 150 mg of SEC, and CZP and ADA are extendedly dominated. Of the non-dominated alternatives, the ICER of ETN versus BSC is £23,833 per QALY and the ICER of INF versus ETN is £324,502 per QALY.

The individual pairwise ICERs for CZP and 150 mg of SEC compared with BSC are £26,105 and £24,773 per QALY, respectively.

Table 97 summarises the differences between the independent analysis and the metaregression evidence synthesis for each of the separate psoriasis subgroups within subpopulation 2 (full results are available in Appendix 12). The pairwise ICERs for each of the treatments compared with BSC are presented along with the optimal (or most cost-effective) treatment at thresholds of £20,000 and £30,000 per QALY, using the full incremental results. Although there are only minimal differences in the pairwise ICERs, in this subpopulation the optimal treatment alters across the two evidence synthesis approaches. Both approaches accord in terms of the optimal strategy at a threshold of £20,000 for the mild–moderate and no concomitant psoriasis subgroups. In the moderate–severe subgroup, the ICER for CZP (compared with BSC – its next best) falls below £20,000; therefore, at this threshold it represents the optimal treatment. Using the metaregression estimates, CZP, as opposed to ETN, represents the most cost-effective option at a threshold value of £30,000 per QALY in the moderate–severe psoriasis group. The optimal treatment switches from ETN to 150 mg of

TABLE 95 Treatment effects from the independent analysis for mild–moderate psoriasis, subpopulation 2: fully incremental cost-effectiveness analysis

Treatment	Cost (£)	QALYs	Incremental cost (£)	Incremental QALYs	ICER vs. next best option (£)	ICER vs. BSC (£)
BSC	67,000	5.676	–	–	–	–
CZP	111,856	7.537	–	–	Dominated ^a	24,103
150 mg of SEC	108,508	7.560	41,508	1.884	22,032	22,032
ADA	114,039	7.708	–	–	Extendedly dominated ^a	23,149
GOL	119,624	7.923	–	–	Dominated ^a	23,419
ETN	119,326	8.025	10,818	0.465	23,256	22,274
INF	145,569	8.161	26,243	0.136	193,063	31,616

a See Analytic methods.

TABLE 96 Treatment effects from the independent analysis for no concomitant psoriasis, subpopulation 2: fully incremental cost-effectiveness analysis

Treatment	Cost (£)	QALYs	Incremental cost (£)	Incremental QALYs	ICER vs. next best option (£)	ICER vs. BSC (£)
BSC	51,436	6.188	–	–	–	–
150 mg of SEC	95,632	7.972	–	–	Extendedly dominated ^a	24,773
CZP	98,060	7.974	–	–	Extendedly dominated ^a	26,105
ADA	100,893	8.125	–	–	Extendedly dominated ^a	25,532
GOL	106,895	8.325	–	–	Dominated ^a	25,951
ETN	105,592	8.456	54,156	2.268	23,883	23,883
INF	133,664	8.543	28,071	0.087	324,502	34,930

a See *Analytic methods*.

TABLE 97 Summary of differences between independent and metaregression approaches, subpopulation 2

NMA approach	ICERs vs. BSC (£)							Optimal treatment strategy at a threshold of	
	CZP	150 mg of SEC	300 mg of SEC	ADA	GOL	ETN	INF	£20,000	£30,000
Moderate–severe psoriasis									
Independent analysis	21,564	–	29,569	20,074	20,074	20,197	27,599	BSC	ETN
Metaregression	19,923	–	30,456	20,092	20,767	20,552	29,138	CZP	CZP
Mild–moderate psoriasis									
Independent analysis	24,103	22,032	–	23,149	23,419	22,274	31,616	BSC	ETN
Metaregression	22,939	21,177	–	23,130	23,408	22,750	32,703	BSC	150 mg of SEC
No concomitant psoriasis									
Independent analysis	26,105	24,773	–	25,532	25,951	23,883	34,930	BSC	ETN
Metaregression	25,275	23,768	–	25,485	25,475	24,460	35,689	BSC	150 mg of SEC

SEC in the mild–moderate and non-concomitant psoriasis subgroups. These differences are driven by the increased relative effectiveness of CZP and 150 mg of SEC in the metaregression approach (see *Chapter 4*).

Subpopulation 3: biologic experienced

Tables 98–100 present the results for subpopulation 3 for the moderate–severe, mild–moderate and no concomitant psoriasis subgroups, respectively. Only an independent analysis is available for this subpopulation, because of the smaller number of data available (see *Sources of effectiveness data*). In this subpopulation, 300 mg of SEC is considered as a relevant comparator, alongside UST and BSC. The clinical trial data for UST and 300 mg of SEC come from a mix of biologic-experienced patients: those who have not responded to biologic treatment (primary non-responders) and those who have responded but subsequently failed the treatment (secondary failures). CZP is not included in this model as only patients who had a primary response to a biologic treatment (secondary failures) were included in the RAPID-PsA trial.⁴⁷ Primary non-responders were explicitly excluded from this trial and, therefore, the population represents a separate subgroup of the

overall biologic-experienced subpopulation (those that have previously had a response). The results for CZP are presented separately in *Results of subgroup analysis: biologic-experienced secondary failures*.

Table 98 shows the results of the moderate–severe psoriasis subgroup. The most effective and expensive treatment is 300 mg of SEC, generating greater QALYs than UST (6.632 vs. 6.334 QALYs) and incurring higher costs (£143,534 vs. £118,127). In the fully incremental analysis, the ICER of UST versus BSC is £21,684 per QALY and the ICER of 300 mg of SEC is £85,013 per QALY.

The individual pairwise ICER for 300 mg of SEC compared with BSC is £36,013.

Table 99 shows the results of the mild–moderate psoriasis subgroup. In this subgroup, 300 mg of SEC is the most effective and expensive treatment, generating more QALYs than UST (6.945 vs. 6.666) and incurring higher costs (£118,564 vs. £91,246). In the fully incremental analysis, the ICER of UST versus BSC is £24,510 per QALY and the ICER of 300 mg of SEC versus UST is £97,713 per QALY.

The individual pairwise ICER for 300 mg of SEC compared with BSC is £40,639.

Table 100 shows the results of non-evaluable psoriasis subgroup. The most effective and expensive treatment is 300 mg of SEC, generating more QALYs than UST (7.384 vs. 7.132 QALYs) and incurring higher costs (£104,973 vs. £76,712). In the fully incremental analysis, the ICER of UST versus BSC is £26,797 per QALY and the ICER of 300 mg of SEC versus UST is £111,927 per QALY.

The individual pairwise ICER for 300 mg of SEC compared with BSC is £44,774.

TABLE 98 Moderate–severe psoriasis, subpopulation 3: fully incremental cost-effectiveness analysis

Treatment	Cost (£)	QALYs	Incremental cost (£)	Incremental QALYs	ICER vs. next best option (£)	ICER vs. BSC (£)
BSC	95,965	5.312	–	–	–	–
UST	118,127	6.334	22,162	1.022	21,684	21,685
300 mg of SEC	143,534	6.632	25,407	0.299	85,013	36,013

TABLE 99 Mild–moderate psoriasis, subpopulation 3: fully incremental cost-effectiveness analysis

Treatment	Cost (£)	QALYs	Incremental cost (£)	Incremental QALYs	ICER vs. next best option (£)	ICER vs. BSC (£)
BSC	67,000	5.676	–	–	–	–
UST	91,246	6.666	24,246	0.989	24,510	24,510
300 mg of SEC	118,564	6.945	27,318	0.280	97,713	40,639

TABLE 100 No concomitant psoriasis, subpopulation 3: fully incremental cost-effectiveness analysis

Treatment	Cost (£)	QALYs	Incremental cost (£)	Incremental QALYs	ICER vs. next best option (£)	ICER vs. BSC (£)
BSC	51,436	6.188	–	–	–	–
UST	76,712	7.132	25,275	0.943	26,797	26,797
300 mg of SEC	104,973	7.384	28,261	0.252	111,927	44,774

Subpopulation 4: TNF- α inhibitors contraindicated

As described in *Patient characteristics*, a separate scenario is required for patients in whom existing TNF- α inhibitors (INF, ETN, ADA and GOL) are contraindicated. These patients are likely to be a combination of biologic-naïve and biologic-experienced patients who have experienced a significant AE. SEC, UST and BSC were included as comparators. CZP was not included as it was assumed that other TNF- α inhibitors, including CZP, would also be contraindicated in these patients. As described in *Sources of effectiveness data*, in the absence of effectiveness data specific to these patients, the analysis was undertaken using the naïve populations from the SEC and UST trials. Only an independent analysis is available for this subpopulation, because of the smaller number of data available (see *Sources of effectiveness data*).

Table 101 shows the results of the moderate–severe psoriasis subgroup. The most effective and expensive treatment is 300 mg of SEC, generating more QALYs than UST (6.530 vs. 6.274 QALYs) and incurring higher costs (£137,936 vs. £115,216). In the fully incremental analysis, the ICER of UST versus BSC is £19,969 per QALY and the ICER of 300 mg of SEC versus UST is £89,302 per QALY.

The individual pairwise ICER for 300 mg of SEC compared with BSC is £34,445.

Table 102 shows the results of the mild–moderate psoriasis subgroup. The most effective treatment is 150 mg of SEC, generating more QALYs than UST (6.739 vs. 6.613 QALYs). It incurs lower costs than UST (£87,559 vs. £88,280). In the fully incremental analysis, UST is dominated by 150 mg of SEC. The ICER of 150 mg of SEC versus BSC is £19,349 per QALY.

Table 103 shows the results of the no concomitant psoriasis subgroup. The most effective and expensive treatment is 150 mg of SEC, generating more QALYs than UST (7.190 vs. 7.088 QALYs) and incurring higher costs (£73,798 vs. £73,717). In the fully incremental analysis, UST is extendedly dominated by 150 mg of SEC. The ICER of 150 mg of SEC compared with BSC is £22,334 per QALY.

TABLE 101 Moderate–severe psoriasis, subpopulation 4, contraindicated: fully incremental cost-effectiveness analysis

Treatment	Cost (£)	QALYs	Incremental cost (£)	Incremental QALYs	ICER vs. next best option (£)	ICER vs. BSC (£)
BSC	95,965	5.312	–	–	–	–
UST	115,216	6.276	19,252	0.964	19,969	19,969
300 mg of SEC	137,936	6.530	22,720	0.254	89,302	34,445

TABLE 102 Mild–moderate psoriasis, subpopulation 4, contraindicated: fully incremental cost-effectiveness analysis

Treatment	Cost (£)	QALYs	Incremental cost (£)	Incremental QALYs	ICER vs. next best option (£)	ICER vs. BSC (£)
BSC	67,000	5.676	–	–	–	–
UST	88,280	6.613	Dominated ^a	–	–	22,708
150 mg of SEC	87,559	6.739	20,558	1.063	19,349	19,349

^a See *Analytic methods*.

TABLE 103 No concomitant psoriasis, subpopulation 4, contraindicated: fully incremental cost-effectiveness analysis

Treatment	Cost (£)	QALYs	Incremental cost (£)	Incremental QALYs	ICER vs. next best option (£)	ICER vs. BSC (£)
BSC	51,436	6.188	–	–	–	–
UST	73,717	7.088	–	–	Extendedly dominated ^a	24,781
150 mg of SEC	73,798	7.190	22,362	1.001	22,334	22,334

a See *Analytic methods*.

Results of the scenario analyses

As discussed in *Scenario analyses*, a number of scenario analyses were conducted to explore the impact of various model assumptions. These scenarios were conducted for the three main subpopulations and were intended to accord with assumptions and data employed in the CSs. These scenarios therefore aid comparison across the models (see *Scenario analyses*).

Details of the scenarios are given in *Scenario analyses*. First, baseline HAQ-DI score is specified according to the subpopulation of interest. Second, the costs assigned according to HAQ-DI score were taken from Poole *et al.*¹³⁸ as opposed to Kobelt *et al.*¹²⁹ Third, two alternative withdrawal scenarios were specified. The results of these alternative scenarios are summarised in *Tables 104–106* for each of the three main subpopulations. The pairwise ICERs for each of the treatments compared with BSC are presented along with the optimal (or most cost-effective) treatment at thresholds of £20,000 and £30,000 per QALY, using the fully incremental ICERs. List prices are used in all of these scenarios. Independent analyses from the evidence synthesis are also employed throughout. The HAQ-DI costs and withdrawal scenarios are specified for only subpopulations 2 and 3. The full results for these scenarios are presented in *Appendix 13*.

Table 104 illustrates the differences between the base case and the alternative scenarios for each of the concomitant psoriasis subgroups in subpopulation 1. The optimal treatment is consistent across the two scenarios, base case and using a subpopulation-specific baseline HAQ-DI score. In the moderate–severe subgroup, the optimal treatment is BSC at a threshold of £20,000 and CZP at a threshold of £30,000. In the mild–moderate and no concomitant subgroups, the optimal treatment is BSC at a threshold of £20,000 and 150 mg of SEC at a threshold of £30,000. The lower ICERs for SEC in these two subgroups are driven by the lower acquisition costs of the 150-mg dose than of the 300-mg dose used in the moderate–severe subgroup.

TABLE 104 Summary of differences between base-case models and alternative scenarios, subpopulation 1

Scenario	ICERs vs. BSC (£)			Optimal treatment strategy at a threshold of	
	CZP	150 mg of SEC	300 mg of SEC	£20,000	£30,000
Moderate–severe psoriasis					
Base case	20,870	–	26,064	BSC	CZP
Baseline HAQ-DI by subpopulation	20,709	–	25,873	BSC	CZP
Mild–moderate psoriasis					
Base case	23,052	21,772	–	BSC	150 mg of SEC
Baseline HAQ-DI by subpopulation	22,874	21,604	–	BSC	150 mg of SEC
No concomitant psoriasis					
Base case	24,744	23,928	–	BSC	150 mg of SEC
Baseline HAQ-DI by subpopulation	24,543	23,732	–	BSC	150 mg of SEC

Table 105 illustrates the differences between the base case and the alternative scenarios for each of the subgroups in subpopulation 2. Aside from the use of the HAQ-DI costs reported by Poole *et al.*,¹³⁸ the optimal treatment is consistent across all scenarios, BSC at a threshold of £20,000 and ETN at a threshold of £30,000. Using the Poole *et al.*¹³⁸ costs significantly reduces the ICERs for all treatments relative to BSC, as it estimates a much higher cost for BSC. As a result, ETN, as opposed to BSC, is considered to be the most cost-effective treatment at a threshold of £20,000. At a threshold of £30,000, ETN remains the optimal treatment despite the reduced ICERs for all the treatments.

Table 106 illustrates the differences between the base case and the alternative scenarios for each of the subgroups in subpopulation 3. Like subpopulation 2, aside from the use of the Poole *et al.*¹³⁸ costs, the optimal treatment is consistent across all scenarios: BSC at a threshold of £20,000 and UST at a threshold of £30,000. Using the Poole *et al.*¹³⁸ costs significantly reduces the ICERs for all treatments relative to BSC, as it estimates a much higher cost for BSC (see Appendix 13, *Alternative Health Assessment Questionnaire-Disability Index costs from Poole et al.*). As a result, UST, as opposed to BSC, is considered to be the most cost-effective treatment at a threshold of £20,000. At a threshold of £30,000, UST remains the optimal treatment, despite the reduced ICERs across all treatments.

TABLE 105 Summary of differences between base-case models and alternative scenarios, subpopulation 2

Scenario	ICERs vs. BSC (£)							Optimal treatment strategy at a threshold of	
	CZP	150 mg of SEC	300 mg of SEC	ADA	GOL	ETN	INF	£20,000	£30,000
Moderate–severe psoriasis									
Base case	21,564	–	29,569	20,074	20,074	20,197	27,599	BSC	ETN
Baseline HAQ-DI by subpopulation	21,809	–	29,877	20,295	20,384	20,409	27,866	BSC	ETN
Poole <i>et al.</i> ¹³⁸ HAQ-DI costs	3115	–	13,500	3069	3244	2842	13,036	ETN	ETN
Withdrawal scenario 1	21,560	–	30,461	20,074	20,161	20,197	27,599	BSC	ETN
Withdrawal scenario 2	21,791	–	29,562	20,406	20,545	20,555	27,750	BSC	ETN
Mild–moderate psoriasis									
Base case	24,103	22,032	–	23,149	23,419	22,274	31,616	BSC	ETN
Baseline HAQ-DI by subpopulation	24,395	22,294	–	23,418	23,687	22,514	31,938	BSC	ETN
Poole <i>et al.</i> ¹³⁸ HAQ-DI costs	3205	1698	–	3171	3358	2913	13,526	ETN	ETN
Withdrawal scenario 1	24,107	21,291	–	23,153	23,418	22,274	31,616	BSC	ETN
Withdrawal scenario 2	24,459	22,267	–	23,623	23,946	22,734	31,911	BSC	ETN
No concomitant psoriasis									
Base case	26,105	24,773	–	25,532	25,951	23,883	34,930	BSC	ETN
Baseline HAQ-DI by subpopulation	26,444	25,096	–	25,851	26,267	24,150	35,311	BSC	ETN
Poole <i>et al.</i> ¹³⁸ HAQ-DI costs	3341	1794	–	3328	3531	3018	14,279	ETN	ETN
Withdrawal scenario 1	26,117	24,219	–	25,542	25,951	23,883	34,930	BSC	ETN
Withdrawal scenario 2	26,570	25,138	–	26,129	26,604	24,427	35,352	BSC	ETN

TABLE 106 Summary of differences between base-case models and alternative scenarios, subpopulation 3

Scenario	ICERs vs. BSC (£)		Optimal treatment strategy at a threshold of	
	UST	300 mg of SEC	£20,000	£30,000
Moderate–severe psoriasis				
Base case	21,685	36,013	BSC	UST
Baseline HAQ-DI by subpopulation	22,309	26,926	BSC	UST
Poole <i>et al.</i> ¹³⁸ HAQ-DI costs	2778	20,154	UST	UST
Withdrawal scenario 1	21,685	35,876	BSC	UST
Withdrawal scenario 2	21,829	36,276	BSC	UST
Mild–moderate psoriasis				
Base case	24,510	40,639	BSC	UST
Baseline HAQ-DI by subpopulation	25,239	41,721	BSC	UST
Poole <i>et al.</i> ¹³⁸ HAQ-DI costs	2870	20,981	UST	UST
Withdrawal scenario 1	24,510	40,749	BSC	UST
Withdrawal scenario 2	24,763	41,081	BSC	UST
No concomitant psoriasis				
Base case	26,797	111,927	BSC	UST
Baseline HAQ-DI by subpopulation	27,638	46,057	BSC	UST
Poole <i>et al.</i> ¹³⁸ HAQ-DI costs	3010	22,264	UST	UST
Withdrawal scenario 1	26,797	45,105	BSC	UST
Withdrawal scenario 2	27,142	45,389	BSC	UST

Results of subgroup analysis: biologic-experienced secondary failures

As discussed in *Subpopulation 3: biologic experienced*, the RAPID-PsA trial⁴⁷ includes only experienced patients who had a primary response to a biologic treatment (secondary failures), representing a specific subgroup of the overall biologic-experienced subpopulation. In the absence of data for other comparators for this subgroup, the comparison is restricted to CZP and BSC. The results for this subgroup of biologic-experienced patients are presented in *Tables 107–109*.

In the biologic-experienced subgroup including only secondary failures, the ICERs of CZP versus BSC are £16,573, £19,113 and £20,973 for moderate–severe, mild–moderate and no concomitant psoriasis patients, respectively.

TABLE 107 Moderate–severe psoriasis, subpopulation 4, secondary failures: fully incremental cost-effectiveness analysis

Treatment	Cost (£)	QALY	Incremental cost (£)	Incremental QALY	ICER vs. BSC (£)
BSC	95,965	5.312	–	–	–
CZP	121,314	6.841	25,349	1.530	16,573

TABLE 108 Mild–moderate psoriasis, subpopulation 4, secondary failures: fully incremental cost-effectiveness analysis

Treatment	Cost (£)	QALYs	Incremental cost (£)	Incremental QALYs	ICER vs. BSC (£)
BSC	67,000	5.676	–	–	–
CZP	95,470	7.166	28,470	1.490	19,113

TABLE 109 No concomitant psoriasis, subpopulation 4, secondary failures: fully incremental cost-effectiveness analysis

Treatment	Cost (£)	QALYs	Incremental cost (£)	Incremental QALYs	ICER vs. BSC (£)
BSC	51,436	6.188	–	–	–
CZP	81,447	7.622	30,011	1.433	20,937

Results from the probabilistic sensitivity analysis

Results for the three main subpopulations (biologic naive with one prior DMARD, biologic naive with two or more prior DMARDs and biologic experienced), and for three separate concomitant psoriasis subgroups (baseline PASI score = 0, 7.5 or 12.5), are presented and discussed in the following sections. For ease of presentation and interpretation, only tables for the independent analysis from the evidence synthesis are presented in the main body of the report, and summary tables are used to compare with the results based on metaregression approach.

All results presented in *Results* are based on the list prices for SEC and CZP and the originator products for INF and ETN. A separate confidential appendix is included which incorporates the Patient Access Scheme prices for CZP and SEC.

In each of the 15 versions of the model, the expected model outputs are not equal to the output evaluated at the expected values of the parameters of the model [deterministic analysis (DA)], showing that the model is non-linear.

Subpopulation 1: biologic naive (one prior DMARD)

The probabilistic cost-effectiveness results for subpopulation 1 are shown for the three subgroups according to the level of concomitant psoriasis (moderate–severe psoriasis, mild–moderate psoriasis and no concomitant psoriasis) in *Tables 110–112*.

Table 110 shows that the means from the PSA imply the same optimal treatment (CZP) as the DA. The probability that CZP is cost-effective at a threshold of £20,000 is 0.39. At a threshold of £30,000 this increases to 0.53. Using the metaregression results increases the likelihood of CZP being cost-effective to 0.46 at a £20,000 threshold and to 0.63 at a £30,000 threshold.

In the mild–moderate psoriasis group (*Table 111*), again the cost-effectiveness results from the means of the PSA are similar to the results obtained from the DA; 150 mg of SEC represents the optimal treatment at a threshold between £20,000 and £30,000. This is highly uncertain; the probability that CZP is cost-effective at threshold of £20,000 is 0.17. At a threshold of £30,000 this increases to 0.30. Using the metaregression results again produces similar results.

In the no concomitant psoriasis subgroup (*Table 112*), the probabilistic results again imply the same optimal treatment (150 mg of SEC). The probability that 150 mg of SEC is cost-effective at a threshold of £20,000 is 0.28. This increases to 0.45 at a threshold of £30,000. Using metaregression analysis gives very similar results.

TABLE 110 Treatment effects from the independent analysis for moderate–severe psoriasis, subpopulation 1: fully incremental cost-effectiveness PSA

Treatment	Cost (£)	QALYs	Incremental cost (£)	Incremental QALYs	ICER vs. next best option (£)	Pairwise ICER vs. BSC (£)	Probability of being cost-effective at a threshold of	
							£20,000	£30,000
BSC	95,849	5.363	–	–	–	–	0.51	0.20
CZP	160,096	8.363	64,247	3.000	21,417	21,417	0.39	0.53
300 mg of SEC	179,594	8.661	19,498	0.298	65,416	25,394	0.10	0.26

TABLE 111 Treatment effects from the independent analysis for mild–moderate psoriasis, subpopulation 1: fully incremental cost-effectiveness PSA

Treatment	Cost (£)	QALYs	Incremental cost (£)	Incremental QALYs	ICER vs. next best option (£)	Pairwise ICER vs. BSC (£)	Probability of being cost-effective at a threshold of	
							£20,000	£30,000
BSC	66,885	5.727	–	–	–	–	0.46	0.20
CZP	135,999	8.653	69,114	2.926	Dominated	23,621	0.17	0.30
150 mg of SEC	132,284	8.822	–3714	0.168	21,136	21,136	0.37	0.50

TABLE 112 Treatment effects from the independent analysis for no concomitant psoriasis, subpopulation 1: fully incremental cost-effectiveness PSA

Treatment	Cost (£)	QALYs	Incremental cost (£)	Incremental QALYs	ICER vs. next best option (£)	Pairwise ICER vs. BSC (£)	Probability of being cost-effective at a threshold of	
							£20,000	£30,000
BSC	51,321	6.239	–	–	–	–	0.59	0.26
CZP	122,839	9.061	71,518	2.822	Dominated	25,342	0.13	0.29
150 mg of SEC	120,028	9.204	–2810	0.142	23,177	23,177	0.28	0.45

Table 113 illustrates the differences between the independent analysis and the meta-regression evidence synthesis for each of the subgroups in subpopulation 1 using the means from the PSA. The pairwise ICERs for each of the treatments compared with BSC are presented along with the optimal (or most cost-effective) treatment strategy determined based on the fully incremental ICER comparisons at thresholds of £20,000 and £30,000 per QALY.

In summary, the differences in the pairwise ICERs estimated using the alternative synthesis models have only a minor effect. Furthermore, the optimal treatment remains consistent across the two evidence synthesis approaches using a threshold of £30,000 per QALY. At a threshold of £20,000 the optimal treatment is BSC, unlike the DA results. The ICER for CZP compared with BSC now is beyond the threshold (£20,621) based on the results of the meta-regression.

TABLE 113 Summary of differences for the PSA results between independent and metaregression approaches, subpopulation 1

NMA approach	ICERs vs. BSC (£)			Optimal treatment strategy at a threshold of	
	CZP	150 mg of SEC	300 mg of SEC	£20,000	£30,000
Moderate–severe psoriasis					
Independent analysis	21,417	–	25,394	BSC	CZP
Metaregression	20,621	–	26,766	BSC	CZP
Mild–moderate psoriasis					
Independent analysis	23,621	21,136	–	BSC	150 mg of SEC
Metaregression	23,280	20,993	–	BSC	150 mg of SEC
No concomitant psoriasis					
Independent analysis	25,342	23,177	–	BSC	150 mg of SEC
Metaregression	25,334	23,090	–	BSC	150 mg of SEC

Subpopulation 2: biologic naive (two or more prior DMARDs)

The means from the PSA for subpopulation 2 are reported according to the level of concomitant psoriasis (moderate–severe psoriasis, mild–moderate psoriasis and no concomitant psoriasis) in *Tables 114–116*.

In the moderate–severe subgroup (*Table 114*), the PSA results imply a different optimal treatment from the DA results; it switches from ETN to GOL. This is driven by the skewed nature of the PASI 75 data. *Figure 20* shows that the PASI 75 data for ETN have the widest variation, with the mean having greater value than the median, indicating that the data are rightly skewed. PASI 75 response plays a more important role in this subgroup than in those with the mild–moderate or no concomitant psoriasis.

There is a high degree of uncertainty around the choice of optimal treatment (GOL); the probability that GOL is cost-effective is 0.20 at a threshold of £20,000 and 0.23 at a threshold of £30,000. Using the metaregression estimates reduces the difference between the QALYs for GOL and ETN, making ETN within the threshold of

TABLE 114 Treatment effects from the independent analysis for moderate–severe psoriasis, subpopulation 2: fully incremental cost-effectiveness PSA

Treatment	Cost (£)	QALYs	Incremental cost (£)	Incremental QALYs	ICER vs. next best option (£)	Pairwise ICER vs. BSC (£)	Probability of being cost-effective at a threshold of	
							£20,000	£30,000
BSC	95,849	5.363	–	–	–	–	0.26	0.10
CZP	137,306	7.255	41,457	1.893	Extendedly dominated	21,906	0.13	0.11
ADA	138,117	7.494	811	0.239	Extendedly dominated	19,831	0.16	0.16
300 mg of SEC	156,926	7.531	18,809	0.036	Dominated	28,176	0.03	0.07
GOL	142,645	7.753	–14,281	0.223	19,577	19,577	0.20	0.23
ETN	144,518	7.800	1873	0.047	39,854	19,968	0.21	0.26
INF	166,776	8.075	22,257	0.275	81,064	26,153	0.01	0.08

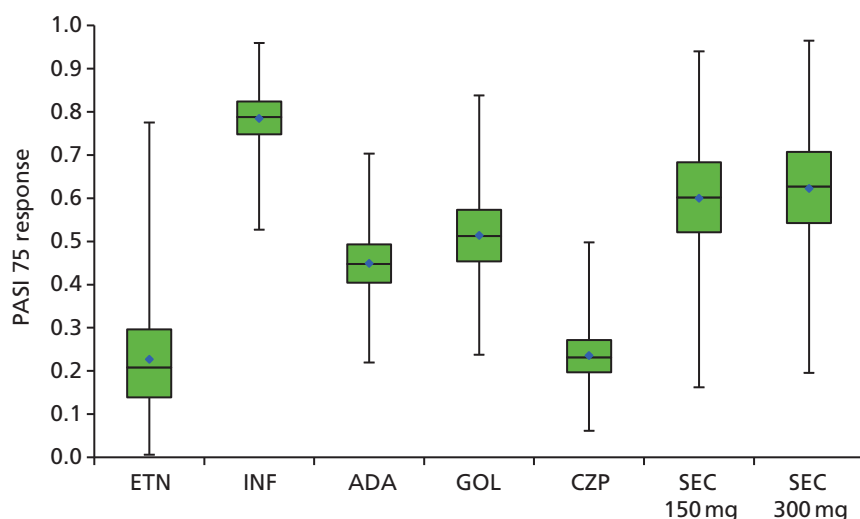

FIGURE 20 Range of values and distributions for PASI 75 response for the treatments.

£30,000 at £25,886 per QALY compared with GOL. Again, this decision is highly uncertain; probability of being cost-effective is 0.20 and 0.25 at a threshold of £20,000 and £30,000, respectively.

Table 115 shows the results for the mild–moderate psoriasis subgroup. In this subgroup, the optimal treatment (ETN) is consistent for the PSA and DA results. The probability that ETN is cost-effective is 0.13 at a threshold of £20,000 and 0.22 at a threshold of £30,000. Using the metaregression estimates increases the decision uncertainty associated with ETN and makes 150 mg of SEC the optimal treatment within a threshold of £30,000 and with a probability of being cost-effective of 0.21.

For the no concomitant psoriasis subgroup (PASI score = 0) (Table 116), the choice of optimal treatment (ETN) is consistent across the PSA and DA results. The probability that ETN is cost-effective is highly uncertain, with a probability of 0.12 at a threshold of £20,000 and of 0.22 at a threshold of £30,000. Using metaregression switches the optimal treatment (see Table 8). The uncertainty associated with the optimal treatment (150 mg of SEC) is somewhat less uncertain, the probability being 0.19.

TABLE 115 Treatment effects from the independent analysis for mild–moderate psoriasis, subpopulation 2: fully incremental cost-effectiveness PSA

Treatment	Cost (£)	QALYs	Incremental cost (£)	Incremental QALYs	ICER vs. next best option (£)	Pairwise ICER vs. BSC (£)	Probability of being cost-effective at a threshold of	
							£20,000	£30,000
BSC	66,885	5.727	–	–	–	–	0.28	0.13
CZP	111,852	7.567	44,967	1.839	Dominated	24,446	0.14	0.12
150 mg of SEC	108,252	7.712	–3600	0.145	20,844	20,844	0.20	0.18
ADA	113,980	7.791	5728	0.079	Extendedly dominated	22,819	0.11	0.13
GOL	119,349	8.040	5369	0.248	Dominated	22,691	0.13	0.18
ETN	119,168	8.107	–181	0.068	27,619	21,969	0.13	0.22
INF	145,152	8.346	25,985	0.238	108,986	29,893	0.00	0.05

TABLE 116 Treatment effects from independent analysis for no concomitant psoriasis, subpopulation 2: fully incremental cost-effectiveness PSA

Treatment	Cost (£)	QALYs	Incremental cost (£)	Incremental QALYs	ICER vs. next best option (£)	Pairwise ICER vs. BSC (£)	Probability of being cost-effective at a threshold of	
							£20,000	£30,000
BSC	51,321	6.239	–	–	–	–	0.33	0.16
CZP	98,022	8.004	46,701	1.765	Dominated	26,461	0.14	0.13
150 mg of SEC	95,329	8.123	–2693	0.119	23,356	23,356	0.19	0.17
ADA	100,800	8.208	5471	0.085	Extendedly dominated	25,129	0.10	0.13
GOL	106,585	8.441	5785	0.233	Dominated	25,095	0.11	0.16
ETN	105,389	8.538	–1196	0.097	24,248	23,517	0.12	0.22
INF	133,214	8.726	27,826	0.188	148,259	32,932	0.00	0.03

Table 117 summarises the differences between the independent analysis and the metaregression evidence synthesis for each of the separate psoriasis subgroups within subpopulation 2. Although there are only minimal differences in the pairwise ICERs in this subpopulation, the optimal treatment alters across the two evidence synthesis approaches. In the moderate–severe subgroup, it switches from ETN to GOL because of the skewness of the PASI 75 data for ETN. In the mild–moderate and no concomitant subgroups, the optimal treatment switches from ETN to 150 mg of SEC. These differences are driven by the increased relative effectiveness of 150 mg of SEC in the metaregression approach.

TABLE 117 Summary of differences for the PSA results between independent and metaregression approaches, subpopulation 2

NMA approach	ICERs vs. BSC (£)							Optimal treatment strategy at a threshold of	
	CZP	150 mg of SEC	300 mg of SEC	ADA	GOL	ETN	INF	£20,000	£30,000
Moderate–severe psoriasis									
Independent analysis	21,906	–	28,176	19,831	19,577	19,968	26,153	BSC	GOL
Metaregression	20,256	–	29,289	19,812	20,038	20,285	27,411	BSC	ETN
Mild–moderate psoriasis									
Independent analysis	24,446	20,844	–	22,819	22,691	21,969	29,893	BSC	ETN
Metaregression	23,279	20,262	–	22,752	22,543	22,406	30,690	BSC	150 mg of SEC
No concomitant psoriasis									
Independent analysis	26,461	23,356	–	25,129	25,095	23,517	32,932	BSC	ETN
Metaregression	25,630	22,675	–	25,023	24,484	24,052	33,391	BSC	150 mg of SEC

Subpopulation 3: biologic experienced

Tables 118–120 present the results for subpopulation 3 for the moderate–severe, mild–moderate and no concomitant psoriasis subgroups. Similar to the DA results, in the moderate–severe subgroup, UST is the optimal treatment at thresholds of £20,000 and £30,000. The probability of UST being cost-effective at a threshold of £20,000 is 0.48. This increases to 0.50 using a threshold of £30,000.

Table 119 shows the results for the mild–moderate psoriasis subgroup. The optimal treatment remains UST, with the probability that it is cost-effective at a threshold of £20,000 being 0.45. This increases to 0.49 at a threshold of £30,000.

Table 120 shows the results of non-evaluable psoriasis subgroup. In this subgroup, again, the choice of optimal treatment (UST) is consistent across the PSA and DA. The probability that UST is cost-effective at a threshold of £20,000 is 0.43 and at a threshold of £30,000 is 0.49.

TABLE 118 Moderate–severe psoriasis, subpopulation 3: fully incremental cost-effectiveness PSA

Treatment	Cost (£)	QALYs	Incremental cost (£)	Incremental QALYs	ICER vs. next best option (£)	Pairwise ICER vs. BSC (£)	Probability of being cost-effective at a threshold of	
							£20,000	£30,000
BSC	95,849	5.363	–	–	–	–	0.44	0.34
UST	117,666	6.605	21,817	1.242	17,571	17,571	0.48	0.50
300 mg of SEC	143,629	6.636	25,964	0.032	818,886	37,524	0.09	0.16

TABLE 119 Mild–moderate psoriasis, subpopulation 3: fully incremental cost-effectiveness PSA

Treatment	Cost (£)	QALYs	Incremental cost (£)	Incremental QALYs	ICER vs. next best option (£)	Pairwise ICER vs. BSC (£)	Probability of being cost-effective at a threshold of	
							£20,000	£30,000
BSC	66,885	5.727	–	–	–	–	0.47	0.36
UST	90,719	6.935	23,835	1.208	19,731	19,731	0.45	0.49
300 mg of SEC	118,576	6.950	27,857	0.014	1,961,907	42,295	0.07	0.14

TABLE 120 No concomitant psoriasis, subpopulation 3: fully incremental cost-effectiveness PSA

Treatment	Cost (£)	QALYs	Incremental cost (£)	Incremental QALYs	ICER vs. next best option (£)	Pairwise ICER vs. BSC (£)	Probability of being cost-effective at a threshold of	
							£20,000	£30,000
BSC	51,321	6.239	–	–	–	–	0.50	0.38
300 mg of SEC	104,944	7.389	53,624	1.150	Dominated	46,617	0.07	0.13
UST	76,152	7.400	–28,792	0.010	21,394	21,394	0.43	0.49

Summary of the model results

The current York model specifies three main subpopulations according to the position in the pathway of treatment:

1. subpopulation 1: biologic naive, one previous cDMARD
2. subpopulation 2: biologic naive, two or more previous cDMARDs
3. subpopulation 3: biologic experienced.

For subpopulation 3, CZP was excluded on the basis that data were available for only a subset of biologic-experienced patients (see *Patient characteristics* and *Choice of intervention and comparators*). A separate scenario was conducted for secondary failures as a result of the availability of data for CZP. This scenario includes only CZP versus BSC.

Three subgroups are also specified within each of the three subpopulations. These subgroups refer to the severity of concomitant psoriasis:

1. no concomitant psoriasis
2. mild–moderate concomitant psoriasis
3. moderate–severe concomitant psoriasis.

A fourth subpopulation is also specified, which defines a population in which TNF- α inhibitors are contraindicated (subpopulation 4). A number of scenarios are specified to explore the robustness of some of the assumptions made in the model: rate of withdrawals beyond the first cycle and source of costs relating to HAQ-DI. In addition, separate analyses were conducted using biosimilar prices for ETN and INF and Patient Access Scheme prices for CZP and SEC.

Base-case results

Under base-case assumptions and using the independent analysis from the evidence synthesis, the results for each of the three subpopulations can be summarised as:

- For subpopulation 1:
 - CZP is likely to be the optimal treatment in the moderate–severe psoriasis group (ICER = £20,870 compared with BSC). The individual pairwise ICER for 300 mg of SEC compared with BSC is £26,064 per QALY.
 - In the mild–moderate psoriasis group, CZP is dominated by 150 mg of SEC, which has an ICER of £21,772 compared with BSC. The individual pairwise ICER for CZP compared with BSC is £23,052 per QALY.
 - In the no concomitant psoriasis subgroup, CZP is no longer dominated by 150 mg of SEC; however, its ICER is substantial compared with 150 mg of SEC (£346,785). The ICER for 150 mg of SEC increases to £23,928, compared with BSC. The individual pairwise ICER for CZP compared with BSC is £24,774 per QALY.
- For subpopulation 2:
 - ETN is likely to be the optimal treatment in the moderate–severe subgroup, with an ICER of £21,210 compared with GOL. The individual pairwise ICERs for CZP and 300 mg of SEC compared with BSC are £21,564 and £29,569 per QALY, respectively.
 - For the mild–moderate psoriasis subgroup, again ETN appears to be the optimal treatment, with an ICER of £23,256 compared with 150 mg of SEC. The individual pairwise ICERs for CZP and 150 mg of SEC compared with BSC are £24,103 and £22,032 per QALY, respectively.
 - For the no concomitant psoriasis subgroup, the ICERs increase for all treatments. ETN is likely to be the optimal treatment in this subgroup, with an ICER of £23,883 compared with BSC.

The individual pairwise ICERs for CZP and 150 mg of SEC compared with BSC are £24,103 and £22,032 per QALY, respectively.

- For subpopulation 3:
 - UST is likely to be the optimal treatment for the moderate–severe psoriasis subgroup, with an ICER of £21,684 compared with BSC. The individual pairwise ICER for 300 mg of SEC compared with BSC is £36,013 per QALY.
 - In the mild–moderate psoriasis subgroup, the ICER for UST compared with BSC increases to £24,510. The individual pairwise ICER for 300 mg of SEC compared with BSC is £40,639 per QALY.
 - In the non-evaluable psoriasis subgroup, UST is likely to be the optimal treatment, at thresholds below £30,000, with an ICER of £26,797 compared with BSC. The individual pairwise ICER for 300 mg of SEC compared with BSC is £44,774 per QALY.

For subpopulations 1 and 2, separate effectiveness results are also available utilising a metaregression approach. The differences between the independent analysis and the metaregression can be summarised as:

- In subpopulation 1 the use of the metaregression evidence has a minimal impact on the pairwise ICERs; however, at a threshold of £20,000 the optimal treatment changes in the moderate–severe subgroup. CZP is now likely to be the most cost-effective treatment, as its ICER, compared with BSC, falls below the threshold (£19,908).
- In subpopulation 2, again, there are only minimal differences in the pairwise ICERs; however, the optimal treatment is not consistent across the two evidence synthesis approaches. Both approaches accord in terms of the optimal strategy at a threshold of £20,000 for the mild–moderate and no concomitant subgroups. In the moderate–severe subgroup, the ICER for CZP (compared with BSC – its next best) falls below £20,000, therefore at this threshold it represents the optimal treatment. Using the metaregression estimates, CZP, as opposed to ETN, represents the most cost-effective optimal treatment at a threshold value of £30,000 per QALY in the moderate–severe psoriasis group. In addition, the optimal treatment switches from ETN to 150 mg of SEC in the mild–moderate and no concomitant psoriasis subgroups.

In the contraindicated subgroup (subpopulation 4):

- UST appears to be the most cost-effective treatment in moderate–severe psoriasis patients, with an ICER of £19,969 compared with BSC. The individual pairwise ICER for 300 mg of SEC compared with BSC is £34,445 per QALY.
- In mild–moderate psoriasis patients, UST is dominated by 150 mg of SEC. Compared with BSC, 150 mg of SEC has an ICER of £19,349.
- In the no concomitant psoriasis patients, UST is extendedly dominated by 150 mg of SEC. Compared with BSC, 150 mg of SEC has an ICER of £22,334.

In the biologic-experienced subgroup, including only secondary failures, CZP seems to be the cost-effective treatment compared with BSC, with ICERs of £16,573, £19,113 and £20,973 for moderate–severe, mild–moderate and no concomitant psoriasis patients, respectively.

Results using biosimilar prices

When using biosimilar prices for ETN and INF in subpopulation 2, the ICERs for ETN compared with BSC and for INF compared with ETN decrease. The ICER for ETN compared with its next best alternative (BSC) in the moderate–severe subgroup falls below the threshold of £20,000; therefore, at this threshold, using the biosimilar prices for ETN, the optimal treatment switches from BSC to ETN. For the mild–moderate and no concomitant psoriasis subgroups the optimal treatment remains unchanged.

Scenario results

A number of scenarios were specified to explore the sensitivity of results to some of the assumptions made in the model. Alternative scenarios were specified for the three main subpopulations, although withdrawal scenarios and the use of Poole *et al.*¹³⁸ costs were conducted only for subpopulations 2 and 3. List prices and originator products (ETN and INF) are used in all of these scenarios. Independent analyses from the evidence synthesis are also employed throughout. The results can be summarised as:

- In subpopulation 1, the optimal treatment is consistent across the two scenarios, base case and using a subpopulation-specific baseline HAQ-DI score.
- In subpopulation 2, aside from the use of the Poole *et al.*¹³⁸ HAQ-DI costs, the optimal treatment is consistent across all scenarios. Using the Poole *et al.*¹³⁸ costs significantly reduces the ICERs for all treatments relative to BSC, as it estimates a much higher cost for BSC. As a result, ETN, as opposed to BSC, is identified to be the most cost-effective treatment at a threshold of £20,000 per QALY. At a threshold of £30,000 per QALY, ETN remains the optimal treatment despite the reduced ICERs for all the treatments.
- In subpopulation 3, aside from the use of the Poole *et al.*¹³⁸ costs, the optimal treatment is consistent across all scenarios. Using the Poole *et al.*¹³⁸ costs significantly reduces the ICERs for all treatments relative to BSC, as it estimates a much higher cost for BSC. As a result, UST, as opposed to BSC, is considered to be the most cost-effective treatment at a threshold of £20,000 per QALY. At a threshold of £30,000 per QALY, UST remains the optimal treatment despite the reduced ICERs across all treatments.

Probabilistic sensitivity analysis

- In all subpopulations and subgroups according to level of psoriasis, the PSA demonstrates considerable decision uncertainty regarding the optimal treatment, at both £20,000 and £30,000 thresholds.
- The ICERs are broadly consistent between the deterministic and the means of the PSA. Although there are only small differences in the ICER, the optimal treatment does change in a few instances:
 - in subpopulation 1, at a threshold of £20,000 the optimal treatment is BSC, unlike the deterministic results, where either CZP or SEC are optimal
 - in subpopulation 2 the optimal treatment changes in the moderate–severe subgroup, from ETN in the deterministic results to GOL in the means of the PSA.

External validation of results

Comparison of updated York model results with company model results

In the absence of a list price analysis from either of the companies, it is not possible to make direct comparisons between the updated York model results and those from the Novartis and UCB Pharma submissions. In general, the structure and approaches of both company models were similar in many key respects to the updated York model and models developed as part of previous appraisals. However, as highlighted in *Chapter 5*, further challenges arise when trying to make comparisons between the results of the updated York model, similar to those we faced when trying to make comparisons between the CSs, given the differences identified in the approaches and data sources employed. On this basis we consider that direct comparisons between the ICER results would not be sufficiently meaningful.

The main advantage of the York model is that it facilitates a more consistent basis for evaluating CZP and SEC by ensuring comparability in methods and inputs (including prices). In addition, the York model attempts to include all relevant treatments within each subpopulation and more explicitly considers issues around the appropriate dosing for SEC by undertaking separate subgroup analyses based on the presence and severity of concomitant psoriasis.

Comparison of updated York model results with published models' results

It is possible to compare some of the results of the updated York model with those from previously published models, namely the three models developed as part of previous appraisals in this area (TA199,³³ TA220¹³³ and TA340³⁵), and a published update of the previous York model by Cawson *et al.*³⁶ (see *Table 3*). This comparison is somewhat restricted by the more limited scope in previously published models. In TA199,³³ TA220¹³³ and Cawson *et al.*,³⁶ only subpopulation 2 was considered. TA340³⁵ also included an analysis for subpopulations 3 and 4 together [experienced and contraindicated (termed ineligible)]. All previously published models looked at the extent of concomitant psoriasis; however, this was included only as limited scenario analyses and full results are only available for the average severity of psoriasis: mild–moderate. It is also noted that none of the previously published models included the comparators CZP or SEC.

In terms of the results for subpopulation 2, the ICERs for ETN versus the next best treatment are broadly consistent across the updated York model and the four published models (£16,426 in Cawson *et al.*³⁶ to £23,256 in the updated York model, mild–moderate psoriasis subgroup). For subpopulation 3, TA340³⁵ included a separate analysis of a biologic-experienced/contraindicated population for UST. In this analysis, the ICER for UST compared with BSC was £25,393. This result is very similar to those from subpopulation 3 of the updated York model results, in which the ICER for UST compared with BSC, in the mild–moderate psoriasis subgroup, is £24,510. In the contraindicated subgroup (subpopulation 4 of the York model), in mild–moderate psoriasis patients, the ICER for UST compared with BSC is again broadly consistent at £22,708. In the full incremental analysis for this subpopulation, however, UST is dominated by 150 mg of SEC and 150 mg of SEC has an ICER of £19,349 compared with BSC.

Discussion of the York model

The previous York model has been updated for this appraisal. This includes an update of the evidence used to populate the model and a number of updates to the model structure and assumptions. Specifically, the updated York model differs from the previous York in several respects:

- The model now incorporates subsequent biologic treatments following primary lack of response or secondary failure.
- The model now includes the three subpopulations specified in the NICE scope¹¹² for this appraisal.
- Rather than presenting a single base case reflecting an 'average' PsA patient, heterogeneity in terms of baseline PASI score is now formally addressed by presenting results for three distinct subgroups within each subpopulation.

In addition, the updated York model includes the comparators CZP and SEC and considers the cost-effectiveness of these treatments in each of the subpopulations. The updated York model also considers several key uncertainties: the acquisition cost of SEC and CZP (list or Patient Access Scheme prices); the products for ETN and INF (originator or biosimilar); the source algorithm used to link progression in HAQ-DI score to costs; and assumptions regarding the longer-term rate of withdrawal for primary responders.

The model utilises all currently available evidence to generate estimates of clinical effectiveness using NMA. Alternative models are specified for the NMA, and a more limited set of models is chosen on the basis of model fit, goodness-of-fit statistics and clinical plausibility. These alternative models (independent analysis and metaregression) are each used in the economic model and the sensitivity of model results to these alternative evidence synthesis models assessed.

Using list prices, SEC and CZP are likely to be considered cost-effective only in subpopulation 1 (biologic naive, one prior DMARD). In subpopulation 2, ETN is likely to be the optimal treatment across all psoriasis subgroups and, in subpopulation 3, UST is likely to be the optimal treatment across all psoriasis subgroups. The cost-effectiveness results are, however, sensitive to a number of assumptions made in the model,

namely the choice of NMA model used to determine clinical effectiveness and the algorithm used to link HAQ-DI score to health state costs.

The updated York model also has a number of limitations, which have largely been imposed by a lack of available data to inform aspects of the model. First, subpopulation 1 includes only the comparators CZP, SEC and BSC, as per the NICE scope.¹¹² It is recognised, however, that there may be other comparators relevant for this subpopulation. In particular, patients who have received only one prior DMARD may be eligible to receive a second DMARD. It was not possible within the scope of this appraisal to assess the evidence for DMARDs and, therefore, include this as a formal comparator in this subpopulation. The extremely low cost of DMARDs (7.5 mg of MTX is £0.30) makes it likely that these would be considered cost-effective in this population. In addition, the licences for the other biologic treatments (ETN, INF, ADA and GOL) do not preclude their use in the one-DMARD population and, therefore, these could be considered to be relevant comparators in subpopulation 1. Indeed, this subpopulation appears to not have been considered in previously published models, largely because the scope of these models has closely followed existing BSR guidelines and criteria for commencing biologic treatments (i.e. that the PsA has not responded to adequate trials of at least two standard DMARDs, administered either individually or in combination), as opposed to reflecting important differences in the licences of existing biologic treatments and those for SEC and CZP.

Second, the clinical effectiveness evidence synthesised in the NMA does not differentiate between subpopulations 1 and 2 as a result of the limited data availability. This means that it was possible to differentiate these two populations only on the basis of the comparators included and the subsequent treatments received following primary failure or secondary withdrawal. Related to this, the subpopulation 1 analysis makes the assumption that ETN is the next treatment received, following failure of 150 mg of SEC or CZP. It is likely that other treatments could be used as second line in this population. Owing to the large number of possible treatment sequences for subpopulation 1, it was not feasible as part of this appraisal to determine the optimal sequence for all potential treatments. Modelling multiple lines of biologic treatments would also require evidence on any degradation effect for subsequent lines. Such evidence is sparse in PsA and that which exists does not consider the full set of biologic treatments considered in this appraisal.

Finally, it has not been possible to update a number of the assumptions in the York model, specifically the rate of withdrawal for primary responders, the progression in HAQ-DI score for those receiving treatment, and the progression of HAQ-DI score for those remaining on treatment. These assumptions rely on non-experimental data and, unfortunately, within the time constraints of this appraisal, it was not possible to gain access to registry data to update these assumptions, although attempts to do so were made.

Given these uncertainties and possible limitations, and the lack of direct head-to-head evidence for the alternative treatments, the results from the fully incremental cost-effectiveness analyses should be carefully considered alongside the separate pairwise comparisons presented against BSC. The significant efficacy of all biologic treatments was evident in the important QALY differences reported compared with BSC alone. In contrast, differences between the alternative biologic therapies were much less significant and, in some instances, may not be clinically meaningful. Hence, there remains considerable uncertainty in relation to defining an optimal treatment or pathway of care. The PSA also demonstrates considerable decision uncertainty regarding the optimal treatment, at both £20,000 and £30,000 thresholds.

Chapter 7 Assessment of factors relevant to the NHS and other parties

The potential extra cost to the NHS of providing SEC and CZP to adult patients with PsA is unclear, as the prevalence of UK PsA patients in subpopulation 1 is somewhat uncertain.

Chapter 8 Discussion

Statement of principal findings

The systematic review of the efficacy of SEC, CZP and relevant comparator therapies in patients with PsA identified an evidence base of generally high-quality randomised trials. The results of the pivotal randomised trials of SEC (FUTURE 2 trial⁴⁸) and CZP (RAPID-PsA trial⁴⁷) demonstrated their short-term efficacy for treating PsA. When considering the whole-trial populations, both SEC and CZP were associated with statistically significant improvements in all key clinical outcomes. At 3 months, patients taking SEC were around six times more likely to be ACR 50 responders – an important clinical outcome to patients – than patients taking placebo. Patients taking CZP were around three times more likely to be ACR 50 responders than placebo patients. Clinically important improvements in activities of daily living (assessed using the HAQ-DI) were also evident for both therapies, particularly in patients who were PsARC responders. In addition, both SEC and CZP significantly improved measures of HRQoL and the resolution of enthesitis and dactylitis.

However, when the populations from these two trials were split into subgroups based on previous biologic experience, results for the biologic-experienced subgroups became difficult to interpret. This was as a result of both the low numbers of placebo patients (and placebo events) and the differences in placebo response rates across subgroups; it was therefore not possible to make robust conclusions about the relative efficacy of SEC and CZP across these subgroups.

Subgroup results from PsA patients recruited to trials of patients with quite severe psoriasis suggested SEC may be particularly efficacious in treating the psoriasis symptoms of PsA.

The results from open-label trial extension studies that radiographically assessed joint damage indicated that, after 2 years of treatment, CZP effectively reduced disease progression, with benefits being similar to those observed in the open-label studies for the other biologics. For SEC, fewer result details were available at 2 years, although results also indicated effective reduction in radiographic disease progression. Meaningful treatment comparisons of longer-term data for other outcomes were difficult to undertake because of the variation in both time points assessed and in methodological approaches used for data analyses (confidential information has been removed).

The trials identified to inform a comparison of SEC and CZP with other biologics were performed across a 15-year period and variation in placebo response was evident for some important outcomes, with larger placebo response rates seen in the more recent trials. Furthermore, there was important heterogeneity across trials with regard to patients' previous use of a biologic therapy: subgroups of biologic-experienced patients were recruited only in more recent trials. Our NMAs were therefore performed on the biologic-naive and biologic-experienced subgroups separately, and included models which adjusted for, and explored, the different rates of placebo response across trials.

The NMA results – both adjusted and unadjusted – demonstrated that, in biologic-naive patients, SEC and CZP were more effective than placebo in terms of achieving PsARC and ACR responses. There was though some uncertainty regarding the relative effectiveness of SEC and CZP when compared with each other and with all other biologics: they had fairly similar effectiveness when compared with the other anti-TNFs, although they were possibly slightly more effective than UST. However, both SEC and CZP appeared to be more effective than APR. In terms of psoriasis outcomes in biologic-naive patients, treatment with SEC and INF resulted in the best PASI results when compared with other therapies, although the differences for most comparisons were not statistically significant.

The median HAQ-DI score change, conditional on a PsARC response, was highest with INF and ETN, followed by 300 mg of SEC, but 150 mg of SEC and CZP were worse than all treatments except for APR.

Only three trials recruited biologic-experienced patients: one each of SEC, CZP and UST. Unfortunately, data from the CZP trial had to be excluded from the NMAs because this trial included a more restricted biologic-experienced population, which was not comparable to the biologic-experienced populations in the other two trials. The NMA results showed that the probabilities of PsARC and ACR responses with SEC and UST were quite similar, as was the change in HAQ-DI score in PsARC responders. Patient numbers were particularly limited for the biologic-experienced PASI analyses, as they were based on a subgroup (prior use of a biologic) of a subgroup (psoriasis on $\geq 3\%$ of BSA), so estimates from the NMA were highly uncertain. However, the results suggested that the probabilities of achieving PASI responses were higher for SEC than for UST.

Results from studies of patient registries that recorded biologic use suggested that, although patients benefit from a second or further anti-TNFs, the expected benefit from anti-TNFs diminishes after switching, with a reduced chance of response and reduced drug survival. The paucity of observational data on the natural history of PsA meant that it was difficult to produce accurate estimates of yearly disease progression rates in patients not taking anti-TNFs.

Results from three systematic reviews of AEs suggested that CZP was associated with statistically significantly more SAEs and serious infections than placebo. SEC was not included in these systematic reviews of AEs, probably as a result of the limited availability of data at the time. Although the safety data for SEC appear promising, the fairly small number of trials for which data are currently available means that there is still some uncertainty regarding its safety.

Strengths and limitations of the assessment

Strengths

The systematic review was performed using transparent, reproducible and robust methods. Our comprehensive searches therefore sought to identify all relevant published and unpublished trials, which minimised the possibility of publication or language biases affecting the review results. The possibility of reviewer errors and biases affecting this assessment was minimised by performing review processes in duplicate. A thorough evaluation of the risk of bias in each randomised trial was performed. We conducted many NMAs to investigate the relative efficacy of all the comparator agents. Additionally, and in order to improve the methodological similarity of the trial data included in our analyses, we successfully obtained previously unpublished data relating to two key trials (for which manufacturer submission data were not available).

A further key strength of our review was the breadth of its scope: in addition to randomised trials we included other types of study, such as non-randomised trial extension studies, registry studies of patients taking anti-TNFs, systematic reviews and other large studies of adverse effects of anti-TNFs and studies of the natural history of PsA. Our review was reported based on the Preferred Reporting Items for Systematic Reviews and Meta-Analyses statement.

The updated York model confers several advantages over current published cost-effectiveness studies, namely the inclusion of the three subpopulations according to the position in the pathway of treatment, the explicit consideration of the severity of concomitant psoriasis and the modelling of subsequent treatments following primary non-response or secondary failure. Like the company models, the updated York model includes the comparators CZP and SEC. In addition, it considers the cost-effectiveness of these treatments in each of the subpopulations and more explicitly considers issues around the appropriate dosing for SEC by undertaking separate subgroup analyses based on the presence and severity of concomitant psoriasis.

The updated York model also considers several key uncertainties: the acquisition cost of SEC and CZP (list or Patient Access Scheme prices); the products for ETN and INF (branded or biosimilars); the source algorithm used to link progression in HAQ-DI score to costs; and assumptions regarding the longer-term rate of withdrawal for primary responders.

The model utilises all currently available evidence to generate estimates of clinical effectiveness using a NMA. Alternative models are specified for the NMA, and a more limited set of models is chosen on the basis of model fit, goodness-of-fit statistics and clinical plausibility. These alternative models (independent analysis and metaregression) are each used in the economic model and the sensitivity of model results to these alternative evidence synthesis models assessed. The York model facilitates a more consistent basis for evaluating CZP and SEC by ensuring comparability in methods and inputs.

Limitations

Data from randomised, fully blinded populations were available only for up to around 3 or 4 months for most of the trials included in our review (after which patients could cross over to active treatments); much of the RCT evidence was therefore quite short term in nature. Some of the earlier trials were also limited by small sample sizes (increasing the possibility of results being attributable to chance, rather than being attributable to treatment). The variation in placebo responses over time was also a limitation of the available data, although we sought to address this in our NMAs (using metaregression adjustments). Although we also evaluated long-term results from studies that were not RCTs, data from such studies may have been affected by biases or confounding and often either key method details were absent from publications or methods were found to be suboptimal. Much less reliability and certainty could therefore be ascribed to the results obtained from these other studies.

As discussed previously, the updated York model does have a number of limitations, which have largely been imposed by a lack of available data to inform aspects of the model.

Of particular note is the fact that subpopulation 1 includes only the comparators CZP, SEC and BSC, as per the NICE scope.¹¹² It is recognised, however, that there may be other comparators relevant for this subpopulation. In particular, patients who have received only one prior DMARD may be eligible to receive a second DMARD. It was not possible within the scope of this appraisal to assess the evidence for DMARDs and, therefore, include this as a formal comparator in this subpopulation. In addition, the licences for the other biologic treatments (ETN, INF, ADA and GOL) do not appear to preclude their use in the one-DMARD population and, therefore, these could be considered to be relevant comparators in subpopulation 1. Indeed, this subpopulation appears to not have been considered in previous models, largely because the scope of these models has closely followed existing BSR guidelines and criteria for commencing biologic treatments (i.e. that the PsA has not responded to adequate trials of at least two standard DMARDs, administered either individually or in combination), as opposed to reflecting important differences in the licences of existing biologic treatments and those for SEC and CZP.

Uncertainties

- The magnitude of SEC and CZP treatment effects in biologic-experienced patients is uncertain because the trial subgroup sample sizes were small, and the subgroup in the CZP trial was not appropriately representative of the biologic-experienced population that would be seen in clinical practice.
- The limitations and variations in the design and reporting of long-term studies means that there is uncertainty whether or not there are differences in efficacy and safety between the different therapies in the long term.
- The long-term impact of SEC and CZP (and other anti-TNFs) on other important outcomes, such as cardiovascular disease and mortality, is uncertain.

The cost-effectiveness results are potentially sensitive to a number of assumptions made in the model, namely the choice of NMA model used to determine clinical effectiveness and the algorithm used to link HAQ-DI score to health state costs. Given these uncertainties and the lack of direct head-to-head evidence for the alternative treatments, the results from the fully incremental cost-effectiveness analyses should also be considered alongside the separate pairwise comparisons presented against BSC. The significant efficacy of all biologic treatments was evident in the important QALY differences reported, compared with BSC alone. In contrast, differences between the alternative biologic therapies were much less significant and in some instances may not be clinically meaningful. Hence, there remains considerable uncertainty in relation to defining an optimal treatment or pathway of care. Indeed, the PSA demonstrates considerable decision uncertainty regarding the optimal treatment, at both £20,000 and £30,000 thresholds.

Chapter 9 Conclusions

Although the NMAs were based on data from high-quality randomised trials, heterogeneity across trials meant that the analyses had to be performed in biologic-naïve and biologic-experienced subpopulations separately, and also needed to include models which adjusted for the different rates of placebo response evident across trials. The NMA results for the biologic-naïve subpopulation indicated that, although SEC and CZP were effective across all outcomes after 3 months' therapy, their relative effectiveness compared with ETN, ADA, GOL and INF and with each other was uncertain (the rankings of treatment varied with outcome and analysis). However, both agents did seem consistently more effective than APR. The results also indicated that SEC and INF were the most effective in terms of treating psoriasis (PASI response). Only SEC and UST could be included in the analyses of the biologic-experienced subpopulation. The results showed that, across all outcomes analysed, both SEC and UST were significantly more effective than placebo. Most of the results suggested that SEC may be better than UST. However, the patient numbers in this subpopulation were quite low; the results were therefore uncertain (with wide overlapping CrIs).

The results from open-label trial extension studies which radiographically assessed joint damage suggest that both CZP and SEC effectively reduce disease progression. Published systematic reviews of AEs have suggested CZP is associated with statistically significantly more SAEs and serious infections than placebo. Although the safety data for SEC appear promising, the fairly small number of trials for which data are currently available means that there is still some uncertainty regarding its safety.

Economic modelling found that these new biologics can be considered a cost-effective use of NHS resources when compared with the other therapies currently recommended by NICE for treating PsA. Which treatment is most cost-effective depends on which previous treatments a patient has tried and not responded to, the severity of the psoriasis symptoms, and the price of the treatment. Some of the study's results were somewhat limited because not enough relevant clinical trial data were available.

Implications for service provision

- The clinical evidence indicates that SEC and CZP are only two of a number of effective treatments for the treatment of active PsA.
- For patients with PsA and significant psoriasis, SEC may be one of the more effective biologic treatments.
- The limited long-term evidence suggests some beneficial impact of radiographic disease progression.

Suggested research priorities

- Adequately powered randomised trials are needed to inform the clinical effectiveness of biologics in biologic-experienced populations.
- Future trials should consider using newer composite disease outcome measures which have recently been developed for PsA, such as the Composite Psoriatic arthritis Disease Activity Index, the PsA disease activity score, the Disease Activity index for PSoriatic Arthritis (DAPSA) and minimal disease activity.
- Further research is required to better elucidate the impact of biologics on radiographic disease progression and HAQ-DI score in the long term. This requires the use of real-world data.
- With the continuing introduction of new biologic drugs and continued collection of data through biologic registries, further analysis of the data to investigate patterns of drug switching and the long-term effectiveness and safety of biologics is warranted. Radiographic outcomes should be evaluated given the significance of radiographic damage as a measure of disease progression and treatment effects.

- Although randomised head-to-head trials – which directly compare different biologics – would yield very useful results, their design and recruitment strategies may require very careful thought. Different biologics are administered at different rates and time points; therefore, to achieve adequate blinding, patients would need both their randomised treatment injections and placebo injections corresponding to the comparator biologic regimen (i.e. patients would receive many more injections than would be needed if they took a biologic outside a trial). When considering this, together with the known benefits of biologics, and the likely large trial population that would be needed to detect efficacy differences between different biologics, consideration of trial recruitment and compliance issues should be key when conducting pilot studies. INF is delivered intravenously so would be even more difficult to study in a head-to-head blinded trial.
- Larger-scale, longer-term studies are required to determine the HRQoL impact of response to treatment and changes in functional capacity (measured using HAQ-DI) and psoriasis (measured using PASI). These should include the full range of PsA severities.
- Larger-scale studies are required to determine the cost implications of response to treatment and changes in functional capacity (measured using HAQ-DI) and psoriasis (measured using PASI). These should be undertaken in a PsA population and include the full range of PsA severities.

Acknowledgements

This study, carried out under YODA project #2016-0897, used data obtained from the YODA project, which has an agreement with Janssen Research & Development, LLC. The interpretation and reporting of research using this data are solely the responsibility of the authors and does not necessarily represent the official views of the YODA project or Janssen Research & Development, LLC.

We would like to thank Dr Sofia Dias, Research Fellow, School of Social & Community Medicine, University of Bristol, for advice on the evidence synthesis models.

Contributions of authors

Mark Corbett, Research Fellow and Systematic Reviewer, contributed to the protocol, study selection, data extraction, validity assessments and synthesis of the included studies. He also contributed to the interpretation of the results and the writing of the report.

Fadi Chehadah, Research Fellow and Health Economist, contributed to the protocol, the development of the economic model, the review of economic analyses, the interpretation of the results and the writing of the report.

Mousumi Biswas, Research Fellow in Health Economics, contributed to developing the synthesis models and undertook the evidence synthesis. She also contributed to the interpretation of the results and the writing of the report.

Thirimon Moe-Byrne, Research Fellow and Systematic Reviewer, contributed to the protocol, study selection, data extraction, and validity assessment of the included studies and the writing of the report.

Stephen Palmer, Professor of Health Economics, contributed to the protocol development and to all aspects of the cost-effectiveness work including the writing of the report.

Marta Soares, Senior Research Fellow in Health Economics and Statistician, contributed to developing the synthesis models and the writing of the report.

Matthew Walton, Research Training Fellow in Systematic Reviews, performed and wrote the sections of the report relating to the reviews of patient registry studies and natural history studies.

Melissa Harden, Information Specialist, contributed to the protocol development, developed the search strategies, conducted a range of searches to locate studies, and wrote the sections of the report relating to the literature searches.

Pauline Ho, Consultant Rheumatologist, provided expert clinical advice, contributed to the protocol and interpretation of the results and commented on drafts of the report.

Nerys Woolcott, Reader in Health Technology Assessment, contributed to the protocol, study selection and synthesis of the included studies. She also contributed to the interpretation of the results and the writing of the report, and took overall responsibility for the clinical effectiveness section.

Laura Bojke, Senior Research Fellow in Health Economics, had overall responsibility for the cost-effectiveness sections. She contributed to the development of the protocol, the economic model and the economic analyses. She also contributed to the interpretation of the results and the writing of the report.

Data sharing statement

Requests for access to data should be addressed to the corresponding author.

References

1. Reveille JD. *Spondyloarthritis*. American College of Rheumatology; 2013. URL: www.rheumatology.org/I-Am-A/Patient-Caregiver/Diseases-Conditions/Spondyloarthritis (accessed 28 July 2016).
2. Arthritis Foundation. *What is Psoriatic Arthritis?* Arthritis Foundation National Office. URL: www.arthritis.org/about-arthritis/types/psoriatic-arthritis/what-is-psoriatic-arthritis.php (accessed 7 July 2016).
3. Emery P, Ash Z. *Psoriatic Arthritis*. American College of Rheumatology; 2013. URL: www.rheumatology.org/I-Am-A/Patient-Caregiver/Diseases-Conditions/Psoriatic-Arthritis (accessed 28 July 2016).
4. Shiel WC. *Psoriatic Arthritis*. MedicineNet.com; 2015. URL: www.medicinenet.com/psoriatic_arthritis/article.htm (accessed 25 November 2015).
5. Gladman DD, Shuckett R, Russell ML, Thorne JC, Schachter RK. Psoriatic arthritis (PSA) – an analysis of 220 patients. *Q J Med* 1987;**62**:127–41.
6. Torre Alonso JC, Rodriguez Perez A, Arribas Castrillo JM, Ballina Garcia J, Riestra Noriega JL, Lopez Larrea C. Psoriatic arthritis (PA): a clinical, immunological and radiological study of 180 patients. *Br J Rheumatol* 1991;**30**:245–50. <https://doi.org/10.1093/rheumatology/30.4.245>
7. Galadari H, Fuchs B, Lebwohl M. Newly available treatments for psoriatic arthritis and their impact on skin psoriasis. *Int J Dermatol* 2003;**42**:231–7. <https://doi.org/10.1046/j.1365-4362.2003.01449.x>
8. Ruderman EM. Evaluation and management of psoriatic arthritis: the role of biologic therapy. *J Am Acad Dermatol* 2003;**49**(Suppl. 2):125–32. [https://doi.org/10.1016/S0190-9622\(03\)01145-9](https://doi.org/10.1016/S0190-9622(03)01145-9)
9. Michelsen B, Fiane R, Diamantopoulos AP, Soldal DM, Hansen IJ, Sokka T, *et al*. A comparison of disease burden in rheumatoid arthritis, psoriatic arthritis and axial spondyloarthritis. *PLOS ONE* 2015;**10**:e0123582. <https://doi.org/10.1371/journal.pone.0123582>
10. Kavanaugh A, Mease PJ, Purcaru O, van der Heijde D. High economic burden of moderate to severe psoriatic arthritis on paid work and household productivity: baseline results from the RAPID-PsA study (poster SAT0275). *Ann Rheum Dis* 2013;**72**(Suppl. 3):676. <https://doi.org/10.1136/annrheumdis-2013-eular.2000>
11. Mease P, Goffe BS. Diagnosis and treatment of psoriatic arthritis. *J Am Acad Dermatol* 2005;**52**:1–19. <https://doi.org/10.1016/j.jaad.2004.06.013>
12. Wong K, Gladman DD, Husted J, Long JA, Farewell VT. Mortality studies in psoriatic arthritis: results from a single outpatient clinic. I. Causes and risk of death. *Arthritis Rheum* 1997;**40**:1868–72. [https://doi.org/10.1002/1529-0131\(199710\)40:10<1868::AID-ART21>3.0.CO;2-W](https://doi.org/10.1002/1529-0131(199710)40:10<1868::AID-ART21>3.0.CO;2-W)
13. Gladman DD, Farewell VT, Wong K, Husted J. Mortality studies in psoriatic arthritis: results from a single outpatient center. II. Prognostic indicators for death. *Arthritis Rheum* 1998;**41**:1103–10. [https://doi.org/10.1002/1529-0131\(199806\)41:6<1103::AID-ART18>3.0.CO;2-N](https://doi.org/10.1002/1529-0131(199806)41:6<1103::AID-ART18>3.0.CO;2-N)
14. Ali Y, Tom BD, Schentag CT, Farewell VT, Gladman DD. Improved survival in psoriatic arthritis with calendar time. *Arthritis Rheum* 2007;**56**:2708–14. <https://doi.org/10.1002/art.22800>
15. Helliwell PS, Taylor WJ. Classification and diagnostic criteria for psoriatic arthritis. *Ann Rheum Dis* 2005;**64**(Suppl. 2):ii3–8. <https://doi.org/10.1136/ard.2004.032318>
16. Moll JM, Wright V. Psoriatic arthritis. *Semin Arthritis Rheum* 1973;**3**:55–78. [https://doi.org/10.1016/0049-0172\(73\)90035-8](https://doi.org/10.1016/0049-0172(73)90035-8)

17. Taylor W, Gladman D, Helliwell P, Marchesoni A, Mease P, Mielants H, *et al.* Classification criteria for psoriatic arthritis: development of new criteria from a large international study. *Arthritis Rheum* 2006;**54**:2665–73. <https://doi.org/10.1002/art.21972>
18. Gladman DD, Antoni C, Mease P, Clegg DO, Nash P. Psoriatic arthritis: epidemiology, clinical features, course, and outcome. *Ann Rheum Dis* 2005;**64**(Suppl. 2):ii14–7. <https://doi.org/10.1136/ard.2004.032482>
19. Salisbury NHS Foundation Trust. *Referral Pathway for Psoriatic Arthritis*. Salisbury NHS Foundation Trust. URL: www.icid.salisbury.nhs.uk/ClinicalManagement/Rheumatology/Pages/PsA.aspx (accessed 7 July 2016).
20. Bowcock AM. Understanding the pathogenesis of psoriasis, psoriatic arthritis, and autoimmunity via a fusion of molecular genetics and immunology. *Immunol Res* 2005;**32**:45–56. <https://doi.org/10.1385/IR:32:1-3:045>
21. Leung YY, Tam LS, Kun EW, Li EK. Psoriatic arthritis as a distinct disease entity. *J Postgrad Med* 2007;**53**:63–71. <https://doi.org/10.4103/0022-3859.30334>
22. Ritchlin CT, Qureshi AA, de Vlam K, Pitzalis C, Helliwell PS, Mease PJ, *et al.* Biomarkers in psoriasis and psoriatic arthritis: GRAPPA 2008. *J Rheumatol* 2010;**37**:462–7. <https://doi.org/10.3899/jrheum.090957>
23. GRAPPA. *Group for Research and Assessment of Psoriasis and Psoriatic Arthritis (GRAPPA)*. GRAPPA; 2016. URL: www.grappanetwork.org/ (accessed 12 July 2016).
24. Felson DT, Anderson JJ, Boers M, Bombardier C, Furst D, Goldsmith C, *et al.* American College of Rheumatology. Preliminary definition of improvement in rheumatoid arthritis. *Arthritis Rheum* 1995;**38**:727–35. <https://doi.org/10.1002/art.1780380602>
25. Mease PJ, Antoni CE, Gladman DD, Taylor WJ. Psoriatic arthritis assessment tools in clinical trials. *Ann Rheum Dis* 2005;**64**(Suppl. 2):ii49–54. <https://doi.org/10.1136/ard.2004.034165>
26. Wong PC, Leung YY, Li EK, Tam LS. Measuring disease activity in psoriatic arthritis. *Int J Rheumatol* 2012;**2012**:839425. <https://doi.org/10.1155/2012/839425>
27. Chang CA, Gottlieb AB, Lizzul PF. *Management of Psoriatic Arthritis from the View of the Dermatologist: Assessment of PsA*. Medscape; 2011. URL: www.medscape.org/viewarticle/749147_2 (accessed 6 July 2016).
28. Kavanaugh A, Cassell S. The assessment of disease activity and outcomes in psoriatic arthritis. *Clin Exp Rheumatol* 2005;**23**(Suppl. 5):142–7.
29. Gossec L, Smolen JS, Ramiro S, de Wit M, Cutolo M, Dougados M, *et al.* European League Against Rheumatism (EULAR) recommendations for the management of psoriatic arthritis with pharmacological therapies: 2015 update. *Ann Rheum Dis* 2016;**75**:499–510. <https://doi.org/10.1136/annrheumdis-2015-208337>
30. Mease PJ. Psoriatic arthritis: update on pathophysiology, assessment and management. *Ann Rheum Dis* 2011;**70**(Suppl. 1):i77–84. <https://doi.org/10.1136/ard.2010.140582>
31. Coates LC, Tillett W, Chandler D, Helliwell PS, Korendowych E, Kyle S, *et al.* The 2012 BSR and BHPR guideline for the treatment of psoriatic arthritis with biologics. *Rheumatology* 2013;**52**:1754–7. <https://doi.org/10.1093/rheumatology/ket187>
32. Haberhauer G, Strehblow C, Fasching P. Observational study of switching anti-TNF agents in ankylosing spondylitis and psoriatic arthritis versus rheumatoid arthritis. *Wien Med Wochenschr* 2010;**160**:220–4. <https://doi.org/10.1007/s10354-010-0795-0>

33. Rodgers M, Epstein D, Bojke L, Yang H, Craig D, Fonseca T, *et al.* Etanercept, infliximab and adalimumab for the treatment of psoriatic arthritis: a systematic review and economic evaluation. *Health Technol Assess* 2011;**15**(10). <https://doi.org/10.3310/hta15100>
34. Yang H, Craig D, Epstein D, Bojke L, Light K, Bruce IN, *et al.* Golimumab for the treatment of psoriatic arthritis: a NICE single technology appraisal. *PharmacoEconomics* 2012;**30**:257–70. <https://doi.org/10.2165/11595920-000000000-00000>
35. O'Connor J, Rice S, Smith A, Rodgers M, Lopez RR, Craig D, *et al.* The clinical and cost effectiveness of ustekinumab for the treatment of psoriatic arthritis: a critique of the evidence. *PharmacoEconomics* 2016;**34**:337. <https://doi.org/10.1007/s40273-015-0350-3>
36. Cawson MR, Mitchell SA, Knight C, Wildey H, Spurden D, Bird A, *et al.* Systematic review, network meta-analysis and economic evaluation of biological therapy for the management of active psoriatic arthritis. *BMC Musculoskelet Disord* 2014;**15**:26. <https://doi.org/10.1186/1471-2474-15-26>
37. Ungprasert P, Thongprayoon C, Davis JM. Indirect comparisons of the efficacy of biological agents in patients with psoriatic arthritis with an inadequate response to traditional disease-modifying anti-rheumatic drugs or to non-steroidal anti-inflammatory drugs: a meta-analysis. *Semin Arthritis Rheum* 2016;**45**:428–38. <https://doi.org/10.1016/j.semarthrit.2015.09.004>
38. Migliore A, Bizzi E, Broccoli S, Lagana B. Indirect comparison of etanercept, infliximab, and adalimumab for psoriatic arthritis: mixed treatment comparison using placebo as common comparator. *Clin Rheumatol* 2012;**31**:133–7. <https://doi.org/10.1007/s10067-011-1790-6>
39. Ramiro S, Smolen JS, Landewe R, van der Heijde D, Dougados M, Emery P, *et al.* Pharmacological treatment of psoriatic arthritis: a systematic literature review for the 2015 update of the EULAR recommendations for the management of psoriatic arthritis. *Ann Rheum Dis* 2016;**75**:490–8. <https://doi.org/10.1136/annrheumdis-2015-208466>
40. Corbett MS, Higgins JP, Woolacott NF. Assessing baseline imbalance in randomised trials: implications for the Cochrane risk of bias tool. *Res Synth Methods* 2014;**5**:79–85. <https://doi.org/10.1002/jrsm.1090>
41. Maneiro JR, Souto A, Salgado E, Mera A, Gomez-Reino JJ. Predictors of response to TNF antagonists in patients with ankylosing spondylitis and psoriatic arthritis: systematic review and meta-analysis. *RMD Open* 2015;**1**:e000017. <https://doi.org/10.1136/rmdopen-2014-000017>
42. Sterry W, Ortonne JP, Kirkham B, Brocq O, Robertson D, Pedersen RD, *et al.* Comparison of two etanercept regimens for treatment of psoriasis and psoriatic arthritis: PRESTA randomised double blind multicentre trial. *BMJ* 2010;**340**:c147. <https://doi.org/10.1136/bmj.c147>
43. Schett G, Wollenhaupt J, Papp K, Joos R, Rodrigues JF, Vessey AR, *et al.* Oral apremilast in the treatment of active psoriatic arthritis: results of a multicenter, randomized, double-blind, placebo-controlled study. *Arthritis Rheum* 2012;**64**:3156–67. <https://doi.org/10.1002/art.34627>
44. Torii H, Nakagawa H, Japanese Infliximab Study investigators. Infliximab monotherapy in Japanese patients with moderate-to-severe plaque psoriasis and psoriatic arthritis. A randomized, double-blind, placebo-controlled multicenter trial. *J Dermatol Sci* 2010;**59**:40–9. <https://doi.org/10.1016/j.jdermsci.2010.04.014>
45. Baranauskaite A, Raffayová H, Kungurov NV, Kubanova A, Venalis A, Helmle L, *et al.* Infliximab plus methotrexate is superior to methotrexate alone in the treatment of psoriatic arthritis in methotrexate-naive patients: the RESPOND study. *Ann Rheum Dis* 2012;**71**:541–8. <https://doi.org/10.1136/ard.2011.152223>

46. Mease PJ, McInnes IB, Kirkham B, Kavanaugh A, Rahman P, van der Heijde D, *et al.* Secukinumab inhibition of interleukin-17A in patients with psoriatic arthritis. *N Engl J Med* 2015;**373**:1329–39. <https://doi.org/10.1056/NEJMoa1412679>
47. Mease PJ, Fleischmann R, Deodhar AA, Wollenhaupt J, Khraishi M, Kielar D, *et al.* Effect of certolizumab pegol on signs and symptoms in patients with psoriatic arthritis: 24-week results of a phase 3 double-blind randomised placebo-controlled study (RAPID-PsA). *Ann Rheum Dis* 2014;**73**:48–55. <https://doi.org/10.1136/annrheumdis-2013-203696>
48. McInnes IB, Mease PJ, Kirkham B, Kavanaugh A, Ritchlin CT, Rahman P, *et al.* Secukinumab, a human anti-interleukin-17A monoclonal antibody, in patients with psoriatic arthritis (FUTURE 2): a randomised, double-blind, placebo-controlled, phase 3 trial. *Lancet* 2015;**386**:1137–46. [https://doi.org/10.1016/S0140-6736\(15\)61134-5](https://doi.org/10.1016/S0140-6736(15)61134-5)
49. Gottlieb AB, Langley RG, Philipp S, Sigurgeirsson B, Blauvelt A, Martin R, *et al.* Secukinumab improves physical function in subjects with plaque psoriasis and psoriatic arthritis: results from two randomized, phase 3 trials. *J Drugs Dermatol* 2015;**14**:821–33.
50. Kavanaugh A, McInnes I, Mease P, Krueger GG, Gladman D, Gomez-Reino J, *et al.* Golimumab, a new human tumor necrosis factor alpha antibody, administered every four weeks as a subcutaneous injection in psoriatic arthritis: twenty-four-week efficacy and safety results of a randomized, placebo-controlled study. *Arthritis Rheum* 2009;**60**:976–86. <https://doi.org/10.1002/art.24403>
51. Antoni CE, Kavanaugh A, Kirkham B, Tutuncu Z, Burmester GR, Schneider U, *et al.* Sustained benefits of infliximab therapy for dermatologic and articular manifestations of psoriatic arthritis: results from the infliximab multinational psoriatic arthritis controlled trial (IMPACT). *Arthritis Rheum* 2005;**52**:1227–36. <https://doi.org/10.1002/art.20967>
52. Antoni C, Krueger GG, de Vlam K, Birbara C, Beutler A, Guzzo C, *et al.* Infliximab improves signs and symptoms of psoriatic arthritis: results of the IMPACT 2 trial. *Ann Rheum Dis* 2005;**64**:1150–7. <https://doi.org/10.1136/ard.2004.032268>
53. Mease PJ, Goffe BS, Metz J, VanderStoep A, Finck B, Burge DJ. Etanercept in the treatment of psoriatic arthritis and psoriasis: a randomised trial. *Lancet* 2000;**356**:385–90. [https://doi.org/10.1016/S0140-6736\(00\)02530-7](https://doi.org/10.1016/S0140-6736(00)02530-7)
54. Mease PJ, Kivitz AJ, Burch FX, Siegel EL, Cohen SB, Ory P, *et al.* Etanercept treatment of psoriatic arthritis: safety, efficacy, and effect on disease progression. *Arthritis Rheum* 2004;**50**:2264–72. <https://doi.org/10.1002/art.20335>
55. Mease PJ, Gladman DD, Ritchlin CT, Ruderman EM, Steinfeld SD, Choy EH, *et al.* Adalimumab for the treatment of patients with moderately to severely active psoriatic arthritis: results of a double-blind, randomized, placebo-controlled trial. *Arthritis Rheum* 2005;**52**:3279–89. <https://doi.org/10.1002/art.21306>
56. Genovese MC, Mease PJ, Thomson GT, Kivitz AJ, Perdok RJ, Weinberg MA, *et al.* Safety and efficacy of adalimumab in treatment of patients with psoriatic arthritis who had failed disease modifying antirheumatic drug therapy. *J Rheumatol* 2007;**34**:1040–50.
57. Mease PJ, van der Heijde D, Ritchlin CT, Cuchacovich R, Shuler CL, Lee CH, *et al.* A randomized, double-blind, active-and placebo-controlled phase 3 study of efficacy and safety of ixekizumab, adalimumab, and placebo therapy in patients naive to biologic disease modifying anti-rheumatic drugs with active psoriatic arthritis. *Arthritis Rheumatol* 2015;**67**(Suppl. 10):977.
58. McInnes IB, Kavanaugh A, Gottlieb AB, Puig L, Rahman P, Ritchlin C, *et al.* Efficacy and safety of ustekinumab in patients with active psoriatic arthritis: 1 year results of the phase 3, multicentre, double-blind, placebo-controlled PSUMMIT 1 trial. *Lancet* 2013;**382**:780–9. [https://doi.org/10.1016/S0140-6736\(13\)60594-2](https://doi.org/10.1016/S0140-6736(13)60594-2)

59. Ritchlin C, Rahman P, Kavanaugh A, McInnes IB, Puig L, Li S, *et al.* Efficacy and safety of the anti-IL-12/23 p40 monoclonal antibody, ustekinumab, in patients with active psoriatic arthritis despite conventional non-biological and biological anti-tumour necrosis factor therapy: 6-month and 1-year results of the phase 3, multicentre, double-blind, placebo-controlled, randomised PSUMMIT 2 trial. *Ann Rheum Dis* 2014;**73**:990–9. <https://doi.org/10.1136/annrheumdis-2013-204655>
60. Kavanaugh A, Mease PJ, Gomez-Reino JJ, Adebajo AO, Wollenhaupt J, Gladman DD, *et al.* Treatment of psoriatic arthritis in a phase 3 randomised, placebo-controlled trial with apremilast, an oral phosphodiesterase 4 inhibitor. *Ann Rheum Dis* 2014;**73**:1020–6. <https://doi.org/10.1136/annrheumdis-2013-205056>
61. National Institute for Health and Care Excellence (NICE). *Psoriatic Arthritis (Active) – Apremilast (Post DMARDs) [ID682]: Committee Papers*. NICE; 2015. URL: www.nice.org.uk/guidance/TA372/documents/psoriatic-arthritis-active-apremilast-post-dmards-id682-committee-papers-2 (accessed 19 May 2016).
62. Gottlieb AB, Thaci D, Blauvelt A, Milutinovic M, Mpfu S. Secukinumab improves skin symptoms and physical functioning compared with ustekinumab in patients with moderate to severe psoriasis with concomitant psoriatic arthritis: subanalysis of a randomized, double blind, parallel-group, active comparator-controlled phase 3b trial. *Arthritis Rheumatol* 2015;**67**(Suppl. 10):2853.
63. Thaci D, Blauvelt A, Reich K, Tsai TF, Vanaclocha F, Kingo K, *et al.* Secukinumab is superior to ustekinumab in clearing skin of subjects with moderate to severe plaque psoriasis: CLEAR, a randomized controlled trial. *J Am Acad Dermatol* 2015;**73**:400–9. <https://doi.org/10.1016/j.jaad.2015.05.013>
64. Atteno M, Peluso R, Costa L, Padula S, Iervolino S, Caso F, *et al.* Comparison of effectiveness and safety of infliximab, etanercept, and adalimumab in psoriatic arthritis patients who experienced an inadequate response to previous disease-modifying antirheumatic drugs. *Clin Rheumatol* 2010;**29**:399–403. <https://doi.org/10.1007/s10067-009-1340-7>
65. Corbett M, Sideris E, Palmer S, Harden M, Woolacott N, Bojke L. *Evidence Review Group's Report: Apremilast for Treating Active Psoriatic Arthritis*. Southampton: National Institute for Health Research; 2015.
66. Craig D, O'Connor J, Rodgers M, Rodriguez-Lopez R, Smith A, Woolacott N. *Evidence Review Group's Report: Ustekinumab for Treating Active and Progressive Psoriatic Arthritis*. Southampton: National Institute for Health Research; 2013. URL: www.journalslibrary.nihr.ac.uk/programmes/hta/125801/#/ (accessed 19 May 2017).
67. Gottlieb AB, Mease PJ, Cuchacovich RS, Shuler CL, Lin CY, Burge RT, *et al.* Ixekizumab improves physical function, quality of life, and work productivity in biologic disease-modifying antirheumatic drug-naïve patients with active psoriatic arthritis. *Arthritis Rheumatol*. 2015;**67**(Suppl. 10):2145.
68. Gottlieb AB, Sigurgeirsson B, Blauvelt A, Mpfu S, Martin R, Papavassilis C. Secukinumab shows substantial improvement in both psoriasis symptoms and physical functioning in moderate-to-severe plaque psoriasis patients with psoriatic arthritis: a subanalysis of a phase 3, multicenter, double-blind, placebo-controlled study. *Arthritis Rheum* 2013;**65**:S136–7.
69. European Medicines Agency. *Assessment Report: Otezla*. London: European Medicines Agency; 2014.
70. Yang H, Epstein D, Bojke L, Craig D, Light K, Bruce I, *et al.* *Evidence Review Group's Report: Golimumab for the Treatment of Psoriatic Arthritis*. Southampton: National Institute for Health Research; 2010. URL: www.journalslibrary.nihr.ac.uk/programmes/hta/0912001/#/ (accessed 19 May 2017).
71. Novartis Pharmaceuticals. *24 Week Efficacy and 3-Year Safety and Efficacy of Secukinumab in Active Psoriatic Arthritis*. ClinicalTrials.gov; 2013. URL: <https://ClinicalTrials.gov/show/NCT01989468> (accessed 7 December 2015).

72. Novartis Pharmaceuticals. *Efficacy at 24 Weeks with Long Term Safety, Tolerability and Efficacy up to 5 years of Secukinumab in Patients of Active Psoriatic Arthritis*. ClinicalTrials.gov; 2012. URL: <https://ClinicalTrials.gov/show/NCT01752634> (accessed 7 December 2015).
73. Novartis Pharmaceuticals. *Study to Demonstrate the Efficacy (Including Inhibition of Structural Damage), Safety and Tolerability up to 2 years of Secukinumab in Active Psoriatic Arthritis*. ClinicalTrials.gov; 2015. URL: <https://ClinicalTrials.gov/show/NCT02404350> (accessed 7 December 2016).
74. Mease P, Deodhar A, Fleischmann R, Wollenhaupt J, Gladman D, Leszczyński P, *et al*. Effect of certolizumab pegol over 96 weeks in patients with psoriatic arthritis with and without prior antitumour necrosis factor exposure. *RMD Open* 2015;**1**:e000119. <https://doi.org/10.1136/rmdopen-2015-000119>
75. Kavanaugh A, McInnes IB, Mease P, Krueger GG, Gladman D, van der Heijde D, *et al*. Clinical efficacy, radiographic and safety findings through 5 years of subcutaneous golimumab treatment in patients with active psoriatic arthritis: results from a long-term extension of a randomised, placebo-controlled trial (the GO-REVEAL study). *Ann Rheum Dis* 2014;**73**:1689–94. <https://doi.org/10.1136/annrheumdis-2013-204902>
76. Krueger GG. Effects of golimumab on the dermatologic manifestations of psoriatic arthritis: 5-year results from the long-term extension of the randomized, placebo-controlled, GO-REVEAL study. *J Am Acad Dermatol* 2013;**68**(Suppl. 1):AB199.
77. Mease PJ, Kivitz AJ, Burch FX, Siegel EL, Cohen SB, Ory P, *et al*. Continued inhibition of radiographic progression in patients with psoriatic arthritis following 2 years of treatment with etanercept. *J Rheumatol* 2006;**33**:712–21.
78. Mease PJ, Ory P, Sharp JT, Ritchlin CT, Van den Bosch F, Wellborne F, *et al*. Adalimumab for long-term treatment of psoriatic arthritis: 2-year data from the Adalimumab Effectiveness in Psoriatic Arthritis Trial (ADEPT). *Ann Rheum Dis* 2009;**68**:702–9. <https://doi.org/10.1136/ard.2008.092767>
79. Antoni CE, Kavanaugh A, van der Heijde D, Beutler A, Keenan G, Zhou B, *et al*. Two-year efficacy and safety of infliximab treatment in patients with active psoriatic arthritis: findings of the Infliximab Multinational Psoriatic Arthritis Controlled Trial (IMPACT). *J Rheumatol* 2008;**35**:869–76.
80. Kavanaugh A, Puig L, Gottlieb AB, Ritchlin C, Li S, Wang Y, *et al*. Maintenance of clinical efficacy and radiographic benefit through 2 years of ustekinumab therapy in patients with active psoriatic arthritis: results from a randomized, placebo-controlled phase III trial. *Arthritis Care Res* 2015;**67**:1739–49. <https://doi.org/10.1002/acr.22645>
81. Kavanaugh A, Puig L, Gottlieb A, Ritchlin C, Li S, Wang Y, *et al*. Efficacy and safety of ustekinumab in patients with active psoriatic arthritis: 2-year results from a phase 3, multicenter, double-blind, placebo-controlled study. *Ann Rheum Dis* 2014;**73**(Suppl. 2):737–8. <https://doi.org/10.1136/annrheumdis-2014-eular.2283>
82. Bird P, Adebajo A, Gladman D, Kavanaugh A, Mease P, Gomez-Reino J, *et al*. Long-term (104-week) efficacy and safety profile of apremilast, an oral phosphodiesterase 4 inhibitor, in patients with psoriatic arthritis: results from a phase III, randomized, controlled trial and open-label extension (PALACE 1). *Intern Med J* 2015;**45**(Suppl. 2):39–40.
83. Saad AA, Ashcroft DM, Watson KD, Hyrich KL, Noyce PR, Symmons DPM, *et al*. Persistence with anti-tumour necrosis factor therapies in patients with psoriatic arthritis: observational study from the British Society of Rheumatology Biologics Register. *Arthritis Res Ther* 2009;**11**:R52. <https://doi.org/10.1186/ar2670>

84. Fagerli K, Watson K, Packham J, Symmons D, Hyrich K. Predicting successful long-term treatment with tumour necrosis factor- α inhibitors in patients with psoriatic arthritis. *Arthritis Rheumatol* 2014;**66**:S679–S80.
85. Kristensen LE, Gulfe A, Saxne T, Geborek P. Efficacy and tolerability of anti-tumour necrosis factor therapy in psoriatic arthritis patients: results from the South Swedish Arthritis Treatment Group register. *Ann Rheum Dis* 2008;**67**:364–9. <https://doi.org/10.1136/ard.2007.073544>
86. Simard JF, Arkema EV, Sundström A, Geborek P, Saxne T, Baecklund E, *et al.* Ten years with biologics: to whom do data on effectiveness and safety apply? *Rheumatology* 2011;**50**:204–13. <https://doi.org/10.1093/rheumatology/keq326>
87. Mease PJ, Collier DH, Saunders KC, Li G, Kremer JM, Greenberg JD. Comparative effectiveness of biologic monotherapy versus combination therapy for patients with psoriatic arthritis: results from the Corrona registry. *RMD Open* 2015;**1**:e000181. <https://doi.org/10.1136/rmdopen-2015-000181>
88. Glintborg B, Østergaard M, Dreyer L, Krogh NS, Tarp U, Hansen MS, *et al.* Treatment response, drug survival, and predictors thereof in 764 patients with psoriatic arthritis treated with anti-tumor necrosis factor α therapy: results from the nationwide Danish DANBIO registry. *Arthritis Rheum* 2011;**63**:382–90. <https://doi.org/10.1002/art.30117>
89. Chen JS, Makovey J, Lassere M, Buchbinder R, March LM. Comparative effectiveness of anti-tumor necrosis factor drugs on health-related quality of life among patients with inflammatory arthritis. *Arthritis Care Res* 2014;**66**:464–72. <https://doi.org/10.1002/acr.22151>
90. Fagerli KM, Lie E, van der Heijde D, Heiberg MS, Lexberg AS, Rødevand E, *et al.* The role of methotrexate co-medication in TNF-inhibitor treatment in patients with psoriatic arthritis: results from 440 patients included in the NOR-DMARD study. *Ann Rheum Dis* 2014;**73**:132–7. <https://doi.org/10.1136/annrheumdis-2012-202347>
91. Carmona L, Gomez-Reino J, BIOBADASER group. Survival of TNF antagonists in spondyloarthritis is better than in rheumatoid arthritis. Data from the Spanish registry BIOBADASER. *Arthritis Res Ther* 2006;**8**:R72. <https://doi.org/10.1186/ar1941>
92. Glintborg B, Gudbjornsson B, Krogh NS, Omerovic E, Manilo N, Holland-Fischer M, *et al.* Impact of different infliximab dose regimens on treatment response and drug survival in 462 patients with psoriatic arthritis: results from the nationwide registries DANBIO and ICEBIO. *Rheumatology* 2014;**53**:2100–9. <https://doi.org/10.1093/rheumatology/keu252>
93. Iannone F, Lopriore S, Bucci R, Scioscia C, Anelli MG, Notarnicola A, *et al.* Two-year survival rates of anti-TNF- α therapy in psoriatic arthritis (PsA) patients with either polyarticular or oligoarticular PsA. *Scand J Rheumatol* 2015;**44**:192–9. <https://doi.org/10.3109/03009742.2014.962081>
94. Glintborg B, Ostergaard M, Krogh NS, Andersen MD, Tarp U, Loft AG, *et al.* Clinical response, drug survival, and predictors thereof among 548 patients with psoriatic arthritis who switched tumor necrosis factor inhibitor therapy: results from the Danish nationwide DANBIO registry. *Arthritis Rheum* 2013;**65**:1213–23. <https://doi.org/10.1002/art.37876>
95. Fagerli KM, Lie E, van der Heijde D, Heiberg MS, Kalstad S, Rødevand E, *et al.* Switching between TNF inhibitors in psoriatic arthritis: data from the NOR-DMARD study. *Ann Rheum Dis* 2013;**72**:1840–4. <https://doi.org/10.1136/annrheumdis-2012-203018>
96. Eder L, Thavaneswaran A, Chandran V, Gladman DD. Tumour necrosis factor α blockers are more effective than methotrexate in the inhibition of radiographic joint damage progression among patients with psoriatic arthritis. *Ann Rheum Dis* 2014;**73**:1007–11. <https://doi.org/10.1136/annrheumdis-2012-202959>

97. Saad AA, Ashcroft DM, Watson KD, Symmons DPM, Noyce PR, Hyrich KL, *et al.* Improvements in quality of life and functional status in patients with psoriatic arthritis receiving anti-tumor necrosis factor therapies. *Arthritis Care Res* 2010;**62**:345–53. <https://doi.org/10.1002/acr.20104>
98. Husted JA, Tom BD, Farewell VT, Schentag CT, Gladman DD. Description and prediction of physical functional disability in psoriatic arthritis: a longitudinal analysis using a Markov model approach. *Arthritis Rheum* 2005;**53**:404–9. <https://doi.org/10.1002/art.21177>
99. Kane D, Stafford L, Bresnihan B, Fitzgerald O. A prospective, clinical and radiological study of early psoriatic arthritis: an early synovitis clinic experience. *Rheumatology* 2003;**42**:1460–8. <https://doi.org/10.1093/rheumatology/keg384>
100. Morgan C, Lunt M, Bunn D, Scott DG, Symmons DP. Five-year outcome of a primary-care-based inception cohort of patients with inflammatory polyarthritis plus psoriasis. *Rheumatology* 2007;**46**:1819–23. <https://doi.org/10.1093/rheumatology/kem270>
101. Mease PJ, McInnes IB, Gottlieb AB, Widmer A, Pricop L, Mpofo S. Secukinumab safety and tolerability in patients with active psoriatic arthritis and psoriasis: results from a pooled safety analysis. *Arthritis Rheumatol* 2015;**67**(Suppl. S10):2886.
102. Singh JA, Wells GA, Christensen R, Tanjong Ghogomu E, Maxwell L, Macdonald JK, *et al.* Adverse effects of biologics: a network meta-analysis and Cochrane overview. *Cochrane Database Syst Rev* 2011;**2**:CD008794. <https://doi.org/10.1002/14651858.CD008794.pub2>
103. Askling J, Fahrback K, Nordstrom B, Ross S, Schmid CH, Symmons D. Cancer risk with tumor necrosis factor alpha (TNF) inhibitors: meta-analysis of randomized controlled trials of adalimumab, etanercept, and infliximab using patient level data. *Pharmacoepidemiol Drug Saf* 2011;**20**:119–30. <https://doi.org/10.1002/pds.2046>
104. Corbett M, Soares M, Jhuti G, Rice S, Spackman E, Sideris E, *et al.* Tumour necrosis factor-alpha inhibitors for ankylosing spondylitis and non-radiographic axial spondyloarthritis: a systematic review and economic evaluation. *Health Technol Assess* 2016;**20**(9). <https://doi.org/10.3310/hta20090>
105. Tarp S, Tarp U, Andersen LS, Lorenzen T, Lindegaard HM, Stoltenberg M, *et al.* Serious adverse events associated with using biological agents to treat rheumatic diseases: network meta-analysis from a national guideline panel. *Arthritis Rheum* 2013;**65**:S997–8.
106. Capogrosso-Sansone A, Mantarro S, Blandizzi C, Montagnani S, Ruggiero E, Saporiti A, *et al.* Update of certolizumab pegol safety profile: a systematic review and meta-analysis. *Drug Saf* 2014;**37**:844–5.
107. Girolomoni G, Altomare G, Ayala F, Berardesca E, Calzavara-Pinton P, Chimenti S, *et al.* Safety of anti-TNF α agents in the treatment of psoriasis and psoriatic arthritis. *Immunopharmacol Immunotoxicol* 2012;**34**:548–60. <https://doi.org/10.3109/08923973.2011.653646>
108. Dixon WG, Hyrich KL, Watson KD, Lunt M. The influence of anti-TNF therapy upon the incidence and severity of serious lower respiratory tract infections in patients with rheumatoid arthritis: results from the BSR biologics register (BSRBR). *Rheumatology* 2008;**47**(Suppl. 2):ii47.
109. Mariette X, Tubach F, Bagheri H, Bardet M, Berthelot JM, Gaudin P, *et al.* Lymphoma in patients treated with anti-TNF: results of the 3-year prospective French RATIO registry. *Ann Rheum Dis* 2010;**69**:400–8. <https://doi.org/10.1136/ard.2009.117762>
110. Zisman D, Bitterman H, Shalom G, Feldhamer I, Comanesther D, Batat E, *et al.* Psoriatic arthritis treatment and the risk of herpes zoster. *Ann Rheum Dis* 2016;**75**:131–5. <https://doi.org/10.1136/annrheumdis-2013-205148>
111. Dias S, Welton NJ, Sutton AJ, Ades AE. *NICE DSU Technical Support Document 1: Introduction to Evidence Synthesis for Decision Making*. 2011. URL: <http://scharr.dept.shef.ac.uk/nicedsu/technical-support-documents/evidence-synthesis-tds-series/> (last updated April 2012).

112. National Institute for Health and Care Excellence (NICE). *Multiple Technology Appraisal. Certolizumab Pegol and Secukinumab for Treating Active Psoriatic Arthritis Following Inadequate Response to Disease Modifying Antirheumatic Drugs [ID579]. Final Scope*. London: NICE; 2015. URL: www.nice.org.uk/guidance/GID-TAG521/documents/final-scope (accessed 14 December 2016).
113. Julious S, Wong SJ. How biased are indirect comparisons, particularly when comparisons are made over time in controlled trials? *Drug Inf J* 2008;**42**:625–33. <https://doi.org/10.1177/009286150804200610>
114. Dias S, Sutton AJ, Welton NJ, Ades AE. *NICE DSU Technical Support Document 3: Heterogeneity: Subgroups, Meta-regression, Bias and Bias-adjustment*. 2011. URL: <http://scharr.dept.shef.ac.uk/nicedsu/technical-support-documents/evidence-synthesis-tsd-series/> (accessed December 2016).
115. Spiegelhalter DJ, Best NG, Carlin BP, van der Linde A. Bayesian measures of model complexity and fit (with discussion). *J R Stat Soc Series B Stat Methodol* 2002;**64**:583–639. <https://doi.org/10.1111/1467-9868.00353>
116. Mease PJ, Woolley JM, Bitman B, Wang BC, Globe DR, Singh A. Minimally important difference of Health Assessment Questionnaire in psoriatic arthritis: relating thresholds of improvement in functional ability to patient-rated importance and satisfaction. *J Rheumatol* 2011;**38**:2461–5. <https://doi.org/10.3899/jrheum.110546>
117. Dias S, Welton NJ, Sutton AJ, Ades AE. *NICE DSU Technical Support Document 2: A Generalised Linear Modelling Framework for Pairwise and Network Meta-analysis of Randomised Controlled Trials*. 2011. URL: <http://scharr.dept.shef.ac.uk/nicedsu/technical-support-documents/evidence-synthesis-tsd-series/> (accessed December 2016).
118. Yang H, Epstein D, Bojke L, Craig D, Light K, Bruce I, et al. Golimumab for the treatment of psoriatic arthritis. *Health Technol Assess* 2011;**15**(Suppl. 1). <https://doi.org/10.3310/hta15suppl1/10>
119. Drummond M, Sculpher MJ, Torrance GW, O'Brien BJ, Stoddart GL. *Methods for the Economic Evaluation of Health Care Programmes*. 3rd edn. Oxford: Oxford University Press; 2005.
120. Codreanu C, Mogosanu C, Joita M, Purcaru O. Cost-effectiveness of certolizumab pegol in the treatment of active rheumatoid arthritis, axial spondyloarthritis, and psoriatic arthritis in Romania. *Value Health* 2014;**17**:A379. <https://doi.org/10.1016/j.jval.2014.08.2608>
121. Tzanetakos C, Vassilopoulos D, Kourlaba G, Christou P, Maniadakis N. Cost-utility analysis of certolizumab pegol for the treatment of active psoriatic arthritis in Greece. *Value Health* 2015;**18**:A646–7. <https://doi.org/10.1016/j.jval.2015.09.2319>
122. Bojke L, Epstein D, Craig D, Rodgers M, Woolacott N, Yang H, et al. Modelling the cost-effectiveness of biologic treatments for psoriatic arthritis. *Rheumatology* 2011;**50**(Suppl. 4):39–47. <https://doi.org/10.1093/rheumatology/ker245>
123. Einarson TR, Bereza BG, Bobro I, Efremova E, Lelli F. Economic analysis of ustekinumab for psoriatic arthritis in Russia. *Value Health* 2015;**18**:A648. <https://doi.org/10.1016/j.jval.2015.09.2325>
124. Wang X, Bansback N, Anis A, Joshi AD, Rao S, Wolff M, et al. Economic evaluation model of biologic therapies for moderate to severe psoriatic arthritis in Germany. *Value Health* 2012;**15**:A446. <https://doi.org/10.1016/j.jval.2012.08.1392>
125. National Institute for Health and Care Excellence. *Guide to the Methods of Technology Appraisal 2013*. London: NICE; 2013.
126. Madan J, Ades T, Barton P, Bojke L, Choy E, Helliwell P, et al. Consensus decision models for biologics in rheumatoid and psoriatic arthritis: recommendations of a multidisciplinary working party. *Rheumatol Ther* 2015;**2**:113–25. <https://doi.org/10.1007/s40744-015-0020-0>

127. Kyle S, Chandler D, Griffiths CE, Helliwell P, Lewis J, McInnes I, *et al.* Guideline for anti-TNF-alpha therapy in psoriatic arthritis. *Rheumatology* 2005;**44**:390–7. <https://doi.org/10.1093/rheumatology/keh514>
128. Smith CH, Anstey AV, Barker JN, Burden AD, Chalmers RJ, Chandler DA, *et al.* British Association of Dermatologists' guidelines for biologic interventions for psoriasis 2009. *Br J Dermatol* 2009;**161**:987–1019. <https://doi.org/10.1111/j.1365-2133.2009.09505.x>
129. Kobelt G, Jönsson L, Lindgren P, Young A, Eberhardt K. Modeling the progression of rheumatoid arthritis: a two-country model to estimate costs and consequences of rheumatoid arthritis. *Arthritis Rheum* 2002;**46**:2310–19. <https://doi.org/10.1002/art.10471>
130. Bansback NJ, Ara R, Barkham N, Brennan A, Fraser AD, Conway P, *et al.* Estimating the cost and health status consequences of treatment with TNF antagonists in patients with psoriatic arthritis. *Rheumatology* 2006;**45**:1029–38. <https://doi.org/10.1093/rheumatology/kel147>
131. Hartman M, Prins M, Swinkels OQ, Severens JL, De Boo T, Van Der Wilt GJ, *et al.* Cost-effectiveness analysis of a psoriasis care instruction programme with dithranol compared with UVB phototherapy and inpatient dithranol treatment. *Br J Dermatol* 2002;**147**:538–44. <https://doi.org/10.1046/j.1365-2133.2002.04920.x>
132. National Institute for Health and Care Excellence. *Etanercept, Infliximab and Adalimumab for the Treatment of Psoriatic Arthritis*. [TA199]. London: NICE; 2010. URL: www.nice.org.uk/guidance/ta199 (accessed September 2017).
133. Cummins E, Asseburg C, Prasad M, Buchanan J, Puneekar YS. Cost effectiveness of golimumab for the treatment of active psoriatic arthritis. *Eur J Health Econ* 2012;**13**:801–9. <https://doi.org/10.1007/s10198-011-0335-x>
134. Anon. *Monthly Index of Medical Specialities (MIMS)*. London: Haymarket Media Group Ltd; 2016.
135. Joint Formulary Committee. *British National Formulary 2015*. London: BMJ Group and Pharmaceutical Press; 2015.
136. Curtis L, Burns A. *Unit Costs of Health and Social Care 2015*. Canterbury: Personal Social Services Research Unit, University of Kent; 2015.
137. Department of Health (DH). *NHS Reference Costs 2014 to 2015*. London: DH; 2015.
138. Poole CD, Lebmeier M, Ara R, Rafia R, Currie CJ. Estimation of health care costs as a function of disease severity in people with psoriatic arthritis in the UK. *Rheumatology* 2010;**49**:1949–56. <https://doi.org/10.1093/rheumatology/keq182>
139. Joint Formulary Committee. *British National Formulary*. London: BMJ Group and Pharmaceutical Press; 2016.
140. National Institute for Health and Care Excellence. *Etanercept, Infliximab and Adalimumab for the Treatment of Psoriatic Arthritis [TA199]*. London: NICE; 2010.
141. Dolan P, Gudex C, Kind P, Williams A. *A Social Tariff for EuroQol: Results from a UK General Population Survey*. Centre for Health Economics Discussion Paper 138. York: Centre for Health Economics, University of York; 1995.
142. Briggs A, Sculpher M, Claxton K. *Decision Modelling for Health Economic Evaluation*. Oxford: Oxford University Press; 2006.
143. Asaria M, Walker S, Palmer S, Gale CP, Shah AD, Abrams KR, *et al.* Using electronic health records to predict costs and outcomes in stable coronary artery disease. *Heart* 2016;**102**:755–62. <https://doi.org/10.1136/heartjnl-2015-308850>

144. HM Treasury. *The Green Book: Appraisal and Evaluation in Central Government*. London: HM Treasury; 2013.
145. Office for National Statistics. *National Life Tables, UK: 2013–2015*. Newport: Office for National Statistics; 2015.
146. Poyner TF, Wall ARJ, Adnitt PI, Menday AP. Economic impact of psoriasis treatment on the patient and on the National Health Service. *J Dermatol Treatment* 1999;**10**:25–9.
147. Karlsson G, Johannesson M. The decision rules of cost-effectiveness analysis. *Pharmacoeconomics* 1996;**9**:113–20. <https://doi.org/10.2165/00019053-199609020-00003>
148. Lefebvre C, Manheimer E, Glanville J. Chapter 6: Searching for Studies. In Higgins J, Green S, editors. *Cochrane Handbook for Systematic Reviews of Interventions Version 5.1.0 (Updated March 2011)*. The Cochrane Collaboration; 2011. URL: www.cochrane-handbook.org (accessed December 2016).
149. Lefebvre C, Eisinga A, McDonald S, Paul N. Enhancing access to reports of clinical trials published world-wide – the contribution of EMBASE records to the Cochrane Central Register of Controlled Trials (CENTRAL) in The Cochrane Library. *Emerg Themes Epidemiol* 2008;**5**:13. <https://doi.org/10.1186/1742-7622-5-13>
150. Centre for Reviews and Dissemination. *Search Strategies for DARE*. 2015. URL: www.crd.york.ac.uk/crdweb/searchstrategies.asp (accessed 15 December 2015).
151. Langley RG, Elewski BE, Lebwohl M, Reich K, Griffiths CE, Papp K, *et al*. Secukinumab in plaque psoriasis – results of two phase 3 trials. *N Engl J Med* 2014;**371**:326–38. <https://doi.org/10.1056/NEJMoa1314258>
152. Adams R, Walsh C, Veale D, Bresnihan B, FitzGerald O, Barry M. Understanding the relationship between the EQ-5D, SF-6D, HAQ and disease activity in inflammatory arthritis. *Pharmacoeconomics* 2010;**28**:477–87. <https://doi.org/10.2165/11533010-000000000-00000>
153. Adams R, Craig BM, Walsh CD, Veale DJ, Bresnihan B, FitzGerald O, *et al*. The impact of a revised EQ-5D population scoring on preference-based utility scores in an inflammatory arthritis cohort. *Value Health* 2011;**14**:921–7. <https://doi.org/10.1016/j.jval.2011.03.002>
154. Brodsky V, Péntek M, Bálint PV, Géher P, Hajdu O, Hodinka L, *et al*. Comparison of the Psoriatic Arthritis Quality of Life (PsAQoL) questionnaire, the functional status (HAQ) and utility (EQ-5D) measures in psoriatic arthritis: results from a cross-sectional survey. *Scand J Rheumatol* 2010;**39**:303–9. <https://doi.org/10.3109/03009740903468982>
155. Gratacós J, Daudén E, Gómez-Reino J, Moreno JC, Casado MÁ, Rodríguez-Valverde V. Health-related quality of life in psoriatic arthritis patients in Spain. *Reumatol Clin* 2014;**10**:25–31. <https://doi.org/10.1016/j.reuma.2013.05.006>
156. Leung YY, Png ME, Wee HL, Thumboo J. Comparison of EuroQol-5D and short form-6D utility scores in multiethnic Asian patients with psoriatic arthritis: a cross-sectional study. *J Rheumatol* 2013;**40**:859–65. <https://doi.org/10.3899/jrheum.120782>
157. Picchianti-Diamanti A, Germano V, Ferlito C, Migliore A, D’Amelio R, Lagana B. Health-related quality of life and disability in patients with rheumatoid, early rheumatoid and early psoriatic arthritis treated with etanercept. *Qual Life Res* 2010;**19**:821–6. <https://doi.org/10.1007/s11136-010-9651-3>
158. Stolfa J. Golimumab in the PsA treatment. *Rheumatologia* 2010;**24**:31–7.

Appendix 1 Database search strategies

MEDLINE

Via Ovid: <http://ovidsp.ovid.com/>

Date range searched: 1946 to November week 3 2015.

Date searched: 1 December 2015.

Records retrieved: 712.

The Cochrane highly sensitive search strategy for identifying randomised trials in Ovid MEDLINE: sensitivity maximising version was used to limit retrieval to clinical trials (lines 25–35).¹⁴⁸

The search was updated on 28 April 2016 and retrieved 749 records.

Search strategy

1. Arthritis, Psoriatic/ (4144)
2. (psoria\$ adj2 (arthrit\$ or arthropath\$)).ti,ab. (6043)
3. 1 or 2 (6887)
4. (Certolizumab or Cimzia or CZP or CDP870 or CDP-870 or 428863-50-7).af. (763)
5. 3 and 4 (53)
6. (secukinumab or Cosentyx or AIN457 or AIN-457 or 1229022-83-6).af. (88)
7. 3 and 6 (18)
8. (golimumab or simponi or CNTO148 or CNTO-148 or 476181-74-5).af. (431)
9. (2010\$ or 2011\$ or 2012\$ or 2013\$ or 2014\$ or 2015\$).ed. (4,809,341)
10. 3 and 8 and 9 (89)
11. (apremilast or otezla or otezia or CC10004 or CC-10004 or 608141-41-9).af. (92)
12. (2014\$ or 2015\$).ed. (1,668,230)
13. 3 and 11 and 12 (22)
14. (ustekinumab or stelara or CNTO1275 or CNTO-1275 or 815610-63-0).af. (536)
15. (2012\$ or 2013\$ or 2014\$ or 2015\$).ed. (3,233,078)
16. 3 and 14 and 15 (86)
17. (inflectra or remsima or CT-P13).af. (17)
18. 3 and 17 (1)
19. (etanercept or enbrel or 185243-69-0).af. (5831)
20. (infliximab or remicade or 170277-31-3).af. (9674)
21. (adalimumab or humira or D2E7 or (D2 adj E7) or 331731-18-1).af. (4205)
22. 19 or 20 or 21 (14,458)
23. (2009\$ or 2010\$ or 2011\$ or 2012\$ or 2013\$ or 2014\$ or 2015\$).ed. (5,535,938)
24. 3 and 22 and 23 (650)
25. randomized controlled trial.pt. (417,039)
26. controlled clinical trial.pt. (92,231)
27. randomized.ab. (308,924)
28. placebo.ab. (159,456)
29. drug therapy.fs. (1,860,741)
30. randomly.ab. (218,795)
31. trial.ab. (321,356)
32. groups.ab. (1,376,975)

33. or/25-32 (3,513,844)
34. exp animals/ not humans/ (4,152,952)
35. 33 not 34 (2,995,700)
36. 5 or 7 or 10 or 13 or 16 or 18 or 24 (765)
37. 35 and 36 (712)

Key

/ = indexing term [medical subject heading (MeSH) heading].

exp = exploded indexing term (MeSH heading).

\$ = truncation.

ti,ab = terms in either title or abstract fields.

af = terms in any field.

ed = entry date – date added to the database.

pt = publication type.

fs = floating subheading.

adj = terms next to each other (order specified).

adj2 = terms within two words of each other (any order).

MEDLINE In-Process & Other Non-Indexed Citations

Via Ovid: <http://ovidsp.ovid.com/>

Date range searched: 30 November 2015.

Date searched: on 1 December 2015.

Records retrieved: 157.

The search was updated on 28 April 2016 and retrieved 168 records.

Search strategy

1. Arthritis, Psoriatic/ (0)
2. (psoria\$ adj2 (arthrit\$ or arthropath\$)).ti,ab. (655)
3. 1 or 2 (655)
4. (Certolizumab or Cimzia or CZP or CDP870 or CDP-870 or 428863-50-7).af. (126)
5. 3 and 4 (16)
6. (secukinumab or Cosentyx or AIN457 or AIN-457 or 1229022-83-6).af. (45)
7. 3 and 6 (10)
8. (golimumab or simponi or CNTO148 or CNTO-148 or 476181-74-5).af. (97)
9. 3 and 8 (13)
10. (apremilast or otezla or otezia or CC10004 or CC-10004 or 608141-41-9).af. (45)
11. 3 and 10 (25)

12. (ustekinumab or stelara or CNTO1275 or CNTO-1275 or 815610-63-0).af. (148)
13. 3 and 12 (36)
14. (inflectra or remsima or CT-P13).af. (19)
15. 3 and 14 (0)
16. (etanercept or enbrel or 185243-69-0).af. (542)
17. (infliximab or remicade or 170277-31-3).af. (994)
18. (adalimumab or humira or D2E7 or (D2 adj E7) or 331731-18-1).af. (631)
19. 16 or 17 or 18 (1560)
20. 3 and 19 (97)
21. 5 or 7 or 9 or 11 or 13 or 15 or 20 (157)

Key

/ = indexing term (MeSH heading).

\$ = truncation.

ti,ab = terms in either title or abstract fields.

af = terms in any field.

adj = terms next to each other (order specified).

adj2 = terms within two words of each other (any order).

Cochrane Central Register of Controlled Trials

Via Wiley Online Library: <http://onlinelibrary.wiley.com/>

Issue 11 of 12, November 2015.

Date searched: 1 December 2015.

Records retrieved: 225.

The strategy below was used to search CENTRAL and CDSR.

The search was updated on 28 April 2016 and retrieved 249 records from CENTRAL.

Search strategy

- #1 MeSH descriptor: [Arthritis, Psoriatic] this term only (199)
- #2 (psoria* near/2 (arthrit* or arthropath*)):ti,ab,kw (560)
- #3 #1 or #2 (560)
- #4 (Certolizumab or Cimzia or CZP or CDP870 or CDP-870 or 428863-50-7):ti,ab,kw (191)
- #5 #3 and #4 (24)
- #6 (secukinumab or Cosentyx or AIN457 or AIN-457 or 1229022-83-6):ti,ab,kw (124)
- #7 #3 and #6 (28)

#8 (golimumab or simponi or CNTO148 or CNTO-148 or 476181-74-5):ti,ab,kw Publication Year from 2010 to 2015 (210)

#9 #3 and #8 (40)

#10 (apremilast or otezla or otezia or CC10004 or CC-10004 or 608141-41-9):ti,ab,kw Publication Year from 2014 to 2015 (35)

#11 #3 and #10 (21)

#12 (ustekinumab or stelara or CNTO1275 or CNTO-1275 or 815610-63-0):ti,ab,kw Publication Year from 2012 to 2015 (102)

#13 #3 and #12 (39)

#14 (inflectra or remsima or CT-P13):ti,ab,kw (15)

#15 #3 and #14 (4)

#16 (etanercept or enbrel or 185243-69-0):ti,ab,kw Publication Year from 2009 to 2015 (577)

#17 (infliximab or remicade or 170277-31-3):ti,ab,kw Publication Year from 2009 to 2015 (655)

#18 (adalimumab or humira or D2E7 or (D2 next E7) or 331731-18-1):ti,ab,kw Publication Year from 2009 to 2015 (722)

#19 #16 or #17 or #18 (1551)

#20 #3 and #19 (116)

#21 #5 or #7 or #9 or #11 or #13 or #15 or #20 (250)

#22 #5 or #7 or #9 or #11 or #13 or #15 or #20 in Cochrane Reviews (Reviews and Protocols) and Trials (228)

Note that 228 results at line #22 include Cochrane Reviews or Protocols as well as trials from CENTRAL.

Key

MeSH descriptor = indexing term (MeSH heading).

* = truncation.

ti,ab,kw = terms in either title or abstract or keyword fields.

near/2 = terms within two words of each other (any order).

next = terms are next to each other.

Cochrane Database of Systematic Reviews

Via Wiley Online Library: <http://onlinelibrary.wiley.com/>

Issue 12 of 12, December 2015.

Date searched: 1 December 2015.

Records retrieved: three.

See above under CENTRAL for search strategy used.

The search was updated on 28 April 2016 and retrieved three records from CDSR.

Database of Abstracts of Reviews of Effects

Via: www.crd.york.ac.uk/CRDWeb/

Date range searched: inception to 31 March 2015.

Date searched: 1 December 2015.

Records retrieved: 13.

The strategy below was used to search DARE and NHS EED.

As DARE and NHS EED were no longer receiving new records after 31 March 2015 these searches were not updated.

Search strategy

1	MeSH DESCRIPTOR Arthritis, Psoriatic	55
2	((psoria* NEAR2 (arthrit* or arthropath*)))	88
3	((arthrit* or arthropath*) NEAR2 psoria*)	68
4	(Certolizumab or Cimzia or CZP or CDP870 or CDP-870 or 428863-50-7)	33
5	(secukinumab or Cosentyx or AIN457 or AIN-457 or 1229022-83-6)	7
6	(golimumab or simponi or CNTO148 or CNTO-148 or 476181-74-5) where LPD from 1 January 2010 to 31 March 2015	31
7	(apremilast or otezla or otezia or CC10004 or CC-10004 or 608141-41-9) where LPD from 1 January 2014 to 31 March 2015	1
8	(ustekinumab or stelara or CNTO1275 or CNTO-1275 or 815610-63-0) where LPD from 1 January 2012 to 31 March 2015	22
9	(inflectra or remsima or CT-P13)	5
10	(etanercept or enbrel or 185243-69-0) where LPD from 1 January 2009 to 31 March 2015	137
11	(infliximab or remicade or 170277-31-3) where LPD from 1 January 2009 to 31 March 2015	204
12	(adalimumab or humira or D2E7 or D2-E7 or 331731-18-1) where LPD from 1 January 2009 to 31 March 2015	152
13	#1 OR #2 OR #3	92
14	#4 OR #5 OR #6 OR #7 OR #8 OR #9 OR #10 OR #11 OR #12	321
15	#13 AND #14	39
16	(#13 AND #14) in DARE	13
17	(#13 AND #14) in NHS EED	8
18	(#13 AND #14) in HTA	18

Key

- MeSH DESCRIPTOR = indexing term (MeSH heading).
- * = truncation.
- NEAR2 = terms within two words of each other (order specified).

EMBASE

Via Ovid: <http://ovidsp.ovid.com/>

Date range searched: 1974 to 2015 November 30.

Date searched: 1 December 2015.

Records retrieved: 639.

A search strategy developed by Lefebvre *et al.* to limit retrieval of studies to RCTs was used (see lines 38–52).¹⁴⁹

The search was updated on 28 April 2016 and retrieved 744 records.

Search strategy

1. psoriatic arthritis/ (13,050)
2. (psoria\$ adj2 (arthrit\$ or arthropath\$)).ti,ab. (11,246)
3. 1 or 2 (15,353)
4. certolizumab pegol/ (3506)
5. (Certolizumab or Cimzia or CZP or CDP870 or CDP-870 or 428863-50-7).af. (4212)
6. 4 or 5 (4212)
7. 3 and 6 (548)
8. secukinumab/ (601)
9. (secukinumab or Cosentyx or AIN457 or AIN-457 or 1229022-83-6).af. (679)
10. 8 or 9 (679)
11. 3 and 10 (199)
12. golimumab/ (2969)
13. (golimumab or simponi or CNTO148 or CNTO-148 or 476181-74-5).af. (3054)
14. 12 or 13 (3054)
15. (2010\$ or 2011\$ or 2012\$ or 2013\$ or 2014\$ or 2015\$).em. (8,021,136)
16. 3 and 14 and 15 (708)
17. apremilast/ (456)
18. (apremilast or otezla or otezia or CC10004 or CC-10004 or 608141-41-9).af. (490)
19. 17 or 18 (490)
20. (2014\$ or 2015\$).em. (3,442,925)
21. 3 and 19 and 20 (170)
22. ustekinumab/ (2445)
23. (ustekinumab or stelara or CNTO1275 or CNTO-1275 or 815610-63-0).af. (2559)
24. 22 or 23 (2559)
25. (2012\$ or 2013\$ or 2014\$ or 2015\$).em. (6,165,443)
26. 3 and 24 and 25 (565)
27. (inflectra or remsima or CT-P13).af. (123)
28. 3 and 27 (21)

29. etanercept/ (21,668)
30. (etanercept or enbrel or 185243-69-0).af. (22,500)
31. infliximab/ (33,968)
32. (infliximab or remicade or 170277-31-3).af. (34,643)
33. adalimumab/ (18,932)
34. (adalimumab or humira or D2E7 or (D2 adj E7) or 331731-18-1).af. (19,317)
35. or/29-34 (47,513)
36. (2009\$ or 2010\$ or 2011\$ or 2012\$ or 2013\$ or 2014\$ or 2015\$).em. (9,378,944)
37. 3 and 35 and 36 (3116)
38. random\$.ti,ab. (1,044,993)
39. factorial\$.ti,ab. (26,816)
40. crossover\$.ti,ab. (55,631)
41. cross-over\$.ti,ab. (24,911)
42. placebo\$.ti,ab. (230,032)
43. (doubl\$ adj blind\$).ti,ab. (163,599)
44. (singl\$ adj blind\$).ti,ab. (16,962)
45. assign\$.ti,ab. (278,181)
46. allocat\$.ti,ab. (100,141)
47. volunteer\$.ti,ab. (201,600)
48. Crossover Procedure/ (45,294)
49. double blind procedure/ (127,551)
50. Randomized Controlled Trial/ (392,436)
51. single blind procedure/ (21,379)
52. or/38-51 (1,651,603)
53. 7 or 11 or 16 or 21 or 26 or 28 or 37 (3624)
54. 52 and 53 (639)
55. animal/ (1,708,125)
56. exp animal experiment/ (1,900,985)
57. nonhuman/ (4,661,466)
58. (rat or rats or mouse or mice or hamster or hamsters or animal or animals or dog or dogs or cat or cats or bovine or sheep).ti,ab,sh. (5,213,728)
59. or/55-58 (7,584,705)
60. exp human/ (16,613,065)
61. human experiment/ (345,688)
62. 60 or 61 (16,614,514)
63. 59 not (59 and 62) (5,821,013)
64. 54 not 63 (639)

Key

/ = indexing term (Emtree heading).

exp = exploded indexing term (Emtree heading).

\$ = truncation.

ti,ab = terms in either title or abstract fields.

af = all fields.

pt = publication type.

sh = subject heading field.

adj2 = terms within two words of each other (any order).

em = entry week – date added to the database.

Health Technology Assessment database

Via: www.crd.york.ac.uk/CRDWeb/

Date range searched: inception to 31 March 2015.

Date searched: 1 December 2015.

Records retrieved: 18.

The search was updated on 28 April 2016 and retrieved 20 records.

Search strategy

1	MeSH DESCRIPTOR Arthritis, Psoriatic	55
2	((psoria* NEAR2 (arthrit* or arthropath*)))	88
3	((arthrit* or arthropath*) NEAR2 psoria*)	68
4	(Certolizumab or Cimzia or CZP or CDP870 or CDP-870 or 428863-50-7)	33
5	(secukinumab or Cosentyx or AIN457 or AIN-457 or 1229022-83-6)	7
6	(golimumab or simponi or CNTO148 or CNTO-148 or 476181-74-5) where LPD from 1 January 2010 to 1 December 2015	31
7	(apremilast or otezla or otezia or CC10004 or CC-10004 or 608141-41-9) where LPD from 1 January 2014 to 1 December 2015	4
8	(ustekinumab or stelara or CNTO1275 or CNTO-1275 or 815610-63-0) where LPD from 1 January 2012 to 1 December 2015	28
9	(inflectra or remsima or CT-P13)	5
10	(etanercept or enbrel or 185243-69-0) where LPD from 1 January 2009 to 1 December 2015	176
11	(infliximab or remicade or 170277-31-3) where LPD from 1 January 2009 to 1 December 2015	267
12	(adalimumab or humira or D2E7 or D2-E7 or 331731-18-1) where LPD from 1 January 2009 to 1 December 2015	204
13	#1 OR #2 OR #3	92
14	#4 OR #5 OR #6 OR #7 OR #8 OR #9 OR #10 OR #11 OR #12	403
15	#13 AND #14	46
16	(#13 AND #14) in HTA	18

Key

- MeSH DESCRIPTOR = indexing term (MeSH heading).
- * = truncation.
- NEAR2 = terms within two words of each other (order specified).

PubMed

Via: www.ncbi.nlm.nih.gov/pubmed/

Date searched: 1 December 2015.

Records retrieved: 779.

The Cochrane highly sensitive search strategy for identifying randomised trials in PubMed sensitivity maximising version was used to limit retrieval to clinical trials.¹⁴⁸

The search was updated on 28 April 2016 and retrieved 844 records.

Search strategy

Search (((((((('Arthritis, Psoriatic'[Mesh:noexp]) OR (psoria*[Title/Abstract] AND arthrit*[Title/Abstract]) OR (psoria*[Title/Abstract] AND arthropath*[Title/Abstract]))) AND ((Certolizumab OR Cimzia OR CZP OR CDP870 OR CDP-870 OR 428863-50-7)))) OR (((('Arthritis, Psoriatic'[Mesh:noexp]) OR (psoria*[Title/Abstract] AND arthrit*[Title/Abstract]) OR (psoria*[Title/Abstract] AND arthropath*[Title/Abstract]))) AND ((secukinumab OR Cosentyx OR AIN457 OR AIN-457 OR 1229022-83-6)))) OR (((('Arthritis, Psoriatic'[Mesh:noexp]) OR (psoria*[Title/Abstract] AND arthrit*[Title/Abstract]) OR (psoria*[Title/Abstract] AND arthropath*[Title/Abstract]))) AND ((golimumab OR simponi OR CNTO148 OR CNTO-148 OR 476181-74-5)) AND ('2010/01/01'[Date - Entrez] : '3000'[Date - Entrez]))) OR (((('Arthritis, Psoriatic'[Mesh:noexp]) OR (psoria*[Title/Abstract] AND arthrit*[Title/Abstract]) OR (psoria*[Title/Abstract] AND arthropath*[Title/Abstract]))) AND ((apremilast OR otezla OR otezia OR CC10004 OR CC-10004 OR 608141-41-9)) AND ('2014/01/01'[Date - Entrez] : '3000'[Date - Entrez]))) OR (((('Arthritis, Psoriatic'[Mesh:noexp]) OR (psoria*[Title/Abstract] AND arthrit*[Title/Abstract]) OR (psoria*[Title/Abstract] AND arthropath*[Title/Abstract]))) AND ((ustekinumab OR stelara OR CNTO1275 OR CNTO-1275 OR 815610-63-0)) AND ('2012/01/01'[Date - Entrez] : '3000'[Date - Entrez]))) OR (((('Arthritis, Psoriatic'[Mesh:noexp]) OR (psoria*[Title/Abstract] AND arthrit*[Title/Abstract]) OR (psoria*[Title/Abstract] AND arthropath*[Title/Abstract]))) AND ((inflectra OR remsima OR CT-P13)))) OR (((('Arthritis, Psoriatic'[Mesh:noexp]) OR (psoria*[Title/Abstract] AND arthrit*[Title/Abstract]) OR (psoria*[Title/Abstract] AND arthropath*[Title/Abstract]))) AND (((((etanercept OR enbrel OR 185243-69-0))) AND ('2009/01/01'[Date - Entrez] : '3000'[Date - Entrez]))) OR (((infliximab OR remicade OR 170277-31-3))) AND ('2009/01/01'[Date - Entrez] : '3000'[Date - Entrez]))) OR (((adalimumab OR humira OR D2E7 OR D2-E7 OR 331731-18-1))) AND ('2009/01/01'[Date - Entrez] : '3000'[Date - Entrez]))) AND (((((((randomized controlled trial[Publication Type]) OR controlled clinical trial[Publication Type]) OR randomized[Title/Abstract]) OR placebo[Title/Abstract]) OR drug therapy[sh]) OR randomly[Title/Abstract]) OR trial[Title/Abstract]) OR groups[Title/Abstract])) NOT (animals[mh] NOT humans[mh]))

Key

[Mesh] = exploded indexing term (MeSH heading).

[mh] = exploded indexing term (MeSH heading).

[Mesh:NoExp] = indexing term (MeSH heading) not exploded.

* = truncation.

[Title/Abstract] = terms in either title or abstract fields.

[Publication Type] = terms in the publication type field.

[Date - Entrez] = date added to the database.

[sh] = subheading.

Science Citation Index

Via Web of Science, Thomson Reuters: <http://thomsonreuters.com/thomson-reuters-web-of-science/>

Date range searched: 1900 to 28 November 2015.

Date searched: 1 December 2015.

Records retrieved: 712.

Strategy below was used to search SCI and the CPCI-S. As both databases were searched together the records retrieved refer to results from both databases.

The search was updated on 28 April 2016 and retrieved 796 records from both databases.

Search strategy

# 27	712	#26 AND #25 <i>Indexes=SCI-EXPANDED, CPCI-S Timespan=All years</i>
# 26	1284	#18 OR #13 OR #11 OR #9 OR #7 OR #5 OR #3 <i>Indexes=SCI-EXPANDED, CPCI-S Timespan=All years</i>
# 25	5,529,680	#23 NOT #24 <i>Indexes=SCI-EXPANDED, CPCI-S Timespan=All years</i>
# 24	3,812,114	TS=(animal or animals or dog or dogs or hamster* or mice or mouse or rat or rats or bovine or sheep or guinea*) <i>Indexes=SCI-EXPANDED, CPCI-S Timespan=All years</i>
# 23	6,341,875	#22 OR #21 OR #20 OR #19 <i>Indexes=SCI-EXPANDED, CPCI-S Timespan=All years</i>
# 22	5,414,453	TS=(placebo* or random* or control* or prospectiv* or volunteer*) <i>Indexes=SCI-EXPANDED, CPCI-S Timespan=All years</i>
# 21	486,891	TS=(clinic* SAME trial*) <i>Indexes=SCI-EXPANDED, CPCI-S Timespan=All years</i>
# 20	227,219	TS=((singl* or doubl* or trebl* or tripl*) SAME (blind* or mask*)) <i>Indexes=SCI-EXPANDED, CPCI-S Timespan=All years</i>
# 19	1,143,892	TS=((study or studies) SAME design*) <i>Indexes=SCI-EXPANDED, CPCI-S Timespan=All years</i>
# 18	973	#17 AND #1 <i>Indexes=SCI-EXPANDED, CPCI-S Timespan=All years</i>
# 17	13,195	#16 OR #15 OR #14 <i>Indexes=SCI-EXPANDED, CPCI-S Timespan=2009-2015</i>
# 16	4497	TS=(adalimumab or humira or D2E7 or (D2 NEAR/1 E7) or 331731-18-1) <i>Indexes=SCI-EXPANDED, CPCI-S Timespan=2009-2015</i>
# 15	8564	TS=(infliximab or remicade or 170277-31-3) <i>Indexes=SCI-EXPANDED, CPCI-S Timespan=2009-2015</i>

# 14	4505	TS=(etanercept or enbrel or 185243-69-0) <i>Indexes=SCI-EXPANDED, CPCI-S Timespan=2009-2015</i>
# 13	4	#12 AND #1 <i>Indexes=SCI-EXPANDED, CPCI-S Timespan=All years</i>
# 12	48	TS=(inflectra or remsima or CT-P13) <i>Indexes=SCI-EXPANDED, CPCI-S Timespan=All years</i>
# 11	151	#10 AND #1 <i>Indexes=SCI-EXPANDED, CPCI-S Timespan=All years</i>
# 10	632	TS=(ustekinumab or stelara or CNTO1275 or CNTO-1275 or 815610-63-0) <i>Indexes=SCI-EXPANDED, CPCI-S Timespan=2012-2015</i>
# 9	61	#8 AND #1 <i>Indexes=SCI-EXPANDED, CPCI-S Timespan=All years</i>
# 8	126	TS=(apremilast or otezla or otezia or CC10004 or CC-10004 or 608141-41-9) <i>Indexes=SCI-EXPANDED, CPCI-S Timespan=2014-2015</i>
# 7	137	#6 AND #1 <i>Indexes=SCI-EXPANDED, CPCI-S Timespan=All years</i>
# 6	594	TS=(golimumab or simponi or CNTO148 or CNTO-148 or 476181-74-5) <i>Indexes=SCI-EXPANDED, CPCI-S Timespan=2010-2015</i>
# 5	54	#4 AND #1 <i>Indexes=SCI-EXPANDED, CPCI-S Timespan=All years</i>
# 4	257	TS=(secukinumab or Cosentyx or AIN457 or AIN-457 or 1229022-83-6) <i>Indexes=SCI-EXPANDED, CPCI-S Timespan=All years</i>
# 3	101	#2 AND #1 <i>Indexes=SCI-EXPANDED, CPCI-S Timespan=All years</i>
# 2	1386	TS=(Certolizumab or Cimzia or CZP or CDP870 or CDP-870 or 428863-50-7) <i>Indexes=SCI-EXPANDED, CPCI-S Timespan=All years</i>
# 1	9294	TS=(psoria* NEAR/2 (arthrit* or arthropath*)) <i>Indexes=SCI-EXPANDED, CPCI-S Timespan=All years</i>

Key

TS = topic tag; searches terms in title, abstract, author keywords and keywords plus fields.

* = truncation.

' ' = phrase search.

NEAR/2 = terms within two words of each other (any order).

SAME = terms within the same sentence.

Ongoing, unpublished or grey literature search strategies

ClinicalTrials.gov

<https://clinicaltrials.gov/>

Date searched: 7 December 2015.

Records retrieved: 99.

The searches were updated on 28 April 2016 and retrieved 110 records.

Search strategy

1. **Six studies found for:** ((psoriatic arthritis OR psoriatic arthropathy) AND (Certolizumab OR Cimzia OR CZP OR CDP870 OR CDP-870 OR 428863-50-7))
2. **Eleven studies found for:** ((psoriatic arthritis OR psoriatic arthropathy) AND (secukinumab OR Cosentyx OR AIN457 OR AIN-457 OR 1229022-83-6))
3. **Thirteen studies found for:** (psoriatic arthritis OR psoriatic arthropathy) AND (golimumab OR simponi OR CNTO148 OR CNTO-148 OR 476181-74-5) | received from 1 January 2010 to 7 December 2015
4. **Two studies found for:** (psoriatic arthritis OR psoriatic arthropathy) AND (apremilast OR otezla OR otezia OR CC10004 OR CC-10004 OR 608141-41-9) | received from 1 January 2014 to 7 December 2015
5. **Three studies found for:** (psoriatic arthritis OR psoriatic arthropathy) AND (ustekinumab OR stelara OR CNTO1275 OR CNTO-1275 OR 815610-63-0) | received from 1 January 2012 to 7 December 2015
6. **Two studies found for:** (psoriatic arthritis OR psoriatic arthropathy) AND (inflectra OR remsima OR CT-P13)
7. **Eighteen studies found for:** (psoriatic arthritis OR psoriatic arthropathy) AND (etanercept OR enbrel OR 185243-69-0) | received from 1 January 2009 to 7 December 2015
8. **Eleven studies found for:** (psoriatic arthritis OR psoriatic arthropathy) AND (infliximab OR remicade OR 170277-31-3) | received from 1 January 2009 to 7 December 2015
9. **Thirty-three studies found for:** (psoriatic arthritis OR psoriatic arthropathy) AND (adalimumab OR humira OR D2E7 OR D2-E7 OR 331731-18-1) | received from 1 January 2009 to 7 December 2015

Conference Proceedings Citation Index: Science

Via Web of Science, Thomson Reuters: <http://thomsonreuters.com/thomson-reuters-web-of-science/>

Date range searched: 1990 to 28 November 2015.

Date searched: 1 December 2015.

Records retrieved: 712.

See above under SCI for search strategy used. As both databases were searched together the records retrieved refers to results from both databases.

The search was updated on 28 April 2016 and retrieved 796 records from both databases.

EU Clinical Trials Register

www.clinicaltrialsregister.eu/ctr-search/search

Date searched: 7 December 2015.

Records retrieved: 29.

The searches were updated on 28 April 2016 and retrieved two new records.

Search strategy

1. **Thirteen result(s) found for:** (psoriatic arthritis OR psoriatic arthropathy) AND (Certolizumab OR Cimzia OR CZP OR CDP870 OR CDP-870 OR 428863-50-7 OR secukinumab OR Cosentyx OR AIN457 OR AIN-457 OR 1229022-83-6 OR inflectra OR remsima OR CT-P13)
2. **Four result(s) found for:** (psoriatic arthritis OR psoriatic arthropathy) AND (golimumab OR simponi OR CNTO148 OR CNTO-148 OR 476181-74-5) date limit 01/01/2010-07/12/2015
3. **No result(s) found for:** (psoriatic arthritis OR psoriatic arthropathy) AND (apremilast OR otezla OR otezia OR CC10004 OR CC-10004 OR 608141-41-9) date limits – 01/01/2014-07/12/2015
4. **Three result(s) found for:** (psoriatic arthritis OR psoriatic arthropathy) AND (ustekinumab OR stelara OR CNTO1275 OR CNTO-1275 OR 815610-63-0) date limits 01/01/2012-07/12/2015
5. **Nine result(s) found for:** (psoriatic arthritis OR psoriatic arthropathy) AND (etanercept OR enbrel OR 185243-69-0 OR infliximab OR remicade OR 170277-31-3 OR adalimumab OR humira OR D2E7 OR D2-E7 OR 331731-18-1) date limits 01/01/2009-07/12/2015

PROSPERO

www.crd.york.ac.uk/PROSPERO/

Date searched: 4 December 2015.

Records retrieved: 25.

Search: psoriatic arthritis in all fields.

The search was updated on 28 April 2016 and retrieved nine new records.

World Health Organization's International Clinical Trials Registry Platform

www.who.int/ictrp/search/en/

Date searched: 7 December 2015.

Records retrieved: 113.

The searches were updated on 28 April 2016 and retrieved five new records.

Search strategy

1. Condition: (psoriatic arthritis OR psoriatic arthropathy) AND Intervention: (Certolizumab OR Cimzia OR CZP OR CDP870 OR CDP-870 OR 428863-50-7 OR secukinumab OR Cosentyx OR AIN457 OR AIN-457 OR 1229022-83-6 OR inflectra OR remsima OR CT-P13)
Twenty-nine trials found.
2. Condition: (psoriatic arthritis OR psoriatic arthropathy) AND Intervention: (golimumab OR simponi OR CNTO148 OR CNTO-148 OR 476181-74-5) limits 1 January 2010 to 7 December 2015
Sixteen trials found.
3. Condition: (psoriatic arthritis OR psoriatic arthropathy) AND Intervention: (apremilast or otezla or otezia or CC10004 or CC-10004 or 608141-41-9) limits 1 January 2014 to 7 December 2015
No records found.
4. Condition: (psoriatic arthritis OR psoriatic arthropathy) AND Intervention: (ustekinumab or stelara or CNTO1275 or CNTO-1275 or 815610-63-0) limits 1 January 2012 to 7 December 2015
Two trials found.
5. Condition: (psoriatic arthritis OR psoriatic arthropathy) AND Intervention: (etanercept OR enbrel OR 185243-69-0 OR infliximab OR remicade OR 170277-31-3 OR adalimumab OR humira OR D2E7 OR D2-E7 OR 331731-18-1) limits 1 January 2009 to 7 December 2015
Eighty-six trials found.

Extra searches for systematic reviews

As DARE ceased at the end of March 2015, searches for systematic reviews were carried out on MEDLINE and EMBASE to ensure that any relevant systematic reviews were identified.

EMBASE

Via Ovid: <http://ovidsp.ovid.com/>

Date range searched: 1974 to 30 November 2015.

Date searched: 1 December 2015.

Records retrieved: 82.

The following strategy includes a search strategy designed to locate reviews for DARE in Ovid EMBASE (see lines 35–129).¹⁵⁰

The search was updated on 28 April 2016 and retrieved 139 records.

Search strategy

1. psoriatic arthritis/ (13,050)
2. (psoria\$ adj2 (arthrit\$ or arthropath\$)).ti,ab. (11,246)
3. 1 or 2 (15,353)
4. certolizumab pegol/ (3506)
5. (Certolizumab or Cimzia or CZP or CDP870 or CDP-870 or 428863-50-7).af. (4212)
6. 4 or 5 (4212)
7. 3 and 6 (548)
8. secukinumab/ (601)
9. (secukinumab or Cosentyx or AIN457 or AIN-457 or 1229022-83-6).af. (679)
10. 8 or 9 (679)
11. 3 and 10 (199)
12. golimumab/ (2969)
13. (golimumab or simponi or CNTO148 or CNTO-148 or 476181-74-5).af. (3054)
14. 12 or 13 (3054)
15. 3 and 14 (806)
16. apremilast/ (456)
17. (apremilast or otezla or otezia or CC10004 or CC-10004 or 608141-41-9).af. (490)
18. 16 or 17 (490)
19. 3 and 18 (231)
20. ustekinumab/ (2445)
21. (ustekinumab or stelara or CNTO1275 or CNTO-1275 or 815610-63-0).af. (2559)
22. 20 or 21 (2559)
23. 3 and 22 (754)
24. (inflectra or remsima or CT-P13).af. (123)
25. 3 and 24 (21)
26. etanercept/ (21,668)
27. (etanercept or enbrel or 185243-69-0).af. (22,500)
28. infliximab/ (33,968)
29. (infliximab or remicade or 170277-31-3).af. (34,643)
30. adalimumab/ (18,932)
31. (adalimumab or humira or D2E7 or (D2 adj E7) or 331731-18-1).af. (19,317)
32. or/26-31 (47,513)

33. 3 and 32 (4302)
34. 7 or 11 or 15 or 19 or 23 or 25 or 33 (4863)
35. systematic\$ review\$.ti,ab. (95,091)
36. systematic\$ literature review\$.ti,ab. (6884)
37. 'systematic review'/(98,895)
38. 'systematic review (topic)'/(13,418)
39. meta analysis/(102,483)
40. 'meta analysis (topic)'/(23,719)
41. meta-analytic\$.ti,ab. (5089)
42. meta-analysis.ti,ab. (92,607)
43. metanalysis.ti,ab. (351)
44. metaanalysis.ti,ab. (4420)
45. meta analysis.ti,ab. (92,607)
46. meta-synthesis.ti,ab. (333)
47. metasynthesis.ti,ab. (173)
48. meta synthesis.ti,ab. (333)
49. meta-regression.ti,ab. (4113)
50. metaregression.ti,ab. (569)
51. meta regression.ti,ab. (4113)
52. (synthes\$ adj3 literature).ti,ab. (2047)
53. (synthes\$ adj3 evidence).ti,ab. (5649)
54. (synthes\$ adj2 qualitative).ti,ab. (939)
55. integrative review.ti,ab. (1084)
56. data synthesis.ti,ab. (10,020)
57. (research synthesis or narrative synthesis).ti,ab. (1100)
58. (systematic study or systematic studies).ti,ab. (9606)
59. (systematic comparison\$ or systematic overview\$).ti,ab. (2447)
60. (systematic adj2 search\$).ti,ab. (14,698)
61. systematic\$ literature research\$.ti,ab. (172)
62. (review adj3 scientific literature).ti,ab. (1182)
63. (literature review adj2 side effect\$).ti,ab. (11)
64. (literature review adj2 adverse effect\$).ti,ab. (2)
65. (literature review adj2 adverse event\$).ti,ab. (9)
66. (evidence-based adj2 review).ti,ab. (2599)
67. comprehensive review.ti,ab. (9891)
68. critical review.ti,ab. (13,722)
69. critical analysis.ti,ab. (6783)
70. quantitative review.ti,ab. (596)
71. structured review.ti,ab. (712)
72. realist review.ti,ab. (93)
73. realist synthesis.ti,ab. (61)
74. (pooled adj2 analysis).ti,ab. (10,726)
75. (pooled data adj6 (studies or trials)).ti,ab. (1727)
76. (medline and (inclusion adj3 criteria)).ti,ab. (13,602)
77. (search adj (strateg\$ or term\$)).ti,ab. (23,159)
78. or/35-77 (313,391)
79. medline.ab. (82,933)
80. pubmed.ab. (59,842)
81. cochrane.ab. (49,544)
82. embase.ab. (49,331)
83. cinahl.ab. (14,619)
84. psyc?lit.ab. (963)
85. psyc?info.ab. (11,667)

86. lilacs.ab. (4162)
87. (literature adj3 search\$.ab. (41,110)
88. (database\$ adj3 search\$.ab. (38,127)
89. (bibliographic adj3 search\$.ab. (1761)
90. (electronic adj3 search\$.ab. (13,296)
91. (electronic adj3 database\$.ab. (18,556)
92. (computeri?ed adj3 search\$.ab. (3348)
93. (internet adj3 search\$.ab. (2745)
94. included studies.ab. (12,116)
95. (inclusion adj3 studies).ab. (10,022)
96. inclusion criteria.ab. (73,458)
97. selection criteria.ab. (23,235)
98. predefined criteria.ab. (1684)
99. predetermined criteria.ab. (980)
100. (assess\$ adj3 (quality or validity)).ab. (62,963)
101. (select\$ adj3 (study or studies)).ab. (56,413)
102. (data adj3 extract\$.ab. (46,092)
103. extracted data.ab. (9890)
104. (data adj2 abstracted).ab. (5666)
105. (data adj3 abstraction).ab. (1428)
106. published intervention\$.ab. (148)
107. ((study or studies) adj2 evaluat\$.ab. (168,567)
108. (intervention\$ adj2 evaluat\$.ab. (9530)
109. confidence interval\$.ab. (302,095)
110. heterogeneity.ab. (130,769)
111. pooled.ab. (71,894)
112. pooling.ab. (10,965)
113. odds ratio\$.ab. (209,779)
114. (Jadad or coding).ab. (151,963)
115. evidence-based.ti.ab. (89,257)
116. or/79-115 (1,249,442)
117. review.pt. (2,121,803)
118. 116 and 117 (155,285)
119. review.ti. (354,800)
120. 116 and 119 (79,064)
121. (review\$ adj10 (papers or trials or trial data or studies or evidence or intervention\$ or evaluation\$ or outcome\$ or findings)).ti.ab. (349,461)
122. (retriev\$ adj10 (papers or trials or studies or evidence or intervention\$ or evaluation\$ or outcome\$ or findings)).ti.ab. (17,449)
123. 78 or 118 or 120 or 121 or 122 (648,468)
124. letter.pt. (918,884)
125. editorial.pt. (497,918)
126. 124 or 125 (1,416,802)
127. 123 not 126 (636,540)
128. (animal/ or nonhuman/) not exp human/ (4,935,282)
129. 127 not 128 (611,316)
130. 34 and 129 (558)
131. 2015\$.em. (1,962,120)
132. 130 and 131 (82)

Key

/ = indexing term (Emtree heading).

exp = exploded indexing term (Emtree heading).

\$ = truncation.

? = optional wildcard – one or no characters.

ti,ab = terms in either title or abstract fields.

af = all fields.

pt = publication type.

sh = subject heading field.

adj2 = terms within two words of each other (any order).

em = entry week – date added to the database.

MEDLINE

Via Ovid: <http://ovidsp.ovid.com/>

Date range searched: 1946 to November week 3 2015.

Date searched: 1 December 2015.

Records retrieved: nine.

The following strategy includes a search strategy designed to locate reviews for DARE in Ovid MEDLINE (see lines 22–98).¹⁵⁰

The search was updated on 28 April 2016 and retrieved 25 records.

Search strategy

1. Arthritis, Psoriatic/ (4144)
2. (psoria\$ adj2 (arthrit\$ or arthropath\$)).ti,ab. (6043)
3. 1 or 2 (6887)
4. (Certolizumab or Cimzia or CZP or CDP870 or CDP-870 or 428863-50-7).af. (763)
5. 3 and 4 (53)
6. (secukinumab or Cosentyx or AIN457 or AIN-457 or 1229022-83-6).af. (88)
7. 3 and 6 (18)
8. (golimumab or simponi or CNTO148 or CNTO-148 or 476181-74-5).af. (431)
9. 3 and 8 (104)
10. (apremilast or otezla or otezia or CC10004 or CC-10004 or 608141-41-9).af. (92)
11. 3 and 10 (29)
12. (ustekinumab or stelara or CNTO1275 or CNTO-1275 or 815610-63-0).af. (536)
13. 3 and 12 (114)
14. (inflectra or remsima or CT-P13).af. (17)
15. 3 and 14 (1)
16. (etanercept or enbrel or 185243-69-0).af. (5831)

17. (infliximab or remicade or 170277-31-3).af. (9674)
18. (adalimumab or humira or D2E7 or (D2 adj E7) or 331731-18-1).af. (4205)
19. 16 or 17 or 18 (14,458)
20. 3 and 19 (1129)
21. 5 or 7 or 9 or 11 or 13 or 15 or 20 (1267)
22. systematic\$ review\$.ti,ab. (62,767)
23. meta-analysis as topic/ (15,063)
24. meta-analytic\$.ti,ab. (3875)
25. meta-analysis.ti,ab,pt. (80,432)
26. metanalysis.ti,ab. (130)
27. metaanalysis.ti,ab. (1122)
28. meta analysis.ti,ab. (61,044)
29. meta-synthesis.ti,ab. (245)
30. metasynthesis.ti,ab. (143)
31. meta synthesis.ti,ab. (245)
32. meta-regression.ti,ab. (2799)
33. metaregression.ti,ab. (315)
34. meta regression.ti,ab. (2799)
35. (synthes\$ adj3 literature).ti,ab. (1446)
36. (synthes\$ adj3 evidence).ti,ab. (4369)
37. integrative review.ti,ab. (943)
38. data synthesis.ti,ab. (7556)
39. (research synthesis or narrative synthesis).ti,ab. (821)
40. (systematic study or systematic studies).ti,ab. (6891)
41. (systematic comparison\$ or systematic overview\$).ti,ab. (1891)
42. evidence based review.ti,ab. (1253)
43. comprehensive review.ti,ab. (6999)
44. critical review.ti,ab. (10,688)
45. quantitative review.ti,ab. (474)
46. structured review.ti,ab. (490)
47. realist review.ti,ab. (58)
48. realist synthesis.ti,ab. (44)
49. or/22-48 (164,741)
50. review.pt. (2,034,742)
51. medline.ab. (60,574)
52. pubmed.ab. (36,054)
53. cochrane.ab. (34,003)
54. embase.ab. (33,609)
55. cinahl.ab. (11,111)
56. psyc?lit.ab. (871)
57. psyc?info.ab. (7994)
58. (literature adj3 search\$.ab. (27,401)
59. (database\$ adj3 search\$.ab. (26,195)
60. (bibliographic adj3 search\$.ab. (1303)
61. (electronic adj3 search\$.ab. (9505)
62. (electronic adj3 database\$.ab. (11,568)
63. (computeri?ed adj3 search\$.ab. (2654)
64. (internet adj3 search\$.ab. (1771)
65. included studies.ab. (7960)
66. (inclusion adj3 studies).ab. (7019)
67. inclusion criteria.ab. (37,933)
68. selection criteria.ab. (21,191)
69. predefined criteria.ab. (1159)

70. predetermined criteria.ab. (756)
71. (assess\$ adj3 (quality or validity)).ab. (42,982)
72. (select\$ adj3 (study or studies)).ab. (39,117)
73. (data adj3 extract\$.ab. (31,055)
74. extracted data.ab. (7660)
75. (data adj2 abstracted).ab. (3467)
76. (data adj3 abstraction).ab. (878)
77. published intervention\$.ab. (108)
78. ((study or studies) adj2 evaluat\$.ab. (110,270)
79. (intervention\$ adj2 evaluat\$.ab. (6324)
80. confidence interval\$.ab. (243,474)
81. heterogeneity.ab. (97,658)
82. pooled.ab. (48,633)
83. pooling.ab. (7960)
84. odds ratio\$.ab. (161,734)
85. (Jadad or coding).ab. (123,582)
86. or/51-85 (846,853)
87. 50 and 86 (138,063)
88. review.ti. (262,483)
89. 88 and 86 (51,780)
90. (review\$ adj4 (papers or trials or studies or evidence or intervention\$ or evaluation\$)).ti,ab. (105,599)
91. 49 or 87 or 89 or 90 (305,581)
92. letter.pt. (928,972)
93. editorial.pt. (379,192)
94. comment.pt. (631,763)
95. 92 or 93 or 94 (1,437,876)
96. 91 not 95 (297,485)
97. exp animals/ not humans/ (4,152,952)
98. 96 not 97 (287,212)
99. 21 and 98 (96)
100. 2015\$.ed. (777,364)
101. 99 and 100 (9)

Key

/ = indexing term (MeSH heading).

exp = exploded indexing term (MeSH heading).

\$ = truncation.

? = optional wildcard – one or no characters.

ti,a. = terms in either title or abstract fields.

af = terms in any field.

ed = entry date – date added to the database.

pt = publication type.

adj = terms next to each other (order specified).

Appendix 2 Inclusion and exclusion criteria of the included studies

Study and drug	Inclusion criteria	Exclusion criteria
FUTURE 2; ⁴⁸ SEC	<ul style="list-style-type: none"> Active PsA with three or more tender and swollen joints and met the CASPAR, despite previous treatment with NSAIDs, DMARDs or anti-TNFs Concomitant oral corticosteroids (≤ 10 mg/day prednisone or equivalent) and MTX (≤ 25 mg/week) were allowed provided the dose was stable for at least 2 weeks and at least 4 weeks before randomisation 	<ul style="list-style-type: none"> Previously received biologic immunomodulating agents, except for those targeting TNF Previously been treated with three or more different TNF inhibitors Ongoing use of prohibited psoriasis treatments/medications (e.g. topical corticosteroids, ultraviolet therapy) at randomisation [the following washout periods were required to be observed: oral or topical retinoids 4 weeks; photochemotherapy 4 weeks; phototherapy 2 weeks; topical skin treatments (except in face, eyes, scalp, and genital area during screening, only corticosteroids with mild to moderate potency) 2 weeks] Active, ongoing inflammatory diseases other than PsA Active TB (patients with latent TB had to commence treatment for latent TB before study entry) A history of hepatitis B or C, human immunodeficiency virus, or any active systemic infection within the 2 weeks before baseline History of ongoing, chronic or recurrent infections, or evidence of active TB infection History of malignancy within the past 5 years (except for basal cell carcinoma or actinic keratosis that has been treated with no evidence of recurrence in the past 3 months, in situ cervical cancer or non-invasive malignant colon polyps that had been removed) Underlying metabolic, haematological, renal, hepatic, pulmonary, neurological, endocrine, cardiac, infectious or gastrointestinal conditions which, in the opinion of the investigator, immunocompromised the patient and/or placed the patient at unacceptable risk for participation Pregnant or nursing (lactating) women and women of child-bearing potential unwilling to use effective contraception during the study and for 16 weeks after stopping treatment
ERASURE; ^{49,151} SEC	<ul style="list-style-type: none"> Moderate and severe plaque-type psoriasis diagnosed for at least 6 months Severity of psoriasis disease meeting all of the following three criteria: <ul style="list-style-type: none"> PASI score of ≥ 12 units Investigator's Global Assessment score of ≥ 3 total BSA affected of $\geq 10\%$ Inadequate control by prior use of topical treatment, phototherapy and/or systemic therapy 	<ul style="list-style-type: none"> Current forms of psoriasis other than chronic plaque-type psoriasis (e.g. pustular, erythrodermic, guttate) Current drug-induced psoriasis Previous use of SEC or any drug that targets IL-17 or the IL-17 receptor MTX, ciclosporin A, corticosteroids, cyclophosphamide Significant medical problems such as uncontrolled hypertension, congestive heart failure or a condition that significantly immunocompromises the subject Haematological abnormalities

Study and drug	Inclusion criteria	Exclusion criteria
FIXTURE, ^{49,151} SEC	<ul style="list-style-type: none"> Moderate and severe plaque-type psoriasis diagnosed for at least 6 months Severity of psoriasis disease meeting all of the following three criteria: <ul style="list-style-type: none"> PASI score of ≥ 12 units Investigator's Global Assessment score of ≥ 3 total BSA affected of $\geq 10\%$ Inadequate control by prior use of topical treatment, phototherapy and/or systemic therapy 	<ul style="list-style-type: none"> History of an ongoing, chronic or recurrent infectious disease, or evidence of untreated TB History of lymphoproliferative disease or history of malignancy of any organ system within the past 5 years Pregnant or nursing (lactating) women Subjects not willing to limit ultraviolet light exposure during the study Previous use of ETN Current forms of psoriasis other than chronic plaque-type psoriasis (e.g. pustular, erythrodermic, guttate) Current drug-induced psoriasis Previous use of SEC or any drug that targets IL-17 or the IL-17 receptor MTX, ciclosporin A, corticosteroids, cyclophosphamide Significant medical problems such as uncontrolled hypertension, congestive heart failure or a condition that significantly immunocompromises the subject Haematological abnormalities History of an ongoing, chronic or recurrent infectious disease, or evidence of untreated TB History of lymphoproliferative disease or history of malignancy of any organ system within the past 5 years Pregnant or nursing (lactating) women Subjects not willing to limit ultraviolet light exposure during the study
CLEAR, ^{62,63} SEC	<ul style="list-style-type: none"> Moderate and severe plaque-type psoriasis diagnosed for at least 6 months Patients eligible for systemic therapy with inadequately controlled psoriasis 	<ul style="list-style-type: none"> Forms of psoriasis other than plaque-type psoriasis Previous exposure to SEC, UST, or other biologic drugs targeting IL-17A or IL-17 receptor A
*SPIRIT-P1, ^{57,67} ADA	<ul style="list-style-type: none"> Presents with established diagnosis of active PsA for at least 6 months, and currently meets CASPAR Active PsA defined as the presence of at least three tender and at least three swollen joints Presence of active psoriatic skin lesion or a history of plaque psoriasis Men must agree to use a reliable method of birth control or remain abstinent during the study Women must agree to use reliable birth control or remain abstinent during the study and for at least 12 weeks after stopping treatment 	<ul style="list-style-type: none"> Current or prior use of biologic agents for treatment of plaque psoriasis or PsA Inadequate response to four or more cDMARDs Current use of more than one cDMARD Evidence of active inflammatory arthritic syndromes or spondyloarthropathies other than PsA Have participated in any study with IL-17 antagonists, including ixekizumab Serious disorder or illness other than PsA Serious infection within the last 3 months Breastfeeding or nursing (lactating) women
RAPID-PsA; ⁴⁷ CZP	<ul style="list-style-type: none"> Active PsA for at least 6 months defined by the CASPAR Active joint disease, defined as three or more tender and swollen joints <p>An ESR of ≥ 28 mm/hour (Westergren) or a CRP concentration greater than the upper limit of normal (7.9 mg/l)</p> <ul style="list-style-type: none"> Have previously failed one or more DMARD Active psoriatic skin lesions or a documented history of psoriasis 	<ul style="list-style-type: none"> Latent or active TB unless prophylactic treatment of latent TB had begun ≥ 4 weeks prior to baseline Chronic or clinically significant infections, malignancy, or demyelinating disease of the central nervous system Previous exposure to two or more biologics or one or more TNF inhibitors for the treatment of PsA or psoriasis, or primary failure of a prior TNF inhibitor (defined as no response within the first 12 weeks of treatments with the anti-TNF) according to investigator assessment

Study and drug	Inclusion criteria	Exclusion criteria
	<ul style="list-style-type: none"> Concomitant MTX (≤ 25 mg/week), sulfasalazine (≤ 3 g/day), leflunomide (≤ 20 mg/day) or prednisone (≤ 10 mg/day) were allowed provided the dose was stable and started ≥ 28 days before the baseline visit 	<ul style="list-style-type: none"> Diagnosis of any other inflammatory arthritis The use of DMARDs other than MTX, sulfasalazine, leflunomide, or intra-articular corticosteroids, was prohibited within 28 days of the baseline visit and during the trial Use of combinations of MTX, sulfasalazine and leflunomide was not permitted Concurrent use of topical, systemic or phototherapy treatments was not permitted up to week 48 of the study
PALACE 1, 2, 3, ^{60,61,65} APR	<ul style="list-style-type: none"> Three or more tender and swollen joints CASPAR Stable dose (oral or parenteral MTX ≤ 25 mg/week; leflunomide ≤ 20 mg/day; sulfasalazine ≤ 2 g/day; or a combination) for at least 4 weeks before the screening visit Prednisone ≤ 10 mg/day or equivalent for at least 1 month NSAIDs ≥ 2 weeks At least one ≥ 2-cm plaque psoriasis lesion^b 	<ul style="list-style-type: none"> Three or more agents for PsA (DMARDs or biologics) or one or more anti-TNF History of or current <ul style="list-style-type: none"> i. inflammatory rheumatic or autoimmune joint disease other than PsA ii. erythrodermic guttate or generalised pustular psoriasis iii. were functional class IV, defined by the ACR Classification of Functional Status in Rheumatoid Arthritis iv. had used phototherapy or DMARDs other than MTX, leflunomide or sulfasalazine within 4 weeks of randomisation v. had used ADA, ETN, GOL, INF, CZP or tocilizumab within 12 weeks of randomisation or alefacept or UST within 24 weeks of randomisation vi. had prior treatment with APR Topical therapy for psoriasis within 2 weeks Patients with active TB or a history of incompletely treated TB
PSUMMIT 2, ^{59,66} UST	<ul style="list-style-type: none"> ≥ 3 months (DMARD) therapy, ≥ 4 weeks (NSAIDs) therapy and/or ≥ 8 (ETN, ADA, GOL, CZP) or 14 (INF) continuous weeks $\geq 5/66$ swollen and $\geq 5/68$ tender joints A CRP concentration of ≥ 6.0 mg/l (modified to ≥ 3.0 mg/l after study start, upper limit of normal 10 mg/l) Active/documented history of plaque psoriasis Concomitant MTX was permitted if started ≥ 3 months prior to study start and at a stable dose (≤ 25 mg/week) for ≥ 4 weeks 	<ul style="list-style-type: none"> Have other inflammatory diseases, including but not limited to RA, ankylosing spondylitis, systemic lupus erythematosus or Lyme disease Have used any therapeutic agent targeted at reducing IL-12 or IL-23 agent or abatacept Have a medical history of latent or active granulomatous infection, including TB, histoplasmosis or coccidioidomycosis, prior to screening Have any known malignancy or have a history of malignancy (with the exception of basal cell carcinoma, squamous cell carcinoma in situ of the skin, or cervical carcinoma in situ) that has been treated with no evidence of recurrence, or squamous cell carcinoma of the skin that has been treated with no evidence of recurrence within 5 years of the beginning of the study
PSUMMIT 1, ⁶⁶ UST	<ul style="list-style-type: none"> ≥ 5 tender and swollen joints, a CRP concentration of ≥ 3.0 mg/l, documented history of plaque psoriasis MTX ≤ 25 mg/week at least 3 months prior If currently not using MTX, must have not received MTX for at least 4 weeks prior to the first administration of the study agent 	<ul style="list-style-type: none"> Have other inflammatory diseases, including but not limited to RA, ankylosing spondylitis, systemic lupus erythematosus, or Lyme disease Have used any therapeutic agent targeted at reducing IL-12 or IL-23, including but not limited to UST and briakinumab (ABT-874) Have used any biologic agents that are targeted for reducing TNF-α, including but not limited to INF, ETN, ADA and GOL Have a medical history of latent or active granulomatous infection

Study and drug	Inclusion criteria	Exclusion criteria
Atteno <i>et al.</i> , 2010; ⁶⁴ ETN vs. ADA vs. INF	<ul style="list-style-type: none"> • Patients aged > 18 years with active PsA who experienced an inadequate response to a previous DMARD therapy • CASPAR 	<ul style="list-style-type: none"> • Have any known malignancy or have a history of malignancy (with the exception of basal cell carcinoma, squamous cell carcinoma in situ of the skin, or cervical carcinoma in situ) that has been treated with no evidence of recurrence, or squamous cell carcinoma of the skin that has been treated with no evidence of recurrence within 5 years of the beginning of the study • Previous usage of anti-TNF-α inhibitors • The usage of DMARDs other than sulfasalazine, MTX, azathioprine, and leflunomide within 4 weeks of enrolment • The usage of > 10 mg prednisone daily • Variation of dosage of NSAIDs or prednisone within 2 weeks of enrolment
GO-REVEAL, ⁵⁰ GOL	<ul style="list-style-type: none"> • Three or more swollen joints and three tender joints • Negative rheumatoid factor, at least one subset of PsA and the presence of plaque psoriasis with a qualifying lesion at least 2 cm in diameter • Previous use of anti-TNF agents, rituximab, natalizumab, or cytotoxic agents was prohibited • Stable doses of MTX, NSAIDs and corticosteroids (prednisone 10 mg/day) were allowed • Patients with latent TB could participate if they were treated for latent TB prior to or concurrent with administration of the study agent 	<ul style="list-style-type: none"> • No prior treatment with biologic anti-TNF agents (INF, ETN, ADA) • No treatment with alefacept or efalizumab within 3 months prior to the first study drug injection • No DMARDs other than MTX, or immunosuppressive drugs within 4 weeks prior to the first study drug injection
Genovese <i>et al.</i> , 2007; ⁵⁶ ADA	<ul style="list-style-type: none"> • Three or more swollen and tender joints • Plaque psoriasis • Had received/receiving concomitant DMARD therapy or had a history of DMARD therapy with an inadequate response • Prednisone \leq 10 mg/day and had been stable • Stable dose of MTX \leq 30 mg/week and other DMARDs except ciclosporin and tacrolimus was allowed if within 4 weeks of the baseline visit 	<ul style="list-style-type: none"> • History of previous anti-TNF therapy • Intra-articular injections or i.v. infusions of corticosteroids within 4 weeks of baseline • Topical psoriasis therapies within 2 weeks of baseline • Ultraviolet A phototherapy, using tanning booth within 2 weeks • Oral retinoids within 4 weeks • Alefacept or siplizumab within 12 weeks • Any other biologic or investigational therapy within 6 weeks • Currently using or likely to need antiretroviral therapy • Patients with persistent or severe infections or a history of active TB, or who had an active non-psoriatic skin disease • Significant history of cardiac, renal, neurological, psychiatric, endocrinological, metabolic, or hepatic disease; neurological symptoms suggestive of central nervous system demyelinating disease; and a history of malignancy other than carcinoma in situ of the cervix or adequately treated non-metastatic squamous or basal cell skin carcinoma

Study and drug	Inclusion criteria	Exclusion criteria
ADEPT; ⁵⁵ ADA	<ul style="list-style-type: none"> • Three or more swollen and tender joints • Patients required to have inadequate response or intolerance to NSAIDs • MTX was allowed only if it had been taken for at least 3 months with the dosage stable for at least 4 weeks prior to the baseline visit 	<ul style="list-style-type: none"> • Treatment within 4 weeks of the baseline visit with ciclosporin, tacrolimus, DMARDs other than MTX or oral retinoids • Topical treatments for psoriasis within 2 weeks of baseline, other than medicated shampoos or low-potency topical steroids • Concurrent treatment with MTX at dosages > 30 mg/week and/or corticosteroids in a prednisone-equivalent dosage of > 10 mg/day • Anti-TNF therapy • History of neurological symptoms suggestive of central nervous system demyelinating disease, a history of active TB or listeriosis, or the presence of a severe infection requiring hospitalisation or treatment with i.v. antibiotics within 30 days or oral antibiotics within 14 days of study entry
IMPACT; ⁵¹ INF	<p>Diagnosed PsA for ≥ 6 months</p> <ul style="list-style-type: none"> • Previous failure of treatment with one or more DMARDs • Active arthritis with five or more tender and swollen joints <p>An ESR of ≥ 28 mm/hour, a CRP concentration of ≥ 15 mg/l, and/or morning stiffness lasting ≥ 45 minutes</p> <ul style="list-style-type: none"> • Negative results of serum tests for rheumatoid factor and negative results for active or latent TB • Patients were allowed to receive concomitant therapy with one of the following DMARDs: MTX (dosage of ≥ 15 mg/week, with folic acid supplementation), leflunomide, sulfasalazine, hydroxychloroquine, intramuscular gold, penicillamine, or azathioprine • Standard topical treatments for psoriatic lesions (e.g. topical steroids) were permitted 	<ul style="list-style-type: none"> • Use of intramuscular or i.v. corticosteroids, ciclosporin, or tacrolimus within 4 weeks of screening and throughout the study • Therapy with psoralen ultraviolet A • Received any investigational drug within 3 months of screening or any previous treatment with a monoclonal antibody or fusion protein
IMPACT 2; ⁵² INF	<ul style="list-style-type: none"> • Diagnosed PsA for ≥ 6 months • Active arthritis with five or more tender and swollen joints • CRP concentrations of at least 15 mg/l and/or morning stiffness lasting ≥ 45 minutes • Inadequate response to current or previous DMARDs or NSAIDs • Active plaque psoriasis with at least one qualifying target lesion at least 2 cm in diameter • Negative test for rheumatoid factor in their serum • Concurrent use of topical or systemic drugs/ treatments for psoriasis was not permitted during the study except low-potency topical corticosteroids on the face or groin 	<ul style="list-style-type: none"> • Evidence of latent or active TB • Had chronic or clinically significant infection, malignancy, or congestive heart failure; or if they had used TNF-α inhibitors previously • Concomitant MTX treatment ≥ 25 mg/week and > 10 mg prednisone • DMARDs (other than MTX) or intra-articular corticosteroids within 4 weeks prior to enrolment in the study and DMARD use other than MTX was not allowed during the trial

Study and drug	Inclusion criteria	Exclusion criteria
Mease <i>et al.</i> 2004; ⁵⁴ ETN	<ul style="list-style-type: none"> ● Active PsA with three or more swollen and tender joints ● Inadequate response to NSAIDs ● Had at least one of the following clinical subtypes of PsA: distal interphalangeal joint involvement, polyarticular arthritis (absence of rheumatoid nodules and presence of psoriasis), arthritis mutilans, asymmetrical peripheral arthritis, or ankylosing spondylitis-like arthritis ● Plaque psoriasis with a qualifying lesion at least 2 cm in diameter <p>Concomitant MTX, a stable dosage of ≤ 25 mg/week and prednisolone ≤ 10 mg/day</p> <ul style="list-style-type: none"> ● Discontinued other DMARDs at least 4 weeks before the study 	<ul style="list-style-type: none"> ● Phototherapy was discontinued at least 2 weeks before the study start. Oral retinoids, topical vitamin A or D analogue preparations, and dithranol were not allowed. Topical therapies were permitted on the scalp, axillae and groin only ● Significant concurrent medical diseases including: <ul style="list-style-type: none"> ○ diabetes mellitus requiring insulin ○ uncompensated congestive heart failure ○ myocardial infarction within 12 months of screening visit ○ unstable or stable angina pectoris ○ uncontrolled hypertension ○ severe pulmonary disease (requiring medical or oxygen therapy) ○ history of cancer (other than resected cutaneous basal or squamous cell carcinoma or in situ cervical cancer) within 5 years of screening visit ○ HIV positive, hepatitis B surface antigen or hepatitis C positive ○ RA, systemic lupus, scleroderma or polymyositis ○ any condition judged by the subject's physician that would cause this study to be detrimental to the subject
Mease <i>et al.</i> , 2000; ⁵³ ETN	<ul style="list-style-type: none"> ● Active PsA with three or more swollen and tender joints ● Inadequate response to NSAIDs ● Patients taking MTX (≤ 25 mg/week) were allowed to continue MTX if the dose was stable for 4 weeks before study start and remained stable throughout the study ● ≤ 10 mg/day of prednisone, stable for at least 2 weeks before the first dose of study drug, and maintained at a constant dose throughout the study 	<ul style="list-style-type: none"> ● Current or history of psychiatric disease that would interfere with ability to comply with the study protocol or give informed consent ● History of alcohol or drug abuse that would interfere with ability to comply with the study protocol ● Evidence of skin conditions other than psoriasis (such as eczema) ● Other DMARDs (except MTX) were discontinued at least 2 weeks before beginning the study drug and were not allowed during the study ● Topical therapies and oral retinoids for psoriasis were discontinued at least 2 weeks before the baseline evaluation and phototherapy was discontinued at least 4 weeks

HIV, human immunodeficiency virus.

a Ixekizumab is not a treatment of interest, which is excluded from the remaining of the report.

b PALACE 3 only.

Appendix 3 Detailed evidence synthesis

Detailed evidence synthesis framework

The evidence synthesis was undertaken using WinBUGS (version 1.4.3). WinBUGS is a Bayesian analysis software tool that, through the use of Markov chain Monte Carlo, calculates posterior distributions for the parameters of interest given likelihood functions derived from data and prior probabilities (uninformative priors were used throughout). There were few individual studies on each treatment; therefore, fixed-effect models were used across studies in all analyses. Parameter estimates for all functional parameters were reported from the models. These differ by outcome, and further details are presented in the subsections that follow. Treatment effects were expressed in relation to placebo. Owing to the sparse evidence imposing a high level of uncertainty over estimates of functional parameters, point estimates are medians throughout. Some models assumed exchangeability across treatments within a class. Within such models we reported the estimates for each treatment (called shrunken estimates), rather than the class medians, allowing us to represent any residual differences across treatments.

All PsARC response, and HAQ-DI conditional on PsARC response, models were run for 20,000 iterations after a burn-in of 30,000 on two chains. All PASI response and ACR response models were run for 20,000 iterations after a burn-in of 50,000 on two chains. The level of credibility used was 95% (i.e. 95% CrIs). The DIC statistic, convergence and autocorrelation were all assessed and informed model selection. Thinning was considered where autocorrelation was high. Model fit statistics are reported in the form of DIC and residual deviance.

Data used for the ustekinumab (PSUMMIT) trials

The marketing authorisation for UST differs from that of the other biologics in terms of how long treatment should be continued before clinicians should consider stopping treatment. Although the recommendation for UST is for doctors to consider stopping treatment if there is no response after 28 weeks, for the other biologics the stopping time frames range between 12 and 16 weeks. However, the PSUMMIT trials^{58,59,66} had an early escape crossover design at week 16, just like several other trials included in the NMA (including the FUTURE 2⁴⁸ and RAPID-PsA trials⁴⁷). Using the post-early escape 24-week data from the PSUMMIT trials but pre-early escape data from the other trials would introduce methodological heterogeneity across treatments, which could potentially have implications on results. With this in mind we obtained 12-week data for the PSUMMIT trials via the YODA project (see *Chapter 3, Methods for reviewing clinical effectiveness*). Although biologic-naïve and biologic-experienced subgroup data were extracted for several relevant outcomes from the PSUMMIT clinical study reports, these subgroup data were not available for PsARC at 12 weeks for PSUMMIT 2,^{59,66} although they were available for the full population.

The data from YODA showed that results for the PsARC and HAQ-DI outcomes were very similar at 12 and 24 weeks in both PSUMMIT trials (*Table 121*).^{58,59,66} Conversely, the 12- and 24-week results appear different for the PASI outcomes, particularly at the higher thresholds. A similar pattern of results (when comparing 12 and 24 weeks) can be seen in the RAPID-PsA trial,⁴⁷ but is less evident in the SEC FUTURE 2 trial⁴⁸ (see *Table 121*). Some differences across treatments may be attributable to variations in analysis approaches used with respect to non-responder imputations in early escapers. It was also noted that in ADEPT,⁵⁵ which was placebo controlled and blinded up to 24 weeks without early escape, there was around a 10% increase in PASI 75 and PASI 90 response rates going from 12 to 24 weeks.

TABLE 121 The 12- and 24-week full population results across recent trials that used an early escape at 16 weeks design

Trial and arm	Outcome									
	PsARC		HAQ-DI (units) ^a		PASI 50		PASI 75		PASI 90	
	12 weeks	24 weeks	12 weeks	24 weeks	12 weeks	24 weeks	12 weeks	24 weeks	12 weeks	24 weeks
FUTURE 2, ⁴⁸ 150 mg of SEC	69	Confidential information has been removed	NR	-0.48	83	NR	53	43	33	33
FUTURE 2, ⁴⁸ 300 mg of SEC	72	Confidential information has been removed	NR	-0.56	83	NR	59	63	39	49
RAPID-PsA, ⁴⁷ CZP 200 mg	73	78	-0.45	-0.52	69	74	47	62	22	47
RAPID-PsA, ⁴⁷ CZP 400 mg	66	77	-0.39	-0.43	63	72	47	61	20	36
PSUMMIT 1, ^{58,66} 45 mg of UST	59	56	-0.28	-0.31	61	78	39	57	19	41
PSUMMIT 2, ^{59,66} 45 mg of UST	52	55	-0.21	-0.21	64	68	39	51	20	30

NR, not reported.

^a Change from baseline; results are % responders for all outcomes except HAQ-DI; for early escapers non-responder imputations were used for all treatment groups in the FUTURE 2 and PSUMMIT trials but for the placebo group only in the RAPID-PsA trial.

Based on these observations, and to allow our analyses to include subgroup data from both PSUMMIT trials,^{58,59,66} we used the 24-week PSUMMIT trial data for the analyses of PsARC and HAQ-DI, on the assumption that they fairly reflected the 12-week results. For the analyses of PASI and ACR outcomes (where the 12- and 24-week results differed), we used the 12-week data.

For completeness, and to allow comparison with the placebo groups and the 24-week data, the PsARC and HAQ-DI 12-week data for the PSUMMIT trial full populations are as follows: PSUMMIT 1,^{58,66} PsARC responders 121 of 205 for 45 mg of UST and 75 of 206 for placebo; HAQ-DI mean change from baseline -0.28 units (SD 0.487 units) for 45 mg of UST and -0.1 units (SD 0.384 units) for placebo; PSUMMIT 2,^{59,66} PsARC responders 54 of 103 for 45 mg of UST and 33 of 104 for placebo; HAQ-DI mean change from baseline -0.21 units (SD 0.472 units) for 45 mg of UST and -0.07 units (SD 0.398 units) for placebo.

Psoriatic Arthritis Response Criteria response

Detailed methods for the biologic-naïve subpopulation

Each trial reported the number of events (PsARC responses) in the placebo and the number of events under treatments (r_{it}), where i represents a trial ($i = 1, \dots, 14$) and t represents a treatment ($t = 1, \dots, 10$). Across all models, it was assumed that that r_{it} are binomially distributed, with probability parameter p_{it} representing the probability of an event (PsARC response) in treatment arm t of trial i . As the parameters of interest, p_{it} , are probabilities and, therefore, can take only values between 0 and 1, we modelled these on the logit scale (log-odds). We implemented separate models for the pooling of treatment effects and of placebo responses.

Treatment effect models

The treatment effect model assumed the baseline and treatment effects to be additive on the logit scale $\text{Logit}(p_{it}) = \mu_i + \delta_t$. This means that log-ORs were pooled across trials. In the treatment effect models, the baselines were considered trial specific (unconstrained). We implemented a set of alternative models in what concerns the specification of treatment effects. We first explored a model with independent treatment effects across treatments. We then explored the possibility of placebo response determining the effectiveness of alternative treatments (with treatment effects still assumed independent). We also explored whether or not there was similarity between treatment effects for treatments of the same class.

Exploring placebo response as a treatment effect modifier

The trial-specific data show that higher placebo rates are associated with lower relative effectiveness estimates. Our investigations regarding trial designs and patient characteristics did not identify a clear reason for such differences, although placebo response rates appear to have increased over time. We investigated the effect of placebo response as a treatment effect modifier. It should be noted that the source of any relationship between placebo response and treatment effect is unclear and the reader should interpret the results carefully and with caution.

Figure 21 shows the relationships between trial-specific observed placebo responses and ORs on log-odds scale in the biologic-naïve population. Considering placebo response as a treatment effect modifier in the independent treatment-effects analysis, only multiple studies of the same treatment (two or more studies) can inform the placebo effect. Hence, treatments from the single trials (i.e. CZP, SEC and GOL) do not contribute to the interaction in the independent treatment-effects analysis. In Figure 21, the solid lines within the plot reflect the relationship between the trials of the same treatments. Those with a steeper slope will indicate a stronger effect modification of placebo response (i.e. stronger association between placebo response and treatment effects). The highest effects are seen between trials of ADA and ETN – lines in green in Figure 21. Among the trials on ETN, the Mease *et al.* trial⁵³ has the smallest number of participants and the response rates in placebo and treatment arms are very different from other trials. Similarly, the smallest trial of ADA (i.e. Genovese *et al.*⁵⁶) reports a similar proportion of PRs but very

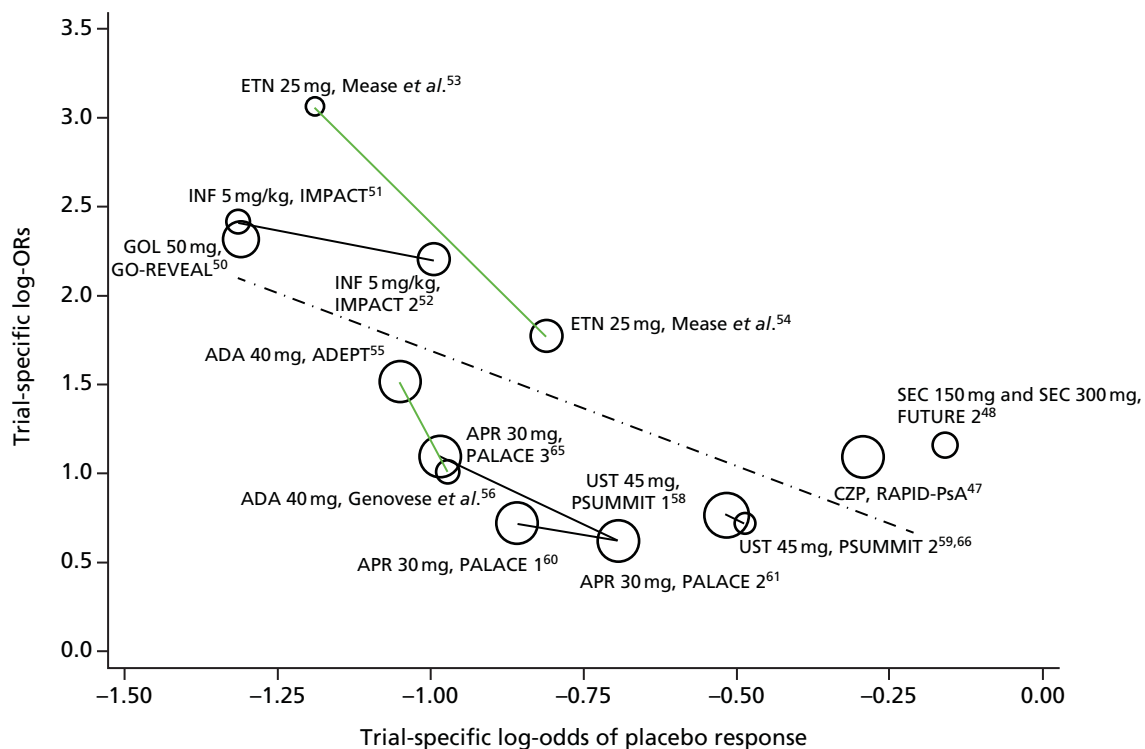

FIGURE 21 The PsARC response in the biologic-naïve subpopulation: plot of trial-specific observed log-odds of placebo responses and ORs on log-scale (all 13 trials).

different response to treatment compared with the ADEPT⁵⁵ of ADA. Therefore, the Mease *et al.*⁵³ and Genovese *et al.*⁵⁶ trials could contribute most (and possibly unreasonably so) to the estimation of interaction term (beta). It should be noted that the effect of placebo is consistently negative across all trials (i.e. higher placebo rates are associated with lower relative effectiveness estimates in the trial evidence). Exclusion of both Mease *et al.*⁵³ and Genovese *et al.*⁵⁶ will probably result in a much less pronounced placebo effect but it will still be negative.

Given the issue of heterogeneity in terms of unexplained differences in placebo response rates across the trials, analyses were undertaken, including a metaregression adjusting for placebo response. We used the baseline risk in each trial for the adjustment, taking into account the error in the estimation of baseline risk and its correlation to the ORs.¹¹⁴ Sensitivity analyses excluding both the Mease *et al.*⁵³ and Genovese *et al.*⁵⁶ trials were performed. Note that the effect of excluding these studies will be more pronounced if independent treatment effects are considered, rather than class effects. In the treatment effects as class analysis, all treatments assume to have equal or similar treatment effects; therefore, all studies within the class will contribute to the interaction term (compare dashed lines in *Figures 21* and *22*, in which all biologics as a class was assumed). The metaregression model includes an interaction term between the treatment effect (log-OR) and the trial-level estimate of placebo log-odds of response. By including such an interaction term, analyses will assume that the relative effectiveness of each of the treatments is not constant, but is associated with the response rate in the placebo arm. Treatment effects are no longer independent of the placebo response, but will be predicted for a particular value for the response rate in the placebo arm – usually the mean across the trials. The ranking of treatments is expected to differ from that estimated in the primary analyses (without the metaregression being imposed). This is because if, for example, the metaregression shows that trials with higher placebo response rates are associated with lower treatment effects, then treatments such as SEC that have been trialled only under a high placebo response will be predicted to have shown higher effectiveness in a different trial with a placebo response equal to the mean observed across trials.

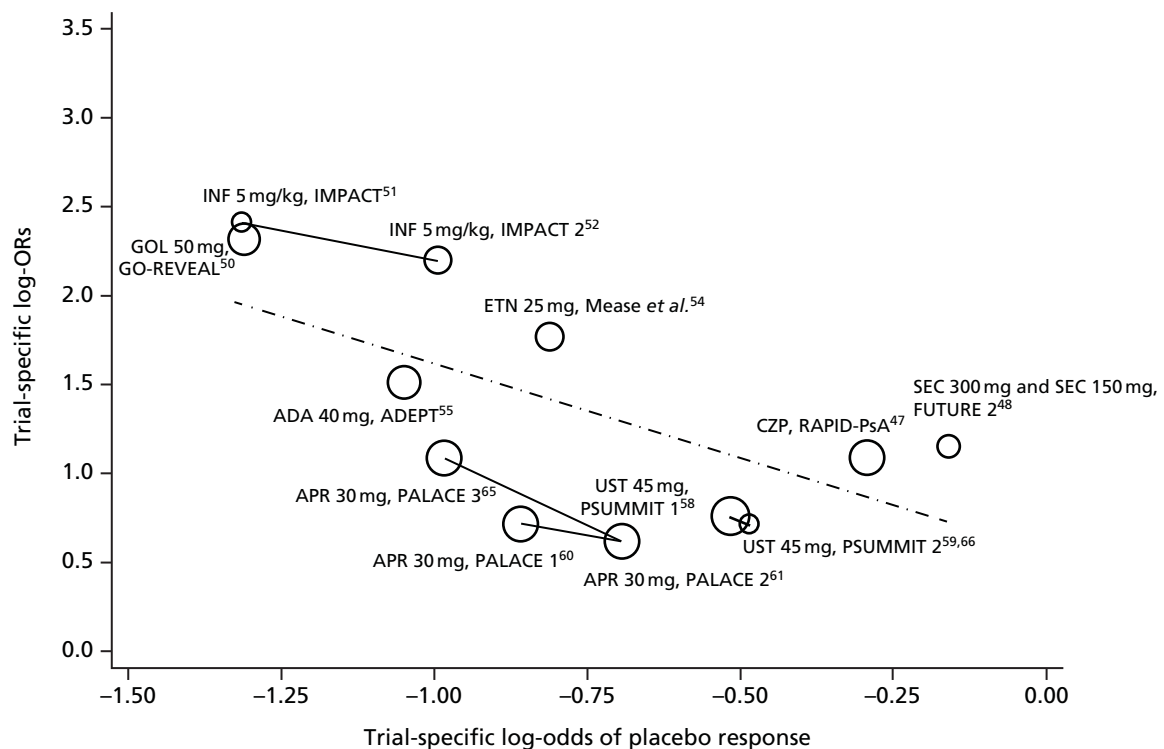

FIGURE 22 The PsARC response in the biologic-naïve subpopulation: plot of trial-specific observed log-odds of placebo responses and ORs on log-scale (excluding Mease *et al.*⁵³ and Genovese *et al.*⁵⁶).

Exploring treatment effects as class

In the context of an adjusted model for placebo response, we explored the possibility of there being class effects. Three different class groupings were considered: all treatments as a single class; all biologics as a class with APR separate; and, to reflect the pharmacology, anti-TNFs grouped, ILs grouped and APR separate. In addition, we explored two within-class assumptions: assuming treatments within a class to have equal effectiveness and, alternatively, that treatments within a class have similar (exchangeable) effectiveness (described by a normal distribution with an estimated mean and variance). Fixed effects across studies were assumed for all models. We have not considered models assuming exchangeability between classes.

Summary of all treatment effect models explored

All models implemented for evidence synthesis of PsARC response are presented in *Table 122*. Detailed coding of the models is presented in *Table 123*.

As stated earlier, sensitivity analyses around the adjustment for placebo response were performed: sets of analyses (models A1, B1, C1, C2, C3, D1 and D2) were conducted for PsARC response excluding the Mease *et al.*⁵³ and Genovese *et al.*⁵⁶ trials.

Placebo response synthesis model

To estimate baseline effect, the number of events in the placebo arm reported within each trial (r_{it}) was assumed to be binomially distributed and the log-odds for placebo was pooled across trials. A random effect was assumed between studies. The trial-specific effects for placebo PD_i were estimated from a common distribution $PD_i \sim \text{dnorm}(\text{mean}, 1/\sigma^2)$. The random effect was defined using a mean and variance parameters (mean and σ , respectively). Mean was assigned a non-informative normal prior distribution and σ was assigned a uniform prior. Results of the analysis are presented in *Detailed results for the biologic-naïve subpopulation*.

TABLE 122 Key assumptions of models implemented for evidence synthesis of PsARC response

Sets of analysis	Between-studies assumption	Treatment	Metaregression	Class
A1	FE	Independent	No baseline adjustment	No class effect
B1	FE	Independent	Common interaction term with log-odds of response in placebo arm	No class effect
C1	FE	Equal I class	Common interaction term with log-odds of response in placebo arm	Independent class effect: class = {all treatments}
C2	FE	Equal I class, remaining treatments independent ^a		Independent class effect: class = APR independent {all remaining biologics}
C3	FE	Equal I class, remaining treatments independent ^a		Independent class effect: class = {anti-TNFs, ILs}; APR independent
D1	FE	Exchangeable I class, remaining treatments independent ^a	Common interaction term with log-odds of response in placebo arm	Independent class effect: class = APR independent {all other biologics}
D2	FE	Exchangeable I class, remaining treatments independent ^a		Independent class effect: class = {anti-TNFs, ILs}; APR independent

FE, fixed effect.

a APR independent

TABLE 123 Description of models and underlying assumptions for PsARC response

Model A1	Model B1
<p><i>Likelihood</i> $r_{it} \sim \text{Binomial}(p_{it}, n_{it})$ <i>Model</i> $\text{Logit}(p_{it}) = \mu_i + \delta_t$ <i>Priors</i> $\delta_t \sim \text{dnorm}(0, 0.000001)$, $\mu_i \sim \text{dnorm}(0, 0.000001)$</p>	<p><i>Likelihood</i> $r_{it} \sim \text{Binomial}(p_{it}, n_{it})$ <i>Model</i> $\text{Logit}(p_{it}) = \mu_i + \delta_t + \beta(\mu_i - \bar{\mu})$ <i>Priors</i> $\delta_t \sim \text{dnorm}(0, 0.000001)$, $\mu_i \sim \text{dnorm}(0, 0.000001)$, $\beta \sim \text{dnorm}(0, 0.000001)$</p>
<p>Assumptions:</p> <ul style="list-style-type: none"> • baselines are unconstrained • the treatments effects are independent • fixed effects between studies 	<p>Assumptions:</p> <ul style="list-style-type: none"> • baselines are unconstrained • the treatments effects are independent • fixed effects between studies • common interaction term between studies
Models C1, C2 and C3	Models D1 and D2
<p><i>Likelihood</i> $r_{it} \sim \text{Binomial}(p_{it}, n_{it})$ <i>Model</i> $\text{Logit}(p_{it}) = \mu_i + \delta_t + \beta(\mu_i - \bar{\mu})$ $\delta_t = \delta_c$ <i>Priors</i> $\delta_c \sim \text{dnorm}(0, 0.000001)$ $\mu_i \sim \text{dnorm}(0, 0.000001)$ $\beta \sim \text{dnorm}(0, 0.000001)$</p>	<p><i>Likelihood</i> $r_{it} \sim \text{Binomial}(p_{it}, n_{it})$ <i>Model</i> $\text{Logit}(p_{it}) = \mu_i + \delta_t + \beta(\mu_i - \bar{\mu})$ $\delta_t \sim \text{dnorm}(\text{Class}_c, 1/\gamma^2)$ <i>Priors</i> $\text{Class}_c \sim \text{dnorm}(0, 0.000001)$ $\gamma \sim \text{dunif}(0, 10)$ $\mu_i \sim \text{dnorm}(0, 0.000001)$ $\beta \sim \text{dnorm}(0, 0.000001)$</p>
<p>C1: class = {all biologics} C2: APR independent; class = {all other biologics} C3: class = {anti-TNFs, ILs}; APR independent</p>	<p>D1: APR independent; class = {all other biologics} D2: class = {anti-TNFs, ILs}; APR independent</p>
<p>Assumptions:</p> <ul style="list-style-type: none"> • baselines are unconstrained • the treatments effects are equal within class • fixed effects between studies • common interaction term between studies 	<p>Assumptions:</p> <ul style="list-style-type: none"> • baselines are unconstrained • a random effect is used to describe differences between treatments (exchangeability is assumed) • fixed effects between studies • common interaction term between studies
Pooling of placebo effects	
<p><i>Likelihood</i> :</p> $r_{plac_i} \sim \text{dbin}(p_{plac_i}, n_i)$ <i>Model</i> $\text{Logit}(p_{plac_i}) = PD_i$ $PD_i \sim \text{dnorm}(\text{Mean}, 1/\sigma^2)$ <i>Priors</i> : $\text{Mean} \sim \text{dnorm}(0, 0.000001)$ $\sigma \sim \text{duni}(0, 10)$	
<p>In summary, this model assumes:</p> <ul style="list-style-type: none"> • common placebo effect across studies • random effects between studies 	

Detailed results for the biologic-naive subpopulation

Summary results of Psoriatic Arthritis Response Criteria response

Tables 124 and 125 show summary results of PsARC response including and excluding the Genovese *et al.*⁵⁶ and Mease *et al.*⁵³ studies.

Detailed results of Psoriatic Arthritis Response Criteria response

Results of the baseline effects (placebo)

The mean baseline effect is estimated to be -0.81 (Table 126).

Results of treatment effects models

More detailed results of models A1, B1, C1, C2, C3, D1 and D2 are presented next.

TABLE 124 Results of PsARC response: log-ORs (median) of treatments analysed (including Genovese *et al.*⁵⁶ and Mease *et al.*⁵³ studies) in the biologic-naive subpopulation

Metaregression	No	Yes	Yes	Yes	Yes	Yes	Yes	Yes	Yes	Yes	Yes	Yes	Yes	Yes	
Treatments	Ind	Ind	= I class	= I class	= I class	= I class ^a	= I class ^a	= I class ^a	= I class ^a	= I class ^a	= I class ^a	= I class ^a	= I class ^a	= I class ^a	
Class	No	No	{All}	{APR, other}	{ILs, TNFs, APR}	{APR, other}	{ILs, TNFs, APR}	{APR, other}	{ILs, TNFs, APR}	{APR, other}	{ILs, TNFs, APR}	{APR, other}	{ILs, TNFs, APR}	{ILs, TNFs, APR}	
	Log-odds placebo	A1	r ^b	B1	r ^b	C1	r ^b	C2	r ^b	C3	r ^b	D1	r ^b	D2	r ^b
300 mg of SEC	-0.16	1.178	5	2.110	1							1.844	3	1.833	3
150 mg of SEC	-0.16	1.175	6	2.104	2					1.285	2	1.839	4	1.822	4
UST	-0.51	0.758	9	1.187	7							1.197	8	1.174	8
CZP	-0.28	1.094	7	1.837	5	1.278	1	1.565	1			1.722	5	1.716	5
GOL	-1.32	2.339	1	1.619	6							1.692	6	1.712	6
ADA	-1.02	1.401	4	1.081	8					1.648	1	1.201	7	1.201	7
INF	-1.15	2.296	2	1.870	4							1.853	2	1.875	1
ETN	-0.99	2.043	3	1.917	3							1.856	1	1.872	2
APR	-0.85	0.813	8	0.765	9			0.756	2	0.779	3	0.769	9	0.771	9
Beta (mean)	-			-1.471		-0.498		-1.692		-1.061		-1.264		-1.225	
Residual deviance ^c		29.9		27.2		59.2		46.8		47.5		27.8		27.9	
DIC		193.1		190.5		148.0		203.8		199.1		190.0		190.3	

= I class, equal class effect; ~ I class, exchangeable class effect; ind, independent.

a Shrunken estimates.

b Ranking of treatments according to point estimates.

c Compared with 27 data points.

TABLE 125 Results of PsARC response: log-ORs (median) of treatments analysed (excluding Genovese *et al.*⁵⁶ and Mease *et al.*⁵³ studies) in the biologic-naive subpopulation

Metaregression	No	Yes	Yes	Yes	Yes	Yes	Yes	Yes	Yes	Yes	Yes	Yes	Yes		
Treatments	Ind	Ind	= I class	= I class	= I class	= I class ^a	= I class ^a	= I class ^a	= I class ^a	= I class ^a	= I class ^a	= I class ^a	= I class ^a		
Class	No	No	{All}	{APR, other}	{IL, TNF, APR}	{APR, other}	{ILs, TNFs, APR}	{APR, other}	{ILs, TNFs, APR}	{APR, other}	{ILs, TNFs, APR}	{ILs, TNFs, APR}	{ILs, TNFs, APR}		
	Log-odds placebo	A1	r ^b	B1	r ^b	C1	r ^b	C2	r ^b	C3	r ^b	D1	r ^b	D2	r ^b
300 mg of SEC	-0.16	1.176	5	1.928	2							1.775	2	1.682	4
150 mg of SEC	-0.16	1.169	6	1.914	3					1.259	2	1.766	3	1.674	5
UST	-0.51	0.757	9	1.099	8							1.179	8	1.127	8
CZP	-0.28	1.092	7	1.686	6							1.665	6	1.640	6
GOL	-1.32	2.341	1	1.761	5	1.294	1	1.577	1	1.680	1	1.729	4	1.778	2
ADA	-1.05	1.526	4	1.251	7							1.344	7	1.377	7
INF	-1.15	2.301	2	1.953	1							1.864	1	1.897	1
ETN	-0.80	1.784	3	1.781	4							1.725	5	1.748	3
APR	-0.85	0.814	8	0.772	9			0.761	2	0.781	3	0.773	9	0.777	9
Beta (mean)	-			-1.149		-1.680		-1.481		-0.903		-1.131		-1.018	
Residual deviance ^c		23.6		22.6		52.2		38.2		36.3		22.3		22.8	
DIC		169.8		168.7		147.9		177.8		176.0		167.0		167.7	

= I class, equal class effect; ~ I class, exchangeable class effect; ind, independent.
a Shrunken estimates.
b Ranking of treatments according to point estimates.
c Compared with 23 data points.

TABLE 126 Result of PsARC response: baseline effect (log-odds) in the biologic-naive subpopulation

Baseline (placebo)	Mean	Median	95% CrI
Baseline effect	-0.814	-0.812	-1.023 to -0.611
	0.290	0.277	0.102 to 0.550

Including Genovese *et al.*⁵⁶ and Mease *et al.*⁵³ studies.

Results including Genovese *et al.* and Mease *et al.* studies

The results of the models A1, B1, C1, C2, C3, D1 and D2, including the Genovese *et al.*⁵⁶ and Mease *et al.*⁵³ studies, are presented in Tables 127–133.

Results of analysis assuming treatments are independent including all studies (Table 127).

Metaregression results including all studies

Results of analysis assuming treatments are independent (Table 128).

TABLE 127 Results of model A1: treatment effects (treatment, independent; studies, fixed effect)

Treatment	OR			Treatment effects (log-odds)		
	Mean	Median	95% CrI	Mean	Median	95% CrI
300 mg of SEC	3.499	3.246	1.559 to 6.886	1.181	1.178	0.444 to 1.930
150 mg of SEC	3.503	3.239	1.540 to 6.955	1.179	1.175	0.432 to 1.939
UST	2.172	2.134	1.489 to 3.070	0.759	0.758	0.398 to 1.122
CZP	3.082	2.985	1.880 to 4.813	1.096	1.094	0.631 to 1.571
GOL	10.890	10.370	5.865 to 18.980	2.343	2.339	1.769 to 2.943
ADA	4.159	4.059	2.703 to 6.212	1.403	1.401	0.994 to 1.827
INF	10.330	9.931	5.914 to 17.060	2.299	2.296	1.777 to 2.837
ETN	8.063	7.712	4.529 to 13.580	2.047	2.043	1.510 to 2.609
APR	2.276	2.255	1.733 to 2.941	0.813	0.813	0.550 to 1.079
Residual deviance ^a	29.86					
DIC	193.148					

^a Compared 27 data points.

TABLE 128 Results of model B1: treatment effects (metaregression; treatment, independent; studies, fixed effect)

Treatment	OR			Treatment effects (log-odds)		
	Mean	Median	95% CrI	Mean	Median	95% CrI
300 mg of SEC	10.560	8.251	3.244 to 26.790	2.142	2.110	1.177 to 3.288
150 mg of SEC	10.410	8.196	3.174 to 26.980	2.135	2.104	1.155 to 3.295
UST	3.441	3.276	2.117 to 5.752	1.201	1.187	0.750 to 1.750
CZP	7.024	6.277	3.166 to 14.980	1.861	1.837	1.153 to 2.707
GOL	5.360	5.049	2.000 to 10.400	1.593	1.619	0.693 to 2.342
ADA	2.989	2.947	1.745 to 4.404	1.067	1.081	0.557 to 1.483
INF	6.702	6.488	3.345 to 11.120	1.856	1.870	1.207 to 2.408
ETN	7.018	6.804	4.026 to 11.250	1.914	1.917	1.393 to 2.420
APR	2.160	2.150	1.684 to 2.691	0.763	0.765	0.521 to 0.990
Beta				-1.471	-1.459	-2.769 to -0.216
Residual deviance ^a	27.17					
DIC	190.495					

^a Compared 27 data points.

Results of analyses assuming treatments as class (*Tables 129–133*).

Results excluding Genovese et al. and Mease et al. studies

The results of the models A1, B1, C1, C2, C3, D1 and D2, excluding the Genovese *et al.*⁵⁶ and Mease *et al.*⁵³ studies, are presented in *Tables 134–140*.

The results of analysis assuming treatments are independent excluding the Genovese *et al.*⁵⁶ and Mease *et al.*⁵³ studies (*Table 134*).

TABLE 129 Results of model C1: treatment effects (metaregression; treatment, equal I class; studies, fixed effect)

Treatment/parameter	OR			Treatment effects (log-odds)		
	Mean	Median	95% CrI	Mean	Median	95% CrI
Biologics as class	3.612	3.589	2.730 to 4.648	1.275	1.278	1.004 to 1.537
Beta				-0.498	0.523	-3.711 to 2.483
Residual deviance ^a	59.24					
DIC	147.961					

a Compared 27 data points.

TABLE 130 Results of model C2: treatment effects (metaregression; treatment, APR = independent, other biologics = equal I class; studies, fixed effect)

Treatment/parameter	OR			Treatment effects (log-odds)		
	Mean	Median	95% CrI	Mean	Median	95% CrI
Biologics as class (excluding APR)	4.805	4.782	4.099 to 5.657	1.566	1.565	1.411 to 1.733
APR	2.142	2.130	1.676 to 2.670	0.755	0.756	0.516 to 0.982
Beta				-1.692	-1.666	-2.406 to -1.122
Residual deviance ^a	46.83					
DIC	203.806					

a Compared 27 data points.

TABLE 131 Results of model C3: treatment effects [metaregression; treatment, APR = independent, equal I class (ILs, anti-TNFs); studies, fixed effect, including all studies]

Treatment/parameter	OR			Treatment effects (log-odds)		
	Mean	Median	95% CrI	Mean	Median	95% CrI
ILs as class	3.755	3.616	1.880 to 6.573	1.273	1.285	0.631 to 1.883
Anti-TNFs as class	5.238	5.195	4.036 to 6.710	1.648	1.648	1.395 to 1.904
APR	2.194	2.179	1.726 to 2.751	0.779	0.779	0.546 to 1.012
Beta				-1.061	-1.025	-1.864 to -0.462
Residual deviance ^a	47.54					
DIC	199.129					

a Compared 27 data points.

TABLE 132 Results of model D1: treatment effects (metaregression; treatment, APR = independent, other biologics = exchangeable I class; studies, fixed effect, including all studies)

Treatment	OR			Predicted mean distribution			Shrunken or independent treatment effects (log-odds)		
	Mean	Median	95% CrI	Mean	Median	95% CrI	Mean	Median	95% CrI
300 mg of SEC	5.331	5.206	3.675 to 7.737	1.657	1.647	0.653 to 2.714	1.859	1.844	1.343 to 2.456
150 mg of SEC							1.853	1.839	1.332 to 2.451
UST							1.202	1.197	0.885 to 1.538
CZP							1.731	1.722	1.342 to 2.165
GOL							1.689	1.692	1.233 to 2.122
ADA							1.197	1.201	0.861 to 1.509
INF							1.854	1.853	1.462 to 2.254
ETN							1.859	1.856	1.481 to 2.258
APR	2.166	2.157	1.765 to 2.609				0.768	0.769	0.568 to 0.959
γ^a							0.437	0.398	0.187 to 0.924
Beta							-1.264	-1.261	-1.917 to -0.633
Residual deviance ^b	27.76								
DIC	189.961								

a Variance parameter for the random effect across biologics (excluding APR).
b Compared 27 data points.

TABLE 133 Results of model D2: treatment effects [metaregression; treatment, APR = independent, exchangeable I class (ILs, anti-TNFs); studies: fixed effect, including all studies]

Treatment	OR			Predicted mean distribution			Shrunken or independent treatment effects (log-odds)		
	Mean	Median	95% CrI	Mean	Median	95% CrI	Mean	Median	95% CrI
300 mg of SEC	5.521	4.982	2.326 to 11.920	1.618	1.597	0.315 to 3.016	1.841	1.833	1.146 to 2.588
150 mg of SEC							1.832	1.822	1.133 to 2.588
UST							1.180	1.174	0.809 to 1.580
CZP	5.546	5.340	3.112 to 9.147	1.671	1.673	0.424 to 2.891	1.722	1.716	1.278 to 2.209
GOL							1.707	1.712	1.173 to 2.204
ADA							1.199	1.201	0.834 to 1.548
INF							1.874	1.875	1.430 to 2.306
ETN							1.874	1.872	1.476 to 2.287
APR	2.172	2.162	1.763 to 2.638				0.770	0.771	0.567 to 0.970
γ^a							0.491	0.437	0.193 to 1.107
Beta							-1.225	-1.227	-2.039 to -0.393
Residual deviance ^b	27.92								
DIC	190.342								

a Variance parameter for the random effect across biologics (excluding APR).
b Compared 27 data points.

TABLE 134 Results of model A1: treatment effects (treatment, independent; studies, fixed effect, excluding Genovese *et al.*⁵⁶ and Mease *et al.*⁵³)

Treatment	OR			Treatment effects (log-odds)		
	Mean	Median	95% CrI	Mean	Median	95% CrI
300 mg of SEC	3.492	3.240	1.554 to 6.920	1.178	1.176	0.441 to 1.934
150 mg of SEC	3.486	3.218	1.543 to 6.982	1.174	1.169	0.434 to 1.943
UST	2.168	2.131	1.486 to 3.062	0.757	0.757	0.396 to 1.119
CZP	3.076	2.980	1.861 to 4.820	1.094	1.092	0.621 to 1.573
GOL	10.910	10.390	5.869 to 18.920	2.345	2.341	1.770 to 2.940
ADA	4.746	4.602	2.856 to 7.491	1.527	1.526	1.049 to 2.014
INF	10.380	9.983	5.954 to 17.210	2.303	2.301	1.784 to 2.845
ETN	6.269	5.956	3.264 to 11.070	1.787	1.784	1.183 to 2.404
APR	2.278	2.257	1.739 to 2.931	0.814	0.814	0.553 to 1.075
Residual deviance ^a	23.63					
DIC	169.761					

a Compared 23 data points.

Metaregressions results excluding Genovese *et al.* and Mease *et al.* studies

Results of analysis assuming treatments are independent (Table 135).

Results of analyses assuming treatments as class (Tables 136–140).

TABLE 135 Results of model B1: treatment effects (metaregression; treatment, independent; studies, fixed effect, excluding Genovese *et al.*⁵⁶ and Mease *et al.*⁵³)

Treatments	OR			Treatment effects (log-odds)		
	Mean	Median	95% CrI	Mean	Median	95% CrI
300 mg of SEC	9.534	6.872	2.132 to 23.890	1.932	1.928	0.757 to 3.174
150 mg of SEC	9.980	6.779	2.091 to 23.470	1.925	1.914	0.738 to 3.156
UST	3.178	3.001	1.748 to 5.410	1.103	1.099	0.558 to 1.688
CZP	6.248	5.400	2.241 to 13.770	1.695	1.686	0.807 to 2.622
GOL	8.068	5.818	2.233 to 14.620	1.757	1.761	0.803 to 2.682
ADA	3.647	3.494	1.940 to 5.920	1.245	1.251	0.663 to 1.778
INF	7.572	7.049	3.629 to 13.280	1.952	1.953	1.289 to 2.587
ETN	6.218	5.936	3.477 to 10.280	1.783	1.781	1.246 to 2.330
APR	2.181	2.165	1.707 to 2.729	0.772	0.772	0.535 to 1.004
Beta				-1.149	-1.151	-2.727 to 0.406
Residual deviance ^a	22.601					
DIC	168.708					

a Compared 23 data points.

TABLE 136 Results of model C1: treatment effects (metaregression; treatment, equal I class; studies, fixed effect, excluding Genovese *et al.*⁵⁶ and Mease *et al.*⁵³)

Treatment/parameter	OR			Treatment effects (log-odds)		
	Mean	Median	95% CrI	Mean	Median	95% CrI
Biologics as class	3.679	3.649	2.749 to 4.794	1.293	1.294	1.011 to 1.567
Beta				-1.680	-2.560	-4.050 to 2.094
Residual deviance ^a	52.16					
DIC	147.920					

a Compared 23 data points.

TABLE 137 Results of model C2: treatment effects (metaregression; treatment, APR = independent, other biologics = equal I class; studies, fixed effect, excluding Genovese *et al.*⁵⁶ and Mease *et al.*⁵³)

Treatment/parameter	OR			Treatment effects (log-odds)		
	Mean	Median	95% CrI	Mean	Median	95% CrI
Biologics as class (excluding APR)	4.867	4.843	4.192 to 5.682	1.580	1.577	1.433 to 1.737
APR	2.151	2.141	1.730 to 2.622	0.760	0.761	0.548 to 0.964
Beta				-1.481	-1.455	-2.122 to -0.996
Residual deviance ^a	38.16					
DIC	177.825					

a Compared 23 data points.

TABLE 138 Results of model C3: treatment effects (metaregression; treatment, APR = independent, equal I class (ILs, anti-TNFs); studies, fixed effect, excluding Genovese *et al.*⁵⁶ and Mease *et al.*⁵³)

Treatment/parameter	OR			Treatment effects (log-odds)		
	Mean	Median	95% CrI	Mean	Median	95% CrI
ILs as class	3.559	3.520	2.289 to 5.069	1.250	1.259	0.828 to 1.623
Anti-TNFs as class	5.392	5.363	4.500 to 6.460	1.681	1.680	1.504 to 1.866
APR	2.195	2.183	1.796 to 2.652	0.781	0.781	0.586 to 0.976
Beta				-0.903	-0.906	-1.725 to -0.087
Residual deviance ^a	36.30					
DIC	175.979					

a Compared 23 data points.

TABLE 139 Results of model D1: treatment effects (metaregression; treatment, APR = independent, exchangeable I class; studies, fixed effect, excluding Genovese *et al.*⁵⁶ and Mease *et al.*⁵³)

Treatment	OR			Predicted mean distribution			Shrunken or independent treatment effects (log-odds)		
	Mean	Median	95% CrI	Mean	Median	95% CrI	Mean	Median	95% CrI
300 mg of SEC	5.214	5.115	3.706 to 7.350	1.637	1.633	0.713 to 2.563	1.787	1.775	1.296 to 2.335
150 mg of SEC							1.778	1.766	1.273 to 2.338
UST							1.180	1.179	0.857 to 1.507
CZP							1.668	1.665	1.283 to 2.067
GOL							1.733	1.729	1.329 to 2.157
ADA							1.341	1.344	0.991 to 1.669
INF							1.869	1.864	1.499 to 2.264
ETN							1.731	1.725	1.355 to 2.141
APR	2.177	2.167	1.791 to 2.621				0.773	0.773	0.583 to 0.964
γ^a							0.385	0.350	0.148 to 0.824
Beta							-1.131	-1.128	-1.750 to -0.528
Residual deviance ^b	22.34								
DIC	167.044								

a Variance parameter for the random effect across biologics (excluding APR).
b Compared 23 data points.

TABLE 140 Results of model D2: treatment effects [metaregression; treatment, APR = independent, exchangeable I class (ILs, anti-TNFs); studies, fixed effect, excluding Genovese *et al.*⁵⁶ and Mease *et al.*⁵³]

Treatment	OR			Predicted mean distribution			Shrunken or independent treatment effects (log-odds)		
	Mean	Median	95% CrI	Mean	Median	95% CrI	Mean	Median	95% CrI
300 mg of SEC	4.805	4.428	2.225 to 9.507	1.503	1.478	0.383 to 2.754	1.688	1.682	1.012 to 2.390
150 mg of SEC							1.679	1.674	0.998 to 2.399
UST							1.127	1.127	0.756 to 1.498
CZP	5.566	5.408	3.436 to 8.554	1.695	1.689	0.670 to 2.750	1.640	1.640	1.218 to 2.064
GOL							1.781	1.778	1.314 to 2.258
ADA							1.376	1.377	0.985 to 1.757
INF							1.904	1.897	1.512 to 2.329
ETN							1.752	1.748	1.359 to 2.165
APR	2.187	2.176	1.796 to 2.642				0.778	0.777	0.586 to 0.972
γ^a							0.407	0.362	0.123 to 0.968
Beta							-1.018	-1.019	-1.781 to -0.245
Residual deviance ^b	22.77								
DIC	167.708								

a Variance parameter for the random effect across biologics (excluding APR).
b Compared 23 data points.

Preferred models

The unadjusted model A1 fits the data as well as any of the other models and generates results that reflect the observed results. The placebo response-adjusted model B1 fits well compared with the unadjusted model A1 (smaller DIC and residual deviance), but not significantly so as the difference in DIC is < 5 points. Considering the placebo-adjusted models, it must be borne in mind that without any clear rationale for the placebo effect, the results must be interpreted with caution. The results (rankings) generated by model B1 are very different from the observed trial results.

Regarding possible class effects, the analyses found that an assumption of equal class effect for the treatments does not produce a better-fitting model (models C1, C2, C3) than assuming independent treatment effects (models A1, B1) or similar treatment effects (models D1, D2). There was little difference in goodness-of-fit statistics (DIC and residual deviance) between models D1 and D2, and we consider the exchangeable class effect model (D2) which utilised two classes (ILs and anti-TNFs) with APR separate to be the most clinically plausible. The results (rankings) generated by models D1 and D2 are same, but are very different from the observed trial results.

Comparing treatment effects in models A1, B1 and D2, the treatment effects are very different from each other. INF and 300 mg of SEC appeared to be the most effective in models D2 and B1, respectively, but GOL is the most effective in model A1. UST appeared to be least effective in model A1, whereas APR appeared to be least effective in models B1 and D2.

In the sensitivity analyses on Genovese *et al.*⁵⁶ and Mease *et al.*,⁵³ excluding those two studies from the analysis affects the treatment effects, resulting in changes of the treatment effects ranking. Despite the results of the adjusted model (B1) being sensitive to the exclusion of Mease *et al.*⁵³ and Genovese *et al.*⁵⁶ (with rankings changing), there are two reasons why this analysis has not been adopted as the main one. First, exclusion of these studies may appear to be selective, and second it is less relevant in the context of our preferred model that assumes a class effect (compare D2 with and without Mease *et al.*⁵³ and Genovese *et al.*⁵⁶). Therefore, these two trials were not excluded from our preferred analysis.

Hence, we consider models A1 and D2 including Genovese *et al.*⁵⁶ and Mease *et al.*⁵³ to be our preferred models.

Comparison of the network meta-analysis of Psoriatic Arthritis Response Criteria responses in the company submissions (Novartis and UCB Pharma), a previous multiple technology appraisal (Rodgers *et al.*) and the current Assessment Group

Each of the two CSs combined evidence using Bayesian evidence synthesis methods to estimate probability of PsARC responses to inform the economic model. UCB Pharma and the AG included analysis of subpopulations in the main NMA and analysed both subpopulations (biologic naive and experienced) separately, whereas Novartis considered overall population as the main NMA, and the analysis included a more complete set of treatments and trials. The AG refers to the subgroup NMA conducted by Novartis (i.e. biologic naive) in this comparison. A brief comparison of the methods used and key model assumptions by the AG, CS and previous MTA is presented in *Tables 141* and *142*.

A key difference between the NMAs presented concerns the trials included in each analysis. Only the AG NMA for the biologic-naive subgroup includes all comparators and all trials. The UCB Pharma analysis for the biologic-naive subgroup includes all treatments but misses only some APR trials. The Novartis NMA does not include CZP or APR for the biologic-naive subgroup analysis and does not include all trials for the other treatments. The Rodgers *et al.*³³ analysis was limited to the treatments available at that time.

The evidence synthesis is not clear in UCB Pharma's main submission for the biologic-experienced subgroup, and results for this subgroup were not reported. Novartis did not conduct a NMA for the biologic-experienced subgroup. Therefore, it was not plausible to compare the AG's NMA with the CS for the biologic-experienced subgroup.

TABLE 141 Comparison of evidence synthesis of PsARC responses in the CSs (Novartis and UCB Pharma), a previous MTA³³ and the current AG

Domains compared	Rodgers <i>et al.</i> , 2011 ³³	CS		CS
		Novartis	UCB Pharma	AG
Model	Binomial logit model	Binomial logit model	Binomial logit model	Binomial logit model
Results reported	Probability of PsARC response for each treatment	RRs of each treatment compared with SEC; and probability of PsARC response for each treatment ^a	ORs reported for the biologic-naive subpopulation, but results were not reported for the biologic-experienced subpopulation	ORs and probability of PsARC response for each treatment
Time point	At 12 weeks (data from the 12-week or closest time point after 12 weeks – normally 14 or 16 weeks)	At 12 weeks (data from the 12-week or closest time point after 12 weeks – normally 14 or 16 weeks)	Primary analysis at 24 weeks (by treatments), sensitivity analysis was conducted at 12 weeks including data on 12 weeks or closest time point after 12 weeks ^b	At 12 weeks (data from the 12-week or closest time point after 12 weeks – normally 14 or 16 weeks); UST outcomes at 24 weeks were included and assumed equivalent to outcomes at 12 weeks
Comments	–	Modelled probabilities are presented graphically	–	–
Data regarding subpopulation of biologic naive				
Studies used in the analysis	ADEPT; ⁵⁵ Genovese <i>et al.</i> ; ⁵⁶ IMPACT; ⁵¹ IMPACT 2; ⁵² and Mease <i>et al.</i> ^{53,54}	ADEPT; ⁵⁵ Genovese <i>et al.</i> ; ⁵⁶ FUTURE 2; ⁴⁸ GO-REVEAL; ⁵⁰ IMPACT 2; ⁵² and Mease <i>et al.</i> ⁵⁴	ADEPT; ⁵⁵ Genovese <i>et al.</i> ; ⁵⁶ GO-REVEAL; ⁵⁰ IMPACT; ⁵¹ IMPACT 2; ⁵² Mease <i>et al.</i> ; ^{53,54} and RAPID-PsA ⁴⁷ (12- to 16-week analysis)	ADEPT; ⁵⁵ FUTURE 2; ⁴⁸ Genovese <i>et al.</i> ; ⁵⁶ GO-REVEAL; ⁵⁰ IMPACT; ⁵¹ IMPACT 2; ⁵² Mease <i>et al.</i> ; ^{53,54} PALACE 1; ⁶⁰ PALACE 2; ⁶¹ PALACE 3; ⁶⁵ PSUMMIT 1; ⁵⁸ PSUMMIT 2; ^{59,66} and RAPID-PsA ⁴⁷
Drugs evaluated	40 mg of ADA; 5 mg/kg of INF; and 25 mg of ETN	40 mg of ADA; 25 mg of ETN; 50 and 100 mg of GOL; 5 mg/kg of INF; and 150 and 300 mg of SEC	40 mg of ADA; 400 mg of CZP; 25 mg of ETN; 50 mg of GOL; and 5 mg/kg of INF	40 mg of ADA; 30 mg of APR; 400 mg of CZP; 25 mg of ETN; 50 mg of GOL; 5 mg/kg of INF; 150 and 300 mg of SEC; and 45 mg of UST
Data regarding subpopulation of biologic experienced				
Studies used in the analysis	–	–	Not clear	FUTURE 2; ⁴⁸ and PSUMMIT 2 ^{59,66}
Drugs evaluated	–	–	Not clear	300 mg of SEC; and 45 mg of UST
a The AG considers probabilities to compare with our results.				
b The AG considers results at 12 weeks to compare with AG NMA results.				

Another key difference relates to the primary time point analysed: most NMAs used 12 weeks, but the UCB Pharma analysis used 24 weeks as its primary time point, although it did include a 12-week sensitivity analysis.

All analyses considered a binomial logit model (both companies, previous MTA and AG). Both the AG and UCB Pharma consider fixed effect on studies, whereas Novartis considers random effects. Both the AG and UCB Pharma consider baseline risk adjustment to reflect effects of differences in trial-specific placebo response on treatment effects in the biologic-naive population whereas Novartis did not consider such adjustment for subgroup analysis.

TABLE 142 Key assumptions in the synthesis models for PsARC responses in the CSs (Novartis and UCB Pharma), a previous MTA³³ and the current AG

Domains compared	Rodgers <i>et al.</i> , 2011 ³³	CS		
		Novartis	UCB Pharma	AG
Model	Binomial logit model	Binomial logit model	Binomial logit model	Binomial logit model
Fixed or random effects between studies	Random effects on studies	Random effects on studies	Fixed effects on studies (for both biologic-naive and biologic-experienced subpopulation)	Fixed effects on studies (for both biologic-naive and biologic-experienced subpopulation)
Baselines	Common-effect model was used to estimate baseline	Common-effect model was used to estimate baseline	Common-effect model was used to estimate baseline	Common-effect model was used to estimate baseline
Treatment effects	Treatments were assumed to be independent of each other	Treatments were assumed to be independent of each other	For the biologic-naive subpopulation the treatment effects are exchangeable within classes (anti-TNFs = ADA, IFX, ETN, GOL). For the biologic-experienced subpopulation the treatments were assumed to be independent of each other	For the biologic-naive subpopulation: <ol style="list-style-type: none"> 1. treatments were assumed to be independent of each other 2. treatments as class considering treatments are similar within class (i.e. exchangeable class effect) and utilise two classes (ILs and anti-TNFs) For the biologic-experienced subpopulation the treatments were assumed to be independent of each other
Model adjusted for placebo response	Unadjusted	Unadjusted	Adjusted for biologic-naive subpopulation, but unadjusted for biologic-experienced subpopulation	Independent treatment effects models were unadjusted, but analysis assuming exchangeable class effects model was adjusted for the placebo response
Interaction term (beta)	–	–	Common interaction term in adjusted model	Common interaction term in adjusted model

Another key difference relates to the PsARC responses data included in the analysis. An inconsistency was identified by the AG in the Novartis submission in PsARC response data for SEC and revised PsARC response data were provided late in the assessment. Therefore, it is plausible that Novartis NMA used the incorrect data for the analysis. Additionally, the AG's extracted PsARC response data from some studies do not match with the Novartis data, particularly for Mease *et al.*⁵⁴ trial and two ADA trials (ADEPT,⁵⁵ Genovese *et al.*⁵⁶). The plausible explanation for the difference is that the AG consistently used ITT denominators rather than the 'modified ITT' approach which was sometimes used by the CS (whereby only patients who have received at least one dose of their randomised treatment are considered).

The results of the AG NMA are compared with those of the other NMAs in *Tables 143* and *144*. *Table 143* shows the probabilities of PsARC response for the biologic-naive subgroup, estimated by the different models – Rodgers *et al.*,³³ Novartis and AG (the UCB Pharma results are presented only as ORs) – and *Table 144* compares the ORs from the AG NMA with those from the UCB Pharma analysis. The results of the AG unadjusted NMA are mostly consistent with the previous MTA as well as the Novartis results, except for the SEC. The differences are largely because Novartis included a different PsARC response data set. The estimated probabilities in the AG's analysis are more precise than Novartis' results. Given the differences in model assumptions and included studies, the ranking of the treatment effects is similar between UCB Pharma and the AG's adjusted NMA (see *Table 144*).

TABLE 143 Comparison of probability of PsARC response in Novartis' submission, a previous MTA³³ and the current AG in the biologic-naïve subpopulation

Treatment	Rodgers <i>et al.</i> (2011), ³³ mean (95% CrI)	Novartis, mean	AG, median (95% CrI)	
			Unadjusted, independent treatment	Adjusted for placebo response, class effects assumed
Placebo	0.25 (0.18 to 0.32)	Confidential information has been removed	0.31 (0.26 to 0.36)	0.31 (0.26 to 0.36)
300 mg of SEC	NC	Confidential information has been removed	0.59 (0.40 to 0.76)	0.73 (0.57 to 0.86)
150 mg of SEC	NC	Confidential information has been removed	0.59 (0.40 to 0.76)	0.73 (0.57 to 0.86)
UST	NC	NC	0.49 (0.38 to 0.60)	0.59 (0.48 to 0.70)
CZP	NC	NC	0.57 (0.44 to 0.69)	0.71 (0.60 to 0.81)
50 mg of GOL	NC	Confidential information has been removed	0.82 (0.71 to 0.90)	0.71 (0.58 to 0.81)
ADA	0.59 (0.44 to 0.71)	Confidential information has been removed	0.64 (0.53 to 0.75)	0.60 (0.49 to 0.69)
INF	0.80 (0.67 to 0.89)	Confidential information has been removed	0.81 (0.71 to 0.89)	0.74 (0.63 to 0.83)
ETN	0.71 (0.57 to 0.83)	Confidential information has been removed	0.77 (0.65 to 0.86)	0.74 (0.64 to 0.82)
APR	NC	NC	0.50 (0.41 to 0.59)	0.49 (0.41 to 0.57)

NC, not conducted.

TABLE 144 Comparison of PsARC response (ORs) at 12 weeks between UCB Pharma's submission and the current AG in the biologic-naïve subpopulation

Treatment	UCB Pharma, mean (95% CrI)	AG, mean (95% CrI)	
		Unadjusted, independent treatment	Adjusted for placebo response, class effects assumed
300 mg of SEC	NC	3.25 (1.56 to 6.89)	6.25 (3.15 to 13.31)
SEC 150	NC	3.24 (1.54 to 6.96)	6.18 (3.10 to 13.30)
UST	NC	2.13 (1.49 to 3.07)	3.24 (2.25 to 4.86)
CZP	Confidential information has been removed	2.99 (1.88 to 4.81)	5.56 (3.59 to 9.11)
GOL	Confidential information has been removed	10.37 (5.87 to 18.98)	5.54 (3.23 to 9.06)
ADA	Confidential information has been removed	4.06 (2.70 to 6.21)	3.33 (2.30 to 4.70)
INF	Confidential information has been removed	9.93 (5.91 to 17.06)	6.52 (4.18 to 10.04)
ETN	Confidential information has been removed	7.71 (4.53 to 13.58)	6.50 (4.38 to 9.85)
APR	NC	2.26 (1.73 to 2.94)	2.16 (1.76 to 2.64)

NC, not conducted.

*WinBUG codes of preferred model**Model A1:*

```

model {
for(i in 1:N) {
  r[i] ~ dbin(p[i],n[i])
  logit(p[i]) <- mu[s[i]] + (d[t[i]]-d[b[i]])*(1-equals(t[i],b[i]))
  rhat[i] <- p[i] * n[i]
  dev[i] <- 2 * (r[i] * (log(r[i])-log(rhat[i]))) + (n[i]-r[i]) * (log(n[i]-r[i]) - log(n[i]-rhat[i])))
}
  totresdev <- sum(dev[]) #total resedual deviance
for (j in 1:ns) { mu[j]~dnorm(0,0.000001) }
d[1]<-0
for (k in 2:nt) { d[k] ~ dnorm(0,0.000001)
  OR[k]<- exp(d[k])
}
}

```

Model D2:

```

model {
for(i in 1:N) {
  r[i] ~ dbin(p[i],n[i])
  logit(p[i]) <- mu[s[i]] + (d[t[i]]-d[b[i]])*(1-equals(t[i],b[i]))
  + (beta[t[i]]-beta[t[1]])*(mu[s[i]]-(Mean))*(1-equals(t[i],b[i]))
  rhat[i] <- p[i] * n[i]
  dev[i] <- 2 * (r[i] * (log(r[i])-log(rhat[i]))) + (n[i]-r[i]) * (log(n[i]-r[i]) - log(n[i]-rhat[i])))
}
  totresdev <- sum(dev[])
d[1]<-0
for (i in 2:3) {d[i] ~ dnorm(D.c[1], prec.d)}
d[4] ~ dnorm(D.c[2], prec.d)
d[5] ~ dnorm(D.c[1], prec.d)
for (i in 6:9) {d[i] ~ dnorm(D.c[2], prec.d)}
d[10]<- D.c[3]
for (i in 1:3) { D.c[i]~dnorm(0.0,0.000001)}
prec.d<-1/(sd.d*sd.d)
sd.d~dunif(0,10)
for (i in 1:2) {D.pred[i]~dnorm(D.c[i],prec.d)}
beta[1]<-0
for (i in 2:nt) { beta[i]<- betaplac }
betaplac ~ dnorm(0,0.000001)
for (j in 1:ns) { mu[j]~dnorm(0,0.000001)}
A ~ dnorm (meanA,precA)
for (k in 1:nt) { logit(T[k]) <- A + d[k] }
for (k in 1:nt) { OR[k]<- exp(d[k])}
}

d[1]=PLA, d[2]=SEC300, d[3]=SEC150, d[4]=CZP, d[5]=UST, d[6]=GOL, d[7]=ADA, d[8]=INF, d[9]=ETA,
d[10]=APR

```

HAQ-DI score changes conditional on PsARC response/non-response

Detailed methods for the biologic-naive subpopulation

We consider three models to estimate the HAQ-DI score changes conditional on PsARC response. Model E1 considers that treatments are independent and considers fixed effects across studies. Models E2 and E3 apply a class effects on three groups: anti-TNFs, ILs and APR. This class effect reflects the best-fitting class effect model for PsARC (see *Detailed results for the biologic-naive subpopulation*). Model E2 assumes that the treatments are similar within class (exchangeable) and fixed effect across studies, and model E3 considers that the treatments are equal within class and fixed effect across studies. A detailed description of the model and underlying assumptions are presented in *Table 145*.

The model defines TR as treatment responder, TNR as treatment non-responder, PR as placebo responder and PNR as placebo non-responder; l represents the trial and j the alternative treatments. The observed quantities (i.e. HAQ-DI score changes in PRs and PNRs, and in TRs and TNRs) have a normal distribution for the likelihood.

TABLE 145 Description of the models and underlying assumptions for HAQ-DI changes conditional on PsARC response

Model E1	Model E2	Model E3
<p><i>Likelihood</i></p> $HAQ_{PNRi} \sim dnorm(\mu_{PNRi}, 1/var_{PNRi})$ $HAQ_{PRi} \sim dnorm(\mu_{PRi}, 1/var_{PRi})$ $HAQ_{TNRij} \sim dnorm(\mu_{TNRij}, 1/var_{TNRij})$ $HAQ_{TRij} \sim dnorm(\mu_{TRij}, 1/var_{TRij})$ <p><i>Model</i></p> $\mu_{PNRi} = baseline_i$ $\mu_{PRi} = \mu_{PNRi} + \delta.diff_{PR}$ $\mu_{TNRij} = \mu_{PNRi} + \delta.diff_{TNRj}$ $\mu_{TRij} = \mu_{PNRi} + \delta.diff_{TRj}$ <p><i>Priors</i></p> $baseline_i \sim dnorm(0, 0.000001)$ $\delta.diff_{PR} \sim dnorm(0, 0.000001)$ $\delta.diff_{TNRj} \sim dnorm(0, 0.000001)$ $\delta.diff_{TRj} \sim dnorm(0, 0.000001)$	<p><i>Likelihood</i></p> $HAQ_{PNRi} \sim dnorm(\mu_{PNRi}, 1/var_{PNRi})$ $HAQ_{PRi} \sim dnorm(\mu_{PRi}, 1/var_{PRi})$ $HAQ_{TNRij} \sim dnorm(\mu_{TNRij}, 1/var_{TNRij})$ $HAQ_{TRij} \sim dnorm(\mu_{TRij}, 1/var_{TRij})$ <p><i>Model</i></p> $\mu_{PNRi} = baseline_i$ $\mu_{PRi} = \mu_{PNRi} + \delta.diff_{PR}$ $\mu_{TNRij} = \mu_{PNRi} + \delta.diff_{TNRj}$ $\mu_{TRij} = \mu_{PNRi} + \delta.diff_{TRj}$ $\delta.diff_{TNRj} \sim dnorm(\delta.diff_{TNR.C}, 1/\gamma_{TNR}^2)$ $\delta.diff_{TRj} \sim dnorm(\delta.diff_{TR.C}, 1/\gamma_{TR}^2)$ <p><i>Priors</i></p> $baseline_i \sim dnorm(0, 0.000001)$ $\delta.diff_{PR} \sim dnorm(0, 0.000001)$ $\delta.diff_{TNR.C} \sim dnorm(0, 0.000001)$ $\delta.diff_{TR.C} \sim dnorm(0, 0.000001)$ $\gamma_{TNR} \sim dunif(0, 10)$ $\gamma_{TR} \sim dunif(0, 10)$	<p><i>Likelihood</i></p> $HAQ_{PNRi} \sim dnorm(\mu_{PNRi}, 1/var_{PNRi})$ $HAQ_{PRi} \sim dnorm(\mu_{PRi}, 1/var_{PRi})$ $HAQ_{TNRij} \sim dnorm(\mu_{TNRij}, 1/var_{TNRij})$ $HAQ_{TRij} \sim dnorm(\mu_{TRij}, 1/var_{TRij})$ <p><i>Model</i></p> $\mu_{PNRi} = baseline_i$ $\mu_{PRi} = \mu_{PNRi} + \delta.diff_{PR}$ $\mu_{TNRij} = \mu_{PNRi} + \delta.diff_{TNRj}$ $\delta.diff_{TNRj} = \delta.diff_{TNR.C}$ $\mu_{TRij} = \mu_{PNRi} + \delta.diff_{TRj}$ $\delta.diff_{TRj} = \delta.diff_{TR.C}$ <p><i>Priors</i></p> $baseline_i \sim dnorm(0, 0.000001)$ $\delta.diff_{PR} \sim dnorm(0, 0.000001)$ $\delta.diff_{TNR.C} \sim dnorm(0, 0.000001)$ $\delta.diff_{TR.C} \sim dnorm(0, 0.000001)$
<p>Assumptions:</p> <ul style="list-style-type: none"> the treatments effects are independent PNR: unconstrained difference between PR and PNR: pooled using FE difference between TNR and PNR: treatments as independent; pooled within treatments using FE difference between TR and PNR: treatments as independent; pooled within treatments using FE 	<p>Assumptions:</p> <ul style="list-style-type: none"> a random effect is used to describe differences between treatments (exchangeability is assumed) PNR: unconstrained difference between PR and PNR: pooled using FE difference between TNR and PNR: treatments as independent; pooled within treatments using FE difference between TR and PNR: treatments as independent; pooled within treatments using FE 	<p>Assumptions:</p> <ul style="list-style-type: none"> the treatments effects are equal within class PNR: unconstrained difference between PR and PNR: pooled using FE difference between TNR and PNR: treatments as independent; pooled within treatments using FE difference between TR and PNR: treatments as independent; pooled within treatments using FE

FE, fixed effect; PNR, placebo non-responder; TNR, treatment non-responder.

Changes in HAQ-DI scores in all groups are assumed relative to changes in HAQ-DI in PNRs – μ_{PNRi} . This parameter was left unconstrained (allowed to differ between trials), and non-informative normal prior distributions were assigned (*baseline*). The relative effects of placebo on those who respond in the placebo arm ($\delta.diff_{PR}$) were assumed to be additive to μ_{PNRi} and were pooled across trials. The relative effects of treatments on those who do not respond ($\delta.diff_{TNRj}$) and on those who respond ($\delta.diff_{TRj}$) are additive to μ_{PNRi} , and were assumed to be treatment specific. In pooling these parameters, we assumed fixed effects across studies. Within a fixed-effects model, parameters $\delta.diff_{PR}$, $\delta.diff_{TNRj}$, and $\delta.diff_{TRj}$ were assigned non-informative normal prior distributions.

Detailed results for the biologic-naive subpopulation

Summary results of Health Assessment Questionnaire-Disability Index changes conditional on Psoriatic Arthritis Response Criteria response

The summary results from three models are presented in *Table 146* as absolute changes in HAQ-DI scores in relation to baseline.

Detailed results of Health Assessment Questionnaire-Disability Index changes conditional on Psoriatic Arthritis Response Criteria response

The results of HAQ-DI score changes conditional on PsARC response or non-response are presented in *Tables 147–149*.

TABLE 146 Results of HAQ-DI score changes (median) conditional on PsARC response and non-response in biologic-naive subpopulation

Treatments	Independent treatment		Exchangeable I class		Equal I class		PsARC response vs. non-response					
	FE		FE		FE							
	E1		E2 ^a		E3		E1	r ^b	E2 ^a	r ^b	E3	r ^b
Studies	PsARC response	PsARC non-response	PsARC response	PsARC non-response	PsARC response	PsARC non-response						
Placebo	-0.26		-0.26		-0.25		-0.26	10	-0.26	10	-0.25	4
150 mg of SEC	-0.39	-0.08	-0.44	-0.09			-0.31	8	-0.35	8		
300 mg of SEC	-0.55	-0.05	-0.51	-0.08	-0.47	-0.08	-0.49	1	-0.43	3	-0.39	1
UST	-0.49	-0.10	-0.48	-0.09			-0.39	4	-0.39	4		
CZP	-0.43	-0.07	-0.47	-0.12			-0.36	6	-0.35	7		
GOL	-0.44	-0.06	-0.49	-0.11	-0.52	-0.13	-0.38	5	-0.37	5	-0.39	1
ADA	-0.49	-0.13	-0.50	-0.13			-0.36	7	-0.37	6		
INF	-0.66	-0.20	-0.60	-0.14			-0.46	2	-0.46	1		
ETN	-0.64	-0.20	-0.59	-0.14			-0.44	3	-0.45	2		
APR	-0.36	-0.09	-0.36	-0.09	-0.36	-0.09	-0.27	9	-0.27	9	-0.27	3
DIC	-126.0		-133.0		-131.4							

FE, fixed effect.

a Shrunken estimates.

b Ranking of treatments according to point estimates.

TABLE 147 Results of model E1: treatment effects (treatment, independent; difference between PR/TNR/TR and PNR pooled using fixed effects)

Treatment	HAQ-DI score changes in PsARC response in relation to PNR			HAQ-DI score changes in PsARC non-response in relation to PNR		
	Mean	Median	95% CrI	Mean	Median	95% CrI
Placebo/baseline effect	-0.263	-0.263	-0.301 to -0.224			
150 mg of SEC	-0.394	-0.395	-0.553 to -0.236	-0.083	-0.083	-0.389 to 0.220
300 mg of SEC	-0.547	-0.547	-0.722 to -0.369	-0.053	-0.053	-0.288 to 0.182
UST	-0.488	-0.488	-0.597 to -0.379	-0.098	-0.097	-0.208 to 0.012
CZP	-0.429	-0.429	-0.530 to -0.326	-0.069	-0.069	-0.194 to 0.057
GOL	-0.439	-0.439	-0.585 to -0.293	-0.063	-0.064	-0.182 to 0.055
ADA	-0.489	-0.489	-0.583 to -0.395	-0.135	-0.134	-0.237 to -0.032
INF	-0.660	-0.660	-0.771 to -0.548	-0.196	-0.196	-0.311 to -0.083
ETN	-0.640	-0.640	-0.767 to -0.515	-0.200	-0.200	-0.348 to -0.054
APR	-0.362	-0.362	-0.432 to -0.291	-0.089	-0.089	-0.157 to -0.022
DIC	-125.96					

Preferred models

The model fit statistics (DIC) indicate that neither class effect model (E2 or E3) is a better fit for the data than the unadjusted, independent treatments model (E1). The fit of both of the class effect models was similar, but the one that allowed exchangeability within classes (E2) was considered to be the most clinically plausible. For the purposes of the economic model in *Chapter 6*, models E1 and E2 were the preferred models.

Comparison of the network meta-analysis of Health Assessment Questionnaire-Disability Index score changes conditional on Psoriatic Arthritis Response Criteria response/non-response in the company submissions (Novartis and UCB Pharma), a previous multiple technology appraisal (Rodgers et al.) and the current Assessment Group

The previous MTA by Rodgers *et al.*³³ and the current AG assessment conducted a NMA for HAQ-DI score changes conditional on PsARC response/non-response outcome using Bayesian methods. Novartis did not conduct a meta-analysis for this outcome. UCB Pharma conducted meta-analysis for HAQ-DI score change in PsARC responders and non-responders with data extracted from Rodgers *et al.*³³ The HTA report assumed an additive effect for the effect of treatment in TRs versus that for PRs (UCB Pharma's submission, p. 133). Although results of the analysis were presented in the economic section of UCB Pharma's submission, detailed information about evidence synthesis was not provided. Hence, it is difficult to compare UCB Pharma's submission with the AG evidence synthesis. The key assumptions for the NMA are presented in *Table 150*.

As mentioned before, the NMA of UCB Pharma is difficult to compare with the AG's NMA; therefore, only the NMA of Rodgers *et al.*³³ was compared with the AG's NMA.

A key difference between the NMAs presented is the trials included in each analysis. The AG's NMA includes nine active treatments and 13 trials, whereas the Rodgers *et al.*³³ analysis was limited to the treatments available at that time. Another key difference between Rodgers *et al.*³³ and AG's analyses was the assumption of the effects on studies. Rodgers *et al.*³³ assumed random effect on studies, whereas the AG considered fixed effect on studies. Despite differences in model assumption, the results of the current assessment are fairly similar to those of Rodgers *et al.*³³ (*Table 151*).

TABLE 148 Results of model E2: treatment effects [treatment, exchangeable I class (ILs, anti-TNF), APR = independent; difference between PR/TNR/TR and PNR pooled using fixed effects]

Treatment	HAQ-DI score changes in PsARC response in relation to PNR						HAQ-DI score changes in PsARC non-response in relation to PNR					
	Predicted mean			Shrunken/independent estimates			Predicted mean			Shrunken/independent estimates		
	Mean	Median	95% CrI	Mean	Median	95% CrI	Mean	Median	95% CrI	Mean	Median	95% CrI
Placebo				-0.258	-0.258	-0.296 to -0.220						
150 mg of SEC				-0.432	-0.435	-0.557 to -0.294				-0.085	-0.085	-0.228 to 0.057
300 mg of SEC	-0.475	-0.474	-0.751 to -0.203	-0.512	-0.509	-0.658 to -0.378	-0.083	-0.083	-0.253 to 0.086	-0.077	-0.078	-0.205 to 0.062
UST				-0.481	-0.480	-0.580 to -0.383				-0.088	-0.087	-0.186 to 0.009
CZP				-0.468	-0.470	-0.558 to -0.370				-0.116	-0.118	-0.196 to -0.021
GOL				-0.482	-0.486	-0.594 to -0.354				-0.110	-0.114	-0.188 to -0.013
ADA	-0.530	-0.529	-0.784 to -0.279	-0.499	-0.500	-0.581 to -0.414	-0.130	-0.130	-0.274 to 0.012	-0.133	-0.132	-0.209 to -0.058
INF				-0.605	-0.603	-0.716 to -0.502				-0.147	-0.144	-0.240 to -0.071
ETN				-0.593	-0.591	-0.717 to -0.486				-0.147	-0.143	-0.255 to -0.063
APR				-0.361	-0.361	-0.430 to -0.289				-0.088	-0.088	-0.155 to -0.020
DIC	-133.03											

TABLE 149 Results of model E3: treatment effects [treatment, equal I class (ILs, anti-TNF), APR = independent; difference between PR/TNR/TR and PNR pooled using fixed effects]

Treatment	HAQ-DI score changes in PsARC response in relation to PNR			HAQ-DI score changes in PsARC non-response in relation to PNR		
	Mean	Median	95% CrI	Mean	Median	95% CrI
Placebo/baseline effect	-0.254	-0.254	-0.291 to -0.217			
ILs as class	-0.473	-0.473	-0.554 to -0.393	-0.083	-0.083	-0.176 to 0.013
Anti-TNFs as class	-0.524	-0.524	-0.575 to -0.474	-0.131	-0.131	-0.185 to -0.077
APR	-0.359	-0.359	-0.430 to -0.290	-0.087	-0.087	-0.155 to -0.018
DIC	-131.37					

TABLE 150 Comparison of evidence synthesis of HAQ-DI score changes conditional on PsARC response/non-response in UCB Pharma's submission, a previous MTA³³ and the current AG

Domains compared	Rodgers <i>et al.</i> , 2011 ³³	UCB Pharma	AG ^a
Key assumptions for model	<ul style="list-style-type: none"> • Random effect on studies • For each of the different trials the true effect may be study specific and vary across studies but remain common across biologics • Changes in HAQ-DI score considering PNRs as common baseline • Effects of treatment response and non-response on HAQ-DI score change are treatment specific and additive to the placebo probability of non-response • Difference between treatment response and placebo non-response pooled within treatments using random effect • Difference between treatment non-response and placebo non-response pooled within treatments using random effect • Difference between placebo response and placebo non-response pooled using random effect 	<ul style="list-style-type: none"> • Not clear from the submission 	<ul style="list-style-type: none"> • Fixed effect on studies • Treatments effects are independent • Changes in HAQ-DI score considering PNRs as common baseline and considered trial specific • Effects of treatment response and non-response on HAQ-DI score change are treatment specific and additive to placebo non-response • Difference between treatment response and placebo non-response pooled within treatments using fixed effect • Difference between treatment non-response and placebo non-response pooled within treatments using fixed effect • Difference between placebo response and placebo non-response pooled using fixed effect
Time points	HAQ-DI at 12 weeks conditional on PsARC response at 12 weeks	At 24 weeks	HAQ-DI at 12 weeks conditional on PsARC response at 12 weeks
Results reported	Changes in HAQ-DI given PsARC response/non-response to treatment	Changes in HAQ-DI given PsARC response/non-response to treatment ^b	Changes in HAQ-DI given PsARC response/non-response to treatment
Data regarding subpopulation of biologic naive			
Studies used in the analysis	ADEPT; ⁵⁵ Genovese <i>et al.</i> ; ⁵⁶ IMPACT; ⁵¹ IMPACT 2; ⁵² and Mease <i>et al.</i> ^{53,54}	ADEPT; ⁵⁵ FUTURE 2; ⁴⁸ GO-REVEAL; ⁵⁰ IMPACT 2; ⁵² SPIRIT-P1; ^{57,67} Mease <i>et al.</i> ; ⁵⁴ and RAPID-PsA ⁴⁷ (24 weeks)	ADEPT; ⁵⁵ FUTURE 2; ⁴⁸ Genovese <i>et al.</i> ; ⁵⁶ GO-REVEAL; ⁵⁰ IMPACT; ⁵¹ IMPACT 2; ⁵² Mease <i>et al.</i> ; ⁵⁴ PALACE 1; ⁶⁰ PALACE 2; ⁶¹ PALACE 3; ⁶⁵ PSUMMIT 1; ⁵⁸ PSUMMIT 2; ^{59,66} and RAPID-PsA ⁴⁷

TABLE 150 Comparison of evidence synthesis of HAQ-DI score changes conditional on PsARC response/non-response in UCB Pharma's submission, a previous MTA³³ and the current AG (*continued*)

Domains compared	Rodgers <i>et al.</i> , 2011 ³³	UCB Pharma	AG ^a
Drugs evaluated	40 mg of ADA; 5 mg/kg INF; and 25 mg of ETN	40 mg of ADA; CZP; 25 mg of ETN; 50 mg of GOL; 5 mg/kg of INF; and SEC	40 mg of ADA; 30 mg of APR; CZP; 25 mg of ETN; 50 mg of GOL; 5 mg/kg of INF; 150 and 300 mg of SEC; and 45 mg of UST
Data regarding subpopulation of biologic experienced			
Studies used in the analysis	–	FUTURE 2; ⁴⁸ PSUMMIT 2; ^{59,66} and RAPID-PsA ⁴⁷ (24 weeks)	FUTURE 2; ⁴⁸ and PSUMMIT 2 ^{59,66}
Drugs evaluated	–	CZP; SEC; and 45 mg of UST	300 mg of SEC; and 45 mg of UST
<p>a To compare with CS and previous MTA, AG only presented independent treatment effect model assumptions.</p> <p>b Results reported in economic section of the submission.</p>			

TABLE 151 The HAQ-DI score changes conditional on PsARC response model results in the biologic-naive subpopulation

Treatment	Rodgers <i>et al.</i> (2011), ³³ mean (95% CrI)	AG (independent treatments), median (95% CrI)
HAQ-DI score changes conditional on PsARC response		
Placebo	-0.244 (-0.337 to -0.151)	-0.263 (-0.301 to -0.224)
150 mg of SEC	NC	-0.395 (-0.553 to -0.236)
300 mg of SEC	NC	-0.547 (-0.722 to -0.369)
CZP	NC	-0.429 (-0.530 to -0.326)
UST	NC	-0.488 (-0.597 to -0.379)
GOL	NC	-0.439 (-0.585 to -0.293)
ADA	-0.477 (-0.596 to -0.351)	-0.489 (-0.583 to -0.395)
INF	-0.657 (-0.793 to -0.523)	-0.660 (-0.771 to -0.548)
ETN	-0.630 (-0.805 to -0.455)	-0.640 (-0.767 to -0.515)
APR	NC	-0.362 (-0.432 to -0.291)
HAQ-DI score changes conditional on PsARC non-response		
150 mg of SEC	NC	-0.083 (-0.389 to 0.220)
300 mg of SEC	NC	-0.053 (-0.288 to 0.182)
CZP	NC	-0.069 (-0.194 to 0.057)
UST	NC	-0.097 (-0.208 to 0.012)
GOL	NC	-0.064 (-0.182 to 0.055)
ADA	-0.130 (-0.188 to 0.065)	-0.134 (-0.237 to -0.032)
INF	-0.194 (-0.333 to -0.057)	-0.196 (-0.311 to -0.083)
ETN	-0.190 (-0.381 to 0.000)	-0.200 (-0.348 to -0.054)
APR	NC	-0.089 (-0.157 to -0.022)
NC, not conducted.		

*WinBUG codes of preferred model**Model E1:*

```

model {
  for (i in 1:13) {
    prec.HAQ.TR[i] <- 1/(se.HAQ.TR[i] *se.HAQ.TR[i])
    prec.HAQ.PR[i] <- 1/(se.HAQ.PR[i]*se.HAQ.PR[i])
    prec.HAQ.TNR[i] <- 1/(se.HAQ.TNR[i] * se.HAQ.TNR[i])
    prec.HAQ.PNR[i] <- 1/(se.HAQ.PNR[i] * se.HAQ.PNR[i])

    HAQ.TR[i] ~ dnorm(TR[i], prec.HAQ.TR[i])
    HAQ.PR[i] ~ dnorm(PR[i], prec.HAQ.PR[i])
    HAQ.TNR[i] ~ dnorm(TNR[i], prec.HAQ.TNR[i])
    HAQ.PNR[i] ~ dnorm(PNR[i], prec.HAQ.PNR[i])

    PNR[i]<-baselineHAQ[i]
    PR[i] <- baselineHAQ[i]+ PR.diff

    TNR[i] <-baselineHAQ[i]+ TNR.diff[trial.tnf[i]]
    TR[i] <-baselineHAQ[i]+ TR.diff[trial.tnf[i]]
  }
  baselineHAQ[i]~ dnorm(0,0.000001)
  for (j in 1:9) {
    TR.diff[j]~ dnorm(0,0.000001)
    TNR.diff[j]~ dnorm(0,0.000001)
  }
  PR.diff~ dnorm(0,0.000001)
  for (i in 1:13) { HAQ.PNR[i] ~dnorm(0,0.000001);
  }
}

```

Model E2:

```

model {
  for (i in 1:13) {
    prec.HAQ.TR[i] <- 1/(se.HAQ.TR[i] *se.HAQ.TR[i])
    prec.HAQ.PR[i] <- 1/(se.HAQ.PR[i]*se.HAQ.PR[i])
    prec.HAQ.TNR[i] <- 1/(se.HAQ.TNR[i] * se.HAQ.TNR[i])
    prec.HAQ.PNR[i] <- 1/(se.HAQ.PNR[i] * se.HAQ.PNR[i])

    HAQ.TR[i] ~ dnorm(TR[i], prec.HAQ.TR[i])
    HAQ.PR[i] ~ dnorm(PR[i], prec.HAQ.PR[i])
    HAQ.TNR[i] ~ dnorm(TNR[i], prec.HAQ.TNR[i])
    HAQ.PNR[i] ~ dnorm(PNR[i], prec.HAQ.PNR[i])

    baselineHAQ[i] ~ dnorm(0,0.000001)

    PNR[i]<-baselineHAQ[i]
    PR[i] <- baselineHAQ[i]+ PR.diff

    TNR[i] <-baselineHAQ[i]+ TNR.diff[trial.tnf[i]]
    TR[i] <-baselineHAQ[i]+ TR.diff[trial.tnf[i]]
  }

  for (i in 1:2) {TR.diff[i] ~ dnorm(D.TR.c[1], prec.TR)}
  TR.diff[3] ~ dnorm(D.TR.c[2], prec.TR)
  TR.diff[4] ~ dnorm(D.TR.c[1], prec.TR)
  for (i in 5:8) {TR.diff[i] ~ dnorm(D.TR.c[2], prec.TR)}
  TR.diff[9] <- D.TR.c[3]

  for (i in 1:2) {TNR.diff[i] ~ dnorm(D.TNR.c[1], prec.TNR)}
}

```

```

TNR.diff[3] ~ dnorm(D.TNR.c[2], prec.TNR)
TNR.diff[4] ~ dnorm(D.TNR.c[1], prec.TNR)
for (i in 5:8) {TNR.diff[i] ~ dnorm(D.TNR.c[2], prec.TNR)}
TNR.diff[9] <- D.TNR.c[3]

for (j in 1:3) {
  D.TR.c[j]~ dnorm(0,0.000001)
  D.TNR.c[j]~ dnorm(0,0.000001)
}
for (j in 1:2) {
  D.pred.TR[j]~dnorm(D.TR.c[j],prec.TR)
  D.pred.TNR[j]~dnorm(D.TNR.c[j],prec.TNR)
}
prec.TR<-1/(sd.TR*sd.TR)
sd.TR~dunif(0,10)
prec.TNR<-1/(sd.TNR*sd.TNR)
sd.TNR~dunif(0,10)

PR.diff~ dnorm(0,0.000001)
for (i in 1:13) { HAQ.PNR[i] ~dnorm(0,0.000001)}
}
d[1]=SEC150, d[2]=SEC300, d[3]=CZP, d[4]=UST, d[5]=GOL, d[6]=ADA, d[7]=INF, d[8]=ETA, d[9]=APR

```

Psoriasis Area and Severity Index response

Detailed methods for the biologic-naive subpopulation

Treatment effect models

The NMA for PASI utilised a framework of analysis that evaluated the probability of PASI responses in different categories of PASI thresholds (50/75/90) within a single model: the single model included all categories of PASI and generated a single effect estimate for each treatment and also probabilities of achieving PASI 50, PASI 75 and PASI 90. Specifically, the model considered a multinomial likelihood and a probit link for ordered categorical data.¹¹⁷

In brief, trials report r_{ikj} , the number of patients in arm k of trial i belonging to different, mutually exclusive categories $j = 1, 2, 3$, where these categories represent the different thresholds of PASI score (e.g. 50%, 75%, or 90% improvement). The responses for each arm k of trial i in category j follows a multinomial distribution as:

$$r_{i,k,j=1,\dots,j} \sim \text{Multinomial}(p_{i,k,j=1,\dots,j}, n_{i,k}) \text{ with } \sum_{j=1}^3 p_{i,k,j} = 1, \quad (5)$$

which has been parameterised as a series of conditional binomial distributions, with parameters of interest the probabilities, p_{ikj} , that a patient in arm k ($k = 1, 2, 3$) of trial i ($i = 1, \dots$; see *Table 153*) belongs to category j ($j = 1, 2, 3$). We use the probit link function, the inverse of the normal cumulative distribution function Φ , to define the p_{ikj} as a function of a set of threshold values, z_j . The threshold values (estimated within the model) are such that the probability that the standard normal (probit score) will take a value $\leq z_1$ will reflect the probability of obtaining a PASI response of $< 50\%$, that is, $1 - \text{PASI } 50$. The probability that the standard normal will take a value $\leq z_2$ will reflect the probability of obtaining a PASI response of $< 75\%$, that is, $1 - \text{PASI } 75$, and, analogously, evaluating Φ at z_3 will approximate $1 - \text{PASI } 95$. Placebo and treatments are assumed to shift the mean of the distribution. This means that the pooled effect of taking the experimental treatment instead of the control is to change the probit score (or z-score) of the control arm, by $d_{i,j}$ SDs. Therefore, the model is written as $p_{ikj} = \Phi(\mu_i + z_j + \delta_{i,1k} I_{(k \neq 1)})$. The terms z_j as the differences on the standard normal scale between the response to category j and the response to category $j-1$ in all the arms of trial i .

We assumed that the baselines, μ_i , were trial specific (unconstrained) and were given non-informative prior. A non-informative prior was assigned to the treatment effects parameter (δ_i). A uniform prior was assigned to the parameter z_j .

Analogously to the analyses on PsARC, alternative assumptions were tested in two analyses. The first assumed independent treatment effects and did not include any metaregression for placebo effects (model F1). As the number of trials to inform each treatment effect was small, a fixed-effect model was used. In a second analysis, we explored the impact on treatment effects of adjusting for placebo responses [i.e. baseline effects (metaregression model)]. As can be seen from *Chapter 4, Data*, there are large differences between trials for PASI responses in placebo arms, ranging between 0% and 27% (0% in IMPACT⁵¹ and 27% in the RAPID-PsA⁴⁷ trial). IMPACT⁵¹ had very small sample size and reported 0% response in placebo arm and 100% response in treatment arm, which leads to very extreme values for placebo adjustment. Therefore, IMPACT⁵¹ could not be included in the metaregression analysis. Unlike the analysis for PsARC, for PASI we did not assume a class effect as the evidence from individual trials does not support such an assumption. *Table 152* presents the key assumptions for the models implemented for PASI response and detailed coding of the models is presented in *Table 153*.

Model F1 considers that treatments are independent of each other and fixed effect on cut-off points/thresholds. Model G1 considers the same assumption as model F1, but IMPACT was excluded from the analysis. Model G2 assumes treatments are independent of each other, but treatment effects are adjusted with the trial-specific baseline effects assuming a common interaction term (beta).

TABLE 152 Summary of models implemented for evidence synthesis of PASI response

Sets of analyses	Between-studies assumption	Treatment	Metaregression	Thresholds (i.e. cut-off points)	Baseline effect for metaregression
F1	FE	Independent	No baseline adjustment	FE	–
G1	FE	Independent	No baseline adjustment	FE	–
G2	FE	Independent	Common interaction term with baseline effect	FE	Adjusted with trial-specific baseline effects

FE, fixed effect.

TABLE 153 Description of models and underlying assumptions for PASI response and ACR response

Models F1 and G1	Model G2
<p><i>Likelihood</i> $r_{ikj} \sim \text{Binomial}(p_{ikj}, n_{ikj})$</p> <p><i>Model</i> $q_{ikj} = 1 - (p_{ikC_{i,j+1}} / p_{ikC_{i,j}})$ $\theta_{ikj} = \mu_i + \delta_{i,k} - \delta_{i,j} + Z_j$ $p_{ikC_j} = 1 - AD_{ikj}$ $AD_{ikj} = \phi(\theta_{ik, j-1})$</p> <p><i>Priors</i> $\delta_i \sim \text{dnorm}(0, 0.000001)$ $\mu_i \sim \text{dnorm}(0, 0.000001)$ $Z_j \sim \text{dunif}(0, 5)$</p> <p>Assumptions:</p> <ul style="list-style-type: none"> • baselines are unconstrained • treatments effects are independent • fixed effects between studies • fixed effect for each of the $j-1$ categories over all trials 	<p><i>Likelihood</i> $r_{ikj} \sim \text{Binomial}(p_{ikj}, n_{ikj})$</p> <p><i>Model</i> $q_{ikj} = 1 - (p_{ikC_{i,j+1}} / p_{ikC_{i,j}})$ $\theta_{ikj} = \mu_i + \delta_{i,k} - \delta_{i,j} + Z_j + \beta(\mu_i - \bar{\mu})$ $p_{ikC_j} = 1 - AD_{ikj}$ $AD_{ikj} = \phi(\theta_{ik, j-1})$</p> <p><i>Priors</i> $\delta_i \sim \text{dnorm}(0, 0.01)$ $\mu_i \sim \text{dnorm}(0, 0.01)$ $\beta \sim \text{dnorm}(0, 0.01)$ $Z_j \sim \text{dunif}(0, 5)$</p> <p>Assumptions:</p> <ul style="list-style-type: none"> • baselines are unconstrained • treatments effects are independent • fixed effects between studies • fixed effect for each of the $j-1$ categories over all trials • common interaction term between studies

The preferred model was used to evaluate estimated probability of achieving PASI 50, PASI 75, PASI 90 responses on treatment t , using $T_{jt} = 1 - \Phi(A + \delta_t + z_j)$, where A is the pooled baseline effect described below.

We adopted the WinBUG code presented in the decision support unit technical support document 2¹¹⁷ for the analysis although we identified that the model was not specifying the z-score correctly in the linear predictor specification when the first category of the response data (in this case PASI 50) was missing. A correction was made to incorporate the correct specification for the z-score in the linear predictor specification.

Baseline effect

The baseline effect, A , was estimated as $A = \frac{\sum \mu_{i1}}{NS}$, where μ_{i1} is the baseline effects, where i is the studies and $1 = \text{placebo}$; NS is the number of studies (in this case NS = 13).

Detailed results for the biologic-naive subpopulation

Summary results of Psoriasis Area and Severity Index response

Table 154 presents the results of the treatment effects for PASI responses estimated from the three models with measures of goodness of fit. There were no issues with convergence.

TABLE 154 Results of PASI response: treatment effects (median) on a probit scale in the biologic-naive subpopulation

Metaregression	No		No		Yes	
Treatments	Ind		Ind		Ind	
Cut-off points	FE		FE		FE	
	F1	r ^a	G1	r ^a	G2	r ^a
Placebo	1.024	–	0.983	–	1.015	–
300 mg of SEC	–1.936	2	–1.932	2	–1.864	1
150 mg of SEC	–1.870	3	–1.865	3	–1.798	2
CZP	–0.875	7	–0.873	7	–1.424	4
UST	–1.134	6	–1.131	6	–1.342	6
GOL	–1.645	4	–1.635	4	–1.141	7
ADA	–1.477	5	–1.476	5	–1.422	5
INF	–2.412	1	–2.276	1	–1.798	2
ETN	–0.798	8	–0.797	8	–0.849	8
APR	–0.749	9	–0.748	9	–0.815	9
Beta	–		–		–1.310	
Residual deviance	76.6 ^b		62.5 ^c		58.4 ^c	
DIC	318.9		297.2		293.7	

FE, fixed effect; ind, independent.

a Ranking of treatments according to point estimates.

b Compared 65 data points.

c Compared 61 data points.

Detailed results of Psoriasis Area and Severity Index response

More detailed results of the models F1, G1 and G2 are presented in *Tables 155–157*.

Preferred models

The results of models G1 and F1 are similar except for a small effect on the estimate of effect for INF; therefore, model F1 is the preferred unadjusted model as it does not exclude a trial. In model G2, DIC and residual deviance are lower than model G1, indicating that the model fits well with the existing data and the data support the assumption of adjustment with baseline effects. Therefore, we considered models F1 and G2 to be our preferred models.

Comparison of evidence synthesis of Psoriasis Area and Severity Index responses in the company submissions (Novartis and UCB Pharma), a previous multiple technology appraisal (Rodgers et al.) and the current Assessment Group

Both the Novartis and the UCB Pharma submissions combined PASI response evidence using Bayesian evidence synthesis methods. Each of the two CSs estimated probability of achieving PASI responses in three categories (50/75/90) to inform the economic model. A brief comparison of the methods used with key model assumptions, by the AG, CS and previous MTA are presented in *Tables 158 and 159*.

As mentioned before, UCB Pharma and the AG included subpopulations in the main NMA and analysed both subpopulations (biologic naive and experienced) separately, whereas Novartis considered overall population as the main NMA, and the analysis included a more complete set of treatments and trials. This comparison refers to the Novartis' NMA of subpopulation (i.e. biologic naive).

TABLE 155 Results of model F1: treatment effects (on a probit scale) and the different cut-off points (PASI 50, PASI 75 and PASI 90)

Treatment/parameter	Treatment effects		
	Mean	Median	97% CrI
Baseline effect	1.025	1.024	0.903 to 1.149
300 mg of SEC	-1.941	-1.936	-2.628 to -1.280
150 mg of SEC	-1.877	-1.870	-2.540 to -1.238
CZP	-0.877	-0.875	-1.239 to -0.523
UST	-1.135	-1.134	-1.407 to -0.868
GOL	-1.647	-1.645	-2.100 to -1.212
ADA	-1.480	-1.477	-1.831 to -1.142
INF	-2.414	-2.412	-2.841 to -2.006
ETN	-0.801	-0.798	-1.639 to 0.025
APR	-0.750	-0.749	-0.987 to -0.513
z_1 , PASI 50	-	-	-
z_2 , PASI 75	0.586	0.585	0.523 to 0.651
z_3 , PASI 90	1.153	1.153	1.059 to 1.251
Residual deviance ^a	76.6		
DIC	318.948		

a Compared 65 data points.

TABLE 156 Results of model G1: treatment effects (on a probit scale) and the different cut-off points (PASI 50, PASI 75 and PASI 90)

Treatment/parameter	Treatment effects		
	Mean	Median	97% CrI
Baseline effect	0.984	0.983	0.867 to 1.103
300 mg of SEC	-1.935	-1.932	-2.612 to -1.287
150 mg of SEC	-1.869	-1.865	-2.528 to -1.236
CZP	-0.874	-0.873	-1.237 to -0.519
UST	-1.131	-1.131	-1.402 to -0.863
GOL	-1.641	-1.635	-2.097 to -1.212
ADA	-1.478	-1.476	-1.834 to -1.136
INF	-2.280	-2.276	-2.730 to -1.847
ETN	-0.800	-0.797	-1.645 to 0.021
APR	-0.748	-0.748	-0.983 to -0.510
z_1 , PASI 50	-	-	-
z_2 , PASI 75	0.578	0.577	0.516 to 0.642
z_3 , PASI 90	1.136	1.136	1.043 to 1.235
Residual deviance ^a	62.54		
DIC	297.153		

a Compared 61 data points.

TABLE 157 Results of model G2: treatment effects (on a probit scale) and the different cut-off points (PASI 50, PASI 75 and PASI 90)

Treatment/parameter	Treatment effects		
	Mean	Median	97% CrI
Baseline effect	1.016	1.015	0.888 to 1.153
300 mg of SEC	-1.860	-1.864	-2.330 to -1.363
150 mg of SEC	-1.793	-1.798	-2.231 to -1.316
CZP	-1.433	-1.424	-1.888 to -1.040
UST	-1.346	-1.342	-1.596 to -1.121
GOL	-1.127	-1.141	-1.499 to -0.667
ADA	-1.421	-1.422	-1.668 to -1.167
INF	-1.788	-1.798	-2.173 to -1.313
ETN	-0.846	-0.849	-1.478 to -0.198
APR	-0.816	-0.815	-0.999 to -0.640
Beta	-1.310	-1.297	-2.164 to -0.495
z_1 , PASI 50	-	-	-
z_2 , PASI 75	0.582	0.582	0.520 to 0.647
z_3 , PASI 90	1.141	1.141	1.044 to 1.238
Residual deviance ^a	58.44		
DIC	293.702		

a Compared 61 data points.

A key difference between the NMAs presented concerns the trials included in each analysis. Only the AG's NMA for the biologic-naive subgroup includes all comparators and all trials. The Rodgers *et al.*³³ analysis was limited to the treatments available at that time. The UCB Pharma analysis for the biologic-naive subgroup includes all treatments, but misses only some APR trials. The Novartis NMA for the biologic-naive subgroup does not include CZP or APR and does not include all trials for the other treatments. The AG considered to exclude the RAPID-PsA trial⁴⁷ in the NMA for the biologic-experienced subgroup, whereas UCB Pharma included the trial data in the analysis. Novartis did not conduct a NMA for this outcome for the biologic-experienced subgroup.

Another key difference between the models was the assumption of effects on studies. The AG and Rodgers *et al.*³³ consider fixed effects on studies, whereas UCB Pharma and Novartis consider random effect on studies for the biologic-naive subgroup and fixed effect on studies for the biologic-experienced subgroup analysis. Another difference was the primary time point used. The AG, a previous MTA and Novartis conducted analyses at the 12-week time point, whereas UCB Pharma conducted primary analysis at 24 weeks and a sensitivity analysis considering the 12-week time point.

Table 160 shows the NMA results for (probabilities of) PASI response for the biologic-naive subpopulation estimated by the four NMAs. Across all the analyses, INF has the highest effectiveness following SEC among the treatment evaluated. The estimated probabilities in the AG's analysis are more precise than either of the CSs.

Given the differences in model assumptions and the included studies, the results are slightly different for GOL, ADA and ETN. Between the previous and current assessment, differences in the ADA estimates are the result of additional data on ADA from the SPIRIT-P1.^{57,67} In the Novartis submission, the estimated probabilities are much lower for 50 mg of GOL. The differences are plausible as the AG and Novartis used

TABLE 158 Comparison of evidence synthesis of PASI responses in the CSs (Novartis and UCB Pharma), a previous MTA³³ and the current AG

Domains compared	CS			
	Rodgers <i>et al.</i> , 2011 ³³	Novartis	UCB Pharma	AG
Model	Conditional multinomial probit model	Conditional multinomial probit model	Conditional multinomial probit model	Conditional multinomial probit model
Results reported	Probability of PASI response in three categories: 50, 75 and 90	Probability of PASI response in three categories: 50, 75 and 90	Probability of PASI response in three categories: 50, 75 and 90	Probability of PASI response in three categories: 50, 75 and 90
Time points	At 12 weeks (data from the 12-week or closest time point after 12 weeks – normally 14 or 16 weeks)	At 12 weeks (data from the 12-week or closest time point after 12 weeks – normally 14 or 16 weeks)	Primary analysis at 24 weeks (by treatments), sensitivity analysis was conducted at 12 weeks including data on 12 weeks or closest time point after 12 weeks ^a	At 12 weeks (data from the 12-week or closest time point after 12 weeks – normally 14 or 16 weeks)
Comments		Modelled probabilities are presented graphically		
Data regarding subpopulation of biologic naive				
Studies used in the analysis	ADEPT, ⁵⁵ IMPACT, ⁵¹ IMPACT 2, ⁵² and Mease <i>et al.</i> ^{53,54}	ADEPT, ⁵⁵ FUTURE 2, ⁴⁸ GO-REVEAL, ⁵⁰ and IMPACT 2 ⁵²	ADEPT, ⁵⁵ GO-REVEAL, ⁵⁰ IMPACT, ⁵¹ IMPACT 2, ⁵² SPIRIT-P1, ^{57,67} Mease <i>et al.</i> , ⁵³ and RAPID-PsA ⁴⁷ (12–16 weeks analysis)	ADEPT, ⁵⁵ FUTURE 2, ⁴⁸ GO-REVEAL, ⁵⁰ IMPACT, ⁵¹ IMPACT 2, ⁵² Mease <i>et al.</i> , ⁵³ PALACE 1, ⁶⁰ PALACE 2, ⁶¹ PALACE 3, ⁶⁵ PSUMMIT 1, ⁵⁸ PSUMMIT 2, ^{59,66} RAPID-PsA, ⁴⁷ and SPIRIT-P1 ^{57,67}
Drugs evaluated	40 mg of ADA; 5 mg/kg of INF; and 25 mg of ETN	40 mg of ADA; 50 mg of GOL and 100 mg; 5 mg/kg of INF; and 150 and 300 mg of SEC	40 mg of ADA; 400 mg of CZP; 25 mg of ETN; 50 mg of GOL; and 5 mg/kg of INF	40 mg of ADA; 30 mg of APR; 400 mg of CZP; 25 mg of ETN; 50 mg of GOL; 5 mg/kg of INF; 150 and 300 mg of SEC; and 45 mg of UST
Data regarding subpopulation of biologic experienced				
Studies used in the analysis	–	–	FUTURE 2, ⁴⁸ PSUMMIT 2, ^{59,66} and RAPID-PsA ⁴⁷ (24-week analysis)	FUTURE 2, ⁴⁸ and PSUMMIT 2 ^{59,66}
Drugs evaluated	–	–	CZP; 300 mg of SEC; and 45 mg of UST	300 mg of SEC; and 45 mg of UST
a The AG considers results at 12 weeks to compare with our results.				

different sets of data and model assumptions. In the UCB Pharma submission, the estimated probabilities for ETN are much lower than obtained in previous and current assessments. The difference is largely because UCB Pharma used different PASI 50 response data in the analysis.

Rodgers *et al.*³³ and Novartis did not include an analysis for the treatment-experienced subgroup. *Table 161* presents the PASI results from the AG and UCB Pharma NMAs for the biologic-experienced subpopulation. However, the results are not comparable between the AG and UCB Pharma analyses as probabilities were estimated at two different time points (12 weeks and 24 weeks), and it is evident that the PASI response differs between these two time points.

TABLE 159 Key assumptions in the synthesis models for PASI responses in the CSs (Novartis and UCB Pharma), a previous MTA³³ and the current AG

Domains compared	Rodgers <i>et al.</i> , 2011 ³³	CS		
		Novartis	UCB Pharma	AG
Model	Conditional multinomial probit model	Conditional multinomial probit model	Conditional multinomial probit model	Conditional multinomial probit model
Fixed or random effects between studies	Fixed effects on studies	Random effects on studies for biologic-naive subpopulation analysis	Random effects on studies for biologic-naive subpopulation analysis and fixed effects for biologic-experienced subpopulation analysis	Fixed effects on studies (for both biologic-naive and biologic-experienced subpopulation)
Baselines	Common-effect model was used to estimate baseline	Common-effect model was used to estimate baseline	Common-effect model was used to estimate baseline	Common-effect model was used to estimate baseline
Treatment effects	Treatments were assumed to be independent of each other	Treatments were assumed to be independent of each other	Treatments were assumed to be independent of each other	Treatments were assumed to be independent of each other
Model adjusted for the placebo response	Unadjusted	Unadjusted	Unadjusted	Considered both unadjusted and adjusted model for biologic-naive subpopulation; considered unadjusted model for biologic-experienced subpopulation
Interaction term (beta)	–	–	–	Common interaction term for adjusted model
Probit/logit score thresholds	Thresholds were assumed to be fixed across trials	Thresholds were assumed to be fixed across trials	Thresholds were assumed to be fixed across trials	Thresholds were assumed to be fixed across trials

TABLE 160 Comparison of PASI response in the CSs (Novartis and UCB Pharma), a previous MTA³³ and the current AG in the biologic-naive subpopulation

Treatment	Probability of PASI responses in the biologic-naive subpopulation at 12 weeks (12–16 weeks)				
	Rodgers <i>et al.</i> (2011), ³³ mean (95% CrI)	CS		AG, median (95% CI)	
		Novartis, mean	UCB Pharma, mean (95% CI)	Unadjusted	Adjusted
Placebo					
PASI 50	0.131 (0.09 to 0.18)	Confidential information has been removed	Confidential information has been removed	0.15 (0.13 to 0.18)	0.16 (0.12 to 0.19)
PASI 75	0.045 (0.03 to 0.07)	Confidential information has been removed	Confidential information has been removed	0.05 (0.04 to 0.07)	0.06 (0.04 to 0.07)
PASI 90	0.017 (0.01 to 0.03)	Confidential information has been removed	Confidential information has been removed	0.02 (0.01 to 0.02)	0.02 (0.01 to 0.02)

TABLE 160 Comparison of PASI response in the CSs (Novartis and UCB Pharma), a previous MTA³³ and the current AG in the biologic-naive subpopulation (*continued*)

Treatment		Probability of PASI responses in the biologic-naive subpopulation at 12 weeks (12–16 weeks)				
		Rodgers <i>et al.</i> (2011), ³³ mean (95% CrI)	CS		AG, median (95% CI)	
			Novartis, mean	UCB Pharma, mean (95% CI)	Unadjusted	Adjusted
300 mg of SEC						
PASI 50	NC	Confidential information has been removed	NC	0.82 (0.61 to 0.94)	0.80 (0.62 to 0.91)	
PASI 75		Confidential information has been removed		0.63 (0.38 to 0.84)	0.60 (0.40 to 0.78)	
PASI 90		Confidential information has been removed		0.41 (0.19 to 0.67)	0.38 (0.21 to 0.58)	
150 mg of SEC						
PASI 50	NC	Confidential information has been removed	NC	0.80 (0.59 to 0.93)	0.78 (0.60 to 0.90)	
PASI 75		Confidential information has been removed		0.60 (0.36 to 0.82)	0.58 (0.38 to 0.75)	
PASI 90		Confidential information has been removed		0.38 (0.18 to 0.63)	0.36 (0.19 to 0.54)	
CZP						
PASI 50	NC	NC	Confidential information has been removed	0.44 (0.31 to 0.59)	0.66 (0.50 to 0.82)	
PASI 75			Confidential information has been removed	0.23 (0.14 to 0.36)	0.43 (0.29 to 0.63)	
PASI 90			Confidential information has been removed	0.10 (0.05 to 0.18)	0.23 (0.13 to 0.41)	
UST						
PASI 50	NC	NC	NC	0.54 (0.44 to 0.65)	0.63 (0.52 to 0.74)	
PASI 75				0.32 (0.23 to 0.42)	0.40 (0.30 to 0.52)	
PASI 90				0.15 (0.09 to 0.22)	0.21 (0.14 to 0.31)	
50 mg of GOL						
PASI 50	NC	Confidential information has been removed	Confidential information has been removed	0.73 (0.58 to 0.86)	0.55 (0.36 to 0.70)	
PASI 75		Confidential information has been removed	Confidential information has been removed	0.51 (0.35 to 0.68)	0.32 (0.17 to 0.48)	
PASI 90		Confidential information has been removed	Confidential information has been removed	0.30 (0.17 to 0.47)	0.15 (0.07 to 0.27)	

continued

TABLE 160 Comparison of PASI response in the CSs (Novartis and UCB Pharma), a previous MTA³³ and the current AG in the biologic-naïve subpopulation (*continued*)

Treatment	Probability of PASI responses in the biologic-naïve subpopulation at 12 weeks (12–16 weeks)				
	Rodgers <i>et al.</i> (2011), ³³ mean (95% CrI)	CS		AG, median (95% CI)	
		Novartis, mean	UCB Pharma, mean (95% CI)	Unadjusted	Adjusted
ADA					
PASI 50	0.738 (0.55 to 0.88)	Confidential information has been removed	Confidential information has been removed	0.68 (0.55 to 0.78)	0.66 (0.54 to 0.76)
PASI 75	0.477 (0.28 to 0.69)	Confidential information has been removed	Confidential information has been removed	0.45 (0.32 to 0.58)	0.43 (0.32 to 0.55)
PASI 90	0.257 (0.12 to 0.45)	Confidential information has been removed	Confidential information has been removed	0.24 (0.15 to 0.36)	0.23 (0.15 to 0.33)
INF					
PASI 50	0.913 (0.82 to 0.97)	Confidential information has been removed	Confidential information has been removed	0.92 (0.84 to 0.96)	0.78 (0.61 to 0.88)
PASI 75	0.769 (0.59 to 0.90)	Confidential information has been removed	Confidential information has been removed	0.79 (0.67 to 0.88)	0.58 (0.39 to 0.73)
PASI 90	0.557 (0.35 to 0.77)	Confidential information has been removed	Confidential information has been removed	0.59 (0.44 to 0.73)	0.36 (0.20 to 0.52)
ETN					
PASI 50	0.403 (0.24 to 0.59)	NC	Confidential information has been removed	0.41 (0.15 to 0.72)	0.43 (0.20 to 0.69)
PASI 75	0.177 (0.09 to 0.31)		Confidential information has been removed	0.21 (0.05 to 0.50)	0.23 (0.08 to 0.47)
PASI 90	0.074 (0.03 to 0.15)		Confidential information has been removed	0.08 (0.01 to 0.29)	0.10 (0.02 to 0.26)
APR					
PASI 50	NC	NC	NC	0.39 (0.31 to 0.49)	0.42 (0.33 to 0.52)
PASI 75				0.20 (0.14 to 0.27)	0.22 (0.16 to 0.30)
PASI 90				0.08 (0.05 to 0.12)	0.09 (0.06 to 0.14)

NC, not conducted.

TABLE 161 Comparison of PASI response in the UCB Pharma submission and the current AG in the biologic-experienced subpopulation

Treatment	Probability of PASI responses in the biologic-experienced subpopulation, mean (95% CrI)	
	UCB Pharma, at 24 weeks	AG, at 12 weeks (12–16 weeks)
Placebo		
PASI 50	Confidential information has been removed	0.088 (0.01 to 0.28)
PASI 75	Confidential information has been removed	0.012 (0.00 to 0.06)
PASI 90	Confidential information has been removed	0.002 (0.00 to 0.02)
300 mg of SEC		
PASI 50	Confidential information has been removed	0.875 (0.46 to 1.00)
PASI 75	Confidential information has been removed	0.598 (0.23 to 0.89)
PASI 90	Confidential information has been removed	0.365 (0.08 to 0.75)
UST		
PASI 50	Confidential information has been removed	0.628 (0.29 to 0.89)
PASI 75	Confidential information has been removed	0.279 (0.07 to 0.61)
PASI 90	Confidential information has been removed	0.120 (0.01 to 0.42)
CZP		
PASI 50	Confidential information has been removed	NC
PASI 75	Confidential information has been removed	NC
PASI 90	Confidential information has been removed	NC

NC, not conducted.

*WinBUG codes of preferred model**Model F1:*

```

model{
for(i in 1:N){
  p[i,1] <- 1
  for(j in 1:nc[i]-1) {
    r[i,j] ~ dbin(q[i,j],n[i,j])
    q[i,j] <- 1-(p[i,C[i,j+1]]/p[i,C[i,j]])
    z.index[i,j]<- C[i,j+1]-1
    theta[i,j] <- mu[s[i]] + (d[t[i]] - d[t[1]])*(1-equals(t[i],b[i])) + z[z.index[i,j]]
    rhat[i,j] <- q[i,j] * n[i,j]
    dv[i,j] <- 2 * (r[i,j]*(log(r[i,j])-log(rhat[i,j]))) + (n[i,j]-r[i,j])*(log(n[i,j]-r[i,j]) - log(n[i,j]-rhat[i,j])))
  }
  dev[i] <- sum(dv[i,1:nc[i]-1])
  for(j in 2:nc[i]) {
    p[i,C[i,j]] <- 1 - phi.adj[i,j]
    phi.adj[i,j] <- phi(theta[i,j-1])
  }
}
totresdev <- sum(dev[])
z[1] <- 0
for(j in 2:Cmax-1) {
  z.aux[j] ~ dunif(0,5)
  z[j] <- z[j-1] + z.aux[j]
}
d[1] <- 0
for(k in 2:nt){ d[k] ~ dnorm(0,.0001) }
for(i in 1:ns){ mu[i] ~ dnorm(0,.000001)}
for(i in 1:ns) {mu1[i]<-mu[i]*equals(t[1],1)}
A<-sum(mu1[])/ns
# calculate prob of achieving PASI50,75,90 on treat k
for(k in 1:nt) {
for(j in 1: Cmax-1) { T[j,k] <- 1 - phi(A + d[k] + z[j]) }
}
}

```

Model G2:

```

model{
for(i in 1:N){
  p[i,1] <- 1
  for(j in 1:nc[i]-1) {
    r[i,j] ~ dbin(q[i,j],n[i,j])
    q[i,j] <- 1-(p[i,C[i,j+1]]/p[i,C[i,j]])
    z.index[i,j]<- C[i,j+1]-1
    theta[i,j] <- mu[s[i]] + d[t[i]] + z[z.index[i,j]]
      + betaplac * (mu[s[i]] - Mean) * (1-equals(t[i],1))
    rhat[i,j] <- q[i,j] * n[i,j]
    dv[i,j] <- 2 * (r[i,j]*(log(r[i,j])-log(rhat[i,j]))) + (n[i,j]-r[i,j])*(log(n[i,j]-r[i,j]) - log(n[i,j]-rhat[i,j])))
  }
  dev[i] <- sum(dv[i,1:nc[i]-1])
  for(j in 2:nc[i]) {
    p[i,C[i,j]] <- 1 - phi.adj[i,j]
    phi.adj[i,j] <- phi(theta[i,j-1])
  }
}
totresdev <- sum(dev[])

```

```

z[1] <- 0
for (j in 2:Cmax-1) {
  z.aux[j] ~ dunif(0,5)
  z[j] <- z[j-1] + z.aux[j]
}

d[1] <- 0
for (k in 2:nt) { d[k] ~ dnorm(0,0.01) }
for (i in 1:ns) { mu[i] ~ dnorm(0,0.01) }
betaplac ~ dnorm(0,0.01)
for (i in 1:ns) { mu1[i] <- mu[i]*equals(t[1],1) }
A <- sum(mu1[])/ns
# calculate prob of achieving PASI50,75,90 on treat k
for (k in 1:nt) {
  for (j in 1: Cmax-1) { T[j,k] <- 1 - phi(A + d[k] + z[j]) }
}
}
d[1]=PLA, d[2]=SEC300, d[3]=SEC150, d[4]=CZP, d[5]=UST, d[6]=GOL, d[7]=ADA, d[8]=INF, d[9]=ETA,
d[10]=APR

```

American College of Rheumatology response

Detailed methods for the biologic-naïve subpopulation

The NMA for ACR utilised a similar framework of analysis to that used to estimate probability of PASI responses. In brief, the model considered a multinomial likelihood and a probit link for ordered categorical data.¹¹⁷

Analogously to the analyses on PsARC, sets of alternative assumptions were tested. We explored the effect of differences in trial-specific placebo responses on treatment effect undertaking a metaregression. In the context of an adjusted model for placebo response, we explored the possibility of there being class effects. Three different class groupings were considered: all treatments as a single class; all biologics as a class with APR separate; and, to reflect the pharmacology, anti-TNFs grouped, ILs grouped and APR separate. Additionally, we explored two within-class assumptions: assuming treatments within a class to have equal effectiveness and, alternatively, assuming that those treatments within a class have similar (exchangeable) effectiveness. Fixed effects across studies were assumed for all models. We have not considered models assuming exchangeability between classes.

Summary of all treatment effect models explored

All models implemented for evidence synthesis of ACR response are presented in *Table 162*. Detailed coding of the models is presented in *Table 163*.

Model H1 considers that the effectiveness of each treatment is independent of the effectiveness of other treatments. Model I1 considers the relative effectiveness of the alternative treatments to be independent of the effectiveness of other treatments, but that the effectiveness of all treatments depends on the response in the placebo arm. Model J1 considers the treatments to be equal in terms of their effectiveness, but dependent on the effect of the placebo arm. Models J2 and J3 consider the treatments to be equal in terms of their effectiveness within class, but dependent on the effect of the placebo arm. Models K1 and K2 assume the treatments to have a similar, but not equal, effectiveness and to be dependent on the

TABLE 162 Key assumptions of models implemented for evidence synthesis of ACR response

Sets of analysis	Between studies assumption	Treatment	Metaregression	Class
H1	FE	Independent	No baseline adjustment	No class effect
I1	FE	Independent	Common interaction term with baseline effect	No class effect
J1	FE	Equal I class	Common interaction term with baseline effect	Independent class effect: class = {all treatments}
J2	FE	Equal I class, remaining treatments independent ^a		Independent class effect: class = APR independent {all remaining biologics}
J3	FE	Equal I class, remaining treatments independent ^a		Independent class effect: class = {anti-TNFs, ILs}; APR independent
K1	FE	Exchangeable I class, remaining treatments independent ^a	Common interaction term with baseline effect	Independent class effect: class = APR independent {all other biologics}
K2	FE	Exchangeable I class, remaining treatments independent ^a		Independent class effect: class = {anti-TNFs, ILs}; APR independent

FE, fixed effect.

^a APR independent.

TABLE 163 Description of models and underlying assumptions for ACR response

Model H1	Model I1
<p><i>Likelihood</i> $r_{ikj} \sim \text{Binomial}(p_{ikj}, n_{ikj})$</p> <p><i>Model</i> $q_{ikj} = 1 - (p_{ikC_i, j+1} / p_{ikC_i, j})$ $\theta_{ikj} = \mu_j + \delta_{t_{i,k}} - \delta_{t_{i,1}} + Z_j$ $p_{ikC_i} = 1 - AD_{ikj}$ $AD_{ikj} = \phi(\theta_{ik, j-1})$ <i>Priors(anti – TNF – naive – analysis)</i> $\delta_t \sim \text{dnorm}(0, 0.000001)$ $\mu_j \sim \text{dnorm}(0, 0.000001)$ $Z_j \sim \text{dunif}(0, 5)$ <i>Priors(anti – TNF – experienced – analysis)</i> $\delta_t \sim \text{dnorm}(0, 0.01)$ $\mu_j \sim \text{dnorm}(0, 0.01)$ $Z_j \sim \text{dunif}(0, 5)$</p> <p>Assumptions:</p> <ul style="list-style-type: none"> • baselines are unconstrained • treatments effects are independent • fixed effects between studies • fixed effect for each of the $j-1$ categories over all trials 	<p><i>Likelihood</i> $r_{ikj} \sim \text{Binomial}(p_{ikj}, n_{ikj})$</p> <p><i>Model</i> $q_{ikj} = 1 - (p_{ikC_i, j+1} / p_{ikC_i, j})$ $\theta_{ikj} = \mu_j + \delta_{t_{i,k}} - \delta_{t_{i,1}} + Z_j + \beta(\mu_j - \bar{\mu})$ $p_{ikC_i} = 1 - AD_{ikj}$ $AD_{ikj} = \phi(\theta_{ik, j-1})$ <i>Priors</i> $\delta_t \sim \text{dnorm}(0, 0.01)$ $\mu_j \sim \text{dnorm}(0, 0.01)$ $\beta \sim \text{dnorm}(0, 0.01)$ $Z_j \sim \text{dunif}(0, 5)$</p> <p>Assumptions:</p> <ul style="list-style-type: none"> • baselines are unconstrained • treatments effects are independent • fixed effects between studies • fixed effect for each of the $j-1$ categories over all trials • common interaction term between studies
Models J1, J2 and J3	Models K1 and K2
<p><i>Likelihood</i> $r_{ikj} \sim \text{Binomial}(p_{ikj}, n_{ikj})$</p> <p><i>Model</i> $q_{ikj} = 1 - (p_{ikC_i, j+1} / p_{ikC_i, j})$ $\theta_{ikj} = \mu_j + \delta_{t_{i,k}} - \delta_{t_{i,1}} + Z_j + \beta(\mu_j - \bar{\mu})$ $p_{ikC_i} = 1 - AD_{ikj}$ $AD_{ikj} = \phi(\theta_{ik, j-1})$ $\delta_t \sim \delta_c$ <i>Priors</i> $\delta_c \sim \text{dnorm}(0, 0.01)$ $\mu_j \sim \text{dnorm}(0, 0.01)$ $\beta \sim \text{dnorm}(0, 0.01)$ $Z_j \sim \text{dunif}(0, 5)$</p> <p>J1: class = {all biologics} J2: APR independent; class = {all other biologics} J3: class = {anti-TNFs, ILs}; APR independent</p> <p>Assumptions:</p> <ul style="list-style-type: none"> • baselines are unconstrained • the treatments effects are equal within class • fixed effects between studies • fixed effect for each of the $j-1$ categories over all trials • common interaction term between studies 	<p><i>Likelihood</i> $r_{ikj} \sim \text{Binomial}(p_{ikj}, n_{ikj})$</p> <p><i>Model</i> $q_{ikj} = 1 - (p_{ikC_i, j+1} / p_{ikC_i, j})$ $\theta_{ikj} = \mu_j + \delta_{t_{i,k}} - \delta_{t_{i,1}} + Z_j + \beta(\mu_j - \bar{\mu})$ $p_{ikC_i} = 1 - AD_{ikj}$ $AD_{ikj} = \phi(\theta_{ik, j-1})$ $\delta_t \sim \text{dnorm}(\text{Class}_c, 1/\gamma^2)$ <i>Priors</i> $\text{Class}_c \sim \text{dnorm}(0, 0.01)$ $\mu_j \sim \text{dnorm}(0, 0.01)$ $\beta \sim \text{dnorm}(0, 0.01)$ $Z_j \sim \text{dunif}(0, 5)$ $\gamma \sim \text{dunif}(0, 10)$</p> <p>K1: APR independent; class = {all other biologics} K2: class = {anti-TNFs, ILs}; APR independent</p> <p>Assumptions:</p> <ul style="list-style-type: none"> • baselines are unconstrained • a random effect is used to describe differences between treatments (exchangeability is assumed) • fixed effects between studies • fixed effect for each of the $j-1$ categories over all trials • common interaction term between studies

effect of the placebo arm; this model introduces more flexibility than those that assume treatment effects to be equal (models J2 and J3), but does not fully assume treatments to differ as in model H1. It does imply that there are differences between the effectiveness of treatments that we may not be able to explain but that we should consider. These may be a result of differences between the treatments themselves or because of differences in the design of the trials used to evaluate each treatment.

Detailed results for the biologic-naive subpopulation

Summary results of American College of Rheumatology response

Table 164 presents the results of the treatment effects for ACR responses estimated from the seven models with measures of goodness of fit. There were no issues with convergence.

Detailed results of American College of Rheumatology response

More detailed results of the models H1, I1, J1, J2, J3, K1 and K2 are presented in Tables 165–171.

Preferred models

The unadjusted model H1 fits the data as well as any of the other models and generates results that reflect the observed results. Considering the placebo-adjusted models, model I1 generated results (rankings) which do not reflect well the observed trial results; and it must be borne in mind that, without any clear rationale for the placebo effect, the results must be interpreted with caution. Using an assumption of equal class effect for the treatments does not produce a better-fitting model (models J1, J2 and J3) than assuming independent treatment effects (models H1 and I1) or similar (exchangeable) treatment effects (models K1 and K2). In addition, there was little difference in goodness-of-fit statistics (DIC and residual deviance) between models K1 and K2, and we consider the exchangeable class effect model, which utilised two classes (ILs and anti-TNFs) with APR separate, to be the most clinically plausible. Hence, our preferred models are models H1 and K2.

TABLE 164 Results of ACR response: treatment effects (median) on a probit scale in the biologic-naive subpopulation

Metaregression	No	Yes		Yes		Yes		Yes		Yes		Yes		
Treatments	Ind	Ind		= class {all}		= class (APR, other)		= class (ILs, TNFs, APR)		~ class ^a (APR, other)		~ class ^a (ILs, TNFs, APR)		
Cut-off points	FE		FE		FE		FE		FE		FE		FE	
	H1	r ^b	I1	r ^b	J1	r ^b	J2	r ^b	J3	r ^b	K1	r ^b	K2	r ^b
Placebo	0.952		0.961		0.882		0.966		0.966		0.963		0.961	
300 mg of SEC	-0.914	6	-1.397	2							-1.274	2	-1.236	3
150 mg of SEC	-0.932	5	-1.415	1			-1.094	1	-1.095	1	-1.283	1	-1.246	2
UST	-0.570	8	-0.722	8							-0.750	8	-0.732	8
CZP	-0.811	7	-1.265	3	-0.830	1					-1.193	5	-1.176	5
GOL	-1.429	2	-0.918	7							-1.010	7	-1.040	7
ADA	-1.072	4	-1.126	6					-0.609	2	-1.121	6	-1.124	6
INF	-1.617	1	-1.212	5							-1.246	3	-1.269	1
ETN	-1.362	3	-1.214	4							-1.215	4	-1.228	4
APR	-0.509	9	-0.592	9			-0.610	2	-0.014	3	-0.581	9	-0.576	9
Beta (mean)			-1.276		1.327		-1.627		-1.621		-1.099		-1.018	
Residual deviance ^c	120.0		119.1		156.1		148.3		148.3		120.0		120.4	
DIC	482.22		480.94		511.66		503.43		503.37		480.90		481.10	

= | class, equal class effect; ~ | class, exchangeable class effect; FE, fixed effect; ind, independent.

a Shrunken estimates.

b Ranking of active treatments according to point estimates.

c Compared with 92 data points.

TABLE 165 Results of model H1: treatment effects (on a probit scale) and the different cut-off points (ACR 20, ACR 50 and ACR 70)

Treatment/parameter	Treatment effects		
	Mean	Median	97% CrI
Baseline effect	0.952	0.952	0.874 to 1.031
300 mg of SEC	-0.915	-0.914	-1.319 to -0.512
150 mg of SEC	-0.932	-0.932	-1.347 to -0.525
UST	-0.570	-0.570	-0.797 to -0.349
CZP	-0.811	-0.811	-1.090 to -0.530
GOL	-1.431	-1.429	-1.810 to -1.068
ADA	-1.072	-1.072	-1.274 to -0.870
INF	-1.619	-1.617	-1.943 to -1.306
ETN	-1.364	-1.362	-1.688 to -1.050
APR	-0.509	-0.509	-0.672 to -0.346
z_1 , ACR 20	-	-	-
z_2 , ACR 50	0.661	0.661	0.615 to 0.709
z_3 , ACR 70	1.284	1.283	1.213 to 1.356
Residual deviance ^a	120.00		
DIC	482.22		

a Compared 92 data points.

TABLE 166 Results of model I1: treatment effects (on a probit scale) and the different cut-off points (ACR 20, ACR 50 and ACR 70)

Treatment/parameter	Treatment effects		
	Mean	Median	97% CrI
Baseline effect	0.962	0.961	0.880 to 1.046
300 mg of SEC	-1.402	-1.397	-1.890 to -0.939
150 mg of SEC	-1.421	-1.415	-1.920 to -0.953
UST	-0.725	-0.722	-0.939 to -0.526
CZP	-1.268	-1.265	-1.666 to -0.874
GOL	-0.910	-0.918	-1.362 to -0.433
ADA	-1.127	-1.126	-1.290 to -0.973
INF	-1.207	-1.212	-1.578 to -0.812
ETN	-1.209	-1.214	-1.455 to -0.931
APR	-0.594	-0.592	-0.738 to -0.459
Beta	-1.276	-1.297	-2.164 to -0.274
z_1 , ACR 20	-	-	-
z_2 , ACR 50	0.661	0.661	0.615 to 0.709
z_3 , ACR 70	1.283	1.282	1.212 to 1.356
Residual deviance ^a	119.10		
DIC	480.94		

a Compared 92 data points.

TABLE 167 Results of model J1: treatment effects (on a probit scale) and the different cut-off points (ACR 20, ACR 50 and ACR 70)

Treatment/parameter	Treatment effects		
	Mean	Median	97% CrI
Baseline effect	0.882	0.882	0.812 to 0.953
All biologics as a class	-0.825	-0.830	-0.992 to -0.624
Beta	1.327	1.236	0.399 to 2.792
z_1 , ACR 20	-	-	-
z_2 , ACR 50	0.656	0.655	0.610 to 0.702
z_3 , ACR 70	1.272	1.272	1.201 to 1.345
Residual deviance ^a	156.1		
DIC	511.66		

a Compared 92 data points.

TABLE 168 Results of model J2: treatment effects (on a probit scale) and the different cut-off points (ACR 20, ACR 50 and ACR 70)

Treatment/parameter	Treatment effects		
	Mean	Median	97% CrI
Baseline effect	0.967	0.966	0.886 to 1.051
All biologics (except APR)	-1.095	-1.094	-1.190 to -1.005
APR	-0.614	-0.610	-0.773 to -0.474
Beta	-1.627	-1.627	-2.365 to -0.926
z_1 , ACR 20	-	-	-
z_2 , ACR 50	0.657	0.656	0.611 to 0.704
z_3 , ACR 70	1.272	1.271	1.201 to 1.345
Residual deviance ^a	148.30		
DIC	503.43		

a Compared 92 data points.

Comparison of evidence synthesis of American College of Rheumatology responses in the company submissions, a previous multiple technology appraisal and the Assessment Group

Both the Novartis and the UCB Pharma submissions combined ACR outcome evidence using Bayesian evidence synthesis methods. Both submissions estimated probability of achieving ACR responses in three categories (20/50/70) and conducted binary analysis of the ACR categories separately to inform clinical effectiveness. However, the AG and a previous MTA estimated probability of achieving ACR responses in three categories (20/50/70) to inform clinical effectiveness. Therefore, the comparison between the CSs and AG is limited to the estimation of probability of achieving ACR responses in three categories (20/50/70). A brief comparison of the methods used with key model assumptions, by the AG, CSs and a previous MTA, is presented in *Tables 172 and 173*.

TABLE 169 Results of model J3: treatment effects (on a probit scale) and the different cut-off points (ACR 20, ACR 50 and ACR 70)

Treatment/parameter	Treatment effects		
	Mean	Median	97% CrI
Baseline effect	0.967	0.966	0.886 to 1.049
ILs as class	-1.095	-1.095	-1.189 to -1.005
Anti-TNFs as class	-0.612	-0.609	-0.767 to -0.474
APR	0.021	-0.014	-19.450 to 19.720
Beta	-1.621	-1.619	-2.349 to -0.918
z_1 , ACR 20			
z_2 , ACR 50	0.657	0.656	0.611 to 0.704
z_3 , ACR 70	1.272	1.271	1.201 to 1.344
Residual deviance ^a	148.30		
DIC			

a Compared 92 data points.

TABLE 170 Results of model K1: treatment effects (on a probit scale) and the different cut-off points (ACR 20, ACR 50 and ACR 70)

Treatment/parameter	Predicted mean distribution			Shrunken or independent estimates		
	Mean	Median	97% CrI	Mean	Median	97% CrI
Baseline effect	-	-	-	0.963	0.963	0.880 to 1.049
300 mg of SEC	-1.137	-1.135	-1.750 to -0.534	-1.278	-1.274	-1.582 to -0.994
150 mg of SEC				-1.287	-1.283	-1.597 to -0.998
UST				-0.750	-0.750	-0.919 to -0.582
CZP				-1.195	-1.193	-1.437 to -0.961
GOL				-1.007	-1.010	-1.264 to -0.733
ADA				-1.122	-1.121	-1.257 to -0.990
INF				-1.244	-1.246	-1.479 to -1.005
ETN				-1.214	-1.215	-1.410 to -1.013
APR	-	-	-	-0.581	-0.581	-0.700 to -0.465
Beta	-	-	-	-1.099	-1.103	-1.646 to -0.534
γ^a	-	-	-	0.264	0.240	0.123 to 0.547
z_1 , ACR 20	-	-	-	-	-	-
z_2 , ACR 50	-	-	-	0.660	0.660	0.614 to 0.709
z_3 , ACR 70	-	-	-	1.280	1.280	1.209 to 1.354
Residual deviance ^b	120.00					
DIC	480.90					

a Variance parameter for the random effect across biologics (excluding APR).

b Compared 92 data points.

TABLE 171 Results of model K2: treatment effects (on a probit scale) and the different cut-off points (ACR 20, ACR 50 and ACR 70)

Treatment/parameter	Predicted mean distribution			Shrunken or independent estimates		
	Mean	Median	97% CrI	Mean	Median	97% CrI
Baseline effect	–	–	–	0.961	0.961	0.878 to 1.046
300 mg of SEC	–1.069	–1.054	–1.869 to –0.345	–1.234	–1.236	–1.609 to –0.845
150 mg of SEC				–1.243	–1.246	–1.628 to –0.854
UST				–0.733	–0.732	–0.913 to –0.552
CZP	–1.167	–1.170	–1.862 to –0.464	–1.178	–1.176	–1.443 to –0.924
GOL				–1.038	–1.040	–1.350 to –0.718
ADA				–1.123	–1.124	–1.259 to –0.988
INF				–1.268	–1.269	–1.530 to –1.003
ETN				–1.228	–1.228	–1.432 to –1.021
APR	–	–	–	–0.576	–0.576	–0.700 to –0.453
Beta				–1.018	–1.028	–1.671 to –0.334
γ^a				0.280	0.248	0.107 to 0.643
z_1 , ACR 20	–	–	–	–	–	–
z_2 , ACR 50				0.661	0.660	0.615 to 0.708
z_3 , ACR 70				1.281	1.281	1.210 to 1.354
Residual deviance ^b	120.40					
DIC						

a Variance parameter for the random effect across biologics (excluding APR).

b Compared 92 data points.

Like other outcomes, a key difference between the ACR NMAs presented concerned the trials included in each analysis. The AG's NMA for the biologic-naive subgroup includes all comparators and all trials. Rodgers *et al.*'s³³ analysis was limited to the treatments available at that time. The UCB Pharma analysis for the biologic-naive subgroup includes all treatments, but misses one APR trial. The Novartis NMA for the biologic-naive subgroup included a more complete set of treatments and trials for this outcome. Both submissions included the RAPID-PsA trial⁴⁷ in the biologic-experienced subgroup analysis, whereas the AG excluded the RAPID-PsA trial⁴⁷ from the analysis. It should be noted that this comparison refers to Novartis' NMAs of subgroups. As mentioned before, the Novartis submission presented a NMA for all patients (treatment naive and experienced combined).

A key difference between models was the assumption of effects on studies. The AG and Rodgers *et al.*³³ consider fixed effects on studies, whereas UCB Pharma and Novartis consider random effect on studies for the biologic-naive subgroup and fixed effect on studies for the biologic-experienced subgroup analysis. Like other outcomes, another key difference relates to the primary time point used. The AG, the previous MTA and Novartis conducted analyses at the 12-week time point, whereas UCB Pharma conducted primary analysis at 24 weeks and sensitivity analysis considering a 12-week time point.

Table 174 shows the three NMA results for (probabilities of) ACR response for the biologic-naive subpopulation. In comparison with the Novartis analysis and the AG unadjusted analysis, the estimated probabilities in the three categories are lower for INF, but higher for ADA. The differences are largely because Novartis included a different data set. UCB Pharma chose binary analysis of ACR 20 and ACR 50

TABLE 172 Comparison of evidence synthesis of ACR responses in CSs (Novartis and UCB Pharma), the previous MTA and the current AG

Domains compared	Rodgers <i>et al.</i> , 2011 ³³	CS		
		Novartis	UCB Pharma	AG
Model	Conditional multinomial probit model	Conditional multinomial probit model	Conditional multinomial probit model	Conditional multinomial probit model
Results reported	Probability of ACR response in three categories 20/50/70	Probability of ACR response in three categories 20/50/70	Probability of ACR response in three categories 20/50/70 for biologic-experienced subpopulation, but did not present probabilities for the biologic-naive subpopulation	Probability of ACR response in three categories 20/50/70
Time points	At 12 weeks (data from the 12-week or closest time point after 12 weeks – normally 14 or 16 weeks)	At 12 weeks (data from the 12-week or closest time point after 12 weeks – normally 14 or 16 weeks)	Primary analysis at 24 weeks (by treatments), sensitivity analysis was conducted at 12 weeks including data on 12 weeks or closest time point after 12 weeks ^a	At 12 weeks (data from the 12-week or closest time point after 12 weeks – normally 14 or 16 weeks)
Comments		Modelled probabilities are presented graphically		

Data regarding biologic-naive subpopulation

Studies used in the analysis	ADEPT; ⁵⁵ Genovese <i>et al.</i> ; ⁵⁶ IMPACT; ⁵¹ IMPACT 2; ⁵² and Mease <i>et al.</i> ^{53,54}	ADEPT; ⁵⁵ FUTURE 2; ⁴⁸ Genovese <i>et al.</i> ; ⁵⁶ GO-REVEAL; ⁵⁰ IMPACT 2; ⁵² Mease <i>et al.</i> ; ⁵⁴ PALACE 1; ⁶⁰ PSUMMIT 1; ⁵⁸ PSUMMIT 2; ^{59,66} and RAPID-PsA ⁴⁷	ADEPT; ⁵⁵ Genovese <i>et al.</i> ; ⁵⁶ GO-REVEAL; ⁵⁰ IMPACT; ⁵¹ IMPACT 2; ⁵² SPIRIT-P1; ^{57,67} PALACE 1; ⁶⁰ PALACE 3; ⁶⁵ PSUMMIT 1; ⁵⁸ Mease <i>et al.</i> ; ^{53,54} and RAPID-PsA ⁴⁷ (12–16 weeks analysis)	ADEPT; ⁵⁵ FUTURE 2; ⁴⁸ Genovese <i>et al.</i> ; ⁵⁶ GO-REVEAL; ⁵⁰ IMPACT 2; ⁵² Mease <i>et al.</i> ; ⁵⁴ PALACE 1; ⁶⁰ PALACE 2; ⁶¹ PALACE 3; ⁶⁵ PSUMMIT 1; ⁵⁸ PSUMMIT 2; ^{59,66} RAPID-PsA; ⁴⁷ and SPIRIT-P1 ^{57,67}
Drugs evaluated	40 mg of ADA; 5 mg/kg of INF; and 25 mg of ETN	40 mg of ADA; 20 and 30 mg of APR; 200 and 400 mg of CZP; 25 mg of ETN; 50 and 100 mg of GOL; 5 mg/kg of INF; 150 and 300 mg of SEC; 45 and 90 mg of UST	40 mg of ADA; 20 mg of APR and 30 mg; 400 mg of CZP; 25 mg of ETN; 50 mg of GOL; and 5 mg/kg of INF	40 mg of ADA; 30 mg of APR; 400 mg of CZP; 25 mg of ETN; 50 mg of GOL; 5 mg/kg of INF; 150 and 300 mg of SEC; and 45 mg of UST

Data regarding biologic-experienced subpopulation

Studies used in the analysis	NC	FUTURE 2; ⁴⁸ PALACE 1; ⁶⁰ PSUMMIT 2; ^{59,66} and RAPID-PsA ⁴⁷	^b FUTURE 1; ⁴⁶ FUTURE 2; ⁴⁸ PSUMMIT 2; ^{59,66} and RAPID-PsA ⁴⁷ (24 weeks' analysis)	FUTURE 2; ⁴⁸ and PSUMMIT 2; ⁵⁹ ,
Drugs evaluated	NC	20 and 30 mg of APR; 200 and 400 mg of CZP; 150 and 300 mg of SEC; and, 45 and 90 mg of UST	CZP; 300 mg of SEC; and 45 mg of UST	300 mg of SEC; and 45 mg of UST

NC, not conducted.

^a The AG considers results at 12 weeks to compare with our results.^b Included patients from the Latin America sites.

TABLE 173 Key assumptions in the synthesis models for ACR responses in CSs (Novartis and UCB Pharma), the previous MTA and the current AG

Domains compared	Rodgers <i>et al.</i> , 2011 ³³	CS		
		Novartis	UCB Pharma	AG
Model	Conditional multinomial probit model	Conditional multinomial probit model	Conditional multinomial probit model	Conditional multinomial probit model
Fixed or random effects between studies	Fixed effects on studies	Random effect on studies for biologic-naive subgroup analysis; and fixed effects on studies for biologic-experienced subgroup analysis	Random effect on studies for biologic-naive subgroup analysis and fixed effect for biologic-experienced subgroup analysis	Fixed effects on studies (for both subpopulation analyses)
Baselines	Common-effect model was used to estimate baseline	Common-effect model was used to estimate baseline	Common-effect model was used to estimate baseline	Common-effect model was used to estimate baseline
Treatment effects	Treatments were assumed to be independent of each other	Treatments were assumed to be independent of each other	Treatments were assumed to be independent of each other	For the biologic-naive subpopulation: <ol style="list-style-type: none"> 1. Treatments were assumed to be independent of each other 2. Treatments as class-considering treatments are similar within class (i.e. exchangeable class effect) and utilise two classes (ILs and anti-TNFs) For the biologic-experienced subpopulation, treatments were assumed to be independent of each other
Model adjusted for the placebo response	Unadjusted	Unadjusted	Unadjusted	Independent treatment effects model was unadjusted, but analysis assuming exchangeable class effects model was adjusted for the placebo response
Interaction term (beta)	–	–	–	Common interaction term for adjusted model
Probit/logit score thresholds	Thresholds were assumed to be fixed across trials	Thresholds were assumed to be fixed across trials	Thresholds were assumed to be fixed across trials	Thresholds were assumed to be fixed across trials

over probability of achieving ACR responses in three categories (20/50/70) to be the preferred analysis, and did not present the results of probability of ACR responses for the biologic-naive subgroup. Therefore, it was not plausible to compare the AG's results for the biologic-naive population with UCB Pharma results.

While comparing results of the biologic-experienced subgroup, the results are not comparable between the AG and UCB Pharma, as probabilities were estimated at two different time points (12 weeks and 24 weeks). There are differences in the Novartis and AG estimates, largely because Novartis included a different data set (*Table 175*).

TABLE 174 Comparison of ACR response in the CSs (Novartis and UCB Pharma), the previous MTA and the current AG in the biologic-naive subpopulation

Treatment	Probability of ACR responses in the biologic-naive subpopulation at 12 weeks (12–16 weeks)			
	Rodgers <i>et al.</i> (2011), ³³ mean (95% CrI)	Novartis, mean	AG, median (95% CrI)	
			Unadjusted	Adjusted
Placebo				
ACR 20	0.14 (0.11 to 0.17)	Confidential information has been removed	0.17 (0.15 to 0.19)	0.17 (0.15 to 0.19)
ACR 50	0.05 (0.04 to 0.07)	Confidential information has been removed	0.05 (0.04 to 0.06)	0.05 (0.04 to 0.06)
ACR 70	0.01 (0.01 to 0.03)	Confidential information has been removed	0.01 (0.01 to 0.02)	0.01 (0.01 to 0.02)
300 mg of SEC				
ACR 20	NC	Confidential information has been removed	0.49 (0.33 to 0.64)	0.61 (0.46 to 0.75)
ACR 50		Confidential information has been removed	0.24 (0.14 to 0.38)	0.35 (0.22 to 0.50)
ACR 70		Confidential information has been removed	0.09 (0.04 to 0.18)	0.16 (0.08 to 0.27)
150 mg of SEC				
ACR 20	NC	Confidential information has been removed	0.49 (0.34 to 0.65)	0.61 (0.46 to 0.75)
ACR 50		Confidential information has been removed	0.25 (0.14 to 0.39)	0.35 (0.22 to 0.51)
ACR 70		Confidential information has been removed	0.10 (0.04 to 0.19)	0.16 (0.08 to 0.27)
45 mg of UST				
ACR 20	NC	Confidential information has been removed	0.35 (0.27 to 0.44)	0.41 (0.34 to 0.49)
ACR 50		Confidential information has been removed	0.15 (0.10 to 0.21)	0.19 (0.14 to 0.25)
ACR 70		Confidential information has been removed	0.05 (0.03 to 0.08)	0.07 (0.04 to 0.10)
CZP				
ACR 20	NC	Confidential information has been removed	0.44 (0.34 to 0.55)	0.58 (0.49 to 0.69)
ACR 50		Confidential information has been removed	0.21 (0.14 to 0.30)	0.33 (0.24 to 0.43)
ACR 70		Confidential information has been removed	0.08 (0.04 to 0.13)	0.14 (0.09 to 0.22)
50 mg of GOL				
ACR 20	NC	Confidential information has been removed	0.68 (0.55 to 0.80)	0.53 (0.40 to 0.66)
ACR 50		Confidential information has been removed	0.43 (0.30 to 0.57)	0.28 (0.18 to 0.40)
ACR 70		Confidential information has been removed	0.21 (0.12 to 0.33)	0.11 (0.06 to 0.19)

continued

TABLE 174 Comparison of ACR response in the CSs (Novartis and UCB Pharma), the previous MTA and the current AG in the biologic-naive subpopulation (*continued*)

Treatment	Probability of ACR responses in the biologic-naive subpopulation at 12 weeks (12–16 weeks)			
	Rodgers <i>et al.</i> (2011), ³³ mean (95% CrI)	Novartis, mean	AG, median (95% CrI)	
			Unadjusted	Adjusted
ADA				
ACR 20	0.56 (0.43 to 0.69)	Confidential information has been removed	0.55 (0.47 to 0.62)	0.56 (0.50 to 0.63)
ACR 50	0.31 (0.21 to 0.44)	Confidential information has been removed	0.29 (0.23 to 0.36)	0.31 (0.26 to 0.37)
ACR 70	0.13 (0.08 to 0.21)	Confidential information has been removed	0.12 (0.09 to 0.17)	0.13 (0.10 to 0.17)
INF				
ACR 20	0.68 (0.53 to 0.81)	Confidential information has been removed	0.75 (0.65 to 0.83)	0.62 (0.51 to 0.72)
ACR 50	0.43 (0.29 to 0.59)	Confidential information has been removed	0.50 (0.39 to 0.62)	0.36 (0.26 to 0.47)
ACR 70	0.20 (0.11 to 0.33)	Confidential information has been removed	0.27 (0.18 to 0.38)	0.17 (0.10 to 0.24)
ETN				
ACR 20	0.61 (0.46 to 0.75)	Confidential information has been removed	0.66 (0.55 to 0.76)	0.61 (0.51 to 0.69)
ACR 50	0.36 (0.23 to 0.52)	Confidential information has been removed	0.40 (0.29 to 0.52)	0.35 (0.27 to 0.43)
ACR 70	0.16 (0.09 to 0.26)	Confidential information has been removed	0.19 (0.12 to 0.29)	0.16 (0.11 to 0.21)
30 mg of APR				
ACR 20	NC	Confidential information has been removed	0.33 (0.27 to 0.39)	0.35 (0.30 to 0.41)
ACR 50		Confidential information has been removed	0.13 (0.10 to 0.17)	0.15 (0.12 to 0.19)
ACR 70		Confidential information has been removed	0.04 (0.03 to 0.06)	0.05 (0.03 to 0.07)
NC, not conducted.				

TABLE 175 Comparison of ACR response in UCB Pharma submission and the current AG in the biologic-experienced subpopulation

Treatment	Probability of ACR responses in the biologic-experienced subpopulation		
	CS	UCB Pharma, at 24 weeks, mean (95% CrI)	AG at 12 weeks (12–16 weeks), median (95% CrI)
Placebo			
ACR 20	Confidential information has been removed	Confidential information has been removed	0.14 (0.08 to 0.22)
ACR 50	Confidential information has been removed	Confidential information has been removed	0.03 (0.01 to 0.06)
ACR 70	Confidential information has been removed	Confidential information has been removed	0.01 (0.00 to 0.02)
300 mg of SEC			
ACR 20	Confidential information has been removed	Confidential information has been removed	0.36 (0.19 to 0.57)
ACR 50	Confidential information has been removed	Confidential information has been removed	0.11 (0.04 to 0.25)
ACR 70	Confidential information has been removed	Confidential information has been removed	0.03 (0.01 to 0.11)
45 mg of UST			
ACR 20	Confidential information has been removed	Confidential information has been removed	0.42 (0.26 to 0.59)
ACR 50	Confidential information has been removed	Confidential information has been removed	0.14 (0.06 to 0.27)
ACR 70	Confidential information has been removed	Confidential information has been removed	0.05 (0.01 to 0.12)
CZP			
ACR 20	Confidential information has been removed	Confidential information has been removed	NC
ACR 50	Confidential information has been removed	Confidential information has been removed	NC
ACR 70	Confidential information has been removed	Confidential information has been removed	NC
NC, not conducted.			

*WinBUG codes of preferred model**Model H1:*

```

model{
for(i in 1:N){
  p[i,1] <- 1
  for(j in 1:nc[i]-1) {
    r[i,j] ~ dbin(q[i,j],n[i,j])
    q[i,j] <- 1-(p[i,C[i,j+1]]/p[i,C[i,j]])
    z.index[i,j]<- C[i,j+1]-1
    theta[i,j] <- mu[s[i]] + (d[t[i]] - d[t[1]])*(1-equals(t[i],b[i])) + z[z.index[i,j]]
    rhat[i,j] <- q[i,j] * n[i,j]
    dv[i,j] <- 2 * (r[i,j]*(log(r[i,j])-log(rhat[i,j]))) + (n[i,j]-r[i,j])*(log(n[i,j]-r[i,j]) - log(n[i,j]-
    rhat[i,j])))
  }
  dev[i] <- sum(dv[i,1:nc[i]-1])
  for(j in 2:nc[i]) {
    p[i,C[i,j]] <- 1 - phi.adj[i,j]
    phi.adj[i,j] <- phi(theta[i,j-1])
  }
}
totresdev <- sum(dev[])
z[1] <- 0
for(j in 2:Cmax-1) {
  z.aux[j] ~ dunif(0,5)
  z[j] <- z[j-1] + z.aux[j]
}
d[1] <- 0
for(k in 2:nt){ d[k] ~ dnorm(0,0.000001) }
for(i in 1:ns){ mu[i] ~ dnorm(0,0.000001)}

for(i in 1:ns) {
  mu1[i]<-mu[i]*equals(t[1],1)}
A<-sum(mu1[])/ns

# calculate prob of achieving ACR20/50/70 on treat k
for(k in 1:nt) {
  for(j in 1: Cmax-1) { T[j,k] <- 1 - phi(A + d[k] + z[j]) }
}
}

```

Model K2:

```

model{
for(i in 1:N){
  p[i,1] <- 1
  for(j in 1:nc[i]-1) {
    r[i,j] ~ dbin(q[i,j],n[i,j])
    q[i,j] <- 1-(p[i,C[i,j+1]]/p[i,C[i,j]])
    z.index[i,j]<- C[i,j+1]-1
    theta[i,j] <- mu[s[i]] + d[t[i]] + z[z.index[i,j]]
    + betaplac * (mu[s[i]] - Mean) * (1-equals(t[i],1))
    rhat[i,j] <- q[i,j] * n[i,j]
    dv[i,j] <- 2 * (r[i,j]*(log(r[i,j])-log(rhat[i,j]))) + (n[i,j]-r[i,j])*(log(n[i,j]-r[i,j]) - log(n[i,j]-rhat[i,j])))
  }
  dev[i] <- sum(dv[i,1:nc[i]-1])
  for(j in 2:nc[i]) {
    p[i,C[i,j]] <- 1 - phi.adj[i,j]
  }
}

```

```

        phi.adj[i,j] <- phi(theta[i,j-1])
      }
    }
  totresdev <- sum(dev[])
  z[1] <- 0

  for (j in 2:Cmax-1) {
    z.aux[j] ~ dunif(0,5)
    z[j] <- z[j-1] + z.aux[j]
  }

  d[1] <- 0
  for (k in 2:4){ d[k] ~dnorm( D.c[1], prec.d) }
  for (k in 5:9){ d[k] ~dnorm( D.c[2], prec.d) }
  d[10] <-D.c[3]
  for (i in 1:3) {D.c[i] ~ dnorm(0,0.01) }
  prec.d<- 1/(sd.d*sd.d)
  sd.d~dunif(0,10)
  for (i in 1:2) {D.pred[i]~dnorm(D.c[i],prec.d)}
  for(i in 1:ns){ mu[i] ~ dnorm(0,0.01)}
  betaplac ~ dnorm(0,0.01)

  for (i in 1:ns) {
    mu1[i]<-mu[i]*equals(t[1],1)}
  A<-sum(mu1[])/ns

  # calculate prob of achieving ACR20/50/70 on treat k
  for (k in 1:nt) {
    for (j in 1: Cmax-1) { T[j,k] <- 1 - phi(A + d[k] + z[j]) }
  }
}
d[1]=PLA, d[2]=SEC300, d[3]=SEC150, d[4]=UST, d[5]=CZP, d[6]=GOL, d[7]=ADA, d[8]=INF, d[9]=ETA,
d[10]=APR

```

Appendix 4 Search strategy for cost-effectiveness studies

MEDLINE and MEDLINE In-Process & Other Non-Indexed Citations

The search strategy was developed in MEDLINE (via Ovid) by an information specialist, with input from the project team. The strategy included terms for PsA combined, using the Boolean operator AND, with terms for the eight drugs. No language or geographical limits were applied. A search strategy to limit retrieval to economic evaluations was used, where available. The search strategy was adapted for use in the other resources searched.

The following databases were searched: MEDLINE; MEDLINE In-Process & Other Non-Indexed Citations; CENTRAL; Conference Proceedings Citation Index – Science; EconLit; EMBASE; NHS EED; PubMed; and the SCI.

The results from the searches were imported into an EndNote library (x7, Thomson Reuters, CA, USA) and de-duplicated. After de-duplication in EndNote, a total of 722 records were available for screening.

Via Ovid: <http://ovidsp.ovid.com/>

Date range searched: 1946 to present.

Date searched: 15 February 2016.

Records retrieved: 73.

Search strategy

1. Arthritis, Psoriatic/ (4255)
2. (psoria\$ adj2 (arthrit\$ or arthropath\$)).ti,ab. (6719)
3. 1 or 2 (7560)
4. Certolizumab Pegol/ (329)
5. (Certolizumab or Cimzia or CZP or CDP870 or CDP-870 or 428863-50-7).af. (873)
6. 4 or 5 (873)
7. 3 and 6 (69)
8. (secukinumab or Cosentyx or AIN457 or AIN-457 or 1229022-83-6).af. (144)
9. 3 and 8 (33)
10. (golimumab or simponi or CNTO148 or CNTO-148 or 476181-74-5).af. (530)
11. (2010\$ or 2011\$ or 2012\$ or 2013\$ or 2014\$ or 2015\$ or 2016\$).ed. (5,936,425)
12. 3 and 10 and 11 (93)
13. (apremilast or otezla or otezia or CC10004 or CC-10004 or 608141-41-9).af. (142)
14. (2014\$ or 2015\$ or 2016\$).ed. (2,019,613)
15. 3 and 13 and 14 (29)
16. Ustekinumab/ (386)
17. (ustekinumab or stelara or CNTO1275 or CNTO-1275 or 815610-63-0).af. (684)
18. 16 or 17 (684)
19. (2012\$ or 2013\$ or 2014\$ or 2015\$ or 2016\$).ed. (3,931,892)
20. 3 and 18 and 19 (97)
21. (inflectra or remsima or CT-P13).af. (45)
22. 3 and 21 (2)
23. Etanercept/ (4522)

24. (etanercept or enbrel or 185243-69-0).af. (6317)
25. Infliximab/ (7584)
26. (infliximab or remicade or 170277-31-3).af. (10,459)
27. Adalimumab/ (3151)
28. (adalimumab or humira or D2E7 or (D2 adj E7) or 331731-18-1).af. (4791)
29. or/23-28 (15,794)
30. (2009\$ or 2010\$ or 2011\$ or 2012\$ or 2013\$ or 2014\$ or 2015\$ or 2016\$).ed. (6,691,099)
31. 3 and 29 and 30 (686)
32. 7 or 9 or 12 or 15 or 20 or 22 or 31 (846)
33. economics/ (26,633)
34. exp 'costs and cost analysis'/ (193,882)
35. economics, dental/ (1876)
36. exp 'economics, hospital'/ (21,057)
37. economics, medical/ (8845)
38. economics, nursing/ (3933)
39. economics, pharmaceutical/ (2601)
40. (economic\$ or cost\$ or price or prices or pricing or pharmacoeconomic\$).ti,ab. (563,319)
41. (expenditure\$ not energy).ti,ab. (20,845)
42. value for money.ti,ab. (1132)
43. budget\$.ti,ab. (21,354)
44. or/33-43 (695,859)
45. ((energy or oxygen) adj cost).ti,ab. (3171)
46. (metabolic adj cost).ti,ab. (962)
47. ((energy or oxygen) adj expenditure).ti,ab. (18,791)
48. or/45-47 (22,130)
49. 44 not 48 (690,811)
50. letter.pt. (901,537)
51. editorial.pt. (393,586)
52. historical article.pt. (326,263)
53. or/50-52 (1,605,365)
54. 49 not 53 (659,853)
55. exp animals/ not humans/ (4,184,674)
56. 54 not 55 (613,314)
57. 32 and 56 (73)

Key

/ = indexing term (MeSH heading).

exp = exploded indexing term (MeSH heading).

\$ = truncation.

ti,ab = terms in either title or abstract fields.

af = terms in any field.

ed = entry date – date added to database.

pt = publication type.

adj = terms next to each other (order specified).

adj2 = terms within two words of each other (any order).

Cochrane Central Register of Controlled Trials

Via Wiley Online Library: <http://onlinelibrary.wiley.com/>

Issue 1 of 12, January 2016.

Date searched: 16 February 2016.

Records retrieved: 240.

Search strategy

- #1 MeSH descriptor: [Arthritis, Psoriatic] this term only (224)
- #2 (psoria* near/2 (arthrit* or arthropath*)):ti,ab,kw (582)
- #3 #1 or #2 (582)
- #4 MeSH descriptor: [Certolizumab Pegol] this term only (57)
- #5 (Certolizumab or Cimzia or CZP or CDP870 or CDP-870 or 428863-50-7):ti,ab,kw (211)
- #6 #4 or #5 (211)
- #7 #3 and #6 (29)
- #8 (secukinumab or Cosentyx or AIN457 or AIN-457 or 1229022-83-6):ti,ab,kw (140)
- #9 #3 and #8 (30)
- #10 (golimumab or simponi or CNTO148 or CNTO-148 or 476181-74-5):ti,ab,kw Publication Year from 2010 to 2016 (227)
- #11 #3 and #10 Publication Year from 2010 to 2016 (43)
- #12 (apremilast or otezla or otezia or CC10004 or CC-10004 or 608141-41-9):ti,ab,kw Publication Year from 2014 to 2016 (48)
- #13 #3 and #12 Publication Year from 2014 to 2016 (24)
- #14 MeSH descriptor: [Ustekinumab] this term only (48)
- #15 (ustekinumab or stelara or CNTO1275 or CNTO-1275 or 815610-63-0):ti,ab,kw Publication Year from 2012 to 2016 (111)
- #16 #14 or #15 Publication Year from 2012 to 2016 (111)
- #17 #3 and #16 Publication Year from 2012 to 2016 (41)
- #18 (inflectra or remsima or CT-P13):ti,ab,kw (16)
- #19 #3 and #18 (4)
- #20 MeSH descriptor: [Etanercept] this term only (381)

- #21 (etanercept or enbrel or 185243-69-0):ti,ab,kw Publication Year from 2009 to 2016 (638)
- #22 MeSH descriptor: [Infliximab] this term only (431)
- #23 (infliximab or remicade or 170277-31-3):ti,ab,kw Publication Year from 2009 to 2016 (718)
- #24 MeSH descriptor: [Adalimumab] this term only (236)
- #25 (adalimumab or humira or D2E7 or (D2 next E7) or 331731-18-1):ti,ab,kw Publication Year from 2009 to 2016 (775)
- #26 #20 or #21 or #22 or #23 or #24 or #25 Publication Year from 2009 to 2016 (1685)
- #27 #3 and #26 Publication Year from 2009 to 2016 (123)
- #28 #7 or #9 or #11 or #13 or #17 or #19 or #27 (265)
- #29 #7 or #9 or #11 or #13 or #17 or #19 or #27 in Trials (240)

Key

MeSH descriptor = indexing term (MeSH heading).

* = truncation.

ti,ab,kw = terms in either title or abstract or keyword fields.

near/2 = terms within two words of each other (any order).

next = terms are next to each other.

Conference Proceedings Citation Index – Science

Via Web of Science, Thomson Reuters: <http://thomsonreuters.com/thomson-reuters-web-of-science/>

Date range searched: 1990 to 12 February 2016.

Date searched: 15 February 2016.

Records retrieved: four.

Search strategy

# 22	4	#21 OR #19 <i>Indexes=CPCI-S Timespan=All years</i>
# 21	3	#20 not #16 <i>Indexes=CPCI-S Timespan=2009-2016</i>
# 20	3	#15 AND #14 AND #3 <i>Indexes=CPCI-S Timespan=2009-2016</i>
# 19	1	#18 not #16 <i>Indexes=CPCI-S Timespan=All years</i>

# 18	1	#17 AND #15 AND #3 <i>Indexes=CPCI-S Timespan=All years</i>
# 17	868	#9 OR #8 OR #7 OR #6 OR #5 OR #4 <i>Indexes=CPCI-S Timespan=All years</i>
# 16	305,948	TS=(rat or rats or mouse or mice or hamster or hamsters or animal or animals or dog or dogs or cat or cats or bovine or sheep or guinea*) <i>Indexes=CPCI-S Timespan=All years</i>
# 15	389,653	TS=(economic* or cost* or price or prices or pricing or pharmaco-economic*) <i>Indexes=CPCI-S Timespan=All years</i>
# 14	1811	#13 <i>Indexes=CPCI-S Timespan=2009-2016</i>
# 13	4801	#12 OR #11 OR #10 <i>Indexes=CPCI-S Timespan=All years</i>
# 12	1317	TS=(adalimumab or humira or D2E7 or D2-E7 or 331731-18-1) <i>Indexes=CPCI-S Timespan=All years</i>
# 11	2706	TS=(infliximab or remicade or 170277-31-3) <i>Indexes=CPCI-S Timespan=All years</i>
# 10	1338	TS=(etanercept or enbrel or 185243-69-0) <i>Indexes=CPCI-S Timespan=All years</i>
# 9	7	TS=(inflectra or remsima or CT-P13) <i>Indexes=CPCI-S Timespan=All years</i>
# 8	177	TS=(ustekinumab or stelara or CNTO1275 or CNTO-1275 or 815610-63-0) <i>Indexes=CPCI-S Timespan=All years</i>
# 7	69	TS=(apremilast or otezla or otezia or CC10004 or CC-10004 or 608141-41-9) <i>Indexes=CPCI-S Timespan=All years</i>
# 6	176	TS=(golimumab or simponi or CNTO148 or CNTO-148 or 476181-74-5) <i>Indexes=CPCI-S Timespan=All years</i>
# 5	76	TS=(secukinumab or Cosentyx or AIN457 or AIN-457 or 1229022-83-6) <i>Indexes=CPCI-S Timespan=All years</i>
# 4	367	TS=(Certolizumab or Cimzia or CZP or CDP870 or CDP-870 or 428863-50-7) <i>Indexes=CPCI-S Timespan=All years</i>
# 3	1638	#2 OR #1 <i>Indexes=CPCI-S Timespan=All years</i>
# 2	30	TS=(psoria* same arthropath*) <i>Indexes=CPCI-S Timespan=All years</i>
# 1	1625	TS=(psoria* same arthrit*) <i>Indexes=CPCI-S Timespan=All years</i>

Key

TS = topic tag; searches terms in title, abstract, author keywords and keywords plus fields.

* = truncation.

'' = phrase search.

EconLit

Via Ovid: <http://ovidsp.ovid.com/>

Date range searched: 1886 to January 2016.

Date searched: 15 February 2016.

Records retrieved: one.

Search strategy

1. (psoria\$ adj2 (arthrit\$ or arthropath\$)).ti,ab. (4)
2. (Certolizumab or Cimzia or CZP or CDP870 or CDP-870 or 428863-50-7).af. (0)
3. (secukinumab or Cosentyx or AIN457 or AIN-457 or 1229022-83-6).af. (0)
4. (golimumab or simponi or CNTO148 or CNTO-148 or 476181-74-5).af. (1)
5. (apremilast or otezla or otezia or CC10004 or CC-10004 or 608141-41-9).af. (0)
6. (ustekinumab or stelara or CNTO1275 or CNTO-1275 or 815610-63-0).af. (0)
7. (inflectra or remsima or CT-P13).af. (1)
8. (etanercept or enbrel or 185243-69-0).af. (9)
9. (infliximab or remicade or 170277-31-3).af. (11)
10. (adalimumab or humira or D2E7 or (D2 adj E7) or 331731-18-1).af. (4)
11. 2 or 3 or 4 or 5 or 6 or 7 or 8 or 9 or 10 (16)
12. 1 and 11 (1)

Key

\$ = truncation.

ti,ab = terms in either title or abstract fields.

af = all fields.

adj2 = terms within two words of each other (any order).

EMBASE

Via Ovid: <http://ovidsp.ovid.com/>

Date range searched: 1974 to 2016 February 12.

Date searched: 15 February 2016.

Records retrieved: 429.

Search strategy

1. psoriatic arthritis/ (13,665)
2. (psoria\$ adj2 (arthrit\$ or arthropath\$)).ti,ab. (11,842)
3. 1 or 2 (16,004)
4. certolizumab pegol/ (3636)
5. (Certolizumab or Cimzia or CZP or CDP870 or CDP-870 or 428863-50-7).af. (4412)
6. 4 or 5 (4412)
7. 3 and 6 (593)
8. secukinumab/ (674)
9. (secukinumab or Cosentyx or AIN457 or AIN-457 or 1229022-83-6).af. (752)
10. 8 or 9 (752)
11. 3 and 10 (236)
12. golimumab/ (3205)
13. (golimumab or simponi or CNTO148 or CNTO-148 or 476181-74-5).af. (3296)
14. 12 or 13 (3296)
15. (2010\$ or 2011\$ or 2012\$ or 2013\$ or 2014\$ or 2015\$ or 2016\$).em. (7,964,340)
16. 3 and 14 and 15 (734)
17. apremilast/ (493)
18. (apremilast or otezla or otezia or CC10004 or CC-10004 or 608141-41-9).af. (529)
19. 17 or 18 (529)
20. (2014\$ or 2015\$ or 2016\$).em. (3,487,544)
21. 3 and 19 and 20 (180)
22. ustekinumab/ (2546)
23. (ustekinumab or stelara or CNTO1275 or CNTO-1275 or 815610-63-0).af. (2662)
24. 22 or 23 (2662)
25. (2012\$ or 2013\$ or 2014\$ or 2015\$ or 2016\$).em. (6,135,553)
26. 3 and 24 and 25 (579)
27. (inflectra or remsima or CT-P13).af. (137)
28. 3 and 27 (20)
29. etanercept/ (22,267)
30. (etanercept or enbrel or 185243-69-0).af. (23,098)
31. infliximab/ (34,699)
32. (infliximab or remicade or 170277-31-3).af. (35,399)
33. adalimumab/ (19,622)
34. (adalimumab or humira or D2E7 or (D2 adj E7) or 331731-18-1).af. (20,032)
35. or/29-34 (48,727)
36. (2009\$ or 2010\$ or 2011\$ or 2012\$ or 2013\$ or 2014\$ or 2015\$ or 2016\$).em. (9,322,795)
37. 3 and 35 and 36 (3158)
38. 7 or 11 or 16 or 21 or 26 or 28 or 37 (3754)
39. Health Economics/ (35,095)
40. exp Economic Evaluation/ (238,057)
41. exp Health Care Cost/ (228,961)
42. pharmacoeconomics/ (6245)
43. 39 or 40 or 41 or 42 (427,297)
44. (econom\$ or cost or costs or costly or costing or price or prices or pricing or pharmacoeconomic\$).ti,ab. (717,152)
45. (expenditure\$ not energy).ti,ab. (27,886)
46. (value adj2 money).ti,ab. (1653)
47. budget\$.ti,ab. (27,874)

48. 44 or 45 or 46 or 47 (744,311)
49. 43 or 48 (940,487)
50. letter.pt. (924,109)
51. editorial.pt. (499,866)
52. note.pt. (628,173)
53. 50 or 51 or 52 (2,052,148)
54. 49 not 53 (858,063)
55. (metabolic adj cost).ti,ab. (1050)
56. ((energy or oxygen) adj cost).ti,ab. (3462)
57. ((energy or oxygen) adj expenditure).ti,ab. (23,424)
58. 55 or 56 or 57 (27,048)
59. 54 not 58 (852,398)
60. animal/ (1,703,995)
61. exp animal experiment/ (1,909,383)
62. nonhuman/ (4,685,261)
63. (rat or rats or mouse or mice or hamster or hamsters or animal or animals or dog or dogs or cat or cats or bovine or sheep).ti,ab,sh. (5,233,856)
64. 60 or 61 or 62 or 63 (7,617,710)
65. exp human/ (16,737,281)
66. human experiment/ (347,954)
67. 65 or 66 (16,738,727)
68. 64 not (64 and 67) (5,838,485)
69. 59 not 68 (781,570)
70. 38 and 69 (429)

Key

/ = indexing term (Emtree heading).

exp = exploded indexing term (Emtree heading).

\$ = truncation.

ti,ab = terms in either title or abstract fields.

af = all fields.

pt = publication type.

sh = subject heading field.

adj2 = terms within two words of each other (any order).

em = entry week – date added to the database.

NHS Economic Evaluations Database

URL: www.crd.york.ac.uk/CRDWeb/

Date range searched: inception to 31 March 2015.

Date searched: 16 February 2016.

Records retrieved: 14.

Search strategy

1	(MeSH DESCRIPTOR Arthritis, Psoriatic) in NHS EED	11
2	((psoria* NEAR2 (arthrit* or arthropath*))) in NHS EED	17
3	((arthrit* or arthropath*) NEAR2 psoria*) in NHS EED	12
4	MeSH DESCRIPTOR Certolizumab Pegol in NHS EED	2
5	((Certolizumab or Cimzia or CZP or CDP870 or CDP-870 or 428863-50-7)) in NHS EED	3
6	((secukinumab or Cosentyx or AIN457 or AIN-457 or 1229022-83-6)) in NHS EED	0
7	((golimumab or simponi or CNTO148 or CNTO-148 or 476181-74-5)) in NHS EED where lpd from 1 January 2010 to 31 March 2015	2
8	((apremilast or otezla or otezia or CC10004 or CC-10004 or 608141-41-9)) in NHS EED where lpd from 1 January 2014 to 31 March 2015	0
9	MeSH DESCRIPTOR Ustekinumab in NHS EED	7
10	((ustekinumab or stelara or CNTO1275 or CNTO-1275 or 815610-63-0)) in NHS EED where lpd from 1 January 2012 to 31 March 2015	9
11	((inflectra or remsima or CT-P13)) in NHS EED	0
12	MeSH DESCRIPTOR Etanercept in NHS EED	52
13	MeSH DESCRIPTOR Infliximab in NHS EED	75
14	MeSH DESCRIPTOR Adalimumab in NHS EED	47
15	((etanercept or enbrel or 185243-69-0)) in NHS EED where lpd from 1 January 2009 to 31 March 2015	61
16	((infliximab or remicade or 170277-31-3)) in NHS EED where lpd from 1 January 2009 to 31 March 2015	85
17	((adalimumab or humira or D2E7 or D2-E7 or 331731-18-1)) in NHS EED where lpd from 1 January 2009 to 31 March 2015	64
18	#1 OR #2 OR #3	17
19	#4 OR #5 OR #6 OR #7 OR #8 OR #9 OR #10 OR #11 OR #12 OR #13 OR #14 OR #15 OR #16 OR #17	135
20	#18 AND #19	14

Key

MeSH DESCRIPTOR = indexing term (MeSH heading).

* = truncation.

NEAR2 = terms within two words of each other (order specified).

PubMed

URL: www.ncbi.nlm.nih.gov/pubmed/

Date searched: 16 February 2016.

Records retrieved: 58.

Search strategy

((economic evaluation*[TIAB] OR economic analy*[TIAB] OR cost analy*[TIAB] OR cost effectiveness[TIAB] OR cost benefit*[TIAB] OR cost utilit*[TIAB]) OR ('Costs and Cost Analysis'[Mesh])) AND (((('Arthritis, Psoriatic'[Mesh:noexp] OR (psoria*[Title/Abstract] AND arthrit*[Title/Abstract]) OR (psoria*[Title/Abstract] AND arthropath*[Title/Abstract]))) AND (('Certolizumab Pegol'[Mesh:noexp] OR (Certolizumab OR Cimzia OR CZP OR CDP870 OR CDP-870 OR 428863-50-7) OR (secukinumab OR Cosentyx OR AIN457 OR AIN-457 OR 1229022-83-6) OR ((golimumab OR simponi OR CNTO148 OR CNTO-148 OR 476181-74-5) AND '2010/01/01'[Date - Entrez] : '3000'[Date - Entrez]) OR ((apremilast OR otezla OR otezia OR CC10004 OR CC-10004 OR 608141-41-9) AND ('2014/01/01'[Date - Entrez] : '3000'[Date - Entrez])) OR ('Ustekinumab'[Mesh:noexp] OR ((ustekinumab OR stelara OR CNTO1275 OR CNTO-1275 OR 815610-63-0) AND ('2012/01/01'[Date - Entrez] : '3000'[Date - Entrez])) OR (inflectra OR remsima OR CT-P13) OR ('Etanercept'[Mesh:noexp] OR ((etanercept OR enbrel OR 185243-69-0) AND ('2009/01/01'[Date - Entrez] : '3000'[Date - Entrez])) OR ('Infliximab'[Mesh:noexp] OR ((infliximab OR remicade OR 170277-31-3) AND ('2009/01/01'[Date - Entrez] : '3000'[Date - Entrez])) OR ('Adalimumab'[Mesh:noexp] OR ((adalimumab OR humira OR D2E7 OR D2-E7 OR 331731-18-1) AND ('2009/01/01'[Date - Entrez] : '3000'[Date - Entrez]))))

Key

[Mesh] = exploded indexing term (MeSH heading).

[Mesh:noexp] = indexing term (MeSH heading) not exploded.

* = truncation.

[Title/Abstract] = terms in either title or abstract fields.

[Date - Entrez] = date added to the database.

Science Citation Index

Via Web of Science, Thomson Reuters: <http://thomsonreuters.com/thomson-reuters-web-of-science/>

Date range searched: 1900 to 12 February 2016.

Date searched: 15 February 2016.

Records retrieved: 111.

Search strategy

# 23	111	#22 OR #19 <i>Indexes=SCI-EXPANDED Timespan=All years</i>
# 22	95	#21 <i>Indexes=SCI-EXPANDED Timespan=2009-2016</i>
# 21	143	#20 not #16 <i>Indexes=SCI-EXPANDED Timespan=All years</i>
# 20	149	#15 AND #14 AND #3 <i>Indexes=SCI-EXPANDED Timespan=All years</i>
# 19	38	#18 not #16 <i>Indexes=SCI-EXPANDED Timespan=All years</i>
# 18	39	#17 AND #15 AND #3 <i>Indexes=SCI-EXPANDED Timespan=All years</i>
# 17	3,371	#9 OR #8 OR #7 OR #6 OR #5 OR #4 <i>Indexes=SCI-EXPANDED Timespan=All years</i>
# 16	3,889,643	TS=(rat or rats or mouse or mice or hamster or hamsters or animal or animals or dog or dogs or cat or cats or bovine or sheep or guinea*) <i>Indexes=SCI-EXPANDED Timespan=All years</i>
# 15	1,036,604	TS=(economic* or cost* or price or prices or pricing or pharmacoeconomic*) <i>Indexes=SCI-EXPANDED Timespan=All years</i>
# 14	23,253	#13 <i>Indexes=SCI-EXPANDED Timespan=All years</i>
# 13	23,253	#12 OR #11 OR #10 <i>Indexes=SCI-EXPANDED Timespan=All years</i>
# 12	6,187	TS=(adalimumab or humira or D2E7 or D2-E7 or 331731-18-1) <i>Indexes=SCI-EXPANDED Timespan=All years</i>
# 11	15,582	TS=(infliximab or remicade or 170277-31-3) <i>Indexes=SCI-EXPANDED Timespan=All years</i>
# 10	8,277	TS=(etanercept or enbrel or 185243-69-0) <i>Indexes=SCI-EXPANDED Timespan=All years</i>
# 9	56	TS=(inflectra or remsima or CT-P13) <i>Indexes=SCI-EXPANDED Timespan=All years</i>

# 8	962	TS=(ustekinumab or stelara or CNTO1275 or CNTO-1275 or 815610-63-0) <i>Indexes=SCI-EXPANDED Timespan=All years</i>
# 7	240	TS=(apremilast or otezla or otezia or CC10004 or CC-10004 or 608141-41-9) <i>Indexes=SCI-EXPANDED Timespan=All years</i>
# 6	709	TS=(golimumab or simponi or CNTO148 or CNTO-148 or 476181-74-5) <i>Indexes=SCI-EXPANDED Timespan=All years</i>
# 5	275	TS=(secukinumab or Cosentyx or AIN457 or AIN-457 or 1229022-83-6) <i>Indexes=SCI-EXPANDED Timespan=All years</i>
# 4	1,407	TS=(Certolizumab or Cimzia or CZP or CDP870 or CDP-870 or 428863-50-7) <i>Indexes=SCI-EXPANDED Timespan=All years</i>
# 3	11,992	#2 OR #1 <i>Indexes=SCI-EXPANDED Timespan=All years</i>
# 2	659	TS=(psoria* same arthropath*) <i>Indexes=SCI-EXPANDED Timespan=All years</i>
# 1	11,744	TS=(psoria* same arthrit*) <i>Indexes=SCI-EXPANDED Timespan=All years</i>

Key

TS = topic tag; searches terms in title, abstract, author keywords and keywords plus fields.

* = truncation.

SAME = terms within the same sentence.

Appendix 5 Quality assessment checklists for company-submitted models

Checklist for the Novartis model

Study question	Grade	Comments
1. Costs and effects examined	✓	
2. Alternatives compared	x	In the one prior DMARD population and the anti-TNF experienced population
3. The viewpoint(s)/perspective of the analysis is clearly stated (e.g. NHS, society)	✓	
Selection of alternatives		
4. All relevant alternatives are compared (including do-nothing if applicable)	x	In the one prior DMARD population, other anti-TNFs can be applicable
5. The alternatives being compared are clearly described (who did what, to whom, where and how often)	✓	
6. The rationale for choosing the alternative programmes or interventions compared is stated	✓	
Form of evaluation		
7. The choice of form of economic evaluation is justified in relation to the questions addressed	✓	
8. If a cost-minimisation design is chosen, have equivalent outcomes been adequately demonstrated?	N/A	
Effectiveness data		
9. The source(s) of effectiveness estimates used are stated (e.g. single study, selection of studies, systematic review, expert opinion)	✓	
10. Effectiveness data from RCT or review of RCTs	✓	
11. Potential biases identified (especially if data not from RCTs)	✓	
12. Details of the method of synthesis or meta-analysis of estimates are given (if based on an overview of a number of effectiveness studies)	✓	WinBUGS code presented
Costs		
13. All the important and relevant resource use included	x	Severe psoriasis costs are not accounted
14. All the important and relevant resource use measured accurately (with methodology)	✓	
15. Appropriate unit costs estimated (with methodology)	✓	
16. Unit costs reported separately from resource use data	✓	
17. Productivity costs treated separately from other costs	✓	
18. The year and country to which unit costs apply is stated with appropriate adjustments for inflation and/or currency conversion	✓	

Study question	Grade	Comments
Benefit measurement and valuation		
19. The primary outcome measure(s) for the economic evaluation are clearly stated	✓	
20. Methods to value health states and other benefits are stated	✓	
21. Details of the individuals from whom valuations were obtained are given	✓	
Decision modelling		
22. Details of any decision model used are given (e.g. decision tree, Markov model)	✓	
23. The choice of model used and the key input parameters on which it is based are adequately detailed and justified	✓	
24. All model outputs described adequately	✓	
Discounting		
25. Discount rate used for both costs and benefits	✓	
26. Do discount rates accord with NHS guidance?	✓	
Allowance for uncertainty		
<i>Stochastic analysis of patient-level data</i>		
27. Details of statistical tests and CIs are given for stochastic data	N/A	
28. Uncertainty around cost-effectiveness expressed (e.g. CI around ICER, cost-effectiveness acceptability curves)	N/A	
29. Sensitivity analysis used to assess uncertainty in non-stochastic variables (e.g. unit costs, discount rates) and analytic decisions (e.g. methods to handle missing data)	N/A	
<i>Stochastic analysis of decision models</i>		
30. Are all appropriate input parameters included with uncertainty?	✓	
31. Is second-order uncertainty (uncertainty in means) included rather than first order (uncertainty between patients)?	✓	
32. Are the probability distributions adequately detailed and appropriate?	✓	
33. Sensitivity analysis used to assess uncertainty in non-stochastic variables (e.g. unit costs, discount rates) and analytic decisions (e.g. methods to handle missing data)	✓	
Deterministic analysis		
34. The approach to sensitivity analysis is given (e.g. univariate, threshold analysis, etc.)	✓	
35. The choice of variables for sensitivity analysis is justified	✓	
36. The ranges over which the variables are varied are stated	✓	
Presentation of results		
37. Incremental analysis is reported using appropriate decision rules	✓	
38. Major outcomes are presented in a disaggregated as well as aggregated form	✓	
39. Applicable to the NHS setting	✓	
N/A, not applicable.		

Checklist for the UCB Pharma model

Study question	Grade	Comments
1. Costs and effects examined	✓	
2. Alternatives compared	X	In the one prior DMARD population
3. The viewpoint(s)/perspective of the analysis is clearly stated (e.g. NHS, society)	✓	
Selection of alternatives		
4. All relevant alternatives are compared (including do-nothing if applicable)	✓	
5. The alternatives being compared are clearly described (who did what, to whom, where and how often)	X	It was not clear how the SEC was modelled as the cost refers to a mix of the two strengths of SEC, 150 mg and 300 mg
6. The rationale for choosing the alternative programmes or interventions compared is stated	✓	
Form of evaluation		
7. The choice of form of economic evaluation is justified in relation to the questions addressed	✓	
8. If a cost-minimisation design is chosen, have equivalent outcomes been adequately demonstrated?	N/A	
Effectiveness data		
9. The source(s) of effectiveness estimates used are stated (e.g. single study, selection of studies, systematic review, expert opinion)	✓	
10. Effectiveness data from RCT or review of RCTs	✓	
11. Potential biases identified (especially if data not from RCTs)	✓	
12. Details of the method of synthesis or meta-analysis of estimates are given (if based on an overview of a number of effectiveness studies)	✓	WinBUGS code presented
Costs		
13. All the important and relevant resource use included	X	Severe psoriasis costs are not accounted
14. All the important and relevant resource use measured accurately (with methodology)	✓	
15. Appropriate unit costs estimated (with methodology)	✓	
16. Unit costs reported separately from resource use data	✓	
17. Productivity costs treated separately from other costs	✓	
18. The year and country to which unit costs apply is stated with appropriate adjustments for inflation and/or currency conversion	✓	
Benefit measurement and valuation		
19. The primary outcome measure(s) for the economic evaluation are clearly stated	✓	
20. Methods to value health states and other benefits are stated	✓	
21. Details of the individuals from whom valuations were obtained are given	✓	

Study question	Grade	Comments
Decision modelling		
22. Details of any decision model used are given (e.g. decision tree, Markov model)	✓	
23. The choice of model used and the key input parameters on which it is based are adequately detailed and justified	✓	
24. All model outputs described adequately	✓	
Discounting		
25. Discount rate used for both costs and benefits	✓	
26. Do discount rates accord with NHS guidance?	✓	
Allowance for uncertainty		
<i>Stochastic analysis of patient-level data</i>		
27. Details of statistical tests and CIs are given for stochastic data	N/A	
28. Uncertainty around cost-effectiveness expressed (e.g. CI around ICER, cost-effectiveness acceptability curves)	N/A	
29. Sensitivity analysis used to assess uncertainty in non-stochastic variables (e.g. unit costs, discount rates) and analytic decisions (e.g. methods to handle missing data)	N/A	
<i>Stochastic analysis of decision models</i>		
30. Are all appropriate input parameters included with uncertainty?	✓	
31. Is second-order uncertainty (uncertainty in means) included rather than first order (uncertainty between patients)?	✓	
32. Are the probability distributions adequately detailed and appropriate?	✓	
33. Sensitivity analysis used to assess uncertainty in non-stochastic variables (e.g. unit costs, discount rates) and analytic decisions (e.g. methods to handle missing data)	✓	
Deterministic analysis		
34. The approach to sensitivity analysis is given (e.g. univariate, threshold analysis, etc.)	✓	
35. The choice of variables for sensitivity analysis is justified	✓	
36. The ranges over which the variables are varied are stated	✓	
Presentation of results		
37. Incremental analysis is reported using appropriate decision rules	✗	Reporting the incremental results was not performed properly
38. Major outcomes are presented in a disaggregated as well as aggregated form	✓	
39. Applicable to the NHS setting	✓	
N/A, not applicable.		

Appendix 6 Clinical effectiveness inputs applied in the company models

Subpopulation 1: biologic naive, one prior DMARD

TABLE 176 Response parameters applied in model for subpopulation 1: UCB Pharma

Treatment	PsARC	PASI 50	PASI 75	PASI 90	Source
CZP	Confidential information has been removed	Confidential information has been removed	Confidential information has been removed	Confidential information has been removed	RAPID-PsA ⁴⁷ trial subgroup (one prior DMARD)
cDMARD	Confidential information has been removed	Confidential information has been removed	Confidential information has been removed	Confidential information has been removed	RAPID-PsA ⁴⁷ trial subgroup (one prior DMARD)

TABLE 177 Response parameters applied in model for subpopulation 1: Novartis

Treatment	PsARC	PASI 50	PASI 75	PASI 90	Source
150 mg of SEC	Confidential information has been removed	Confidential information has been removed	Confidential information has been removed	Confidential information has been removed	FUTURE 2 ⁴⁸ trial subgroup (one prior DMARD)
SoC	Confidential information has been removed	Confidential information has been removed	Confidential information has been removed	Confidential information has been removed	FUTURE 2 ⁴⁸ trial subgroup (one prior DMARD)

TABLE 178 Health Assessment Questionnaire-Disability Index score change according to the PsARC response for subpopulation 1: UCB Pharma

Treatment	PsARC responders	PsARC non-responders	Source
CZP	Confidential information has been removed	Confidential information has been removed	RAPID-PsA ⁴⁷ trial subgroup (one prior DMARD)
cDMARD	Confidential information has been removed	Confidential information has been removed	RAPID-PsA ⁴⁷ trial subgroup (one prior DMARD)

TABLE 179 Health Assessment Questionnaire-Disability Index score change according to the PsARC response for subpopulation 1: Novartis

Treatment	PsARC responders	PsARC non-responders	Source
150 mg of SEC	Confidential information has been removed	Confidential information has been removed	FUTURE 2 ⁴⁸ subgroup (one prior DMARD)
SoC	Confidential information has been removed	Confidential information has been removed	FUTURE 2 ⁴⁸ subgroup (one prior DMARD)

Subpopulation 2: biologic naive (one or more prior DMARDs, UCB Pharma; two or more prior DMARDs, Novartis)

TABLE 180 Response parameters applied in model for subpopulation 1: UCB Pharma

Treatment	PsARC	PASI 50	PASI 75	PASI 90	Source
CZP	Confidential information has been removed	Confidential information has been removed	Confidential information has been removed	Confidential information has been removed	NMA, naive population
150 mg of SEC	Confidential information has been removed	Confidential information has been removed	Confidential information has been removed	Confidential information has been removed	Confidential information has been removed
ETN	Confidential information has been removed	Confidential information has been removed	Confidential information has been removed	Confidential information has been removed	NMA, naive population
INF	Confidential information has been removed	Confidential information has been removed	Confidential information has been removed	Confidential information has been removed	NMA, naive population
ADA	Confidential information has been removed	Confidential information has been removed	Confidential information has been removed	Confidential information has been removed	NMA, naive population
GOL	Confidential information has been removed	Confidential information has been removed	Confidential information has been removed	Confidential information has been removed	NMA, naive population

TABLE 181 Response parameters applied in model for subpopulation 2: Novartis

Treatment	PsARC	PASI 50	PASI 75	PASI 90	Source
150 mg of SEC	Confidential information has been removed	Confidential information has been removed	Confidential information has been removed	Confidential information has been removed	NMA, overall population
CZP	Confidential information has been removed	Confidential information has been removed	Confidential information has been removed	Confidential information has been removed	NMA, overall population
ETN	Confidential information has been removed	Confidential information has been removed	Confidential information has been removed	Confidential information has been removed	NMA, overall population
INF	Confidential information has been removed	Confidential information has been removed	Confidential information has been removed	Confidential information has been removed	NMA, overall population
ADA	Confidential information has been removed	Confidential information has been removed	Confidential information has been removed	Confidential information has been removed	NMA, overall population
GOL	Confidential information has been removed	Confidential information has been removed	Confidential information has been removed	Confidential information has been removed	NMA, overall population
SoC	Confidential information has been removed	Confidential information has been removed	Confidential information has been removed	Confidential information has been removed	NMA, overall population

TABLE 182 Health Assessment Questionnaire-Disability Index score change according to the PsARC response for subpopulation 2: UCB Pharma

Treatment	PsARC responders	PsARC non-responders	Source
CZP	Confidential information has been removed	Confidential information has been removed	NMA, naive population
150 mg of SEC	Confidential information has been removed	Confidential information has been removed	Confidential information has been removed
ETN	Confidential information has been removed	Confidential information has been removed	Confidential information has been removed
INF	Confidential information has been removed	Confidential information has been removed	Confidential information has been removed
ADA	Confidential information has been removed	Confidential information has been removed	NMA, naive population
GOL	Confidential information has been removed	Confidential information has been removed	Confidential information has been removed

TABLE 183 Health Assessment Questionnaire-Disability Index score change according to the PsARC response for subpopulation 2: Novartis

Treatment	PsARC responders	PsARC non-responders	Source
150 mg of SEC	Confidential information has been removed	Confidential information has been removed	FUTURE 2 trial ⁴⁸
CZP	-0.558	-0.15	Assumption: average TNF effect
ETN	-0.64	-0.2	Cawson <i>et al.</i> , 2014 ³⁶
INF	-0.66	-0.2	Cawson <i>et al.</i> , 2014 ³⁶
ADA	-0.49	-0.14	Cawson <i>et al.</i> , 2014 ³⁶
GOL	-0.44	-0.06	Cawson <i>et al.</i> , 2014 ³⁶
SoC	Confidential information has been removed	Confidential information has been removed	FUTURE 2 trial ⁴⁸

Subpopulation 3: biologic experienced

TABLE 184 Response parameters applied in model for subpopulation 3: UCB Pharma

Treatment	PsARC	PASI 50	PASI 75	PASI 90	Source
CZP	Confidential information has been removed	Confidential information has been removed	Confidential information has been removed	Confidential information has been removed	RAPID-PsA trial, ⁴⁷ experienced subgroup
300 mg of SEC	Confidential information has been removed	Confidential information has been removed	Confidential information has been removed	Confidential information has been removed	Assumption
UST	Confidential information has been removed	Confidential information has been removed	Confidential information has been removed	Confidential information has been removed	Assumption
Mix/SoC	Confidential information has been removed	Confidential information has been removed	Confidential information has been removed	Confidential information has been removed	RAPID-PsA trial, ⁴⁷ experienced subgroup

TABLE 185 Response parameters applied in model for subpopulation 3: Novartis

Treatment	PsARC	PASI 50	PASI 75	PASI 90	Source
300 mg of SEC	Confidential information has been removed	Confidential information has been removed	Confidential information has been removed	Confidential information has been removed	Common efficacy reduction from the FUTURE 2 trial ⁴⁸
CZP	Confidential information has been removed	Confidential information has been removed	Confidential information has been removed	Confidential information has been removed	Common efficacy reduction from the FUTURE 2 trial ⁴⁸
UST	Confidential information has been removed	Confidential information has been removed	Confidential information has been removed	Confidential information has been removed	Common efficacy reduction from the FUTURE 2 trial ⁴⁸
SoC	Confidential information has been removed	Confidential information has been removed	Confidential information has been removed	Confidential information has been removed	Common efficacy reduction from the FUTURE 2 trial ⁴⁸

TABLE 186 Health Assessment Questionnaire-Disability Index score change according to the PsARC response for subpopulation 3: UCB Pharma

Treatment	PsARC responders	PsARC non-responders	Source
CZP	Confidential information has been removed	Confidential information has been removed	RAPID-PsA trial ⁴⁷
300 mg of SEC	Confidential information has been removed	Confidential information has been removed	Assumption
UST	Confidential information has been removed	Confidential information has been removed	Assumption
Mix/SoC	Confidential information has been removed	Confidential information has been removed	RAPID-PsA trial ⁴⁷

TABLE 187 Health Assessment Questionnaire-Disability Index score change according to the PsARC response for subpopulation 3: Novartis

Treatment	PsARC responders	PsARC non-responders	Source
300 mg of SEC	Confidential information has been removed	Confidential information has been removed	Assumption
CZP	Confidential information has been removed	Confidential information has been removed	Assumption
UST	Confidential information has been removed	Confidential information has been removed	Assumption
SoC	Confidential information has been removed	Confidential information has been removed	Assumption

Appendix 7 R code for the updated York model

Confidential information has been removed.

Appendix 8 Cost-effectiveness results using infliximab and etanercept biosimilar prices, subpopulation 2

In a separate scenario analysis, biosimilar prices,¹³⁴ as opposed to list prices for ETN and INF, were used in subpopulation 2 (see *Chapter 6, Choice of intervention and comparators*). This reduces the acquisition cost for ETN from £2332 to £2139 in the first cycle and subsequent cycles. For INF, the acquisition cost falls from £7147 to £6432 in the first cycle and from £3395 to £3056 in subsequent cycles. The results for the three subgroups according to concomitant psoriasis are shown below (see *Tables 188–190*).

Table 188 shows the results for the mild–moderate psoriasis subgroup. In this subgroup, CZP is the least effective biologic treatment, generating 7.226 QALYs, whereas INF generates the highest numbers of QALYs (7.890). Fully incremental analysis shows that 300 mg of SEC is dominated by ADA, GOL and ETN, GOL is dominated by ETN, and CZP and ADA are extendedly dominated. Of the remaining non-dominated alternatives, the ICER of ETN versus BSC is £18,906 per QALY and the ICER of INF versus ETN is £114,044 per QALY.

The individual pairwise ICERs for CZP and 300 mg of SEC compared with BSC are £21,560 and £29,564 per QALY, respectively.

Table 189 shows the results for the mild–moderate psoriasis subgroup. In this subgroup, CZP is the least effective biologic treatment, generating 7.537 QALYs, whereas INF generates the highest number of QALYs (8.161). Performing fully incremental analysis shows that CZP is dominated by 150 mg of SEC, GOL is dominated by ETN, and 150 mg of SEC and ADA are extendedly dominated. Of the remaining non-dominated alternatives, the ICER of ETN versus BSC is £20,951 per QALY and the ICER of INF versus ETN is £170,815 per QALY.

The individual pairwise ICERs for CZP and 150 mg of SEC compared with BSC are £24,107 and £22,032 per QALY, respectively.

For the no concomitant psoriasis subgroup (PASI score = 0) (*Table 190*), INF maintains its position as the most effective treatment (8.543 QALYs), whereas 150 mg of SEC is now the least effective treatment (7.972 QALYs). As expected in this subgroup, the ICERs versus BSC increase compared with the

TABLE 188 Treatment effects from independent analysis for moderate–severe psoriasis, subpopulation 2: fully incremental cost-effectiveness analysis, biosimilar prices

Treatment	Cost (£)	QALYs	Incremental cost (£)	Incremental QALYs	ICER vs. next best option (£)	ICER vs. BSC (£)
BSC	95,965	5.312	–	–	–	–
CZP	137,240	7.226	Extendedly dominated	–	–	21,560
300 mg of SEC	157,086	7.379	Dominated	–	–	29,564
ADA	138,109	7.411	Extendedly dominated	–	–	20,074
GOL	142,850	7.637	Dominated	–	–	20,161
ETN_Sim	141,477	7.719	45,512	2.407	18,906	18,906
INF_Sim	160,993	7.890	19,517	0.171	114,044	25,220

ETN_Sim, etanercept biosimilar; INF_Sim, infliximab biosimilar.

TABLE 189 Treatment effects from independent analysis for mild–moderate psoriasis, subpopulation 2: fully incremental cost-effectiveness analysis, biosimilar prices

Treatment	Cost (£)	QALYs	Incremental cost (£)	Incremental QALYs	ICER vs. next best option (£)	ICER vs. BSC (£)
BSC	67,000	5.676	–	–	–	–
CZP	111,856	7.537	Dominated	–	–	24,107
150 mg of SEC	108,508	7.560	Extendedly dominated	–	–	22,032
ADA	114,039	7.708	Extendedly dominated	–	–	23,153
GOL	119,624	7.923	Dominated	–	–	23,418
ETN_Sim	116,218	8.025	49,217	2.349	20,951	20,951
INF_Sim	139,436	8.161	23,218	0.136	170,815	29,148

ETN_Sim, etanercept biosimilar; INF_Sim, infliximab biosimilar.

TABLE 190 Treatment effects from independent analysis for no concomitant psoriasis, subpopulation 2: fully incremental cost-effectiveness analysis, biosimilar prices

Treatment	Cost (£)	QALYs	Incremental cost (£)	Incremental QALYs	ICER vs. next best option (£)	ICER vs. BSC (£)
BSC	51,436	6.188	–	–	–	–
150 mg of SEC	95,632	7.972	Extendedly dominated	–	–	24,782
CZP	98,060	7.974	Extendedly dominated	–	–	26,117
ADA	100,893	8.125	Extendedly dominated	–	–	25,542
GOL	106,895	8.325	Dominated	–	–	25,951
ETN_Sim	102,484	8.456	51,047	2.268	22,512	22,512
INF_Sim	127,531	8.543	25,047	0.087	289,542	32,325

ETN_Sim, etanercept biosimilar; INF_Sim, infliximab biosimilar.

mild–moderate and severe psoriasis subgroups as a result of benefits being driven entirely by HAQ-DI benefits as opposed to HAQ-DI and PASI. The incremental cost-effectiveness analysis shows that GOL is dominated by ETN. CZP, 150 mg of SEC and ADA are extendedly dominated. Of the non-dominated alternatives, the ICER of ETN versus BSC is £22,512 per QALY and the ICER of INF versus ETN is £289,542 per QALY.

The individual pairwise ICERs for CZP and 150 mg of SEC compared with BSC are £26,117 and £24,782 per QALY, respectively.

Appendix 9 Estimating health-related quality of life for the updated York model

In order to generate an estimate of the lifetime QALYs for each of the treatments, the disease-specific measures, HAQ-DI and PASI, at each cycle of the model, must be mapped onto the utilities scores associated with particular HAQ-DI and PASI combinations. This assumes that HAQ-DI and PASI capture all of the relevant information regarding a PsA patient's quality of life. In the previous York model,³³ this relationship was estimated from analyses provided by the company (Wyeth), it carried out ordinary least squares regressions of EQ-5D utility versus HAQ-DI, PASI and an interaction term HAQ-DI × PASI, in participants in key RCTs. The utility function is given below with standard errors in parentheses:

$$\text{Expected utility} = 0.897(0.006) - 0.298(0.006) \times \text{HAQ-DI} - 0.004(0.0003) \times \text{PASI} \quad (6)$$

The interaction between HAQ-DI and PASI did not reach statistical significance at the 5% level and was therefore excluded from the regression model. *Table 191* presents the results of Wyeth linear regressions of utility versus HAQ-DI, PASI and HAQ-DI × PASI.

The Psoriasis Randomized Etanercept study in Subjects with psoriaTic Arthritis (PRESTA) trial⁴² was used to determine this algorithm. The PRESTA trial is a 24-week clinical study comparing two forms of ETN and includes 752 patients with PsA. The study was originally designed to detect any differences in treatment efficacy for skin manifestations of psoriasis, but these patients also had diagnosed (by a rheumatologist) PsA.

Comparison of the Wyeth algorithm with that from other companies, in the previous York model, showed that the results were similar in all data sets. This indicates that the relationship between HAQ-DI, PASI and utility is stable across independent clinical trials, and gives some assurance about the generalisability to the wider PsA population.

We performed a systematic search to identify any subsequent papers which include mapping functions from HAQ-DI and PASI to utilities (post December 2009). This was not restricted to utilities measured using the EQ-5D. The search strategy can be seen in *Appendix 10*. This identified 2573 potentially relevant records after deduplication. After initial screening, 40 of these records were actually related to PsA and contained information on (preference-rated) quality of life. Of these, only 11 suggested the use of a mapping function to link a preference-based measure of quality of life, such as the EQ-5D or the SF-36, to disease-specific measures, including the HAQ-DI and PASI. Five of these were available only as conference abstracts. The remaining six papers were screened for inclusion (see *Table 192* for a summary of these studies). In conclusion, none of the papers offers a mapping function that will allow the disease-specific measures, HAQ-DI and PASI to be mapped onto a utility score. The existing York utility algorithm is therefore used in the current version of the economic model.

TABLE 191 Full results of Wyeth's linear regressions of utility vs. HAQ-DI, PASI and HAQ-DI × PASI

Wyeth	Coefficients				Variance–covariance matrices			
	Mean	SE	z	p > z	Intercept	HAQ-DI	PASI	HAQ-DI × PASI
Intercept	0.895	0.007	128.652	0.000	0.000048430			
HAQ-DI	-0.295	0.008	-37.157	0.000	-0.000030080	0.000062880		
PASI	-0.004	0.000	-9.039	0.000	-0.000001640	0.000000947	0.000000207	
HAQ-DI × PASI	0.000	0.000	-0.669	0.504	0.000001311	-0.000002207	-0.000000136	0.000000183

TABLE 192 Utilities papers screened for inclusion

Publication (first author and year of publication)	Population	Measures included	Mapping function made explicit in paper?	Relevant for economic model?
Adams <i>et al.</i> , 2010 ¹⁵²	Patients with RA and PsA (<i>n</i> = 504)	HAQ-DI, SF-6D, EQ-5D, EULAR and DAS	Yes, presented separately for EQ-5D and SF-6D	Does not include the PASI
Adams <i>et al.</i> , 2011 ¹⁵³	Patients with RA and PsA (<i>n</i> = 504)	HAQ-DI, SF-36, EQ-5D (revised) and EQ-5D (original)	Yes, presented separately for EQ-5D and SF-6D	Does not include the PASI
Brodzky <i>et al.</i> , 2010 ¹⁵⁴	Patients with PsA (<i>n</i> = 183)	Hungarian versions of HAQ-DI, EQ-5D, PsAQoL, DAS28, VAS, PASI and BASDI	No, looked at correlations between measures individually but no mapping	No
Gratacós <i>et al.</i> , 2014 ¹⁵⁵	Patients with PsA (<i>n</i> = 287)	PASI, HAQ-DI, number of swollen and tender joints, SF-36 and EQ-5D	Yes, multivariate analysis conducted	Does not include the HAQ-DI in the EQ-5D model; instead includes the number of swollen and tender joints and the PASI. EQ-5D not included in the HAQ-DI model
Leung <i>et al.</i> , 2013 ¹⁵⁶	Patients with PsA (<i>n</i> = 86)	EQ-5D and SF-6D	Not undertaken. Does not include the HAQ-DI or PASI	No
Picchianti-Diamanti <i>et al.</i> , 2010 ¹⁵⁷	Patients with RA and PsA (<i>n</i> = 80)	HAQ-DI, SF-36 and DAS	Not undertaken. Reports scores separately	No

BASDI, Bath Ankylosing Spondylitis Disease Activity Index; DAS, Disease Activity Score; DAS28, Disease Activity Score 28; PsAQoL, Psoriatic Arthritis Quality of Life; SF-6D, Short-Form Six-Dimension.

Appendix 10 Search strategy for utility studies

Database

Ovid MEDLINE(R) In-Process & Other Non-Indexed Citations.

Ovid MEDLINE(R).

Date range searched: 1946 to present.

Search strategy

1. (sf36 or sf 36).ti,ab. (15,462)
2. (eq5d or eq 5d or euroqol or euro qol).ti,ab. (5427)
3. (short form 36 or shortform 36 or sf thirtysix or sf thirty six or shortform thirtysix or shortform thirty six or short form thirtysix or short form thirty six).ti,ab. (7310)
4. (hrql or hrqol or h qol or hql or hqol).ti,ab. (12,181)
5. (hye or hyes or health\$ year\$ equivalent\$ or health utilit\$).ti,ab. (1375)
6. health related quality of life.ti,ab. (26,941)
7. rosser.ti,ab. (74)
8. (standard gamble\$ or time trade off or time tradeoff or 'tto' or willingness to pay).ti,ab. (4653)
9. (utilities or utility or daly or dalys or disability adjusted life).ti,ab. (140,271)
10. 'Quality of Life' / (132,981)
11. (quality of life or life quality).ti,ab. (178,851)
12. health status indicators / (20,944)
13. quality adjusted life year / (8035)
14. (qaly\$ or quality adjusted).ti,ab. (9209)
15. (qwb\$ or hui or hui1 or hui2 or hui3 or qwi).ti,ab. (1249)
16. (quality of wellbeing or quality of well being).ti,ab. (360)
17. preference based.ti,ab. (841)
18. (dermatology life quality index or health status).ti,ab. (42,673)
19. (state\$ adj2 (value or values or valuing or valued)).ti,ab. (2630)
20. (dlqi or hspv).ti,ab. (688)
21. general health questionnaire.ti,ab. (3748)
22. nottingham health profile.ti,ab. (1019)
23. patient generated index.ti,ab. (44)
24. sickness impact profile.ti,ab. (1019)
25. (ghq or nhp or pgi or sip or uksip or wtp).ti,ab. (10,048)
26. or/1-25 (425,323)
27. (PSAQoL or psoriatic arthritis quality of life or PsA quality of life).ti,ab. (14)
28. (PASI or psoriasis area severity index).ti,ab. (1737)
29. (PsARC or Psoriatic Arthritis Response Criteria).ti,ab. (44)
30. (HAQ-DI or Health Assessment Questionnaire).ti,ab. (3581)
31. or/27-30 (5285)
32. Arthritis, Psoriatic / (4270)
33. (psoria\$ adj2 (arthrit\$ or arthropath\$)).ti,ab. (6737)
34. 32 or 33 (7581)
35. 26 and 34 (655)
36. 31 and 34 (424)
37. 35 or 36 (918)
38. (letter or editorial or comment).pt. (1,456,654)

39. 37 not 38 (902)
40. exp animals/ not humans/ (4,189,142)
41. 39 not 40 (899)
42. limit 41 to yr='2009 -Current' (595)

Appendix 11 Identifying additional psoriatic arthritis health state costs

Methods

This is a very broad literature and an exhaustive review was beyond the time constraints of this appraisal. Instead, a rapid review was undertaken of the following sources, since the previous MTA (December 2009):

- evidence presented to previous NICE appraisals of PsA treatments
- the CSs to the current appraisal
- citation searches using Rodgers *et al.*³³

Relevant cost data for the economic model must satisfy the following criteria:

- The data should be specific to patients with PsA.
- The data must show a causal relationship from the HAQ-DI and PASI to subsequent health service utilisation and costs.
- The data should report mean costs conditional on the HAQ-DI and PASI and measures of sampling uncertainty.
- The data should measure costs not charges or prices.
- Preferably data would be taken from the UK; where this is not possible, it is important to assess whether or not studies from other countries are likely to be generalisable to the UK, particularly countries with mixed public/private financing such as the USA.
- The data should measure all direct health-care costs in the hospital, outpatient and community; productivity losses should be reported separately (the base-case model excludes productivity losses in accordance with the NICE reference case).
- The data should estimate the costs of medications separately from those of other health services; the economic model includes these costs separately from the effect of HAQ-DI/PASI on costs.
- The data should state the price year, the currency and other data to allow adjustment to the UK in 2016.

Results

An additional relevant reference was found from the recent STA for APR in PsA. In this, the company identified a paper by Poole *et al.*¹³⁸ The citation searches for Rodgers *et al.*³³ did not identify any further published studies. One conference abstract was identified;¹⁵⁸ however, the costs relating to PsA patients have not been published and contact with the author did not receive a response. The GOL and UST STAs both used the Rodgers *et al.*'s³³ algorithms for costs. The advantages and disadvantages of the previous York HAQ-DI costs and Poole *et al.*'s¹³⁸ costs are discussed in *Chapter 6, Health state costs*.

Appendix 12 Metaregression results

Results utilising the metaregression estimates for effectiveness parameters are presented in *Tables 193–198* for each of the subpopulations and subgroups.

Subpopulation 1

TABLE 193 Treatment effects from metaregression for moderate–severe psoriasis, subpopulation 1: fully incremental cost-effectiveness analysis

Treatment	Cost (£)	QALYs	Incremental cost (£)	Incremental QALYs	ICER vs. next best option (£)	ICER vs. BSC (£)
BSC	95,965	5.312	–	–	–	–
CZP	161,347	8.596	65,382	3.284	19,908	19,908
300 mg of SEC	186,956	8.677	25,609	0.082	313,571	27,033

TABLE 194 Treatment effects from metaregression for mild–moderate psoriasis, subpopulation 1: fully incremental cost-effectiveness analysis

Treatment	Cost (£)	QALYs	Incremental cost (£)	Incremental QALYs	ICER vs. next best option (£)	ICER vs. BSC (£)
BSC	67,000	5.676	–	–	–	–
150 mg of SEC	134,957	8.869	67,956	3.192	21,287	21,287
CZP	138,698	8.870	3741	0.002	2,010,048	22,446

TABLE 195 Treatment effects from metaregression for no concomitant psoriasis, subpopulation 1: fully incremental cost-effectiveness analysis

Treatment	Cost (£)	QALYs	Incremental cost (£)	Incremental QALYs	ICER vs. next best option (£)	ICER vs. BSC (£)
BSC	51,436	6.188	–	–	–	–
150 mg of SEC	122,938	9.243	71,502	3.055	23,408	23,408
CZP	126,253	9.256	3315	0.013	252,218	24,388

Subpopulation 2

TABLE 196 Treatment effects from metaregression for moderate–severe psoriasis, subpopulation 2: fully incremental cost-effectiveness analysis

Treatment	Cost (£)	QALYs	Incremental cost (£)	Incremental QALYs	ICER vs. next best option (£)	ICER vs. BSC (£)
BSC	95,965	5.312	–	–	–	–
ADA	136,766	7.342	–	–	Extendedly dominated	20,092
GOL	141,113	7.486	–	–	Dominated	Confidential information has been removed
CZP	139,489	7.496	43,524	2.185	19,923	19,923
300 mg of SEC	165,222	7.586	–	–	Dominated	Confidential information has been removed
ETN	143,538	7.626	4049	0.130	31,090	20,552
INF	165,132	7.685	21,594	0.059	366,216	29,138

TABLE 197 Treatment effects from metaregression analysis for mild–moderate psoriasis, subpopulation 2: fully incremental cost-effectiveness analysis

Treatment	Cost (£)	QALYs	Incremental cost (£)	Incremental QALYs	ICER vs. next best option (£)	ICER vs. BSC (£)
BSC	67,000	5.676	–	–	–	–
ADA	112,468	7.642	–	–	Dominated	23,130
GOL	116,438	7.788	–	–	Dominated	Confidential information has been removed
CZP	115,516	7.791	–	–	Dominated	Confidential information has been removed
150 mg of SEC	111,894	7.796	44,894	2.120	21,177	21,177
ETN	118,339	7.933	6445	0.137	47,137	22,750
INF	142,056	7.971	23,717	0.038	616,950	32,703

TABLE 198 Treatment effects from metaregression for no concomitant psoriasis, subpopulation 2: fully incremental cost-effectiveness analysis

Treatment	Cost (£)	QALYs	Incremental cost (£)	Incremental QALYs	ICER vs. next best option (£)	ICER vs. BSC (£)
BSC	51,436	6.188	–	–	–	–
ADA	99,209	8.063	–	–	Extendedly dominated	25,485
150 mg of SEC	99,225	8.199	47,789	2.011	23,768	23,768
CZP	102,418	8.205	–	–	Extendedly dominated	Confidential information has been removed
GOL	102,993	8.212	–	–	Extendedly dominated	Confidential information has been removed
ETN	104,635	8.363	5410	0.164	32,926	24,460
INF	129,401	8.373	24,766	0.010	2,571,503	35,689

Appendix 13 Results from alternative scenarios

Baseline Health Assessment Questionnaire-Disability Index according to subpopulation

TABLE 199 Treatment effects from independent analysis for moderate–severe psoriasis, subpopulation 1: fully incremental cost-effectiveness analysis, subpopulation-specific baseline HAQ-DI score

Treatment	Cost (£)	QALYs	Incremental cost (£)	Incremental QALYs	ICER vs. next best option (£)	ICER vs. BSC (£)
BSC	95,460	5.540	–	–	–	–
CZP	159,431	8.629	63,971	3.089	20,709	20,709
300 mg of SEC	179,172	8.775	19,741	0.146	134,880	25,873

TABLE 200 Treatment effects from independent analysis for mild–moderate psoriasis, subpopulation 1: fully incremental cost-effectiveness analysis, subpopulation-specific baseline HAQ-DI score

Treatment	Cost (£)	QALYs	Incremental cost (£)	Incremental QALYs	ICER vs. next best option (£)	ICER vs. BSC (£)
BSC	66,495	5.904	–	–	–	–
CZP	135,426	8.917	Dominated	–	–	22,874
150 mg of SEC	131,980	8.935	65,485	3.031	21,604	21,604

TABLE 201 Treatment effects from independent analysis for no concomitant psoriasis, subpopulation 1: fully incremental cost-effectiveness analysis, subpopulation-specific baseline HAQ-DI score

Treatment	Cost (£)	QALYs	Incremental cost (£)	Incremental QALYs	ICER vs. next best option (£)	ICER vs. BSC (£)
BSC	50,931	6.414	–	–	–	–
150 mg of SEC	119,783	9.315	68,852	2.901	23,732	23,732
CZP	122,312	9.322	2529	0.007	351,603	24,543

TABLE 202 Treatment effects from independent analysis for moderate–severe psoriasis, subpopulation 2: fully incremental cost-effectiveness analysis, subpopulation-specific baseline HAQ-DI score

Treatment	Cost (£)	QALYs	Incremental cost (£)	Incremental QALYs	ICER vs. next best option (£)	ICER vs. BSC (£)
BSC	96,544	5.049	–	–	–	–
CZP	137,839	6.942	Extendedly dominated	–	–	21,809
300 mg of SEC	157,685	7.095	Dominated	–	–	29,877
ADA	138,709	7.127	42,165	2.078	20,295	20,295
GOL	143,451	7.350	Extendedly dominated	–	–	20,384
ETN	145,186	7.432	6477	0.306	21,183	20,409
INF	167,727	7.603	22,541	0.171	131,805	27,866

TABLE 203 Treatment effects from independent analysis for mild–moderate psoriasis, subpopulation 2: fully incremental cost-effectiveness analysis, subpopulation-specific baseline HAQ-DI score

Treatment	Cost (£)	QALYs	Incremental cost (£)	Incremental QALYs	ICER vs. next best option (£)	ICER vs. BSC (£)
BSC	67,580	5.416	–	–	–	–
CZP	112,455	7.255	Dominated	–	–	24,395
150 mg of SEC	109,107	7.278	41,527	1.863	22,294	22,294
ADA	114,639	7.425	Extendedly dominated	–	–	23,418
GOL	120,225	7.638	Extendedly dominated	–	–	23,687
ETN	119,927	7.741	10,820	0.462	23,400	22,514
INF	146,170	7.876	26,243	0.136	193,511	31,938

TABLE 204 Treatment effects from independent analysis for no concomitant psoriasis, subpopulation 2: fully incremental cost-effectiveness analysis, subpopulation-specific baseline HAQ-DI score

Treatment	Cost (£)	QALYs	Incremental cost (£)	Incremental QALYs	ICER vs. next best option (£)	ICER vs. BSC (£)
BSC	52,016	5.930	–	–	–	–
150 mg of SEC	96,231	7.692	Extendedly dominated	–	–	25,096
CZP	98,659	7.694	Extendedly dominated	–	–	26,444
ADA	101,493	7.844	Extendedly dominated	–	–	25,851
GOL	107,496	8.042	Dominated	–	–	26,267
ETN	106,193	8.173	54,178	2.243	24,150	24,150
INF	134,265	8.259	28,072	0.086	326,736	35,311

TABLE 205 Treatment effects from independent analysis for moderate–severe psoriasis, subpopulation 3: fully incremental cost-effectiveness analysis, subpopulation-specific baseline HAQ-DI score

Treatment	Cost (£)	QALYs	Incremental cost (£)	Incremental QALYs	ICER vs. next best option (£)	ICER vs. BSC (£)
BSC	97,192	4.756	–	–	–	–
UST	119,384	5.750	22,192	0.995	22,309	22,309
300 mg of SEC	144,796	6.045	25,412	0.294	86,320	36,926

TABLE 206 Treatment effects from independent analysis for mild–moderate psoriasis, subpopulation 3: fully incremental cost-effectiveness analysis, subpopulation-specific baseline HAQ-DI score

Treatment	Cost (£)	QALYs	Incremental cost (£)	Incremental QALYs	ICER vs. next best option (£)	ICER vs. BSC (£)
BSC	68,228	5.124	–	–	–	–
UST	92,503	6.086	24,276	0.962	25,239	25,239
300 mg of SEC	119,826	6.361	27,323	0.275	99,385	41,721

TABLE 207 Treatment effects from independent analysis for no concomitant psoriasis, subpopulation 3: fully incremental cost-effectiveness analysis, subpopulation-specific baseline HAQ-DI score

Treatment	Cost (£)	QALYs	Incremental cost (£)	Incremental QALYs	ICER vs. next best option (£)	ICER vs. BSC (£)
BSC	52,664	5.641	–	–	–	–
UST	77,968	6.556	25,305	0.916	27,638	27,638
300 mg of SEC	106,235	6.804	28,267	0.248	114,170	46,057

Alternative Health Assessment Questionnaire-Disability Index costs from Poole *et al.*

TABLE 208 Treatment effects from independent analysis for moderate–severe psoriasis, subpopulation 2: fully incremental cost-effectiveness analysis, HAQ-DI costs from Poole *et al.*¹³⁸

Treatment	Cost (£)	QALYs	Incremental cost (£)	Incremental QALYs	ICER vs. next best option (£)	ICER vs. BSC (£)
BSC	137,167	5.312	–	–	–	–
CZP	143,130	7.226	Extendedly dominated	–	–	3115
300 mg of SEC	165,077	7.379	Dominated	–	–	13,500
ADA	143,610	7.411	Extendedly dominated	–	–	3069
GOL	144,712	7.637	Dominated	–	–	3244
ETN	144,009	7.719	6843	2.407	2842	2842
INF	170,780	7.890	26,771	0.171	156,435	13,036

TABLE 209 Treatment effects from independent analysis for mild–moderate psoriasis, subpopulation 2: fully incremental cost-effectiveness analysis, HAQ-DI costs from Poole *et al.*¹³⁸

Treatment	Cost (£)	QALYs	Incremental cost (£)	Incremental QALYs	ICER vs. next best option (£)	ICER vs. BSC (£)
BSC	137,167	5.676	–	–	–	–
CZP	143,130	7.537	Dominated	–	–	3205
150 mg of SEC	140,366	7.560	3199	1.884	1698	1698
ADA	143,610	7.708	Extendedly dominated	–	–	3171
GOL	144,712	7.923	Dominated	–	–	3358
ETN	144,009	8.025	3643	0.465	7832	2913
INF	170,780	8.161	26,771	0.136	196,949	13,526

TABLE 210 Treatment effects from independent analysis for no concomitant psoriasis, subpopulation 2: fully incremental cost-effectiveness analysis, HAQ-DI costs from Poole *et al.*¹³⁸

Treatment	Cost (£)	QALYs	Incremental cost (£)	Incremental QALYs	ICER vs. next best option (£)	ICER vs. BSC (£)
BSC	137,167	6.188	–	–	–	–
150 mg of SEC	140,366	7.972	3199	1.783	1794	1794
CZP	143,130	7.974	Extendedly dominated	–	–	3341
ADA	143,610	8.125	Extendedly dominated	–	–	3328
GOL	144,712	8.325	Dominated	–	–	3531
ETN	144,009	8.456	6843	2.268	3018	3018
INF	170,780	8.543	26,771	0.087	309,469	14,279

TABLE 211 Treatment effects from independent analysis for moderate–severe psoriasis, subpopulation 3: fully incremental cost-effectiveness analysis, HAQ-DI costs from Poole *et al.*¹³⁸

Treatment	Cost (£)	QALYs	Incremental cost (£)	Incremental QALYs	ICER vs. next best option (£)	ICER vs. BSC (£)
BSC	137,167	5.312	–	–	–	–
UST	140,006	6.334	2840	1.022	2778	2778
300 mg of SEC	163,788	6.632	23,781	0.299	79,576	20,154

TABLE 212 Treatment effects from independent analysis for mild–moderate psoriasis, subpopulation 3: fully incremental cost-effectiveness analysis, HAQ-DI costs from Poole *et al.*¹³⁸

Treatment	Cost (£)	QALYs	Incremental cost (£)	Incremental QALYs	ICER vs. next best option (£)	ICER vs. BSC (£)
BSC	137,167	5.676	–	–	–	–
UST	140,006	6.666	2840	0.989	2870	2870
300 mg of SEC	163,788	6.945	23,781	0.280	85,064	20,981

TABLE 213 Treatment effects from independent analysis for no concomitant psoriasis, subpopulation 3: fully incremental cost-effectiveness analysis, HAQ-DI costs from Poole *et al.*¹³⁸

Treatment	Cost (£)	QALYs	Incremental cost (£)	Incremental QALYs	ICER vs. next best option (£)	ICER vs. BSC (£)
BSC	137,167	6.188	–	–	–	–
UST	140,006	7.132	2840	0.943	3010	3010
300 mg of SEC	163,788	7.384	23,781	0.252	94,184	22,264

Withdrawal scenario 1

TABLE 214 Treatment effects from independent analysis for moderate–severe psoriasis, subpopulation 2: fully incremental cost-effectiveness analysis, withdrawal scenario 1

Treatment	Cost (£)	QALYs	Incremental cost (£)	Incremental QALYs	ICER vs. next best option (£)	ICER vs. BSC (£)
BSC	95,965	5.312	–	–	–	–
CZP	137,240	7.226	Extendedly dominated	–	–	21,560
ADA	138,109	7.411	42,144	2.100	20,074	20,074
GOL	142,850	7.637	4741	0.226	20,976	20,161
ETN	144,585	7.719	1735	0.082	21,215	20,197
300 mg of SEC	172,821	7.835	Dominated	–	–	30,461
INF	167,126	7.890	22,541	0.171	131,716	27,599

TABLE 215 Treatment effects from independent analysis for mild–moderate psoriasis, subpopulation 2: fully incremental cost-effectiveness analysis, withdrawal scenario 1

Treatment	Cost (£)	QALYs	Incremental cost (£)	Incremental QALYs	ICER vs. next best option (£)	ICER vs. BSC (£)
BSC	67,000	5.676	–	–	–	–
CZP	111,856	7.537	Extendedly dominated	–	–	24,107
ADA	114,039	7.708	Extendedly dominated	–	–	23,153
GOL	119,624	7.923	Dominated	–	–	23,418
150 mg of SEC	115,157	7.938	48,157	2.262	21,291	21,291
ETN	119,326	8.025	4169	0.087	47,734	22,274
INF	145,569	8.161	26,243	0.136	193,063	31,616

TABLE 216 Treatment effects from independent analysis for no concomitant psoriasis, subpopulation 2: fully incremental cost-effectiveness analysis, withdrawal scenario 1

Treatment	Cost (£)	QALYs	Incremental cost (£)	Incremental QALYs	ICER vs. next best option (£)	ICER vs. BSC (£)
BSC	51,436	6.188	–	–	–	–
CZP	98,060	7.974	Extendedly dominated	–	–	26,117
ADA	100,893	8.125	Extendedly dominated	–	–	25,542
150 mg of SEC	103,136	8.323	Extendedly dominated	–	–	24,219
GOL	106,895	8.325	Dominated	–	–	25,951
ETN	105,592	8.456	54,156	2.268	23,883	23,883
INF	133,664	8.543	28,071	0.087	324,502	34,930

TABLE 217 Treatment effects from independent analysis for moderate–severe psoriasis, subpopulation 3: fully incremental cost-effectiveness analysis, withdrawal scenario 1

Treatment	Cost (£)	QALYs	Incremental cost (£)	Incremental QALYs	ICER vs. next best option (£)	ICER vs. BSC (£)
BSC	95,965	5.312	–	–	–	–
UST	118,127	6.334	22,162	1.022	21,685	21,685
300 mg of SEC	164,019	7.208	45,892	0.875	52,454	35,876

TABLE 218 Treatment effects from independent analysis for mild–moderate psoriasis, subpopulation 3: fully incremental cost-effectiveness analysis, withdrawal scenario 1

Treatment	Cost (£)	QALYs	Incremental cost (£)	Incremental QALYs	ICER vs. next best option (£)	ICER vs. BSC (£)
BSC	67,000	5.676	–	–	–	–
UST	91,246	6.666	24,246	0.989	24,510	24,510
300 mg of SEC	141,128	7.495	49,881	0.830	60,105	40,749

TABLE 219 Treatment effects from independent analysis for no concomitant psoriasis, subpopulation 3: fully incremental cost-effectiveness analysis, withdrawal scenario 1

Treatment	Cost (£)	QALYs	Incremental cost (£)	Incremental QALYs	ICER vs. next best option (£)	ICER vs. BSC (£)
BSC	51,436	6.188	–	–	–	–
UST	76,712	7.132	25,275	0.943	26,797	26,797
300 mg of SEC	128,564	7.898	51,852	0.767	67,626	45,105

Withdrawal scenario 2

TABLE 220 Treatment effects from independent analysis for moderate–severe psoriasis, subpopulation 2: fully incremental cost-effectiveness analysis, withdrawal scenario 2

Treatment	Cost (£)	QALYs	Incremental cost (£)	Incremental QALYs	ICER vs. next best option (£)	ICER vs. BSC (£)
BSC	95,965	5.312	–	–	–	–
CZP	145,291	7.575	Extendedly dominated	–	–	21,791
300 mg of SEC	168,369	7.761	Dominated	–	–	29,562
ADA	146,695	7.798	Extendedly dominated	–	–	20,406
GOL	152,626	8.069	56,661	2.758	20,545	20,545
ETN	154,686	8.168	2060	0.099	20,827	20,555
INF	180,980	8.375	26,294	0.207	127,152	27,750

TABLE 221 Treatment effects from independent analysis for mild–moderate psoriasis, subpopulation 2: fully incremental cost-effectiveness analysis, withdrawal scenario 2

Treatment	Cost (£)	QALYs	Incremental cost (£)	Incremental QALYs	ICER vs. next best option (£)	ICER vs. BSC (£)
BSC	67,000	5.676	–	–	–	–
CZP	120,762	7.874	Dominated	–	–	24,459
150 mg of SEC	116,558	7.902	49,558	2.226	22,267	22,267
ADA	123,771	8.080	Extendedly dominated	–	–	23,623
GOL	130,746	8.338	Dominated	–	–	23,946
ETN	130,329	8.462	13,771	0.560	24,593	22,734
INF	161,129	8.626	30,800	0.164	187,663	31,911

TABLE 222 Treatment effects from independent analysis for no concomitant psoriasis, subpopulation 2: fully incremental cost-effectiveness analysis, withdrawal scenario 2

Treatment	Cost (£)	QALYs	Incremental cost (£)	Incremental QALYs	ICER vs. next best option (£)	ICER vs. BSC (£)
BSC	51,436	6.188	–	–	–	–
150 mg of SEC	104,305	8.292	Extendedly dominated	–	–	25,138
CZP	107,389	8.294	Extendedly dominated	–	–	26,570
ADA	111,192	8.475	Extendedly dominated	–	–	26,129
GOL	118,682	8.716	Dominated	–	–	26,604
ETN	117,041	8.874	65,605	2.686	24,427	24,427
INF	150,067	8.978	33,026	0.104	316,876	35,352

TABLE 223 Treatment effects from independent analysis for moderate–severe psoriasis, subpopulation 3: fully incremental cost-effectiveness analysis, withdrawal scenario 2

Treatment	Cost (£)	QALYs	Incremental cost (£)	Incremental QALYs	ICER vs. next best option (£)	ICER vs. BSC (£)
BSC	95,965	5.312	–	–	–	–
UST	122,062	6.507	26,098	1.196	21,829	21,829
300 mg of SEC	152,067	6.858	30,004	0.351	85,485	36,276

TABLE 224 Treatment effects from independent analysis for mild–moderate psoriasis, subpopulation 3: fully incremental cost-effectiveness analysis, withdrawal scenario 2

Treatment	Cost (£)	QALYs	Incremental cost (£)	Incremental QALYs	ICER vs. next best option (£)	ICER vs. BSC (£)
BSC	67,000	5.676	–	–	–	–
UST	95,632	6.833	28,631	1.156	24,763	24,763
300 mg of SEC	127,960	7.160	32,328	0.328	98,657	41,081

TABLE 225 Treatment effects from independent analysis for no concomitant psoriasis, subpopulation 3: fully incremental cost-effectiveness analysis, withdrawal scenario 2

Treatment	Cost (£)	QALYs	Incremental cost (£)	Incremental QALYs	ICER vs. next best option (£)	ICER vs. BSC (£)
BSC	51,436	6.188	–	–	–	–
UST	81,319	7.289	29,883	1.101	27,142	27,142
300 mg of SEC	114,795	7.584	33,476	0.295	113,494	45,389

Appendix 14 Quality assessment checklists for published cost-effectiveness models

Checklist for the Rodgers *et al.*³³ model

Study question	Grade	Comments
1. Costs and effects examined	✓	
2. Alternatives compared	✓	
3. The viewpoint(s)/perspective of the analysis is clearly stated (e.g. NHS, society)	✓	
Selection of alternatives		
4. All relevant alternatives are compared (including do-nothing if applicable)	✗	UST, GOL, SEC and CZP not included
5. The alternatives being compared are clearly described (who did what, to whom, where and how often)	✓	
6. The rationale for choosing the alternative programmes or interventions compared is stated	✓	
Form of evaluation		
7. The choice of form of economic evaluation is justified in relation to the questions addressed	✓	
8. If a cost-minimisation design is chosen, have equivalent outcomes been adequately demonstrated?	N/A	
Effectiveness data		
9. The source(s) of effectiveness estimates used are stated (e.g. single study, selection of studies, systematic review, expert opinion)	✓	
10. Effectiveness data from RCT or review of RCTs	✓	
11. Potential biases identified (especially if data not from RCTs)	✓	
12. Details of the method of synthesis or meta-analysis of estimates are given (if based on an overview of a number of effectiveness studies)	✓	WinBUGS code presented
Costs		
13. All the important and relevant resource use included	✓	
14. All the important and relevant resource use measured accurately (with methodology)	✓	
15. Appropriate unit costs estimated (with methodology)	✓	
16. Unit costs reported separately from resource use data	✓	
17. Productivity costs treated separately from other costs	✓	
18. The year and country to which unit costs apply is stated with appropriate adjustments for inflation and/or currency conversion	✓	
Benefit measurement and valuation		
19. The primary outcome measure(s) for the economic evaluation are clearly stated	✓	
20. Methods to value health states and other benefits are stated	✓	
21. Details of the individuals from whom valuations were obtained are given	✓	

Study question	Grade	Comments
Decision modelling		
22. Details of any decision model used are given (e.g. decision tree, Markov model)	✓	
23. The choice of model used and the key input parameters on which it is based are adequately detailed and justified	✓	
24. All model outputs described adequately	✓	
Discounting		
25. Discount rate used for both costs and benefits	✓	
26. Do discount rates accord with NHS guidance?	✓	
Allowance for uncertainty		
<i>Stochastic analysis of patient-level data</i>		
27. Details of statistical tests and CIs are given for stochastic data	N/A	
28. Uncertainty around cost-effectiveness expressed (e.g. CI around ICER, cost-effectiveness acceptability curves)	N/A	
29. Sensitivity analysis used to assess uncertainty in non-stochastic variables (e.g. unit costs, discount rates) and analytic decisions (e.g. methods to handle missing data)	N/A	
<i>Stochastic analysis of decision models</i>		
30. Are all appropriate input parameters included with uncertainty?	✓	
31. Is second-order uncertainty (uncertainty in means) included rather than first order (uncertainty between patients)?	✓	
32. Are the probability distributions adequately detailed and appropriate?	✓	
33. Sensitivity analysis used to assess uncertainty in non-stochastic variables (e.g. unit costs, discount rates) and analytic decisions (e.g. methods to handle missing data)	✓	
Deterministic analysis		
34. The approach to sensitivity analysis is given (e.g. univariate, threshold analysis, etc.)	✓	
35. The choice of variables for sensitivity analysis is justified	✓	
36. The ranges over which the variables are varied are stated	✓	
Presentation of results		
37. Incremental analysis is reported using appropriate decision rules	✓	
38. Major outcomes are presented in a disaggregated as well as aggregated form	✓	
39. Applicable to the NHS setting	✓	
N/A, not applicable.		

Checklist for the golimumab model⁷⁰

Study question	Grade	Comments
1. Costs and effects examined	✓	
2. Alternatives compared	✓	
3. The viewpoint(s)/perspective of the analysis is clearly stated (e.g. NHS, society)	✓	
Selection of alternatives		
4. All relevant alternatives are compared (including do-nothing if applicable)	✗	Biologics compared with palliative care, which is defined as DMARDs Comparators UST, SEC and CZP not included
5. The alternatives being compared are clearly described (who did what, to whom, where and how often)	✗	Does not describe what the series of DMARDs are
6. The rationale for choosing the alternative programmes or interventions compared is stated	✓	
Form of evaluation		
7. The choice of form of economic evaluation is justified in relation to the questions addressed	✓	
8. If a cost-minimisation design is chosen, have equivalent outcomes been adequately demonstrated?	N/A	
Effectiveness data		
9. The source(s) of effectiveness estimates used are stated (e.g. single study, selection of studies, systematic review, expert opinion)	✓	
10. Effectiveness data from RCT or review of RCTs	✓	
11. Potential biases identified (especially if data not from RCTs)	✓	
12. Details of the method of synthesis or meta-analysis of estimates are given (if based on an overview of a number of effectiveness studies)	✓	WinBUGS code presented
Costs		
13. All the important and relevant resource use included	✓	
14. All the important and relevant resource use measured accurately (with methodology)	✓	
15. Appropriate unit costs estimated (with methodology)	✓	
16. Unit costs reported separately from resource use data	✓	
17. Productivity costs treated separately from other costs	N/A	
18. The year and country to which unit costs apply is stated with appropriate adjustments for inflation and/or currency conversion	✓	
Benefit measurement and valuation		
19. The primary outcome measure(s) for the economic evaluation are clearly stated	✓	
20. Methods to value health states and other benefits are stated	✓	
21. Details of the individuals from whom valuations were obtained are given	✓	

Study question	Grade	Comments
Decision modelling		
22. Details of any decision model used are given (e.g. decision tree, Markov model)	✓	
23. The choice of model used and the key input parameters on which it is based are adequately detailed and justified	✓	
24. All model outputs described adequately	✓	
Discounting		
25. Discount rate used for both costs and benefits	✓	
26. Do discount rates accord with NHS guidance?	✓	
Allowance for uncertainty		
<i>Stochastic analysis of patient-level data</i>		
27. Details of statistical tests and CIs are given for stochastic data	N/A	
28. Uncertainty around cost-effectiveness expressed (e.g. CI around ICER, cost-effectiveness acceptability curves)	N/A	
29. Sensitivity analysis used to assess uncertainty in non-stochastic variables (e.g. unit costs, discount rates) and analytic decisions (e.g. methods to handle missing data)	N/A	
<i>Stochastic analysis of decision models</i>		
30. Are all appropriate input parameters included with uncertainty?	✓	
31. Is second-order uncertainty (uncertainty in means) included rather than first order (uncertainty between patients)?	✓	
32. Are the probability distributions adequately detailed and appropriate?	✓	
33. Sensitivity analysis used to assess uncertainty in non-stochastic variables (e.g. unit costs, discount rates) and analytic decisions (e.g. methods to handle missing data)	✓	
Deterministic analysis		
34. The approach to sensitivity analysis is given (e.g. univariate, threshold analysis, etc.)	✓	
35. The choice of variables for sensitivity analysis is justified	✓	
36. The ranges over which the variables are varied are stated	✓	
Presentation of results		
37. Incremental analysis is reported using appropriate decision rules	X	Calculated incorrectly
38. Major outcomes are presented in a disaggregated as well as aggregated form	X	
39. Applicable to the NHS setting	✓	
N/A, not applicable.		

Checklist for the ustekinumab model⁶⁶

Study question	Grade	Comments
1. Costs and effects examined	✓	
2. Alternatives compared	✓	
3. The viewpoint(s)/perspective of the analysis is clearly stated (e.g. NHS, society)	✓	
Selection of alternatives		
4. All relevant alternatives are compared (including do-nothing if applicable)	✗	Conventional management was not specifically defined, but reflects treatment with non-biologics. SEC and CZP not included
5. The alternatives being compared are clearly described (who did what, to whom, where and how often)	✗	Does not describe what the series of DMARDs are
6. The rationale for choosing the alternative programmes or interventions compared is stated	✓	
Form of evaluation		
7. The choice of form of economic evaluation is justified in relation to the questions addressed	✓	
8. If a cost-minimisation design is chosen, have equivalent outcomes been adequately demonstrated?	N/A	
Effectiveness data		
9. The source(s) of effectiveness estimates used are stated (e.g. single study, selection of studies, systematic review, expert opinion)	✓	
10. Effectiveness data from RCT or review of RCTs	✓	
11. Potential biases identified (especially if data not from RCTs)	✓	
12. Details of the method of synthesis or meta-analysis of estimates are given (if based on an overview of a number of effectiveness studies)	✓	WinBUGS code presented
Costs		
13. All the important and relevant resource use included	✓	
14. All the important and relevant resource use measured accurately (with methodology)	✓	
15. Appropriate unit costs estimated (with methodology)	✓	
16. Unit costs reported separately from resource use data	✓	
17. Productivity costs treated separately from other costs	N/A	
18. The year and country to which unit costs apply is stated with appropriate adjustments for inflation and/or currency conversion	✓	
Benefit measurement and valuation		
19. The primary outcome measure(s) for the economic evaluation are clearly stated	✓	
20. Methods to value health states and other benefits are stated	✓	
21. Details of the individuals from whom valuations were obtained are given	✓	

Study question	Grade	Comments
Decision modelling		
22. Details of any decision model used are given (e.g. decision tree, Markov model)	✓	
23. The choice of model used and the key input parameters on which it is based are adequately detailed and justified	✓	
24. All model outputs described adequately	✓	
Discounting		
25. Discount rate used for both costs and benefits	✓	
26. Do discount rates accord with NHS guidance?	✓	
Allowance for uncertainty		
<i>Stochastic analysis of patient-level data</i>		
27. Details of statistical tests and CIs are given for stochastic data	N/A	
28. Uncertainty around cost-effectiveness expressed (e.g. CI around ICER, cost-effectiveness acceptability curves)	N/A	
29. Sensitivity analysis used to assess uncertainty in non-stochastic variables (e.g. unit costs, discount rates) and analytic decisions (e.g. methods to handle missing data)	N/A	
<i>Stochastic analysis of decision models</i>		
30. Are all appropriate input parameters included with uncertainty?	✓	
31. Is second-order uncertainty (uncertainty in means) included rather than first order (uncertainty between patients)?	✓	
32. Are the probability distributions adequately detailed and appropriate?	✓	
33. Sensitivity analysis used to assess uncertainty in non-stochastic variables (e.g. unit costs, discount rates) and analytic decisions (e.g. methods to handle missing data)	✓	
Deterministic analysis		
34. The approach to sensitivity analysis is given (e.g. univariate, threshold analysis, etc.)	✓	
35. The choice of variables for sensitivity analysis is justified	✓	
36. The ranges over which the variables are varied are stated	✓	
Presentation of results		
37. Incremental analysis is reported using appropriate decision rules	✓	
38. Major outcomes are presented in a disaggregated as well as aggregated form	✓	
39. Applicable to the NHS setting	✓	
N/A, not applicable.		

Checklist for the Cawson *et al.*³⁶ model

Study question	Grade	Comments
1. Costs and effects examined	✓	
2. Alternatives compared	✓	
3. The viewpoint(s)/perspective of the analysis is clearly stated (e.g. NHS, society)	✓	
Selection of alternatives		
4. All relevant alternatives are compared (including do-nothing if applicable)	✗	Conventional management was not specifically defined, but reflects treatment with non-biologics. SEC and CZP not included
5. The alternatives being compared are clearly described (who did what, to whom, where and how often)	✗	Does not describe what the series of DMARDs are
6. The rationale for choosing the alternative programmes or interventions compared is stated	✓	
Form of evaluation		
7. The choice of form of economic evaluation is justified in relation to the questions addressed	✓	
8. If a cost-minimisation design is chosen, have equivalent outcomes been adequately demonstrated?	N/A	
Effectiveness data		
9. The source(s) of effectiveness estimates used are stated (e.g. single study, selection of studies, systematic review, expert opinion)	✓	
10. Effectiveness data from RCT or review of RCTs	✓	
11. Potential biases identified (especially if data not from RCTs)	✓	
12. Details of the method of synthesis or meta-analysis of estimates are given (if based on an overview of a number of effectiveness studies)	✓	WinBUGS code presented
Costs		
13. All the important and relevant resource use included	✓	
14. All the important and relevant resource use measured accurately (with methodology)	✓	
15. Appropriate unit costs estimated (with methodology)	✓	
16. Unit costs reported separately from resource use data	✓	
17. Productivity costs treated separately from other costs	N/A	
18. The year and country to which unit costs apply is stated with appropriate adjustments for inflation and/or currency conversion	✓	
Benefit measurement and valuation		
19. The primary outcome measure(s) for the economic evaluation are clearly stated	✓	
20. Methods to value health states and other benefits are stated	✓	
21. Details of the individuals from whom valuations were obtained are given	✓	

Study question	Grade	Comments
Decision modelling		
22. Details of any decision model used are given (e.g. decision tree, Markov model)	✓	
23. The choice of model used and the key input parameters on which it is based are adequately detailed and justified	✓	
24. All model outputs described adequately	✓	
Discounting		
25. Discount rate used for both costs and benefits	✓	
26. Do discount rates accord with NHS guidance?	✓	
Allowance for uncertainty		
<i>Stochastic analysis of patient-level data</i>		
27. Details of statistical tests and CIs are given for stochastic data	N/A	
28. Uncertainty around cost-effectiveness expressed (e.g. CI around ICER, cost-effectiveness acceptability curves)	N/A	
29. Sensitivity analysis used to assess uncertainty in non-stochastic variables (e.g. unit costs, discount rates) and analytic decisions (e.g. methods to handle missing data)	N/A	
<i>Stochastic analysis of decision models</i>		
30. Are all appropriate input parameters included with uncertainty?	✓	
31. Is second-order uncertainty (uncertainty in means) included rather than first order (uncertainty between patients)?	✓	
32. Are the probability distributions adequately detailed and appropriate?	✓	
33. Sensitivity analysis used to assess uncertainty in non-stochastic variables (e.g. unit costs, discount rates) and analytic decisions (e.g. methods to handle missing data)	✓	
Deterministic analysis		
34. The approach to sensitivity analysis is given (e.g. univariate, threshold analysis, etc.)	✓	
35. The choice of variables for sensitivity analysis is justified	✓	
36. The ranges over which the variables are varied are stated	✓	
Presentation of results		
37. Incremental analysis is reported using appropriate decision rules	✓	
38. Major outcomes are presented in a disaggregated as well as aggregated form	✓	
39. Applicable to the NHS setting	✓	
N/A, not applicable.		

A decorative graphic consisting of numerous thin, parallel green lines that curve from the left side of the page towards the right, creating a sense of movement and depth.

**EME
HS&DR
HTA
PGfAR
PHR**

Part of the NIHR Journals Library
www.journalslibrary.nihr.ac.uk

This report presents independent research funded by the National Institute for Health Research (NIHR). The views expressed are those of the author(s) and not necessarily those of the NHS, the NIHR or the Department of Health

Published by the NIHR Journals Library