

Microwave-assisted pyrolysis with chemical activation, an innovative method to convert orange peel into activated carbon with improved properties as dye adsorbent

Su Shiung Lam ^{a,d*}, Rock Keey Liew ^a, Yee Mun Wong ^a, Nai Yuh Peter Yek ^{a,b}, Nyuk Ling Ma^c, Chern Leing Lee^d, Howard A. Chase ^e

^a Pyrolysis Technology Research Group, Eastern Corridor Renewable Energy Group, School of Ocean Engineering, Universiti Malaysia Terengganu, 21030 Kuala Nerus, Terengganu, Malaysia.

^b School of Engineering and Technology, University College of Technology Sarawak, Lot 88, Persiaran Brooke, 96000 Sibu, Sarawak.

^c School of Fundamental Science, Universiti Malaysia Terengganu, 21030 Kuala Nerus, Terengganu, Malaysia.

^d Chemical Engineering Discipline, School of Engineering, Monash University Malaysia, Jalan Lagoon Selatan, Bandar Sunway, 47500, Selangor, Malaysia.

^e Department of Chemical Engineering and Biotechnology, University of Cambridge, New Museums Site, Pembroke Street, Cambridge CB2 3RA, United Kingdom.

lam@umt.edu.my, lrklrk1991@gmail.com, emunwong92@gmail.com,
peter.yek@ucts.edu.my, nyukling@umt.edu.my, lee.chernleing@monash.edu,
hac1000@cam.ac.uk

* Corresponding author. Tel: +609 6683844; fax: +609 6683991; Email address: lam@umt.edu.my, sushiong@gmail.com (S.S. Lam); Postal address: Pyrolysis Technology Research Group, Eastern Corridor Renewable Energy Group, School of Ocean Engineering, Universiti Malaysia Terengganu, 21030 Kuala Terengganu, Terengganu, Malaysia.

Abstract

Microwave-assisted pyrolysis with chemical activation was developed and optimized to transform orange peel into activated carbon (AC) desirable for use as a dye adsorbent. The orange peel was first carbonized via microwave-assisted pyrolysis to produce a biochar, which was then activated and converted into AC via chemical impregnation coupled with microwave-assisted pyrolysis. The process parameters involved was optimized to maximize the yield of AC and its adsorption efficiency on malachite green dye using response surface methodology adopting central composite design. The use of microwave-assisted pyrolysis provided a fast heating rate and short process time in converting orange peel into AC, recording a heating rate of up to 112 °C/min in a process taking about 25 min, representing a method that is potentially faster and more energy efficient compared to that shown by the method commonly performed using conventional heating source (≥ 1 hour). The results showed that AC with the highest yield (87 wt% of biochar) and optimal adsorption efficiency (28.5 mg of dye / g of AC) can be obtained by performing chemical impregnation at an impregnation ratio of 1:1 coupled with microwave-assisted pyrolysis under microwave irradiation (heating) for 5 min using 550 W of microwave power. The addition of chemical activation with alkali metal hydroxides resulted in the production of AC with improved properties. The AC showed a highly porous structure containing high content of fixed carbon (83 wt%) and high BET surface area (1350 m²/g). The adsorption–desorption isotherm showed a combination of Type I and Type II isotherms, which indicates the presence of microporous-mesoporous structure, thus exhibiting a characteristic of improved pores accessibility and high adsorption capacity. Combined with the detection of low ash (3.2 wt%) and moisture content (5 wt%), the AC shows great promise as a high-grade dye adsorbent with high adsorption capacity and potentially increased durability since a low moisture content could increase the rate of adsorption of dye contaminants and a high ash content could promote undesirable catalytic reactions and reduce the adsorption capacity and

reactivation efficiency of AC. The recovery of AC with improved properties and the desirable process features (fast heating rate, short process time) suggest the great potential of this method as an alternative for the treatment and recovery of fruit peel.

Keywords: Microwave; pyrolysis; activated carbon; optimization; response surface methodology; adsorbent

1. Introduction

Orange represents a fruit with high market demand in the world (Boukroufa et al., 2015). There were approximately 100 metric tons of oranges being imported into Malaysia in 2015 to fulfill the demand by the consumers and the fruit processing industries. Consequently, a large amount of orange peel has been discarded and dumped to the landfill sites. This results in the release of greenhouse gases (e.g. CH₄, CO₂) that promotes global warming when the orange peel undergoes decomposition over time by bacteria in the landfill sites (Lam et al., 2016b; Lou and Nair, 2009). Hence, efforts should be made to reuse or transform orange peel into potentially useful product such as activated carbon instead of simply being disposed by landfilling that can bring negative impact to the environment.

Activated carbon (AC) is a highly porous material that shows excellent performance in adsorption process (Demiral and Güngör, 2016). It is widely applied in industry for separation of heavy metal, dyes, and organic residues from water and waste water (Bhatnagar et al., 2013; Kundu et al., 2015a). It also demonstrates great promise as a catalyst support and heating medium in thermochemical applications (Lam et al., 2016c; Lam et al., 2016d). The production of AC involves 2 processes - carbonization and activation. These processes are performed separately where the feedstock (a biomass or waste material) is first heated and pyrolyzed in a reactor at a high temperature (400 – 700 °C) in order to be carbonized to produce a char product,

then the char is transferred to another reactor in which physical or chemical activation is performed to increase its porosity by heating and pyrolysis at a high temperature ranging between 400 °C and 900 °C (Saygılı et al., 2015). Alternatively, carbonization and activation are performed simultaneously in a one-step approach (Kundu et al., 2015a).

However, both carbonization and activation are commonly performed via pyrolysis using conventional heating sources such as electrical oven or furnace, which usually requires long process time (1 – 7 hours) (Baccar et al., 2009; Dural et al., 2011; Tay et al., 2009) and high process temperature (up to 700 °C) (Ahmad and Alrozi, 2010; Garba and Rahim, 2014), resulting in high energy usage and increased production cost. In conventional electric-heated pyrolysis, heat is transferred mainly to the material being heated by conduction and convection mechanisms. This type of heat transfer could be slow and energy inefficient because the heat needs to be transferred from the heating elements (e.g. heating mantle or coil) to the furnace chamber, and then to the heat conductor (e.g. the gas present inside the furnace cavity) before it is finally received by the surface of the material being heated. This also results in significant energy loss and thus more time and energy are required to heat the material to the target temperature for pyrolysis to occur.

Microwave-assisted pyrolysis shows potential as an alternative to overcome the limitations shown by pyrolysis using conventional oven or furnace as the heat source. The use of microwave as a heat source is well known for its ability to provide fast and selective heating mechanism (Lam et al., 2015; Wan Mahari et al., 2016). When microwave radiation is applied to a material being heated, the resulting microwave energy can induce dipole rotation in atomic scale over a million times per second (Njoku et al., 2014). This creates a frictional force between atoms and molecules within the material and in turn generates heat rapidly within the whole volume of the material, hence showing ability to generate a rapid and ‘volumetric’ heating to heat the material in bulk (Lei et al., 2009; Russell et al., 2012).

Furthermore, the microwave energy is targeted only to microwave receptive materials (e.g. carbon-based material) and not to gases within the heating chamber or the chamber itself (Lam et al., 2016a). This could generate micro-plasma spots throughout the material being heated (Menéndez et al., 2007) and promote certain chemical reactions in a way that is not possible in conventional processing by selectively heating the reactants and initiating extensive pyrolysis cracking at a significantly lower process temperature (Lam et al., 2015). Other advantages shown by microwave-assisted pyrolysis compared with conventional electric-heated pyrolysis techniques include better process control in terms of quick start-up and shutdown, a more uniform heat distribution, increased production speeds and decreased production costs (Kundu et al., 2015a; Lam et al., 2017; Menéndez et al., 2004). It is thus thought that the application of microwave-assisted pyrolysis in the production of AC could show favorable features that could lead to an energy-efficient heating process, savings in process time, and improved yield of desirable products.

Despite the advantages shown by microwave pyrolysis, the growth of industrial microwave pyrolysis applications is hampered by an apparent lack of the understanding of microwave systems, the influence of key process parameters on the desired product, and the technical information for designing commercial equipment for these pyrolysis applications. In addition, microwave radiation presents an additional hazard over traditional heating methods, although this is easily contained within an appropriate Faraday cage. Moreover, using microwaves places limits on which materials can be used in the construction of a reactor and its design. These limitations present difficulties for microwave pyrolysis processes to be scaled up and optimized.

Chemical activation is performed to increase the porosity of AC via impregnation with chemicals followed by pyrolysis at a high temperature. It shows potential as a method that can be performed at a lower process temperature (> 450 °C) than that reported by physical

activation ($> 700\text{ }^{\circ}\text{C}$) (Mahapatra et al., 2012), and has been reported to produce AC with increased surface porosity and less cracked surface (Al-Qodah and Shawabkah, 2009; Williams and Reed, 2006). Chemicals such as H_3PO_4 , ZnCl_2 , NaOH and KOH have been tested for their potential to either weaken or break down the chemical bonds between the lignocellulosic components present in the biomass used as the feedstock to produce AC (Chen, 2005; Jin et al., 2013). This enables the lignocellulosic components to be easily removed and transformed into volatiles (e.g. CO_2 and CH_4) during the subsequent treatment by pyrolysis and which in turn increases the formation of pores on the surface of the resulting AC generated as the solid product (Saygılı and Güzel, 2016). In particular, alkali metal hydroxides (e.g. KOH , NaOH) have been reported to show ability to enhance pore formation via an intercalation effect caused by interaction of K and Na atom with the carbon structure of the AC (Giraldo and Moreno-Piraján, 2012; Musa et al., 2015; Raymundo-Pinero et al., 2005). It was thus hypothesized that chemical activation with alkali metal hydroxides could lead to production of AC with improved properties with respect to increased porosity and the resulting surface area.

The findings above provide the motivation for this study, which is to investigate the use of an innovative method incorporating microwave-assisted pyrolysis and chemical activation with alkali metal hydroxides to produce AC from orange peel. The method was examined for its performance over a range of process parameters (i.e. microwave power, microwave irradiation time and chemical impregnation ratio) with emphasis on the process features, the yield and composition of the AC obtained, and its adsorption of malachite green (a common dye that produces the wastewater in textile industry). This was followed by optimization of the process parameters using response surface methodology (RSM) adopting central composite design (CCD) to maximize the yield of AC with optimal adsorption efficiency on malachite green dye. These evaluations are important to assess the feasibility of developing an improved method that is energy-efficient and requires a shorter process time to recycle orange peel, while

simultaneously producing a higher yield of AC with better quality and which can be use as dye adsorbent to treat wastewater in textile industry. To the best of author's knowledge, there has yet to be any studies reported in the literature on the application of the proposed method to produce AC from orange peel.

2. Materials and methods

2.1. Pre-treatment and preparation of materials

Orange peel was collected from a local café in Kuala Terengganu, Malaysia. The peels were washed with tap water to remove dirt and dried in oven at 110 °C for 24 hours. The dried peels were crushed into small pieces with a diameter of ≤ 3 cm, then they were stored in glass bottles before being subjected to microwave-chemical activation.

A chemical solution formulated from alkali metal hydroxides was prepared for chemical impregnation by dissolving potassium and sodium hydroxides at a weight ratio of 1:1 in distilled water. *Malachite green (MG)* dye (*Bendosen* Laboratory Chemicals, Malaysia) was used as adsorbate to test the adsorption efficiency of the activated carbon (AC). A 1 mg/ml of MG stock solution was prepared and this was followed by preparation of a series of the dye solutions at different diluted concentrations (0 – only distilled water, 0.2, 0.4, 0.6, 0.8 and 1 mg/ml) using distilled water to produce a standard curve for determination of the concentration of dye solution after treatment by AC.

2.2. Procedures on microwave-assisted pyrolysis with chemical activation

A two-step approach comprising carbonization and chemical activation was performed incorporating microwave-assisted pyrolysis to produce AC. The use of two-step approach has been reported to produce AC with a higher surface area compared to the use of one-step approach (i.e. carbonization and activation are performed simultaneously) (Nasri et al., 2014a;

Nasri et al., 2014b). Fig. 1 demonstrates the schematic diagram of the microwave-assisted pyrolysis apparatus. A microwave oven with a frequency of 2.45 GHz (model: Panasonic) was modified and used to generate the microwave radiation required as a heating source to perform the pyrolysis process. A modified 1 L quartz reactor was used as the pyrolysis reactor. The pyrolysis temperature was monitored using a Type-K thermocouple that is in direct contact with the feedstock in the reactor during the pyrolysis experiment. The temperature measured using thermocouple was also validated with the use of an infrared thermometer, and the results of validation showed good precision with low standard deviations shown in the recorded temperature ($\pm 1-3$ °C). N₂ purge-gas was flowed through the reactor to maintain an inert atmosphere.

Carbonization was first performed via microwave-assisted pyrolysis to convert orange peel into a biochar product. 15 g of orange peel were measured and added into the pyrolysis reactor, which was then inserted into the microwave oven. Then, the microwave oven was turned on for 20 min at 700 W of microwave power to heat, pyrolyze, and in turn carbonize the orange peel under a N₂ flow of 0.25 L/min. The temperature versus time profile of the orange peel was monitored as an indication of its heating characteristic during the heating and pyrolysis process. A yield of about 30 wt% was obtained for the biochar, which was collected and further subjected to chemical activation for conversion into activated carbon.

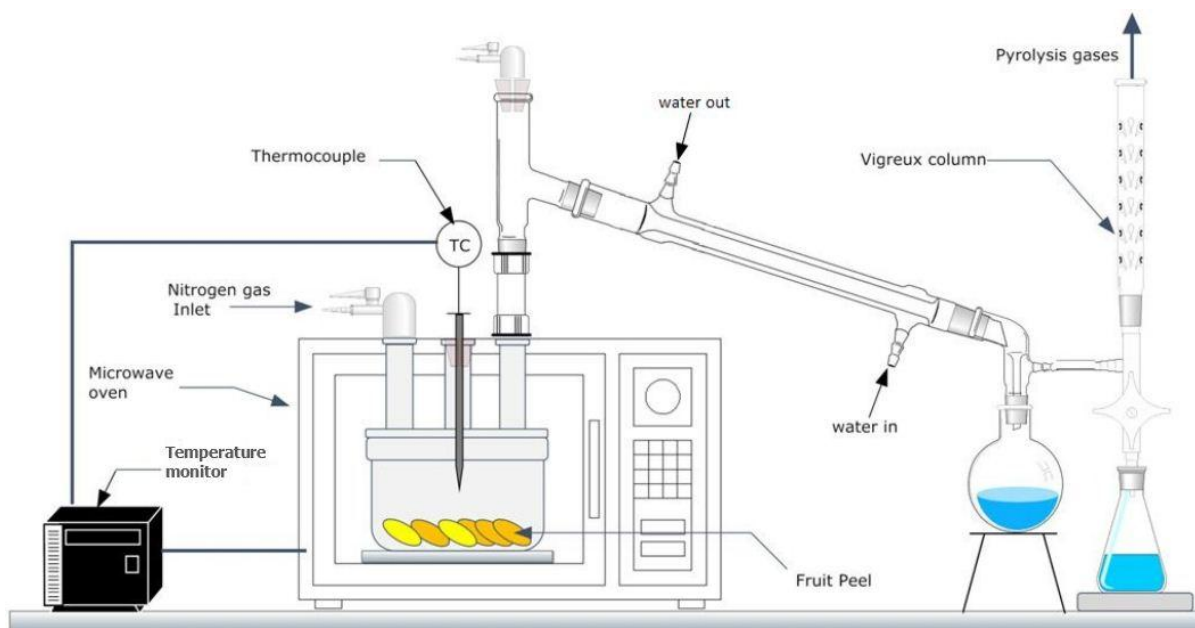

Fig. 1. The schematic diagram of the microwave-assisted pyrolysis apparatus.

Chemical activation was then initiated with chemical impregnation as the first step, which was performed by soaking the biochar in the prepared alkali metal hydroxides solutions for 24 hours. The influence of chemical impregnation was examined over a range of impregnation ratio (i.e. weight of biochar : weight of chemicals) ranging from 1:1 to 1:3. The biochar was then separated from the chemical solution and then subjected to microwave-assisted pyrolysis for conversion into AC. The microwave-assisted pyrolysis at this stage was examined over a range of microwave power (300 – 700 W) and microwave irradiation time (5 – 15 minutes) in order for comparison to made with the relevant literature (Junior et al., 2014). The temperature versus time profile continued to be monitored during the microwave pyrolysis of the biochar. This allows an examination of the heating characteristic that can lead to estimation of the heating rate and the total process time achieved by the whole pyrolysis operation. The resulting AC was immersed in 0.1 M of HCl and then washed with hot distilled water to remove the chemical residues remained within the AC. The AC was dried with an

oven at 110 °C for 24 hours and stored inside a sample vial. The experiments were repeated for three times to ensure good reproducibility of the data.

The yield of AC was calculated using Equation 1 (Mohammed et al., 2015).

$$Yield (wt\%) = \frac{W_f}{W_i} \times 100 \quad (1)$$

W_f is the weight of AC produced (g) and W_i is the weight of biochar (g). The calculation was based on the weight of biochar used because the focus of this study was to optimize the process parameters involved in maximizing the yield of AC from the biochar originally derived from the orange peel.

2.3. Characterization of activated carbon

The AC produced from orange peel biochar was analysed for their content of carbon (C), hydrogen (H), nitrogen (N), and sulphur (S) using a FlashEA 1112 CHNS elemental analyser, whereas the content of oxygen (O) was calculated by difference (Jamaluddin et al., 2013). The proximate content of moisture and volatile matter were determined via a Mettler Toledo TGA under pyrolysis (N_2) environments by heating the AC from ambient temperature to 900 °C at a heating rate of 10 °C/min and with a N_2 flow rate of 25 ml/min. The ash content was determined by combustion of the AC in a muffle furnace at 950 °C with a holding time of 10 minutes. The fixed carbon content was estimated by subtracting the contents of moisture, volatile matter and ash from the original mass of the sample (Azua et al., 2013). The AC was also analysed using a JEOL JSM-6360LA scanning electron microscope (SEM) to examine their surface morphology. The porous characteristics of the AC (i.e. surface area, pore width, and total pore volume) were analysed using a Micrometric ASAP 2020 automatic sorption analyser; the description of this method is presented in Appendix A.

2.4. Adsorption of malachite green by activated carbon

A lab-scale batch adsorption test was performed using the method adapted and modified from Ghaedi et al. (2016). 10 ml of MG with a concentration of 1 mg/ml was prepared as adsorbate and inserted into 17 test tubes, respectively. Batch tests were then performed by adding 200 mg of AC into each test tubes to examine its efficiency to absorb MG. The test tubes were vortexed at 2000 rpm using Vortex Mixer at room temperature for 3 min. It had been ascertained from trial experiments that the change of colour of the mixture, which indicated the initiation of the adsorption of MG by AC, started in about 1 min and no further change of colour was observed after 2 min, thus a contact time of 3 min was selected to allow the adsorption process to be completed. The remaining concentration (mg/ml) of MG after adsorption by AC was determined using Shimadzu UV-1800 UV-Vis spectrophotometer at a wavelength of 617 nm. Adsorption efficiency (mg/g) of AC was calculated using Equation 2.

$$A_e = \frac{[(C_o - C_f) \times V]}{m_{ac}} \quad (2)$$

Where A_e = adsorption efficiency of AC; C_o = initial concentration of MG solution; C_f = final concentration of MG solution; V = volume of MG solution; m_{ac} = mass of AC used.

2.5. Design and optimization of process parameters via response surface methodology (RSM)

Response surface methodology (RSM) is a robust statistical tool that can evaluate and estimate the optimum process parameters based on the experimental data obtained over a range of process parameters considered (Huang et al., 2015). In this study, RSM was used to estimate the optimal parameters required to maximize the yield of AC with optimal adsorption efficiency on MG dye. This was performed along with the use of Central Composite Design (CCD) in designing the experiments for the three process parameters involved in the production of AC via microwave assisted pyrolysis combined with chemical activation, namely

microwave power (A), microwave irradiation time (B) and chemical impregnation ratio (C). In addition, the yield of AC (Y_1) and the adsorption value of malachite green (Y_2) were selected as the responding factors from the AC produced.

“Minitab 16” software was used to process the CCD approach and conduct regression analysis on the experimental outcomes (Mohammed et al., 2015a). Table 1 summarizes the three process parameters with their respective ranges chosen. Equation 3 shows the formula to calculate the total number of runs required, where n is the number of process parameters used. A face-centered CCD consisting of eight factorial points, six axial points and three replicates at centre points with a total number of 17 experiments was employed to formulate the optimum process condition from the three process parameters. The use of triplicate experiment at centre point is to ensure the reproducibility of the data and to determine the experimental error (Auta and Hameed, 2011; Kundu et al., 2015a).

$$N = 2^n + 2n + n_c \quad (3)$$

Table 1: Process parameters and their coded levels for face-centred CCD.

Variables/parameters	Code	Units	Coded Variable Levels		
			-1	0	1
Microwave power	A	Watt (W)	300	500	700
Microwave Irradiation Time	B	Minutes (min)	5	10	15
Chemical impregnation ratio	C	-	1:1	1:2	1:3

Face-centered CCD was chosen compared to other types of CCDs (e.g. central composite circumscribed (CCC) and central composite inscribed (CCI)) because it required only three level of settings for each parameter whereas both CCC and CCI would require five level of settings for each parameter. Face-centered CCD was selected with considerations that

it is a simpler design to perform and could reduce the prediction error compared to the use of CCC and CCI, which deal with more level of settings that could lead to the risk of having higher possibility of errors associated with setup and operation (Zhang and Xiaofeng, 2009). Therefore, the prediction of optimal process parameters is likely to be more precise compared to the use of CCC and CCI. The combinations of the process parameters suggested by the Minitab 16 software associated with the responses for each run was shown in appendix (Table A.1).

The data of responses (i.e. yield of AC and its adsorption efficiency on MG dye) were used to develop a quadratic model correlated to the process parameters using Equation 4.

$$Y = b_o + \sum_{i=1}^n b_i x_i + \left(\sum_{i=1}^n b_{ii} x_i^2 \right) + \sum_{i=1}^{n-1} \sum_{j=i+1}^n b_{ij} x_i x_j \quad (4)$$

where Y = predicted response; b_o = constant coefficient; b_i = linear coefficient; b_{ij} = interaction coefficient; b_{ii} = quadratic coefficient; x_i, x_j = coded value of process parameters.

3. Results and Discussion

3.1 Temperature profile and heating performance during carbonization and chemical activation by microwave-assisted pyrolysis

Figure 2 shows the temperature profile during carbonization and chemical activation by microwave-assisted pyrolysis. The data presented show typical results for the temperature profile obtained in experiments performed under optimized process parameters with low standard deviations shown in the temperature reading ($\pm 1-6$ °C) for each reference point; the results on the optimized process parameters are presented and discussed in Section 3.2.4. It should be noted that the temperature profile is limited to the particular configuration of the microwave-assisted pyrolysis system used in the experimental apparatus developed for this investigation.

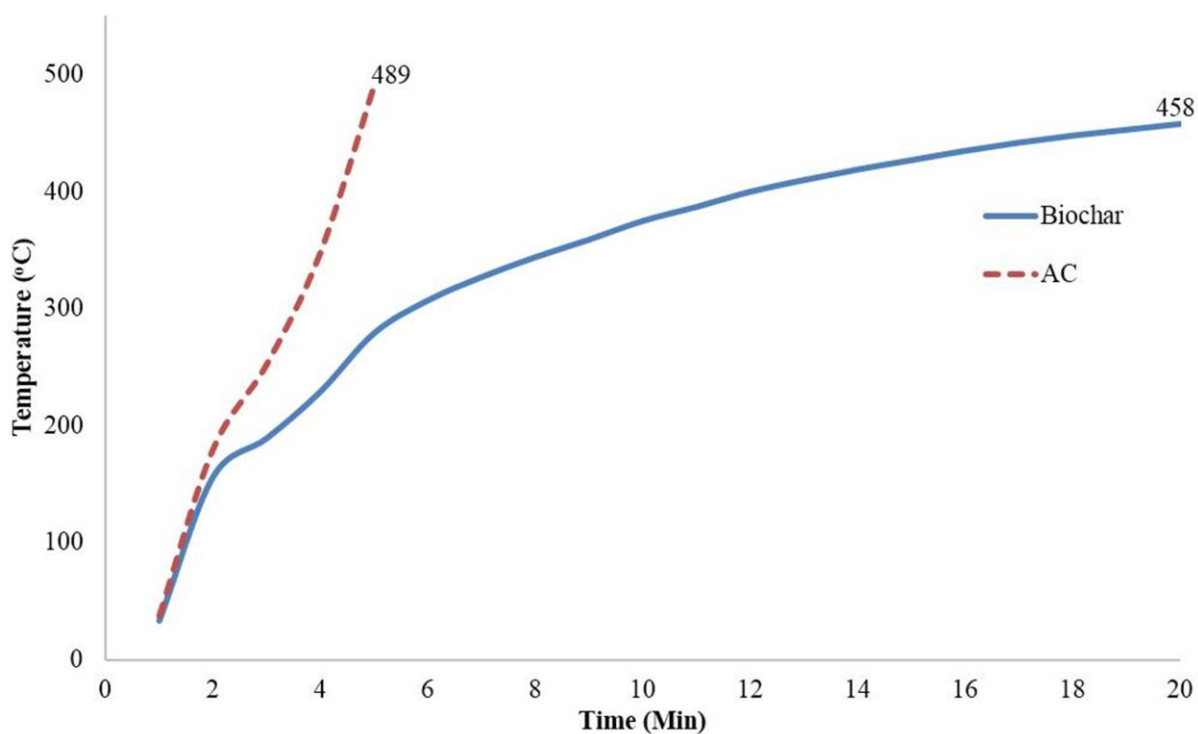

Fig. 2. Temperature profiles during carbonization and chemical activation by microwave-assisted pyrolysis at optimized process parameters.

The use of microwave-assisted pyrolysis provided a fast heating process to convert orange peel into AC, recording a heating rate of 22 °C/min for carbonization and an even higher heating rate of 112 °C/min for chemical activation, both of which higher than the heating rate reported by that performed by pyrolysis using conventional oven or furnace as the heat source (5 – 10 °C/min) (Le Van and Thi, 2014; Saygılı et al., 2015). This resulted in a short process time required for both carbonization and chemical activation, which were completed in approximately 25 min. In contrast, a much longer process time (1 – 7 hours) was reported for production of AC via pyrolysis using conventional heating sources (Baccar et al., 2009; Dural et al., 2011; Saygılı and Güzel, 2016; Tay et al., 2009)

The fast heating rate and short process time corroborates the beneficial role of microwave heating in providing a rapid heating mechanism. In particular, the high heating rate recorded for chemical activation can be explained by the high microwave absorbency of the

biochar that was subjected to chemical activation for conversion into AC. The biochar, being a carbonaceous material with a high carbon content (73.7 wt%, Table 3), is considered as a good microwave receptor with high capability in absorbing and converting microwave energy into thermal energy (Lam et al., 2016d). Thus, it can be rapidly heated to high temperature by microwave radiation, hence accounting for the high heating rate. Overall, the fast heating rate and short process time achieved by microwave-assisted pyrolysis represent favorable features in developing a potentially faster and energy efficient method to produce AC.

It is also worth to mention that a lower process temperature ($< 500\text{ }^{\circ}\text{C}$) was achieved compared to the recent studies reported on the production of AC ($\leq 750\text{ }^{\circ}\text{C}$) (Meryemoglu et al., 2016; Selvaraju and Bakar, 2017). The low process temperature could be attributed to the fast heating rate and selective heating mechanism shown by microwave heating, which can generate heat rapidly within the volume of the material being heated (orange peel, biochar), creating a 'volumetric' heating effect to heat the material in bulk. This in turn created a localized reaction hot zone (Lam et al., 2016d; Wan Mahari et al., 2016) that was likely to have promoted the carbonization reaction to convert orange peel into biochar, and also the cracking reactions during chemical activation that enhanced the removal of the volatile matters from the biochar in order for increased pores development within the resulting AC.

3.2. Yield of AC and its adsorption efficiency

3.2.1 Development of quadratic model for AC yield and adsorption efficiency

The quadratic models for AC yield (Y_1) and adsorption efficiency (Y_2) are shown by Equation (5) and (6) as below:

$$Y_1 = 76.6 - 3.6A - 4.5B - 3.2C - 3.8A^2 - 2.4B^2 - 2.1C^2 - 5.3AB - 0.3AC + 3.3BC \quad (5)$$

$$Y_2 = 23.0 - 3.5A - 1.3B - 2.9C - 1.8A^2 + 0.1B^2 - 0.8C^2 - 4.0AB - 3.2AC + 0.1BC \quad (6)$$

The R^2 values obtained were 0.81 and 0.93, respectively, indicating that 81% and 93% of the total variation were attributed to the process parameters studied. The standard deviation for both the quadratic models was recorded at 3.516 and 1.485, respectively. Overall, high R^2 value and low standard deviation were obtained by the quadratic models, indicating their reliability to correlate the experimental data obtained for AC yield and adsorption efficiency. It was found that AC showed a yield ranging from 56 to 87 wt% and its adsorption efficiency was found to be ranging from 7.8 mg/g to 30.2 mg/g (See appendix – Table A.1).

The normality tests of the residuals derived from AC yield and adsorption efficiency are shown in the appendix (Figure A.1). The p-value obtained from the plots were >0.05 , indicating that both the residuals followed a normal distribution pattern where the plots were located near to the regression line. Combined with the mean value that can be assumed as zero and the standard deviation value that is almost close to 1 from both plots, this indicates that the experimental data obtained were representable and significant.

3.2.2 Effect of two process parameters on AC yield

Fig. 3 shows the surface plots for the effects of two different process parameters on the AC yield. The AC yield is an important parameter to assess the technical feasibility of both the microwave-chemical activation approach and the product itself. In general, the yield of AC decreased with increasing level of the process parameters. Similar trend was reported in other literatures (Kundu et al., 2015b; Xin-Hui et al., 2011).

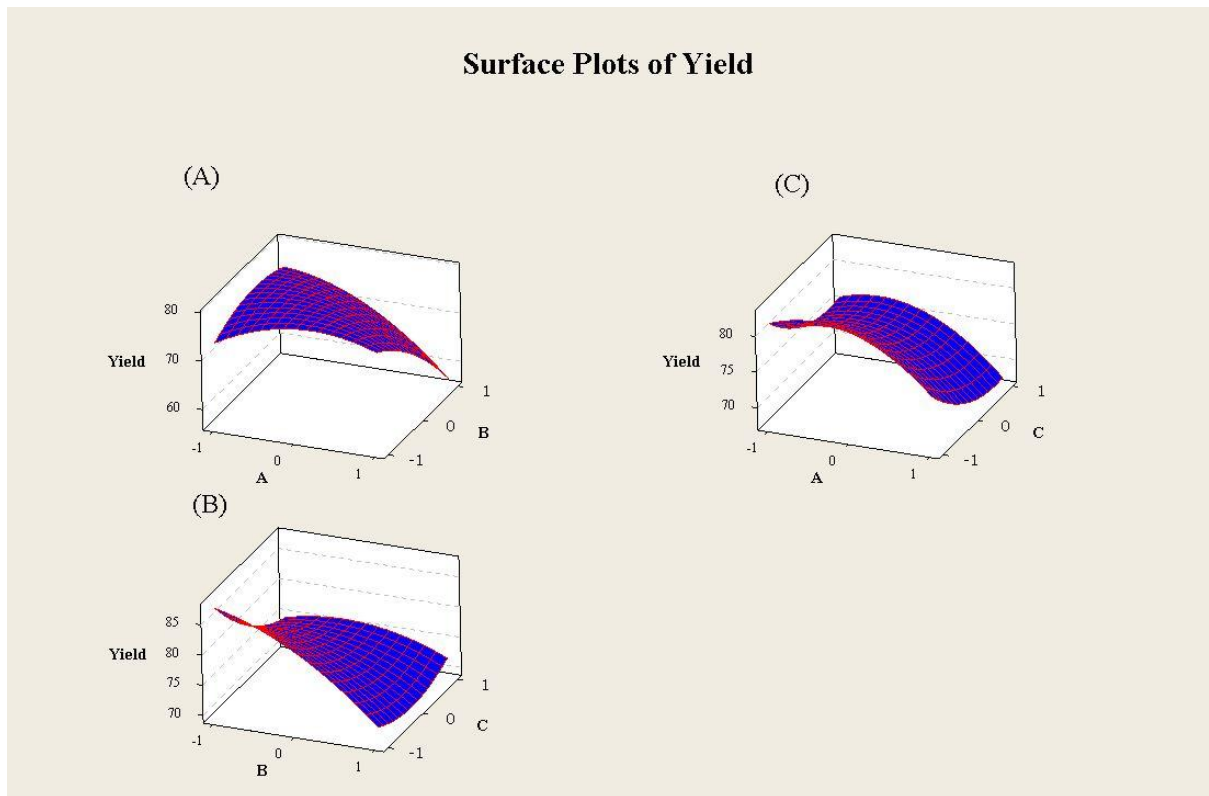

Fig. 3. The surface plots of two process parameters on AC yield. Coded variables **(-1, 0, 1)** for A (microwave power) = 300W, 500W, 700W; B (microwave irradiation time) = 5mins, 10mins, 15mins; C (chemical impregnation ratio = 1:1, 1:2, 1:3).

3.2.2.1 Effect of microwave power and microwave irradiation time

It was observed from Fig. 3(A) that the highest AC yield was obtained at a low microwave power (300W) and a short irradiation time (5 min). This suggests that both the microwave power and the irradiation time were insufficient to heat the biochar (originally derived from orange peel) to achieve the desired temperature in order for extensive thermal activation to occur and remove the volatile components from the biochar. As a result, some volatile components were remained within the biochar that was then transformed into AC, and hence producing an AC with a higher yield.

In contrast, the lowest yield of AC was recorded at high microwave power and irradiation time. The use of high microwave power coupled with a long exposure to microwave

irradiation were likely to have provided a higher thermal energy that promoted the decomposition and conversion of biochar to produce more volatiles, and thus reducing the weight of the biochar that was subsequently transformed into AC; this explains the lower yield of AC.

3.2.2.2 Effect of microwave irradiation time and chemical impregnation ratio

Fig. 3(B) shows the interaction effect between microwave irradiation time and chemical impregnation ratio on the AC yield. It was observed that the yield of AC shows no significant changes when chemical impregnation ratio is increased from 1 to 3, indicating that a low chemical impregnation ratio can be adopted to produce similar amount of AC. In contrast, the yield of AC was found to increase from 70 to 85 wt% when the microwave irradiation time was decreased from 15 to 5 mins, suggesting microwave irradiation time could be a more dominant factor to be considered than chemical impregnation ratio in producing high yield of AC. The inverse relation of microwave irradiation time to the AC yield could be explained by the increased extent of decomposition caused by a longer exposure to microwave radiation (heating) (Xin-Hui et al., 2011). Hence, more volatile matter was released from the biochar that was subsequently transformed into AC, leading to the lower yield of AC.

3.2.2.3 Effect of microwave power and chemical impregnation ratio

Fig. 3(C) shows that the increase of the chemical impregnation ratio at high microwave power (700 W) had led to a reduction in the yield of AC. This indicates that the use of a higher volume of alkali metal hydroxides solution to soak or impregnate the biochar had an effect on aiding the removal of volatile components from the biochar during the subsequent thermal activation under high microwave power condition. The higher volume of the prepared hydroxides solutions, coupled with the higher thermal energy provided by the higher

microwave power, were likely to have facilitated the decomposition of the lignocellulose components (e.g. lignin) in the biochar to produce more volatile matters, resulting in the lower conversion of biochar into AC.

3.2.3. Effect of two process parameters on the adsorption of malachite green

Fig. 4 shows the surface plots produced from the interactive effect of two process parameters on the adsorption of malachite green by AC. The adsorption efficiency of AC is an important parameter to examine its suitability to be used as an adsorbent material.

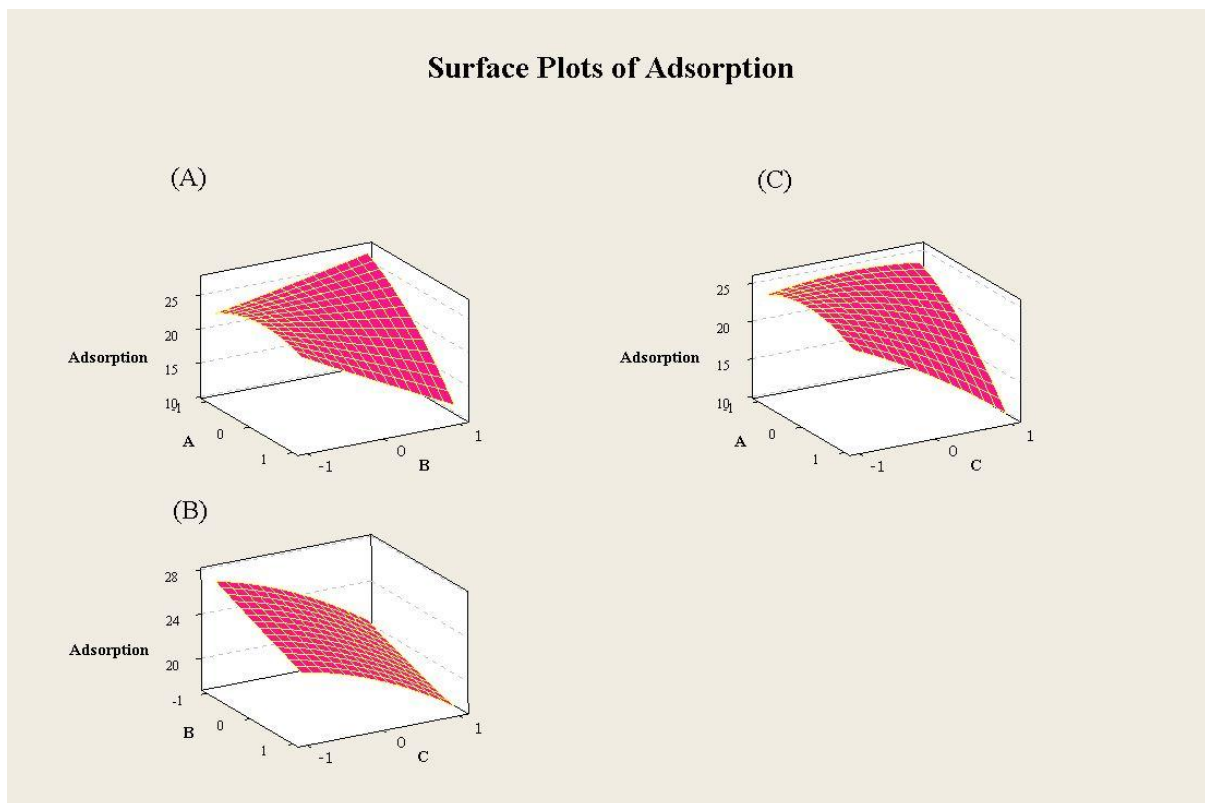

Fig. 4. The surface plots of two process parameters on adsorption of malachite green by AC. Coded variables (-1, 0, 1) for A (microwave power) = 300W, 500W, 700W; B (microwave irradiation time) = 5mins, 10mins, 15mins; C (chemical impregnation ratio = 1:1, 1:2, 1:3).

3.2.3.1. Effect of microwave power and microwave irradiation time

Fig. 4(A) shows the interaction between microwave power and irradiation time on the adsorption efficiency of AC. It was found that the AC obtained at the longest microwave irradiation time (15 min) showed increased adsorption efficiency from 11 to 27 mg/g when a lower microwave power was used to produce the AC (i.e. AC of higher adsorption efficiency was obtained at lower microwave power). In contrast, no changes were observed for the adsorption efficiency of the AC obtained at the short microwave irradiation time (5 min). This indicates that increasing the microwave irradiation time combined with the use of a low microwave power can produce an AC with higher adsorption efficiency. The increase of microwave irradiation time was likely to have heated the biochar to a higher temperature and provided a longer residence time that promoted the decomposition and cracking of biochar, leading to increased formation of pores on the resulting AC that could in turn provide more sites for adsorption of malachite green. On the contrary, the use of short microwave irradiation time provided insufficient microwave energy to heat and promote the cracking reactions for pores development, and thus presenting no beneficial effects on the adsorption efficiency of the AC obtained.

3.2.3.2. Effect of microwave irradiation time and chemical impregnation ratio

It was observed from Fig. 4(B) that the adsorption efficiency of AC was decreased with increasing chemical impregnation ratio at all levels of microwave irradiation time, suggesting that a low concentration of alkali metal hydroxides solutions would be sufficient in producing AC with high adsorption efficiency for use as an adsorbent. When higher concentration of hydroxides solution was used, the pores developed within the AC could be damaged, cracked, or filled up by the chemical solution and subsequently lead to the decrease in the adsorption efficiency.

3.2.3.3. Effect of microwave power and chemical impregnation ratio

A low adsorption efficiency of only 10 mg/g was recorded at both the highest chemical impregnation ratio and microwave power used due to the pores destruction occurred on the AC using the highest concentration of alkali metal hydroxides. In addition, the highest microwave power was likely to have led to excessive internal heating within the AC that resulted in excessive burning of carbon (Foo and Hameed, 2012). As a result, the pores were ruptured and this decreased the reactive surface area for adsorption to take place, thus accounting for the low adsorption efficiency.

3.2.4. Process optimization and validation

The optimum values for both responses (AC yield and adsorption efficiency) were obtained from different sets of process parameters. It was a challenge to optimize both the responses using the same process conditions due to different interest regions of factors. Hence, the function of desirability was applied using Minitab 16 software with the intention to compromise between these two responding factors. To obtain the optimized set of process parameters to produce activated carbon, the target criteria was set as “maximum” for both responses while the minimum and maximum values were set higher than the mean values of responses. The results from the optimization test conducted by Minitab 16 software is shown in appendix (Figure A.2). The optimal process parameters predicted was obtained at desirability of 1. Table 2 summarizes the predicted and experimental values of both responses obtained at optimal process parameters; the measured values represent the average value obtained from experiments performed in triplicates for model validation.

Table 2. Model validation from predicted values under the process conditions of 550W, 5 mins, and chemical impregnation ratio of 1:1.

AC yield, Y_1 (wt%)					Adsorption efficiency, Y_2 (mg/g)				
Predicted	Measured				Predicted	Measured			
	1 st	2 nd	3 rd	Average*		1 st	2 nd	3 rd	Average*
87.6	87.2	86.8	87	87	27.9	27.9	29.1	28.4	28.5

* Average value obtained from experiments performed in triplicates.

The optimization test estimated that activated carbon with the highest yield and optimal adsorption efficiency could be produced by soaking the biochar with the prepared alkali metal hydroxides solutions at a chemical impregnation ratio of 1:1, and then subjecting the biochar to thermal activation under microwave irradiation (heating) for 5 min using 550 W of microwave power. The values predicted from the optimization test were validated by performing experiments on microwave-chemical activation of orange peel to produce the AC using the values estimated for the optimal process parameters, and this was followed by experiments to measure the adsorption efficiency shown by the AC obtained on malachite green. The results from these experiments showed that a yield of 87 wt% was measured for the AC and it showed an adsorption efficiency of 28.5 mg/g. It was observed that these measured values were quite similar to the values predicted from the optimization test with small errors of 0.68% and 2.15% for AC yield and adsorption efficiency, respectively.

3.3 Characterization of AC obtained from the optimized process parameters

3.3.1. Elemental and proximate analysis

Table 3 shows the results obtained from the elemental and proximate analysis of orange peel, and the biochar and AC produced from this study. The results show that carbon and

oxygen represented the main elements whereas hydrogen and nitrogen were detected in low concentration. Sulphur was not detected probably due to the presence of a very low sulphur content that was below the detection limit of the CHNS analyzer. The orange peel, biochar and AC were dominated by volatile matter (8.5 – 62.2 wt%) and fixed carbon (34.8 – 83.3 wt%) with small amounts of moisture (5.0 – 11.3 wt%) and ash (3.0 – 9.0 wt%).

Table 3. Elemental and proximate contents

Elemental Content	Orange Peel	Biochar	AC
Carbon	42.5	73.7	84.0
Hydrogen	6.0	4.3	1.1
Nitrogen	0.5	1.0	0.9
Oxygen ^a	51.0	21.0	14.0
Sulphur ^b	0	0	0
Proximate Content			
Moisture ^c	11.3	6.0	5.0
Volatile Matter	62.2	12.7	8.5
Fixed Carbon ^d	34.8	79.3	83.3
Ash ^e	3.0	9.0	3.2

^a Determined by mass difference (Jamaluddin et al., 2013).

^b Sulphur content is not detectable by the minimum detection limit of the CHNS analyser (<0.05 wt%), and thus it is assumed to be 0 wt% in calculation.

^c Dry basis.

^d Calculated by mass difference (i.e. Fixed carbon = 100 wt% - wt% of moisture - volatile matter - ash) (Azura et al., 2013).

^e Obtained by combustion at 950 °C with 20 mins of holding time.

It was found that the both the carbon and fixed carbon contents of the AC increased significantly after the microwave-chemical activation process while the oxygen and volatile contents decreased dramatically. This can be attributed to the decomposition and carbonization reactions that occurred during the microwave-chemical activation from which the organic fractions of biochar such as the cellulose, hemicellulose and lignin originally present in the

orange peel were either decomposed to produce light organic molecules (e.g. CO₂ and CH₄) and released as gases (Aguiar et al., 2008), or they were carbonized to produce a carbon-dense product.

3.3.2. Surface morphology

Fig. 5(a), (b) and (c) present the SEM micrographs of the orange peels, biochar and AC obtained in this study, respectively. The surface of the orange peel was rough and non-porous before carbonization. In contrast, pores were observed on the surface of the biochar and AC obtained after being subjected to the microwave-chemical activation process (Fig. 5(b) and (c)). This indicates that the microwave-chemical activation had led to the production and release of volatile components from the orange peels, and the remaining non-volatile components were transformed into biochar with pores of different shapes and sizes observed on the surface of the biochar (Fig. 5(b)). After the biochar was further subjected to chemical impregnation and thermal activation, it was transformed into AC that showed a highly and more uniform porous structure (Fig. 5(c)). The highly porous structure can in turn provide a high surface area and more sites for adsorption process to be performed.

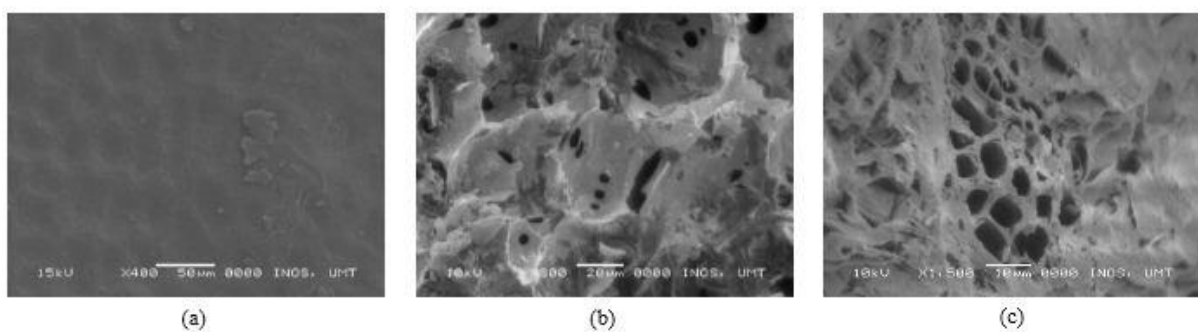

Fig. 5. SEM image of (a) orange peel, (b) biochar, (c) AC.

3.3.3. N₂ adsorption-desorption isotherm and porous characteristics

Fig. 6 shows the N₂ adsorption-desorption isotherms of the AC obtained from the optimized process parameters and the resulting data on the porous characteristics of the biochar and AC are presented in Table 4. The AC showed a combination of Type I and Type II isotherms with a small hysteresis loop according to the IUPAC classification (Sing et al., 1985). This type of isotherm is an indication to the presence of a microporous-mesoporous structure with the pore width ranging from 2 to 50 nm (Foo and Hameed, 2012). This concurs with the pore width estimated for the AC using the BJH method (23 nm; See Table 4). In addition, the AC was detected to have micropore and mesopore volumes of 0.38 cm³/g and 0.22 cm³/g, respectively, which further corroborates the presence of micropores and mesopores within the AC. The AC obtained from the microwave-chemical activation in this study showed a much desirable porous characteristic compared to the biochar obtained (Table 4). The AC was found to be more porous and contained a much higher surface area (1350 m²/g) dominated by micropores and mesopores.

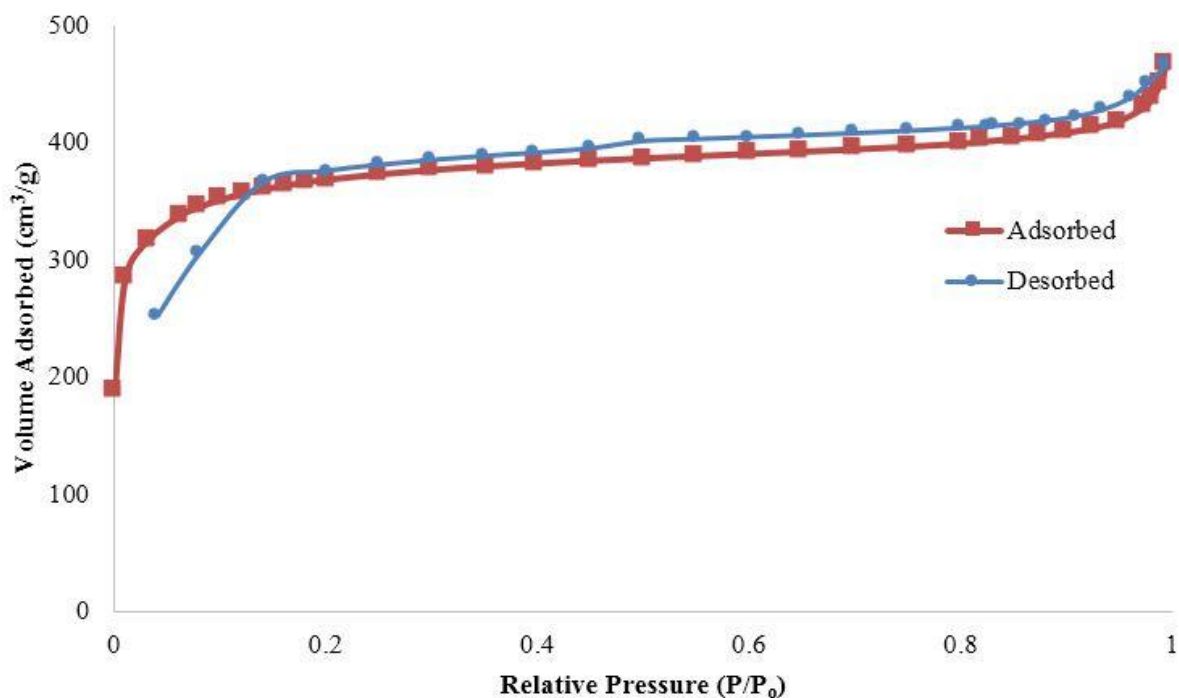

Fig. 6. Nitrogen adsorption-desorption isotherms of AC.

Table 4. Porous characteristics of biochar and AC.

Properties	Biochar	AC
BET surface area (m ² /g) ^a	20.8	1350
Micropore area (m ² /g) ^b	11.6	930
Total pore volume (cm ³ /g) ^c	0.0075	0.60
Micropore volume (cm ³ /g) ^b	0.0058	0.38
Mesopore volume (cm ³ /g) ^d	0.0017	0.22
Average pore width (nm) ^c	65	23

^a Multipoint Brunauer, Emmett & Teller (BET) method.

^b t-plot method.

^c Barrett, Jovner & Halenda (BJH) desorption method.

^d Mesopore volume = Total pore volume – Micropore volume (Foo and Hameed, 2012)

3.4. Process features and AC properties compared to other AC production methods in the literature

Table 5 shows the process features and properties of AC demonstrated from microwave-assisted pyrolysis with chemical activation compared with commercial AC and AC produced by other methods reported in the literature. The process features and properties of AC obtained from the optimized parameters in this study was selected for comparison. These evaluations are important to assess the technical viability of this microwave-chemical activation approach, especially in scaling and optimizing the design and operation to the commercial level.

Table 5. Product comparison.

	AC (This study)	AC from literatures (Ghaedi and Mosallanejad, 2014; Mahamad et al., 2015; Nekouei et al., 2016)	Commercial AC (Fidalgo et al., 2008)
Process Features			
Total process time	25 min	1 – 7 hours	≥ 5 hours
Process temperature (°C)	460 – 490	450 – 900	1000 – 2000
Types of activation agent	Mixtures of NaOH and KOH	Single agents (e.g. KOH, NaOH, CO ₂ , steam)	Steam
Properties of AC			
Moisture (wt%)	5.0	≤ 1.5	8.5
Ash (wt%)	3.2	≤ 1.5	2.1
BET surface area (m ² /g)	1350	900 – 1271	826
Total pore volume (cm ³ /g)	0.60	0.56	0.34
Production cost of AC^a (USD/kg)		Market price of commercial AC (USD/kg)	
This study	Zauba.com ^b	Alibaba.com ^c	MarketsandMarkets ^d
0.20	1.17 – 2.14	0.62 – 5.63	1.73-2.26

^aEstimated from the cost incurred by the feedstock, chemicals, and electricity used in producing the AC.

^bMarket price obtained from <https://www.zauba.com/export-COCONUT+SHELL+ACTIVATED+CARBON-hs-code.html>, accessed on 15 January 2017.

^cMarket price obtained from <https://www.alibaba.com/showroom/activated-carbon-price.html>, accessed on 15 January 2017.

^dStatistics from a market research firm at <http://www.marketsandmarkets.com/Market-Reports/activated-carbon-362.html>, accessed on 4 April 2017.

It was observed that microwave-assisted pyrolysis shows advantages in providing a faster heating rate (up to 112 °C/min) and shorter process time (25 min) over other AC production methods by pyrolysis using conventional oven or furnace as the heat source (heating rate: 5–10 °C/min; process time: 1–7 hours). In addition, low process temperature was required (460 °C for carbonization, 490 °C for activation) compared to that required by other methods adopting conventional pyrolysis (up to 2000 °C for carbonization, 450–900 °C for activation), thus presenting a significantly lower energy consumption since a lower thermal energy was needed to achieve the temperature for both carbonization and activation. These favourable features suggest the great promise of this pyrolysis approach as a faster and energy efficient method to produce AC.

The addition of chemical activation with alkali metal hydroxides also resulted in the production of AC with a higher pore volume and a surface area higher or nearly comparable to that shown by commercial AC and AC produced by other methods reported in the literature. It was likely that the alkali metal hydroxides had weakened and broken down the chemical bonds between the lignocellulosic components remained in the biochar (e.g. lignin originally derived from orange peel) and this led to increased removal of these components in the form of volatiles (e.g. CO₂ and CH₄) during the subsequent thermal activation by microwave-assisted pyrolysis, resulting in increased formation of pores and hence the surface area of the resulting AC.

In addition, the use of alkali metal hydroxides combining NaOH and KOH as the chemical activating agent seemed to have a beneficial effect in increasing the porosity and surface area of the AC, possibly due to increased pore formation via an intercalation effect caused by interaction of K and Na atom with the carbon structure of the AC (Alau et al., 2010; Chowdhury et al., 2011; Gimba et al., 2010; Giraldo and Moreno-Piraján, 2012; Musa et al., 2015; Raymundo-Pinero et al., 2005). Furthermore, the combination of NaOH and KOH has led to production of a pore structure dominated by micropores and mesopores. This represents

a desirable feature if the AC is to be used as an adsorbent, since a microporous-mesoporous structure could give the adsorbate (e.g. dye pollutant) access to the smaller micropores located within the larger mesopores, thus providing greater access to pores and sites in order for adsorption to take place.

The AC was tested for its efficiency as adsorbent on MG dye and it was found to show an adsorption efficiency of up to 28.5 mg MG dye / g of AC (Table 6). The AC showed improved adsorption efficiency compared to that shown by AC obtained in other studies (≤ 15 mg of MG dye / g of AC; Table 6). The higher adsorption efficiency could be derived from the high porosity and higher surface area (1350 m²/g) of the AC that provide more sites for adsorption of MG to occur compared to that shown by other ACs (≤ 1271 m²/g). The high adsorption efficiency is beneficial and indicates the potential of the AC to be used as a dye adsorbent.

Table 6. Comparison of adsorption efficiency of AC on MG dye.

Adsorbent	Adsorption efficiency on Malachite Green dye (mg/g)	BET surface area (m ² /g)	References
AC (this study)	28.5	1350	
ZnO Nanorod-loaded activated carbon *	15	Not reported	Ghaedi et al. (2016)
Ni(OH) ₂ -NPs-AC *	9 – 15	960	Nekouei et al. (2016)
(Cd(OH) ₂ -NW-AC) *	1 – 2	1271	Ghaedi and Mosallanejad (2014)
Groundnut shell activated carbon *	11.4	Not reported	Hassan et al. (2010)

* The adsorption efficiency was obtained from studies using different contact time. It was adapted to show the adsorption efficiency obtained within a contact time of 3 min for comparison to be made to the adsorption efficiency of AC obtained in this study.

The AC was also detected to have a low moisture and ash content. Low moisture content (< 10 wt%) is preferable otherwise the moistures could attach on the surface or block the pores on/within the AC and decrease the accessibility and availability of adsorption sites, and resulting in decreased durability and lifespan of the AC. Low ash content (< 5 wt%) is important to prevent formation of by-products from the undesirable catalytic reactions caused by the inorganic minerals present in the ash (Mahamad et al., 2015; Qureshi et al., 2008), which can decrease the adsorption capacity and reactivation efficiency of AC.

The production cost of AC by the microwave-assisted pyrolysis method was estimated to allow a simple evaluation of its economic feasibility; this was presented in Table A.2 in Appendix. The estimation was based on the cost incurred by the feedstock (orange peel), transportation, chemicals (hydroxides and hydrochloric acid), N₂ gas, and the electricity used by the pyrolysis method in producing the AC. The production cost was estimated to be about USD 0.20 / kg of AC, which is comparatively lower than the market price of AC (USD 0.62 – 5.63 / kg of AC) and the production cost (USD 1.67 / kg of AC) reported by Selvaraju and Bakar (2017) (Table 5). This is a good indication of profitability and suggests that the microwave-assisted pyrolysis method could be an economically viable approach to produce AC, hence the pyrolysis operation could be scaled up for commercial applications.

4. Conclusion

Microwave-assisted pyrolysis with chemical activation showed desirable process features in converting orange peel into AC, providing a fast heating rate (up to 112 °C/min), short process time (25 mins), and a low process temperature (460–490 °C). The process parameters were optimized from which AC with an optimal yield (87 wt% of biochar) and adsorption efficiency (28.5 mg of Malachite green dye / g of activated carbon) was obtained

by performing chemical impregnation at an impregnation ratio of 1:1 coupled with thermal activation under microwave irradiation (heating) for 5 min using 550 W of microwave power.

The addition of chemical activation with alkali metal hydroxides generated a highly porous and carbon-dense AC with a high surface area (1350 m²/g). The AC showed a microporous-mesoporous structure that could improve pores accessibility and adsorption capacity of the AC. Combined with a low moisture and ash content, the AC shows great promise as a high-grade dye adsorbent with high adsorption capacity. Our results demonstrated that microwave-assisted pyrolysis coupled with chemical activation shows exceptional promise as a fast and energy efficient method to convert orange peel to produce activated carbon with improved properties desirable for use as a dye adsorbent to treat wastewater in textile industry.

Acknowledgements

The authors acknowledge the financial support by the Universiti Malaysia Terengganu for the conduct of the research.

References

- Aguiar, L., Márquez-Montesinos, F., Gonzalo, A., Sánchez, J.L., Arauzo, J., 2008. Influence of temperature and particle size on the fixed bed pyrolysis of orange peel residues. *J. Anal. Appl. Pyrol.* 83, 124-130.
- Ahmad, M.A., Alrozi, R., 2010. Optimization of preparation conditions for mangosteen peel-based activated carbons for the removal of Remazol Brilliant Blue R using response surface methodology. *Chem. Eng. J.* 165, 883-890.
- Al-Qodah, Z., Shawabkah, R., 2009. Production and characterization of granular activated carbon from activated sludge. *Braz. J. Chem. Eng.* 26, 127-136.
- Alau, K., Gimba, C., Kagbu, J., Nale, B., 2010. Preparation of activated carbon from neem (*Azadirachta indica*) husk by chemical activation with H₃PO₄, KOH and ZnCl₂. *Arch. Appl. Sci. Res.* 2, 451-455.
- Auta, M., Hameed, B., 2011. Optimized waste tea activated carbon for adsorption of Methylene Blue and Acid Blue 29 dyes using response surface methodology. *Chem. Eng. J.* 175, 233-243.

- Azuara, M., Kersten, S.R., Kootstra, A.M.J., 2013. Recycling phosphorus by fast pyrolysis of pig manure: concentration and extraction of phosphorus combined with formation of value-added pyrolysis products. *Biomass Bioenerg.* 49, 171-180.
- Baccar, R., Bouzid, J., Feki, M., Montiel, A., 2009. Preparation of activated carbon from Tunisian olive-waste cakes and its application for adsorption of heavy metal ions. *J. Hazard. Mater.* 162, 1522-1529.
- Bhatnagar, A., Hogland, W., Marques, M., Sillanpää, M., 2013. An overview of the modification methods of activated carbon for its water treatment applications. *Chem. Eng. J.* 219, 499-511.
- Boukroufa, M., Boutekedjiret, C., Petigny, L., Rakotomanomana, N., Chemat, F., 2015. Bio-refinery of orange peels waste: a new concept based on integrated green and solvent free extraction processes using ultrasound and microwave techniques to obtain essential oil, polyphenols and pectin. *Ultrason. Sonochem.* 24, 72-79.
- Chen, H., 2005. *Biotechnology of lignocellulose*. Springer.
- Chowdhury, Z.Z., Zain, S.M., Khan, R.A., Ashraf, M.A., 2011. Preparation, characterization and adsorption performance of the KOH-activated carbons derived from kenaf fiber for lead (II) removal from waste water. *Sci. Res. Essays* 6, 6185-6196.
- Demiral, H., Güngör, C., 2016. Adsorption of copper (II) from aqueous solutions on activated carbon prepared from grape bagasse. *J. Clean. Prod.* 124, 103-113.
- Dural, M.U., Cavas, L., Papageorgiou, S.K., Katsaros, F.K., 2011. Methylene blue adsorption on activated carbon prepared from *Posidonia oceanica* (L.) dead leaves: Kinetics and equilibrium studies. *Chem. Eng. J.* 168, 77-85.
- Fidalgo, B., Fernández, Y., Domínguez, A., Pis, J.J., Menéndez, J.A., 2008. Microwave-assisted pyrolysis of CH₄/N₂ mixtures over activated carbon. *J. Anal. Appl. Pyrol.* 82, 158-162.
- Foo, K., Hameed, B., 2012. Factors affecting the carbon yield and adsorption capability of the mangosteen peel activated carbon prepared by microwave assisted K₂CO₃ activation. *Chem. Eng. J.* 180, 66-74.
- Garba, Z.N., Rahim, A.A., 2014. Process optimization of K₂C₂O₄-activated carbon from *Prosopis africana* seed hulls using response surface methodology. *J. Anal. Appl. Pyrol.* 107, 306-312.
- Ghaedi, M., Azad, F.N., Dashtian, K., Hajati, S., Goudarzi, A., Soylak, M., 2016. Central composite design and genetic algorithm applied for the optimization of ultrasonic-assisted removal of malachite green by ZnO Nanorod-loaded activated carbon. *Spectrochim. Acta A.* .
- Ghaedi, M., Mosallanejad, N., 2014. Study of competitive adsorption of malachite green and sunset yellow dyes on cadmium hydroxide nanowires loaded on activated carbon. *J. Ind. Eng. Chem.* 20, 1085-1096.
- Gimba, C., Salihu, A.A., Kagbu, J., Turoti, M., Itodo, A., Sariyya, A., 2010. Study of pesticide (Dichlorvos) removal from aqueous medium by *Arachis hypogaea* (groundnut shell) using GC/MS. *World Rur. Observ.* 2, 1-9.

- Giraldo, L., Moreno-Piraján, J.C., 2012. Synthesis of activated carbon mesoporous from coffee waste and its application in adsorption zinc and mercury ions from aqueous solution. *J. Chem.* 9, 938-948.
- Huang, Y.-P., Hou, C.-H., Hsi, H.-C., Wu, J.-W., 2015. Optimization of highly microporous activated carbon preparation from Moso bamboo using central composite design approach. *J. Taiwan Inst. Chem. Eng.* 50, 266-275.
- Jamaluddin, M.A., Ismail, K., Mohd Ishak, M.A., Ab Ghani, Z., Abdullah, M.F., Safian, M.T.-u., Idris, S.S., Tahiruddin, S., Mohammed Yunus, M.F., Mohd Hakimi, N.I.N., 2013. Microwave-assisted pyrolysis of palm kernel shell: Optimization using response surface methodology (RSM). *Renew. Energ.* 55, 357-365.
- Jin, H., Wang, X., Gu, Z., Polin, J., 2013. Carbon materials from high ash biochar for supercapacitor and improvement of capacitance with HNO₃ surface oxidation. *J. Power Sources* 236, 285-292.
- Junior, O.P., Cazetta, A.L., Gomes, R.C., Barizão, É.O., Souza, I.P., Martins, A.C., Asefa, T., Almeida, V.C., 2014. Synthesis of ZnCl₂-activated carbon from macadamia nut endocarp (*Macadamia integrifolia*) by microwave-assisted pyrolysis: optimization using RSM and methylene blue adsorption. *J. Anal. Appl. Pyrol.* 105, 166-176.
- Kundu, A., Gupta, B.S., Hashim, M., Redzwan, G., 2015a. Taguchi optimization approach for production of activated carbon from phosphoric acid impregnated palm kernel shell by microwave heating. *J. Clean. Prod.* 105, 420-427.
- Kundu, A., Gupta, B.S., Hashim, M., Sahu, J., Mujawar, M., Redzwan, G., 2015b. Optimisation of the process variables in production of activated carbon by microwave heating. *RSC Adv.* 5, 35899-35908.
- Lam, S.S., Liew, R.K., Cheng, C.K., Chase, H.A., 2015. Catalytic microwave pyrolysis of waste engine oil using metallic pyrolysis char. *Appl. Catal. B-Environ.* 176-177, 601-617.
- Lam, S.S., Liew, R.K., Jusoh, A., Chong, C.T., Ani, F.N., Chase, H.A., 2016a. Progress in waste oil to sustainable energy, with emphasis on pyrolysis techniques. *Renew. Sust. Energ. Rev.* 53, 741-753.
- Lam, S.S., Liew, R.K., Lim, X.Y., Ani, F.N., Jusoh, A., 2016b. Fruit waste as feedstock for recovery by pyrolysis technique. *Int. Biodeter. Biodeg.* 113, 325-333.
- Lam, S.S., Liew, R.K., Wong, Y.M., Azwar, E., Jusoh, A., Wahi, R., 2016c. Activated Carbon for Catalyst Support from Microwave Pyrolysis of Orange Peel. *Waste Biomass Valori.*, 1-11.
- Lam, S.S., Mahari, W.A.W., Cheng, C.K., Omar, R., Chong, C.T., Chase, H.A., 2016d. Recovery of diesel-like fuel from waste palm oil by pyrolysis using a microwave heated bed of activated carbon. *Energ.* 115, 791-799.
- Lam, S.S., Mahari, W.A.W., Jusoh, A., Chong, C.T., Lee, C.L., Chase, H.A., 2017. Pyrolysis using microwave absorbents as reaction bed: An improved approach to transform used frying oil into biofuel product with desirable properties. *J. Clean. Prod.* 147, 263-272.

- Le Van, K., Thi, T.T.L., 2014. Activated carbon derived from rice husk by NaOH activation and its application in supercapacitor. *Prog. Nat. Sci. Mat. I.* 24, 191-198.
- Lei, H., Ren, S., Julson, J., 2009. The effects of reaction temperature and time and particle size of corn stover on microwave pyrolysis. *Energ. Fuel.* 23, 3254-3261.
- Lou, X., Nair, J., 2009. The impact of landfilling and composting on greenhouse gas emissions—a review. *Bioresour. Technol.* 100, 3792-3798.
- Mahamad, M.N., Zaini, M.A.A., Zakaria, Z.A., 2015. Preparation and characterization of activated carbon from pineapple waste biomass for dye removal. *Int. Biodeter. Biodeg.* 102, 274-280.
- Mahapatra, K., Ramteke, D., Paliwal, L., 2012. Production of activated carbon from sludge of food processing industry under controlled pyrolysis and its application for methylene blue removal. *J. Anal. Appl. Pyrol.* 95, 79-86.
- Manya, J.J., 2012. Pyrolysis for biochar purposes: a review to establish current knowledge gaps and research needs. *Environ. Sci. Technol.* 46, 7939-7954.
- Menéndez, J., Domínguez, A., Fernández, Y., Pis, J., 2007. Evidence of self-gasification during the microwave-induced pyrolysis of coffee hulls. *Energ. Fuel.* 21, 373-378.
- Menéndez, J., Domínguez, A., Inguanzo, M., Pis, J., 2004. Microwave pyrolysis of sewage sludge: analysis of the gas fraction. *J. Anal. Appl. Pyrol.* 71, 657-667.
- Meryemoglu, B., Irmak, S., Hasanoglu, A., 2016. Production of activated carbon materials from kenaf biomass to be used as catalyst support in aqueous-phase reforming process. *Fuel Process. Technol.* 151, 59-63.
- Mohammed, J., Nasri, N.S., A. Zaini, M.A., Hamza, U.D., Zain, H.M., Ani, F.N., 2015. Optimization of microwave irradiated - coconut shell activated carbon using response surface methodology for adsorption of benzene and toluene. *Desalin. Water Treat.*, 1-17.
- Musa, M., Sanagi, M., Nur, H., IBRAHIM, W., 2015. Understanding Pore Formation and Structural Deformation in Carbon Spheres During KOH Activation. *Sains Malays.* 44, 613-618.
- Nasri, N.S., Jibril, M., Zaini, M.A.A., Mohsin, R., Dadum, H.U., Musa, A.M., 2014a. Synthesis and characterization of green porous carbons with large surface area by two step chemical activation with KOH. *J. Teknol.* 67.
- Nasri, N.S., Zaini, M.A.A., Mohsin, R., Dadum, H.U., Musa, A.M., 2014b. Synthesis and characterization of bio-based porous carbons by two step physical activation with CO₂. *Jurnal Teknologi* 68.
- Nekouei, F., Kargarzadeh, H., Nekouei, S., Tyagi, I., Agarwal, S., Gupta, V.K., 2016. Preparation of Nickel hydroxide nanoplates modified activated carbon for Malachite Green removal from solutions: Kinetic, thermodynamic, isotherm and antibacterial studies. *Process Saf. Environ.* 102, 85-97.

- Njoku, V., Foo, K., Asif, M., Hameed, B., 2014. Preparation of activated carbons from rambutan (*Nephelium lappaceum*) peel by microwave-induced KOH activation for acid yellow 17 dye adsorption. *Chem. Eng. J.* 250, 198-204.
- Raymundo-Pinero, E., Azais, P., Cacciaguerra, T., Cazorla-Amorós, D., Linares-Solano, A., Béguin, F., 2005. KOH and NaOH activation mechanisms of multiwalled carbon nanotubes with different structural organisation. *Carbon* 43, 786-795.
- Russell, A.D., Antreou, E.I., Lam, S.S., Ludlow-Palafox, C., Chase, H.A., 2012. Microwave-assisted pyrolysis of HDPE using an activated carbon bed. *RSC Adv.* 2, 6756-6760.
- Saygılı, H., Güzel, F., 2016. High surface area mesoporous activated carbon from tomato processing solid waste by zinc chloride activation: process optimization, characterization and dyes adsorption. *J. Clean. Prod.* 113, 995-1004.
- Saygılı, H., Güzel, F., Önal, Y., 2015. Conversion of grape industrial processing waste to activated carbon sorbent and its performance in cationic and anionic dyes adsorption. *J. Clean. Prod.* 93, 84-93.
- Selvaraju, G., Bakar, N.K.A., 2017. Production of a new industrially viable green-activated carbon from *Artocarpus integer* fruit processing waste and evaluation of its chemical, morphological and adsorption properties. *J. Clean. Prod.* 141, 989-999.
- Sing, K., Everett, D., Haul, R., Moscou, L., Pierotti, R., Rouquerol, J., Siemieniowska, T., 1985. Physical and biophysical chemistry division commission on colloid and surface chemistry including catalysis. *Pure Appl. Chem.* 57, 603-619.
- Tay, T., Ucar, S., Karagöz, S., 2009. Preparation and characterization of activated carbon from waste biomass. *J. Hazard. Mater.* 165, 481-485.
- Wan Mahari, W.A., Zainuddin, N.F., Wan Nik, W.M.N., Chong, C.T., Lam, S.S., 2016. Pyrolysis recovery of waste shipping oil using microwave heating. *Energies* 9, 780.
- Williams, P.T., Reed, A.R., 2006. Development of activated carbon pore structure via physical and chemical activation of biomass fibre waste. *Biomass Bioenerg.* 30, 144-152.
- Xin-Hui, D., Srinivasakannan, C., Jin-Hui, P., Li-Bo, Z., Zheng-Yong, Z., 2011. Preparation of activated carbon from *Jatropha* hull with microwave heating: optimization using response surface methodology. *Fuel Process. Technol.* 92, 394-400.
- Zhang, Z., Xiaofeng, B., 2009. Comparison about the three central composite designs with simulation, *Advanced Computer Control*, 2009. ICACC'09. International Conference on. IEEE, pp. 163-167.

Appendix A

A sample with a mass of 0.3 g was subjected to a degassing treatment to remove the moisture and contaminants (e.g. dust) present on the sample. This was performed by heating at 150 °C under vacuum condition for 8 hours. The sample was then cooled to room temperature and then treated with a liquid nitrogen bath. The automatic sorption analysis was then initiated at a temperature of 77 K by exposing the sample to N₂ gas over a range of pressures. The volume of nitrogen adsorbed and desorbed (cm³/g) on the sample at the relative pressure ranging from 0 to 1 were recorded to plot the N₂ adsorption and desorption isotherms. The surface area was calculated based on the nitrogen adsorption-desorption isotherm obtained using the multipoint Brunauer, Emmett & Teller (BET) method whereas the total pore volume and pore width were estimated using the Barette, Jovner & Halenda (BJH) method (Manya, 2012). The micropore area and volume were estimated using t-plot method.

Table A.1: Summary of experimental design matrix.

Run	Code			Parameters			Responses	
Order				Microwave Power (W)	Microwave Irradiation Time (min)	Impregnation Ratio	Yield (wt%)	Adsorption Efficiency (mg/g)
1	1	-1	-1	700	5	1:1	87	30.23
2	-1	0	0	300	10	1:2	70	26.33
3	0	0	0	500	10	1:2	80	23.33
4	-1	1	1	300	15	1:3	77	25.28
5	0	1	0	500	15	1:2	67	19.49
6	1	0	0	700	10	1:2	70	15.85
7	0	-1	0	500	5	1:2	76	26.49
8	0	0	0	500	10	1:2	79	23.06
9	0	0	1	500	10	1:3	70	18.19
10	1	1	1	700	15	1:3	62	7.83
11	0	0	0	500	10	1:2	82	22.91
12	1	-1	1	700	5	1:3	70	15.22
13	1	1	-1	700	15	1:1	56	16.52
14	-1	-1	-1	300	5	1:1	80	19.00
15	-1	-1	1	300	5	1:3	74	22.57
16	0	0	-1	500	10	1:1	82	26.00
17	-1	1	-1	300	15	1:1	80	27.12

Table A.2 Estimated production cost (USD/kg) of the AC.

Components	Estimated cost (USD/kg)
Transportation of orange peel	0.07
Orange peel as feedstock	0.02
Chemicals (Hydroxides and hydrochloric acid) <i>i.e. Hydroxides = USD 0.01, hydrochloric acid = USD 0.01 (Selvaraju and Bakar, 2017)</i>	0.02
Nitrogen gas <i>i.e. USD 3/48L, 1 standard refill of nitrogen gas in Malaysia = 48 L</i>	0.06 USD/L
Electrical consumption including carbonization and activation <i>i.e. Carbonization (20 mins, 700W) = USD 0.01</i> <i>Activation using optimized process conditions (5 mins, 550W) = USD 0.0023</i> <i>*Charges rate of electricity in Malaysia (1 kWh) = USD 0.05</i>	0.0123
Total estimated production cost	0.1823 ~ 0.2

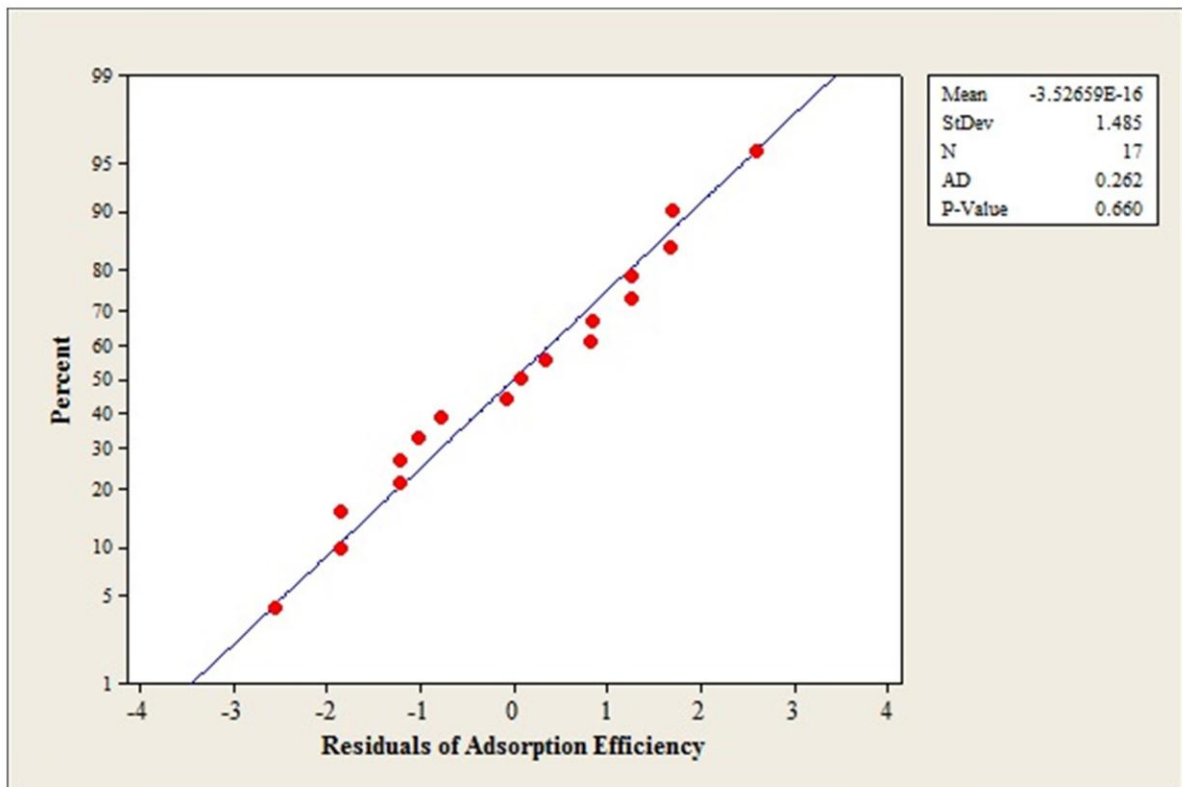
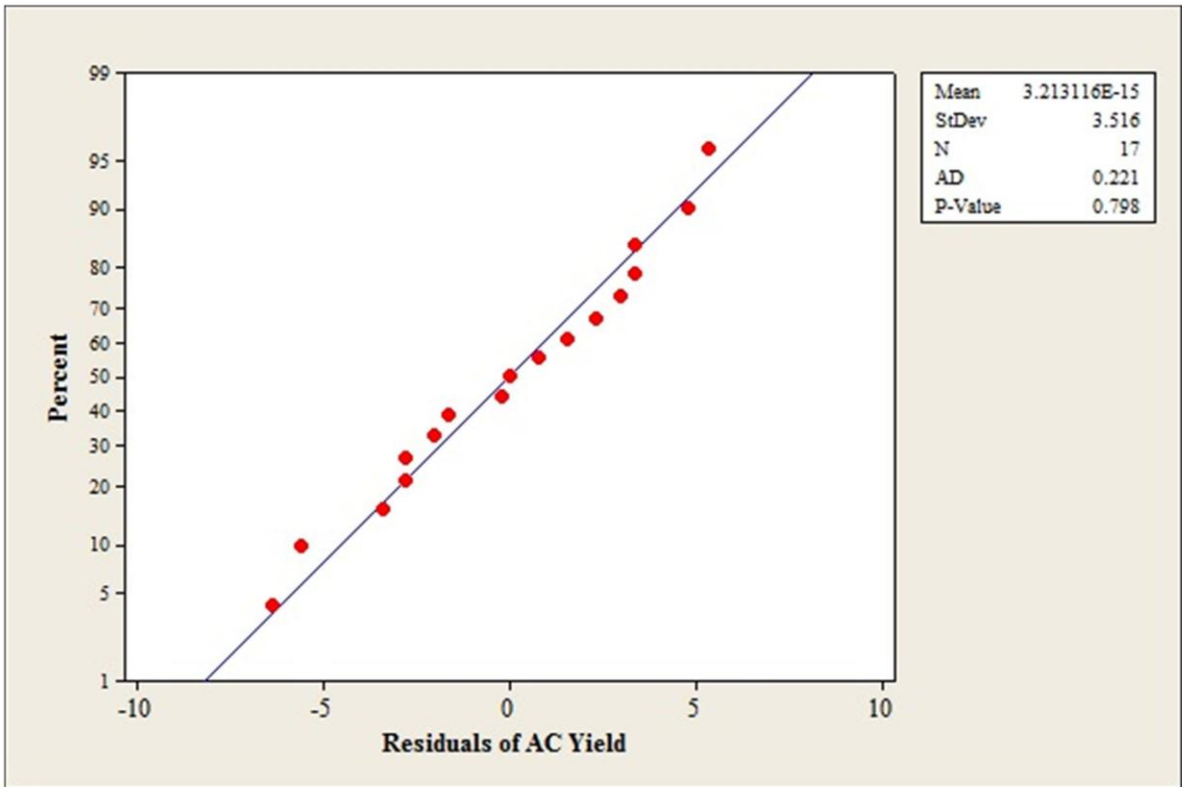

Fig. A.1 Normality tests of the residuals derived from AC yield and adsorption efficiency.

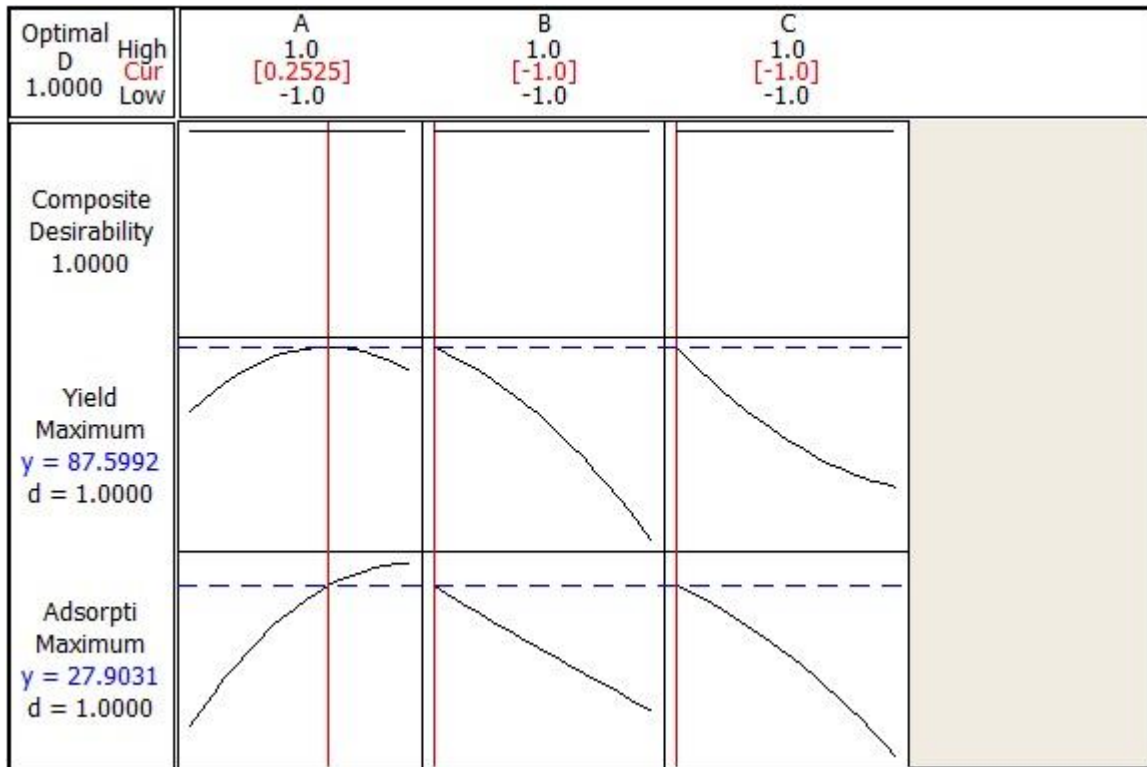

Fig. A.2 Optimization of process parameters by Minitab 16 software.