

9th International Conference on Applied Energy, ICAE2017, 21-24 August 2017, Cardiff, UK

## The development of an experimental test rig to evaluate the performance of a new technology for stratified hot water storage - The Water Snake

Amin Al-Habaibeh<sup>a</sup>, Bubaker Shakmak<sup>a</sup>, Simon Fanshawe<sup>b,\*</sup>

<sup>a</sup>*Innovative and Sustainable Built Environment Technologies (iSBET), School of Architecture, Design and the Built Environment, Nottingham Trent University, NG1 4BU, UK*

*Amin.Al-Habaibeh@ntu.ac.uk; bubaker.shakmak2008@my.ntu.ac.uk*

<sup>b</sup>*Gannet Limited, Nottingham, UK; simon@gannet.co.uk*

---

### Abstract

The increase in energy prices and the demand to reduce carbon emission is attracting the attention to the implementation and integration of diverse heating technologies such as heat pumps, solar energy, gas boilers, CHP and electric heaters. Heating applications for integrated technologies include district heating, domestic small-scale applications and commercial large-scale buildings. Energy from flooded coalmines and water from other sources could also play an important role in improving energy efficiency of heating and cooling systems. Stratified thermal storage and hot water tanks are likely to become key to energy efficient heating, particularly when implementing a mix of technologies. A stratified hot water tank, and even natural stratified reservoirs, are expected to play an important role in the integration of several heating technologies that operate efficiently at different levels of temperature with reduced implementation cost. This paper discusses the new innovative technology to improve stratification, namely 'the water snake', and an automated test rig to evaluate the new stratification method for energy utilisation using energy storage of hot water. A fully computerised system is used to evaluate the performance. The results clearly indicate that the test rig has been successful for the automated testing of the technology. Moreover, the results show that the water snake as a new technology for stratification is successful in minimising mixing and turbulence inside the thermal energy storage. The results prove that the technology could be implemented for a wide range of applications to enhance the efficiency of heating systems in buildings as well as district heating and cooling applications.

© 2017 The Authors. Published by Elsevier Ltd.

Peer-review under responsibility of the scientific committee of the 9th International Conference on Applied Energy.

---

\* Corresponding author. Tel.: +44 (0) 115 848 2564; fax: +44 (0) 115 8486166.

*E-mail address:* Amin.Al-Habaibeh@ntu.ac.uk

© 2017 The Authors. Published by Elsevier Ltd.

Peer-review under responsibility of the scientific committee of the 9th International Conference on Applied Energy.

## 1. Introduction

Thermal Energy Storage (TES) is a technology used to store the thermal energy for later time use in buildings and industrial processes. The technology is used for heating and cooling applications and power generation. The TES systems can assist in balancing the energy demand and supply, reduce peak demand, energy consumption, CO<sub>2</sub> emissions as well as cost [1].

Thermal storage systems are already widely used with solar thermal systems so that the heat can be used after sunset. They are also used for heat pumps and boilers. They can be used to enhance the hot or cold storage buffer tank and also they can be used to enhance the stratification of the water in flooded coalmines to reduce underground water mixing between the water intake and return [2, 3]. Hence, there is an increasing market for large stratified thermal storage systems as they allow inputs from different heat sources to be combined and used for heating and cooling applications.

“Stratification” is the intention to heat, or cool, two or more horizontal layers to different temperatures. Typically, the lower 60% of a thermal store is heated to an appropriate temperature for space heating with the top 40% being at a temperature high enough for the hot water preparation. The less mixing there is between fluids at different temperatures, the more efficient the stratification is.

The stratification is found to be efficient not only for the water storage tank but for the whole system linked to it. For example, for a solar collector, it has been found that the thermal stratification decreases the temperature at the collector inlet which increases its efficiency as well as it decreases the operation cycle of the secondary source of energy [4]. The stratification is becoming an effective factor for both commercial and environmental reasons. Stratified tank will keep the hot water for longer time and then reduces the heating and reheating processes, which are costly and wasteful to the environment. Several parameters influence thermal stratification. One of those parameters is the location of the inlet, which is more important than the outlet. This means that the inlet fluid should be entered to the suitable height [5]. Therefore, the methods that improve the supplying process of the water to the right level inside the thermal storage is vital. One of the methods proposed to improve the stratification inside the thermal energy storage is by using a thin flexible tube, named as the water snake. The water snake moves up and down according to the temperature and the density of water entered into the tank placing it in the right layer where temperatures and densities are the same. Furthermore, the technology could also be implemented on a larger scale for open loop geothermal heating and cooling systems using water from flooded coalmines and large water reservoirs as energy storage buffers [2, 3]. This means the water snake could be implemented to reduce mixing in temperature between the water inlet and outlet, hence improving the efficiency of the system.

### 1.1. THE WATER SNAKE CONCEPT

The Water Snake is a radically new method for minimising mixing and turbulence of water entering a stratified thermal store. It is a highly flexible thin walled tube which is fixed and sealed to the feeding line into the vessel. The open end is free to float within the vessel such that it will rise or drop to a position of neutral buoyancy. Thus, the end of the snake will move to the right temperature level equal to the temperature of water flowing in the snake hence reducing any mixing between different temperature levels [6]. Fig. 1 outlines the basic principle of the water snake movement inside a thermal tank. The water snake will move to the proper layer of water that its temperature and density identical to the temperature and the density of the supplied water. The water snake is connected to the inlet pipe with its other end left open and free to float within the vessel such that it will rise or drop to a position of neutral buoyancy as shown in Fig. 1.

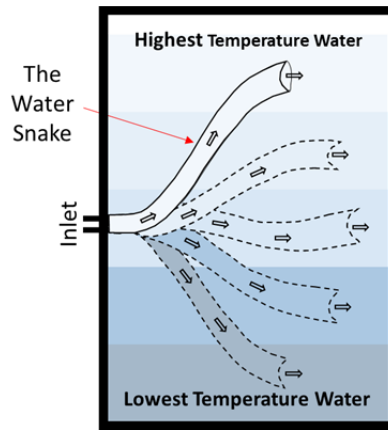

Fig. 1. A schematic diagram that shows the movement of the water snake to the proper water layer that match the inlet water temperature.

Fig. 2 presents a schematic diagram of the automated experimental test rig developed to evaluate the new technology (Water Snake) for stratified hot water, as configured for the first run of the machine. Further circuits could also be added to simulate space heating and domestic hot water preparation using a plate heat exchanger. These will both include a Water Snake to return water into the tank. The technology could also be used to enhance stratification in open loop systems for using water from flooded coalmines and underground reservoirs with heat pumps for heating and cooling applications.

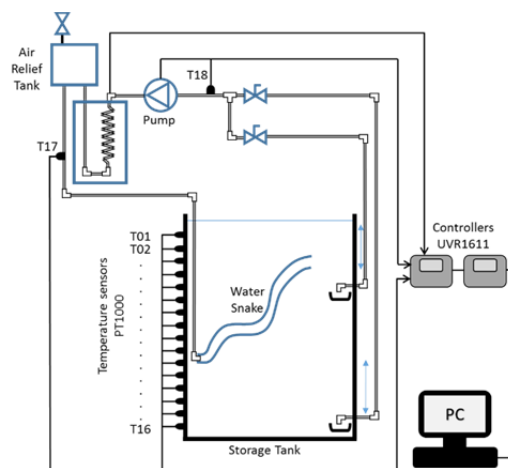

Fig. 2. A schematic diagram of the automated experimental test rig

The automated test rig is programmed to circulate the water from/to the water storage tank. The water will be drawn as required from any level of water within the tank. The drawn water will be either heated up using the heater coil or introduced without heating and then returned to the tank to investigate whether the new technology of using the water snake can feed the inlet water to the exact layer of water inside the tank. Fig. 3 shows an actual water snake in two positions. The end open of the water snake moved to the layer of water that have the same density and temperature of the supplied water.

Evaluation of the stratification process inside the TES is carried out using either density approach or temperature approach [7]. In this paper, for the evaluation of the stratification and consequently the performance of the water snake as a novel technology, the temperature approach is used. Therefore, a multiple temperature sensors have been fitted on the sidewall of the tank to probe the temperature of layers of water up to sixteen layer.

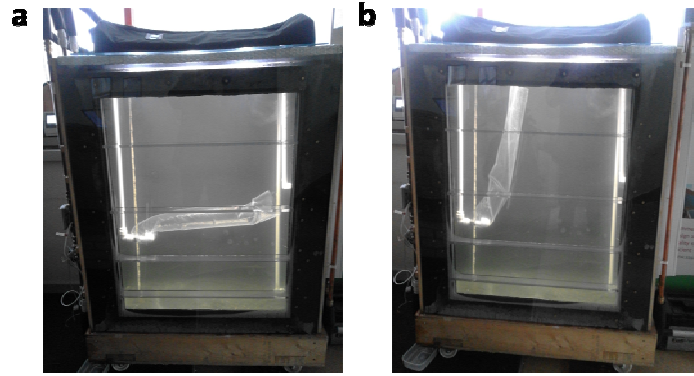

Fig. 3. The snake in the middle position where water from the bottom of the tank is heated to a temperature equal to that in the middle portion of the tank (a) ; and the snake in the top position when the top layer was being heated such that the returning water was hotter than that at the top of the tank (b).

## 2. THE EXPERIMENT WORK

This section will discuss the full details of the experimental work including the automated test rig structure and the condition monitoring system and control used to run the experiments.

### 2.1. The Water Snake

The Water Snake consisted of a length of 12" (circa 30.5 cm) circumference 200 gauge (50 microns) polyethylene lay flat tubing. One of the purposes of the equipment is to test different materials and dimensions to optimise the effectiveness of the technology.

### 2.2. The Water Storage Tank

To reduce the cost of the system a 650 litre upright Medium-density polyethylene (MDPE) water tank is used in this work, see Fig. 4 (a) The plastic tank is modified to create a double-layered transparent front window to monitor and video the water snake. Due to the high temperature involved, a wooden structure was designed to give the plastic tank the necessary mechanical support and insulation. The tank is filled to a depth of about 1,130 mm with cold water. This went up by about 20 mm during the test due to thermal expansion.

### 2.3. The Automated Experimental Rig

The experimental test rig comprises a hot water storage tank with clear polycarbonate window, pump, pipes, control system based around Technische Alternative UVR1611 controllers, electric boiler, temperature sensors, and the Water Snake, see Fig. 4 (a).

### 2.4. The controllers (UVR1611)

The control system for the test rig implemented two UVR1611 controllers (Fig. 4 (b)) coupled with a CMI data logger over CAN bus. These are made by Technische Alternative and Winsol is the software used to display the data retrieved from the data logger.

### 2.5. The PT1000 Sensors

The PT1000-sensor is used for accurate temperature monitoring applications. It is simple to use in many applications because of its simple linear relationship of the resistor and temperature. It is widely used in industrial application for temperature monitoring, control, and switching. Two PT1000 sensors are implemented to measure the flow through the electric boiler using standard Technische Alternative pipe sensors. Sixteen HeraeusTO92 PT 1000 KL sensors sealed to a glass fibre rod are used to measure the temperatures in the tank. The lowest sensor (T16) is roughly 40 mm from the bottom of the tank. The sensors are spaced at 70 mm intervals with the top one (T1) at 1,090 mm.

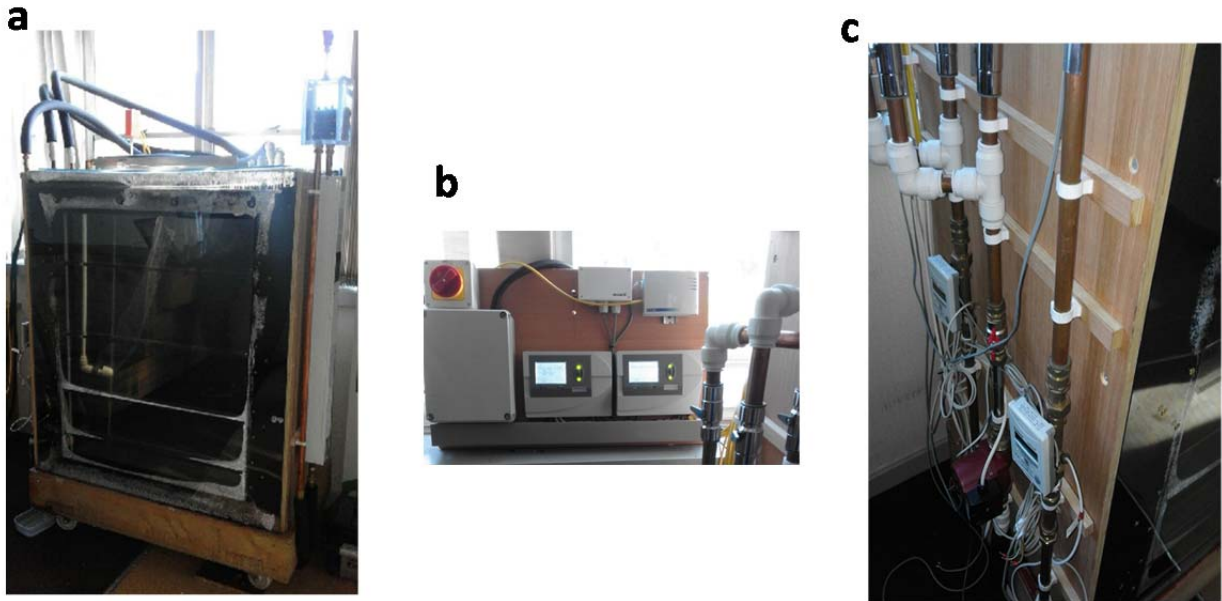

Fig. 4. The automated test rig (a), the two UVR1611 controllers (b) and pipes and instrumentations work (c).

The first UVR1611 controls the circulating pump and 4 off 3kW stages in the electric boiler. This also measures the temperatures of the water being drawn from the tank (T18) and the heated water being returned through the water Snake (T17). The temperatures in the tank are measured by sixteen PT1000 sensors connected to the 2nd UVR1611 (T1 to T16). Each has only 16 inputs so it has been necessary to use two controllers. In the present test only the plumbing required for heating the tank is present and the valves used to select one of the two levels to draw out the water are chosen manually. The first initial preparation test is primarily intended to demonstrate the test rig and to heat it above its range of expected working temperatures, 20° C - 80° C. The fluid in the tank is fresh water with some corrosion inhibitor added. As the water had not been previously heated, some air bubbles came out of solution and this lifted the snake above the target level during part of the test. Never-the-less, a reasonable degree of stratification has been achieved under the circumstances.

### 3. RESULTS

Following the experimental work, the data collected from multiple experiments, have been processed using Matlab. A Matlab intelligent image processing code has been developed to detect the movement of the water snake from the videos recorded during the experiments. Fig. 5 and Fig. 9 show the temperature measured across the tank using the sixteen temperature sensors fitted vertically on the side of the tank. Fig. 5 is for the temperature measured

prior the use of the water snake while Fig. 9 is for the temperature across the tank after using the water snake. The figures show that the stratification has significantly improved when the water snake is used to supply the tank with hot and cold water. The water snake kept the water stratified and supplied each water into the exact layer that matches its temperature.

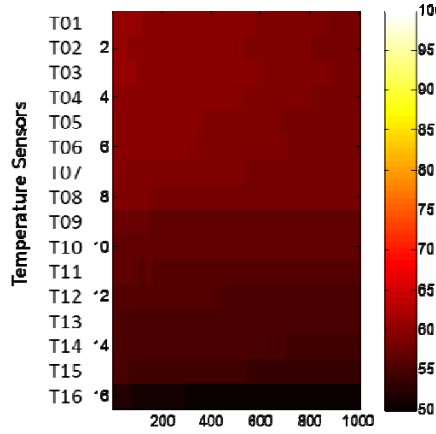

Fig. 5. The poor stratification process without the water snake.

It can be seen clearly in Fig. 6 that the figure shows that when we supply either hot water or cold water without using the water snake, the supplied water will substantially dominate the whole temperature of the water inside the storage tank. As it could be seen from the figure, the temperature across the tank did not differ much when the water snake is not used. While when the snake is used, the hot water moved to the top of the tank without mixing with the cold water and the cold water moved to the bottom of the tank without mixing with the hot water and at the end we had a perfect stratified water storage tank.

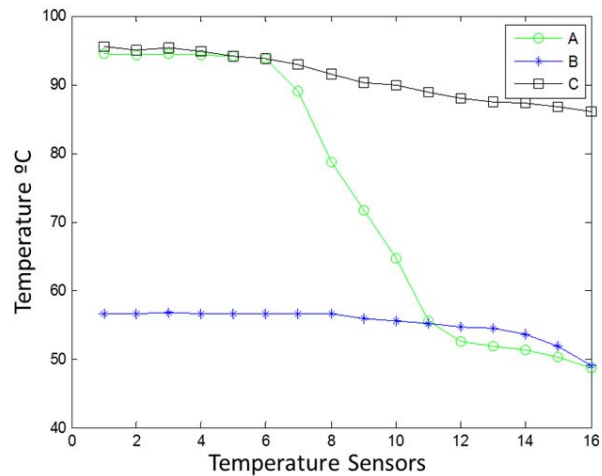

Fig. 6. Line (A) is the temperature across the tank when the water snake is used; while lines (B) and (C) are the temperatures without the water snake.

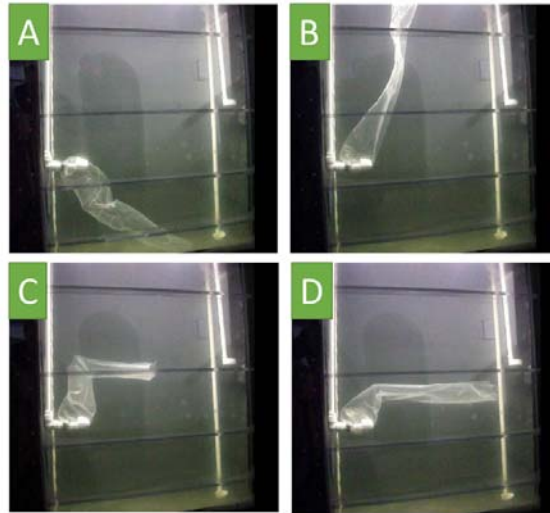

Fig. 7. Four images for the water snake in different positons during the experiment.

Fig. 7 shows how clearly that the snake moves from one layer to another based on the supplied water temperature. The images A to D in Fig. 7 are illustrated in on graph in Fig. 8.

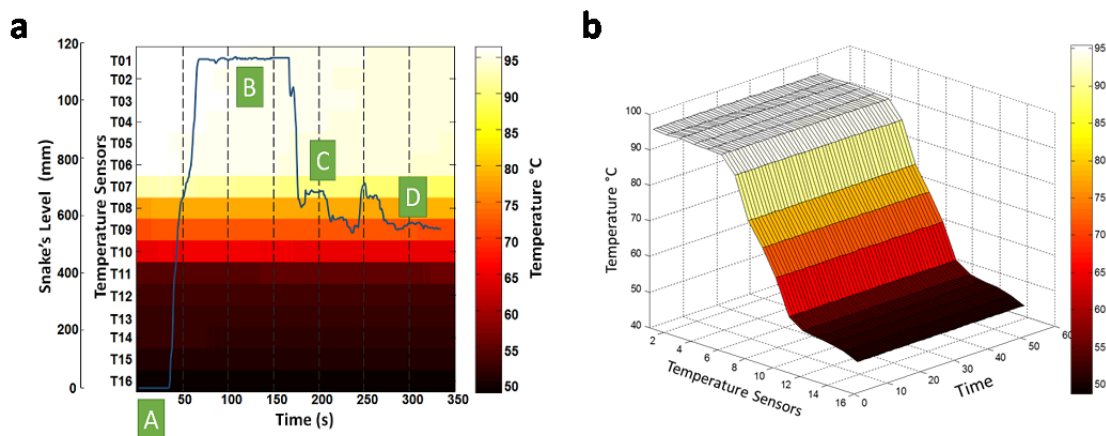

Fig. 8. The movement of the water snake inside a fully stratified tank (a); and a 3D representation for the stratification inside the tank after using the water snake (b).

Fig. 8 (a) is for the path drawn by Matlab code for the snake movement. This path represents the open end of the snake. The figure shows clearly how the water snake has led the supplied water to its correct destination layer that exactly matches with its temperature and density of the supplied water. This experiment started by supplying a cold water to the storage tank that was already stratified. The snake supplied the water to the bottom of the storage tank. After that, a hot water of above 90 °C has been supplied to the storage tank. The water snake has immediately in few seconds moved up quickly to the highest level of the tank to supply that hot water to the top of the tank. While the supply of the hot water continued for almost 120 seconds, the water snake stayed up there in stable condition. Once the supplied water changed to a colder water of about 75 °C, the water snake moved quickly to that layer of water that matched the same criteria. Some turbulence in the snake movement can be noticed in this section however, the snake remained in that layer and at the end settled in it. The stratification is clearly shown in the Fig. 8 (b) which is a 3D representation of the water temperature inside the tank.

Fig.9 shows the records of the temperature across the height of the tank taken for one complete hour (3600s) using the sixteen temperature sensors. The figure shows that the stratification process is successful using the water snake. As it can be seen in the figure, the first part, there was no stratification at all the temperature of the water in the tank ranged from 50 – 55 °C. After few minutes, the stratification started to appear clearly, whereas, the water snake used to supply hot water to the tank.

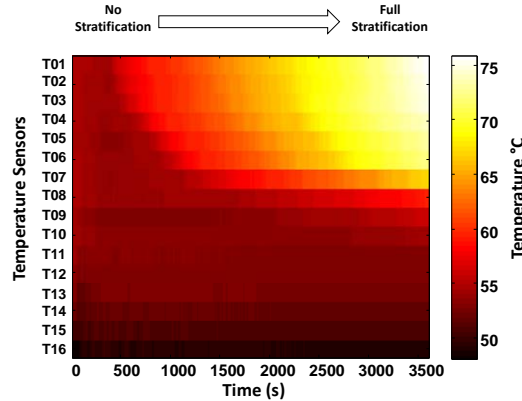

Fig.9. The progress of the stratification in an hour using water snake.

One more experiment has been carried out to confirm the previous results. This time the experiment run for a longer time with changing the supplied water temperature. Fig.10 below shows the level of the water snake's movement inside the tank, which was full of cold water at the beginning. The temperature of the water inside the tank was ranging from 20 to 25 °C. The experiment continued for more than three hours. The sequence of events for the test was as follows:

- 13:43 - Brief test to ensure the system including pump and heater stages were working correctly. This put a little heat into the top of the tank.
- 16:09 - Test started drawing water from the bottom of the tank.
- 16:47 - Draw off point changed from the bottom to 800 mm.
- 18:15 - System starts shutting off heaters as layer approaches its target of 70° C.
- 18:31 - Draw off point dropped to 480 mm with a new set point of 45° C, the three heaters stages come on again.
- 18:41 - The last heating stage drops out and the layer starts to stabilise.
- 18:45 - The set point for the heating is set high to ensure the heating restarts and all three stages remain on. The draw off point is changed back to 800 mm. This causes the Snake to rise to the top again.
- 18:48 - The draw off point is dropped back to 480 mm causing the snake to go back to the lower position.
- 18:52 - The draw off point is raised to 800 mm again. Snake rises to top.
- 18:55 - The draw off point is dropped to the bottom of the tank. Snake drops down again.
- 19:04 - The draw off point is raised to 800 mm again. Snake rises to top.
- 18:08 - The draw off point is dropped to the bottom of the tank and the target progressively dropped to 35° C. The snake drops back down low again.
- 18:25 - The last heat stage turns off leaving the pump to circulate without further heat.
- 21:19 - The pump is stopped, the test has finished.



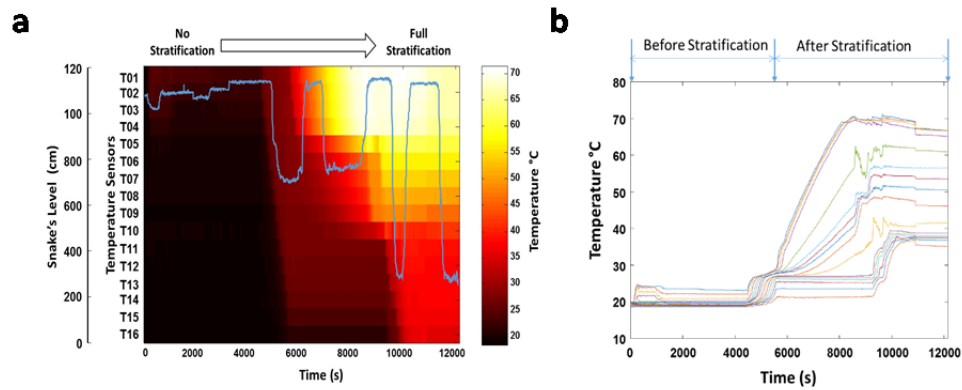

Fig.10. The movement of the water snake inside a tank from cold water to fully stratified water (a) and the temperature profile of the sixteen temperature sensors, T01– T16 (b).

Fig. 10 (a) shows the temperature from the sixteen temperature sensors. The figure shows clearly how the temperature of the water layers have varied after using supplying water of different temperatures using the water snake. (b) The temperature profile of the sixteen temperature sensors (T01 – T16).

#### 4. Thermal Images

Thermal images of the front side of the tank have been taken using FLIR B200 thermal camera. The images showed a clear stratification of the tank after using the water snake. Fig.11 presents one of multiple images taken throughout the experiment. It shows how the tank is fully stratified.

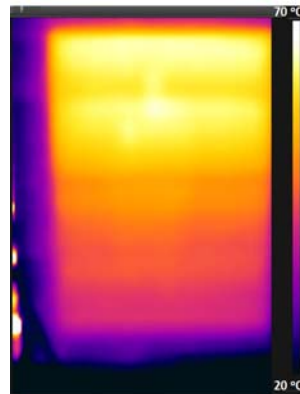

Fig.11: Infrared thermal image of the fully stratified tank taken after using the water snake.

#### 5. Conclusion

Stratification of water energy storage systems is currently attracting the attention of researchers and industry due to the need to improve energy efficiency and reduce running costs. Stratification has significant benefits for a wide range of systems including the ones that use a mixed-technology approach such as using a combination of solar energy, gas boilers, electric heaters and heat pumps. Also the technology could have a wider use in open loop systems for extracting energy from flooded coalmines and energy storage reservoirs. The use of flexible low density tube, the water snake, has been described in this paper. An automated system is used to test the capability of the technology. The use of the automated test rig has been found successful in evaluating the water snake technology. It has proved that the water snake is working perfectly in supplying the water to its exact layer that matches its temperature and density, hence achieving a high level of stratification.

## 6. Future work

Future work will include the development and testing of the system in residential and commercial environments where different technologies for heating are integrated such as solar, thermal heat pump and boiler. It will also include carrying out experimental work on the same rig to evaluate the use of two or more water snakes in one tank and supplying water from two or more different sources with different temperatures. The use of different types of material for the water snake and carrying out comparative studies to evaluate the best material that will optimise the performance of the water snake will be also investigated. The effect of the length of the water snake and the size of the tank will be investigated in the future. Finally, the use of the water snake in open loop energy systems from flooded coalmines will be investigated further to evaluate the suitability of the technology for such applications.

## Acknowledgements

This paper is based on research work partially carried out within the frame of research project: Low-Carbon After-Life (LoCAL) financed by the European Commission, Research Fund for Coal and Steel, July 2014–June 2017 (Contract No.: RFCR-CT-2014-00001). The development of the test rig is partially funded by The Future Factory at Nottingham Trent University and the European Regional Development Fund.

## References:

- [1] D. Zhou et al., "Technology Roadmap," SpringerReference, vol. 92, no. January, p. 24, 2013.
- [2] A. P. Athresh, A. Al-Habaibeh, and K. Parker, "Innovative Approach for Heating of Buildings Using Water from a Flooded Coal Mine Through an Open Loop Based Single Shaft GSHP System," *Energy Procedia*, vol. 75, no. 0, pp. 1221–1228, 2015.
- [3] A. Al-Habaibeh, B. Meyerowitz, Duolan, and A. Athresh, "The Design and Development of an Innovative Simulator for an Open Loop System for Extracting Energy from Flooded Coal Mines," *Energy Procedia*, vol. 75, no. 0, pp. 1470–1476, 2015.
- [4] Y. M. Han, R. Z. Wang, and Y. J. Dai, "Thermal stratification within the water tank," *Renew. Sustain. Energy Rev.*, vol. 13, no. 5, pp. 1014–1026, 2009.
- [5] Vijay Dwivedi, "Thermal Modelling and Control of Domestic Hot Water Tank," Thesis, no. 200858672, 2009.
- [6] S. Fanshawe, A. Al-Habaibeh, and B. Shakmak, "An innovative design and evaluation of a stratified hot water storage system-the Water Snake," 2015 IEEE Jordan Conf. Appl. Electr. Eng. Comput. Technol. AEECT 2015, pp. 1–6, 2015.
- [7] M. Y. Haller, C. A. Cruickshank, W. Streicher, S. J. Harrison, E. Andersen, and S. Furbo, "Methods to determine stratification efficiency of thermal energy storage processes - Review and theoretical comparison," *Sol. Energy*, vol. 83, no. 10, pp. 1847–1860, 2009.



### Biography

Professor Amin Al-Habaibeh is a professor of Intelligent Engineering Systems within the Product Design team at Nottingham Trent University. He is currently the director of DTA-Energy at University Alliance; and leading the Innovative and Sustainable Built Environment Technologies research group (iSBET) at Nottingham Trent University. Amin's interest also includes condition monitoring, intelligent systems, sustainable technologies, product design and advanced manufacturing technologies.