



Panagiotou, Konstantina and Klumpner, Christian and Sumner, M. (2017) Being a member of an energy community: assessing the financial benefits for end-users and management authority. In: 2017 IEEE International Symposium on Industrial Electronics (ISIE 2017), 19-21 June 2017, Edinburgh, UK.

Access from the University of Nottingham repository:

http://eprints.nottingham.ac.uk/42605/2/ISIE_2017_FINAL_paper.pdf

Copyright and reuse:

The Nottingham ePrints service makes this work by researchers of the University of Nottingham available open access under the following conditions.

This article is made available under the University of Nottingham End User licence and may be reused according to the conditions of the licence. For more details see:
http://eprints.nottingham.ac.uk/end_user_agreement.pdf

A note on versions:

The version presented here may differ from the published version or from the version of record. If you wish to cite this item you are advised to consult the publisher's version. Please see the repository url above for details on accessing the published version and note that access may require a subscription.

For more information, please contact eprints@nottingham.ac.uk

Being a Member of an Energy Community:

Assessing the Financial Benefits for End-users and Management Authority

Konstantina Panagiotou

Power Electronics, Machines and
Control (PEMC) Research Group
The University of Nottingham
Nottingham, UK

konstantina.panagiotou@nottingham.ac.uk

Christian Klumpner

Power Electronics, Machines and
Control (PEMC) Research Group
The University of Nottingham
Nottingham, UK

christian.klumpner@nottingham.ac.uk

Mark Sumner

Power Electronics, Machines and
Control (PEMC) Research Group
The University of Nottingham
Nottingham, UK

mark.sumner@nottingham.ac.uk

Abstract — Since 2011, in the context of sustainable development, UK government has been encouraging individuals to work as groups, and now, more than 5,000 community led projects are sprouted across the country, since more than 50% of the UK citizens had expressed their interest to get involved with energy communities if they can potentially reduce their electricity cost. The aim of this study is to quantify the financial benefits for end-users and energy management authority when an energy community is settled up. By simulating possible operating scenarios and by observing and assuming a cost effective power flow/exchange between the individuals, the communal energy storage and the power grid, the finances of each scenario were quantified. Consequently, the electricity cost for the end-users and the incomes for the management authority were monitored and the most financially suitable community energy storage along with the PV penetration were identified.

Keywords— Decentralized Generation, Energy Flow Management.

I. INTRODUCTION

A power system must continuously ensure a balanced match between the power demand and the generation, as it needs to generate electric power according to the consumption needs. While no differences between the production and consumption are acceptable, a single disorder can cause instability to the whole system [1]. A promising source of integrity and flexibility could be the decentralised energy (DE) and energy storage (ES). By combining local generation and the ability to manage demand, DE systems can significantly reduce the reliance on the central grid network [2] and ‘open new horizons’ to the liberation of the existing power grid.

Further, since UK government has been encouraging individuals to work as a group, within the last 5 years, more than 5,000 community led projects have been sprouting across UK, as a significant proportion of consumers expressed desire to get involved in an energy community if they could reduce the electricity cost [3]. For this work, the term ‘energy community’ can be defined as a group of neighbouring domestic dwellings, from which some of them have their own PV installations and are able to trade the excess power in a hierarchical way: first, within the community, after with the community energy storage (CES) and only lastly export it to the power grid. By setting up a convenient energy price scheme, it is possible to maximise local consumption of PV energy produced and to minimise the energy cost for the

consumers but also produce financial income for the community management system operator that could also pay for the installation and maintenance of the hardware.

In nearby future, customers can to be more engaged with their electricity consumption and also to become prosumers (act as consumer and supplier), since smart meters, coupled with smart appliances and connected homes will offer a better control over the energy usage and generation. Four are the types of energy activities for the examined energy community: (i) *generating energy* (PV installations at community houses), (ii) *reduction of energy use* (minimizing the transmission losses and maximizing the efficiency by controlling the energy flow), (iii) *managing energy* (balancing supply and demand) and (iv) *purchasing energy* (collective purchasing and trading within the community members and the power grid).

Energy storage has already been investigated and shown that it has the potential to increase the robustness and reliability of energy systems, to reduce the price volatility in electricity market with govern the price structure and to deliver renewable generation to loads [4], [5]. Technology-based systems modelling which can combine the necessary temporal granularity to accurately represents ES is essential [6]. In this research study, a domestic installation was chosen to be examined since ES often has its greatest value to the power system when it is placed closest to the source of demand rather than at the transmission or at distribution level [7]. Fig. 1 illustrates the scale of the examined community, ranging from a single house to distribution level.

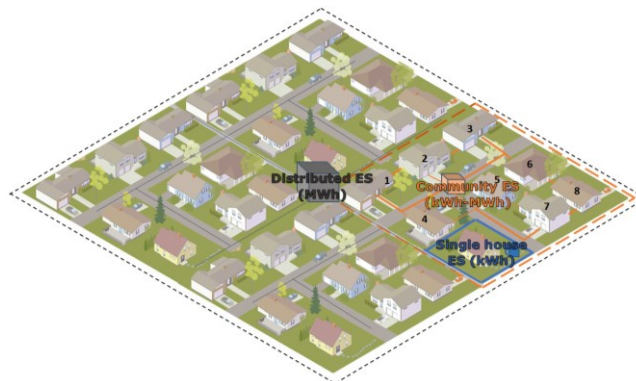

Fig. 1: Scale of the examined community, ranging from a single house energy storage (ES) to distribution level

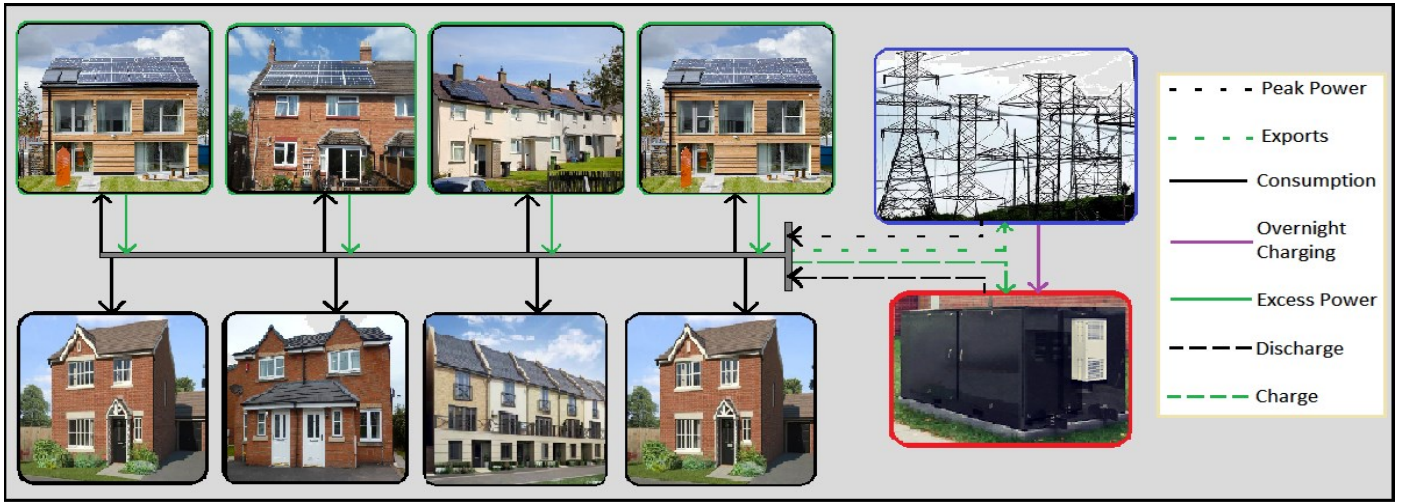

Fig. 2. Schematic representation of the examined community for a 50% PV penetration (energy flow among houses, community energy storage and power grid)

II. METHODOLOGY

This study uses real consumption profiles for an 8-house neighbourhood situated in Midlands, UK [8]. The PV power generation profile of a 3.8kWh PV system that occupies the full roof space of a terrace house in the same region [9] was used as the benchmark and based on this, the rest houses, depending on their type (detached, semi-detached or terrace) and hence, the corresponding available roof size, the generated power was adapted accordingly [10]. Fig.2 illustrates the representation of the examined community and the potential power flow between the houses, the CES and the power grid.

Various scenarios were simulated and the power flow within the energy community was observed in order to quantify the electricity cost for the end-users and the incomes for the utility which manages the community project. Table I summarises the constructed scenarios. Scenario 6, which indicates the completely functional community case, includes the power generation due to PV installations, the trading of excess power within the houses, a realistic pricing schemes for each house depending on its particularities (Economy7¹ or constant electricity pricing tariff), the availability of a CES which can charge from the excess PV energy that is not consumed by inter-trading and also from cheap off-peak overnight electricity, and the connection to power grid which can satisfy any extra consumption and also to enable the purchase of the excess PV generated power that is not stored.

The main goal of the examined energy community is to provide the minimum possible electricity cost to its members. In order to achieve this, the action priority which was followed can be seen in the flow diagram of Fig.3. Each community house with installed PV can act as prosumer (be consumer and supplier in a given time interval). Further, if the house is using Economy7, the price priority will diversify

¹Economy7 pricing scheme is an available UK electricity tariff, for which between 00:00 and 07:00 of each day of the year, the price per kWh is almost 4 times less than for the rest hours during the day.

from the members who are using the single tariff as purchasing electricity during the off-peak time is the cheapest possible option. Moreover, in order to provide financial incomes to the utility which runs the energy community system, the charging benefit is lower than the discharging tariff. Additionally, to minimize the transmission losses, trading within the community members gives a greater financial return rather than to charge or discharge the CES. Lastly, purchasing at peak tariff from or exporting the excess to the power grid at lowest tariff is the last option for the community, since the average pricing and the peak tariff are higher than discharging the CES or purchasing excess PV energy from the neighbours, and on the other hand, the incomes for exporting to the power grid are less than charging the communal battery or trading among the rest members.

Each scenario was simulated and run for a whole week of each season and the energy flow within the end-users, the CES and the power grid was calculated in order to quantify the electricity cost for the end-users and the incomes for the management utility (if applicable). Different levels of PV penetrations and communal battery capacities were considered to enable in-depth analysis of the various interdependencies and also to determine threshold levels where trends change. Finally, comparisons between the different possible cases considered were performed to understand the relevance of the key system adjustments.

TABLE I: IMPLEMENTED SCENARIOS

S C E N A R I O S		PV	Individual house ES	Trading	Community ES	Overnight charging
		1	X	X	X	X
2	✓	X	X	X	X	
3	✓	✓	X	X	✓	
4	✓	X	✓	X	X	
5	✓	X	✓	✓	X	
6	✓	X	✓	✓	✓	

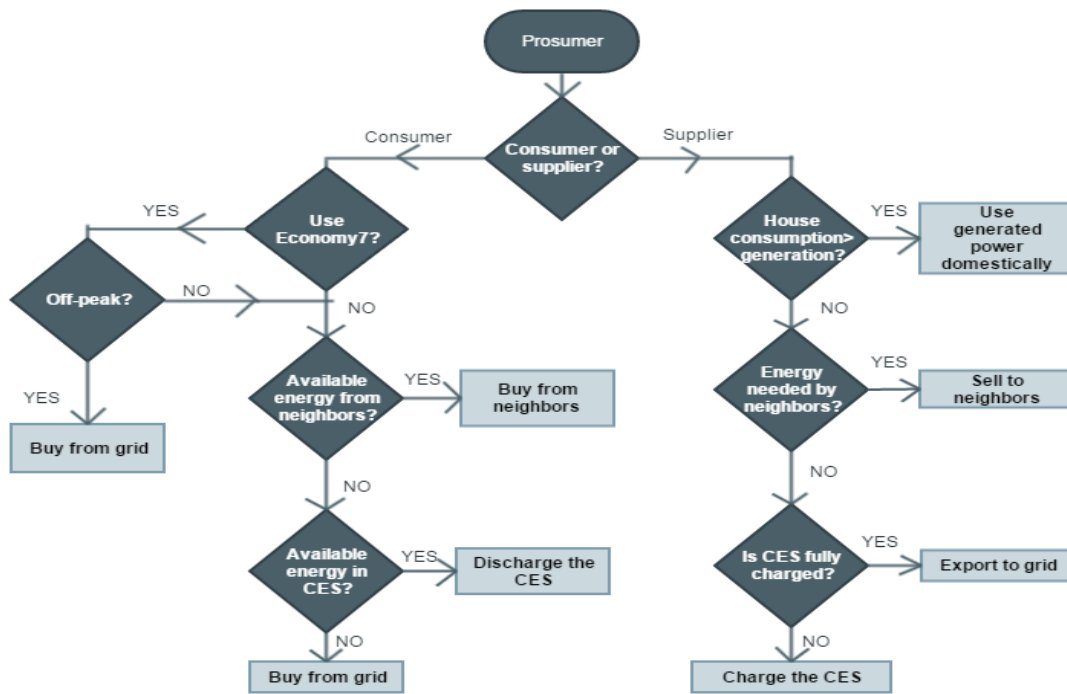

Fig. 3. Action priority for the energy community members/prosumers

III. MODELLING OF COMMUNAL ENERGY STORAGE

A. Model used

Several battery models already exist in the literature. Most of them are not well suited to be combined with a performance model [11]. Electrochemical models, which are the most accurate ones, are too complex for the required purposes. Mathematical, stochastic and analytic models are too limited. Electric-circuit models were considered to be the most suitable ones for this case, as they have a suitable level of complexity, without compromising performance [12], [13]. The type of the battery which was assumed to be installed as the CES for the examined community was the lead-acid, for its low cost, long track record of safety and positive public acceptance [6, 14, and 15]. The model used in this paper was the Rint, as it was concluded that the most suitable model for representing community storage must be relatively simple but must capture the significant aspects of the battery's behaviour.

The electric-circuit model implemented consists of a variable voltage source, in series with an internal resistance. The voltage source is linearly dependent on the state of charge (SOC) of the battery, whereas the internal resistance is adjusted to be inversely proportional with the battery size (its initial value was the one provided by the manufacturers in battery datasheets [16]). For validation of the battery model used, experiments were conducted in lab conditions to quantify the deviation of the battery parameters considered. The results of characterization of the relationship between voltage and SOC, as well as the simulated curves are shown in Fig. 4. The initial relationship between the open circuit voltage and the SOC was found from the manufactured sheets

(light blue dashed line in Fig.4). However, after conducting charge/discharge experiments on an equipment dedicated for characterising electrochemical devices, the model was revised and the relationship between the two aforementioned parameters was found to follow the red dashed line of Fig. 4. Further, after implementing electro-scope impedance spectroscopy for SOC's between 10% and 100% (with step of 10%), the internal resistance was found to be variable and be highly depended on the SOC for frequencies below $\sim 10\text{mHz}$, as illustrated in Fig.5.

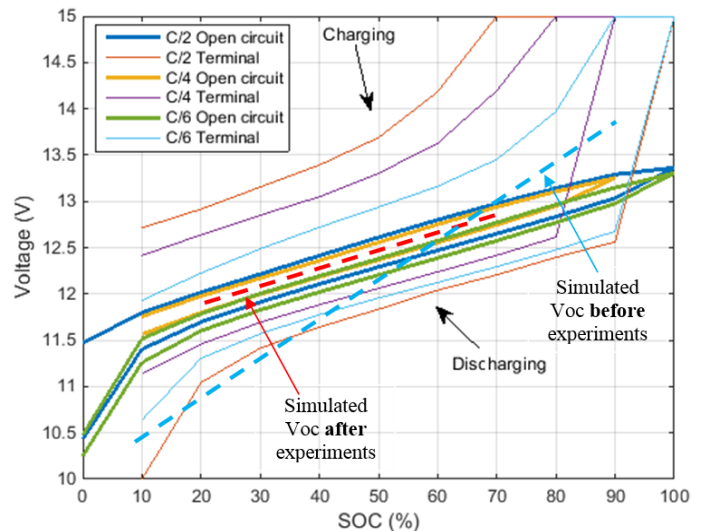

Fig. 4. Voltage (open circuit (Voc) and terminal) vs state of charge (SOC)

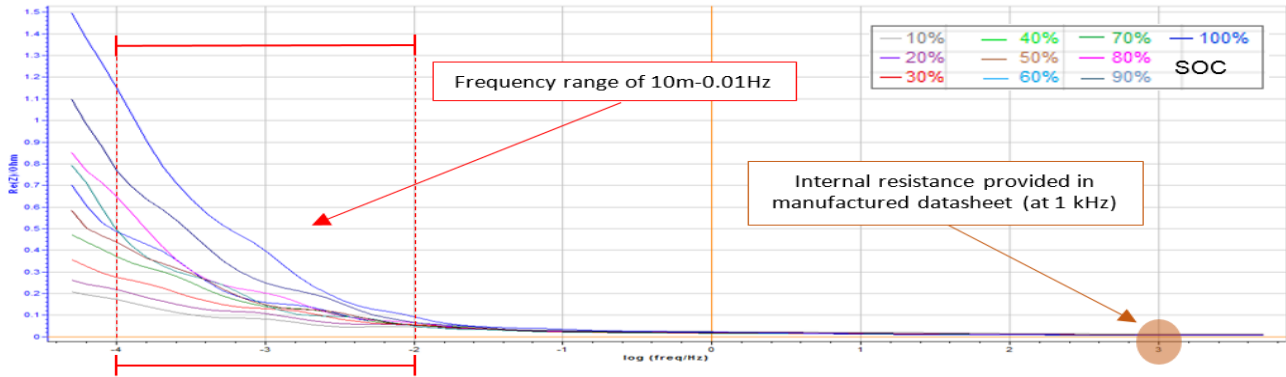

Fig. 5. Electrochemical impedance spectroscopy for state of charge (SOC) between 10 and 100% (33Ah-12V lead-acid battery)

From a series of additional experiments, the SOC limits for the implemented model chosen to be 20-70%, as within this range lead-acid batteries have linear behaviour and to last longer, this type needs to operate within a 50% range of SOC [2]. To make sure that the battery lifetime is not affected by the way it is exploited, the charging/discharging currents were limited to $C/4$ (C : nominal battery capacity), as above this value, the battery behaviour is non-linear and difficult to predict. The internal resistance was used as the one provided in the datasheet by the manufactures, as the examined system does not operate for frequencies below 10mHz. By taking the aforementioned limitations into consideration, the electric-circuit model used is represented in Fig. 6.

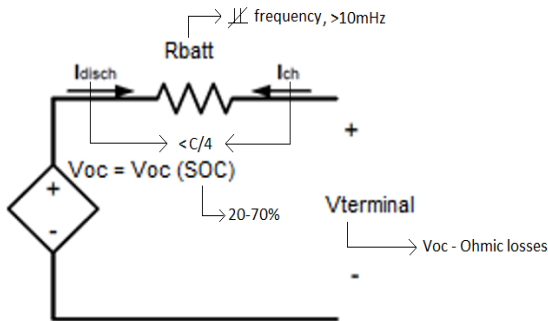

Fig. 6. Equivalent battery electric-circuit used

B. Charging patterns

To examine the impact of an additional financial benefit, for specific implemented scenarios (3 and 6 of Table I), CES charges from the grid during the off-peak tariff (00:00-07:00 every day), in addition to the PV excess power, if the control

algorithm that utilises the CES operation requires it. Via the overnight charging, the CES takes advantage of the ‘cheap’ electricity which is returned to the community members during the peak tariff. The overnight charging level strongly affects the charging pattern of the battery leading to unwanted situations: if battery is not sufficiently charged during off-peak time and the day ahead is cloudy, the ES will probably be fully discharged before the end of the peak period and peak electricity will need to be purchased. On the other hand, if the overnight charge level is too high and the day ahead is sunny, the ES will be fully charged and any excess PV energy must be exported to grid at the smallest price.

For this work, two control algorithms (CA) were simulated; a constant SOC level aimed for the end of the overnight charging and an intelligent one, namely ‘One day before adjusted’ CA. This CA as explained in [18], ‘observes’ the charging pattern of the previous day and according to previous’ day exports and peak purchased energy, it either reduces or increases the charging level respectively. Fig. 7 presents the charging pattern of the CES for the constant charge CA for two overnight charging levels: for the two extreme cases, i.e. the minimum charging used (30% SOC) and the fully overnight (70% SOC), for s week during winter and spring.

Additionally to the possibility to adjust the overnight charging level, the change of the ES size can significantly affect the charging pattern and hence, the power flow within the community, as for larger sizes, the amount of time the ES is out of use because it reached the SOC limits is shorter than for smaller batteries. To highlight this, Fig. 8, illustrates the charging patterns for a small (18.6kWh – 1,550Ah) and a large (120kWh – 10,000Ah) battery.

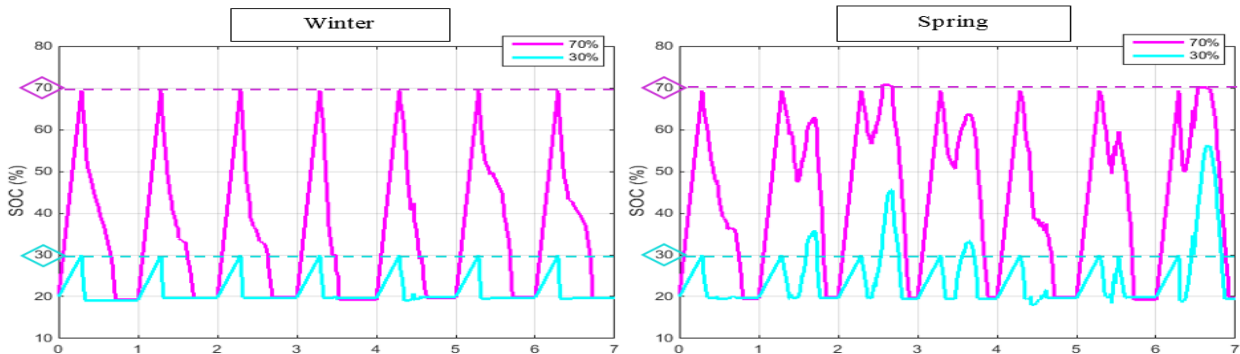

Fig. 7. Charging patterns for one week during winter and spring for different overnight charging levels (capacity: 18.6kWh, constant charging control algorithm)

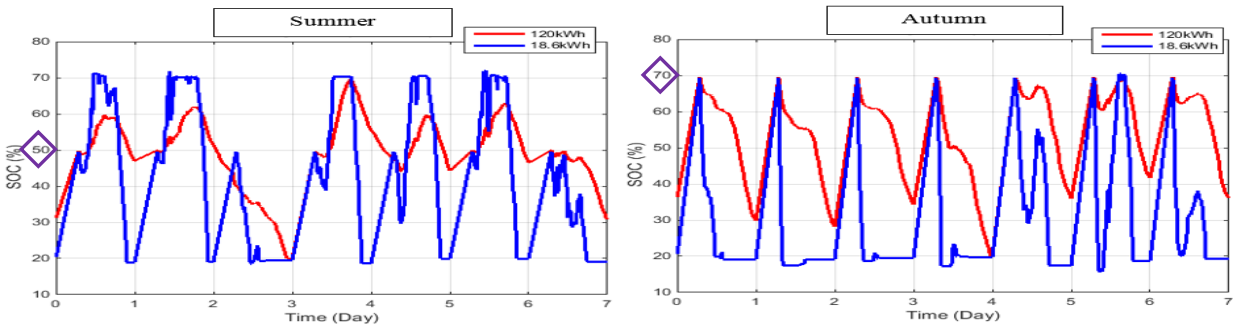

Fig. 8. Charging patterns for one week during autumn and summer for different community energy storage capacities (50% and 70% SOC overnight charging level)

IV. SIMULATION RESULTS AND EVALUATION

A. Initialising PV penetration and CES capacity

For the beginning of this study, a PV penetration level of 37.5% was considered as the starting point. In more detail, it was assumed that 3 out of the 8 community houses have installed PVs on their roofs, and the electricity cost for the end-users, along with the percentage reduction of their bill (compared to scenario 1: act individually without installed PVs) as well as the profits for the local authority which manages and controls the energy flow (if it is applicable) are shown in Table II. Overall, it can be concluded that for this particular case, if an end-user is member of complete functional energy community (scenario 6), can achieve a reduction of an approx. 31% on its electricity cost. On the other hand, if the CES charges overnight by a constant level, the financial benefits for the end-users are not significant, but the increase of the EC operator profits is remarkable (3 times more than when not having overnight charge).

It was highlighted previously that in order to suggest and provide guidance for the optimal energy flow among the members, the CES and the grid, the battery capacity must be well defined. Fig. 9 demonstrates the impact of CES capacity on the average end-users' electricity cost, on the utility's incomes and on the exports, for the aforementioned PV penetration. From the figure, it can be shown that the relationship between the battery size and the end-users' bill is an exponential decay; after a specific battery capacity, the reduction of the energy cost is negligible. On the other hand, the incomes for the utility increases with the increase of the CES size, but again, after the same battery size, the increase is insignificant. As a coincidence, for this particular PV penetration, the installation of a CES larger than 120kWh will not provide any additional financial benefit to both the end-users and to the utility which operates the energy community.

TABLE II: SUMMARY OF FINANCIAL RESULTS (37.5%PV PENETRATION)

SCENARIOS	1	2	3	4	5	6
Avg. end-user energy cost	£37.49	£30.87	£28.21	£28.02	£26.34	£25.72
Percentage reduction	N/A	17.67%	24.75%	25.29%	29.76%	31.40%
Profit for CES operator	N/A	N/A	N/A	N/A	£9.37	£28.63

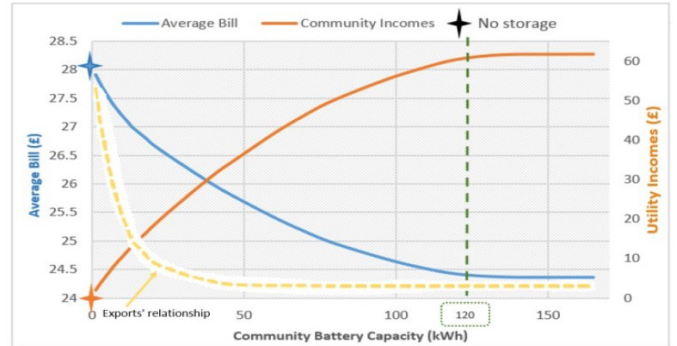

Fig. 9. Average end-users electricity cost and utility incomes vs CES size

B. Variable PV penetration and CES capacity

To understand the impact of the PV penetration on the finances of the examined energy community, the number of houses assumed to have installed PV systems on their roof varies. Also, two overnight charging control algorithms were simulated and run, to help derive the design recommendations for an energy community considering a wide range of configuration variability. So, the 6 aforementioned scenarios (explained in Table I) were implemented for variable PV penetration (0 - 100%). The electricity cost for the community members along with the income for the community management were monitored. Fig. 10 illustrates the outcomes of scenarios 1, 2, 3 and 4, and more specifically, the electricity cost for the average end-user for 4 weeks (one week of each season) in relation to the PV percentage penetration. Further, Figs. 11a&b and 12a&b compare the average end-users electricity cost and the incomes for the utility respectively (Fig. 12a shows the cumulated 2D graphs whereas in Fig 12b, the 3D graphs are separately shown: for scenarios 4, 5 and 6A&B (6A is scenario 6 with constant overnight charging control algorithm and 6B with intelligent control algorithm)).

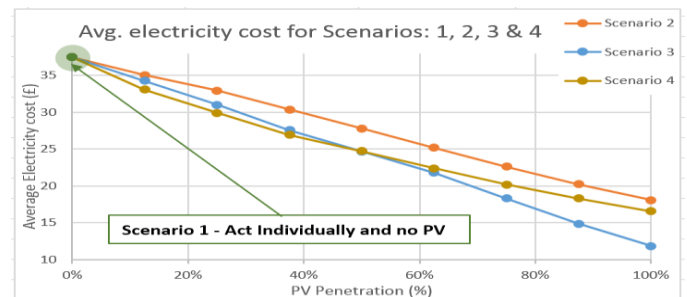

Fig. 10. Avg. end-users electricity cost vs PV penetration for Scenarios 1, 2, 3 & 4

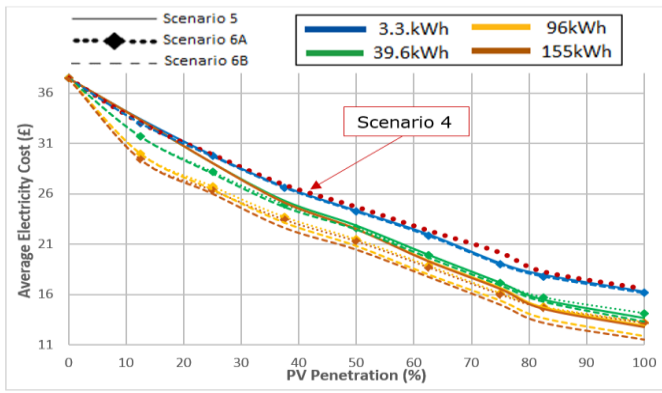

Fig. 11a. Avg. end-user electricity cost vs PV penetration for Scenarios 4, 5 & 6A, B

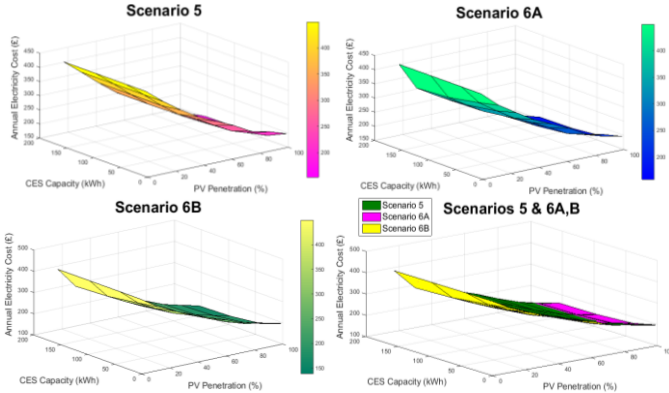

Fig. 11b. Avg. end-user electricity cost vs PV penetration for Scenarios 4, 5 & 6A, B

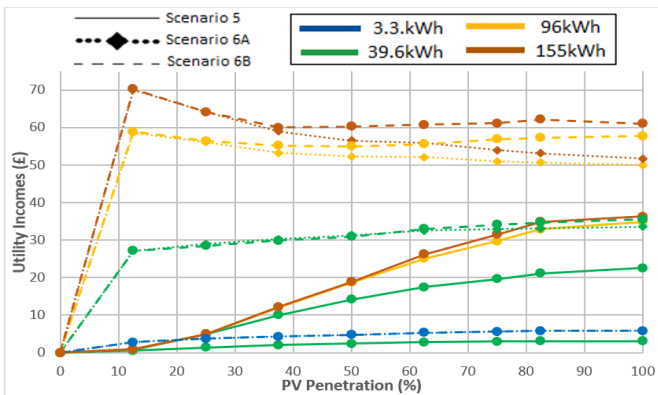

Fig. 12a. Utility incomes vs PV penetration for Scenarios 4, 5 & 6A, B

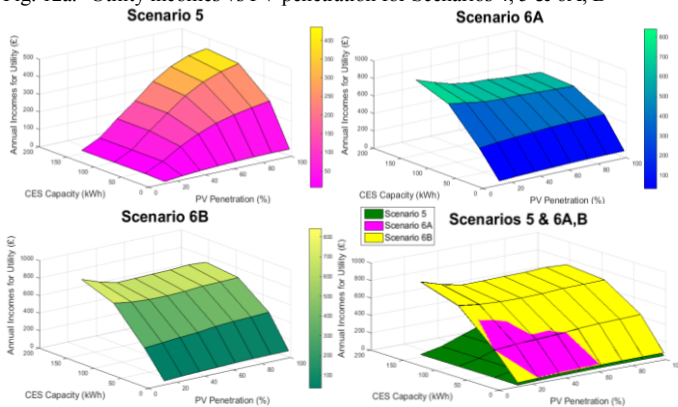

Fig. 12b. Utility incomes vs PV penetration for Scenarios 4, 5 & 6A, B

Hence, from Figs. 11 & 12 it can be concluded that, by varying the PV penetration within the community, it can preliminary observed that the decrease of the electricity cost for the end-users and the increase of the management income are not proportional to the PV penetration or to CES capacity. More specifically, the benefits by increasing the PV percentage from 0 to 12.5% are the greatest whereas from 87.5 to 100% are the lowest, regardless the battery size or the control algorithm. Also, an advanced control algorithm which controls the overnight charging level for the communal battery does not provide any benefit for small battery sizes or small-scaled PV generation. Finally, Fig.13 summarises the yearly benefits for the community (electricity cost reduction for the end-users plus the management authority's incomes) for all the examined scenarios compared to the case when end-users work as individuals and they do not have installed PVs (Scenario 1).

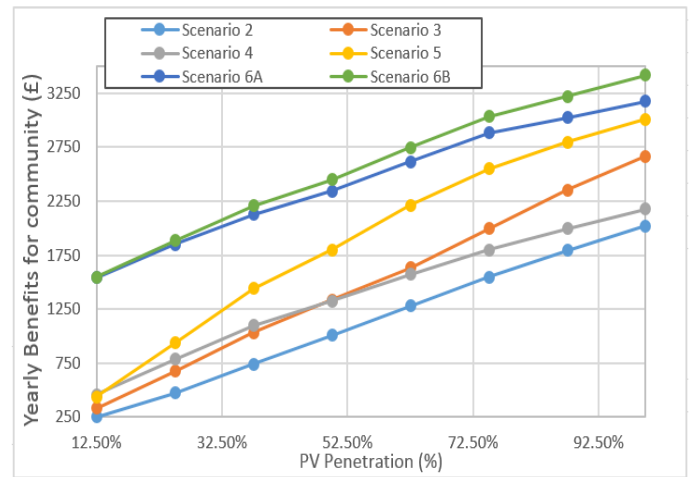

Fig. 13. Yearly community benefits for all scenarios (CES capacity: 96kWh)

V. CONCLUSIONS

Technology-based systems models which can accurately represent energy communities is essential, in order to quantify the financial profits for being member of an energy community. The energy flow between the end-users, the community energy storage and the power grid must be monitored in order to determine the optimal action priority. Acting as a prosumer (being consumer and supplier) within an energy community can certainly allow the accomplishment of significant electricity cost reduction, as for a PV penetration of 3/8 within a complete functional energy community, an approx. 31% average end-user reduction was achieved. Apart of the community members, the community management company can benefit, as significant incomes can be accomplished, especially when the CES charges during the off-peak electricity tariff.

In order to provide guidance and recommendations for the optimal community energy flow of a specific neighborhood, in addition to the most suitable PV penetration within the community, the communal battery capacity along with the overnight charging level of the

community energy storage must be well defined. By varying the PV penetration within the community, the decrease of the electricity cost for the end-users and the increase of the management incomes are not proportional to the PV penetration or to CES capacity. It was proved that, the increase of the CES capacity above a certain size (120kWh for this particular neighborhood), it would not lead to any additional financial benefits to either the end-users or to management authority.

Lastly, by adding the financial benefits of both end-users and authority, it was proved that the case which describes the complete functional energy community (Scenario 6B) provides the greatest yearly benefit. Finally, if a neighbourhood is transformed into an energy community, significant financial benefits will certainly be accomplished, as for this particular application, over one year period, from £350 to £3,200 can be saved for the community (depending on PV penetration, CES capacity and control algorithm).

VI. FUTURE WORK

Future work can be seen as the inclusion of a more detailed model for representing the community energy storage. The losses of the power converter which processes the power to the communal battery could be taken into consideration for further increase of the model complexity. Thus, by adding a more complex community energy storage model, and hence, by accounting for the power losses of the examined system, modifications on the optimal community energy flow can be done, as the action priority will be modified with the introduction of a non-ideal converter with stand-by losses and cut-off power.

REFERENCES

- [1] Energy UK (2016) 'Pathways for the GB Electricity Sector to 2030', Available Online.
- [2] Department of Energy & Climate Change, gov.uk (2013) 'Smart meter communication licence.', Available Online.
- [3] Department of Energy & Climate Change. (2014) 'Community Energy Strategy: People Powering Change.', Available Online.
- [4] Anuta et all. (2014) An international review of the implications of regulatory and electricity market structures on the emergence of grid scale electricity storage. Renewable and Sustainable Energy Reviews.
- [5] J. Makansi and J. Abboud. (2002) Energy storage: the missing link in the electricity value chain. Energy Storage Council White Paper.
- [6] Center for Low Carbon Futures (2012) Pathways for energy storage in the UK, Available Online.
- [7] Rocky Mountain Institute (2015) The economics of battery energy storage. Executive summary.
- [8] Consumption data used for Crest model (over one year, 1-minute sample resolution), Midlands, UK. (2009)
- [9] PVoutput.org, Trowell, UK. (2013) Available Online.
- [10] energy saving trust.org.uk, (2015) 'Solar Energy Calculator Sizing Guide', Available Online.
- [11] Jongerden, M.R. & Haverkort, B.R. (2008) Battery Modelling.
- [12] Shuhui, Li. Bao, Ke. (2011) Study of battery modeling using mathematical and circuit oriented approaches. Power and Energy Society General Meeting, IEEE. 1-8.
- [13] Robyn A, Jackey. (2007) A Simple, Effective Lead-Acid Battery Modeling Process for Electrical System Component Selection.
- [14] Jackey R.A.: A Simple. (2007) Effective Lead-Acid Battery Modeling Process for Electrical System Component Selection, The MathWorks.
- [15] Hoffman MG., et al. (2010) Analysis Tools for Sizing and Placement of Energy Storage in Grid Applications: A Literature Review, U.S. department of Energy.
- [16] Leoch Company: OCV VS Capacity, Datasheet for a 12V-33Ah deep cycle Lead-Acid Battery.
- [17] K. Panagiotou, C. Klumpner, M. Sumner (2016) The effect of including power converter losses when modelling energy storage systems: A UK domestic study. 18th European Conference on Power Electronics and Applications (EPE'16 ECCE Europe.