

DEFLECTION OF CONCRETE SLABS
CURRENT PERFORMANCE & DESIGN DEFLECTION LIMITS

SHIVAN TOVI

A thesis submitted in partial fulfilment of the
requirements of The University of West London
for degree of Doctor of Philosophy

This research programme was carried out
in collaboration with the Concrete Centre

February 2017

Declaration of Authorship

I, Shivan Tovi, affirm that this thesis submitted to the University of West London is my own work of research. Contributions have been referenced or acknowledged accordingly.

Abstract

Thesis title: Deflection of Concrete Slabs
Current Performance & Design Deflection Limits

Degree: Doctor of Philosophy

Author: Shivan Tovi

Date: February 2017

Deflection is usually controlled by limiting the span/depth ratio. One aspect of this research is to document the deflection of a concrete slab in a large residential block. The other part of the research is to look at current design limits. Limits on deformation were set many decades ago, when the forms of construction, partitions, finishing, cladding and service were very different from what they are now. Part of that is to review the span-to-depth method of design.

Site investigation and testing theory through observation and data collection was the main deductive approach of this research. A quantitative method was used to calculate and determine the deflection on concrete slabs, the research is attempted to identify target companies and projects to participate in the research. The data indicate that the slab has not sagged significantly due to the back propping for 30 days. However, it does seem that the slab was sloping down from the corner by 6 mm diagonally across the 12m bay. A margin of deflection around 2mm occurred especially in the mid-span of the slab 12 x 7 m corner bay. The 2 mm deflection occurred at the beginning of the investigation after back propping reinforced concrete corner bay slab. The back propping applied after 7 days of pouring slab.

Keywords: Slab deflection, design for serviceability limit state, span/depth ratio, Eurocode 2 design code.

Table of Contents

| | |
|--|-----------|
| Declaration of Authorship..... | ii |
| Abstract | iii |
| Table of Contents..... | iv |
| List of Figures..... | ix |
| List of Tables..... | xii |
| Acknowledgements..... | xx |
| Dedication | xxi |
| List of Publications Arising from this Thesis..... | xxii |
| CHAPTER ONE: Introduction to Deflection on Slabs..... | 23 |
| 1.2 General..... | 27 |
| 1.3 Research Aims, Questions and Objectives..... | 34 |
| 1.3.1 Aims..... | 34 |
| 1.3.2 Research Questions..... | 35 |
| 1.3.3 Objectives | 35 |
| 1.4 Eurocode Group | 35 |
| 1.4.1 Eurocode 2..... | 36 |
| 1.5 Eurocode 2 Deflection Design and Analysis..... | 38 |
| 1.6 Factors Affecting Deflection..... | 39 |
| 1.6.1 Creep | 40 |
| 1.6.2 Tensile Strength | 40 |
| 1.6.3 Elastic Modulus | 41 |
| 1.6.4 Cracking | 42 |
| 1.6.5 Shrinkage Curvature | 43 |
| 1.6.6 Loading Succession..... | 43 |
| 1.7 Deflection Checking Methods..... | 44 |
| 1.8 Deflection Calculation Methods | 46 |
| 1.8.1 Rigorous Method..... | 46 |
| 1.8.2 Simplified Method | 46 |
| 1.9 Research Structure..... | 47 |
| 1.10 Research Contribution..... | 48 |
| CHAPTER TWO: Literature Review of Deflection of Slabs | 51 |
| 2.1 Deflection of Slabs..... | 51 |
| 2.1.1 Instantaneous Deflections..... | 52 |

| | |
|--|------------|
| 2.1.2 Long Duration Deflections..... | 54 |
| 2.2 Maximum Deflection | 55 |
| 2.3 Cracking Impact on Concrete Slabs..... | 58 |
| 2.4 Deflection Calculation | 60 |
| 2.5 Design Code Limitations for Deflection | 64 |
| 2.6 Compendium | 66 |
| 2.7 Shortening of Columns..... | 67 |
| 2.8 Precamber | 69 |
| 2.9 Accuracy of Eurocode 2 | 70 |
| 2.10 Flat Slabs..... | 70 |
| 2.11 Cladding Allowances | 71 |
| 2.12 Combined Reaction | 72 |
| 2.13 Strain and Stress Relationships..... | 75 |
| 2.14 Concrete | 75 |
| 2.15 Steel..... | 77 |
| 2.16 Shrinkage of Concrete and Hydration..... | 78 |
| 2.16.1 Restrain Shrinkage and Stress Calculation..... | 80 |
| 2.16.2 Fully Restrained Shrinkage and Stress Calculation..... | 82 |
| 2.16.3 Elastic Modulus of Concrete..... | 83 |
| 2.17 Thermal Behaviour of Concrete and Steel | 86 |
| 2.18 Creep | 87 |
| 2.19 Concrete Specification | 88 |
| 2.20 Steel Specification | 91 |
| 2.21 Structural Analysis at the Limit State | 93 |
| 2.21.1 Permanent loads | 95 |
| 2.21.2 Variable Loads..... | 96 |
| 2.22 Summary | 97 |
| CHAPTER THREE: Methodology and Site Investigation | 100 |
| 3.1 Introduction..... | 100 |
| 3.2 Various Methods for Measuring Deflection..... | 101 |
| 3.2.1 Precise Levelling..... | 105 |
| 3.2.2 Hydrostatic Cells Levelling (HCL) Method | 112 |
| 3.2.3 Shape Accel Array (SAA) Method..... | 129 |
| 3.2.4 Optical Fibre Method..... | 131 |

| | |
|---|-----|
| 3.3 Planned Sequence of Tasks | 131 |
| 3.3.1 Authorisation | 132 |
| 3.3.2 Quality Requirements | 132 |
| 3.3.3 Materials | 133 |
| 3.2.4 Tools | 133 |
| 3.3.5 Plant | 134 |
| 3.4 HLC’s Calibration Certificate | 134 |
| 3.5 Striking of Slabs Calculation, Elephant & Castle MP1 – Block (H10C) | 135 |
| 3.6 Summary | 138 |
| CHAPTER FOUR: Deformation of Multi-Storey Flat Slabs, a Finite Elements Analysis and Precise Levelling | 139 |
| 4.1 Introduction | 139 |
| 4.2 Bentley: Structural Design Analysis Results | 142 |
| 4.2.1 Detailing Rules | 143 |
| 4.2.3 Materials | 145 |
| 4.2.4 Finite Element Standard Plan | 148 |
| 4.2.5 Long-term Deflection | 150 |
| 4.3 ETABS: Structural Design Analysis Results | 150 |
| 4.3.1 Computational Analysis | 151 |
| 4.4 Precise Levelling | 155 |
| 4.5 Summary | 158 |
| CHAPTER FIVE: Evaluation of Column Shortening in mid-rise Concrete Structures .160 | |
| 5.1 Introduction | 160 |
| 5.2 Review of Column Shortening Developments | 162 |
| 5.3 Column Shortening Prediction | 168 |
| 5.3.1 Column Shortening | 168 |
| 5.3.2 12-Storey Building Description | 168 |
| 5.3.3 24-Storey Building Description | 170 |
| 5.4 TCC55 and TCC55X Results and Discussion | 173 |
| 5.4.1 Investigation of the Effects of Environmental Factors on Column Shortening, Ambient Temperature | 173 |
| 5.4.2 Investigation of the Effects of Environmental Factors on Column Shortening, Relative Humidity | 175 |
| 5.4.3 Investigation of the Effects of Material Parameters on Column Shortening, Cement Classification | 178 |

| | |
|--|------------|
| 5.4.4 Investigation of the Effects of the Mineralogy of the Aggregate on Column Shortening | 182 |
| 5.5 Summary..... | 185 |
| 5.6 Recommendation | 186 |
| CHAPTER SIX: Analysis of Results and Discussion | 187 |
| 6.1 Introduction..... | 187 |
| 6.2 Outline Description of Building and Structural Form | 189 |
| 6.3 Construction Tolerance Specifications – Concrete | 192 |
| 6.4 Discussion of Construction Tolerances..... | 192 |
| 6.4.1 First Level (Highest Level) – Overall Tolerance of the Structure | 192 |
| 6.4.2 Second level – Positional Tolerance of All Parts of the Structure..... | 193 |
| 6.4.3 Third level – Dimensional Tolerance of The Individual Elements..... | 193 |
| 6.4.4 Fourth level – Position Tolerance..... | 194 |
| 6.5 Description of Movements | 194 |
| 6.5.1 Dead Loads (Permanent)..... | 194 |
| 6.5.2 Imposed Loads (Live)..... | 195 |
| 6.5.3 Foundation Movement..... | 196 |
| 6.5.4 Concrete - Long Term Concrete Effects (Shrinkage, Creep and Cracking) . | 197 |
| 6.6 Pre-Cambering and Pre-setting | 199 |
| 6.7 Construction Programme..... | 199 |
| 6.8 Accumulation of Movement and Tolerances | 200 |
| 6.8.1 Accumulation of Tolerances | 200 |
| 6.8.2 Accumulation of Movements | 201 |
| 6.8.3 Combination of Movement and Tolerances | 201 |
| 6.9 Details of Structural Movement Limits | 203 |
| 6.9.1 Vertical Deflection - Floor under Vertical Imposed and Dead Loading | 203 |
| 6.9.2 Vertical Foundation Settlement..... | 205 |
| 6.9.3 Axial Shortening of Concrete Cores Walls and Columns | 205 |
| 6.9.4 Horizontal Deflection – Movement of the Structure under Gravity Loading | 207 |
| 6.9.5 Movement of the Structure Subject to Thermal Actions | 207 |
| 6.10 Allowances Required due to Structural Movement and Tolerance | 208 |
| 6.10.1 Slab Movement and Tolerance..... | 208 |
| 6.10.2 Vertical Movements Relevant to External Cladding | 210 |
| 6.11 Ceiling Zone Allowance for Slab Deflections | 213 |

| | |
|---|------------|
| 6.12 Structural Frame Construction Tolerance..... | 214 |
| 6.12.1 Overall Structure..... | 214 |
| 6.13 Elements – Columns and Walls..... | 216 |
| 6.14 Elements – Beams and Slabs..... | 219 |
| 6.15 Section Elements..... | 222 |
| 6.16 Position of Reinforcement within Elements..... | 224 |
| 6.17 Surface Straightness..... | 226 |
| 6.17.1 Flatness..... | 226 |
| 6.17.2 Edge Straightness..... | 227 |
| 6.18 Discussion of Allowable Tolerances..... | 228 |
| 6.9 Summary..... | 235 |
| CHAPTER SEVEN: Discussion and Conclusions..... | 237 |
| 7.1 Aims of the Study..... | 237 |
| 7.2 Deflection Limits..... | 237 |
| 7.3 Methods of Controlling Deflection and Achievements..... | 238 |
| 7.4 Contributions of the Study..... | 238 |
| 7.5 Limitations..... | 239 |
| 7.6 Standard Code of Design..... | 240 |
| 7.7 Monitoring Slab Deflection..... | 241 |
| 7.8 Lessons Learnt..... | 242 |
| 7.9 Future Work and Recommendations..... | 242 |
| 7.10 Conclusions..... | 243 |
| References..... | 250 |
| List of Appendixes..... | 265 |
| Appendix A..... | 265 |
| Appendix B..... | 273 |
| Appendix C..... | 274 |
| Appendix D..... | 300 |
| Appendix E..... | 301 |
| Appendix F..... | 308 |
| Appendix G..... | 309 |
| Appendix H..... | 310 |
| Appendix I..... | 333 |

List of Figures

| | |
|---|-----|
| Figure 1.1 Typical Floor Layouts..... | 41 |
| Figure 2.1 Slab Precambering | 69 |
| Figure 2.2 Simulated Flat Slab Satisfied Criteria | 71 |
| Figure 2.3 Concrete and Steel in Composite Action..... | 74 |
| Figure 2.4 Stress and Strain Curve for Concrete in Compression | 75 |
| Figure 2.5 Stress and Strain (High Yield Steel)..... | 77 |
| Figure 2.6 Strain Hardening | 78 |
| Figure 2.7 Shrinkage Strain..... | 81 |
| Figure 2.8 Cracking and Shrinkage Forces..... | 83 |
| Figure 2.9 Concrete Moduli of Elasticity | 86 |
| Figure 2.10 Typical Concrete Deformation by Time | 87 |
| Figure 2.11 Three Span Beam..... | 96 |
| Figure 3.1 Precise Levelling Deflection of 2mm of on Selected Bay, refer to Figure 5.11 for more details..... | 107 |
| Figure 3.2 Levelling Instrument..... | 109 |
| Figure 3.3 Level Observing Deflection on Slab | 111 |
| Figure 3.4 Hydrostatic Cells Levelling System Connected..... | 113 |
| Figure 3.5 Hydrostatic Cell Levelling Location | 114 |
| Figure 3.6 Hydraulic Cell Level date box..... | 115 |
| Figure 3.7 Hydraulic Cell Level Network Connection | 116 |
| Figure 3.8 Hydraulic Cell Level water pressure reservoir | 117 |
| Figure 3.9 Hydrostatic Cells Levelling Connected to Data Box | 118 |
| Figure 3.10 Hydrostatic Cells Levelling Monitoring Software | 121 |
| Figure 3.11 HCL System in Action Observing Deflection and Transferring Data | 123 |
| Figure 3.12 Deflection & Temperature Vs Time | 124 |
| Figure 3.13 Location of Site Investigation, Elephant & Castle - London | 126 |
| Figure 3.14 HCL Attached to the Underside of the Concrete Slab..... | 128 |
| Figure 3.15 Shape Accel Array (SAA) (Getec 2016) | 129 |
| Figure 3.16 (SAA) – Intrados Profile (Getec 2016) | 130 |
| Figure 3.17 Practicality of Shape Accel Array (SAA) (Getec 2016) | 130 |
| Figure 3.18 Optical Fibre Interferometer (Tayag et al 2003) | 131 |
| Figure 3.19 Loading Plan, Block (H10C), Refer to (Figure 5.2 and 5.3) for details | 137 |
| Figure 3.20 Calculation Sheet no.1 | 310 |
| Figure 3.21 Calculation Sheet no.2 | 312 |
| Figure 3.22 Calculation Sheet no.2 | 314 |
| Figure 3.23 Calculation Sheet no.4 | 316 |
| Figure 3.24 Calculation Sheet no.5 | 318 |
| Figure 3.25 Calculation Sheet no.6 | 320 |
| Figure 3.26 Calculation Sheet no.7 | 322 |
| Figure 3.27 Calculation Sheet no.8 | 324 |
| Figure 3.28 Calculation Sheet no.9 | 326 |

| | |
|---|-----|
| Figure 3.29 Calculation Sheet no.10..... | 328 |
| Figure 3.30 Calculation Sheet no.11..... | 330 |
| Figure 3.31 Calculation Sheet no.12..... | 332 |
| Figure 4.1 Principle of Operation..... | 334 |
| Figure 4.2 Typical Cell Installation..... | 336 |
| Figure 4.3 Deflection of Reinforced Concrete Slab, Site Investigation..... | 338 |
| Figure 4.4 Deflection and Temperature Vs Time (Deflection of Concrete Slab)..... | 339 |
| Figure 5.1 Custom Span Detailing Rules..... | 144 |
| Figure 5.2 Loading Regions Colour and Number Coded [dashed rectangular]..... | 146 |
| Figure 5.3 Loading Regions Colour and Number Coded..... | 147 |
| Figure 5.4 Finite Element Standard Plan Block H10C, 3rd Floor Elephant and Castle - London..... | 149 |
| Figure 5.5 Long-term Deflection Plan due to Sustained Load..... | 150 |
| Figure 5.6 3D Grade Lines and Top View of Block (H10C)..... | 151 |
| Figure 5.7 3D and Top View of Block (H10C)..... | 152 |
| Figure 5.8 Point 36 on Third Floor Slab..... | 153 |
| Figure 5.9 Point 91 on Third Floor Slab..... | 154 |
| Figure 5.10 Point 89 on Third Floor Slab..... | 155 |
| Figure 5.11 Precise Levelling Deflection of 2mm of on Selected Bay..... | 157 |
| Figure 6.1 Torsional Effect of Differential Column Shortening (reproduced from SlideShare, 2016)..... | 163 |
| Figure 6.2 Outrigger System..... | 167 |
| Figure 6.3 12-Storey Building Frame..... | 170 |
| Figure 6.4 24-Storey Building Frame..... | 172 |
| Figure 6.5 Ambient Temperature Simulation Results for 12-Storey Building Structure, Rotimi et al (in press), See Table 6.1..... | 173 |
| Figure 6.6 Ambient Temperature Simulation Results for 24-Storey Building Structure, Rotimi et al (in press), See Table 6.2..... | 174 |
| Figure 6.7 Relative Humidity Simulation Result for 12-Storey Building Structure, Rotimi et al (in press), See Table 6.1..... | 176 |
| Figure 6.8 Relative Humidity Simulation Results for 24-Storey Building Structure, Rotimi et al (in press), See Table 6.2..... | 177 |
| Figure 6.9 Slow, Normal and Rapid Hardening Cement Results for 12-Storey Building Structure, Rotimi et al (in press), See Table 6.1..... | 179 |
| Figure 6.10 Slow, Normal and Rapid Hardening Cement Results for 24-Storey Building Structure, Rotimi et al (in press), See Table 6.2..... | 180 |
| Figure 6.11 Aggregate Type Results at 5° C, 50% RH, and Normal Hardening Cement for the 24-Storey Building..... | 182 |
| Figure 6.12 Aggregate Type Results at 30°C, 50% RH, and Normal Hardening Cement) for the 24-Storey Building..... | 183 |
| Figure 7.1 MP1 Site (Master Plan 1 – Elephant & Castle – London)..... | 190 |
| Figure 7.2 H10B & H10C Settlement Plot..... | 197 |

| | |
|---|-----|
| Figure 7.3 Movements and Tolerances Timeline | 202 |
| Figure 7.4 Breakdown of Slab Deflections | 210 |
| Figure 7.5 Edge Slab Deflection between Adjacent Floors (Robert Bird Group) | 211 |
| Figure 7.6 Ground Floor - Slab Edge Condition, (Robert Bird Group)..... | 212 |
| Figure 7.7 Brickwork Façade Supporting at the Concrete Slab Edge | 213 |
| Figure 7.8 Inclination of Floor edge, Column and Walls | 215 |
| Figure 7.9 Design Level at the Reference Level | 215 |
| Figure 7.10 Columns and Walls, Position on Plan..... | 216 |
| Figure 7.11 Vertically by Storey of the Structure..... | 217 |
| Figure 7.12 Offset between Floors | 217 |
| Figure 7.13 Curvature between Adjacent Floors..... | 218 |
| Figure 7.14 Curvature between Adjacent Floors, Side View..... | 218 |
| Figure 7.15 Distance between Adjacent Columns and Walls | 219 |
| Figure 7.16 Location of Beam to Column Connection..... | 219 |
| Figure 7.17 Position of Bearing Axis of Support..... | 220 |
| Figure 7.18 Straightness of Beams | 220 |
| Figure 7.19 Distance between Adjacent Beams | 221 |
| Figure 7.20 Inclination of Beams or Slab..... | 221 |
| Figure 7.21 Level of Adjacent Beams | 222 |
| Figure 7.22 Position of Slab Edge | 222 |
| Figure 7.23 Cross-Section Beam, Colum and others Dimension of Elements..... | 223 |
| Figure 7.24 Cross-Section Slab, Beam and others Dimension of Elements | 223 |
| Figure 7.25 Cross-Sectional of Cover Dimension of Elements | 224 |
| Figure 7.26 Length of Reinforcement Lap Joints | 225 |
| Figure 7.27 Location of Reinforcement and Ducts in Pre-stressed Elements..... | 225 |
| Figure 7.28 Flatness | 226 |
| Figure 7.29 Edge Straightness..... | 227 |

List of Tables

| | |
|---|-----|
| Table 2.1 Recommends Traditional Limiting Design values of Horizontal Deformations as Function of High H of Structure or High $H1$ Building | 66 |
| Table 2.2 Material property comparison between steel and concrete | 72 |
| Table 2.3 Elastic modulus of usual weight gravel concrete (short duration, 28 days) | 84 |
| Table 2.4 Concrete Strength Classes (Eurocode 2 2008) | 89 |
| Table 2.5 Steel Reinforcement Strength | 91 |
| Table 2.6 Traditional Limiting Design values of Horizontal Deformations as a Function of High H of Structure or High $H1$ Building | 99 |
| | |
| Table 3.1 Comparison of Various Methods for Measuring Deflection on Slabs | 104 |
| Table 3.2 Planned Sequence of Tasks | 131 |
| | |
| Table 4.1 Technical Data | 333 |
| Table 4.2 Technical Data | 339 |
| | |
| Table 5.1 Bentley Design Rules (3rd Floor Elephant and Castel – London) Construction Site Block H10C | 143 |
| Table 5.2 Concrete Mix (3rd Floor Elephant and Castel Construction Site Block H10C) | 145 |
| Table 5.3 Load History Details | 148 |
| Table 5.4 ETABS Design Rules (3rd Floor Elephant and Castel – London) Construction Site Block H10C | 151 |
| | |
| Table 6.1 Geometry and Loading Sequence of the 12-Storey Building | 169 |
| Table 6.2 Geometry and Loading Sequence of the 24-Storey Building | 171 |
| Table 6.3 Results Summary for the Effect of Ambient Temperature on Column Shortening | 175 |
| Table 6.4 Results Summary for the Effect of Relative Humidity on Column Shortening | 178 |
| Table 6.5 Results Summary for the Effects of Cement Type on Column Shortening | 181 |
| Table 6.6 Results Summary for the Effect of Aggregate Type on Column Shortening | 184 |
| | |
| Table 7.1 Slab Deflection Criteria – Internal Conditions | 204 |
| Table 7.2 Slab Deflection Criteria – Slab edge Conditions | 204 |
| Table 7.3 Horizontal Movement Criteria, based on (Eurocode 2 2008) | 206 |
| Table 7.4 Building Temperature Variation | 208 |
| Table 7.5 Breakdown of Vertical Slab Movement & Tolerance | 209 |
| Table 7.6 Movement Combinations for Main Trade Items | 210 |
| Table 7.7 Ceiling Void Allowance for Slab Movement and Tolerance, (Robert Bird Group) | 214 |

List of Acronyms / Abbreviations

Notation is commonly in accordance with Eurocode 2 and the principal List of Acronyms and Abbreviations are presented below. The common system of subscripts such that the first subscript refers to the material, such as (c - concrete and s - steel), and the second subscript refers to the form of stress, such as (c – compression and t - tension).

| | |
|----------|-------------------------|
| <i>E</i> | modulus of elasticity |
| <i>F</i> | load (action) |
| <i>G</i> | permanent load |
| <i>I</i> | second moment of area |
| <i>K</i> | prestress loss factor |
| <i>M</i> | moment (bending moment) |
| <i>N</i> | axial load |
| <i>Q</i> | variable load |
| <i>T</i> | torsional moment |
| <i>V</i> | stress force |
| <i>a</i> | deflection |
| <i>b</i> | breadth (width) |
| <i>d</i> | effective depth |

| | |
|-------------|--|
| d' | depth to compression reinforcement |
| e | eccentricity |
| h | overall depth of section in plan of bending |
| i | radius of gyration |
| k | coefficient |
| l | length (span) |
| n | ultimate load per unite area |
| $1/r$ | curvature of a beam |
| s | spacing od shear reinforcement (depth of stress section) |
| t | thickness |
| u | punching shear perimeter |
| x | neutral axis depth |
| z | lever arm |
| A_c | concrete cross-section area |
| A_p | cross-section area of prestressing tendons |
| A_s | cross-section area of tension reinforcement |
| A'_s | cross-section area of compression reinforcement |
| $A_{s,req}$ | cross-section area of tension reinforcement required at the ultimate limit state |

| | |
|--------------|---|
| $A_{s,prov}$ | cross-section area of tension reinforcement provided at ultimate limit state |
| A_{sw} | cross-section area of shear reinforcement in the form of links (bent-up bars) |
| E_{cm} | secant modulus of elasticity of concrete |
| E_s | modulus of elasticity of reinforcing (prestressing steel) |
| G_k | characteristic permanent load |
| I_c | second moment of area of concrete |
| M_{bal} | moment on a column corresponding to the balanced condition |
| M_{Ed} | design value of moment |
| M_u | ultimate moment of resistance |
| N_{bal} | axial load on a column corresponding to the balanced condition |
| N_{Ed} | design value of axial force |
| P_0 | initial prestress force |
| Q_k | characteristic variable load |
| T_{Ed} | design value of torsional moment |
| V_{Ed} | design value of shear force |
| W_k | characteristic wind load |
| b_w | minimum width of section |
| f_{ck} | characteristic cylinder strength of concrete |

| | |
|------------|--|
| f_{cm} | mean cylinder strength of concrete |
| f_{ctm} | mean tensile strength of concrete |
| f_{pk} | characteristic yield strength of prestressing steel |
| f_{yk} | characteristic yield strength of reinforcement |
| g_k | characteristic permanent load per unit area |
| k_1 | average compressive stress in the concrete for a rectangular parabolic stress section |
| k_2 | a factor that relates the depth to the centroid of the rectangular parabolic stress section and the depth to the neutral axial |
| l_a | lever arm factor = z/d |
| l_0 | effective height of column (wall) |
| q_k | characteristic variable load per unit area |
| a | coefficient of thermal expansion |
| a_c | modular ratio |
| ψ | action combination factor |
| γ_c | partial safety factor for concrete strength |
| γ_f | partial safety factor for load (action), F |
| γ_G | partial safety factor for permanent loads, G |
| γ_Q | partial safety factor for variable loads, Q |
| γ_s | partial safety factor for steel strength |

| | |
|---------------|--|
| δ | moment redistribution factor |
| ε | strain |
| σ | stress |
| \emptyset | bar diameter |
| A_a | area of a structural steel section |
| A_v | shear area of a structural steel section |
| b | width of the steel flange |
| b_{eff} | effective width of the concrete flange |
| d | clear depth of steel web (diameter of the shank of the shear stud) |
| E_a | modulus of elasticity of steel |
| $E_{c,eff}$ | effective modulus of elasticity of concrete |
| E_{cm} | secant modulus of elasticity of concrete |
| f_{cm} | mean value of the axial tensile strength of concrete |
| f_y | nominal value of the yield strength of the structural steel |
| f_u | specified ultimate tensile strength |
| h | overall depth (thickness) |
| h_1 | depth of structural steel section |
| h_f | thickness of the concrete flange |
| h_p | overall depth of the profiled steel sheeting excluding embossments |

| | |
|--------------|--|
| h_{sc} | overall nominal height of a shear stud connector |
| I_a | second moment of area of the structural steel section |
| I_{transf} | second moment of area of the transformed concrete area and the structural steel area |
| k_1 | reduction factor for resistance of headed stud with profiled steel sheeting parallel with the beam |
| k_t | reduction factor for resistance of headed stud with profiled steel sheeting transverse with the beam |
| L | length (span) |
| M_c | moment of resistance of the composite section |
| n | modular ratio (number of shear connections) |
| n_f | number of shear connection for full shear connection |
| P_{Rd} | design value of the shear resistance of a single connector |
| R_{cf} | resistance of the concrete flange |
| R_{cx} | resistance of the concrete above the neutral axis |
| R_s | resistance of the steel section |
| R_{sf} | resistance of the steel flange |
| R_{sx} | resistance of the steel flange above the neutral axis |
| R_v | resistance of the clear web depth |
| R_w | resistance of the overall web depth = $R_s = sR_{sf}$ |

| | |
|------------|---|
| R_{wx} | resistance of the web above the neutral axis |
| t_f | thickness of the steel flange |
| t_w | thickness of the steel web |
| $W_{pl,y}$ | plastic section modulus of the a steel structural section |
| δ | deflection at mid span |
| γ | factor of safety |
| v_{Ed} | longitudinal shear stress in the concrete flange |
| η | degree of shear connection |

Acknowledgements

Above all, prima facia, I am grateful to ALLAH (**الله سبحانه وتعالى**) for all things I have the strength through him who gives me power, for the good health and wellbeing that were necessary to complete this PhD.

Firstly, I would like to express my sincere gratitude to my advisor Charles Goodchild Principal Structural Engineer from MPA The Concrete Centre for the continuous support of my PhD study and related research, for his patience, motivation, and immense knowledge. His guidance helped me in all the time of research and writing of this thesis. I could not have imagined having a better advisor and mentor for my PhD study.

Besides my advisor, I would like to thank Dr. Ali B-Jahromi, for his insightful comments and encouragement, but also for the hard question which incited me to widen my research from various perspectives.

My sincere thanks also goes to Lendlease and Morrisroe who provided me an opportunity to join their team as intern, and who gave access to the construction site. Without their precious support it would not be possible to conduct this research.

A special thanks to my family. Words cannot express how grateful I am to my mother and father for all of the sacrifices that you've made on my behalf. Your prayer for me was what sustained me thus far.

Last but not the least, I would like to thank my brothers and sisters for supporting me spiritually throughout writing this thesis and my life in general.

Dedication

To my parents for teaching me the purpose of life,

To all my family members for supporting me during my 3 years PhD study.

List of Publications Arising from this Thesis

The following publications have been produced and presented in advance of the thesis, in which attached as an Appendixes of this thesis.

1. Tovi, S., Goodchild, C., Jahromi, B. A. and Sofroniou, A. (2016) A review of the span-to-depth ratio methods of design. *Proceedings of the fib Symposium*, 21 – 23 November 2016, Cape Town, South Africa.
2. Tovi, S., Goodchild, C. and Jahromi, B. A. (2017) *Deformation of Multi-Storey Flat Slabs, a Site Investigation*. Daejeon: Techno Press.
3. Tovi, S., Goodchild, C. and Jahromi, B. A. (in press) *Deformation of Multi-Storey Flat Slabs, a Finite Elements Analysis and Precise Levelling*. Daejeon: Techno Press.
4. Jahromi, A, B., Rotimi, A., Tovi, S., Goodchild, C. and Rizzuto, J. (2017) *Evaluation of the influence of creep and shrinkage determinants on column shortening in mid-rise buildings*. Daejeon: Techno Press.

CHAPTER ONE: Introduction to Deflection on Slabs

1.1 Background of Span-to-Depth Ratio Methods of Concrete Slab Design

Concrete flat slab structures are economical and the most popular form of concrete used in multi-storey structures. Deflection of slabs is a principal criterion in design, it governs thickness, which in turn has a significant economic impact. Deflection is usually controlled by limiting span/depth ratio. This paper reviews the history of the span-to-depth method of design.

Span/depth ratios are based on knowledge of deflection and currently, advances have been made in the calculation of deflection. Yet, the actual performance of restrained concrete slabs in the field remains largely unknown. Models have only rarely been calibrated against actual construction projects. This study aims to document the deflection of a concrete slab in a large residential block. The intention is to note any serviceability issues and to compare design models and assumptions with reality (Tovi et al 2016).

Limits on deformation were set many decades ago, when the forms of construction, partitions, finishes, cladding and service were very different from what they are now. It is possible, therefore, that the current limits are too conservative. In order to justify change, and enable more sustainable and economic designs, knowledge of the background to current limits and of current performance is needed. Part of that is to review the span-to-depth method of design.

Beeby (2001) explained during analysis and calculations of prop forces at Cardington case study that the construction load is situated on the top slab of the supporting assembly while the other slabs carry their own weight before the slab above is cast.

The lower slabs in the supporting assembly is extremely loaded if reinforced concrete slabs do not carry their own weight before the reinforced slab above is cast. If the recently cast slab carries its own weight after loading, the construction load is given by:

$$W_{peak} = W_{self} + C(W_{self} + W_{con}) \quad (\text{Eq. 1.1})$$

Where C is a carry through factor of at least $1/(\text{number of supporting levels})$ and W_{con} is a construction action (load) comprising formwork, which is usually close to 0.75 kN/m^2 . Beeby's investigation states that, when backprops are installed, it is acceptable in the absence of detailed calculation to take the C value as 0.7 in Equation (1.1), if there is only one level of backprops, and as 0.65 if there are more than one level of backprops. Backprops are normally preloaded through installation rather than being installed, as at Cardington study case.

Vollum (2003) calculated significant preloads in the backprops at St George Wharf, as a uniformly distributed load of approximately 1 kN/m^2 . Preloading is useful because it induces an additional distribution of construction load between the supporting concrete slabs than calculated at Cardington.

Parametric studies have shown that it is acceptable to consider the peak construction load W_{self} as $0.04h \text{ kN/m}^2$, where h is the slab thickness in mm, in deflection calculations for slabs up to 500 mm thick where two levels of backprops are used and the backprops are preloaded throughout the installation, as Vollum (2003) demonstrates at St George Wharf.

Construction loads from casting concrete slabs above can only be ignored if:

- Columns support the formwork, or

- Adequate backprops are provided to divert the self-weight of the recently cast slab to the ground

Caution should be applied in ignoring construction loads since calculations of prop forces at Cardington, as Hossain (2002) declares, and at St George Wharf, as in Vollum (2003), suggest that slabs can experience considerable construction loads from casting concrete slabs above them, even if the backprops continue to the ground, owing to the combined influence of prop shortening and floor settlement.

Beeby (1971) states that at an early stage in the development of the proposed new code of practice for the structural use of reinforced concrete members, the methods considered in British Standards Institution (1965) to control deflections were not fully satisfactory and would be even less satisfactory when the higher levels of reinforced steel stress allowed by the new code were used. It was agreed, however, that the simple technique of controlling deflections provided by span/depth ratios is essential for common use rather than insisting on the calculation of deflections in all circumstances.

Eurocode 2 (2008) calculates the mean curvature in cracked concrete members by interpolating between the curvatures in uncracked and cracked sections as:

$$\Psi_m = \xi\Psi_2 + (1 - \xi)\Psi_1 \quad (\text{Eq. 1.2})$$

Where

$$\xi = 1 - \beta(M_r/M)^2 \quad (\text{Eq. 1.3})$$

Ψ_1 and Ψ_2 are the curvatures in uncracked and cracked members, including shrinkage, while M_r is the cracking moment when the moment M is applied. The coefficient β presents the loss of tension stiffening with time owing to further internal and macro

cracking when the slab is subjected to a sustained load. Eurocode 2 (2008) declares that coefficient β should be considered as 1 for short term loading and 0.5 for long term loading, but it does not define the variation in the coefficient β with time, although Vollum (2002) suggested 0.7 for construction loading.

Vollum (2002) also offered back analysis of the slab deflection data from laboratory and field investigation, and states that Equation (1.3) obtains good estimates of curvature and then deflection, if the material properties and loading are known. Difficulties appear in practice, however, since neither the material properties nor the loading are known prior to construction or, as a matter of fact, subsequently. Deflections in reinforced concrete slabs are difficult to predict reliably because they are extremely dependent on whether or not the reinforced concrete slab is cracked.

Vollum (2004) published a report on deflection by analysing the backdrop forces at Cardington, to give an indication of the loads on one slab when the slab above is cast. The report concluded that a major proportion of the load from casting the slab above is carried by the upper floor in a supporting assembly, which differs from the conventional proposition that the load is distributed evenly between floors. The result was inspected at St George's Wharf when the back prop forces were calculated on the sixth floor during construction. The most important conclusions are:

- Engineers should consider that flat slabs are subjected to peak construction loads and model slabs accordingly
- Back prop forces may be considerably underestimated by elastic analysis, if overloading occurs, as a result of neglecting temperature and preloading

Vollum (2009) also notes that deflections in reinforced concrete slabs are significantly governed by the most severe cracking, which can appear during construction work or

subsequently in service. Cracking can appear during construction work either when striking the slab, or subsequently due to loading from casting slabs above or storing construction materials.

1.2 General

Reinforced concrete slabs have been used extensively since the 20th century for different applications such as flat slabs and bridge decks. This research aims to investigate the deflection of restrained concrete slabs in order to recommend design limits to calculate this deflection.

The behaviour of restrained concrete slabs under load is investigated in this research, with a particular focus on the establishment and comparison of the serviceability limit state. The research fits onto a project initiated by the Concrete Centre – London. As part of this research, an investigation programme with large-scale reinforced concrete slabs will be considered under loads.

Reinforced concrete structures are increasingly popular worldwide and in the UK, particularly for multi-storey structure. The popularity of this structure shapes principally due to the efficiency offered in terms of building behaviour, construction period and material usage all of which are especially attractive proposing the ever-increasing requests for improved sustainability in structure (Florides and Cashell 2016).

This research reviews the derivation of a technique for controlling deflections in the design of reinforced concrete slabs by using ratios of span to effective depth. The method is a development of that given in the draft of the Code of Practice for the structural use of concrete published for comment in September 1969 (Beeby 1971). This study shows how more current research permits considerable simplification of the original proposals while increasing their general accuracy.

The serviceability design is probably the most complicated and least understood aspect in the design of concrete slab structures. Deflection must be controlled so as not to exceed design limits, and cracking and shrinkage must be monitored and treated. In addition, freshly constructed concrete structures must not excessively vibrate. Hence shrinkage reflects its impact on concrete structure and plays a significant part in each aspect.

Failures of concrete slab structures occur due to extreme deflection or cracking, even in the case of structures built to design code requirements, often as a direct result of inaccurate calculation of the time dependent deflection of concrete slab structures. Concrete deflections can be controlled, however, if the service load behaviour has been studied carefully. The behaviour of the service load initially depends on the material properties of the concrete but, at the early stage of design, these factors are largely unknown. Using the nonlinear and inelastic behaviour of concrete at the service load to design for serviceability limitation is intricate, however. Standard codes for serviceability limitation design are comparatively modest and, in some cases uncertain; indeed, even inaccurate in modelling structures' behaviour. In short, there has been a widespread failure to calculate the effect of shrinkage and creep on concrete structures.

This failure is particularly striking given that the effects of shrinkage and creep on concrete structure have been widely researched and investigated for over 100 years, for instant Slab Deflections in the Cardington in-situ Concrete Frame Building study by Vollum (2003) and Backprop Forces and Deflection in Flat Slabs Construction at St George Wharf by Vollum (2004). Many of these analytical techniques and methods are not used or known professionally, for instant rigorous and simplified methods to calculate deflection and also various FEM software, however. Service loads have often

been underestimated by structural designers, using simplified methods in standard codes, and this leads in turn to an oversimplification in the understanding of structural behaviour, for instant the RILEM Draft Recommendation 107-GCS Guidelines for the Formulation of Creep and Shrinkage Prediction Models by Kluwer (1995). There are a variety of sources on concrete slab structures from which to obtain design details, but since comparison information from these sources reveals considerable variation, the material properties should be investigated and tested to calculate time dependent deflection. This cannot be taken as an effective alternative, however: structural design engineers rarely have the time or the inclination for long term laboratory tests. Moreover, it is not guaranteed that the concrete used in the construction process is the same as the test sample used in the laboratory. In fact, the computed deflection property of concrete is commonly larger than the actual property, with coefficients of difference of more than 20 per cent sometimes being found. Hence, a probabilistic approach is demanded in construction design to obtain better concrete properties, and the outcome of such methods needs to be considered (Taylor 1977).

Serviceability limitations for deflection in respect to pre-stressed and reinforced slab structures may be calculated using several techniques, from cracking control according to various codes of design and deflection limitation using either simple, or more advanced and refined methods. When designing methods to analyse serviceability in concrete slab structures it is important to include the effect of shrinkage and creep on structures. In addition, a clearer understanding of concrete slab behaviour may be obtained from advanced analytical methods.

The initial consideration in understanding the serviceability of flat slab systems is deflection control. The reasons for controlling deflection are:

- Deflection values need to be controlled, for use as a measurement tool to understand the vibration in a slab structure
- To avoid alteration in deflection in concrete slab structures requires sufficient stiffness
- To alleviate safety concerns, since deflection in flat slabs must be unnoticeable by residents

All concrete slabs deflect, however, and over the time the magnitude of that deflection increases, and hence to guarantee it does not exceed the specification, the deflection must be accurately monitored and controlled. Excessive deflection can be optically unacceptable, causing damage to supported partitions, except if articulated. Although in most cases partitions are sufficiently resilient to accommodate concrete deflection in the long term without cracking, it remains essential to comprehend the deflection behaviour of slabs to construct appropriate serviceability limitation requirements.

Current design limits on deformation (such as Eurocode 2) are based on limits set many decades ago in ET ISO 4356 - 1977 (2012), when the forms of construction, partitions, finishes, cladding, and services were very different to what they are now. It is possible, therefore, that the current limits are too conservative, and more research is thus needed to understand current performance in order to enable more sustainable and economic designs.

Serviceability and strength are two main criteria to consider when designing concrete structures. There has been limited recent academic research into deflection limits for concrete slabs and this emphasises how significant and important this study will be for understanding the behaviour of the deflection of concrete slabs.

In many cases, appropriate control of deflections may be achieved by complying with detailed span/depth ratios. There are some cases, however, where they should be determined to conform to tolerances concerning partitions and cladding, such as the case in St George's Wharf, London, UK (Vollum 2004).

Reinforced concrete is a popular and durable structural material, and a very economical material to design sustainable suspended floors (Taylor, 1977). Concrete slabs and slabs with drop panels normally develop radial cracking in the vicinity of column supports under usual service construction action. This behaviour has been spotted in slabs in which model and/or construction errors have been recognised, and in properly modelled and constructed slabs. As such, the occurrence of such cracking is not itself indicative of either layout of construction errors, much less unanticipated performance. Negative flexural stresses are ideally responsible for a density of cracking in the immediate vicinity of the columns, which often manifests in a star-burst pattern of radial cracks. Such cracking can be identified in reinforced concrete slabs in structures that have been in service for decades, as well as in new structures shortly after removal of props. The deflection of concrete slabs, however, depends on many variables such as loading, strength and cracking, among others, and the estimation of this deflection is critical in the sizing and reinforcement of slabs. The design limits appear to be historic or traditional, perhaps inappropriate to today's forms of construction and current demands for economy and material reduction in the name of sustainability. The behaviour of reinforced concrete slabs will be the focus of an experimental and observation programme as fib indicates Federation Internationale du beton fib (2014), and this encourage more study in this area and this research is taking up the challenge.

Generally, concrete structures subjected to load will react both instantaneously and time dependently. The deflection of concrete structures progressively increases over time, to eventually become greater than initial deflection value. Adequate and credible estimates of the immediate and time dependent deflection of concrete slab structures are necessary to satisfy these serviceability limitations. Shrinkage and creep causes a gradual increase of strain if stress and temperature stay steady, resulting in increased deformation and curvature, redistribution of stress and losses of pre-stress and interior activities. Extreme deflection at service loads is a direct result of such shrinkage and creep. For instance shortening in pre-stressed members and/or extreme camber is largely caused by creep. In addition, a failure in durability or serviceability occurs due to restraining shrinkage, causing time dependent cracking, as Kluwer Academic indicates in their draft recommendation 107-GCS Guidelines for the Formulation of Creep and Shrinkage Prediction Models by Kluwer (Kluwer 1995).

The demand for harmonisation of methodological standards in Europe has led to the development of structural codes in Europe (Eurocodes) intended for adoption among members of the European Union. The function of the new codes (Eurocodes groups) is to narrow trading barriers and enable companies to compete on the basis of impartial rules across the European Union. Eurocode 2 adopted the principle of limit state from British Standards, and there are a range of documents produced from many UK bodies supporting the code, explaining the background and giving a commentary on the Eurocodes' demands. The National Annex of each European Committee is published separately to support the Eurocodes. In the UK, this is supported by British Standards publication PD 6687:2006, which provides background information. In addition, the Concise Eurocode for the Design of Concrete, produced by the British Cement Association, distils elements from Eurocode 2, in a more use friendly way than the full

code, focusing on the essential information for the design of everyday concrete structures. In addition, a new edition of the Design Manual has been produced by the Institute of Structural Engineers. Both documents (the Concise Eurocode for the Design of Concrete produced by the British Cement Association and the new edition of the Design Manual produced by the Institute of Structural Engineers) contain further details and information not covered by Eurocode 2 (e.g. design methods and design charts drawn from British Standard BS 8110).

The essential feat of Eurocode 2 is that the principles embodied in the code are quite similar to the principles of BS 8110, although there are some specific differences; this means that designers have no difficulty in dealing with Eurocode 2. In addition, a new grade of steel reinforcement is proposed and the cylinder strength of concrete is considered as the designing base. The terminology has also changed, with “action” indicating the load applied on structures and the terms “permanent” and “variable” replacing “imposed” and “dead loads”.

The use of Eurocode 2 with the rest of Eurocode family codes in specific, it prefaces Eurocode; Basis of Structural Design published by British Standards Institution (1990) and Eurocode 1, Action on structures (1991) and navigates structural engineers through practicality of defining the right designing values for constructions. In addition, they presents an abstract overview of important variation between the Eurocode and BS 8110 and a glossary of terminology.

The Eurocode project began to evolve in 1975, and the Eurocodes are now considered to be the most advanced structural guidance codes in the world. The advantages of using Eurocode 2 are highlighted below, (IStructE 2004).

- The most technically advanced code available in the world

- Produces more economic benefit to structures than BS 8110
- More exclusive than all previous codes
- Less restrictive than all previous codes
- The official code in all of the European public work sector
- More efficient for use by structural designers around Europe, and thus results in better business opportunities
- Well organised and logically ordered to avoid any repetition

1.3 Research Aims, Questions and Objectives

1.3.1 Aims

In this thesis, the behaviour of restrained concrete slabs under load has been investigated. The focus of the research is the establishment and comparison of the serviceability limit state. This research aims to provide a better understanding of reinforced concrete slab deflection. The research fits into a project initiated by the Concrete Centre – London. As part of this project, an investigation programme with large-scale reinforced concrete slabs will be considered under loads.

There is a requirement to document the performance of commercial reinforced concrete flat slabs in order to comment on current design assumptions.

The aims of this research are:

- To obtain new accurate deflection data from a commercial building site
- To calibrate the Eurocode 2 rigorous method
- To verify new span/depth (L/d) rules

1.3.2 Research Questions

The research is answering the most fundamental deflection questions as below

- What are the traditional L/250 and L/500 deflection limits values based on?
- Are these values still adequate for modern structures?

1.3.3 Objectives

Site investigation and testing theory through observation and data collection was the main deductive approach of this research.

A quantitative method was used to calculate and determine the deflection on concrete slabs, using Hydraulic Cells Levelling methods to monitor slab deflection on construction site.

The project has the following characteristics:

- A six-month lifecycle timeframe

1.4 Eurocode Group

The Eurocode family includes ten Eurocodes (more details are presented below), covering all the major structural materials. The Eurocodes are derived from the European Committee for Standardisation (CEN), replacing national standards in the European Union, with each country being required to release a Eurocode with a national title page and foreword. The primordial Eurocode text, however, is generated by the CEN as the initial body of the Eurocode. A National Annex is included as part of the final product.

- BS EN 1990, Eurocode: Basis of Structural Design (structural safety, serviceability & durability)
- BS EN 1991, Eurocode 1: Action on Structural (action on structures)

- BS EN 1992, Eurocode 2: Concrete (design & detailing)
- BS EN 1993, Eurocode 3: Steel (design & detailing)
- BS EN 1994, Eurocode 4: Composite (design & detailing)
- BS EN 1995, Eurocode 5: Timber (design & detailing)
- BS EN 1996, Eurocode 6: Masonry (design & detailing)
- BS EN 1997, Eurocode 7: Geotechnical Design (geotechnical design)
- BS EN 1998, Eurocode 8: Seismic Design (Seismic design)
- BS EN 1992, Eurocode 9: Aluminium (design & detailing)

1.4.1 Eurocode 2

Eurocode 2 is considered to be the most advanced structural design standard code in the world according to IStructE (2004), and consists of four parts, as detailed below:

Eurocode 2, Part 1-1 General rules and rules of building are published in British Standards Institution (2004) and is considered as the principal part, referenced by the other three parts in Eurocode 2. There are a number of variations between Eurocode 2 and BS 8110, as set out below:

- Eurocode 2 mainly evolved to provide guidance on structural phenomena (shear, bending and torsion) rather than the types of members as in BS 8110 (slabs, columns and beams)
- The derived formulae (bending, stress block details) are presented only as classical European guidance, while textbooks and other publications such Non-Contradictory Complementary Information (NCCI) will provide the Eurocode application. The stress unit used is the Mega pascal (MPa) ($1 \text{ MPa} = 1 \text{ N/mm}^2$)

- The comma is used in Eurocode 2 for the decimal point, while in the UK, designers are still using the decimal point. Hence, to prevent any confusion, the use of the comma is not allowed for separations of multiples of a thousand
- The representation of one thousandth is ‰
- The steel reinforcement partial factor is 1.15, while the steel distinctive yield strength is 500 MPa, resulting in negligible effect
- The practicality of Eurocode 2 to ribbed reinforcement and distinctive yield strengths 400 – 600 MPa, however no instruction on steel reinforcement or plain bar is presented in the Eurocode 2. Such an instruction is given in the UK National Annex, (British Standard Institution 2006)
- The influence of geometric deficiency (national horizontal loads) is considered additionally to side loads
- The minimum cover of concrete is refined to durability, fire resistance and bond strength; in addition, due to variations in implementation, deviation tolerances are included as a requirements. Eurocode 2 proposes 10 mm for casting concrete versus formwork, except that the structure is subjected to a characteristic assertion framework allowing a reduction of 0 – 5 mm, while unconfirmed members are unacceptable (precast yard)
- Eurocode 2 is valid up to a maximum concrete strength of C90/105 class, although several terms in the Eurocode are valid for higher classes over C50/60, due to differences in the maximum strength of concrete

- Eurocode 2 proposes the variable strut inclination technique to assess the shear capacity for pragmatic structures. The classified values are compared with structured values
- For rectangular shape and from the face of the column, shear punch checks executed at $2d$, circumference circulated at corners
- Similar to BS 8110, the span to effective depth ratio technique is still considered suitable for serviceability checks
- The lap length and anchorage principles defined are more complicated than in BS 8110. Eurocode 2 sets out the impact of the bar location at the casting edge, as well as the shape of cover and the bar

1.5 Eurocode 2 Deflection Design and Analysis

Designing and analysing slabs using Eurocode 2 is essentially similar as in BS 8110, although the content and layout of Eurocode 2 might be unfamiliar for some designers compared to BS 8110. Certain instructions and/or derived formulae on defining shear forces and distribution moments are not included in EC 2, due to the aim to present only essential rules and principles in EC 2, rather than detailed applications, which are left to other sources, such as textbooks. The principles of structural mechanics and materials reaction remain the same, however, and it is these standards of practice and codes that mainly require revision. Structural engineers and designers are recommended by IStructE (2004), to work on current code editions and any up to date modifications.

1.6 Factors Affecting Deflection

The stiffness of constructed structures tends to be greater the shorter the span. As applications and technology have advanced, however, more flexible construction structures are required due to:

- concrete strength, arising from the demand to progress the duration of the construction period, results in greater service stresses and stiffer concrete
- In addition, excessive reinforcement strength, resulting in less reinforcement for the ultimate limit state, causes greater service stress
- The need for a better comprehension of concrete structural behaviour and the capability to analyse the reaction of the structures more effectively using available computer programs
- The commercial demand to develop an economic slab design, given that thicknesses are defined by the serviceability limit state and comprise 80% to 90% of project costs
- The demand from clients for sufficient flexibility and longer spans.

There are a range of factors affecting deflection as The Concrete Society (2005) states. These factors are predominately time-dependent and interdependent, which makes it difficult to estimate deflection

The primary factors are:

- Creep
- Concrete Tensile Strength
- Elastic Modulus

Other factors include:

Duration of loading, cracking of the concrete, shrinkage, time of loading, extent of stiffening by other elements, secondary load-paths, ambient conditions, degree of restraint and magnitude of loading.

An adequate estimation of deflection may be obtained by observing each of these factors affecting deflection, as detailed below.

1.6.1 Creep

Creep is defined as an increase of time dependent intensive strain in an element of concrete subjected to intensive stress.

From a design perspective, creep is normally considered as an alteration in the elastic modulus. The creep coefficient, ϕ , depends on environmental conditions (specifically humidity), the time at loading and the dimension of a member. To assess creep, the class of cement strength needs to be considered, although this is not an absolute requirement at the design stage. Commonly, the assumption is class R, where fly ash (pfa) comprises 20% of the content of the cement, or class N where ground granulated blast furnace slag (ggbs) comprises more than 35% of the cement. If the fly ash (pfa) content is greater than 35%, or if the ggbs is more than 65%, class S is the assumption (Mosley et al. 2007).

1.6.2 Tensile Strength

Cracks occur in concrete slabs when the tensile stress in the extreme fibre is exceeded. Tensile strength is therefore an important property that needs careful consideration in concrete slabs. In addition, the tensile strength, f_{ctm} , of the concrete is an initial value in Eurocode 2 and is crucial for deflection measurements, with its value increasing as the compressive strength increases. A comparison of tensile

strength values between Eurocode 2 and BS 8110 shows that it is more advantageous to use than Eurocode 2 where concrete strengths values are fixed. The effort put into restraining shrinkage activities will affect the effectiveness of the tensile strength of concrete slab structures. Walls with greater restraints tend to have less effective tensile strength. More details of a typical floor layout are given in (Figure 1.1) published by The Concrete Centre (2011). The expression below may express the concrete tensile strength:

$$f_{ctm,fl} = \left(1.6 - \frac{h}{1000}\right) f_{ctm} > f_{ctm} \quad (\text{Eq. 1.4})$$

Where

$f_{ctm,fl}$ = Mean flexural tensile strength of reinforced concrete

f_{ctm} = Mean tensile strength of concrete

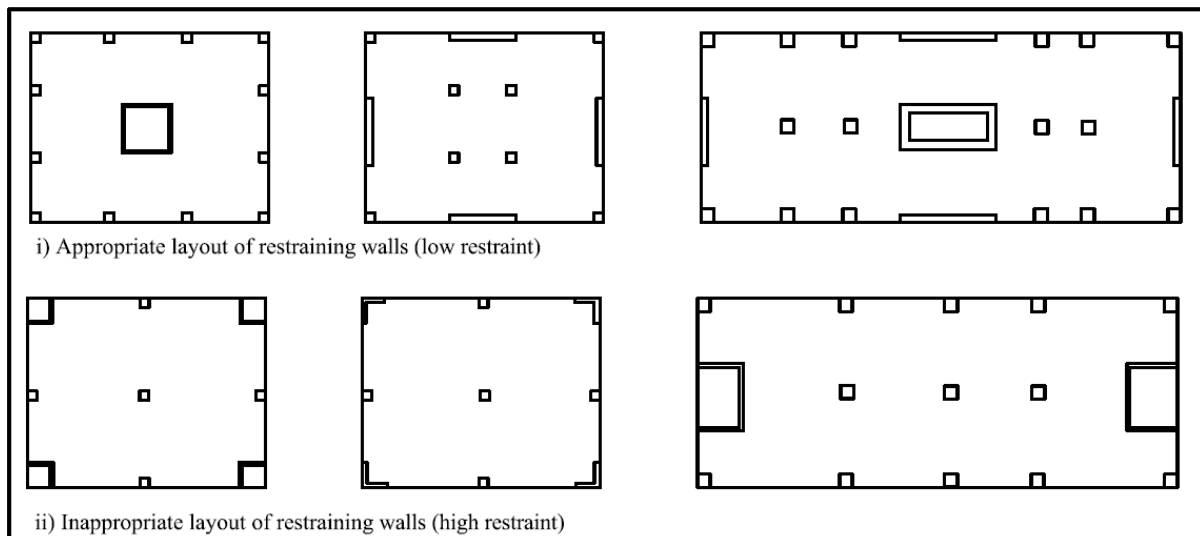

Figure 1.1 Typical Floor Layouts

1.6.3 Elastic Modulus

Curing status, aggregate pattern and workmanship are all factors that affect the elastic modulus in slab concrete structures. Over time, creep causes a reaction in the

effective elastic modulus due to sustained load. To define an adequate elastic modulus, therefore, accuracy is required. To define an adequate elastic modulus, Eurocode 2 proposes simulated values for a 28 day period.

1.6.4 Cracking

Cracking extension and the level at which cracking capacity is exceeded have an influence on deflection of slab sections. The cracking zone is defined by moments stimulated in the concrete slab and the tensile strength of the section, causing cracks to increase over time. The critical condition occurs when a slab is subjected to a load from the casting slab above and/or the slab is pummelled. When a crack occurs it causes a perpetual reduction to its stiffness. It is crucial to define the critical point at the initial stages of cracking in order to control that cracking. In this case critical load equates to the minimum value of K , where:

$$K = f_{ctm}/(W/\sqrt{0.5}) \quad (\text{Eq. 1.5})$$

Where

W = The serviceability applied load on that level

f_{ctm} = The tensile strength of concrete at that level

The degree of cracking (ξ) computed for the periodic combination is also considered for the quasi-perpetual combination, where the periodic combination is at the critical loading level, but not at the earlier loading period. The degree of cracking (ξ) value should be carried forward at the earlier stage to all subsequent loading levels, if an earlier level is considered to be critical.

1.6.5 Shrinkage Curvature

The factors influencing shrinkage are humidity, the ratio of water/cement and the shape and size of the section. Shrinkage in an asymmetrically reinforced concrete section serves to stimulate a curvature which causes considerable deflection in shallow sections. Avoiding such deflections requires careful consideration in the computation of deflection.

1.6.6 Loading Succession

Timing and the loading succession are key factors in defining the deflection of a pendent concrete slab due to their effects on the point where the slab is cracking. In addition, they can be used to compute the creep for the concrete slab. The loading succession may vary, however, depending on the technique of construction: casting additional concrete slabs above results in smaller imposed loads, hence, the erection of partitions and floor finishes causes perpetual increases of the loads. Eventually, the alterable reaction exercised on the concrete structure along with quasi-perpetual incorporation may be used to compute the deflection, as indicated by The Concrete Centre (2011). There is a probability of quasi-permanent integration being exceeded through the life span of the structure, however. In addition, frequent integration may reach a critical point, while defining the crack in the slab.

Market pressure predominately result in more demand hit the formwork earlier in the construction process, with the construction of subsequent floors commencing with minimal propped sections. A flat slab test result indicated that 70% of loading from the freshly casted floor above (construction loads, formwork and wet concrete) is supported by the suspended floor below. After installing the partitions and/or cladding, normally, adding load to the formwork earlier creates no excessive effect on deflection

due to cracking slab before partitions and/or the cladding installation, where the deflection effectiveness on partitions gets smaller.

1.7 Deflection Checking Methods

Eurocode 2 is one of the most advanced design codes available, sufficient for use in checking deflection by calculation. The technique for calculating deflection in Eurocode 2 is the deemed-to-satisfy span to-effective-depth ratio. These methods are compatible and economic for use with large designs (Moss and Brooker 2006).

Some conditions where direct deflection computation is required, are listed below:

- If an assumption of deflection is needed
- If the deflection limits are not adequate for the span/250 for quasi-perpetual behaviours, or span/500 for partition members and/or cladding load
- Direct examination of deflection proposes an economic solution, when the design demands a specific shallow section
- To define the impact on deflection of premature striking of formwork or of interim load construction periods on the structure

The Concrete Society (2005) indicated in its technical report no. 58 that finite element methods are generally considered as the functional methods to obtain actual values of deflections. Limiting quasi-permanent, long-term, and deflection to span/250 is normal, however, unless a specific demand is required, and if cladding or brittle partitions have been supported, to control the movement influencing to span/500 (Tovi et al 2016).

The deflection of slab structures subjected to various loads increases as a result of shrinkage from losing moisture and creep due to the applied load. The methods of

structural design engineering used to predict deformation define the immediate reaction of the constructed structure when subjected to the applied load. In addition, though, a magnification of the initial deflection occurs due to time dependent elements of shrinkage and creep.

Time has a significant impact in terms of changing the rate of deformation in construction structures. It was argued by Heiman and Taylor (1977) that five years is a crucial time for the displacement to reach peak value, and although time dependent deflection can be computed at any time period, the prevalent procedure for design purposes is to assess the ultimate value at five years.

Various concrete construction projects and designs have demonstrated the constraining dimensions in slab system structures, with thickness reduction in slabs having impacts on the structure. Furthermore, reinforcement is required to obtain substantial strength, and to ensure serviceability limits are met to control the cracking. The long-duration deflection prediction requirement and an appropriate degree of accuracy for one-way system slabs and two-way system slabs are explained by the reaction of extreme deflections.

The deformation of large slabs may cause cracking in finishes and partitions, damaged windows and doors, inadmissible flooring slopes and roof ponds. Heiman and Taylor (1977) stated that deflection increases due to loading slabs throughout the construction period during supporting procedures. Loading normally occurs at early stages, resulting in extreme cracking and slabs losing stiffness.

Slabs are comparatively thin structures for spanning, which means that deflection is a crucial consideration at the design stage. Due to lower costs and ease of use, slab

systems are the most popular form of constructed structures, and as a result, structural engineers innovate new ways to construct slabs efficiently.

1.8 Deflection Calculation Methods

The best methods for calculating deflection are recommended by The Concrete Society (2005) technical report no.58, as presented below:

1.8.1 Rigorous Method

The rigorous method is the most useful method for calculating deflection; it is an appropriate technique to define an actual assumption of deflection but should be used with computer simulation only. Numerous spreadsheets have been presented by The Concrete Centre using the rigorous method to define the deflection calculation for various types of slabs and beams, as indicated by Goodchild and Webster (2006). The rigorous method is a cost-effective guide to execute particular deflection computations, in addition, it contains the capacity to recommend the effect of early stage loading on the slab structure. In addition, using finite element analysis may also be useful to generate a predictive value of deflection.

1.8.2 Simplified Method

A simplified method is practical for computing deflection by hand calculation, and is also useful to estimating and verifying deflection value results from computer programs and/or where the program or computer are not available. The essential simplification of this method is that the impacts of loading at the early stage are not accounted for specifically. In fact, when computing the cracking moment, an allowance is produced for the impacts. The deformation from the curvature of the concrete slab is simplified and considers creep.

1.9 Research Structure

The layout and structure of the thesis is presented below. The thesis is divided into Eight Chapters.

Chapter One: Introduction

This chapter lays out the general background, current knowledge, the aims, the research questions, objectives of the research and the structure of the research.

Chapter Two: Literature Review

This chapter presents a critical literature review of the deflection of slabs and the fundamental deflection problems that underlie the objectives of the research. These include the experimental studies and technical methods to control deflection of slabs. In addition, the chapter presents current work in the area of developing appropriate study cases.

Chapter Three: Methodology and Construction Site Investigation

This chapter proposes the design of the research. The research is based on a quantitative methodology which is underpinned by advanced structural analysis of the Eurocode 2 requirements and sensitivity testing to analyse and model the impact of variable current and future deflection patterns on detached flat slab reinforced concrete. The site investigation analysis aims to identify input parameters and various passive design scenarios which have a significant effect on deflection of flat slabs and serviceability limit state performance design. The chapter presents the methods used in the site investigation process and the data collection over a period of 142 days.

1.10 Research Contribution

The contribution of this research is to confirm that the Current Performance and the Design Deflection Limits in the Eurocode 2 (2008) calculations and tabulated values are acceptable.

It is highly recommended that this research project should be extended by using different methods to investigate the deflection of reinforce concrete slabs for longer periods (of 1-3 years). Investigations over a longer time scale using a range of equipment and methods will give more data than can be obtained from the use of an Hydraulic Cell Levelling system in isolation.

It will be interesting to carry out comparative research between various methods of deflection calculation and the results of this research project to obtain a complete perspective on Current Performance and the Design Deflection Limits to the Eurocode 2.

Chapter Four: Hydrostatic Cells Levelling

This chapter investigates the use of the Hydrostatic Cells Levelling (HCL) method to determine deflection of reinforced concrete flat slabs and for remote data collection to the GETEC server. The results points to the use of this approach as a credible statistical validation method for evaluating the agreement between monitored and simulated structural analysis software using a network of sensors.

The HCL system detects the changes in hydrostatic pressure relative to a reference cell which is located out of the zone of influence. The change is used to calculate the vertical deformations.

GETEC HCL provides an accurate and near real-time method for measuring vertical movements.

Chapter Five: Deformation of Multi-Storey Flat Slabs, a Finite Elements Analysis and Precise Levelling

This chapter explores the simulation software and computer interfaces involved. Bentley and ETABS supplement computationally complex analytical choices such as dynamic nonlinear behaviour, and powerful CAD-like designing tools in a graphical and object-based interface to give the profession the ultimate efficient and complete software for the analysis and design of structures.

This chapter also provides calibration of Finite Elements packages for monitoring the deformation of structures with flat slabs and presents and discusses the experimental results for the vertical deformation. Computational simulation by using Bentley and ETABS has been used to analyse and determine deflection on reinforced concrete slabs according to Eurocode 2. In addition, Precise Levelling has been used on Elephant & Castel construction site Block H10C to observe the deflation on flat slab.

Chapter Six: Evaluation of Column Shortening in mid-rise Concrete Structures

This chapter aims to investigate the effects of ambient temperature, relative humidity, cement hardening speed and aggregate type on concrete column shortening. The investigation was conducted using a column shortening prediction model which is underpinned by the Eurocode 2.

The phenomenon of concrete column shortening has been widely acknowledged since it first became apparent in the 1960s. Axial column shortening is due to the combined effect of elastic and inelastic deformations, shrinkage and creep.

Chapter Seven: Analysis of Results and Discussion

This chapter discusses and analyse the site investigation and specifies the allowable tolerances that the primary structural frame should be constructed to achieve. It also describes the movements that the structure will experience during construction and the lifespan of the building.

This chapter is intended to analyse the allowable positional variation of the structure due to movement and construction tolerance, and to advise as to what structural movements need to be allowed for in follow-on trades and interfaces.

Chapter Eight: Conclusions

The final chapter summarises and highlights the main outcomes drawn from the preceding chapters and presents an overview of the conclusions of the research. The practical application of the findings and the modest contributions of this research to knowledge are also pinpointed. This is followed by recommendations for the logical continuation and development of the research.

CHAPTER TWO: Literature Review of Deflection of Slabs

Concrete flat slabs designed to the span/depth rules in the Eurocode 2 and its predecessors have usually performed acceptably in service. However deflection in flat slabs is a complex issue: the relevant loads are commonly long-term and actual deflection depends on construction and loading history as well as on loading Eurocode 2 (2008). A full analysis of the relevant experiment data and theory to try decide exactly what the 'correct' span/depth ratios are for all circumstances would be a major research project.

2.1 Deflection of Slabs

The deflection of concrete slabs is significantly complicated by the degree of cracking and time dependent concrete properties. The deflection of structural members can be accommodated in the design stage without causing damage to partitions or finishes. The problem can be tackled by considering immediate and long-term deflections separately, as discussed below.

Goodchild (2000) approached the deflection of flat slab reinforcement by referring to a report presented in Vollum (1999) explaining the difficulty in predicting the deflections of flat slabs at the design stage in the field due to the following factors:

- Long-term service load
- Constructed loads/strength of concrete at shrinkage
- Tensile strength of concrete
- The exact position of steel reinforcement
- The exact thickness of slabs
- Coefficients of shrinkage and creep

2.1.1 Instantaneous Deflections

To calculate instantaneous deflections of flat plates subjected to a uniform distributed load classical elastic plate theory is used, which is based on thin isotropic plates and small deformations.

Timoshenko and Woinowsky – Krieger (1959) proposed an equation where deflections can be calculated at point (X, Y) by solving the plate equation:

$$\frac{\partial^4 \Delta}{\partial X^4} + \frac{2 \partial^4 \Delta}{\partial X^2 \partial Y^2} + \frac{\partial^4 \Delta}{\partial Y^4} = \frac{W}{D} \quad (\text{Eq. 2.1})$$

Where:

$\Delta = \text{deflection at point } (X, Y)$

$W = \text{transverse load}$

$D = \text{flexural plate rigidity} = \frac{E_c h^3}{12(1 - \nu^2)}$

$h = \text{plate thickness}$

$\nu = \text{Poisson's ratio}$

$E_c = \text{modulus of elasticity}$

The method been catalogued by Timoshenko and Woinowsky – Krieger (1959) for numerous isolated plate cases. However two way cases continuous floor system need to be consolidated by using indeterminate structural solution techniques, although sacrificial solutions have also been stated by Timoshenko and Woinowsky – Krieger (1959) where plate moments are calculated anticipating coefficients tabulated according to support conditions and panel aspect ratio. Coefficients are also progressed to calculate centre panel deflections for standard interior flat plate panels supported on a column.

The standard for two-way slab design is an equivalent method in both the Canadian Standards Association (CSA) (1997) and American Concrete Institute (ACI) (1983). The slab system is convergent by continuous frames centred along column lines in both directions. This method was initially outlined by Peabody (1948) for continuous elastic frame analysis.

Vanderbilt et al. (1965) also described a method to calculate deflections based on an equivalent frame approach. A continuous slab system is broken into beam and plate elements bounded by lines of anti-buckling (contraflexure). The mid-panel point deflection consists of the centreline deflection of a long beam in addition to the deflection of the beam edge with respect to the centreline as well as the deflection of the plate element.

Nilson and Walters (1975) proposed a more direct application of an equivalent frame procedure. The method calculates deflections for orthogonal middle and column strips separately, and employs superposition to obtain definitive mid-panel deflection. Kripanarayan and Branson (1976) extended this method to include the effects of cracking when calculating the deflections. The equivalent frame stiffness is modified by using a weighted average for an effective inertia period computed at the positive and negative moment locations.

Rangan (1976) proposed a calculation for mid-panel deflection of a flat plate as the sum of the mid-span deflections of the column – beam strip in the long direction, and middle beam strip in the short direction. Strips were taken into account separately, with the beam taking a uniformly distributed load and applied end moment. A similar approach was applied by Scanlon and Murray (1982), with the equivalent uniform strip load and actual beam moments in the deflection calculation has been predicted.

The most efficient way to approach the plate analysis is the finite element method, however, which provides a more comprehensive approach to plate analysis than the equivalent frame methods described above. Taking into account that most finite element programmes apply linear elastic analyses, Jofriet (1973), Jofriet and McNeice (1971), Scanlon (1971), and Scanlon and Murray (1982) contemplate the inelastic framework by considering element stiffness matrices to calculate flexural concrete cracking.

2.1.2 Long Duration Deflections

The fundamental combinations of long duration deflections of concrete members are creep and shrinkage. In order to calculate the additional creep and shrinkage deflection based on a computed initial elastic deflection, it is essential to use a simplified multiplier approach, as shown by Washa and Fluck (1952), Washa and Fluck (1956), and Yu and Winter (1960) on a cracked beam subjected to sustained loading. The essential additional creep and shrinkage multiplier is embraced by the American Concrete Institutes (ACI 1983).

In the case of a one-way system the equation below can be used:

$$\lambda = \left[2 - \frac{1.2A'_S}{A_S} \right] > 0.6 \quad (\text{Eq.2.2})$$

Where:

$\lambda = \text{additional long duration deflection multiplier}$

$A_S = \text{tensile steel area}$

$A'_S = \text{compressive steel area}$

The actual technique can also be used to calculate two way systems. Concrete slabs are known to rarely contain considerable amounts of compressive steel, which leads to the instantaneous elastic being doubled, leading to additional long duration

deflection due to shrinkage and creep. Branson (1977) tackled the deflection caused by creep and shrinkage by developing a procedure to calculate the creep and shrinkage deflections that has been summarised by the American Concrete Institute (ACI) (1982). This technique is useful for design use in spite of demanding the input of a lot of parameters. Scanlon (1971), meanwhile, managed to merge time dependent effects instantly into a finite element analysis of concrete slabs deflections, which is quite useful in developing appropriate serviceability demand and straightforward deflection calculation methods. In addition, the American Concrete Institute (ACI) (1982) calculation of instantaneous deflection uses an initial elastic finite element analysis method implementing a multiplier approach simultaneously with effects of cracking to compute additional long duration deflection.

Goodchild (2000) assumed that the prediction of deflection may require effective load to be approached by a solitary long term load and a solitary value for the material properties of the concrete to present:

- Coefficients of shrinkage and creep
- Concrete's elastic modulus
- The tensile strength of concrete

Loading, and the selection of adequate material properties plays significant roles of concrete deflection.

2.2 Maximum Deflection

Examination of ultimate deflection relies on the loading history of the building, at a twenty eight day period, with the ultimate service loads applied contrasted with those loads that may vary in volume and the period of application.

Generally fresh concrete slabs in multi-storey flat slab construction are propped by other formally cast concrete slabs from a range of types: propped, and re-propped, recognised as floor supporting floor. Supporting commonly depends on vertical posts, horizontal liners and cross members that provide support for the formwork, as well as slabs that are freshly casted to lower levels. Propped designs are comparable to re-propped ones to free formwork for use on subsequent levels.

Primarily, re-propped designs uphold negligible load, as explained in more detail by Nielsen's (1952) analysis of load distribution between connected propped and floor slabs. Nielsen's procedure treats the deformation characteristics of the slabs and props, showing that the slabs and props that uphold construction loads have an explicit load ratio that can be determined by using the equation below:

$$k = \frac{\text{load carried by slab}}{\text{slab+formwork weight}} \quad (\text{Eq.2.3})$$

Where: $k = \text{construction load ratio}$

Nielsen managed to calculate the maximum load ratio on a concrete slab and found it to be 2.56 taking into account three levels of props. Meanwhile a simple method was developed by Kabaila and Grundy (1963) to tackle the distribution of load between slabs throughout the construction period, considering the suppositions below:

- Props are indefinitely solid in vertical displacement compared to slabs
- Props will react as a distribution load if they are located close enough together
- The applied load is distributed among the slabs related to their proportional flexural stiffness

The maximum load ratio for concrete slab sections occurs when the props connecting the supporting assembly with the ground floor are removed, and the ratio increases

for upper levels. For the same section suggested by Kabaila, Nielsen and Grundy obtained an absolute value of a maximum load ratio of 2.36, while the obtained value for upper levels was 2.00. Changing the number of propped floors has a small influence on the maximum action ratio value, with a decrease in the number of propped floors decreasing the age at which the maximum ratio for the reinforced concrete slab, thereby leading to a further critical situation.

Analysis carried out by Kabaila and Grundy showed that if the stable flexural stiffness for the upholding assembly slabs is altered, the distributions of loads among the slabs will be affected, due to cracking of slabs during the construction period. The maximum load ratios calculated earlier decrease by 10 percent for the supporting slabs due to the effect of cracking on the load distribution factors, as Sbarounis (1984) determined. Using a system of props and floors in order to rule the construction loads requires the use of Beresford and Blakey's (1965) method of a stepped sequence of construction, involving the casting of fresh slabs and giving additional time to evolve adequate strength ahead of the application of a construction load. While Taylor's (1967) method of stripping formwork to decrease the impact loads on slabs over construction time, recommended loosening and straining adjustable props ahead of each new slab that is cast; in this case, the loads which are distributed to the slabs and props are indeed reduced. Practically, to make this technique functioning properly, all props need to be loosened simultaneously at one level, this leads to a reduction in the maximum load ratio from the 2.36 which was achieved by Kabaila and Grundy, to 1.44, which is Taylor's value.

Grander and Agarwal (1974) expressed their agreement through field measurement techniques that calculated construction loads, and other reports have suggested the main maximum measured load ratio to be greater by 4 percent than the corresponding

theoretical value in the case of a multi-storey flat slab building with fifteen floors, as in Ng and Lasisi (1979). In addition to dead loads, a live load impact report from Hurd (1967) for a formed design suggests a minimum construction live load of 2.4 kPa, although there is no consideration of Kabaila and Grundy's theory to any construction live loads in calculating the predicted load distributed to props and slabs. Nonetheless, Ng and Lasisi's (1979) theory approaches to a technique summarising the effect of live loads. A construction live load of 2.4 kPa extracted after the day of casting, and a constant E_c for slabs connected in one resupport level plus two support levels in a flat plate structure supporting assembly, results in the ultimate maximum load ratio exceeding the Kabaila and Grundy maximum load ratio by 9 percent. In the supporting assembly, the calculated construction live load results in an increase of the ultimate load held by the lowest slab, as Agarwal and Gardner (1974) and Sbarounis (1984) indicate, while an additional load was recommended by Sbarounis for both cracked and uncracked slabs.

2.3 Cracking Impact on Concrete Slabs

Applied loads cause cracking in slab members, but cracking may also occur due to restraint of shrinkage. Bending moments develop due to loading of the concrete, resulting in flexural cracking that will exceed the cracking moment, which is the immediate result of the tensile strength of the concrete. Concrete curing practicability depends on various atmospheric conditions such as wind, humidity, temperature and concrete strength properties at an early age. Also, the degree of cracking in concrete will increase as a result of warping of slab sections, causing shrinkage due to bad curing status.

Concrete's effective tensile strength will be reduced and may also increase cracking in slab systems due to restraint by reinforcement, column supports and adjacent

panels. The bending stiffness of slab panels decreases as a result of cracking effects. Mid-panel regions will also get their share of overall cracking in flat plates, in spite of developing around panel supports in most cases; as a result adjacent locations will develop further cracking as a consequence of moment redistribution.

Long term and initial panel deflections increase as the slab stiffness is reduced, and by reducing the flexural stiffness in the cracking territory, the impact of cracking can be calculated. When concrete slabs are subordinated to a moment higher than the cracking moment, a sophisticated experimental relationship proposed by Branson (1963) can be used to compute an effective moment of subsidence. Other studies have tried to understand the mechanism of deflection by making further delicate assessments of density and cracking distribution in flat concrete slabs. A considerable degree of cracking was assumed by Heiman (1974) to obtain better results for much smaller deflections than the actual measurement in the case of four separated slabs of inertia procedure by using American Concrete Institute (ACI) effective moment.

In middle strips, using the full cracking moment of subsidence is recommended by Ragan (1976) for column strips and fully uncracked and cracked average moment of subsidence. Ragan's proposal corresponds to Heiman's recommendation of calculating the deflection of slabs, but Heiman's technique is perhaps not suitable for all cracked slabs.

Furthermore, Murray and Scalon (1982) proposed a more comprehensive method to compute the cracking effect, comprising of the effects as a consequent of restraint. Cracking estimation within slabs relies on precise prediction of a slab's deflection. The most common sources of cracking in a slab are exceeded moments as a result of loading, in spite of restraint and shrinkage, and these may cause a considerable

degree of cracking. Throughout the construction period, a considerable load may develop simulating this moment into slabs. In fact, decreasing tensile strength at an early stage will cause concrete to develop more extensive problems.

2.4 Deflection Calculation

Site investigation measurements of two-way concrete slab deflection are not extensive. Australia and the US have managed to document a significant amount of data related to plates and flat concrete slabs, but there are only a handful of research studies that indicate the deflection problems of one-way and two-way slabs. It is worth mentioning, however, that regulations and construction property materials are likely to vary in different countries.

Vollum (2004) published a report on deflection by analysing the backdrop forces at Cardington, indicating that the load on a slab occurs when the slab above is cast. The report concluded that a major proportion of the load from casting the slab above was carried by the upper floor in a supporting assembly, differing from the conventional understanding that the load is distributed evenly between floors. The result was inspected at St George's Wharf when the back prop forces were calculated on the sixth floor during construction. The report at Cardington confirms that most of the derivations drawn from investigation into construction loading and deflection are valid for the intended purposes. The most substantial conclusions are:

- engineers should consider that flat slabs are subjected to peak construction loads and thus model slabs accordingly
- back prop forces may be considerably underestimated in elastic analysis if there is overloading as a result of neglecting temperature and preloaded actions

Empirical research into flat plate lightweight concrete carried out by Blakey (1961) indicated that the deflection ratio after a 200 day period was 7 for an interior panel in the middle position related to the deflection of the primary dead load. Blakey (1963), however, developed this work to show the ratio of deflection in a structure characterised by three bays spanning 9 ft (2.74 m) in one direction and another three bays spanning 12 ft (3.7 m) in the other direction, with a long direction of 4.5 ft (1.4 m) cantilevers. This case utilised a 3.5 mm thick flat plate of lightweight concrete that was subjected to self-load only for a period of eight months. Blakey concluded that the extent of the deflection at the middle region of the interior panel increasing by 12 times in comparison with the initial elastic deflection. Of this examined deflection, 20 % was attributed to differential column settlements, 40 % to additional cracking resulting from reduced stiffness and to local bond slip, and 40 % to creep. It was recorded that the reinforced concrete slab was constructed of expanded shale concrete that underwent fluctuations in relative humidity and temperature, and was exposed to direct sunlight during the observation and construction time.

Branson (1977) approached the deflection calculation in a different way by taking nine panels and using normal loaded two-way slab system to tackle the deflection problem. Each panel was 6 ft (1.8 m) square with deep beams in proportion. Branson designed the experiment for a period of 500 days ahead by loading the structure using sand bags at 30 days. Thus, the time dependent maximum ratio to initial deflection converged to five.

Taylor (1970) examined long-term deflections for a concrete slab constructed in North Sydney, Australia. The longer span/depth ratio was 31.0. Ratios of initial three day deflection calculations to those considered 2.5 years later indicate increased from 6.5 to 10 for deflections at the middle of interior sections. The previous theory suggested

that the partial cause of the high multipliers is the concrete properties of shrinkage and higher creep. Branson's (1977) technique obtained superior outcomes when creep and shrinkage deflections were individually investigated compared to long-term deflection calculations, subsequently resulting in cracks in the concrete slabs.

The deflections of flexural sections in four different Australian structures were examined by Heiman in (1974). The reinforced concrete slab structural systems considered were:

- A flat plate roof in a two storey commercial structure ($L/h = 31$)
- A flat slab in a three storey unenclosed car park ($L/h = 36$)
- A flat plate in a four storey motel and car park ($L/h = 31$)
- A tapered beam and slab structure in a fifty storey circular high altitude structure ($L/h = 21$) for beams

The investigation was carried out for a period of eight years, and the deflection ratio monitored and recorded for the period between two and half to eight years. The slabs in the first two systems were propped to upper slabs or directly supported on the floor below, resulting in a small amount of construction load. The long term to premier deflection ratio was 8.7 for the first structure and 5.1 to 6.3 was the range ratio for the second structure. In both structures (first and second) shrinkage deflection was suggested to be the main factor, while the remaining structures (third and fourth) were subjected to heavy construction loads from slabs cast above. In the third structure, additional deformation and slab loading during the construction period were stabilised by supports onto the ground directly.

At the early age of construction, loading will have an impact on spurious cracking as Heiman (1974) concluded for all four structures by using American Concrete Institute (ACI) code method and Branson's method, whereby long-term deflections were calculated. Using the former method, the calculated deflection 34 to 67 percent was the range below those calculated, with the latter method calculated deflection ranged from 13 below to 17 above. The second pattern was dependent on the assumed degree of cracking in the reinforced concrete slabs.

A flat plate construction in Australia was investigated and reported by Jenkins (1974) on the fourth floor of a five storey building; the report recorded a deflection ratio of approximately 4 after one year dead load to the initial 10 years' deflection. Massive construction loads were supported by the slab, and the heavy load was from the floor slab above and bricks stored for the partition structure.

Sbarounis (1984) explored the deflections for a flat plate multi-storey structure in the US. The investigation was carried out over a period of a year on 13 floors alternately, with measurements taken over 175 days. Sbarounis noted that the calculated deflections were exceeded by one inch at one year in almost 90 % of cases and, as a result, 36.4 was the longer span to depth ratio. Sbarounis (1984) assumed 4.2 as a multiplier for one year to calculate the long-term deflections, which is in close agreement with the average of the calculated deflections for the one year period.

Due to the shrinkage and high creep associated with concrete, greater multipliers could be attributed, especially if the construction is taking place in severe environmental conditions. Concrete slab structures under intensive load early in the construction period will eventually develop cracks and decrease in stiffness. Greater

premier deflections cause further deflections and eventually a comprehensive deformation effect on structures.

2.5 Design Code Limitations for Deflection

The minimum thickness of a one-way slab system and two-way slabs systems is the standard principal definition code limitation for deflections, considering column sizes, the shape of the panel, drop panel and/or presence of edge beams, spans, the edge panel's effectiveness, reinforcement grade and size of the supporting columns.

If a reinforced concrete flat slab meets the minimum thickness requirements deflection need not be calculated. For thinner concrete flat slabs, calculated deflections should not exceed the required limit. These limits pertain to instant imposed load deflection and long term deflection resulting after the attachment of non-structural factors due to sustained action. And instant deflection due to any further imposed (live load) action. The additional long term deflection is calculated as a multiple of the instant elastic deflection, normally 2 for slab systems.

There are no individual provisions calculating the influence of live loads at an early age. Increased cracking may result in greater instant deflections. Any underestimation of the instant deflection may be magnified when a multiplier method is considered to compute additional long-term deflection. In addition, the maximum live load could be greater than the total service loads that are considered to examine the serviceability limits required in the code. Both these elements could cause unsatisfactory deflections in reinforced concrete flat slabs otherwise meeting code specifications.

Goodchild (2009) indicated that determining deflections are usually presented as $\text{span}/250$ for overall deflection, and for deflection after non – structural installation, the determining deflection is $\text{span}/500$. Realistically, the codes set ultimate limitations but

achieving the span/250 limitation is Eurocodes's objective. Hence, modular construction may demand accurate measurements and estimates of deflection.

Realistically, not enough details are available from Eurocode 2 to indicate which members of a structure will be highly or lightly stressed. While Beeby and Narayanan (1995) indicated that slabs generally will be lightly stressed, beams will be stressed more heavily. Eurocode 2 (2008) presents a deemed-to-satisfy span to depth ratio technique to ensure acceptance with admittance criteria, resulting in adequacy and economic resolution. While such techniques are not intended to predict the deflection on each member, computing deflections could be desirable in some circumstance:

- Accommodating the amount of motion may have a considerable economic effect on fixing partitions and cladding
- The rigorous approach leads to less reinforcement members or smaller members (i.e. an efficient economic design)
- If deflection predictions are demanded or certain deflection limits are additionally fatigued than the ones recommended by the standard construction code should be used

The Concrete Society (2005) indicated in technical report no.58 that grillage and finite element methods are generally considered to be functional methods to obtain actual values of deflections. Limiting quasi-permanent / long-term deflection to span/250 is normal unless a specific demand is required, but if cladding or brittle partitions are being supported, control of the motion is set to span/500. In such circumstances it is necessary to execute a supplementary programme to estimate deflection values.

Table 2.1 Recommends Traditional Limiting Design values of Horizontal Deformations as Function of High H of Structure or High H_1 Building (Euro Code 2).

| Serviceability requirement | Functioning of structure | Comfort of uses | Appearance of structure |
|---|---|-----------------|-------------------------|
| Combination of actions to be considered | Characteristic | Frequent | Quasi-permanent |
| Single-storey building | $H/400$ | | |
| Multi-storey buildings: -in general -with brittle Partition Walls | $H/200$ $H/500$ | | |
| L/d (deflection check) | EN1992 rules inaccurate: reviewed rules demanded. (TCC has done some work in this region, however needs to be worked up, extended, validated and published) | | |

2.6 Compendium

A survey of the computed methods for one-way and two-way slab system structures was presented from the obtainable literature. Examples of finite element methods, equivalent frame and elastic plate theory were discussed. Other factors affecting deflections, such as cracks, shrinkages and construction loads, were reviewed. Additional authenticated studies and reports on deflections of concrete slabs were surveyed and a summary of the demands in the controlling deflection codes was presented.

Serviceability and strength are the two main objects to consider in designing concrete structures to be sufficiently ductile and strong enough to stand strain, resist collapse due to overloading, excessive forces and various environmental conditions that may be imposed, while also providing satisfactory performance without cracking, extreme vibration or deflection.

2.7 Shortening of Columns

Shortening of concrete columns and walls occurs due to shrinkage, creep and elastic compression, although the influence of this is not significant for structures less than about 10–15 storeys, as indicated in Concrete Society Technical Report no. 67 (2008), concrete buildings, walls and columns shorten by various amounts and at various times.

Examination of vertical shortening has to consider the following:

- Axial force. Any increment of action develops primary elastic strain which increases over time due to creep.
- Shrinkage. Shrinkage develops immediately the early thermal contraction cycle has occurred, and then continues at a decreasing rate.
- Construction sequence. Every new level is cast at a floor which overrides all the shortening which has happened beneath it.
- Loading sequence. After a level is established, the remaining action is added gradually, normally in the sequence: screed or raised level; partitions and walls; furniture and occupants; ceilings with lighting and other services.
- Time-dependent effects. The overriding dilemma is that shrinkage and creep are both very much dependent on the age of the reinforced concrete section,

and with every level cast at a various time the ultimate shortening at any one time is the aggregate of movements which all began at various times and have developed to various phases.

- Differential shortening. Usually it is differential shortening which is significant, especially between reinforced concrete columns, which are usually intensively loaded, and core walls, which are generally exceedingly lightly loaded.
- Shortening in a single floor height is significant for added members that are not elastic, such as partitions and cladding.

Technical Report no.67 (2008) recommends the shortening of a panel of columns (various concrete strengths and restraint percentages) and concludes that an ultimate shortening of 1.4 mm/m is possible, i.e. 4–5 mm in a typical structure height. The Report indicates that it is hard to reduce is considerably. A better technique is to limit the differential shortening by calculating all reinforced concrete columns to the same standard, and by conserving long obvious spans between various structural shapes, for instance, between interior reinforced concrete columns and shear walls and cores on the one side and perimeter concrete columns on the other.

Standard design code rules concentrate on structure to withstand externally applied actions, deriving the restraint needed to withstand axial actions, shear stresses and bending moments. Many reinforced concrete sections are lightly loaded, however, or are influenced especially by other loads, such as early-age shrinkages, creep, temperature and humidity effects, as well as long-term drying shrinkage. These all produce movements, and although they hardly define the total capacity, they significantly affect serviceability, especially through cracking. The Technical Report no.67 takes into account the different forms of movement and their constriction time.

Any deflection or cracking is generally the outcome of, at least, temperature and shrinkage added to early-age effects, albeit with significant contributions from other sources. The significance of movement is very dependent on whether the concrete is reinforced or not; although all reinforcement is partial since reinforcements will normally apply under the significant stresses that may be produced. In addition, creep is useful in decreasing the stresses generated by reinforcement, particularly at early ages. The probability of cracking occurring is very hard to estimate, and the technique suggested by the Report is to predict that cracks will develop and to apply adequate restraint to control them.

2.8 Precamber

Reducing the effect of deflection below the horizontal can be achieved when the slab is precambered, in practice, however, excess precamber causes the slab to remain constantly cambered due to the difficulty of adequately computing the deflection. The Concrete Society (2005) indicates the use of a precamber of up to half the quasi-permanent calculation deflection, however, a lower value is recommended. In conclusion, deflections affecting cladding or partitions cannot be deducted using precambering.

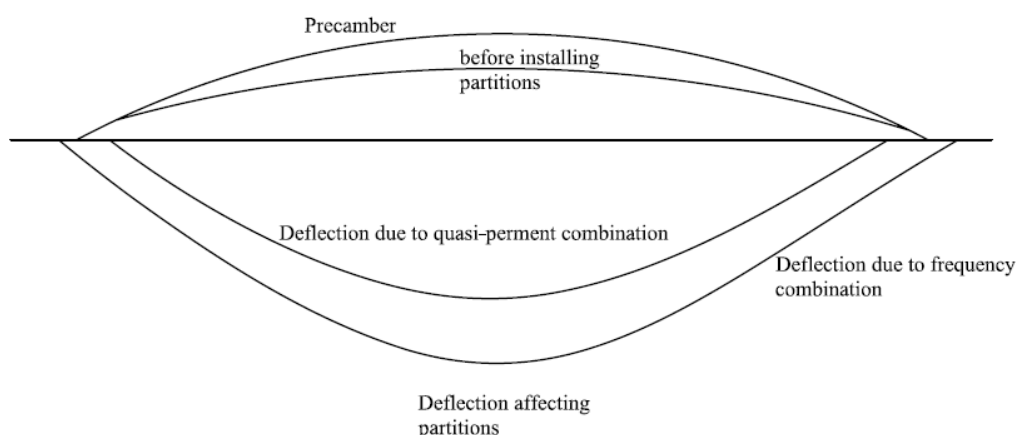

Figure 2.1 Slab Precambering

2.9 Accuracy of Eurocode 2

Eurocode 2 presents the rigorous method as the most accurate method for calculating deflection and is more advanced than BS 8110 (1997). The reliability of the rigorous method considers the early stage construction loading by accounting for the reduced early tensile strength of concrete. In spite of Eurocode 2's recommendation to use the rigorous method, the impact of the factors listed below cannot be estimated accurately:

- elastic modulus
- construction loading
- tensile strength (defines the cracking moment)

The calculated values of deflection are assumed values only. Thus, the most advanced analysis methods still result in a +15% to -30% possibility of error. An appropriate caveat should therefore be recommended with any assessment of deflection calculations for use during the construction process (Eurocode 2 2008).

2.10 Flat Slabs

Flat slabs are the most efficient and popular method for constructing floor system structures, due to their bi-directional behaviour, however, calculating their deflection is not an easy process. The Concrete Society (2005) in technical report no.58 presented a number of methods for estimating flat slab deflection. The most suitable and popular method is to calculate the average deflection for two parallel column strips, adding the deflection of the middle strip orthogonally to obtain the maximum deflection of the slab in the central region. Simulated flat slab satisfied criteria are detailed in (Figure 2.2) (The Concrete Society 2005).

When maximum allowance $\delta = \frac{L}{n}$ and X is the position of maximum δ , where

L = Span, n = Limiting span-to-depth ration, e.g. 250

Hence, the deflection at $X < \frac{2a}{n}$, (the deflection could be more critical on the gridline)

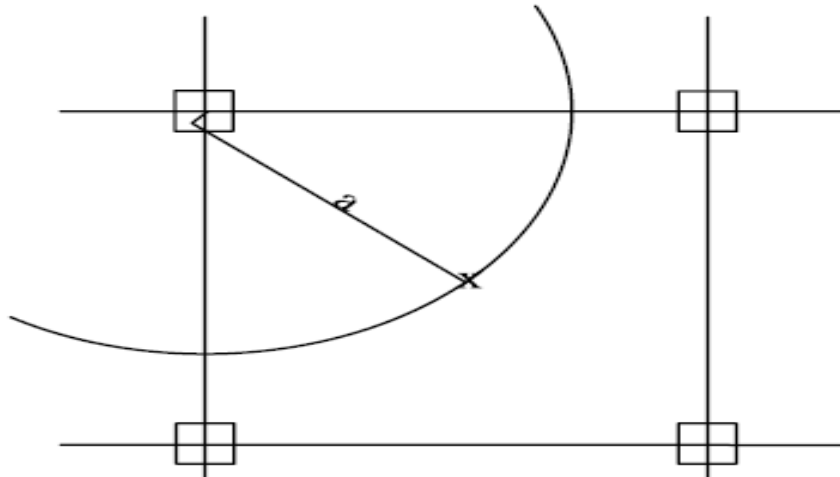

Figure 2.2 Simulated Flat Slab Satisfied Criteria

2.11 Cladding Allowances

Cladding or glazing occurs due to deflection as detailed below: deflection results in reduced loads on central fixing parts of the slab with a shift to the external fixings

- A deflection of 5 mm may be accommodated by a glazing system, as industrialists may claim
- The load will be alleviated on the central fixings due to slab deflection, and the load will shift to external fixings

Structural engineers are recommended to investigate a variety of options to define a suitable and cost-effective technique to approach the deflection and its effectiveness on slab structures and cladding.

2.12 Combined Reaction

Reinforced concrete structures are durable strong structures, with the ability to be formed into various shapes and sizes, from simple shapes like rectangular columns, to more complicated shapes like shells and curved domes. Combining the features of steel and concrete results in the versatility and utility of reinforced concrete. A comparison Table 2.2 between concrete and steel reveals their vastly different properties as shown below:

Table 2.2 Material property comparison between steel and concrete

| Properties | Steel | Concrete |
|-------------------|---|-----------------|
| Compression | Good (slender bars may buckle) | Very Good |
| Tension | Good | Poor |
| Fire resistance | Poor (at high temperature cursory loss of strength) | Good |
| Shear forces | Good | Reasonable |
| Durability | Oxidation and corrosion if unprotected | Good |

It is clear from the comparison table that both materials are complementary so that, when combined, concrete obtains the tensile and shear strength of steel, while the steel obtains the fire resistance and durability of concrete.

Concrete shrinks and dries, resulting in the appearance of fine cracks, which may develop into larger cracks when subjected to tensile stress. If the cracks remain uncontrolled, this will eventually cause concrete to lose its durability and fire resistance, and will leave the structure with an unattractive appearance. Normally, cracks of 0.3 mm width are considered to be acceptable as Eurocode 2 (2008) indicates, however, reinforcement is demanded to control these fine cracks and

prevent larger cracks. It is important to understand that the reinforcement functions to prevent the cracking from increasing rather than to prevent the cracking from taking place, hence numbers of micro cracks are more acceptable than a single wide-open crack. Crack widths may be controlled by following the demanded minimum magnitude of the reinforcement; more details on which can be obtained from (Eurocode 2 2008).

The majority of reinforced concrete constructions are constructed on the assumption of non-resistance to tensile strength due to their poor tensile strength compared to their compressive strength. Hence, reinforced structures needed to transfer such tensile strength by bonds through the interface of concrete and steel. In order to obtain maximum composite action between these two materials, the bond should be designed accurately to avoid any slips of reinforcing bars within the concrete section. Concrete sections should therefore be well detailed and designed so as to obtain a well-compacted concrete section, considering compact reinforcement through the construction period. Additionally, the composite structures normally obtain extra self-load grip due to ribbed bars.

The need for a perfect bond is normally assumed in the design and analysis of composite steel-concrete reinforced sections, so as to achieve an identical strain in the adjacent concrete as in the reinforcement section, thus ensuring the compatibility of strains along the cross-section of the structure. The coefficient of thermal expansion of concrete is 10×10^{-6} per °C while that of steel is $7 - 12 \times 10^{-6}$ per °C; these are sufficiently close to mean that questions of bonding seldom emerge from the distinct expansion between concrete and steel over an average temperature range.

A simply supported reinforced beam subjected to a vertical load illustrates the reaction and deformation of reinforced concrete beams resisting tensile forces, and describes

how the compression loads are carried by the concrete beam at the top, as illustrated in (Figure 2.3).

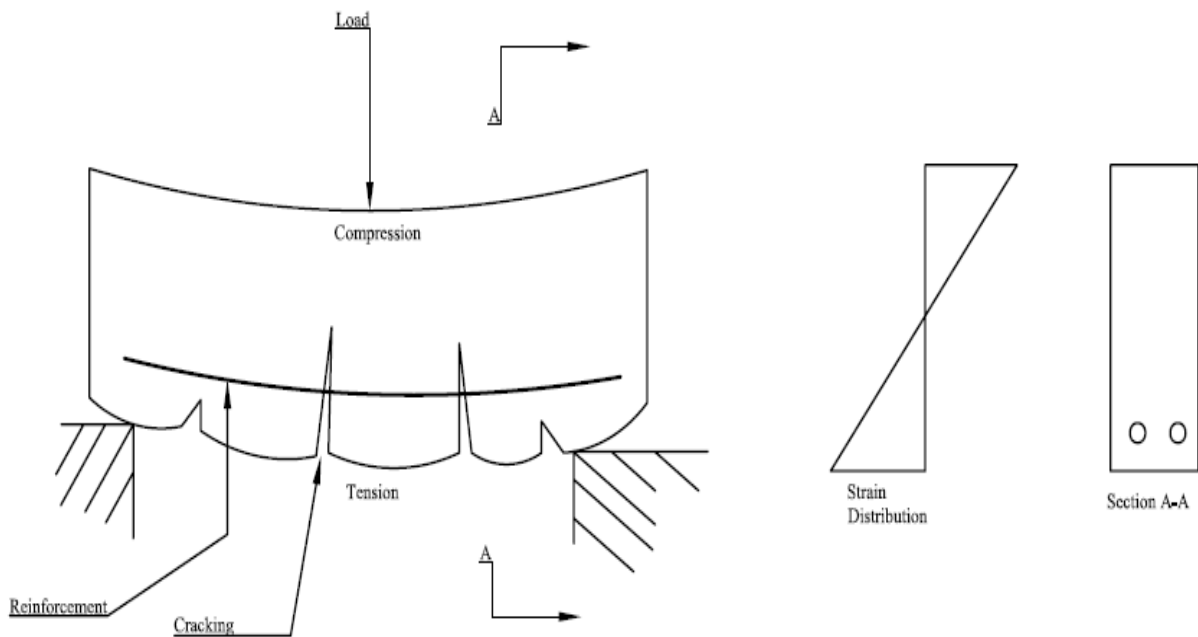

Figure 2.3 Concrete and Steel in Composite Action

Cracking will take place wherever tension occurs; but this cracking does not reduce the safety of the structure due to the presence of reinforcement which serves to restrain the cracks and to ensure that the crack is stopped from opening further, thus to keeping the embedded steel well protected and covered from corrosion.

If the shear and/or compressive forces are greater than the strength of the concrete, then steel reinforcement is needed to allow the concrete to carry extra pressure or additional loads. Reinforcement is only required for the load carrying capacity of the constructed concrete, however; usually columns demand compression reinforcement whenever used as a vertical bar close to the perimeter. Steel binders are required to assist and support the restraint reinforcement for concrete so buckling problems do not occur in the bars.

2.13 Strain and Stress Relationships

Deformation of structures occurs due to the load applied on them, which leads to strain and stress in the reinforced steel and concrete. It is necessary to comprehend the strain - stress relationship to implement the design and structural analysis, especially when constructing a structure from a composite material such as reinforced concrete. In these circumstances, therefore, analysis of the stresses on a cross section of the member should take into account the equilibrium of the forces in the reinforced section, and also the compatibility of the strains across the reinforced section.

2.14 Concrete

Variability is a characteristic of concrete, which possesses a range of strengths and strain and stress curves. Figure 2.4 shows the short term loading of the curvature of reinforced concrete under compression. The reinforced concrete section subjected to load exhibits a linear stress and strain ratio relationship at the beginning, and then shows an elastic reaction. In practice, the reinforced concrete displacement fully recovers if the load is removed, but when loading continues, the reinforced concrete reacts as a plastic material exhibiting a non-linear relationship.

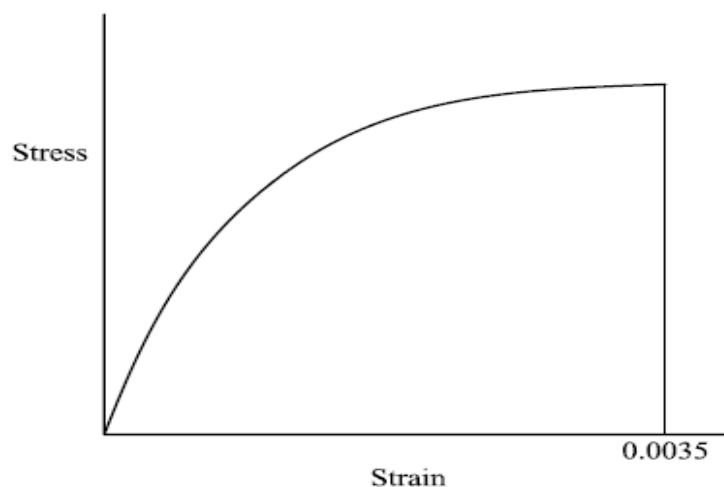

Figure 2.4 Stress and Strain Curve for Concrete in Compression

Permanent damage caused by deformation will occur, however, if the load were removed during the plastic period, and then recovery would not be an option. The constant value of 0.0035 is the maximum value for construction concrete, however, in the case of concrete with a strength above 60 N/mm^2 , there is a possibility for this constant value to be reduced. In such cases, the recommended values are as proposed by BS EN1992 Eurocode 2 (Design of Concrete Structures) (EC2).

The curvature of the strain and stress relationship is very dependent on the loading period; known as creep.

The strength of concrete increases over time, in addition, the property and type of cement plays a significant part in this relationship. Some standard design codes permit the strength of concrete to be varied depending on the age of the concrete to support the construction load. The Eurocodes, however, do not allow the strength used in design to be greater than the twenty eight days value, although the elasticity modulus can be modified according to the age. The compressive stress in the UK has traditionally been calculated in terms of a 150 mm cube strength test at 28 days old. While other countries take 150 mm as a diameter cylinder test on concrete, which is 300 mm longer than the cube test used in the UK. In terms of the ordinary strength of concrete, on average, the cylinder strength is 0.8 times the cube strength. Hence, designing to Eurocode 2 for all calculations based on the distinctive strength of cylinder f_{ck} , the cube strength, meanwhile, can be considered for the purposes of compliance, in addition to the distinctive strength known as $f_{ck,cube}$. Usually 28 days is the concrete specification distinctive strength; for instance, the distinctive cylinder strength for concrete class C35/45 is 35 N/mm^2 , while the distinctive cube strength is 45 N/mm^2 for the same concrete class C35/45. Usually there is some rounding off to these values, normally, for cube strengths extracted in multiples of 5 N/mm^2 .

2.15 Steel

Mild steel reacts elastically in response to loads. Figure 2.5 illustrates a typical strain and stress relationship, part (a) is for high yield steel, hot rolled, and part (b) is for high yield steel, cold worked. It is clear that up to the yield stage, the stress and strain relationship is proportional, until the yield point is reached, when the strain increases without any change in stress. The relationship then becomes plastic, resulting in the strain increasing momentarily until reaches its maximum value.

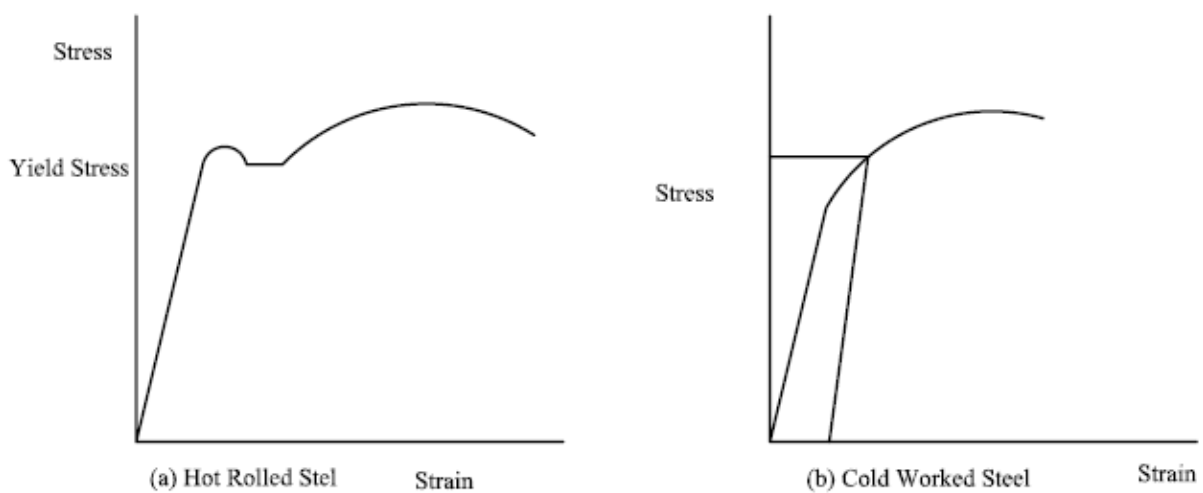

Figure 2.5 Stress and Strain (High Yield Steel)

(Figure 2.5) The most common type of steel used for reinforcement is high yield steel, and while this may react in a similar way, it may, on the other hand, not have such a specific yield point but may present a further gradual change from elastic to elastic behaviour, and reduced ductility, depending on the manufacturing process. Materials with a similar elastic modulus $E_s = 200 \text{ kN/mm}^2$ superficially have a similarity in their slope in the region of elasticity, while within the range of plasticity, removing the load causes the relationship of the strain and stress curvature to follow a line superficially resulting in a parallel shape to the load, as shown in Figure 2.6.

Figure 3.5 illustrates the line ZY. The permanent strain XZ occurs when steel is subjected to loading again, known as (slip), resulting in the relationship between stress and strain to follow the unloaded curve up to the original stress at Y, then it takes a curve shape toward the first load, hence, for the second load, the proportional limit will be higher than the initial load. This is called work hardening or strain hardening. In addition, the steel loading deformation depends on the duration for which the load is applied. The strain increases gradually under a constant stress (creep). The degree of creep depends on the class of steel and the amount of stress. Usually in reinforced concrete structures creep is of little importance; however, creep is a significant factor in concrete when steel is subjected to high stress actions.

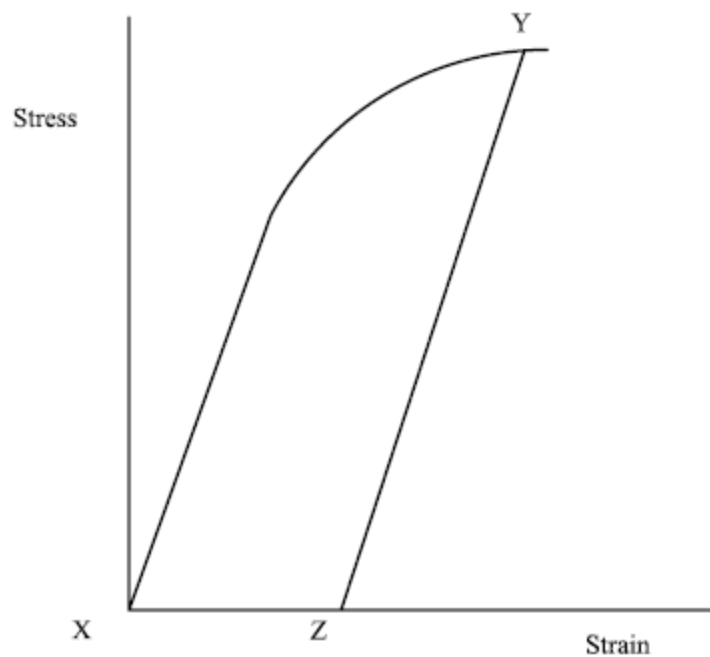

Figure 2.6 Strain Hardening

2.16 Shrinkage of Concrete and Hydration

A reduction in concrete volume occurs due to hardening and, as a result, shrinkage causes concrete to crack. This also has an advantageous effect of reinforcing the relationship between the steel and concrete, however. It is known that shrinkage

occurs as soon as concrete begins to mix, the initial cause of shrinkage is water absorption due to the aggregate and concrete mixture; in addition, more shrinkage occurs due to evaporation and loss of humidity in the water through the surface of the concrete section.

The hydration of cement during the setting operation generates a major heat redistribution, and when the temperature of concrete reduces, more shrinkage occurs due to thermal contraction. Shrinkage continues, even after concrete hardens, as the concrete gets dryer over a period of time. To control the thermal shrinkage, the temperature needs to be restricted by following the steps below:

- Cool water needs to be used with cool and steel shuttering
- To cool down the heat of hydration, the shutter should strike early
- The water and aggregate mixture should be kept cool
- Use finely ground cement and avoid any sudden hardening
- Use of a suitable cement replacement or a mix with a low cement content

To help reduce the dry shrinkage to a minimum and to avoid losing moisture, a low ratio of water to cement is required. No changes in stress will occur within the concrete, however, if the change in concrete volume is permitted to occur freely without any restriction. Restraining the shrinkage results in more stress and tensile strains; in addition, the restraint may occur externally by fixity with and bonding members or contact against the surface of the earth, and internally, due to the impact of the reinforcement of the steel. In the case of reinforced concrete floor slabs or longer shear walls, the restraint could be reduced by building sequential bays rather than alternate bays. This may allow the free end of each bay to tighten before the next bay is poured.

The thermal dilating of concrete structures could be larger than the actual movement due to shrinkage through a period of time; however, it can be controlled by correct positioning of dilating joints or movement in the concrete section. In theory, the joint should pass through the constructed structures completely in one plane and in cross section as it should be positioned at a sudden change. Cracking occurs due to a lack of tensile strength as a result of thermal movement exceeding the strength or shrinkage. Hence, steel reinforcement is required to be positioned close to the concrete surface in order to control the width of any cracks. Hence, Eurocode 2 comes to play a significant role in design by providing the right quantities of steel reinforcement in the concrete section to control the width of cracks.

2.16.1 Restrain Shrinkage and Stress Calculation

Reinforcing concrete leads to shrinkage but the unrestrained concrete sections can be easily calculated. Figure 2.7 illustrates a concrete section with shrinkage, strain free of ε_{cs} when the section is a plain concrete section. On the other hand, while the shrinkage decreased overall when the concrete was reinforced, this results in the steel experiencing compressive strain ε_{sc} giving the concrete an effective tensile strain ε_{ct} (Figure 2.7) (Mosley et al. 2007).

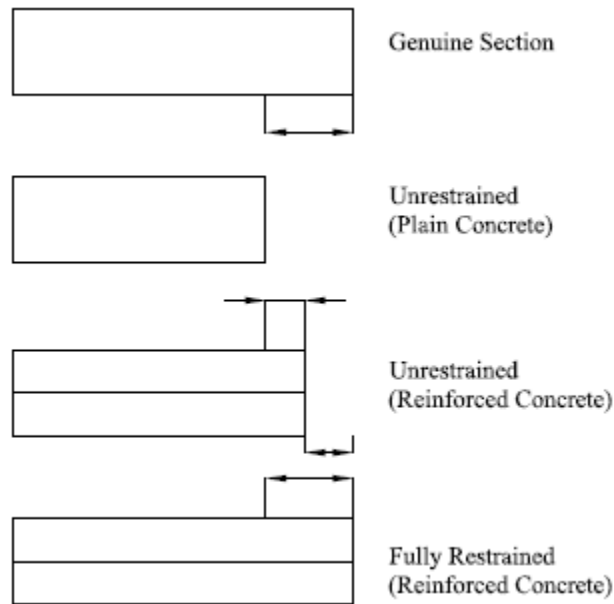

Figure 2.7 Shrinkage Strain

Therefore

$$\varepsilon_{cs} = \varepsilon_{ct} + \varepsilon_{sc} = \frac{f_{ct}}{E_{cm}} + \frac{f_{sc}}{E_s} \quad (\text{Eq. 2.4})$$

Where

f_{ct} is the tensile stress of area A_c in the concrete section and f_{sc} is the steel compressive stress for A_s in a concrete section

The steel and the concrete equilibrium equating forces give the relation below:

$$A_c f_{ct} = A_s f_{sc} \quad (\text{Eq. 2.5})$$

Thus

$$f_{ct} = \frac{A_s}{A_c} f_{sc}$$

When f_{ct} substituted in equation (3.4)

$$\varepsilon_{cs} = f_{sc} \left(\frac{A_s}{A_c E_{cm}} + \frac{1}{E_s} \right)$$

Therefore if $\alpha_e = \frac{E_s}{E_{cm}}$

$$\begin{aligned} \varepsilon_{cs} &= f_{sc} \left(\frac{\alpha_e A_s}{A_c E_{cm}} + \frac{1}{E_s} \right) \\ &= \frac{f_{sc}}{E_s} \left(\frac{\alpha_e A_s}{A_c} + 1 \right) \end{aligned}$$

Hence steel stress relationship as:

$$f_{sc} = \left(\frac{E_{cs} E_s}{\frac{\alpha_e A_s}{A_c} + 1} \right) \quad (\text{Eq. 2.6})$$

2.16.2 Fully Restrained Shrinkage and Stress Calculation

In this case when the concrete section is fully restrained, it results in uncompressed steel due to $\varepsilon_{sc} = 0$, hence, $f_{sc} = 0$, therefore the induced tensile strain in concrete ε_{ct} should be equal to ε_{cs} the free shrinkage strain. In addition, the corresponding stress will cause more cracking in fresh concrete, if it is high enough. Figure 2.8 illustrates the details of the process, due to cracking members of a concrete section; the uncracked members of the concrete will contract to let the steel embedded in the cracked region to be in compression, meanwhile, the embedded steel across the cracking region is in tension. This characteristic is joined by domesticated bond breakdown, implying that cracks are imminent. The illustration is presented in Figure 2.8 (Mosley et al. 2007).

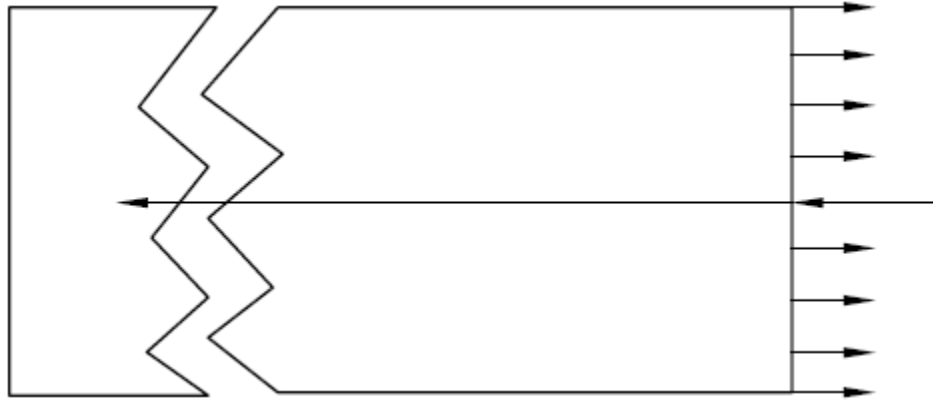

Figure 2.8 Cracking and Shrinkage Forces

2.16.3 Elastic Modulus of Concrete

The elastic modulus magnitude is required to investigate the cracking and deflection of concrete structures. The stiffness of a member depends on the static modulus E_{cm} if the short duration effects are considered, while if long term effects are under consideration, the creep effect may alter the E_{cm} value to the efficient value $E_{c, eff}$. The table below Table 2.3 shows the values of E_{cm} for different types of concrete in which gravel aggregates have been used as a suitable material to use for design. At an age other than twenty eight days, the elastic modulus can be predicted at that age by using the estimated strength value from the table below. When a Poisson's ratio is needed, however, it may be taken as 0.2 for the areas which are not under any cracking tension (Eurocode 2 2008).

Table 2.3 Elastic modulus of usual weight gravel concrete (short duration, 28 days)

| Distinctive Strength (N/mm^2) at 28 days | | Secant (Static) Modulus (E_{cm}) (kN/mm^2) Mean |
|--|-----------------------|---|
| Cube (f_{ck}) | Cylinder (f_{ck}) | |
| 25 | 20 | 30 |
| 30 | 25 | 31 |
| 37 | 30 | 33 |
| 45 | 35 | 34 |
| 50 | 40 | 35 |
| 55 | 45 | 36 |
| 60 | 50 | 37 |
| 75 | 60 | 39 |
| 85 | 70 | 41 |
| 95 | 80 | 42 |
| 105 | 90 | 44 |

The strain and stress curvature relationship for concrete, as described earlier, illustrated that in spite of the assumption of elastic behaviour for stresses under 1/3 of the maximum compressive strength, realistically, the stress and strain relationship is not always linear. Thus, determining the precise value of the elastic modulus is a crucial consideration for any design.

$$E \frac{stress}{strain} \quad (Eq. 2.7)$$

Various definitions are available, however, the common definition is:

$$E = E_{cm} \quad (Eq. 2.8)$$

Where

E_{cm} is the static or secant modulus

The calculation is carried out for the specific concrete through a static test in which the cylinder is subjected to a load of over 1/3 of the corresponding mean control cube stress $f_{cm, cube}$, or 4/10 of the mean cylinder strength, then turned back to zero stress. This highlights the influence of bedding in and secondary stress redistributions in the sample of concrete subjected to the load. The reapplied loading process eventually results in linear behaviour, the average slope is taken up to the particular stress, as the E_{cm} value. This test is known as the secant modulus of elastic, and is described in detail by BS 1881.

It is easier to calculate the dynamic modulus of elastic (E_d), in the laboratory, and the E_d and E_{cm} relationship is well determined. The basis of the test is defining the resonant frequency for a prism specimen; the test is documented in detail by BS 1881. It is possible to use ultrasonic measuring techniques to achieve a fair estimate of E_d , and this can be used in structures on site to assess the concrete. Figure 2.9 illustrates the criterion test on an unstressed sample to obtain the E_d value. It is clear that the obtained value indicates the slope of the tangent at nil stress (zero stress); as a result, the E_d value is higher than the E_{cm} value.

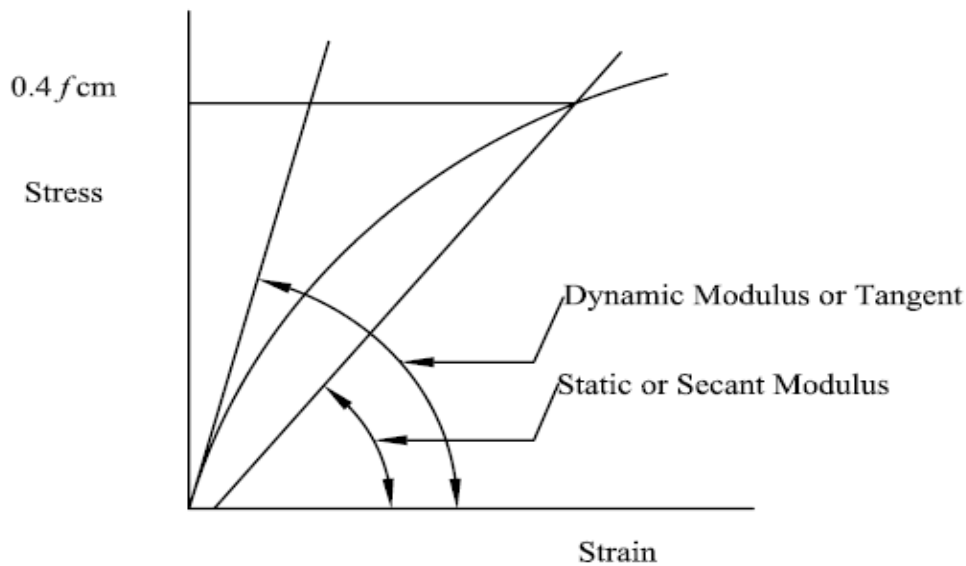

Figure 2.9 Concrete Moduli of Elasticity

The equation below is fairly accurate for the purposes of normal design as Eurocode 2 (2008) indicates, and the two moduli E_{cm} and E_d relationship, can be described as:

Secant modulus
$$E_{cm} = (1.25E_d - 19) \text{ kN/ mm}^2 \quad (\text{Eq. 2.9})$$

The E value of concrete depends on factors related to the concrete mix; however, an ordinary relationship between the compressive strength and the elastic modulus does exist.

2.17 Thermal Behaviour of Concrete and Steel

The similarity between the thermal expansion coefficients of concrete and steel ($\alpha_{T,c}$ and $\alpha_{T,s}$) are much greater than the differential thermal movement between concrete and steel, which means cracks are unlikely to occur.

If necessary, the shrinkage strain ϵ_{cs} should be added to differential thermal strain, and can be calculated due to temperature change as below:

$$T(\alpha_{T,c} - \alpha_{T,s}) \quad (\text{Eq. 2.10})$$

Generally, thermal contraction is very likely to be the cause of the initial crack in the restrained part of the concrete, and temperature changes over the night time will cause cracking in freshly casted concrete, despite controlling the temperature produced by hydration processes and generated heat (Mosley et al. 2007).

2.18 Creep

In concrete sections under sustained loads for long durations deformation is known as creep. Various types of materials exhibit this phenomenon, but concrete is the most well-known for creep behaviour. Creep is associated with the mix of the constructed member and the type of aggregates used in the construction process, as well as the humidity of the construction site, the loading time and the cross section of the member. The typical creep pattern is shown in Figure 2.10, when a concrete section is subjected to an axial compression.

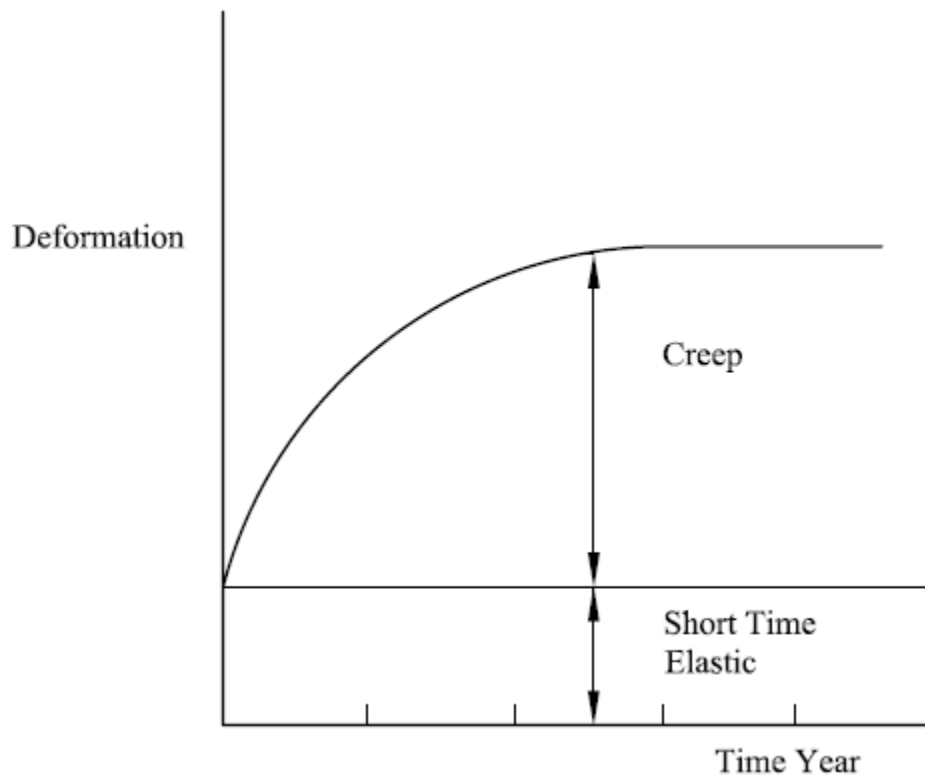

Figure 2.10 Typical Concrete Deformation by Time

The typical creep curvature illustrates that creep characteristics are:

- The load is redistributed between any steel present and the concrete
- The immediate elastic deformation may recover when the load is removed, but this is not the case with plastic deformation, which will remain permanently deformed
- The concrete strength inverse and the loading intensity are approximately proportional to the deformation
- The definitive deformation of the concrete section may be 3 – 4 times the short time elastic deformation

The change in the compressive strain that is transferred to the steel in the concrete causes the load redistribution; hence, the steel is taking a greater proportion of the load due to increasing compressive stresses. The impact of creep is especially significant in beams, where crack opening, non-aligned equipment and damaged finishes occur due to increasing deflection. Stress redistribution between the steel and the concrete occurs initially in the uncracked compressive region, although, in addition, in some cases, there is a smaller impact in terms of tension reinforcement rather than decreasing shrinkage stresses. The reinforced provision is in the compressive region of the flexural section of the reinforced concrete, serving powerfully to restrain the deflection occurring as a result of creep (Mosley et al. 2007).

2.19 Concrete Specification

The specification of what concrete to choose in the construction process is most often governed by the strength required, which depends on the size and form of the structure and the load intensity. In multi-storey structures, for the lower columns, a higher

concrete strength is needed rather than having columns with larger diameters, which would result in a loss of space in floors. The strength of concrete can be measured using either the cylinder test or the cube test to measure the crushing strength of a sample of concrete. The procedure set out in the codes for both tests requires them to be carried out after 28 days. The concrete is identified by its class for a given strength; for instance, the concrete class 25/30 gives the strength f_{ck} of 30 N/mm^2 for cube test and strength f_{ck} of 25 N/mm^2 for cylinder test. Lists of concrete characteristic classes widely used are shown in Table 2.3. In addition, the lowest usual concrete classes used for different kinds of structural design, are also presented in Table 2.4 as below.

Table 2.4 Concrete Strength Classes (Eurocode 2 2008)

| Class | $f_{ck}(\text{N/mm}^2)$ | Specified usual lowest class |
|--------------|-------------------------|---|
| C16/20 | 16 | Plain concrete |
| C20/25 | 20 | Reinforced concrete |
| C25/30 | 25 | |
| C28/35 | 28 | Prestressed concrete/Reinforced concrete subjected to chlorides |
| C30/37 | 30 | Reinforced concrete in foundations |
| C32/40 | 32 | |
| C35/45 | 35 | |
| C40/50 | 40 | |
| C45/55 | 45 | |
| C50/60 | 50 | |
| C55/67 | 55 | |
| C60/75 | 60 | |

The durability and the exposure conditions may affect the selection of the mix and the concrete class. For instance, concrete blocks subjected to harsh conditions located in a chemical plant, would require a higher concrete class than concrete used in the inner construction members of office structures or schools. In spite of the fact that the Portland cement class 42.5 may be used in various structures, while other cement classes may also have advantages, in cases where chemical resistance is required, sulphate resisting cement or a blast furnace may be used, and to reduce the high temperature generated from hydration process, low heat cement may be used in massive concrete blocks, or where high early strength is demanded, a rapid hardening type of cement can be used. In addition, replacing types of materials like Ground Granulated Blast Furnace Slag or Pulverised Fuel Ash that are known for their slow evolution of cementation. Such materials will control the heat generated from the hydration process and will give the best construction performance in terms of structural durability. Usually, local aggregates are most popular for use on construction sites, but the lightweight manufactured aggregates may be required when weight is an issue and/or there is a need to consider the specific density of the aggregate, such as if radiation shielding is the intended purpose (Mosley et al. 2007).

There are two main types of concrete mix, known as Designated and Designed. Designed concrete is where the type of cement, the class of strength and limits to composition, including the content of the cement and the water/cement ratio, are specified at the design stage for a particular purpose. With designated concrete, meanwhile, the material is provided by the producer to satisfy the strength class of the designated concrete and workability from the use of specific size of aggregates. RC30 is the identification of designated concretes, with a cube test up to RC50 according to the applications required. Designed concrete is needed in circumstances where

designated concrete cannot be used on account of durability demands; for instance in chloride induced corrosive environments. Descriptions and more information and requirements can be found in BS8500 and BS EN206.

2.20 Steel Specification

The most commonly used types of steel in the UK are listed in Table 2.5 along with their distinctive design strength. For instance, steel grade 500 ($500N/mm^2$ distinctive strength) has been replaced with steel grade 240 and steel grade 250 reinforcement steel all over Europe, considering the usual bar size is the diameter of the steel of an equivalent circular area, and grade 250 steel bar is mild steel, hot rolled, and normally coming with a smooth surface which will make the adhesion process to be the only bond between the steel bar and the concrete due to its smooth surface which is very easy to bend. For this reason it has been used in the past where there is a requirement for a smaller radius bend; for instance, links in narrow column beams. Currently, in Europe, however, plain bars of steel are not considered and are also not available any more in the UK for normal use.

Table 2.5 Steel Reinforcement Strength

| Designation | Standard Size (<i>mm</i>) | Particular Characteristic Strength f_{yk} ($\frac{N}{mm^2}$) |
|-------------------------------------|----------------------------------|---|
| High yield cold worked (BS 4449) | Up to and including 12 | 500 |
| High yield hot rolled (BS 4449) | All sizes | 500 |

High yield reinforced steel bars are constructed with a ribbed surface or are manufactured in the shape of a twisted square. Square twisted reinforced steel bars

have inferior connection specifications and although these have been used in the past they are currently disregarded. The relationship between steel and concrete is described as a mechanical bond, the high yield bars bending through quite small radius often results in the steel being subjected to a tension crack, so to prevent such cracking taking place, the bend radius should be equal or higher than twice the usual size of the bar, if the bars are small in size $\leq 16\text{mm}$, and/or $3\frac{1}{2}$ times in the case of larger sized bars. The ductility requirements of reinforced steel bars for construction are also classified, and the high yield ribbed bars classification may be described as:

- Class A, usually links with cold worked bars with a diameter of $\leq 12\text{ mm}$, found in fabric and mesh. This is the class with the lowest ductility grade and limits on redistribution moment are included which may be subjected, in addition, for fire resistance, the quantities is higher.
- Class B, recommended for reinforcing bars
- Class C, high ductility, considered for seismic design such as in earthquake zones

Flat slab floors, shells, roads and walls can be reinforced by using a welded fabric, provided in rolls with rectangular or square mesh to obtain greater economies in design detailing when reinforcement takes place, as well as in the labour costs of fixing and handling on construction sites. In addition, for very similar reasons, the prefabricated reinforcement bars have become very popular, and also welded fabric mesh manufactured of ribbed wire with a diameter bigger than 6 mm can be included in any of above ductility classes.

The process of bar reinforcement in the member can be straight or bent to a standard shape. These shapes should be completely measured and listed in a detail of the reinforcement which is used on construction site for the fixing and bending of the reinforced steel bars. The standard shapes and techniques are described in detail in BS8666, and the types of bars mentioned above are commonly known by the following codes: H, which stands for high yield steel, HA, HB, HC or ductility irrespective class; where an appropriate ductility class is demanded (Mosley et al. 2007).

2.21 Structural Analysis at the Limit State

The combination of slabs, beams, walls and columns is known as reinforced concrete structures, which are rigidly bonded together to shape a monolithic frame, hence all members should individually have the capability to resist the action of the loads upon them, in which the determination of these action loads is a substantial factor in the process of structural design.

Rigid reinforced concrete structures are far more complicated to analyse completely; however, simplified adequate precision calculation may be an option if the behaviour of the structures and the basic action load principles of the structures are determined and analysed adequately. The analysis of the structures should start with the evaluation of the action forces carried by the frame structure, considering its own weight. A number of action forces are variable in position and magnitude; in addition, all probable critical arrangements of action forces need to be taken into account. Primarily, the frame structure is rationalised into simplified shapes that symbolise the action forces carrying the load of the structure. The action loads in each individual member may be defined by using one of the techniques below:

- Computer analysis

- Manual calculation
- Applying shear coefficients and moment

The use of tabulated coefficients are only appropriate for use with basic framed structures, such as continuous beams of equal span carrying uniform action forces. The manual calculation method, meanwhile, is suitable for a wide range of structures. This method could be tedious for more complicated or large structures, however. While the computer method may be invaluable in structural analysis, even in the case of small structures, and in some cases it could be crucial for these calculations. On the other hand, the magnitude of output from the computer method may be overwhelming in some cases and the results are readily translated when they presented diagrammatically.

It is known that the design of reinforced concrete structures basically depends on the ultimate limit state (ULS), and the structural analysis is generally carried out for loadings corresponding to the ultimate limit state. Pre-stressed concrete members, however, are usually designed for serviceability limit state (SLS) loadings.

The loads (actions) on buildings are classified into two types: permanent (dead) loads (actions), and variable (live or imposed) loads (actions). The former are those types of load which are usually constant during the structure's life. While the latter are transient and not constant in magnitude, for instance the actions due to human occupants or wind. References and testaments for the actions on structures are given in the Eurocode standards, some of which are EN 1991-1-7 Accidental loads due to explosions and impact, EN 1991-1-4 Wind loads, EN 1991-1-3 Snow actions, EN 1991-1-2 Traffic actions on bridges, and EN 1991-1-1 General loads.

2.21.1 Permanent loads

Permanent loads comprise all types of architectural elements, such as ceilings, partitions and exterior cladding, static machinery and other architectural equipment.

Permanent equipment are also usually considered as part of the permanent loads.

When the size of the structural section, and the specifications of the architectural demands and permanent equipment have been established, the dead (permanent) loads can be determined accurately. Before doing this, though, initial design calculations are usually needed to assess the sizes and weight of the elements of the concrete structure.

In most reinforced concrete structures, a standard value for the weight of the concrete itself is 25 kN per cubic metre, although a higher density needs to be used for bigger reinforced concrete structures or dense concrete, as Mosley et al. (2007) indicated. Considering a concrete structure, the weight of constant (permanent) partitions needs to be calculated from the architect's designs, and a minimum partition acting equivalent to 1.0 kN per square metre and more often classified as a inconstant (variable) loads. This is only appropriate for light-weight partitions, however. Permanent loads are usually determined slightly conservatively; so that the section will not need redrawing and redesigning due to small variations in its dimensions. Bearing in mind that this needs to be done with care, however, the permanent load can, realistically, often be reduced in some parts of the concrete structure, as Figure 2.11 illustrates in the case of the loading and deflection of a three-span beam.

- i) Maximum sagging moment at A & C
- ii) Deflection form

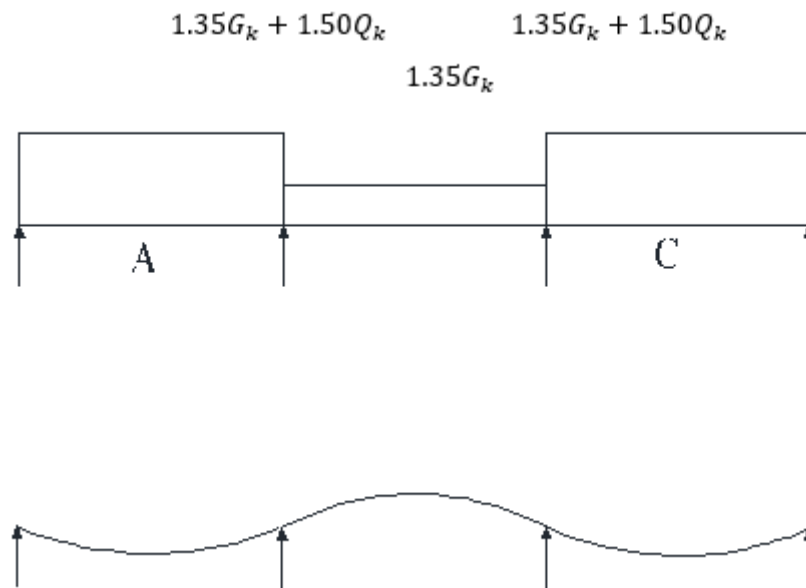

Figure 2.11 Three Span Beam

2.21.2 Variable Loads

It is quite complicated to calculate these loads. In the majority of cases, it is only possible to apply conservative estimates to these types of load, according to standard design codes or historical experience. For instance, these loads on structures could be the weight of residents, furniture, or machinery, wind pressure, snow load, retained water or earth, and any other loads occurred due to thermal expansion or shrinkage of the concrete.

It is unlikely that a large structure would be carrying its full live load simultaneously on all floors. Therefore, Eurocode 1 EN 1991-1-1 Actions on Structures (2002) clause 6.2.2 (2) allows a reduction in the total live floor load when the column, foundations or walls are designed, for a structure more than two storeys high. In the same Eurocode 1, clause 6.3.1.2 (10) states that the live load can be reduced when drawing a beam span which is load-bearing over a bigger floor region.

Although wind action is a live load, it is catalogued independently when its partial safety factor determined, and when the joining actions on the building are being taken into account.

2.22 Summary

By considering immediate and long-term deflections separately, it is possible to design structures so as to accommodate the deflection of structural members without causing damage to partitions or finishes.

Many techniques and methods of deflection calculation have been reviewed and studied in this chapter, and the effect of cracking on reinforced concrete flat slabs have been examined and reviewed closely. Site investigation measurements to determine and control deflection on flat slabs have also been reviewed and examined. Finally, various design code limitations have been covered and evaluated in respect of deflection control and the limitation of deflection.

The deflection of a section or building may not be such that it adversely affects its appearance or adequate performance. Appropriate limiting values of deformation considering the type and shape of the structure, of the finishes, partitions and fixings, and also the purpose of the structure may be determined.

The appearance and usual utility of the building may be adversely affected when the computed sag of a beam, slab or cantilever subjected to quasi-permanent actions exceeds $\text{span}/250$. The sag is estimated close to the supports. Precamber could be considered to compensate for some or all of the deformation, but any upward deformation incorporated in the formwork could not usually exceed $\text{span}/250$.

Deformations that may damage adjacent parts of the building should be limited. For the deformation after construction, $\text{span}/500$ is generally an adequate limit for quasi-

permanent actions. Other limits could be taken into account, relying on the sensitivity of adjacent parts.

The limit state of deflection could be examined by either:

- Limiting the span/depth ratio, or
- Comparing a calculated deflection with a limit value

The actual deflections may vary from the calculated values, especially if the values of the moments used are relative to the calculating moment. The variation may rely on the dispersion of the material properties, on the environmental circumstances, on the action record, on the reinforcements at the supports and ground situation.

Eurocode 2 (2008) recommends traditional limiting design values of horizontal deformations as a function of high H of structure or high H_1 buildings, as presented in Table 2.6, concerning:

- What the traditional $L/250$ and $L/500$ deflection limits values are based on?
- Are these values still adequate for modern structures?

Table 2.6 Traditional Limiting Design values of Horizontal Deformations as a Function of High H of Structure or High H_1 Building

CHAPTER THREE: Methodology and Site Investigation

Traditional reinforced concrete slabs and beams are widely used for the building. The use of flat slab structures gives advantages over traditional reinforced concrete building in terms of design flexibility, easier formwork and use of space and shorter building time. Deflection of the slab plays critical role on design and service life of the building components, however there is no recent research to explore actual deformation of concrete slab despite various advancements within the design codes and construction technology, apart from Vollum. This study provides the methodology for monitoring the deformation of a multi-storey building with flat slabs presents and discusses the experimental results for the vertical deformation.

3.1 Introduction

Site investigation to monitor deflection on the construction site started in early September 2015 for a period of six months. The construction site is located in Elephant Castle. Site investigation and testing theory through observation and data collection was the main deductive approach of this research, entailing a quantitative method to calculate and determine the deflection of concrete slabs by using Hydrostatic Cells Levelling system (HCL).

This site investigation has the following characteristics:

- A six-month timeframe, started on early September 2015 to early February 2016
- Specialisation – specialists are part of the team for the input of their specialist advice, Gete company (Keller Group plc represented by Keller UK, and is the pioneering name in the foundations and ground engineering industry) involved

in installing Hydraulic Cell Levelling system (HCL) on the site to observe the deflection

- A core team of 1-3 members, including the researcher and two engineering technician from Gete to install the Hydraulic Cell Levelling system (HCL)

3.2 Various Methods for Measuring Deflection

Eurocode 2 is considered to be one of the most advanced design codes available. It allows deformation to be checked by using calculation, suggesting a method using a cracking distribution coefficient gives an adequate prediction. Eurocode 2 also allows the use of deemed-to-satisfy span to-effective-depth ratios. These methods are compatible and economic for use with mega constructions (Moss and Brooker 2006).

Numerous optimum or minimum load designed structural components are under intense work conditions. More often, the small deflection linear theory is no longer applicable. It is very important to apply and understand crack and fracture attitude with non-linear analysis (Akbas 2015).

- Some conditions where direct deflection computation is required, are listed below:
 - If an assumption of deflection is needed.
 - If the deflection limits are not adequate for the span/250 for quasi-perpetual behaviours, or span/500 for partition members and/or cladding load.
 - Direct examination of deflection proposes an economic solution, when the design demands a specific shallow section.
 - To define the impact on deflection of premature striking of formwork or of interim load construction periods on the structure.

The Concrete Society (2005) indicated in its technical report no. 58 that finite element methods are generally considered as the functional methods to obtain actual values of deflections. Limiting quasi-permanent, long-term, and deflection to $\text{span}/250$ is normal as Beeby (1971) states. However, unless a specific demand is required, and if cladding or brittle partitions have been supported, to control the movement deflection limit should be reduced to $\text{span}/500$ (Tovi et al 2016).

The deflection of slab structures subjected to various loads increases as a result of shrinkage from losing moisture and creep due to the applied load. In addition, though, a magnification of the initial deflection occurs due to time dependent elements of shrinkage and creep (Rotimi et al in press).

Time has a significant impact in terms of changing the rate of deformation in concrete structures. It was argued by Heiman and Taylor (1977) that five years is a crucial time for the displacement to reach peak value, and although time dependent deflection can be computed at any time period, the prevalent procedure for design purposes is to assess the ultimate value at five years.

The deformation of large slabs may cause cracking in finishes and partitions, damaged windows and doors, inadmissible flooring slopes and roof ponds. Heiman and Taylor (1977) stated that deflection increases due to loading slabs throughout the construction period during supporting procedures. Loading normally occurs at early stages, resulting in extreme cracking and slabs losing stiffness.

The best methods for calculating deflection are recommended by The Concrete Society (2005) technical report no.58. This is presented under the Rigorous Method.

a) The Rigorous Method

Commonly, 'The Rigorous Method' refers to the distribution coefficient method of Exp (7.19) in Eurocode 2 (2008). There are more methods that are rigorous, but in light of the variability of concrete strengths, loadings over time, etc., their validity is questionable.

b) Simplified Method

A simplified method is practical for computing deflection by hand calculation, and is also useful to estimating and verifying deflection value results from computer programs and/or where the program or computer are not available. Essential simplification of this method is that the impacts of loading at the early stage are not accounted specifically. In fact, when computing the cracking moment, an allowance is produced for the impacts.

The self-weight of required slab concrete cannot be corroborated by itself for very long term and should be diverted either entirely or partially to lower levels connected by props, since unhardened slab concrete cannot appropriately develop its stiffness and strength until it is hardened completely (Kang et al. 2013).

During construction, reinforced concrete slabs that have been placed at different times develop a gravity load resisting system, where adjacent slabs are connected by props. Actions (Loads) applied into the system are self-weights of joined concrete slabs and construction live actions. These actions (Loads) are transferred according to the proportional stiffness ratio of concrete slabs and applied to each slab as a construction action. According to a level construction cycle or the number of propped levels, the construction action applied to the reinforced concrete slab is specified through the relative stiffness ratio with the age of each reinforced concrete slab (Kang et al. 2013).

Experimental work to monitor deflection on construction site by using Hydrostatic Cell Levelling system (HCL) was started on early September 2015 for the period of six months. The construction site located in Elephant and Castel- London.

This site investigation has the following characteristics:

- A six-month timeframe, started on early September 2015 to early February 2016
- Specialisation – specialists are part of the team for the input of their specialist advice, Getec Company (Keller Group plc represented by Keller UK) involved in installing Hydrostatic Levelling Cell system (HCL) on the site to observe the deflection.
- Installation core team of 1-3 members, including the researcher and two engineering technician from Gete to install the HCL system.

Several methods were considered for monitoring the slab deflection, a comparison Table 3.1 presents various methods to determine deflection. Hydrostatic Cells Levelling and Precise Levelling were selected and used to observe the deflection for the period of six months after considering advantages and disadvantages of each method.

Table 3.1 Comparison of Various Methods for Measuring Deflection on Slabs

| Technic | Advantage | Disadvantage |
|-----------------------------|---|---|
| Precise levelling | Inexpensive, costing £4000 (costing £4000 for the whole site including 8 storeys) | Additional operation for site staff Not reliable/ imprecise Subject to obstruction by false work/formwork, following trades, services, ceilings, occupation |
| Getec Hydrostatic levelling | Accurate Remote data collection Small boxes (say 100x120x120 on u/s slab) | Costly, £1950/station i.e. £4000 per bay of 7 x 12m Specialist installation PC and internet connection required on site. |

| | | |
|-----------------------------------|---|---|
| | | Tubes for water and signals Robustness during construction Desirability post construction |
| SAA (Shape Access Array) | Accurate Remote data collection Non-specialist installation | Array cast in, ('Joined sticks') Costly, £450/m i.e. probably approx. £16,000 for two bays |
| Optical fibre | Inexpensive | Unproven technology which could be the subject of a research itself (computers and optical fibre rather than concrete and deflection) (Atkins et al. 2016) |

Following methods have been identified for monitoring the slab deflection with the Getec Hydrostatic and Precise Levelling methods being selected after considering the advantages and disadvantages of each.

3.2.1 Precise Levelling

Levelling is the expression applied to any technique of measuring directly the difference in elevation between points.

Precise levelling is a predominately accurate technique of differential levelling which uses extremely accurate levels and with a further stringent observing execution than normal engineering levelling. It aims to obtain high levels of accuracy such as 1 mm per 1 km traverse.

A level surface is a surface which is perpendicular to the direction of the load of gravity. For normal levelling method, level surfaces at various elevations can be taken into account to be parallel. An arbitrary level surface to which elevations are referred to is called level datum. The common surveying datum is mean sea level (MSL). A given datum, which is proposed by assuming a benchmark value (e.g. 100.000 m) to which all levels in the region will be lowered.

A bench mark (BM) is the expression given to a specific, constant accessible spot of known height above a datum to which the height of other spots can be referred. It is normally a steel pin embedded in an essential concrete block cast into the floor. The positions of benchmarks shall be highlighted with BM marker paint and/or posts, and recorded on the station.

A set-up refers the location of a level at the time in which a number of readings are made without mooring the device. The first reading is made to the known spot and is termed a back sight; the last reading is to the last spot or the next to be defined on the run, and all other spots are intermediates.

A run is the observation among two or more spots observed in one direction only. The outward run is from known to unknown spots and the return run is the check observation in the opposite direction.

Figure 3.1 illustrates the actual deflection values obtained from the site observation using Precise Levelling which shows 2mm of deflection as an average on selected bay highlighted in red colour.

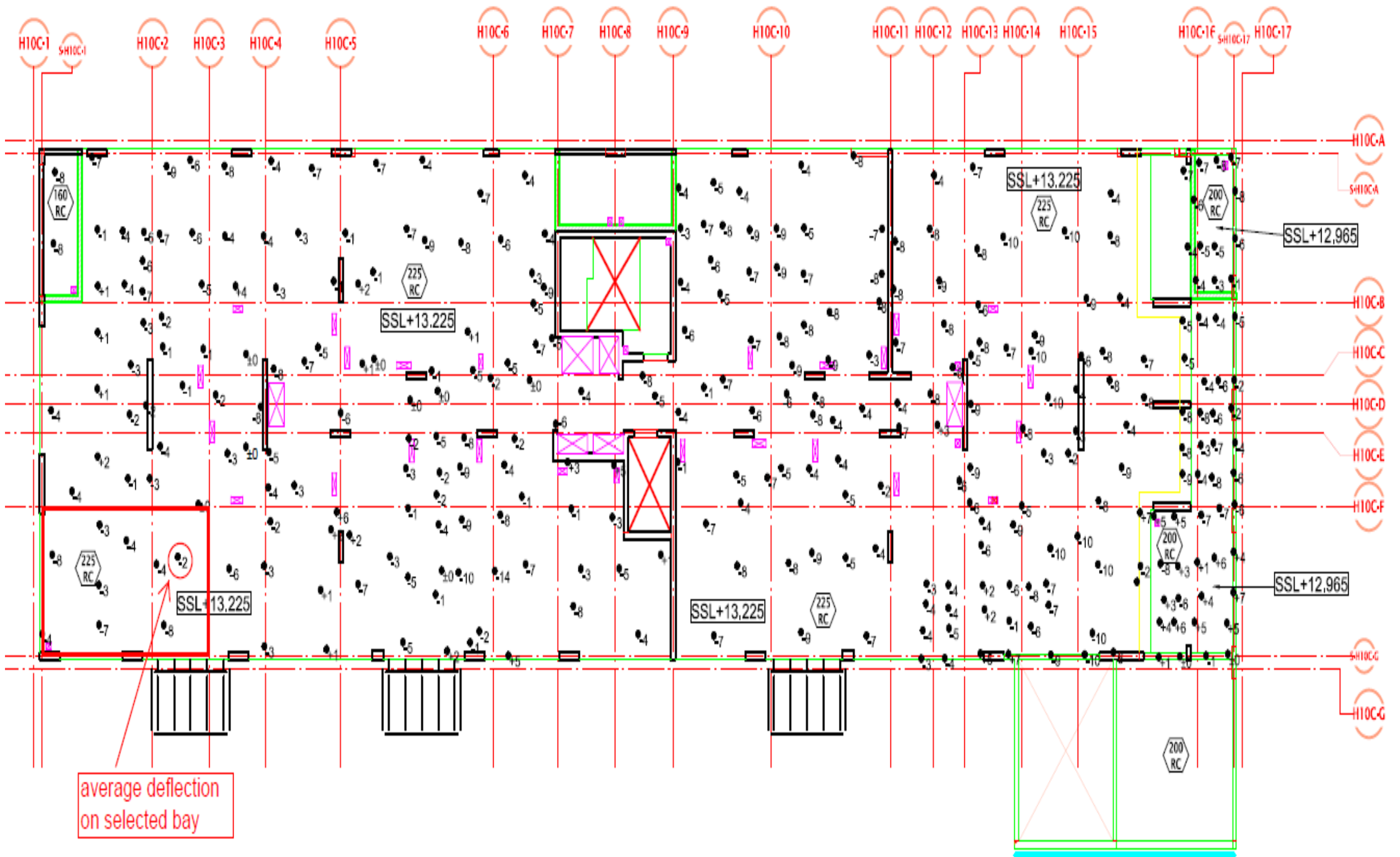

Figure 3.1 Precise Levelling Deflection of 2mm of on Selected Bay, refer to Figure 5.11 for more details

The variation between the starting level of the initial spot for the outward run and that defined at the end of the return run is called a close. If the levels have been lowered correctly this value should be the same as the variation between the total of the rises and falls and also the variation between the total of the backsights and foresights.

The height of the optical axis of the telescope at the time of the setup is called Height of Collimation. The bar of collimation is the fictional bar at the height, and orders of observation presents the quality of the observation, normally being measured by the anticipated maximum closing error.



Figure 3.2 Levelling Instrument

A level is essentially a telescope connected to an accurate levelling instrument, set upon a tripod which gives ability to rotate horizontally through 360°. Basically the levelling instrument is a bubble. There are three ordinary forms of level.

a) Dumpy Level:

These are other typical levels predominantly considered in construction project. The telescope is connected to a single bubble and the assembly is adjusted by footscrews which are adjusted first in one way, then at 90°.

b) Tilting Level:

Fitted with a circular bubble for preparatory levelling and a main bubble which is connected to the telescope. For each reading, the main bubble is sighted through an eyepiece and the telescope tilted by a fine screw to get the two ends of the bubble into conformance.

c) Automatic Level:

This type of level is now in common use. It has a display which consists of a configuration of three prisms. The two outer ones are connected to the cylinder of the telescope. The middle prism is suspended by thin wiring and respond to gravity. The device is first levelled with a round bubble; the compensator will then drift the bar of view by the amount that the telescope is out of level.

The levelling staff is a box unit of aluminium, which will extend in height by telescoping, addition of units. One side has a graduated scale connected for observing with the cross-hairs of the level telescope. These sides can alter in shape and graduation; 5mm graduations is the maximum for accurate levelling of gauging units.

Currently most staves used are of aluminium due to its durability. Yet aluminium has a co-efficient of thermal expansion of $0.000023\text{m/metre of length}/^{\circ}\text{C}$, and this will result some potential inaccuracies, such as Brookeades and Survey Chief staves are consolidated at 27°C , and in extreme cold weather these staves will be 3mm short over their actual length. In case of low temperature work review the temperature table for every individual staff which will come with its instruction manual.



Figure 3.3 Level Observing Deflection on Slab

These are usually a small rounder bubble on an angle plate which is attached to one corner of the staff to guarantee that the staff is held in a vertical status. If it is not, then reading will be too large and will be remarkably in error.

The steps below summarises the levelling procedures

- Foresight and Backsight distances should be equal to prevent any errors as a result of earth curvature, refraction or collimation

- Distances should not be so big as to not be able to observe the graduations accurately
- The spots to be levelled should be below the level of the device, yet not lower than the height of the staff
- Parallax is the visible motion of the image generated by motion of the observer's eye at the eyepiece. It is reduced by centring the telescope on infinity to adjust the eyepiece. The setting should stay steady for a certain observer's eye
- Loose-leaf levelling sheets should be indexed
- Details of the site and any relevant work should be registered

3.2.2 Hydrostatic Cells Levelling (HCL) Method

For a long period constantly Hydrostatic Cells Levelling method is effectively used for the continuous observing of deformations in height of structures and various types of technical constructions. The observation method basically consists of different observing cells which are connected by pipes and tubes as illustrated in (Figure 3.4). More information can be obtained from Chapter Four.



Figure 3.4 Hydrostatic Cells Levelling System Connected

In the Hydrostatic Cells levelling method (HCL) the data is expressed in numeric terms, such as temperature, location, dimensions and percentages. Since the research needs to be both replicable and valid, care is required in all aspects of data acquisition and analysis. Allocating the correct position for the cell is essential in order to obtain the most accurate data deflection, as illustrated in (Figure 3.5) shows the location of the Hydrostatic Cell Level position on the column.

The Hydrostatic Cells Levelling method provides:

- High precision measurements to 0.025mm
- Long life and low maintenance
- Can read data every 5 seconds if required



Figure 3.5 Hydrostatic Cell Levelling Location

The method requires:

- One fixed reference point outside the zone of influence
- Power supply, site PC and internet connection



Figure 3.6 Hydraulic Cell Level data box

In the method, water from a water reservoir installed higher than the cells is kept at a constant pressure in the system. The water line is a complete sealed circuit passing through each cell. A reference cell is situated outside the settlement zone so that it does not move. All movements from cells within the circuit being referenced to this cell are reflected as a change in height.

The airline also passes through the cells in a circuit but, unlike the water line, is left open in the environment; this is stable so all the cells have the same air pressure. If a cell location moves, the capacitive pressure transducer situated between the water and air chambers in the cell records the difference in pressure. The electrical signal from the cell, which varies from 4mA to 20mA, is sent to a data box, which then transmits to a site logger that converts the signal to useable units (mm).

Once the circuit is complete, the system is set to zero through the software. Any subsequent change in water pressure is recorded from each cell in the chain and

compared with the reference cell. If settlement occurs in one cell location, as the structure moves downwards the water pressure will increase in that cell showing a negative value. If the cell is raised due to heave, the pressure decreases showing a positive value.

(Figure 3.7) Illustrates Hydraulic Cell Level network connection, which is connected to the data box below



Figure 3.7 Hydraulic Cell Level Network Connection

(Figure 3.8) Illustrates the water pressure reservoir connected to tubes transferring water pressure to the cells.



Figure 3.8 Hydraulic Cell Level water pressure reservoir

The methodology of Hydrostatic Cells Levelling (HCL) Systems can be defined as below, more information on (HCL) described in details in Chapter Four.

a) Principle of Function

Stationary hydrostatic multipoint levelling systems have been successfully for a long time for the continuous monitoring of changes in the height of buildings and other technical constructions. The observation technique essentially consists of various observing sports, which are connected by pipes and tubes as illustrated in Figure 3.9.



Figure 3.9 Hydrostatic Cells Levelling Connected to Data Box

The hydrostatic levelling system measures pressure differences versus a reference measuring point. These changes of pressure are converted to a height difference. The reference level is defined by the liquid horizon in a header tank. A water tube connects all the measuring points to the header tank and therefore, with the reference level, because the header tank is not linked to the measuring circuit, the level changes experienced by the liquid (e.g. through liquid losses, equal heating) have no influence on the measurement results.

b) Accuracy

The heart of the hydrostatic levelling system are capacitive pressure devices, which are characterised by their stability and reliability. The technical specifications are as follows (Getec 2016)

- Compensated range: 0 – 50 °C
- Operation Temperature: -20 – 80 °C
- Stability: 0.2 mm/a
- Linearity: 0.2 mm
- Resolution: 0.01 mm
- Measuring range: 200 mm

The analogue signals from the pressure devices were captured and converted into measuring values during the use of the measuring system in a free time range, with the mean value and standard deviation being calculated at the end of each time range. The standard deviation of the mean value is normally an amount between 0.02 mm and 0.05 mm. An integrated mathematical temperature model can correct for the influences of temperature.

c) Measuring Dynamics

The dynamic response to the hydrostatic levelling device using pressure measurement distinguishes it from the liquid level gauge system since the head of the liquid oscillates with very small amplitudes. As an example, once stimulated, because of the conversion of the measuring system, the relaxation time has a value of about 10 s (100 m – hydrostatic levelling system). Classical liquid level gauge systems have a relaxation time ten times more than this.

d) Data Capture and Process Visualisation

The electrical capture of the measuring signals from, the measuring points was achieved by using electric/analogue (E/A) modules. These modules for analogue input were charged with 8 channels (to a maximum of eight measuring points for the complete hydrostatic levelling device) and a 16 Bit A/D converter, which assures a high monitoring speed. The sampling rate was 10 Hz. The decentralised arranged modules were linked with a RS-485 bus line and were guided by a computer. The technical specifications of process E/A modules are as follows:

- Total sampling rate in the network max. 1500 signals/s
- Sampling rate per module can be used without a repeater
- Up to 256 modules can be used without a repeater
- Watchdog survey for the module function and data transmission
- Power supply from 10V up to 30V
- Galvanic separation up to 3000V
- RS-485 interface with transmission rates of 300 up to 115.200 bps

- 16 bit A/D conversion

e) Monitoring Software

A personal computer read the signals provided by the modules as illustrated in (Figure 3.10). Getec Software was used to visualise the data and saves them in an archive.

The functionality of the visualisation software is as follows:

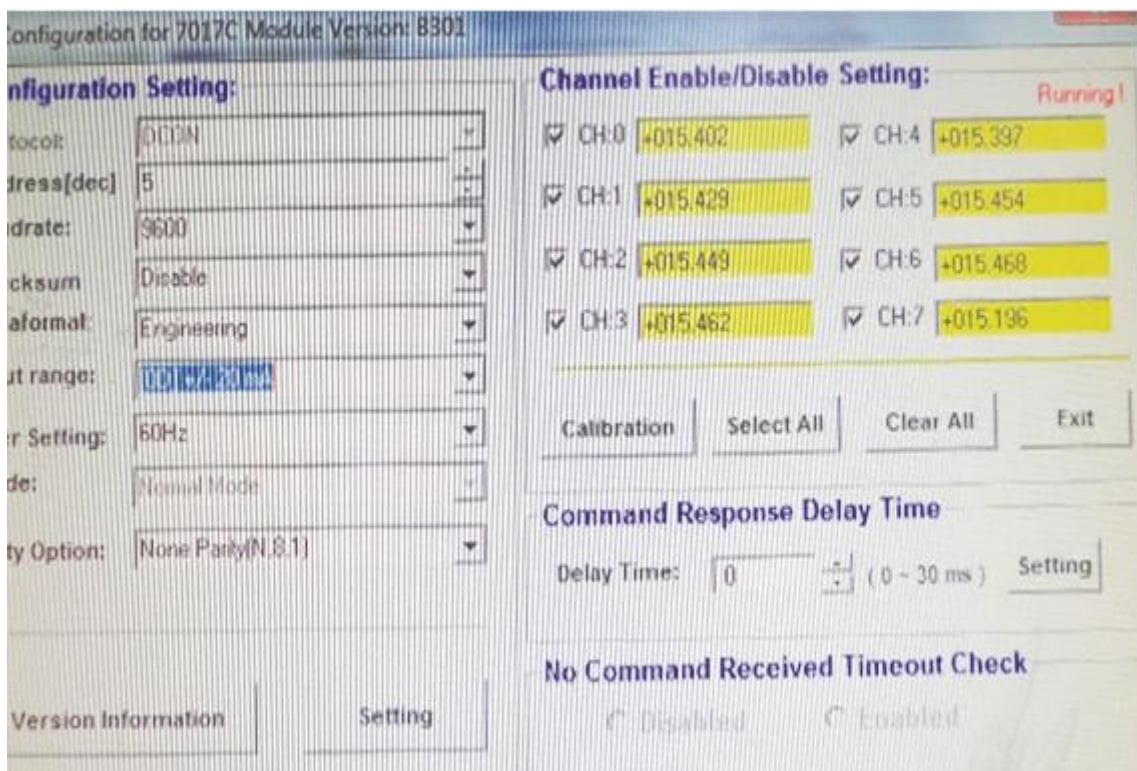

Figure 3.10 Hydrostatic Cells Levelling Monitoring Software

- Process visualisation-panel control
- Various software interfaces
- Archive for measuring value – ODBC Databases MS Access
- Data capture using a RS-485 bus line

f) Hydrostatic Cell Level Site Installation

The hydrostatic levelling cell installation was completed on 16th Oct 15 in the afternoon and the PC was set to record readings throughout the night so as to collect the measurements needed to check the data quality. A water test was completed early in the morning on 17th Oct 15 and the results were checked for accuracy. Following the water test, the data was exported to the website. Data was collected every 15 minutes and was available for viewing shortly after being recorded. (Figure 3.11) illustrates the HCL system in action observing the deflection and the transfer of data back to the Getec website. Values shown in blue are the settlements in mm, while values shown in orange are the temperatures for that cell. Two cells do not have temperatures are in close proximity to cells which do.

The graphical data were reviewed by selecting a certain point or all points together. It is also possible to plot settlement and temperature side-by-side to see any variation effects between the two. When viewing a chart it is possible to change the scales and the date ranges that are plotted. If any events occurred on site, or there are any comments in general within the system, these can be logged by expanding the journal option in the top right of the window, and typing a log entry for the time shown below in the bottom right as illustrated in Figure 3.11. Hence, if an historical observation or comment needs to be made this can be done by first changing the “Display Date” to the time of the event.

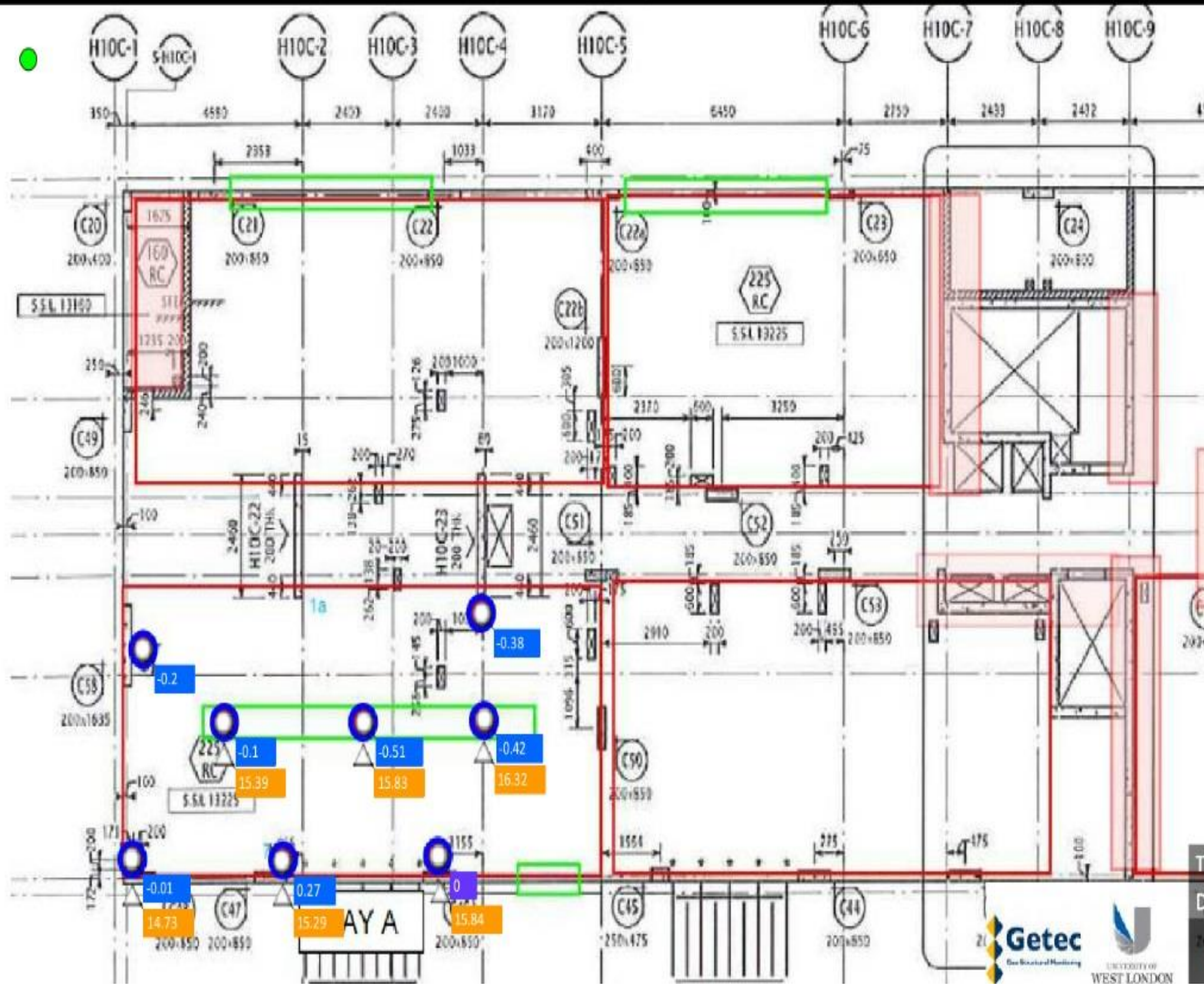

Figure 3.11 HCL System in Action Observing Deflection and Transferring Data

The slab deflection and temperature vs time recorded for the period of 142 days illustrated in Figure 3.12.

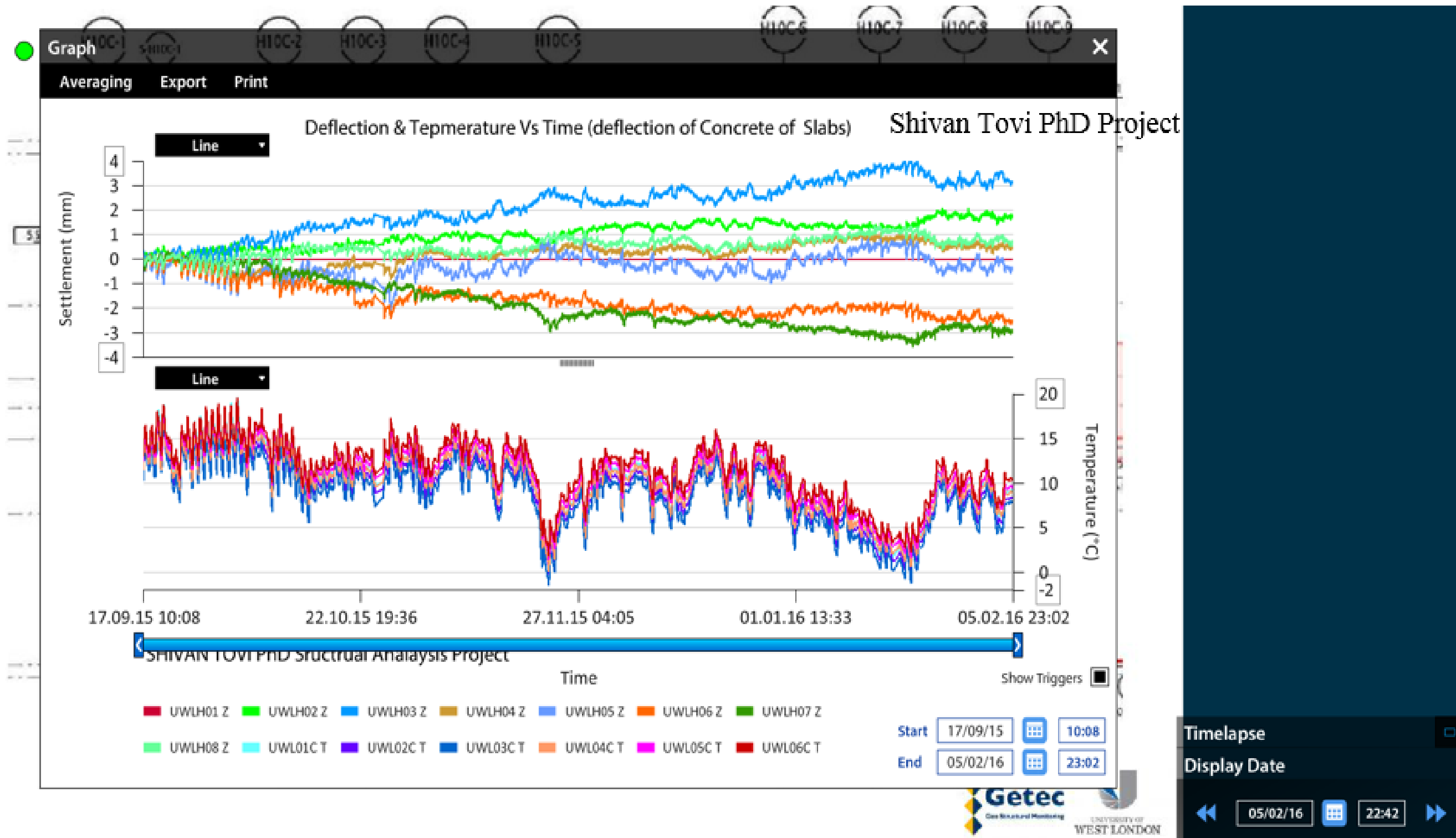

Figure 3.12 Deflection & Temperature Vs Time

g) Work Package Plan for Installation of Hydraulic Cell Level System

This work package plan by Getec (2016) describes the safe working practices and method required for the installation of a hydrostatic levelling cell (HLC) system comprising of eight HLCs at Elephant Gardens, for the University of West London. A site specific hazard assessment was completed once on site. The PhD Project Student (Author) at the University of West London, the reinforced concrete frame contractor, A. J. Morrisroe & Sons Ltd (2016), and the principal contractor Lend Lease UK (2016) were each given a copy of the work package plan prior to works commencing. The plan required that:

- All operatives attend a site-specific induction prior to the start of works
- All operatives are adequately trained and qualified for each task
- All operatives are briefed on the contents of this work package plan and are provided with a task briefing prior to commencing work
- All operatives are signed in and out of site as required by the client or principal contractor
- All equipment used has an inspection or calibration certificate which can be produced and validated if required

h) Scope

There is a requirement to document the performance of commercial reinforced concrete flat slabs in order to comment on current design assumptions.

Getec UK were tasked with the supply and installation of eight Getec 500 Hydrostatic Cells Levelling (HCL) onto the underside of a third floor reinforced concrete flat slab at a new development, Elephant Gardens located in Elephant & Castle - London, along

with the real-time presentation of the data obtained from the monitoring system using the specialist web-based monitoring software from Getec Quick View.



Figure 3.13 Location of Site Investigation, Elephant & Castle - London

The HCLs were attached to the underside of the concrete slab with two 6 mm diameter, 50 mm long stainless steel masonry screws into 8 mm diameter RAWL plugs. These required 8 mm holes to be drilled into the concrete slab to a depth of approximately 50 mm. Access was by means of a small scaffold tower.

The data logger PC and the liquid reservoir were mounted with four and two of the same screws, respectively, at locations deemed most suitable when on site.

The cabling and tubing was run between the HLCs around the edge of the concrete slab and secured with cable ties to cable tie bases nailed to the concrete approximately every 0.5m using a gas actuated fastening tool.

Due to the location of the bleed valves on the HLCs a different method needed to be adopted to fill the system: each HLC was removed from the slab and tilted to an upright position, thus allowing the air to be bled from the HLC as it usually would be. Once all the air had been bled from the HLC it was then re-attached to the underside of the slab. To facilitate the filling of the system the header tank was placed as high up as possible as recommended and supervised by the PhD researcher.

See (Figures 3.11 and 3.14) for the approximate location of the HLCs.

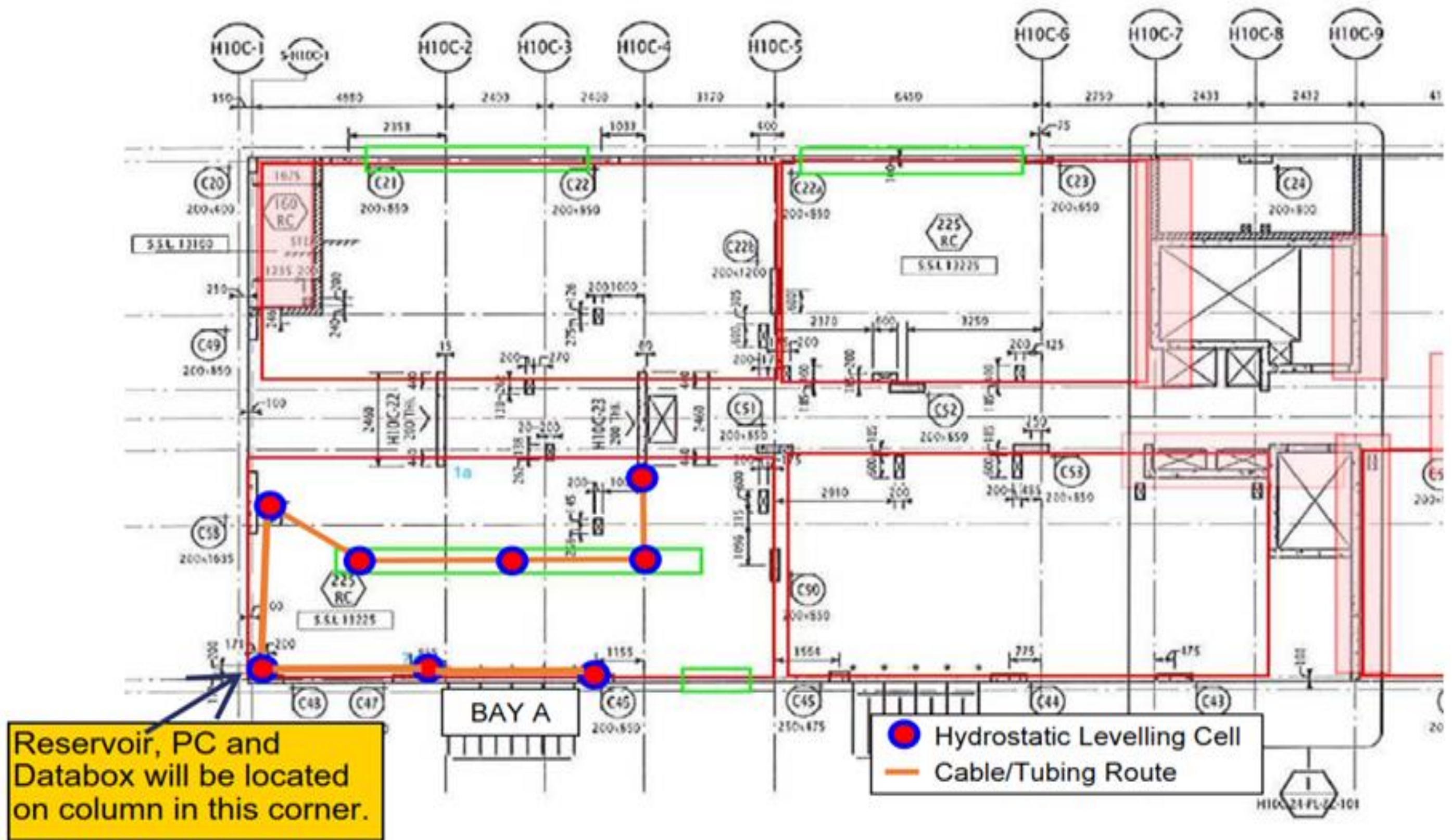

Figure 3.14 HCL Attached to the Underside of the Concrete Slab

3.2.3 Shape Accel Array (SAA) Method

Getec (2016) apply the Shape Accel Array (SAA) produced by Measurand for accurately observing slab deflections, sewer movement, retaining walls, and drilling inclination observation.



Figure 3.15 Shape Accel Array (SAA) (Getec 2016)

The Shape Accel Array (SAA) can also be applied for vibration observing. SAA is a series of solid slices separated by joints that can shift in any direction but cannot twist. MEMS gravity sensors observe decline in two directions. Processors convert the location (X,Y & Z) of each cell to produce format and transform of format.

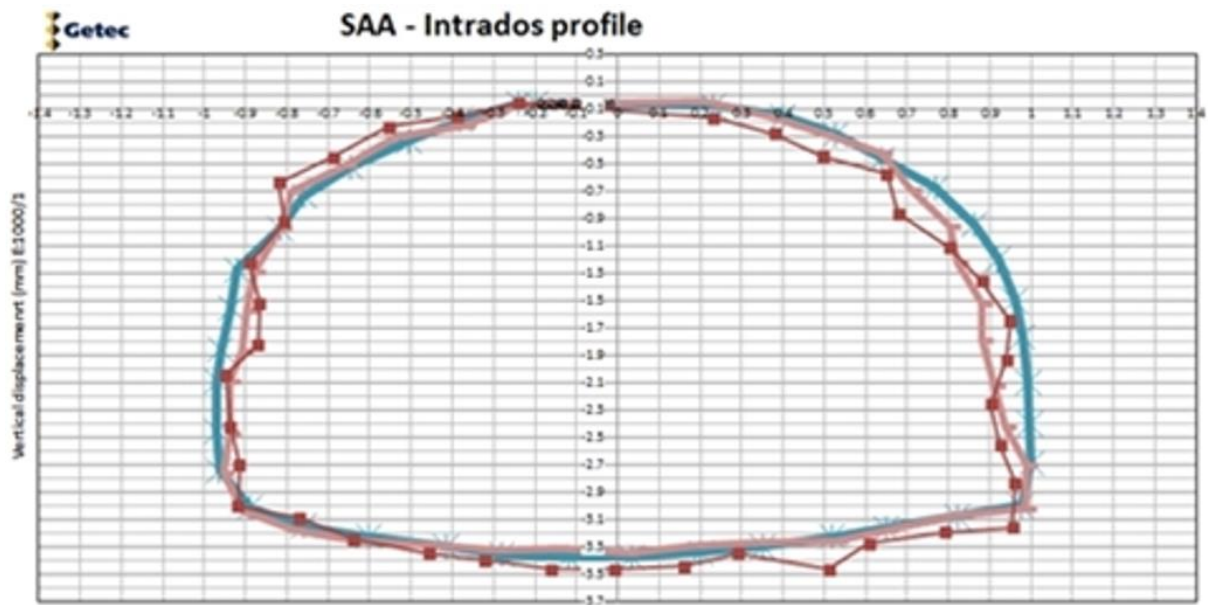

Figure 3.16 (SAA) – Intrados Profile (Getec 2016)

The SAA data can be applied instantly in the gtcVisual observing software and with SAA Viewer app that is merged into gtcVisual, standalone PC and all android platforms.

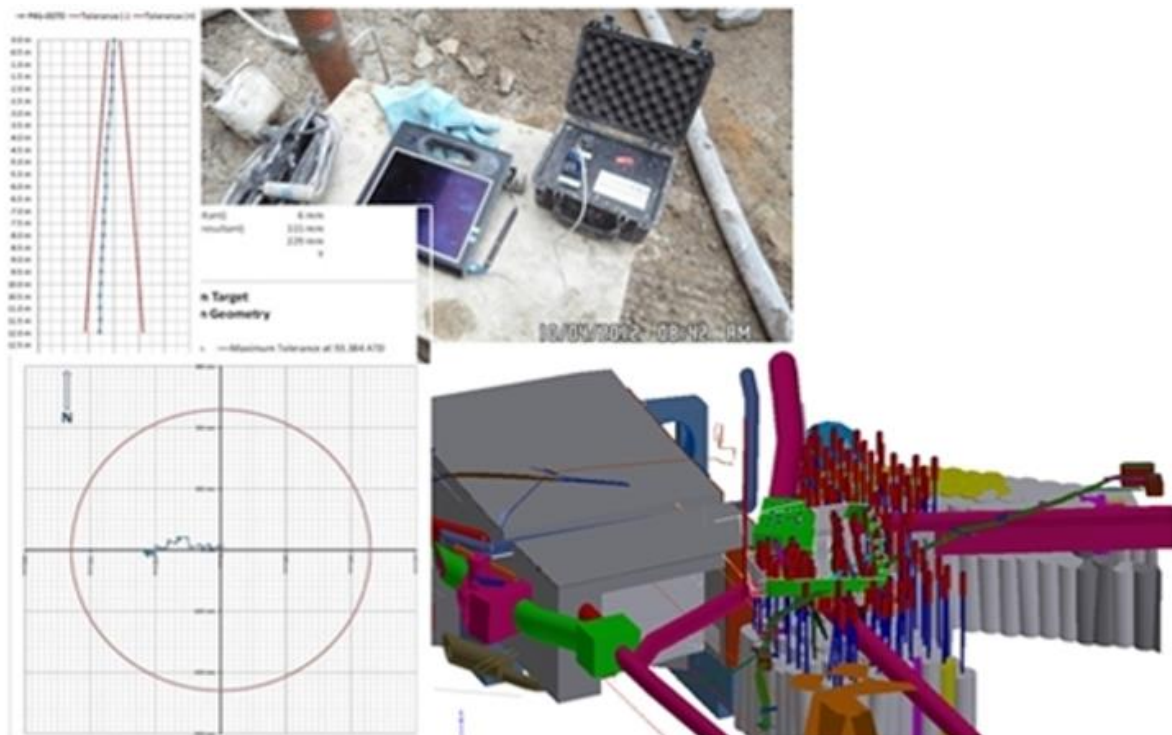

Figure 3.17 Practicality of Shape Accel Array (SAA) (Getec 2016)

Getec have successfully applied the SAA to observe slab heave and deflection, drill positioning, tank base movement, retaining wall deformation and sewer deformation.

3.2.4 Optical Fibre Method

The instantly growing technology of microelectromechanical systems (MEMS) is facing exceptional growth in communication and sensing implementations. MEMS systems commercially under development for optical communication implementations include optical cross-connects as stated by David and Roland (2000), add-drop wavelength multiplexers as Joseph et al (1999) states, obtain equalisers, and tuneable lasers and filters as Burrer et al (1996) indicates. Moreover, MEMS sensing systems have gained commercial prosperity in micro accelerometers. More MEMS systems presently under development include resonant transducer sensors, gyroscopic sensors, magnetic field sensors and pressure sensors. In spite of the fact that not all MEMS systems inclose movable elements, the systems shown below indicate the usual trait that they cover some out-of-plane movable element (Tayag et al 2003).

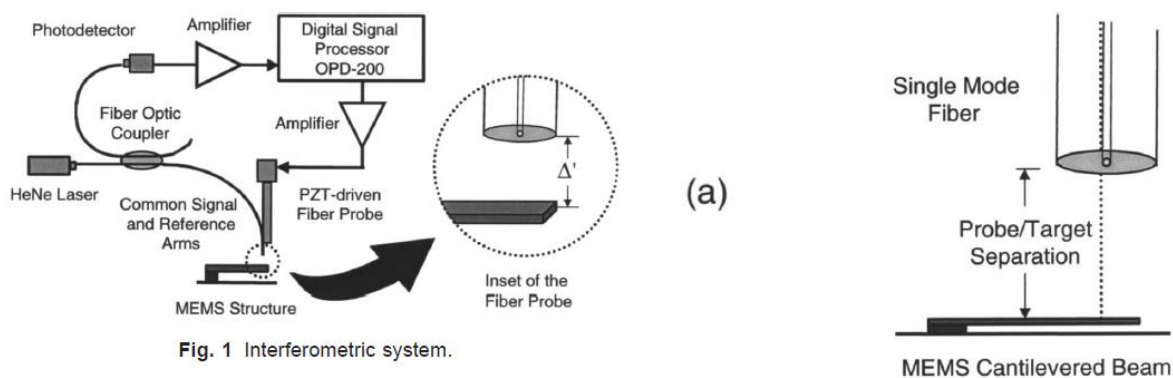

Figure 3.18 Optical Fibre Interferometer (Tayag et al 2003)

3.3 Planned Sequence of Tasks

The planned sequence of tasks is outlined in Table 3.2.

Table 3.2 Planned Sequence of Tasks

| Task Number | Description | Approximate Duration | Planned Sequence |
|-------------|--|----------------------|------------------|
| 1 | Preparation and checking of kit, briefings etc. | 0.25 days | ■ |
| 2 | Mounting of the HLCs and Data logger PC. | 0.25 days | ■ |
| 3 | Running and connecting up cabling and tubing to the HLCs. | 0.25 days | ■ |
| 4 | Wiring up Data logger PC. | 0.25 days | ■ |
| 5 | Fixing of reservoir and filling of system with Antifreeze mix. | 0.25 days | ■ |
| 6 | Set up of PC and testing. | 0.5 days | ■ |

If alterations were required to be done on site the changes had to be reviewed and initialled by the Site Supervisor or Project Manager and submitted as a new revision of the document at a later date. The Site Supervisor and Project Manager were informed of any delays to the programme.

3.3.1 Authorisation

Getec UK started work on site with prior authorisation from the PhD Researcher at the University of West London, Morrisroe and Lend Lease. Upon completion of the works the work area was made clean and safe and checked by Morrisroe and Lend Lease prior to Getec UK leaving the site.

3.3.2 Quality Requirements

For the calibration and validation procedures after completion of the work an installation report was prepared by the PhD Researcher (Author), and was limited to

the location of the sensors, installation details, baseline values, early instrument readings and calibration certificates.

3.3.3 Materials

The following materials were used to install the Hydraulic Cell Level system on site:

- 8 Getec 500 HLCs.
- 1 Fluid Reservoir
- 1 Data logger PC
- Cable ties
- Cable tie bases
- Steel/masonry nails
- 8mm/11mm PVC tubing
- 4mm/6mm PVC tubing
- Cell screws
- RAWL plugs
- Data cable
- De-mineralised water/antifreeze mix
- Electrical tape

3.2.4 Tools

The following tools were used to install the Hydraulic Cell Level system on site:

- Side cutters

- Screwdrivers
- Tape measure
- Spanners
- Water pump pliers
- Allan keys
- Hand clamps
- Ratchet and extension bar
- Hilti TE-6A battery operated SDS drill
- 8mm drill bit
- Hilti GX-120 gas actuated fastening tool

3.3.5 Plant

A platform (scaffold tower) was used to reach the slab in order to fix the cell sensors under the slab.

3.4 HLC's Calibration Certificate

All hydrostatic levelling cells were factory calibrated, and their calibration certificates are included in Appendix.

Temperature generally has an influence on the measurements and therefore affects the accuracy of the system. The main reason for this is the well-known change of density of a liquid utilized as a function of its temperature. There is also an influence on the sensor when temperature reaches the limits of its temperature range.

There are both uniform and a differential temperature effects. Uniform temperature changes result in a uniform pressure change in all the measurement points due to the aforementioned change of density. This uniform pressure difference does not give a displacement.

In contrast to uniform changes, local thermal effects on the tubes and the sensors have an effect on the readings. The temperature influence on the hydrostatic levelling system is determined by either a change in water density, a fluid exchange between the liquid reservoir and tubing, dilatancy of the liquid reservoir, or the thermal coefficient of the zero point of the sensor.

With the exception of the change in water density and the thermal coefficient of the zero-point of the sensor, the temperature effects cause uniform pressure differences in the water circuit which have no influence on the measurement of the hydrostatic levelling system. As far as possible, the design of the liquid level system can be optimized in such a way that vertical tube sections will be avoided. To compensate for local temperature effects, mathematical algorithms were investigated. These algorithms are derived from observations made during a certain measurement period. These thermal coefficients are applied for the different sensors in the data capturing system on the PC.

3.5 Striking of Slabs Calculation, Elephant & Castle MP1 – Block (H10C)

Based on the 'Early striking and improved backpropping for efficient flat slab Construction by British Cement Association (2001) and (CIRIA REP 136 1995), more information on striking of slabs calculation can be obtained from Appendix H.

Design Data: Design Loads as load plan 30/05/14

Concrete grade used for slab striking calculations

Concrete Strength 45 N/mm^2

Transfer Slabs 50 N/mm^2

Calculation Sheet for relevant conditions attached.

Loading plan is colour coded and illustrated in (Figure 3.19) describing the loading areas.

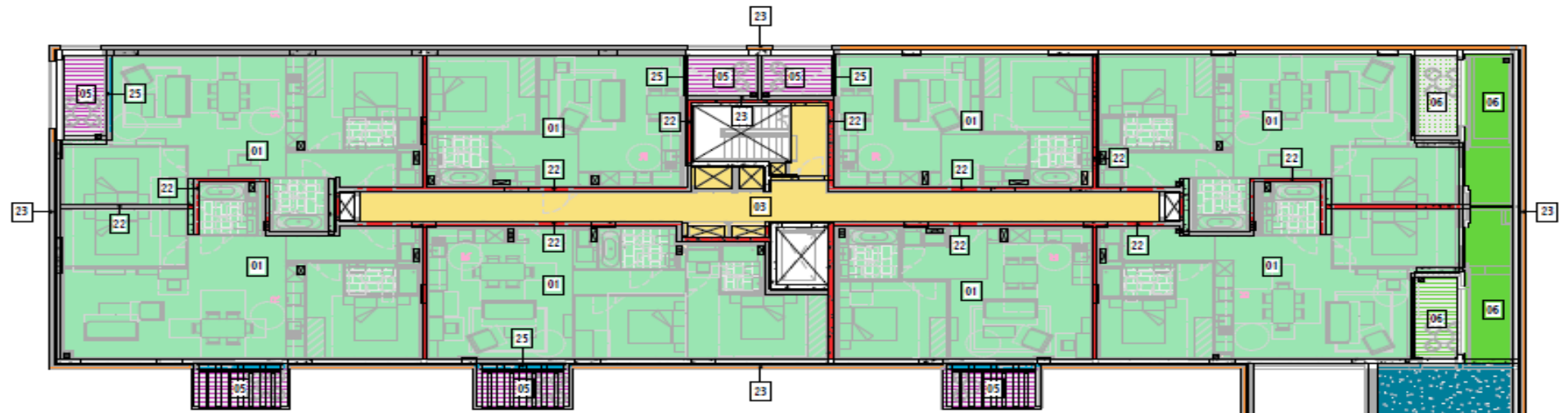

| MARK | LEGEND | DESCRIPTION | S.D.L. (kN/m ²) | LL. (kN/m ²) |
|------|--------|--|--|--------------------------|
| 01 | | RESIDENTIAL FLOORS (RC FLOORS) | NON LOAD BEARING PARTITIONS 20mm TIMBER FLOOR/HARD FINISHES UNDER FLOOR HEATING 15mm RESILIENT UNDERLAY CEILING & SERVICES =1.0 kN/m ² =0.3 kN/m ² =0.8 kN/m ² =0.2 kN/m ² =0.3 kN/m ² TOTAL: 2.4kN/m ² | 1.5kN/m ² |
| 02 | | RESIDENTIAL (CLT FLOORS) | NON LOAD BEARING PARTITIONS 20mm TIMBER FLOOR/HARD FINISHES UNDER FLOOR HEATING 15mm RESILIENT UNDERLAY CEILING & SERVICES =1.0 kN/m ² =0.3 kN/m ² =0.8 kN/m ² =0.2 kN/m ² =0.3 kN/m ² TOTAL: 2.4kN/m ² | 1.5kN/m ² |
| 03 | | RESIDENTIAL LOBBIES, CORRIDORS & STAIRS (RC STAIRS) | NON LOAD BEARING PARTITIONS 20mm TIMBER FLOOR UNDER FLOOR HEATING CEILING & SERVICES =1.0 kN/m ² =0.1 kN/m ² =0.8 kN/m ² =0.3 kN/m ² TOTAL: 2.0kN/m ² | 3.0kN/m ² |
| 04 | | RESIDENTIAL LOBBIES, CORRIDORS & STAIRS (CLT FLOORS) | NON LOAD BEARING PARTITIONS 20mm TIMBER FLOOR UNDER FLOOR HEATING CEILING & SERVICES =1.0 kN/m ² =0.1 kN/m ² =0.8 kN/m ² =0.3 kN/m ² TOTAL: 2.0kN/m ² | 3.0kN/m ² |
| 05 | | RESIDENTIAL BALCONIES | TIMBER DECKING SERVICES & CLADDING STRUCTURAL FRAME =0.25 kN/m ² =0.25 kN/m ² =1.0 kN/m ² TOTAL: 1.5kN/m ² | 3.0kN/m ² |
| 06 | | RESIDENTIAL TERRACES | TIMBER DECKING (DECKING SUPPORT AND COUNTER BATTENS) WEATHERING & INSULATION CEILING & SERVICES =2.0 kN/m ² =0.2 kN/m ² =0.3 kN/m ² TOTAL: 2.5kN/m ² | 3.0kN/m ² |
| 07 | | RETAIL FLOOR | FLOOR FINISHES (TFC) =3.6 kN/m ² TOTAL: 3.6kN/m ² | 3.0kN/m ² |
| 08 | | ROOF PLANT | 150mm FLOATING SLAB 50mm SAND BEDDING 50mm DRAINAGE LAYER WEATHERING & INSULATION CEILING & SERVICES =3.75 kN/m ² =1.25kN/m ² =0.5 kN/m ² =0.2 kN/m ² =0.3 kN/m ² TOTAL: 6.2kN/m ² | 7.5kN/m ² |
| 09 | | EXTENSIVE GREEN ROOF AREA | VEGETATION ALLOWANCE 150mm SOIL LAYER 50mm DRAINAGE LAYER WEATHERING & INSULATION CEILING & SERVICES =0.5 kN/m ² =3.0 kN/m ² =0.5 kN/m ² =0.2 kN/m ² =0.3 kN/m ² TOTAL: 4.5kN/m ² | 3.0kN/m ² |
| 10 | | EXTENSIVE BIODIVERSE ROOF | VEGETATION ALLOWANCE 150mm SOIL LAYER 50mm DRAINAGE LAYER WEATHERING & INSULATION CEILING & SERVICES =0.5 kN/m ² =3.0 kN/m ² =0.5 kN/m ² =0.2 kN/m ² =0.3 kN/m ² TOTAL: 4.5kN/m ² | 3.0kN/m ² |
| 11 | | GREEN ROOF WITH P.V. PANELS | EXTENSIVE GREEN ROOF P.V. PANELS & FRAMES =4.5 kN/m ² =1.5 kN/m ² TOTAL: 6.0kN/m ² | 1.5kN/m ² |
| 12 | | ROOF CRAVEL | 150mm CRAVEL WEATHERING & INSULATION CEILING & SERVICES =3.0kN/m ² =0.2kN/m ² =0.3kN/m ² TOTAL: 3.5kN/m ² | 1.5kN/m ² |
| 13 | | EXTERNAL GROUND FLOOR LANDSCAPING | LANDSCAPING BUILD UP 50mm DRAINAGE LAYER =6.0 kN/m ² =0.5 kN/m ² TOTAL: 6.5kN/m ² | 3.0kN/m ² |
| 14 | | REFUSE AREAS | ALLOWANCE FOR 75mm SCREED LAID TO FALLS =1.5 kN/m ² TOTAL: 1.5kN/m ² | 3.0kN/m ² |

| MARK | LEGEND | DESCRIPTION | S.D.L. (kN/m ²) | LL. (kN/m ²) |
|------|--------|------------------------------------|--|--------------------------|
| 15 | | CYCLE STORAGE | ALLOWANCE FOR 75mm SCREED LAID TO FALLS =1.5 kN/m ² TOTAL: 1.5kN/m ² | 2.5kN/m ² |
| 16 | | PLANT | ALLOWANCE FOR 75mm SCREED LAID TO FALLS =1.5 kN/m ² TOTAL: 1.5kN/m ² | 7.5kN/m ² |
| 17 | | STORE ROOM | 75mm SCREED LAID TO FALLS =1.5 kN/m ² TOTAL: 1.5kN/m ² | 7.5kN/m ² |
| 18 | | CAR PARK | N/A | 2.5kN/m ² |
| 19 | | RAISED PLANTER | VEGETATION ALLOWANCE 450mm SOIL LAYER 50mm CONCRETE RAVERS 50mm SAND BEDDING 50mm DRAINAGE LAYER WEATHERING & INSULATION CEILING & SERVICES =0.5 kN/m ² =8.0 kN/m ² =1.25 kN/m ² =1.25 kN/m ² =0.2 kN/m ² =0.3 kN/m ² TOTAL: 11.7kN/m ² | 3.0kN/m ² |
| 20 | | WATER TANK | WATER TANK =1.0 kN/m ² TOTAL: 1.0kN/m ² | 20.0kN/m ² |
| 22 | | INTERNAL PARTY WALLS | 4 LAYERS 15mm PLASTERBOARD 50mm MINERAL WOOL METAL STUDS (LINE LOAD 3.0kN/m PER FLOOR) =0.6 kN/m ² =0.3 kN/m ² =0.1 kN/m ² TOTAL: 1.0kN/m ² | - |
| 23 | | SINGLE LEVEL EXTERNAL BRICK FACADE | 100 BRICKWORK (LINE LOAD 10.0kN/m PER FLOOR) =3.3 kN/m ² TOTAL: 3.3kN/m ² | - |
| 24 | | EXTERNAL BRICK FACADE (2 STOREYS) | 102mm BRICKWORK METAL STUD AND PLASTERBOARD INSULATION (LINE LOAD 18kN/m PER FLOOR) =0.2 kN/m ² =0.4 kN/m ² =0.4 kN/m ² TOTAL: 3.0 kN/m ² | - |
| 25 | | CLAZED FACADE | 2 LAYERS OF 16mm CLASS ALUMINUM FRAME (LINE LOAD 4.0kN/m PER FLOOR) =1.0 kN/m ² =0.2 kN/m ² TOTAL: 1.2kN/m ² | - |
| 26 | | METAL BALUSTRADE | =1.0 kN/m ² TOTAL: 1.0kN/m ² | - |
| 27 | | BLOCKWORK | 140 BLOCKWORK (LINE LOAD 10.0kN/m PER FLOOR) =3.3 kN/m ² TOTAL: 3.3kN/m ² | - |

Figure 3.19 Loading Plan, Block (H10C), Refer to (Figure 5.2 and 5.3) for detail

3.6 Summary

The behaviour of the service load depends on the material properties of the concrete however, at the early stage of design, these factors are largely unknown. And using the nonlinear and inelastic behaviour of concrete at the service load to design for serviceability limitation is complicated. Codes for serviceability limitation design are comparatively modest and, in some cases uncertain; indeed, even inaccurate in modelling structures' behaviour. There has been a widespread failure to calculate the effect of shrinkage and creep on concrete structures.

In this research Hydrostatic Cell Levelling system were identified as accurate and practical system for monitoring the slab deflection. The slab monitoring started from a very early stage in the casting when the slab was still wet. The Hydraulic Levelling Cells were positioned under the slab while the workers were pouring the rest of the 3rd floor on the top. This study shows that the slab has been deformed by 2 mm, and it can be seen that the deflection started developing very slowly. Starting from 0 mm to 0.51 mm, and then by day 142 ending up with 2 mm.

The formwork and falsework were left in an inordinately long time – approximately one month instead of typical two weeks turnover. This practice may have contributed to reduction of overall deflection and as indicated in the result certainly minimised the deflection during the first month. Further study is required to investigate and quantify positive impact of the long term propping.

The shortening of 1.4mm/m is allowable. A better technique is to limit the differential shortening by calculating all reinforced concrete columns to the same standard, and by conserving long obvious spans between various structural shapes.

CHAPTER FOUR: Deformation of Multi-Storey Flat Slabs, a Finite Elements Analysis and Precise Levelling

Traditional reinforced concrete slabs and beams are widely used for the building. The use of flat slab structures gives advantages over traditional reinforced concrete building in terms of design flexibility, easier formwork and use of space and shorter building time. Deflection of the slab plays critical role on design and service life of the building components, however there is very little recent research to explore actual deformation of concrete slabs whereas there have been various advancements within the design codes and construction technology (Tovi et al in 2017).

This chapter provides calibration of Finite Elements packages for monitoring the deformation of structures with flat slabs and presents and discusses the experimental results for the vertical deformation. Computational simulation by using Bentley and ETABS has been used to analyse and determine deflection on reinforced concrete slabs according to Eurocode 2.

Levelling is commonly used within the construction industry to monitor the deflection or deformation of the structures. This study presents results of levelling data for multi-storey concrete structures, Elephant and Castle in London and aims to evaluate accuracy of levelling data by comparing to simulation analysis (Bentley and ETABS).

4.1 Introduction

This study aims to compare two Finite Elements packages (Bentley and ETABS) with reality (Precise Levelling site data) in order to investigate the deflection of Multi-Storey flat slabs and the behaviour of concrete slabs under load.

Concrete deflections can be controlled, if the service load behaviour has been studied carefully. The behaviour of slab subjected to service loads initially depends on the

material properties of the concrete but, at the early stage of design, these factors are largely unknown. And using the nonlinear and inelastic behaviour of concrete at the service load to design for the Serviceability Limit state (SLS) is complicated. Standard codes for (SLS) design are comparatively modest and, in some cases uncertain; indeed, even inaccurate in modelling structures' behaviour as Tovi et al (2016) indicates. In short, there has been a widespread failure to calculate the effect of shrinkage and creep on concrete structures (Tovi et al 2016).

Deflection in respect to pre-stressed and reinforced slab structures may be calculated using several techniques, using either simple, or more advanced and refined methods. Beside elastic deformation it is important to include the effect of shrinkage and creep. A clearer understanding of concrete slab behaviour may be obtained from advanced analytical methods. Hence two leading Finite Elements packages were examined and used to predict deflection on the test slab.

The reasons for controlling deflection as Technical report no. 58 by The Concrete Society (2005) indicates is to alleviate safety concerns, since deflection in flat slabs must be unnoticeable by residents.

Current design limits on deformation such as Eurocode 2 are based on limits set four decades ago as presented by ISO 4356 (1977). When the forms of construction, partitions, finishes, cladding, and services were very different to what they are now. It is possible, therefore, that the current limits are too conservative, and more research is thus needed to understand current performance in order to enable more sustainable and economic designs.

Serviceability and strength are two main criteria to consider when designing concrete structures. There has been limited recent academic research into deflection limits for

concrete slabs and this emphasises how significant and important this study will be for understanding the behaviour of the deflection of concrete slabs (Tovi et al 2016).

In many cases, appropriate control of deflections may be achieved by complying with detailed span/depth ratios. There are some cases, however, where they should be determined to conform to tolerances concerning partitions and cladding, such as the case in St George's Wharf, London, UK (Vollum 2004).

The deflection of concrete slabs, depends on many variables such as loading, strength and cracking, among others, and estimation of deflection is critical in the sizing and reinforcement of slabs. The current design limits appear to be traditional, perhaps inappropriate to today's forms of structural design and material reduction in the name of sustainability. The International Federation for Structural Concrete fib (2014) encourages more research on the behaviour of reinforced concrete slabs by applying both experimental and observation programme and this research is taking up the challenge.

The design of reinforced concrete structures is usually based on small deformation theories. The different design methods aim at keeping deflections and crack widths within adequate serviceability limits (Gouverneur et al 2015).

One of key issues in designing the deflection using typical classic techniques is the lack of a valid provision. The high costs involved in curing, casting and testing procedures of structural elements. Addressing this issues require finding the inexpensive new effective tools for designing of reinforced concrete slab behaviours such as deflection, crack width, etc. This involves the use of classical and /or modern designs for prediction of concrete slab deflection with assurance on structural behaviour and non-linear strain distribution (Mohammadhassani et al 2013).

Precise levelling is a technique of differential levelling which uses extremely accurate levels and with more stringent methods of making observations than normal engineering levelling. It aims to obtain high levels of accuracy such as 1 mm per 1 km traverse. However, the Hydrostatic Cell Levelling system were identified as accurate and practical system for monitoring the slab deflection as Tovi et al (2017) indicates. The whole idea was to compare the results from two leading FEA packages (Bentley and ETABS) with results from site. The Elephant and Castle site in London was used for experimental part of this study and observations were carried out on the 3rd floor of block H10C.

4.2 Bentley: Structural Design Analysis Results

Bentley is a well-known Finite Elements package, the package has been used in Elephant and Castle-London block H10C to observe analyse the deflection on concrete slab considering the parameters presented in Table 5.1:

Table 4.1 Bentley Design Rules (3rd Floor Elephant and Castel – London)

Construction Site Block H10C

| RAM Structural System | Integrate Slab and Foundation Models | Design Rules |
|--|---|--|
| Steel: Design and model structure | Model slabs and foundations using specified applications that are combined within the master analysis design. | Code Minimum Design: EC2:2004 (UK) Min. Reinforcement |
| RAM Concrete: Obtain reinforcement quantities for both lateral frames and gravity | Generate model determinations and reinforcing plans. | User Minimum Design: Specified Min. Reinforcement |
| RAM Frame: Analyse walls and frames, including compliance with seismic and wind requirements | Add the design details in BIM design by using ISM. | Initial Service Design: EC2:2004 (UK) Initial Service Design |
| RAM Foundation: Evaluate, analyse and design spread, continuous, and pile cap foundations | | Quasi-Permanent Service Design: EC2:2004 (UK) Quasi-Permanent Service Design Include detailed section analysis |

4.2.1 Detailing Rules

Custom span detailing rules are illustrated in Figure 4.1, "A", "B" and "C", are support reinforcement sets, based on the peak reinforcement in the support zone. "D", "E" and "F", are span reinforcement sets, based on the peak reinforcement in the span zone.

"*R1" is never taken as greater than 0.2 when multiplied by load combination (Lc or Lcc).

"Fraction" is the ratio of set reinforcement to peak reinforcement. It is always in the 0.0 to 1.0 range.

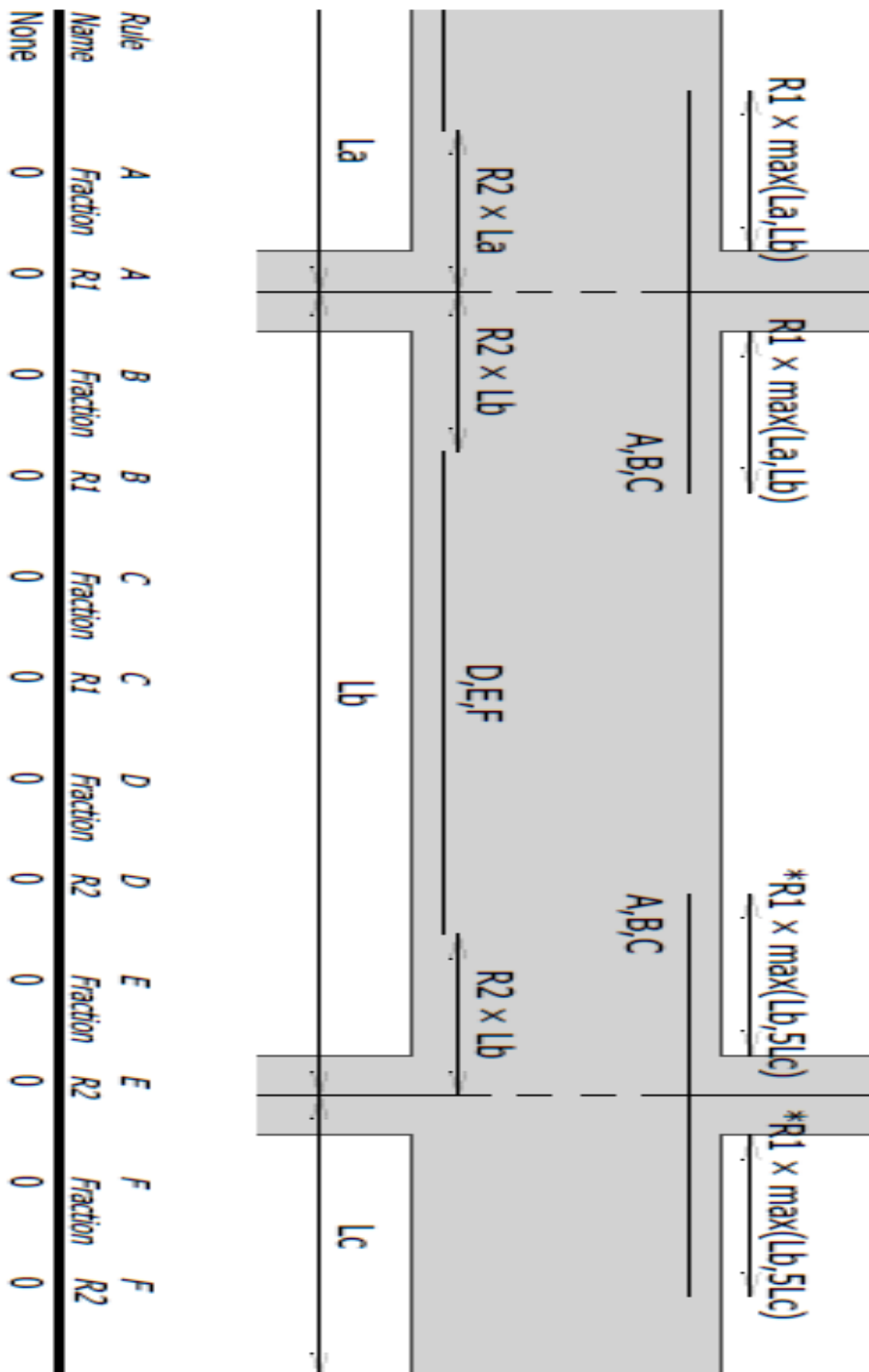

Figure 4.1 Custom Span Detailing Rules

4.2.3 Materials

Concrete mix and materials in Table 4.2 has been considered for the 3rd floor block H10C bottom left corner bay highlighted in red rectangular.

Table 4.2 Concrete Mix (3rd Floor Elephant and Castel Construction Site Block H10C)

| Mix Name | Density (kg/m ³) | Density for Loads (kg/m ³) | f'ci (N/mm ²) | f'c (N/mm ²) | fcui (N/mm ²) | fcu (N/mm ²) | Poissons Ratio | Ec Calc | User Eci (N/mm ²) | User Ec (N/mm ²) |
|----------|------------------------------|--|---------------------------|--------------------------|---------------------------|--------------------------|----------------|---------|-------------------------------|------------------------------|
| C45/55 | 2400 | 2400 | 25 | 45 | 30 | 55 | 0.2 | Code | 25000 | 33500 |

Figures 4.2 and 4.3 illustrates the architectural plan of 3rd floor block H10C, Elephant and Castle construction site, which is has been used to observe deflection

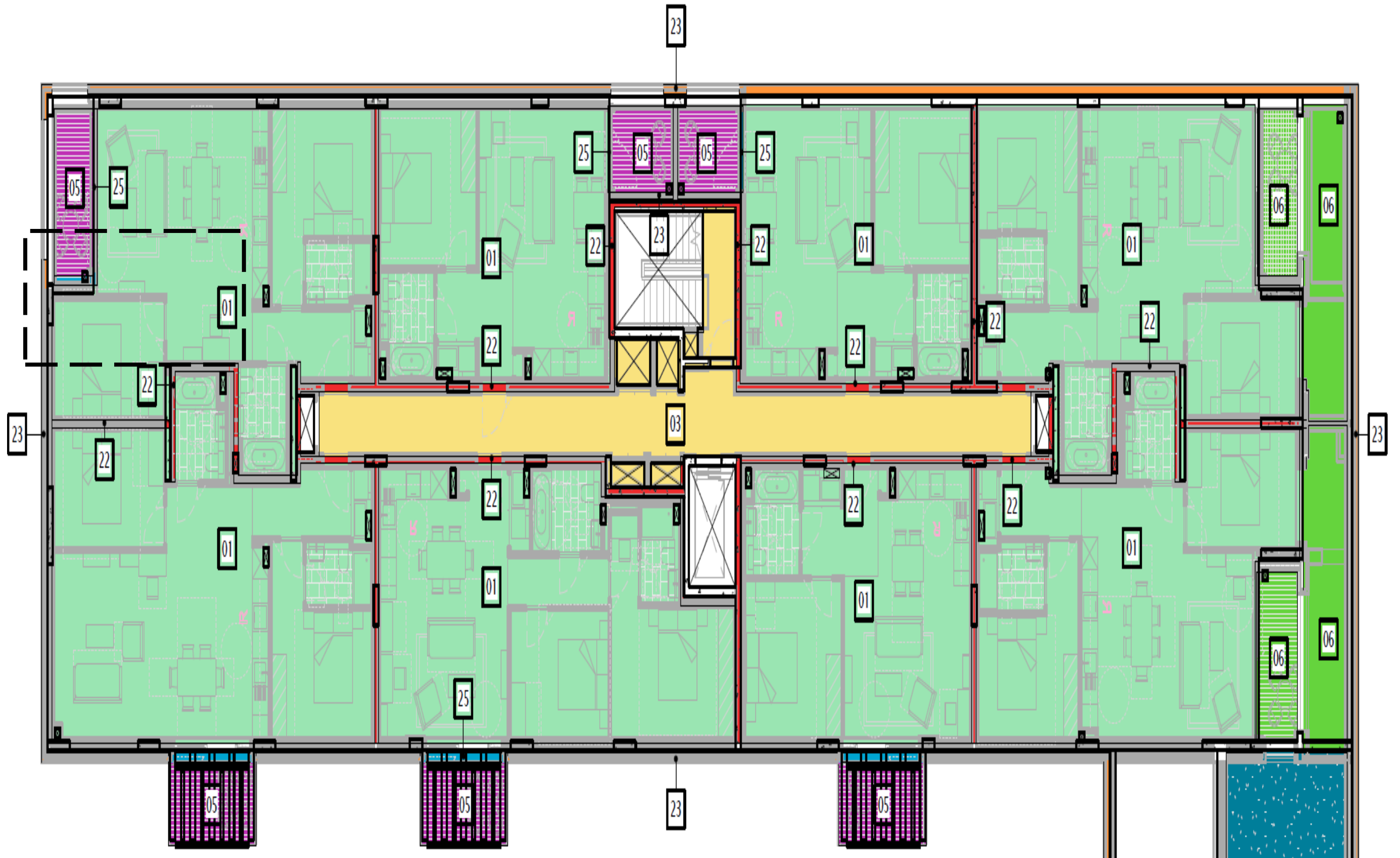

Figure 4.2 Loading Regions Colour and Number Coded [dashed rectangular]





| MARK | LEGEND | DESCRIPTION | S.D.L. (kN/m ²) | | I.L. (kN/m ²) |
|------|---|---|--|--|---------------------------|
| 01 |  | RESIDENTIAL FLOORS (RC FLOORS) | NON LOAD BEARING PARTITIONS 20mm TIMBER FLOOR/HARD FINISHES UNDER FLOOR HEATING 15mm RESILIENT UNDERLAY CEILING & SERVICES | =1.0 kN/m ² =0.3 kN/m ² =0.6 kN/m ² =0.2 kN/m ² =0.3 kN/m ² TOTAL: 2.4kN/m ² | 1.5kN/m ² |
| 03 |  | RESIDENTIAL LOBBIES, CORRIDORS & STAIRS (RC STAIRS) | NON LOAD BEARING PARTITIONS 20mm TIMBER FLOOR UNDER FLOOR HEATING CEILING & SERVICES | =1.0 kN/m ² =0.1 kN/m ² =0.6 kN/m ² =0.3 kN/m ² TOTAL: 2.0kN/m ² | 3.0kN/m ² |
| 05 |  | RESIDENTIAL BALCONIES | TIMBER DECKING SERVICES & CLADDING STRUCTURAL FRAME | =0.25 kN/m ² =0.25 kN/m ² =1.0 kN/m ² TOTAL: 1.5kN/m ² | 3.0kN/m ² |
| 06 |  | RESIDENTIAL TERRACES | TIMBER DECKING (DECKING SUPPORT AND COUNTER BATTENS) WEATHERING & INSULATION CEILING & SERVICES | =2.0 kN/m ² =0.2 kN/m ² =0.3 kN/m ² TOTAL: 2.5kN/m ² | 3.0kN/m ² |

Figure 4.3 Loading Regions Colour and Number Coded

Load History

Table 4.3 Load History Details

| Load History Step Name | Load Combination | Duration (days) | Total Age (days) |
|--------------------------|---|-----------------|------------------|
| Maximum Short Term Load | Frequent Service LC: D + Ψ 1L | 30 | 33 |
| Sustained Load | Quasi-Permanent Service LC: D + Ψ 2L | 5000 | 5033 |
| Final Instantaneous Load | Frequent Service LC: D + Ψ 1L | 0 | 5033 |

4.2.4 Finite Element Standard Plan

Finite element method has been used to analysis block (H10C). Finite element standard plan as illustrated in Figure 4.4 describes the third floor block (H10C) mesh showing all elements including slabs, columns, walls, holes and point supports. Red area indicates the deflection bay where the site investigation carried out in Elephant and Castle block H10C – London.

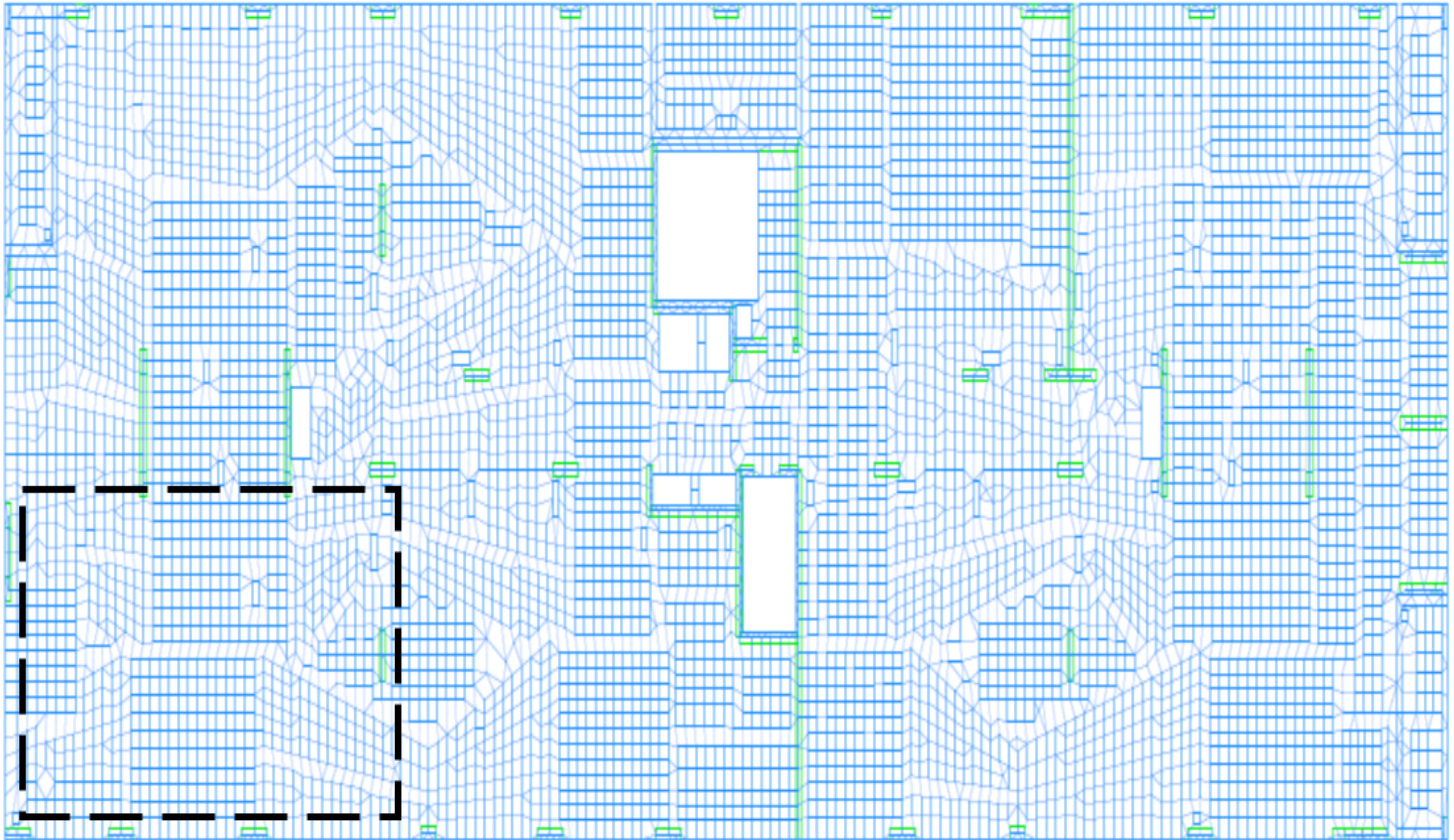
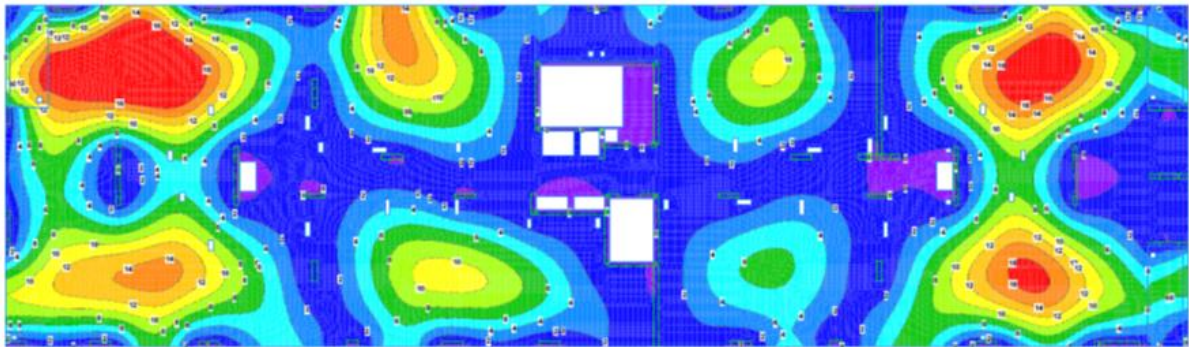

Figure 4.4 Finite Element Standard Plan Block H10C, 3rd Floor Elephant and Castle - London

4.2.5 Long-term Deflection

Sustained deflection plan as illustrated in Figure 4.5 shows the impact of sustained load causing vertical deflection.

The analysis indicates that the amount of deflection that occurs due to sustained load ranges from 1.55 mm to 22.94 mm as a maximum deflection value.



Sustained Load - Vertical Deflection Plot

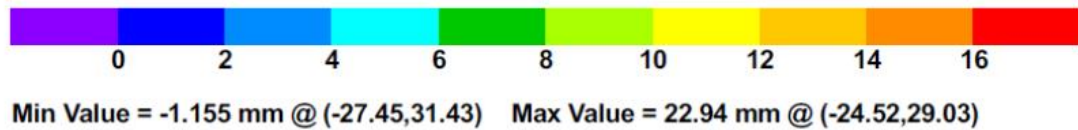

Figure 4.5 Long-term Deflection Plan due to Sustained Load

4.3 ETABS: Structural Design Analysis Results

ETABS is a well-known Finite Elements package, the package has been used in Elephant and Castle-London block H10C to observe analyse the deflection on concrete slab considering the parameters illustrated in Table 4.4:

Table 4.4 ETABS Design Rules (3rd Floor Elephant and Castel – London)

Construction Site Block H10C

| Design | An Integrated Process | Advance Analysis |
|---|--|--|
| A basic grid system determined by horizontal slabs and vertical column lines | A fully integrated software | Static analyses |
| The commonality has been used dramatically to reduce design and analysis time | Finite element based dynamic analysis and linear static design | vertical uniform actions on the level are distributed to the slabs and columns through bending of the level sections |
| The input and output conventions used correspond to common building terminology | Concrete structure model unit (slabs and column) | 3D method forms and frequencies, modal participation elements, direction elements and engaging mass percentages are examined using eigenvector or ritz-vector value analysis |

4.3.1 Computational Analysis

The early stage of simulation analysis is illustrated in Figure 4.6, presents the grade line of structure, columns, floor slabs and hole’s boundaries.

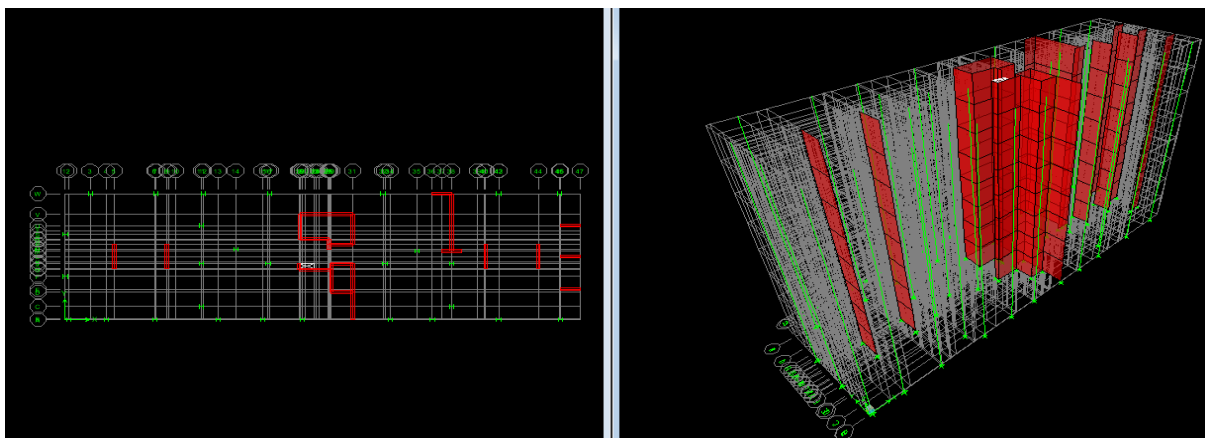

Figure 4.6 3D Grade Lines and Top View of Block (H10C)

Computational analysis of a ten floor block (H10C) simulated by ETABS illustrated in Figure 4.7 shows 3D of the block and top view, describing the floor slabs, columns and holes.

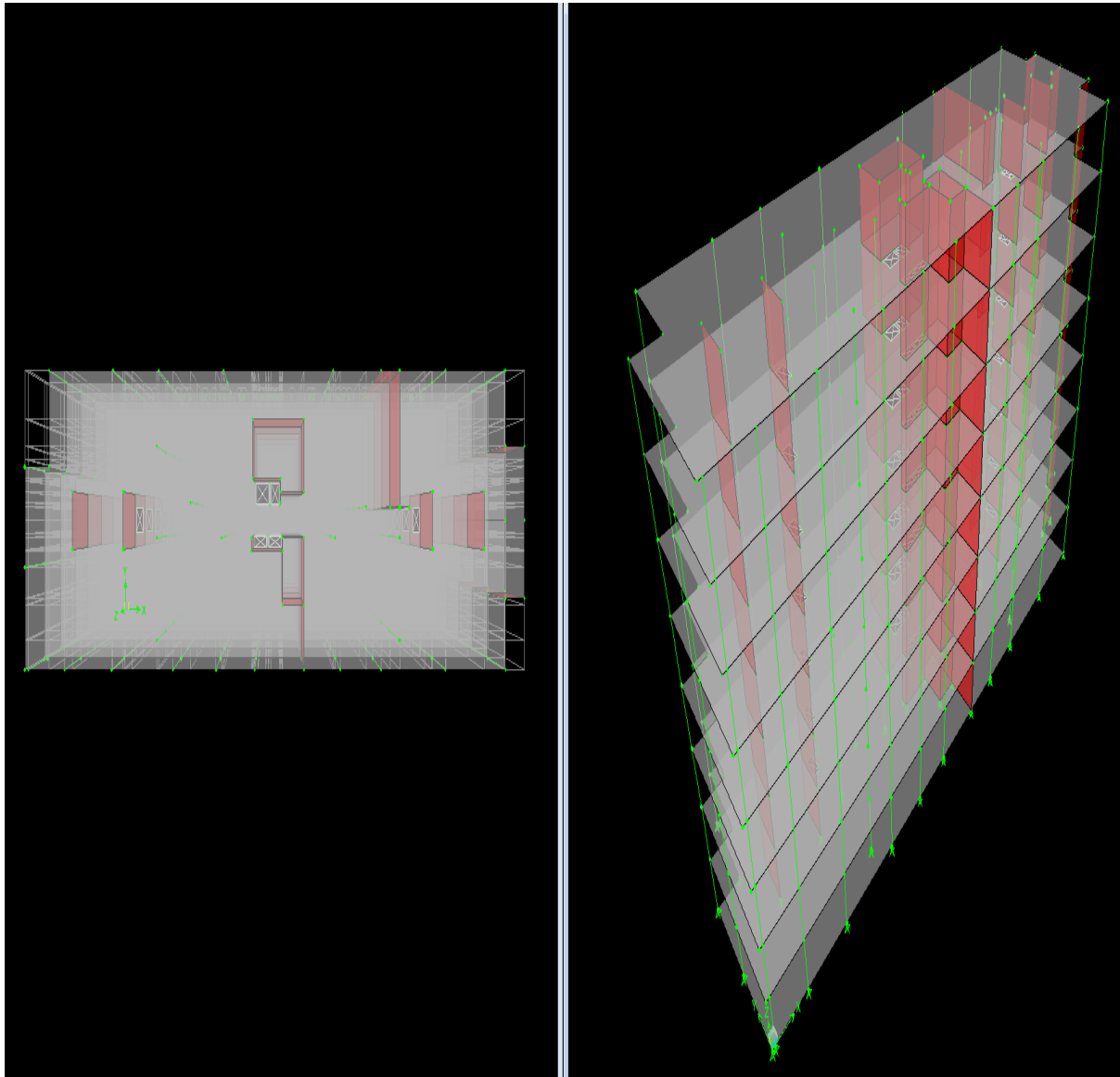

Figure 5.7 3D and Top View of Block (H10C)

The ETABS simulation analysis to determine deflection is illustrated in Figure 4.8, shows the deflection of approximately 2mm. 3 points have been selecting as an average long term deflection to compare with the Bentley and Precise Levelling deflection results.

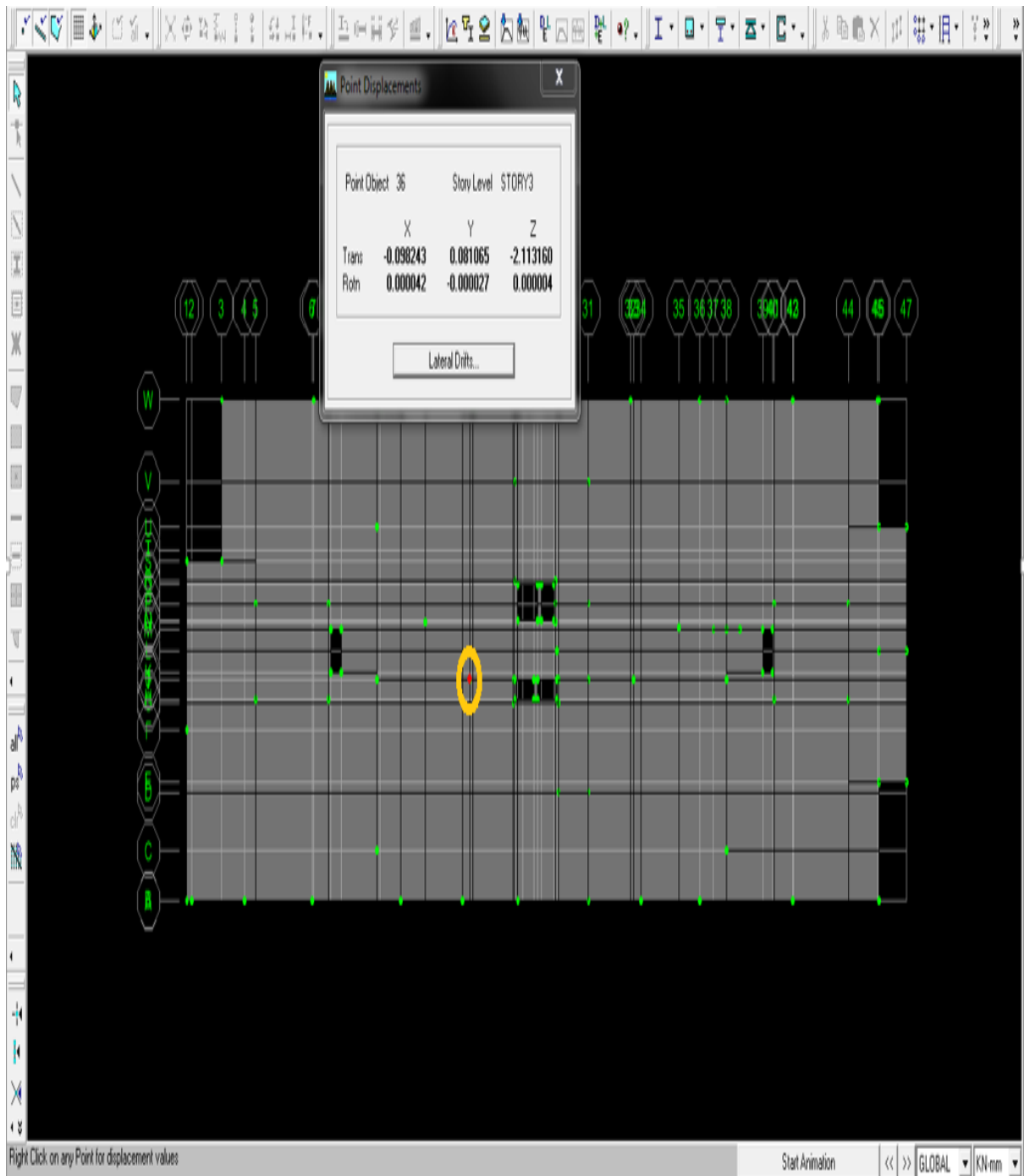

Figure 4.8 Point 36 on Third Floor Slab

Different spot on floor slab has been selected to determine deflection as illustrated in Figure 4.9, which shows the deflection of 1.25mm highlighted in red spot and yellow.

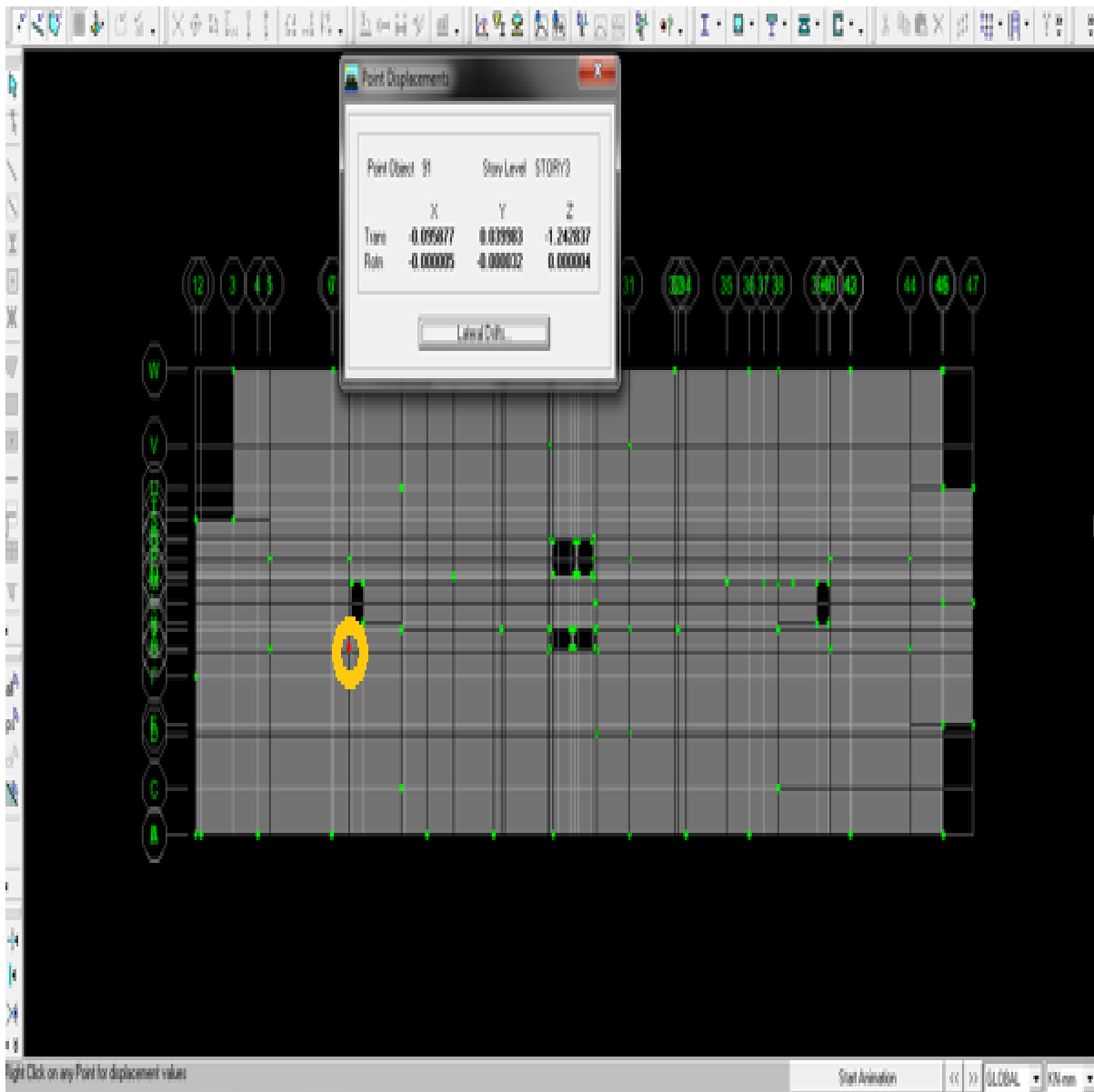

Figure 4.9 Point 91 on Third Floor Slab

More spots have been selected as illustrated in Figure 4.10, to define deflection in order to compare the deflection values determined by ETABS later with Bentley simulation analysis and site observation deflection values by using Hydrostatic Cell Levelling and Levelling methods carried out by author in previous research paper related to the same project in Elephant and Castle – London block H10C.

The deflection values in Figure 4.10, shows around 1.42mm.

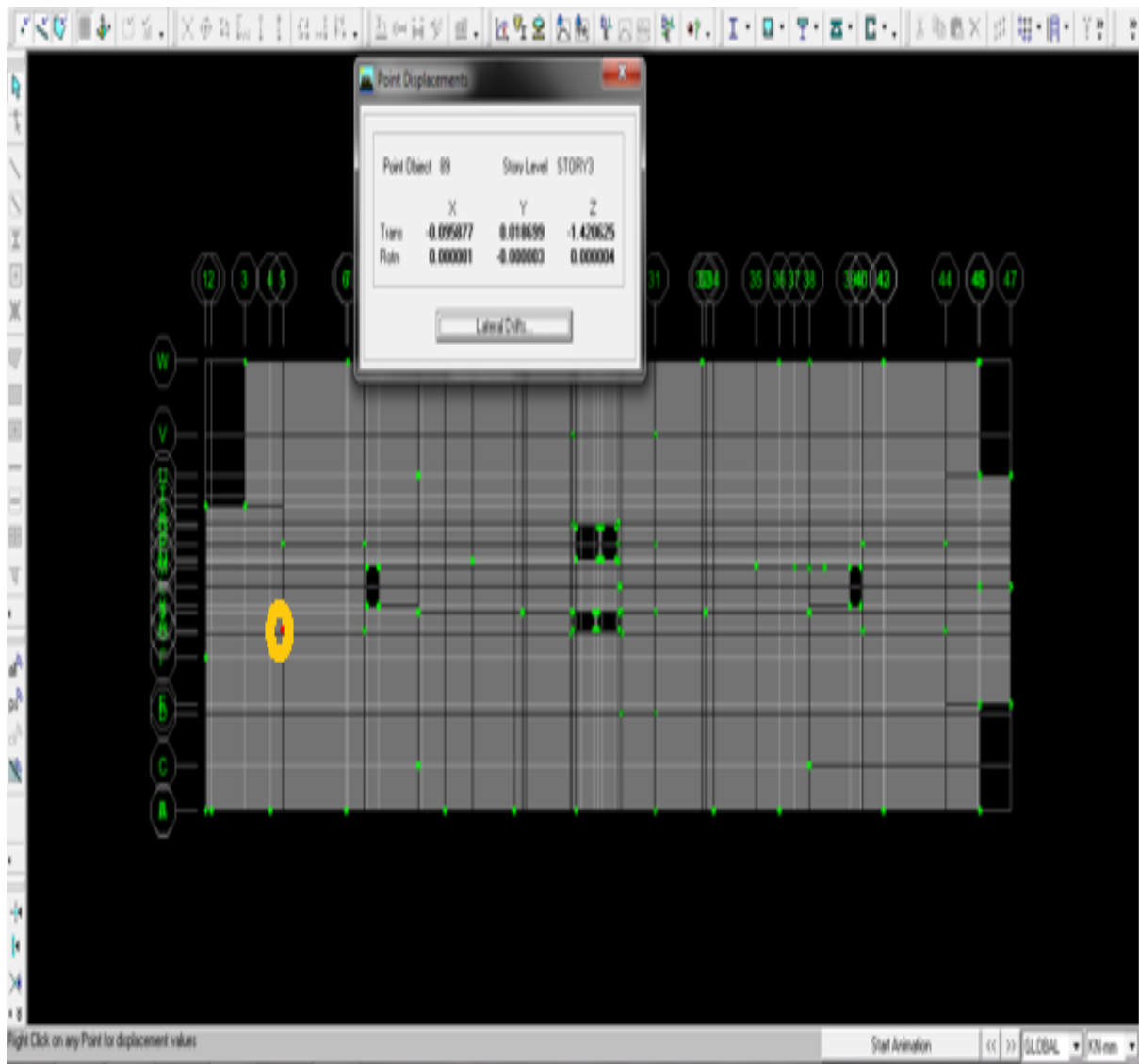

Figure 4.10 Point 89 on Third Floor Slab

4.4 Precise Levelling

Precise Levelling has been used to determine the deflection on construction site in Elephant and Castle-London block H10C in order to compare the Precise Levelling deflection results with the Bentley and ETABS results.

Levelling is the expression applied to any technique of measuring directly the difference in elevation between points.

Precise levelling is a technique of differential levelling which uses extremely accurate levels and with stringent methods of making observations than normal engineering levelling. It aims to obtain high levels of accuracy such as 1 mm per 1 km traverse.

A level surface is a surface which is perpendicular to the direction of the load of gravity. For normal levelling method, level surfaces at various elevations can be taken into account to be parallel. An arbitrary level surface to which elevations are referred to is called level datum. The common surveying datum is mean sea level (MSL). A given datum, which is proposed by assuming a benchmark value (e.g. 100.000 m) to which all levels in the region will be lowered.

A benchmark (BM) is the expression given to a specific, constant accessible spot of known height above a datum to which the height of other spots can be referred. It is normally a steel pin embedded in an essential concrete block cast into the floor. The positions of benchmarks shall be highlighted with BM marker paint and/or posts, and recorded on the station.

A set-up refers the location of a level at the time in which a number of readings are made without mooring the device. The first reading is made to the known spot and is termed a back sight; the last reading is to the last spot or the next to be defined on the run, and all other spots are intermediates.

A run is the observation among two or more spots observed in one direction only. The outward run is from known to unknown spots and the return run is the check observation in the opposite direction.

Figure 4.11 illustrates the actual deflection values obtained from the site observation using Precise Levelling which after 2 weeks of casting, shows 2mm of deflection as an average on selected bay highlighted in rectangular shape.

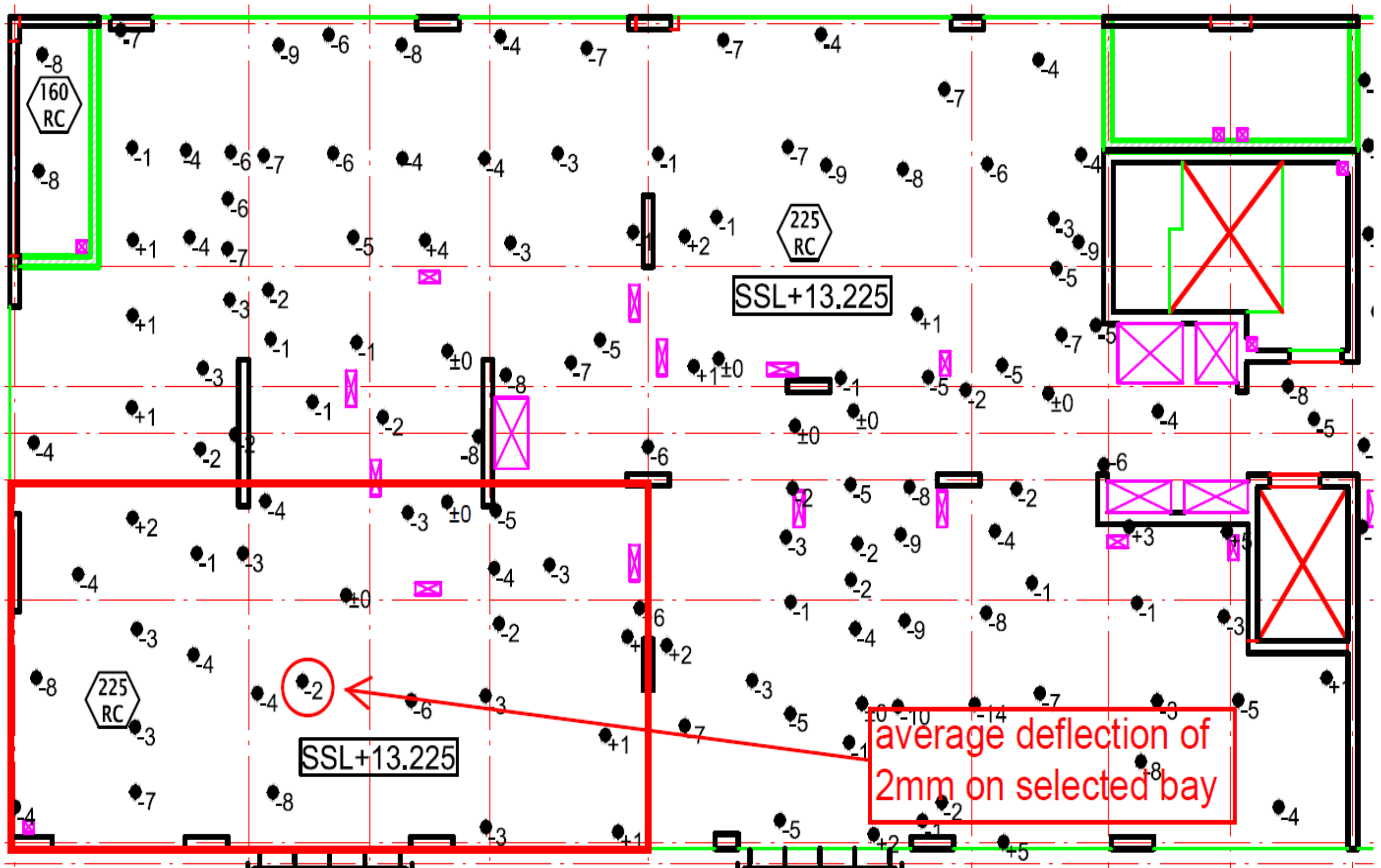

Figure 4.11 Precise Levelling Deflection of 2mm of on Selected B

4.5 Summary

Current design limits on deformation such as Eurocode 2 are based on limits set four decades ago in 1977. When the forms of construction, partitions, finishes, cladding, and services were very different to what they are now, therefore, the current limits are too conservative, and more research is thus needed to understand current performance in order to enable more sustainable and economic designs.

There has been limited recent academic research into deflection limits for concrete slabs and this emphasises how significant and important this study will be for understanding the behaviour of the deflection of concrete slabs.

One of key issues in designing the deflection using typical classic methods is the lack of a valid provision. The high costs involved in curing, casting and testing procedures of design elements. Addressing this problems need finding the inexpensive new effective tools for modelling of concrete slab behaviours such as deflection, crack width, etc. This involves the use of classical and /or modern models for prediction of slab deflection with assurance on structural behaviour and non-linear strain distribution.

Bentley and ETABS have been used to determine deflection on concrete slab according to Eurocode 2, while Precise Levelling has been used to verify and compare actual deflection results with Bentley and ETABS.

The simulation analysis results obtained from Bentley and ETABS and Precise Levelling results shows the very close correlation between them as deflection values around 2mm were recorded as an average on the third floor left bottom corner.

Precise levelling is a predominantly accurate technique of differential levelling which uses extremely accurate levels and with a further stringent observing execution than normal engineering levelling. It aims to obtain high levels of accuracy such as 1 mm per 1 km traverse.

CHAPTER FIVE: Evaluation of Column Shortening in mid-rise Concrete Structures

The phenomenon of concrete column shortening has been widely acknowledged since it first became apparent in the 1960s. Axial column shortening is due to the combined effect of elastic and inelastic deformations, shrinkage and creep.

This chapter aims to investigate the effects of ambient temperature, relative humidity, cement hardening speed and aggregate type on concrete column shortening. The investigation was conducted using a column shortening prediction model which is underpinned by the Eurocode 2.

Critical analysis and evaluation of the results showed that the concrete aggregate types used in the concrete have significant impact on column shortening. Generally, aggregates with higher moduli of elasticity hold the best results in terms of shortening. Cement type used is another significant factor, as using slow hardening cement gives better results compared to rapid hardening cement. This study also showed that environmental factors, namely, ambient temperature and relative humidity have less impact on column shortening.

5.1 Introduction

In high-rise concrete buildings, columns are subject to axial shortening due to the combined effect of elastic and inelastic deformations, shrinkage and creep (The Concrete Society 2008). This phenomenon, noticed for the first time in the 1960s takes place during the curing of freshly cast concrete as well as on a longer term basis throughout a building's life span (Moragaspitiya et al, 2010). Several factors affect column shortening: these include the concrete properties and amount of steel reinforcement, variations in Young's modulus of elasticity of the concrete,

environmental conditions and the ratios of cross-sectional area to length (Moragaspitiya, 2011).

Concrete is a heterogeneous material with mechanical and rheological properties that change with time. Creep and shrinkage have paramount importance in the design of concrete mid-rise and high-rise structures especially as the total shortening of a column comprises the sum of immediate axial deformations and the induced creep and shrinkage deformations (Pan, Liu and Bakoss, 1993).

Concrete as a material is one of the most widely used owing to its durability, ease of construction and low cost (Shaikh and Taweel 2015). Several shrinkage and creep prediction methods have been developed to estimate the time-dependent deformations of concrete structures such as axial and differential column shortening as the inaccurate prediction of these phenomena could lead to structural and non-structural failures especially with increasing building height (Moragaspitiya, 2010; Zou et al 2014). Therefore, it is vital that time-dependent deformations of vertical elements of hardened concrete structures are predicted and appropriate adjustments are made to the construction system used in high-rise buildings in order to cater for these deformations (Njomo and Ozay 2014). Creep and shrinkage are affected by numerous factors related to both the design and the construction of a concrete structure that make it difficult to get an in-depth understanding of the physical processes that cause creep and shrinkage of concrete elements (Aslani 2015). However, many studies have been carried out on the subject that have determined the main mechanisms that govern the rheological behaviour of cured concrete as well as the parameters that influence their magnitudes. Numerous models have been developed for the prediction of creep and shrinkage: some of them are regulatory such as the Eurocode 2 Model that is based on the CEB-FIP MC90 model, and the ACI-209 model developed by the

American Concrete Institute (Zou et al 2014). The precision and accuracy of these models however are low, especially for longer term behaviour (Bazant and Baweja 1995).

Differential axial shortening of columns induces additional stresses in horizontal structural members such as beams and slabs, and vertical non-structural members such as partition walls and glazing (Pan, Liu and Bakoss 1993). These induced additional stresses increase bending moments, shear forces and torsional moments, affecting thereby the corresponding diagrams used for the ultimate limit state design of the structure. Therefore, it is important that engineers can accurately quantify the shortening of columns in order to produce accurate structural designs for buildings susceptible to column shortening effect. Through the review of existing literature on differential column shortening in concrete structures, including creep and shrinkage deformations, no specific statements were evident on the exact impact that each of the factors affecting shrinkage and creep have on column shortening. The Concrete Centre has produced Excel (Microsoft 2016) spreadsheets underpinned by Eurocode 2, for the prediction of column shortening with the possibility of selecting ambient temperature, relative humidity, cement type and aggregate type. The aim of this study is to investigate and quantify the effect of these factors and parameters on column shortening (The Concrete Centre 2016).

5.2 Review of Column Shortening Developments

Shortening of concrete columns induce additional stresses and torsion in slabs and beams. This is due to the differential shortening of the columns, in other words, the columns supporting a beams and slab system do not shorten by the same amount as they might not be subject to the same stress levels (Fintel, et al., 1987). This can be easily pictured when comparing the vertical loads acting on internal columns to those

acting on perimeter columns. A perimeter column typically supports two beams when it is located in the corner of the building and three beams otherwise, whereas an internal column typically supports four beams. The loads on perimeter columns are thus generally lower than the loads on internal columns, hence the difference in elastic deformation of the columns. The differential aspect of column shortening is thus caused by the variations that are inherent to the structural design of a column, hence the need of considering this phenomenon during the design stage and also proffer means of reducing differential column shortening. Plain non-differential column shortening also have adverse effects on the cladding and heads of partitions where allowance for the axial shortening has not been provided for (The Concrete Centre 2014).

Figure 5.1 illustrates the torsional effects of differential column shortening impact on non-structural members such as partition walls and façade glazing.

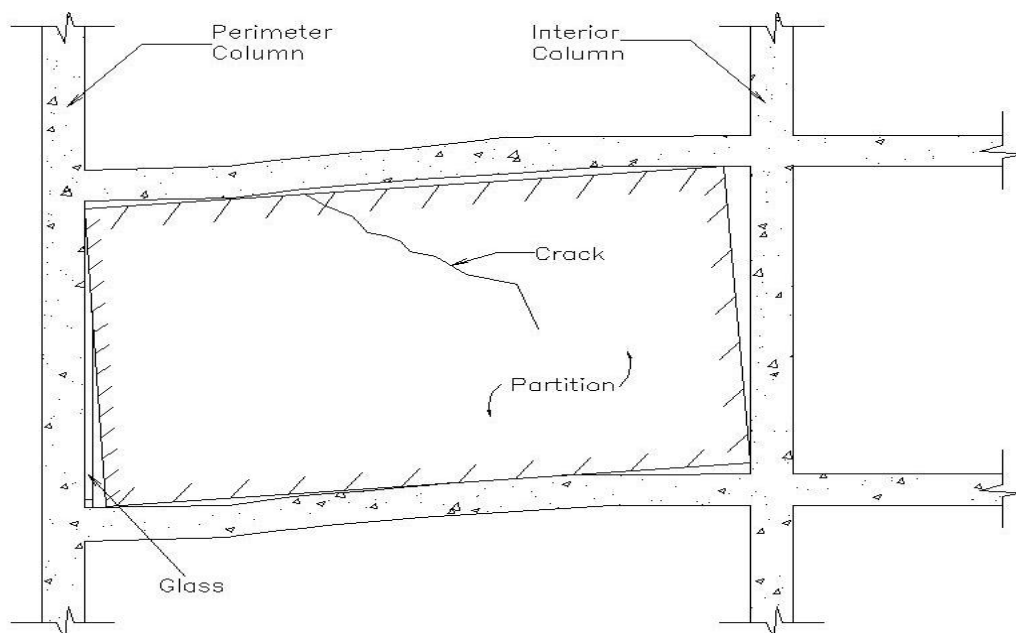

Figure 5.1 Torsional Effect of Differential Column Shortening (reproduced from SlideShare, 2016)

In order to predict and monitor axial shortening, engineers have used analytical procedures, laboratory tests and measurements on constructed buildings along with analytical procedures. However, by comparing analytical predictions with on-site observations, it has been found that the accurate prediction of this phenomenon is difficult to achieve and complex. This is due to the variability, complexity and to some extent, the unpredictability of the influencing factors (Baidya and Mendis, 2010).

The American Concrete Institute (ACI) Committee report 209 (2008) noted that regulatory models presented in European and American codes are based on past experience and they present a compromise between the precision of the results and the ease of use. Furthermore, the uncertainties of these models emanate from the fact that they consider a broad range of materials with different characteristics and from different countries in order to be applicable in all the regions where these codes are used (ACI Committee 209, 2008). Additionally, it has been shown that within the same batch of concrete, the shrinkage and creep of the specimens varied by up to 8%, justifying thereby the unpredictability of creep and shrinkage (Bazant, et al.1987). Also the development of models for the prediction of creep is difficult because the theory and processes describing it are not completely understood. According to Gardner (2004), it is not possible to predict creep and shrinkage with an accuracy of +/- 20%. The Creep and Shrinkage Committee from the ACI could not reach a consensus to determine which model allows the most precise and accurate prediction. The debate is partly on the type of data one should consider to develop the models, the types of parameters to be used in the model equations and on the appropriate statistical methods for the comparison of the models (ACI Committee 209 2008).

According to Moragaspiya (2011), shear cores and columns under axial compression are the main structural members for axial shortening control. The design of these

elements is thus the stage at which the issue of column shortening should be considered. Some of the methods that could be used to reduce the shortening of the columns include improvement of the mechanical properties of the materials and structural members, the use of rigid joints to connect columns and horizontal members, outriggers and the increase of reinforcement in the columns (Hansoo and Seunghak, 2014). However, the shortening of columns is usually investigated once the design of the structural elements is complete, making it laborious to address by structural element design alterations, that is, changing the column sections and material properties. Nonetheless, the reinforcement bars can be increased in order to stiffen the column and reduce its shortening (Hansoo and Seunghak, 2014).

Patel and Poojara (2014), carried-out a construction stage analysis using the Extended Three Dimensional Analysis of Building Systems (ETABS) software computer and structures, Inc. (2012), to show that the cross-sectional area of columns had a direct impact on the differential shortening of the columns. The study demonstrated that the larger columns exhibits lower axial and differential shortenings (Patel and Poojara, 2014). The study additionally found that when the construction pace is high, the shortening of the columns is substantial for both tall and short buildings; nevertheless, when the construction rate is low, short buildings are not concerned with column shortening.

Acker (2003), found that creep strains in concrete result only from the visco-plastic behaviour of cement hydrates C-S-H; viscous deformations outweighing by far the elastic deformation, and this deformation is completely reversible. This finding is the result of creep tests and indentation at the nanoscale on a high-performance fibre reinforced concrete. A comparative study of the basic creep behaviour was made between different types of concrete. These included ordinary concrete, high and ultra-

high performance concrete and fibre concrete. The outcome showed the differences between the basic creep values of different concretes. The study concludes that these differences can be explained by a profound change in the internal structure of the hydrates C-S-H. To explain this change, there are two theories. The first is the "exhausted collapse site" created by shrinkage. Whereas, the second is linked to a coupling between capillary pressure and the mechanical stress or, in how these stresses are superimposed locally at the hydrate layer or, in the process of stress concentration and capillary pressure that occurs in dry granular stacks (Acker, 2003).

Hansoo and Seunghak, (2014), worked on the reduction of differential column shortening in tall buildings. They showed that increasing the reinforcement in the columns results in decreased differential shortening. Their study was carried out by modelling an 80 storey building with beam spans of 8m and by taking the beam stiffness as zero. Their results demonstrated that an increase of 4% in the steel ratios of the columns lead to a column shortening reduction of 51.7% and that for a 1% increase in reinforcement the column shortening was reduced by 15.9%. However, the work also showed that the effect of increasing the steel ratio on the shortening of the columns is not linear and that this effect decreases with higher steel ratios.

Choi, et al., (2012) and Kamath et al., (2015) investigated a different approach for reducing differential column shortening in tall buildings with the use of outriggers. Outriggers are used to connect core walls to peripheral columns as illustrated in Figure 6.2. The use of these rigid horizontal structural members increases the stiffness of the structure thereby reducing its overturning ability (Choi, et al., 2012). Both studies found that optimal use of outriggers can significantly reduce differential axial shortening of concrete columns. Moreover, Kamath et al., (2015), results showed that the differential shortening was decreased by 34% when an outrigger system was used at a level

58.3% of the height of the building. Higher overall height to outrigger position height ratios produced an increase of the differential shortening. Additionally, using the same model while keeping the outrigger fixed at its optimum position of 58.3% of the overall height and by adding another outrigger system at an optimum position of 75% of the structure's height, the differential shortening was reduced by a total of 58% (Kamath, et al. 2015).

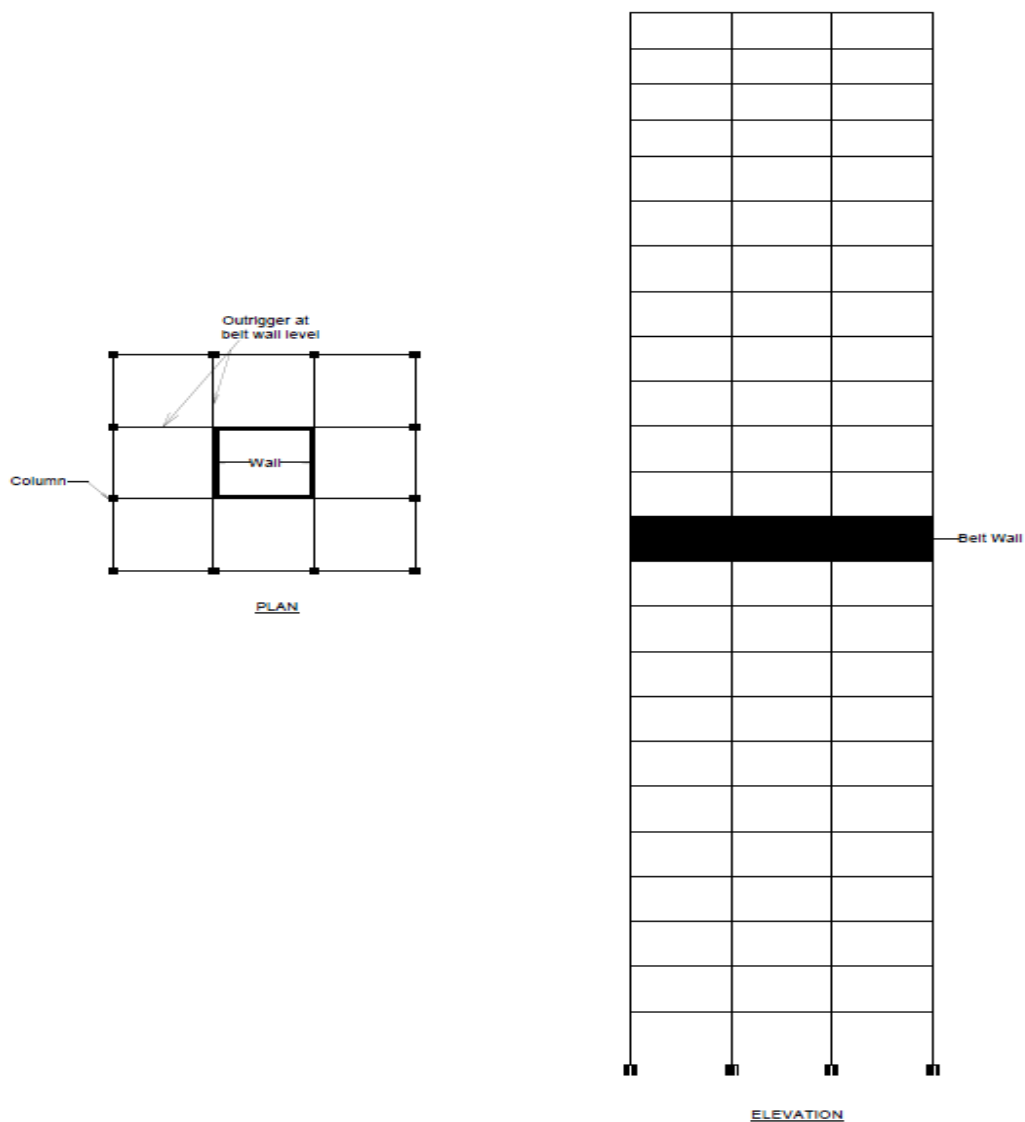

Figure 5.2 Outrigger System

5.3 Column Shortening Prediction

For the purposes of this study, the behaviour of a 12-storey and a 24-storey building structure was simulated using the TCC55 and TCC55X Excel (Microsoft 2016) spreadsheets produced by The Concrete Centre (The Concrete Centre 2016), for the prediction of column shortening. These Concrete Centre spreadsheets calculate both the short-term and long-term shortenings of columns based on Eurocode 2. The short-term shortening is referred to as 'Shortenings between Floors' and represents the amount by which a column lift shortens in length when the next floor is constructed on top of it. Whereas, the long-term shortening is referred to as 'Floor Displacements' and represents the net displacement of the floor from the level at which it was erected (The Concrete Centre, 2016).

5.3.1 Column Shortening

The column shortening effect can be determined by considering the variation of possible parameter combinations. The parameters are: (i) ambient temperature, (ii) relative humidity, (iii) cement hardening speed and (iv) types of aggregate used. The considered ambient temperatures are 5°, 20° and 30° Celsius along with relative humidity (RH) of 50%, 60%, 70% and 80%. Additionally, Slow-, Normal-, or Rapid hardening (S, N or R) cement classes based on Eurocode 2 classification are considered along with four aggregate mineralogy types, namely: Basalt, Limestone, Quartzite and Sandstone. The total number of possible combinations is 288 for each of the two structures, that is, 12-storeys and 24-storeys, totalling 576 combinations.

5.3.2 12-Storey Building Description

The TCC55 Excel spreadsheets produced by the Concrete Centre allows for the calculation of the shortening of the columns for structures up to 12-storey (45.75m

total height) in terms of creep and shrinkage strains in accordance with BS EN 1992-1-1 Clauses 3.1.3(1), 3.1.3. (3) and Annex B.

For this study, the dimensions of the columns, the concrete strength, the area of steel reinforcement, as well as the loading sequence for the 12-storeys are shown in Table 5.1; Figure 5.3 shows the structure's frame.

Table 5.1 Geometry and Loading Sequence of the 12-Storey Building

| Level | Time gap days | f_{ck} N/mm ² | Column below | | | | Col SW kN | Floor SW kN | At age days | Balance of Gk kN | Age days | Per m imposed Q_k kN | Age days |
|-------|---------------|-------------------------------|--------------|--------|--------|-----------------------------|--------------|----------------|-------------|---------------------|----------|---------------------------|----------|
| | | | Length mm | H m | B m | A_{sL} mm ² | | | | | | | |
| Roof | 14 | 40 | 3750 | 300 | 300 | 452 | 8.4 | 354.4 | 7 | 118.1 | 28 | 44.3 | 82 |
| 11 | 14 | 40 | 3750 | 300 | 300 | 1257 | 8.4 | 354.4 | 7 | 118.1 | 28 | 62.0 | 96 |
| 10 | 14 | 40 | 3750 | 400 | 400 | 1257 | 15.0 | 354.4 | 7 | 118.1 | 28 | 62.0 | 110 |
| 9 | 14 | 40 | 3750 | 450 | 450 | 1257 | 19.0 | 354.4 | 7 | 118.1 | 28 | 62.0 | 124 |
| 8 | 14 | 40 | 3750 | 450 | 450 | 1963 | 19.0 | 354.4 | 7 | 118.1 | 28 | 62.0 | 138 |
| 7 | 14 | 60 | 3750 | 450 | 450 | 1257 | 19.0 | 354.4 | 7 | 118.1 | 28 | 62.0 | 152 |
| 6 | 14 | 60 | 3750 | 450 | 450 | 2592 | 19.0 | 354.4 | 7 | 118.1 | 28 | 62.0 | 166 |
| 5 | 14 | 60 | 3750 | 500 | 500 | 3217 | 23.4 | 354.4 | 7 | 118.1 | 28 | 62.0 | 180 |
| 4 | 14 | 60 | 3750 | 500 | 500 | 3217 | 23.4 | 354.4 | 7 | 118.1 | 28 | 62.0 | 194 |
| 3 | 14 | 80 | 3750 | 500 | 500 | 3217 | 23.4 | 354.4 | 7 | 118.1 | 28 | 62.0 | 208 |
| 2 | 14 | 80 | 3750 | 500 | 500 | 3217 | 23.4 | 354.4 | 7 | 118.1 | 28 | 62.0 | 222 |
| 1 | 14 | 80 | 4500 | 500 | 500 | 4825 | 28.1 | 354.4 | 7 | 118.1 | 28 | 62.0 | 236 |

Where: f_{ck} = Characteristics cylinder strength of concrete; H = Column depth ; B = Breadth of column; A_{sL} = Area of steel; SW = Selfweight; G_k = Characteristics value of permanent action and Q_k = Characteristics value of variable action

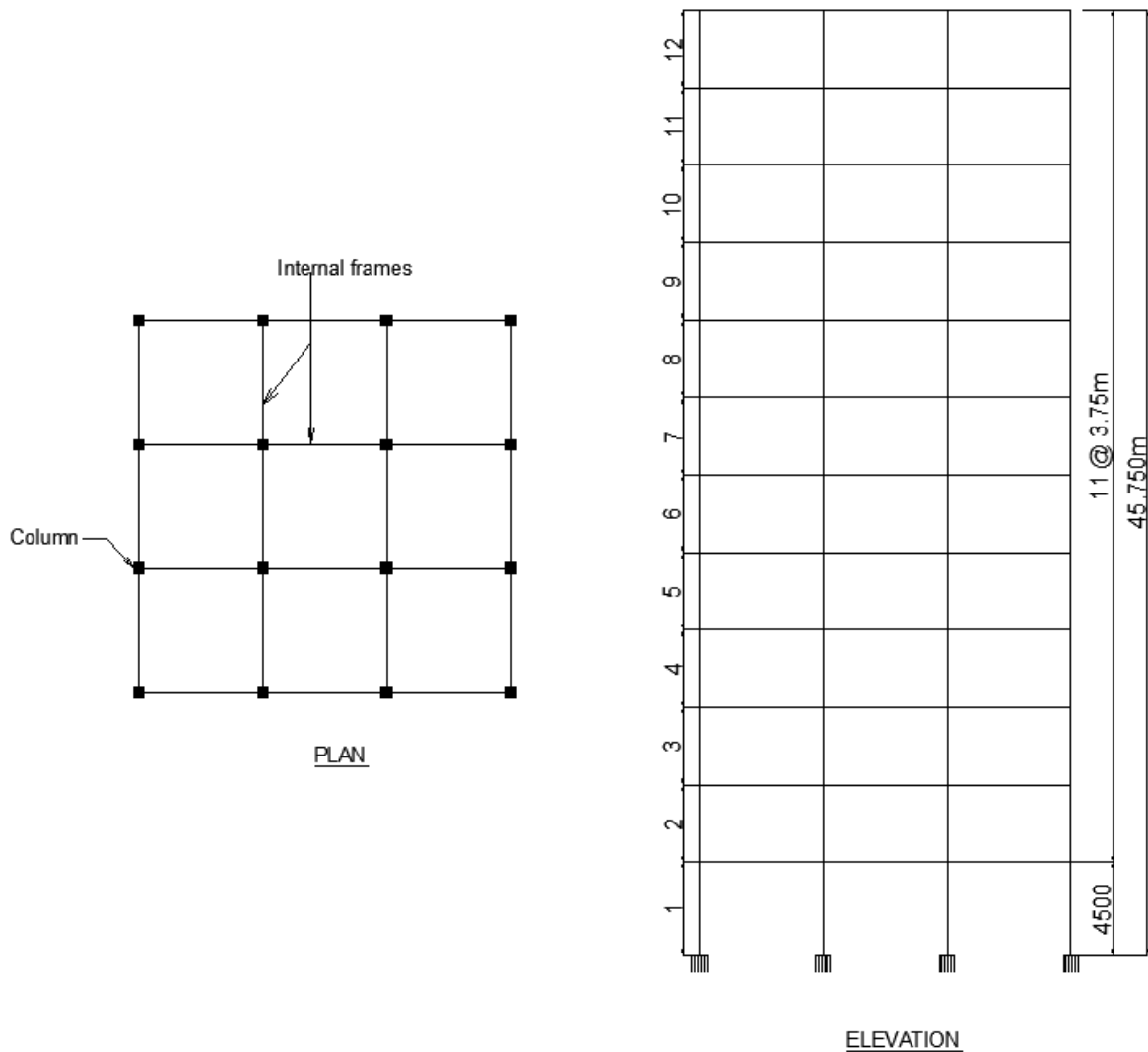

Figure 6.3 12-Storey Building Frame

5.3.3 24-Storey Building Description

The Concrete Centre TCC55X Excel spreadsheet calculates the shortening of the columns for structures up to 24-storeys. The dimensions of the columns, the concrete strength, the area of steel reinforcement used and the loading sequence for the 24-storey structure (87.75m total height) used in this study are shown in Table 5.2; Figure 5.4 shows the structure's frame.

Table 5.2 Geometry and Loading Sequence of the 24-Storey Building

| Level | Time gap days | Column below | | | | | Col SW kN | Floor SW kN | At age days | Balance of Gk kN | Age days | Perm Imposed Q_k kN | Age days |
|-------|---------------|----------------------------|-----------|------|------|--------------------------|-----------|-------------|-------------|------------------|----------|-----------------------|----------|
| | | f_{ck} N/mm ² | Length mm | H mm | B mm | A_{sL} mm ² | | | | | | | |
| Roof | 14 | 40 | 3000 | 300 | 300 | 3619 | 6.8 | 300.6 | 7 | 93.8 | 28 | 14.4 | 133 |
| 23 | 14 | 40 | 3000 | 300 | 300 | 3619 | 6.8 | 300.6 | 7 | 93.795 | 28 | 14.4 | 147 |
| 22 | 14 | 40 | 3000 | 300 | 300 | 3619 | 6.8 | 300.6 | 7 | 93.795 | 28 | 14.4 | 161 |
| 21 | 14 | 40 | 3000 | 300 | 300 | 3619 | 6.8 | 300.6 | 7 | 93.795 | 28 | 14.4 | 175 |
| 20 | 14 | 40 | 3750 | 300 | 300 | 3619 | 8.4 | 601.3 | 7 | 187.59 | 28 | 28.9 | 154 |
| 19 | 14 | 40 | 3750 | 300 | 300 | 3619 | 8.4 | 601.3 | 7 | 187.59 | 28 | 28.9 | 168 |
| 18 | 14 | 40 | 3750 | 300 | 300 | 3619 | 8.4 | 601.3 | 7 | 187.59 | 28 | 28.9 | 182 |
| 17 | 14 | 40 | 3750 | 300 | 300 | 3619 | 8.4 | 601.3 | 7 | 187.59 | 28 | 28.9 | 196 |
| 16 | 14 | 40 | 3750 | 300 | 300 | 3619 | 8.4 | 601.3 | 7 | 187.59 | 28 | 28.9 | 210 |
| 15 | 14 | 40 | 3750 | 300 | 300 | 3619 | 8.4 | 601.3 | 7 | 187.59 | 28 | 28.9 | 224 |
| 14 | 14 | 40 | 3750 | 300 | 300 | 3619 | 8.4 | 601.3 | 7 | 187.59 | 28 | 28.9 | 238 |
| 13 | 14 | 40 | 3750 | 300 | 300 | 3619 | 8.4 | 601.3 | 7 | 187.59 | 28 | 28.9 | 252 |
| 12 | 14 | 40 | 3750 | 300 | 300 | 3619 | 8.4 | 601.3 | 7 | 187.59 | 28 | 28.9 | 266 |
| 11 | 14 | 40 | 3750 | 300 | 300 | 3619 | 8.4 | 601.3 | 7 | 187.59 | 28 | 28.9 | 280 |
| 10 | 14 | 48 | 3750 | 300 | 300 | 3619 | 8.4 | 601.3 | 7 | 187.59 | 28 | 28.9 | 91 |
| 9 | 14 | 48 | 3750 | 300 | 300 | 3619 | 8.4 | 601.3 | 7 | 187.59 | 28 | 28.9 | 105 |
| 8 | 14 | 48 | 3750 | 300 | 300 | 3619 | 8.4 | 601.3 | 7 | 187.59 | 28 | 28.9 | 119 |
| 7 | 14 | 48 | 3750 | 300 | 300 | 6283 | 8.4 | 601.3 | 7 | 187.59 | 28 | 28.9 | 133 |
| 6 | 14 | 48 | 3750 | 300 | 300 | 9817 | 8.4 | 601.3 | 7 | 187.59 | 28 | 28.9 | 147 |
| 5 | 14 | 48 | 3750 | 300 | 300 | 16085 | 8.4 | 601.3 | 7 | 187.59 | 28 | 28.9 | 161 |
| 4 | 14 | 48 | 3750 | 300 | 300 | 16085 | 8.4 | 601.3 | 7 | 187.59 | 28 | 28.9 | 175 |
| 3 | 14 | 48 | 3750 | 300 | 300 | 19302 | 8.4 | 601.3 | 7 | 187.59 | 28 | 28.9 | 189 |
| 2 | 14 | 48 | 3750 | 300 | 300 | 24127 | 8.4 | 601.3 | 7 | 187.59 | 28 | 28.9 | 203 |
| 1 | 14 | 48 | 4500 | 500 | 500 | 27344 | 28.1 | 601.3 | 7 | 187.59 | 28 | 28.9 | 217 |

* See Table 5.1 for symbols Notation

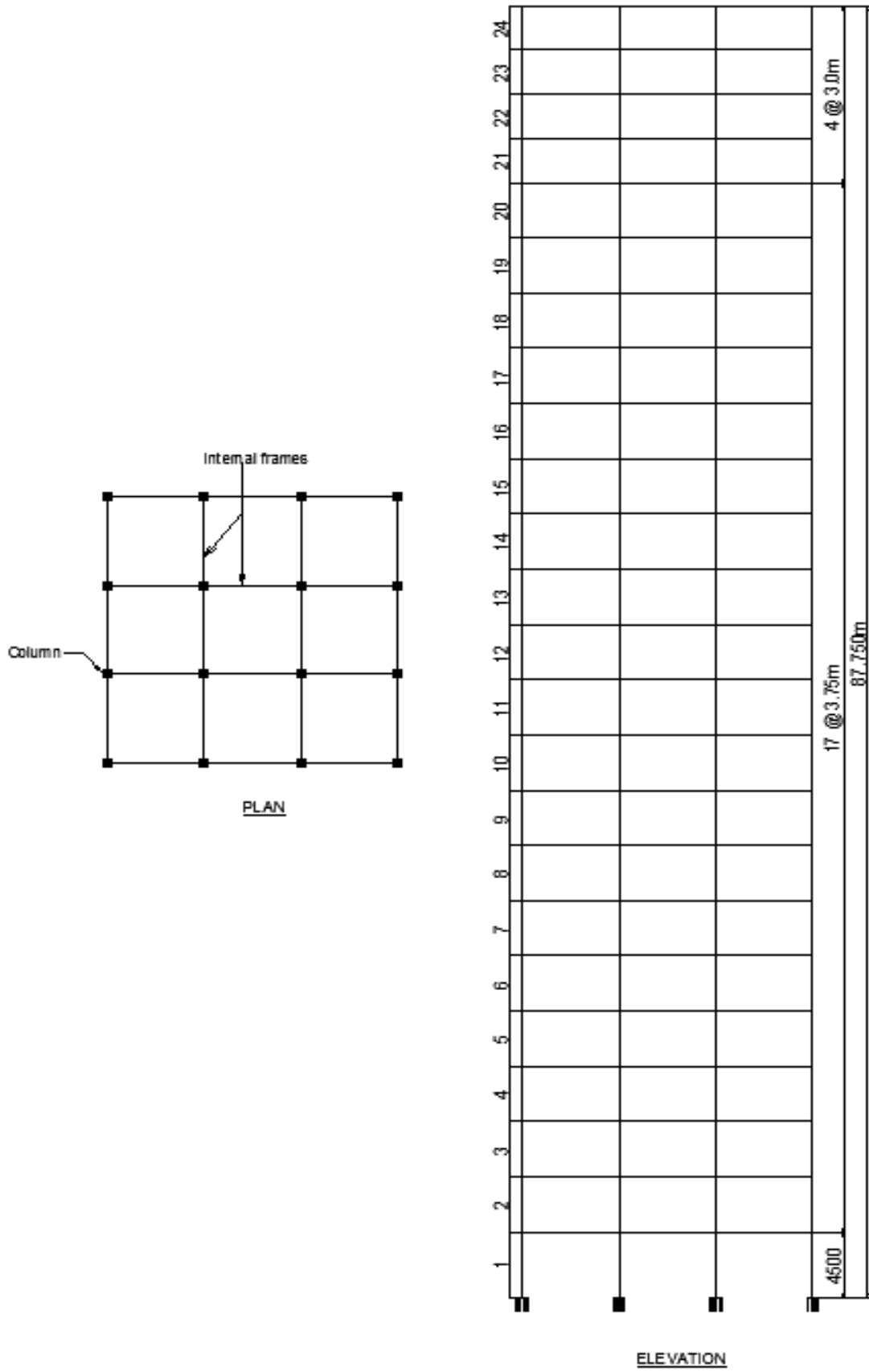

Figure 5.4 24-Storey Building Frame

5.4 TCC55 and TCC55X Results and Discussion

5.4.1 Investigation of the Effects of Environmental Factors on Column Shortening, Ambient Temperature

It has been observed during the simulations that higher ambient temperatures resulted in lower shortenings of the columns. For instance, in the 12-storey building with an ambient temperature of 5° C, 50% relative humidity, N class cement, and Basalt used as aggregate, the total net shortening that would occur at roof level is 28.6 mm as shown in Figure 6.5, whereas whilst keeping the same conditions but raising the ambient temperature to 30° C, the total shortening at roof level decreases to 26.1 mm. However, the maximum values for total net shortening are reached at the 11th Floor with a total of 29.6 mm at 5° C and 27.1 mm at 30° C.

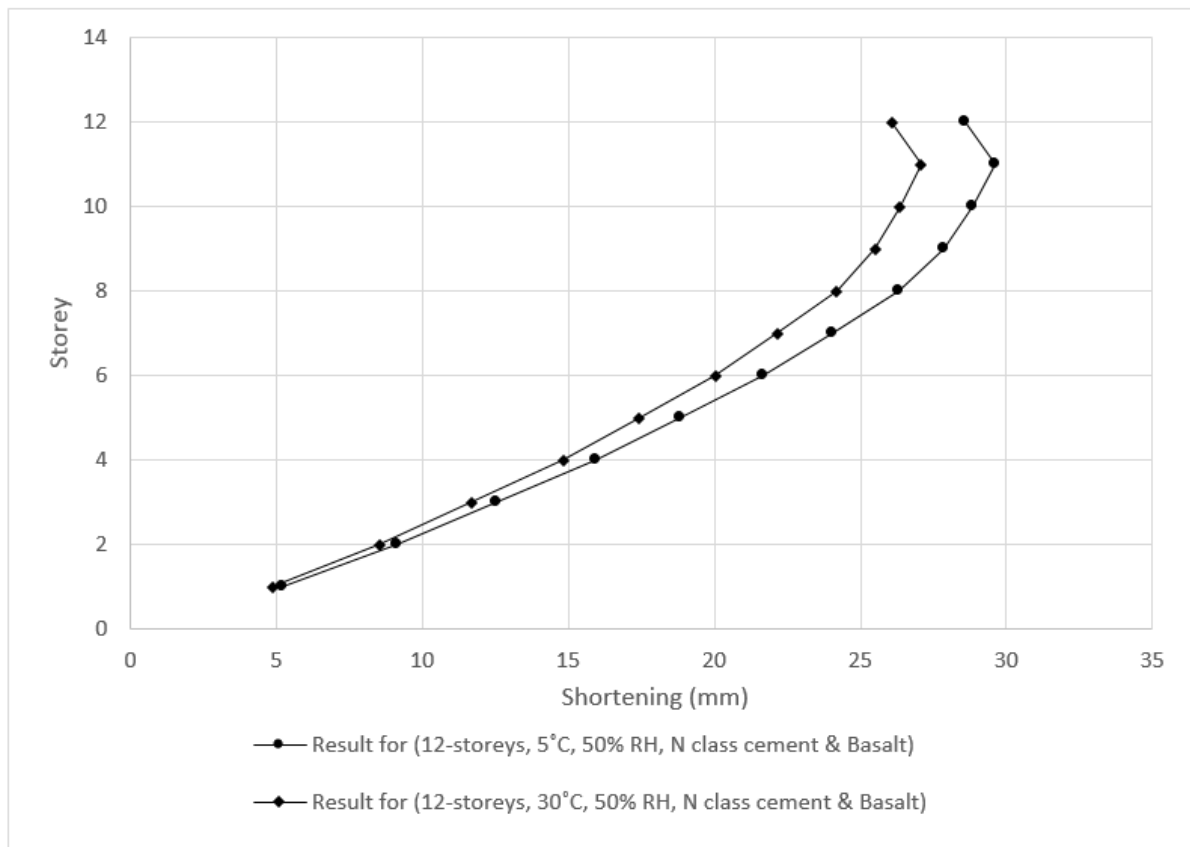

Figure 5.5 Ambient Temperature Simulation Results for 12-Storey Building Structure, Rotimi et al (in press), See Table 5.1

Figure 5.6 shows that a similar trend is also observed in the case of the 24 storey building; where a total net shortening of 66.7 mm is predicted at the 24th floor level with 5° C ambient temperature, 50% relative humidity, N class cement and Basalt used as aggregate. A total shortening of 60.7 mm is obtained at the 24th floor level with identical conditions but with 30° C ambient temperature.

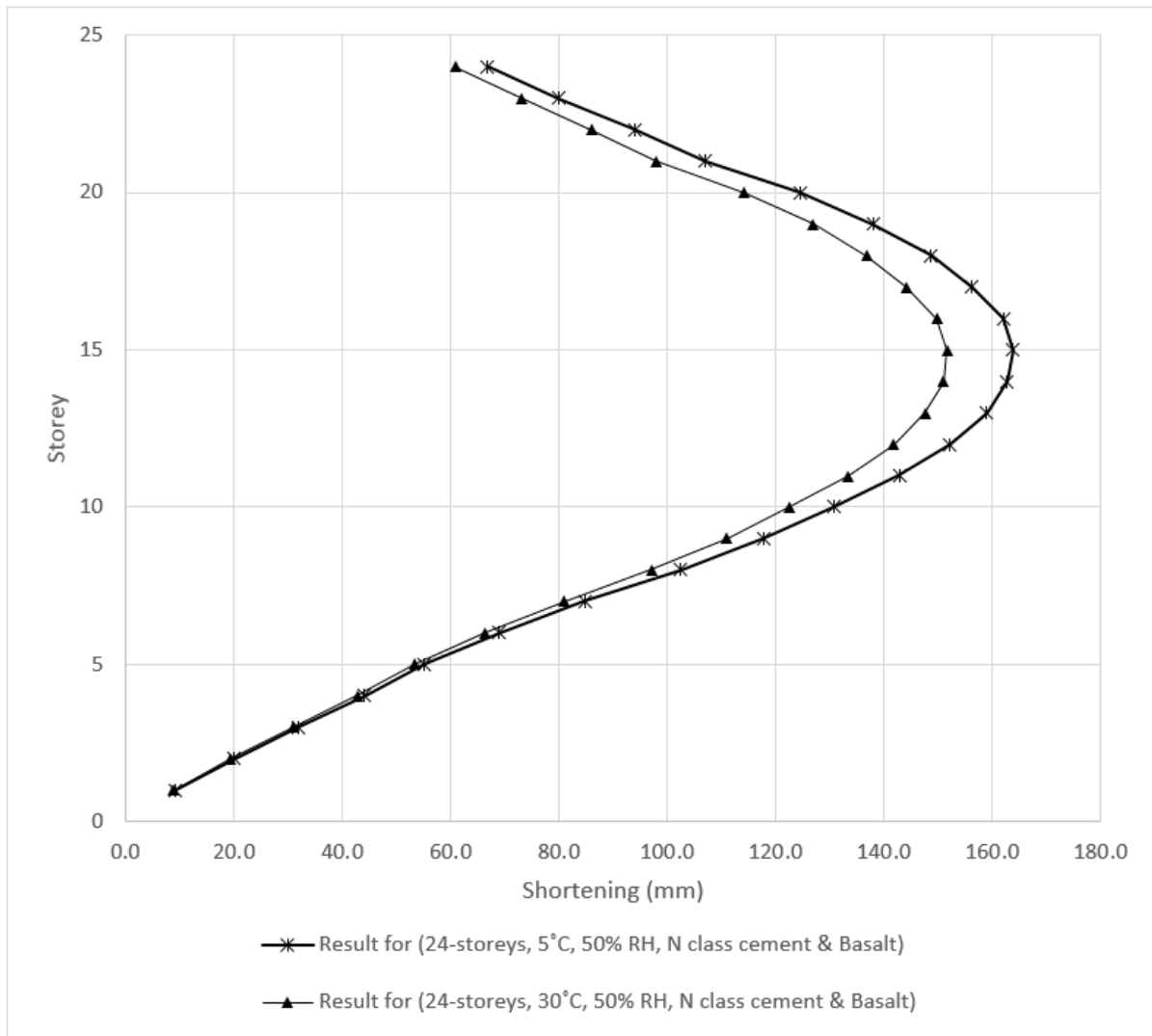

Figure 5.6 Ambient Temperature Simulation Results for 24-Storey Building Structure, Rotimi et al (2017), See Table 5.2

Table 5.3 Results Summary for the Effect of Ambient Temperature on Column Shortening

| 50% RH, N Type Cement, Basalt aggregate | 5° C | 30° C | Δ [mm] | Δ [%] | Δ/ 1° C |
|---|-------|-------|--------|-------|---------|
| Shortening at 11th Floor for 12-Storey | 29.6 | 27.1 | 2.5 | 9 | 0.10 |
| Shortening at 15th Floor for 24-Storey | 163.8 | 151.6 | 12.2 | 7 | 0.49 |

Δ= Difference in shortening

As shown in Table 7.3, there is an increase of 0.10 mm in total net column shortening for each 1°C ambient temperature drop for the 12-storey building and an increase of 0.49 mm for each 1° C ambient temperature drop for the 24-storey building.

5.4.2 Investigation of the Effects of Environmental Factors on Column Shortening, Relative Humidity

The Concrete Centre considers a relative humidity of 50% as ‘Internal Exposure’ and a relative humidity of 80% as ‘External Exposure’ (The Concrete Centre, 2016). However, relative humidity should be considered as the proportion of water vapour that the air can hold at a given temperature (The Concrete Countertop Institute, 2016).

The simulation results show that the higher the relative humidity the lower the shortening. This can probably be attributed to the fact that less water is lost by the concrete at higher relative humidity, thereby resulting in lower plastic shrinkage effect. As shown in Figure 6.7, in the case of the 12-storey building, with an ambient temperature of 20° C, 50% relative humidity, N class cement, and Basalt used as aggregate, the maximum total net shortening that was obtained at the 11th floor level was 28.0 mm whereas, a maximum total net shortening of 22.3 mm was obtained with 80% relative humidity.

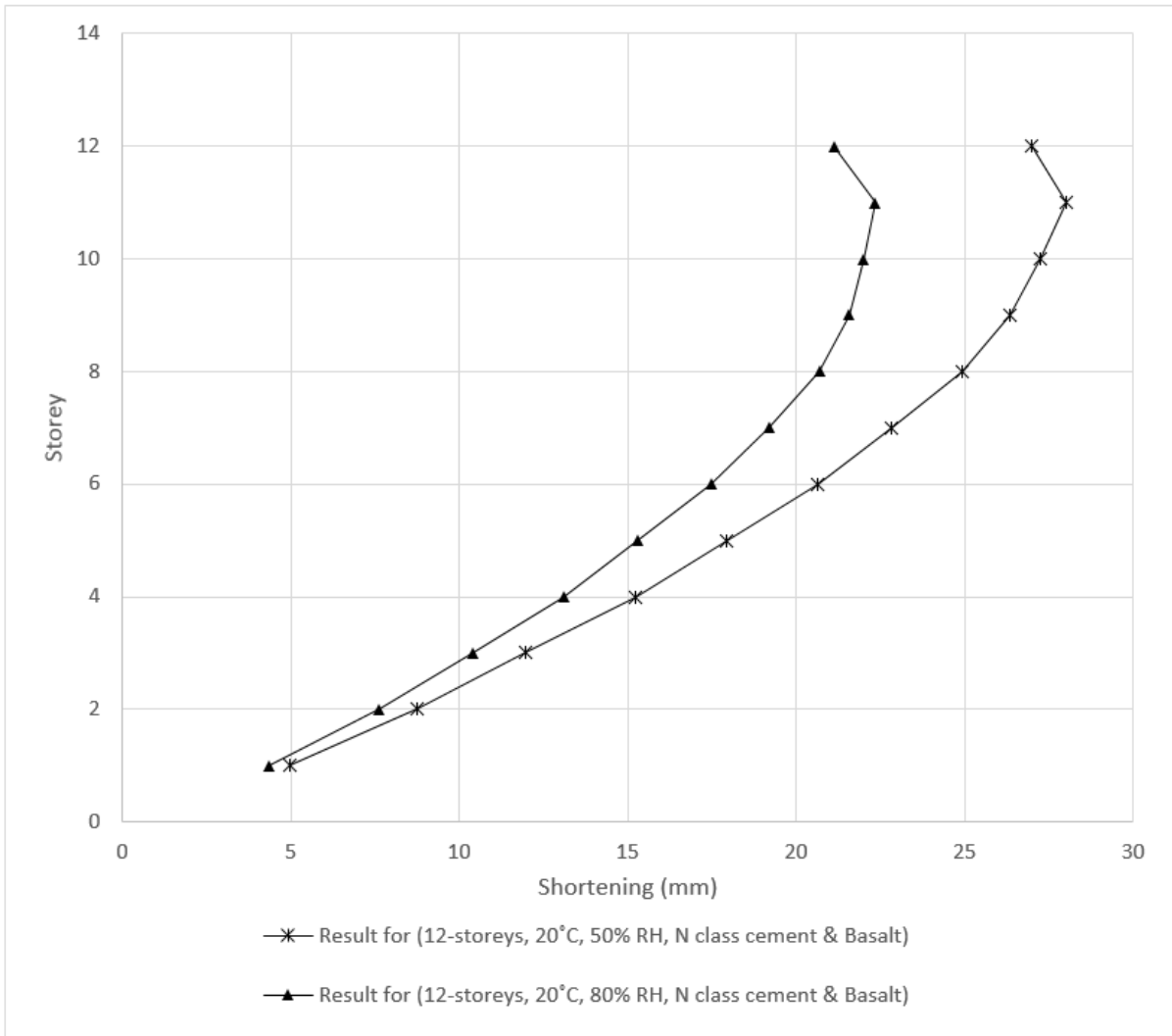

Figure 5.7 Relative Humidity Simulation Result for 12-Storey Building Structure, Rotimi et al (2017), See Table 6.1

In the 24-storey building a maximum total net shortening of 156.1 mm was obtained at the 15th floor level with 50% relative humidity. Whereas with 80% relative humidity the maximum total net shortening at the 15th floor was 140.1 mm. The results show a 10% reduction in net maximum shortening when relative humidity is increased from 50% to 80%. Figure 5.8 illustrates relative humidity results for the 24-storey building structure.

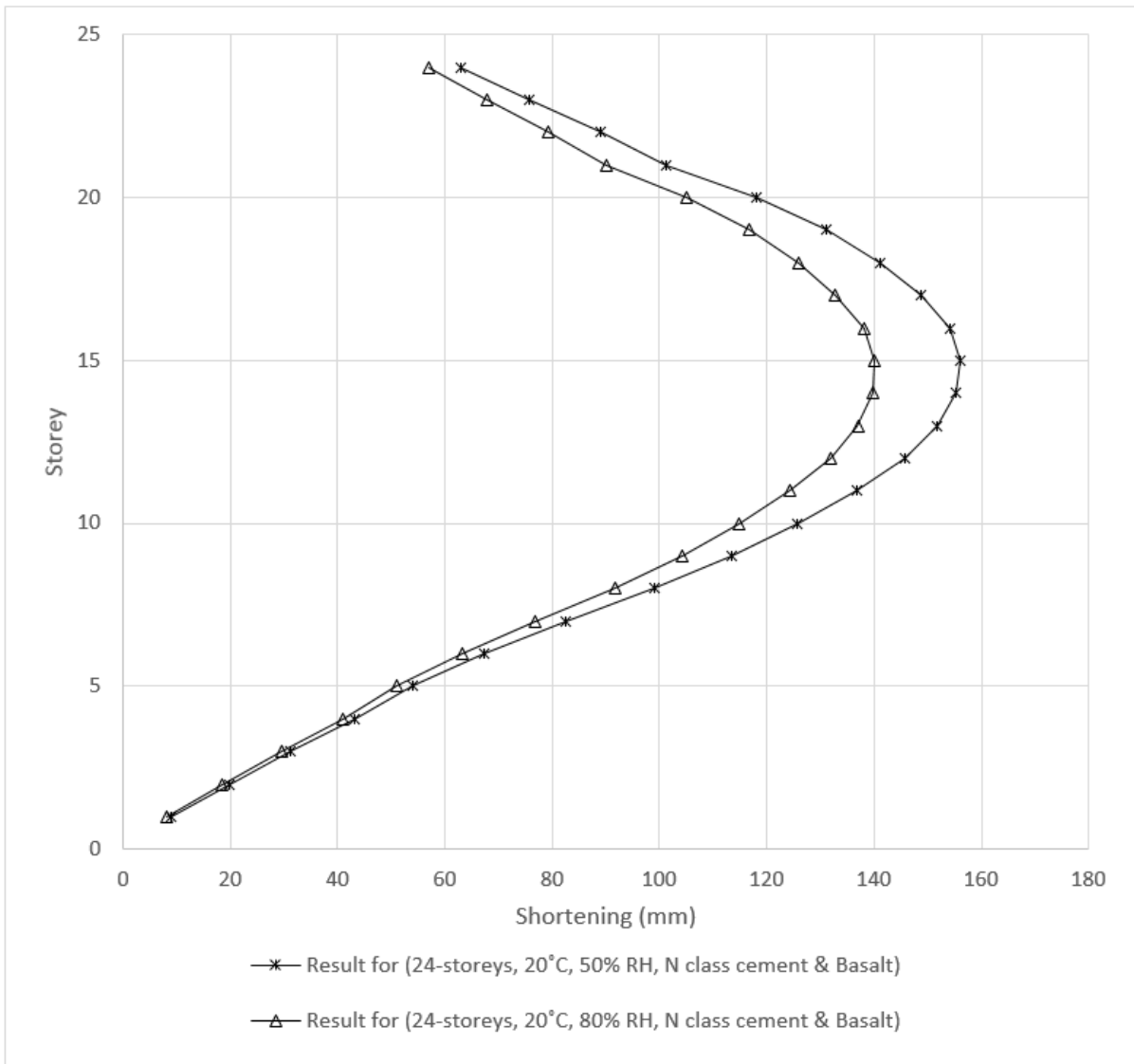

Figure 5.8 Relative Humidity Simulation Results for 24-Storey Building Structure, Rotimi et al (2017), See Table 6.2

Generally, the higher the relative humidity, the less water can evaporate from the freshly cast concrete, this results in a slower concrete curing rate that consequently produces a higher compressive strength concrete. As creep and shrinkage related strains are directly related to the concrete compressive strength, it is expected that creep and shrinkage deformations increase with decreasing compressive strengths and vice versa.

Table 5.4 Results Summary for the Effect of Relative Humidity on Column Shortening

| 20° C, N aggregate | Type Cement, Basalt | 50% RH | 80% RH | Δ [mm] | Δ [%] |
|--|------------------------|-----------|--------|---------------|--------------|
| Shortening at 11th Floor for 12-Storey | | 28.0 | 22 | 6.0 | 20 |
| Shortening at 15th Floor for 24-Storey | | 156.1 | 140.1 | 16.0 | 10 |

From Table 5.4, it is apparent that the total net shortening of the columns can be reduced by 20% to 10% for the 12-and 24-storey building by increasing the relative humidity from 50% to 80%.

5.4.3 Investigation of the Effects of Material Parameters on Column Shortening, Cement Classification

The Concrete Centre's prediction spreadsheets allow for 3 classes of cement to be used. The cement can be either of the three classes according to Eurocode 2: Slow-, Normal-, or Rapid hardening (S, N or R) cement the expressions being in terms of rate of strength gain (British Standard Institution 2014). There are different types of cement available commercially however, in the UK these are based on designations CEM I, CEM II & CEM III (The Concrete Centre 2016). Generally, CEM I cements are Portland cements and will typically be Classification 'R' to BS EN 1992-1-1. CEM II and CEM III, or their equivalents, may be 'S', 'N' or 'R' with specific classification made based on the proportions of Ground Granular Blast-furnace Slag (ggbs) or fly ash in the cement (The Concrete Centre 2016).

As shown in Figure 5.9, the simulation results indicate that the slower the hardening the less shortening occurs. For the 12-storey case, with 20° C ambient temperature, 50% relative humidity and Basalt used as aggregate, the maximum total net shortening

is obtained at the 11th floor level with values of 26.6 mm for 'Slow Hardening' cement, 28.0mm for 'Normal Hardening' cement and 31.3 mm for 'Rapid Hardening' cement.

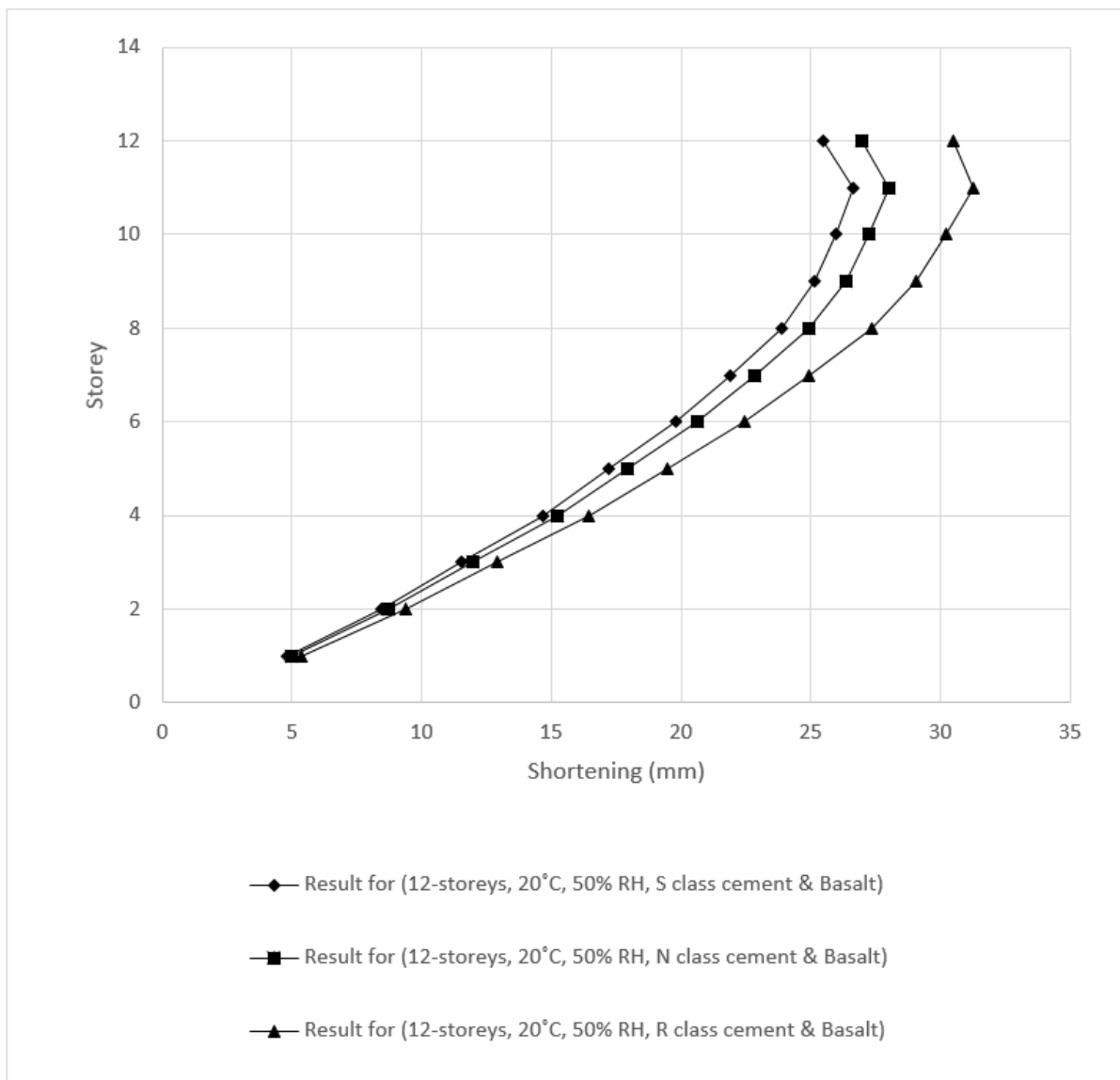

Figure 5.9 Slow, Normal and Rapid Hardening Cement Results for 12-Storey Building Structure, Rotimi et al (2017), See Table 6.1

A similar trend is observed for the 24-storey building structure as illustrated in Figure 5.10. The maximum total net shortening is observed at the 15th floor level with values of 155.4 mm for slow hardening cement, 156.1 mm for normal hardening cement, and 158.1 mm for rapid hardening cement. The effect of cement type on the maximum net

shortening in the 24-storey building structure is not as significant as that predicted in the 12-storey building structure. In the 24-storey case, the maximum net shortening occurs at the 15th floor level. For the 12-storey building, the results show that net maximum shortening increases by approximately 5% and 16% for normal and rapid hardening cement respectively compared to that of slow hardening cement. Whereas, for the 24-storey building, the net maximum shortening increases by approximately 0.5% and 2% for normal and rapid hardening cement respectively compared to that of slow hardening cement.

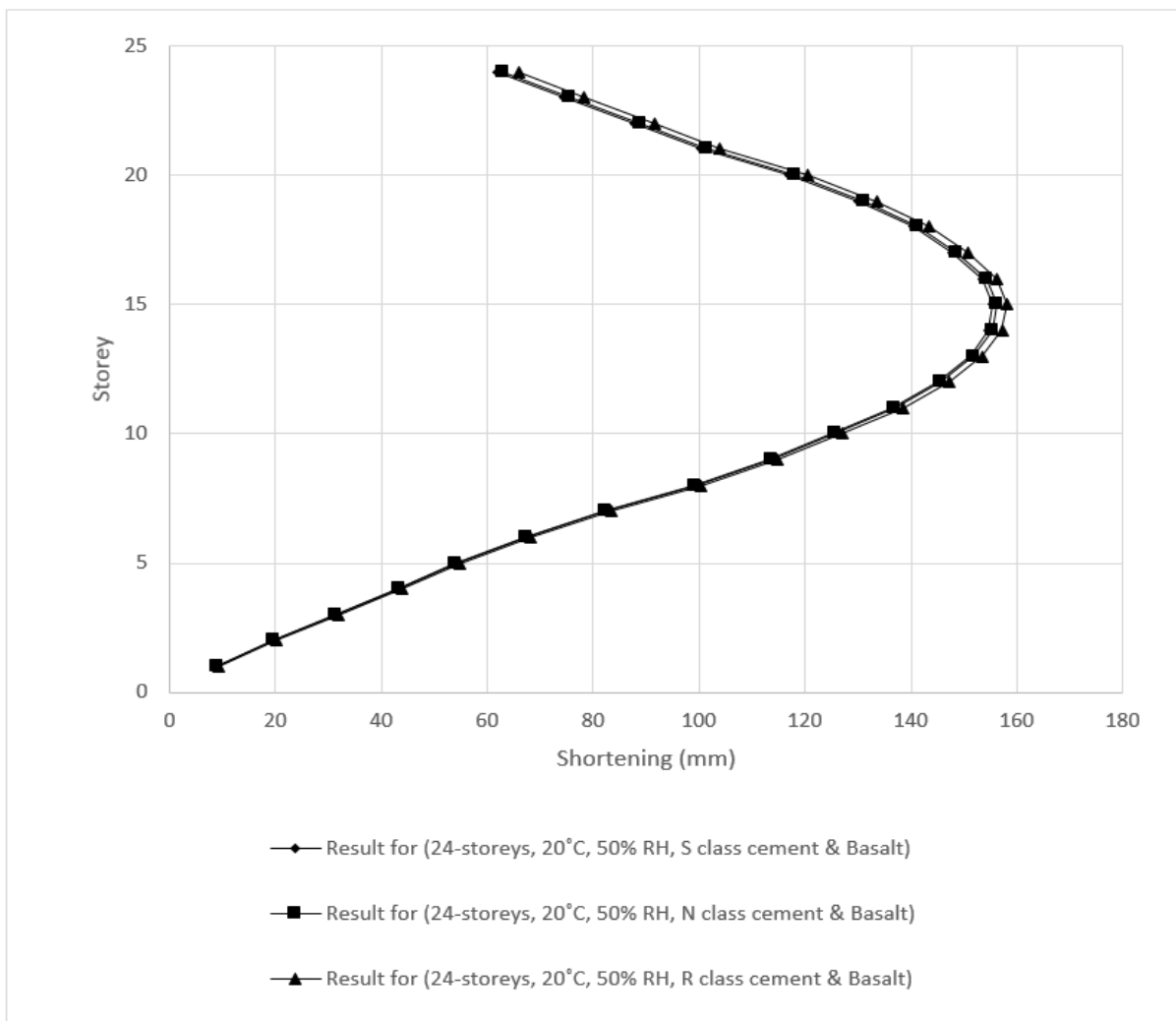

Figure 5.10 Slow, Normal and Rapid Hardening Cement Results for 24-Storey Building Structure, Rotimi et al (2017), See Table 5.2

Table 5.5 Results Summary for the Effects of Cement Type on Column Shortening

| 20° C, 50% RH, Basalt aggregate | S-Type Cement | $\Delta(N-S)$ [mm] | $\Delta(N-S)$ [%] | N-Type Cement | $\Delta(R-N)$ [mm] | $\Delta(R-N)$ [%] | R-Type Cement |
|--|---------------|--------------------|-------------------|---------------|--------------------|-------------------|---------------|
| Shortening at 11th Floor for 12-Storey | 26.6 | 1.4 | 5 | 28.0 | 3.3 | 12 | 31.3 |
| Shortening at 15th Floor for 24-Storey | 155.4 | 0.7 | 0.4 | 156.1 | 2.0 | 1.3 | 158.1 |

S – Type = Slow hardening; $\Delta(N - S)$

= (Normal hardening cement column shortening)

– (Slow hardening cement column shortening); N – Type

= Normal hardening; $\Delta(R - N)$

= (Rapid hardening cement column shortening)

– (Normal hardening cement column shortening); R – Type

= Rapid hardening

Table 5.5 shows that the faster the hardening of the cement, the higher the shortening effect especially for building structures not up to 24-storey. By choosing to use a slower setting cement, the total net shortening can be reduced by 5% and 0.4% for the 12- and 24-storey buildings respectively. Whereas, deciding to use a rapid setting cement, the total net shortening will be increased by 12% and 1.3% for the 12- and 24-storey buildings respectively.

5.4.4 Investigation of the Effects of the Mineralogy of the Aggregate on Column Shortening

The Concrete Centre's spreadsheets allows for selection of four different types of aggregates, namely: Basalt, Limestone, Quartzite and Sandstone. The effect of using each of these types of aggregate has been investigated in all the environmental conditions as well as using the three types of cement available on the programme.

This study showed that irrespective of the ambient temperature, relative humidity and cement type used, the same aggregate type ranking emerges in terms of column shortening. The results obtained for the 24-storey building with an ambient temperature of 5° C, a relative humidity of 50% and N-class cement are shown in Figure 5.11.

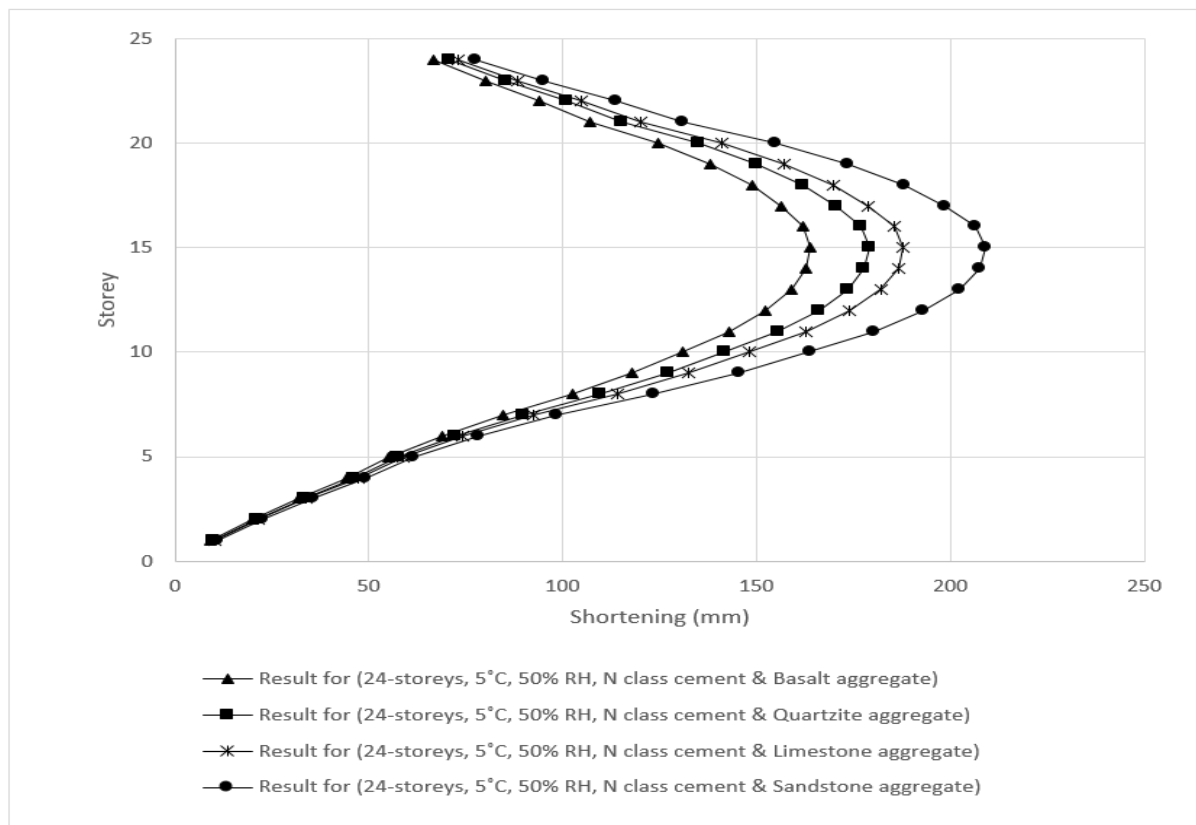

Figure 5.11 Aggregate Type Results at 5° C, 50% RH, and Normal Hardening Cement for the 24-Storey Building

Figure 5.11 presents the results of using a 'N' class cement, 50% relative humidity and an ambient temperature of 5° C, while varying the aggregate types. For all the aggregate types the maximum net shortening occurs at the 15th floor level with values of 163.8mm, 178.9mm, 187.8mm and 208.8mm for Basalt, Quartzite, Limestone and Sandstone respectively. Basalt produced the least net shortening with the Quartzite, Limestone and Sandstone aggregate giving net shortening values that are 9%, 15% and 27% greater than that of Basalt.

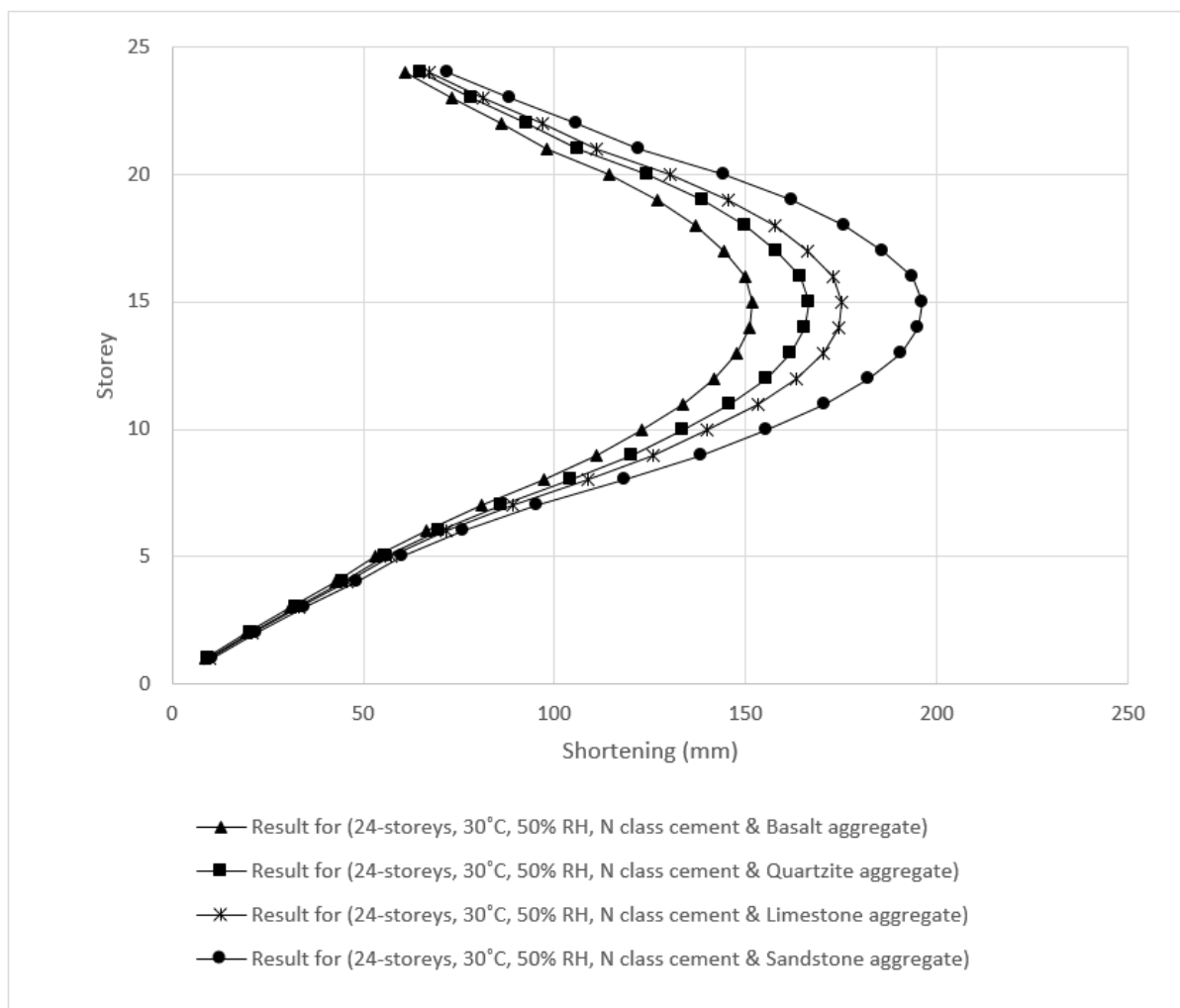

Figure 5.12 Aggregate Type Results at 30°C, 50% RH, and Normal Hardening Cement) for the 24-Storey Building

The results obtained with ambient temperature of 30°C, 50% relative humidity and normal hardening cement while varying the types aggregate used are shown in Figure 5.12. Similar behaviour was observed with the change in ambient temperature from 5°C to 30°C. For all the aggregate type, the maximum net shortening occurs at the 15th floor level with values of 151.6mm, 166.3mm, 175.0mm and 196.1mm for Basalt, Quartzite, Limestone and Sandstone respectively. Basalt again produced the least net shortening with Quartzite, Limestone and Sandstone aggregate giving net shortening values that are 10%, 15% and 29% greater than that of Basalt.

As far as aggregate mineralogy is concerned, Basalt gives the best results in this simulation, that is, the least net shortening effect. It is followed by Quartzite, Limestone and finally Sandstone which gives the highest values of shortening.

The mineralogical origin of the aggregates used in the concrete mixtures has thus a significant impact on the post-casting deformations of concrete and thereby on the shortening of the concrete columns.

Table 5.6 Results Summary for the Effect of Aggregate Type on Column Shortening

| 50% RH-N Type Cement | Basalt | Quartzite | Limestone | Sandstone | $\Delta(\text{max-min})$ Difference[m m] | $\Delta(\text{max-min})$ [%] |
|--|--------|-----------|-----------|-----------|--|---------------------------------|
| Shortening at 15th Floor at 5° C Ambient Temperature | 163.8 | 178.9 | 187.8 | 208.8 | 45.0 | 27 |
| Shortening at 15th Floor at 30° C Ambient Temperature | 151.6 | 166.4 | 175.0 | 196.1 | 44.5 | 29 |

Table 5.6 shows the results summary of the investigation on the effect of aggregate mineralogy on the total net shortening of the columns in a 24-storey building. Changing the type of aggregate used can alter the shortening by between (27% - 29%) for ambient temperatures of 5°C and 30°C respectively.

5.5 Summary

This study evaluated column shortening in mid-rise concrete structures, with focus on the effects of ambient temperature, relative humidity, cement hardening speed and aggregate type. The study approach used The Concrete Centre model for column shortening prediction produced insightful results.

The results show that the effect of the temperature on the total net shortening of columns can be considered as negligible compared to that of the other factors considered. Nonetheless, to reduce the shortening of the columns in a given project, consideration should be given to the erection of the structure in warmer weather when possible.

Furthermore, this study indicates that the total net shortening of columns can be reduced by 20% to 10% in 12-and 24-storey buildings by increasing the relative humidity from 50% to 80%. Additionally, cement hardening speed can be considered as insignificant for buildings up to 24-storey. However, in the case of a 12-storey building, the effect of cement type on total net column shortening becomes substantial.

Finally, the results also indicate that the aggregate type used when compared with the other factors considered has the most substantial impact on column shortening. Changing the aggregate type can alter the shortening by 27% with an ambient temperature of 5°C and 29% with an ambient temperature of 30°C.

The results of this study show that environmental factors that are the least controllable have less significant impact on column shortening. Column shortening can be significantly reduced by modifying controllable parameters such as the aggregate and cement types.

5.6 Recommendation

From the conclusion above, it can be recommended that using Limestone and Sandstone as aggregate in buildings over 13 storeys should be avoided. Furthermore, Basalt should be preferred to Quartzite when possible. Generally, it can be said that igneous rocks should be considered as first choice aggregate for high-rise concrete buildings, followed by metamorphic rocks.

Use of sedimentary rocks as aggregate should be discouraged even for low-rise buildings. This is that even though the shortening of the columns is not usually an issue in low rise buildings, creep and shrinkage deformations are concerns in terms of concrete cracking. Sedimentary rocks give the highest values of creep and shrinkage deformations. Moreover, aggregates with higher moduli of elasticity produce smaller relative values of column shortening.

CHAPTER SIX: Analysis of Results and Discussion

6.1 Introduction

Robert Bird and Partners Limited (RBP) were engaged by Lend Lease to provide Structural, Civil and Geotechnical Engineering design services for the Master Plan Phase (MP1) project in Elephant and Castle, London.

This chapter sets out the construction tolerances and describes the predicted movements that the building's structure will go through during the design life of the building.

It is intended that this chapter may referred to by the Architect, M&E Engineer, Main Contractor, Façade designer and other specialist subcontractor designers to understand both the initial position of the structure and the behaviour (movement) of the structure under loading of the primary structural elements. Design parameters are provided for use in the design and detailing of secondary structures, cladding, partitions and ancillary items that connect to the primary structure.

These items may include, but are not limited to:

- Cladding
- Lifts
- Floor and ceiling finishes
- Partitioning
- Services
- Secondary Steelwork

No allowance has been made for deformations of non-structural or secondary elements and if deemed necessary the interested party should make their own assessment of this.

This chapter initially considers construction tolerance and building movements separately, followed by a discussion and summary of the combined effect which the follow-on secondary structures and cladding, need to allow for.

Tolerances relate to the accuracy of the fabrication and construction of the structure, whilst movements relate to changes to the structural geometry due to the loads or forces being applied to the structure. The initial position of the structure as constructed is that shown on the structural drawings with the addition of the permitted positional tolerances referred to in (Section 7.3) of this chapter. All subsequent movements are measured from the envelope formed by the permitted tolerances.

The movements calculated for design purposes are the upper-bound movements under the appropriate codified loading for the building's design life. Movements have typically only been considered for the structure in its completed form. In order to describe the movements "seen" by elements fixed to the structure, however, assumptions regarding the construction programme and construction sequence have been made. These assumptions are recorded in (Section 7.5) and are based on the advice received from Lendlease. In the event that the frame contractor's proposed methodology, sequence or programme significantly changes from these assumptions, the movements provided in this chapter should be reviewed and updated.

Movements that occur during construction are not covered by this chapter (except where specifically described) as these will be dependent on the construction sequence and programme adopted by the contractor. The frame contractor may need to adopt a construction methodology that ensures that the movements and tolerance requirements of this chapter are met for their adopted sequence. The contractors adopted construction sequence and fit-out programmes, in conjunction with any

adopted temporary work solutions, will determine the movement that occurs at each interface relative to installation.

This chapter should be read in conjunction with the structural drawings, specifications and other contract documents (for more details refer to Appendix B). This movement and tolerances analysis is a performance specification for construction designed elements or alternative contractor design proposals.

6.2 Outline Description of Building and Structural Form

Master Plan Phase 1 (MP1) is the first phase of a wider masterplan development. In addition there are two other related (but separate) developments currently being constructed by Lend Lease – Trafalgar Place, and One the Elephant.

The MP1 site is located in Elephant & Castle, Southwark, London, and forms part of the Elephant and Castle Regeneration Masterplan scheme. The approximate postcode for the centre of the site is SE17 1SR.

The proposed development comprises a mixed-use development, with affordable and private accommodation split into apartments, townhouses and duplex units over three sets of blocks.

With reference to Figure 7.1, a description of each block comprising MP1 follows:

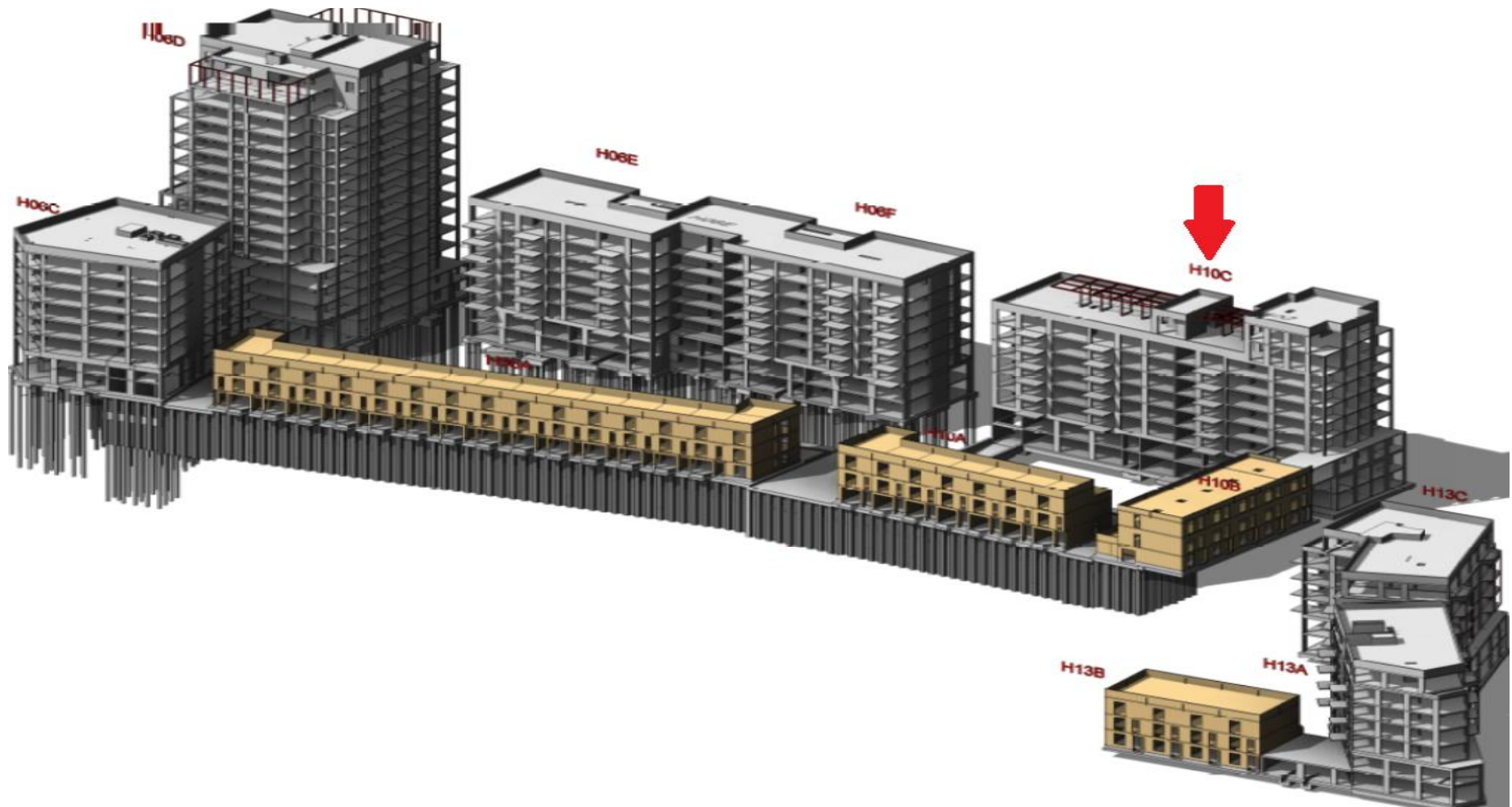

Figure 6.1 MP1 Site (Master Plan 1 – Elephant & Castle – London)

where

Block H6A: 3 storey townhouses (14.80m Above Ordnance Datum, AOD)

Block H6C: 8 storey building facing Wansey Street with open plan single story flats (29.70m AOD); Retail space is provided at ground floor on the western perimeter, whilst BOH storage, plant rooms and circulation is provided on the eastern side.

Block H6D: 16 storey building with open plan single story flats (55.23m AOD); retail, and lobby space is located on the west side of the ground floor, and plant rooms, including substation, switch rooms and CHP station are located on the east.

Block H6E/F: 8 storey building with open plan, single storey flats on all upper levels with duplexes on the ground and first floors (30.48m AOD)

Block H10A: 3 storey townhouses facing onto Wansey Street.

Block H10C: 8 storey building with open plan, single storey flats on floors 2-7 and duplexes occupying ground and first floors; two duplex penthouses on level 7 (37.23m AOD). This building is connected to a three storey residential building (facing onto Brandon place) via a linking storey at level 2, below which is an opening in the building permitting access to the courtyard.

Block H13A: 7 storey building with open plan, single storey flats on levels 2-6, and two storey duplexes between ground and level.

H13C: 3 storey residential buildings (13.58m AOD) facing onto Wansey Street. Mid-rise and tall buildings have private balconies and terraces.

A single level basement is located under part of developed site (H6A, H10A and part of central courtyard) for car parking, plant and cycle storage.

A raised central courtyard, situated above the basement, provides public realm amenities and landscaping.

MP1 is designed to revolve around the retention of existing trees.

6.3 Construction Tolerance Specifications – Concrete

The tolerances stated in this research are defined as the permitted deviations from the specified size or position of the relevant structural element prior to the striking of the formwork.

The frame contractor may conform to the allowable construction tolerances as described by this study and as set out in Appendix B. The project's allowable construction tolerances are based on those specified by the National Structural Concrete Specifications 4th Edition (NSCS) (2010).

For the avoidance of doubt, the construction tolerances specified within this research (including the appendix), and the interpretation of construction tolerances described within this chapter, take precedence over the NSCS specification.

6.4 Discussion of Construction Tolerances

As described in the NSCS (2010), tolerances are not cumulative, and shall be considered in hierarchy, where each subsequent tolerance level must be contained within the broader tolerance level above.

There are generally more than one tolerance criteria applied to any given positional check. The contractor is required to comply with all criteria.

6.4.1 First Level (Highest Level) – Overall Tolerance of the Structure

This is the outside envelope within which the structure must be achieved, specifying allowable:

- Inclination of the structure
- Overall building level
- Position of base supports
- Foundation bolts and similar inserts

6.4.2 Second level – Positional Tolerance of All Parts of the Structure

The positional tolerance of all parts of the structure must stay within the envelope of the First Level allowable tolerances (Section 6.4.1). The NSCS breaks this down into two categories:

- Position of columns and walls
- Position of beams and slabs

Allowable tolerances are generally specified relative to adjacent members or between adjacent floors (not to absolute datum). These allowable tolerances should be used by designers when assessing the allowable minimum dimensions between elements. The specified setting out of the structure (what is shown on the drawings) needs to make due allowance for the allowable positional tolerances.

6.4.3 Third level – Dimensional Tolerance of The Individual Elements

This is the allowable tolerance of structural element dimensions. Once again, though, the structure must also comply with the Second Level allowable tolerances (Section 6.4.2). The NSCS breaks this down into three categories:

- General structural elements
- Staircases
- Precast Concrete Elements

6.4.4 Fourth level – Position Tolerance

This is the allowable tolerance in the position of reinforcements and fixings within individual structural elements. The NSCS breaks this down into three categories:

- Reinforcements
- Holes and fixings
- Surface straightness

6.5 Description of Movements

The information on movements included in this research is defined as changes in the structural geometry under applied loading, which are effectively movements away from the initial position as constructed, including movements beyond the envelope formed by the allowable construction tolerance.

These movements can be the result of a number of different loadings and factors which are briefly outlined below.

6.5.1 Dead Loads (Permanent)

These are movements caused by:

- The self-weight of the structure
- Finishes
- Cladding
- Ceiling and services

The movement of the horizontal members due to these loads is generally discussed in terms of the beam and slab deflections.

Movement of the vertical elements includes the axial shortening - both elastic (instantaneous) and inelastic (time dependant due to creep) of the concrete core and columns under applied loads.

Dead loads cause permanent deformation of the structure, and it should be noted that the majority of creep effects result from movement due to dead loads. Dead loads can also cause horizontal movements of the structure and these are noted in this report where considered significant.

Movements due to dead loads are unrecoverable.

Refer to (Appendix B) loading plans for further details of the dead loads the structure has been designed for.

6.5.2 Imposed Loads (Live)

These are movements caused by imposed (live) loads and may be considered as short, medium or long term loads caused by the user of the building. Generally, for time dependant movement calculations it has been assumed that on average 30% of the “design” imposed load is applied in the long term. The remaining 70% is applied as a short to medium term transient load.

The movement of the horizontal members due to these loads is generally discussed in terms of the beam and slab deflections. Movement of the vertical elements include the axial shortening - both elastic (instantaneous) and inelastic (time dependant due to creep) of the concrete core and columns under applied load.

Deformations caused by imposed loads are generally recovered once the live load is removed, however, for medium and long term imposed loads, permanent additional deformation occurs due to creep, refer to (Appendix B) loading plans for further details of the imposed loads the structure has been designed for.

6.5.3 Foundation Movement

Vertical movement of the structure will occur due to settlement of the supporting foundations / piles under applied loading. This can include differential movement due to different loads across the building, or variations in ground conditions or foundation types. Changes in ground water pressures or imposed ground movements such as heave can also cause movements to the structure.

H10C will incur a 42 mm worst case settlement according to Robert Bird Group foundation movement calculation, half of which will be released due to elastic deformation (21 mm) according to (Appendix B). H10B will witness a 10 mm settlement, therefore the differential settlement between blocks H10C and H10B will be in the region of 9-11 mm, which satisfies the differential settlement limits for the link structure, refer to (Appendix B) for more details

In order to limit differential settlements between H10B and H10C, construction sequencing will serve to remove the short term settlement, leaving a minimised differential settlement of approximately 9 mm between the two blocks. Refer to Figure 6.2 below for a bearing pressure plot showing the differences in pressures exerted on the ground from both structures. Construction of H10B can commence once H10C reaches at least 75% completion, as presented in detail in (Appendix B).

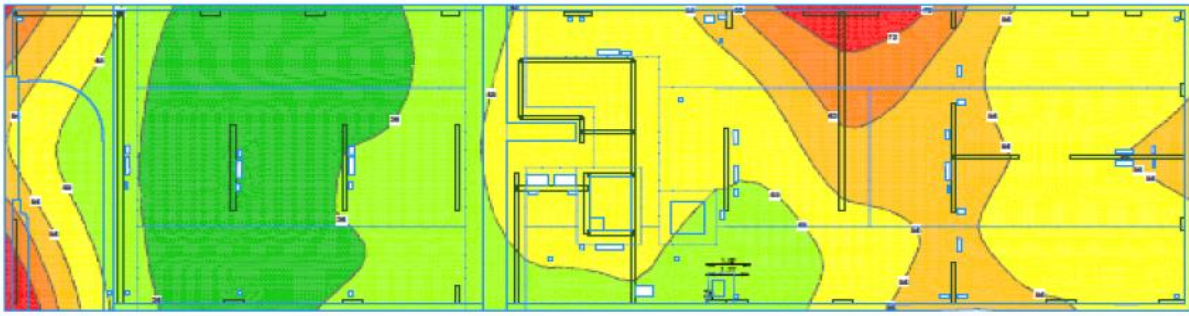

BLOCK H10C

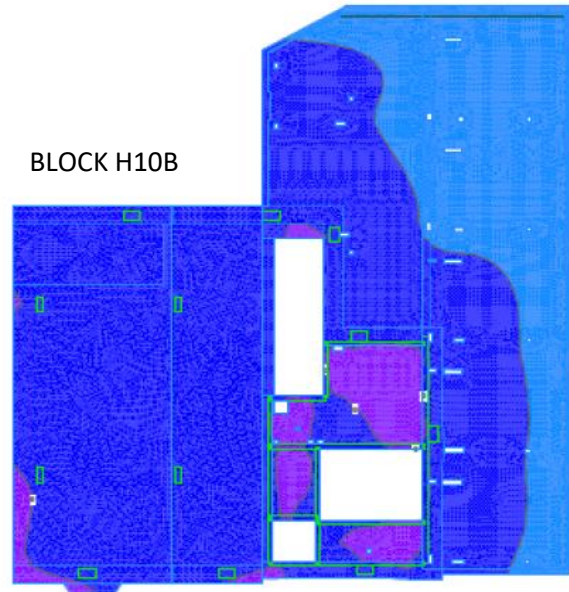

BLOCK H10B

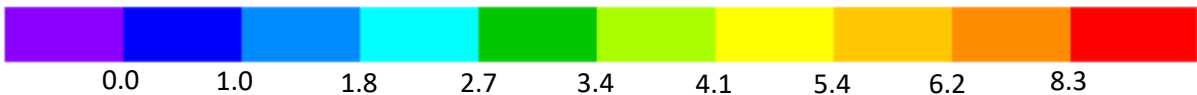

Figure 6.2 H10B & H10C Settlement Plot

6.5.4 Concrete - Long Term Concrete Effects (Shrinkage, Creep and Cracking)

Shrinkage and creep are time dependent properties of concrete, both leading to permanent shortening of concrete elements. The properties are complex and dependent on the ambient humidity, the dimensions of the element under consideration and the composition of the concrete. Creep is also influenced by the maturity of the concrete under first load application and the magnitude of the load and the loading history, (Appendix B).

Creep occurs when a concrete element undergoes compression (including compressive stresses due to bending moments). Deflection due to creep is generally in the order of two times the elastic deflection, i.e. for every 1 mm of elastic deflection, an additional 2 mm of deflection due to creep occurs over time. This “creep factor” will typically lie in the range from 1 to 3 depending on variables as outlined above and will be different for separate structural elements.

A common approximation is that, under constant conditions, 40% of the total creep occurs in the first month, 60% in six months and 80% in 30 months. The movements discussed within this research are calculated on this basis according to Robert Bird Group foundation movement calculation.

Shrinkage is more difficult to estimate due to its dependence on the geometry of the element and the potential for minimisation via appropriate curing techniques.

Cracking of concrete reduces the effective modulus of the section under consideration, and this results in greater deflections than an un-cracked element. In order to assess the impact of cracking on structural movements, a computer analysis is typically required since this behaviour can be complex. A cracked section can be expected to have half the effective stiffness of an un-cracked section as Robert Bird Group structural design indicates. The fully cracked section will therefore deflect twice as much as an un-cracked section. Cracking effects needs to be accounted for in conjunction with creep effects.

Movements due to shrinkage and creep are unrecoverable. Effects due to cracking are generally also unrecoverable; however the use of post-tensioning (where/if specified) can limit and reduce the degree of cracking since the compression can close these cracks.

6.6 Pre-Cambering and Pre-setting

Pre-cambering is the process of constructing a slab or beam in a smooth continuous curve (circular or parabolic).

Pre-setting is the process of constructing a beam or slab into a pre-set position away from its specified position. Pre-setting is generally specified at a given point or along a given line, with a linear change in pre-set positions. Straight lines between pre-set points (not curved).

Pre-cambering and pre-setting are used as means of deliberately constructing the structure in the opposite direction to that which it is predicted to move in under dead loads, so that after (a proportion of the) dead load is applied the structure has deflected into its required position in space. This does not change the amount of movement which the primary structure goes through, but can be used to reduce the amount of sag or deflection that the following elements (and building users) need to accommodate.

Where required, pre-cambers and pre-sets will be detailed on the structural drawings at Stage E and beyond. It is recommended by Eurocode 2 (2008) to pre-camber up to 70% of the expected dead (permanent) load deflection since there is a possibility of over pre-cambering, which may cause a permanent upwards deflection instead of a reduced downwards deflection.

6.7 Construction Programme

The construction programme affects the movements of the structure. A key item is the time at which the cladding is constructed since this has a large impact on the amount of movement the cladding has to accommodate.

Key assumptions on the construction programme are:

- Tower typical floor cycle time of one calendar week (seven days)
- Cladding installed three to eight floors behind leading slab – four to eight weeks after slab cast
- Cladding installed before floor finishes and fit out. Construction sequence for H06D (as an example) is assumed to be:
 - Core jump formed circa five floors ahead of floor construction
 - Floors constructed, with verticals (except core) in cycle
 - Pods (if applicable) loaded onto slab, located away from slab edge
 - Cladding installed
 - Non- load bearing party walls constructed
 - Floor finishes applied
 - Partition walls constructed along with general fit out and installation of services
 - Ceiling installed

6.8 Accumulation of Movement and Tolerances

6.8.1 Accumulation of Tolerances

Tolerance values are generally not cumulative. The box principle is to be applied to this building. Reference should be made to (Section 6.3) which includes project specific figures specifying the overall tolerances to be achieved.

If it is necessary to combine tolerances, then this combination needs to comply with the method given in BS 5606 (1990) which involves taking the square root of the sum of the squares of the relevant individual tolerances. This method accounts for the

statistical improbability of all deviations occurring in the most onerous manner and direction.

6.8.2 Accumulation of Movements

Movements are to be combined in conjunction with the requirements of BS EN 1990 (2008) Table A1.4, for the serviceability combination appropriate to the item under consideration, characteristic, frequent or quasi-permanent combinations.

For the combination of movements from different elements, the movements should be additive under the relevant load combination. The quasi-permanent load combination accounts for the reduced live load that is likely to be experienced by that structural element in the long-term.

To assist in achieving a consistent interpretation of the combined movements, specific movement combination cases have been identified and are defined in this section.

6.8.3 Combination of Movement and Tolerances

The combination of tolerance and movement is additive, i.e. combined tolerance + movement. Figure 6.3 describes the indicative timeline of structural tolerances and structural movements for a typical slab edge, and identifies which of the movements occur prior to cladding and partitions being installed and which occur after. It is important that the following trade-offs recognise which movements need to be allowed for in the tolerances of the structural interface/connection, and which structural movements need to be allowed for in the jointing systems.

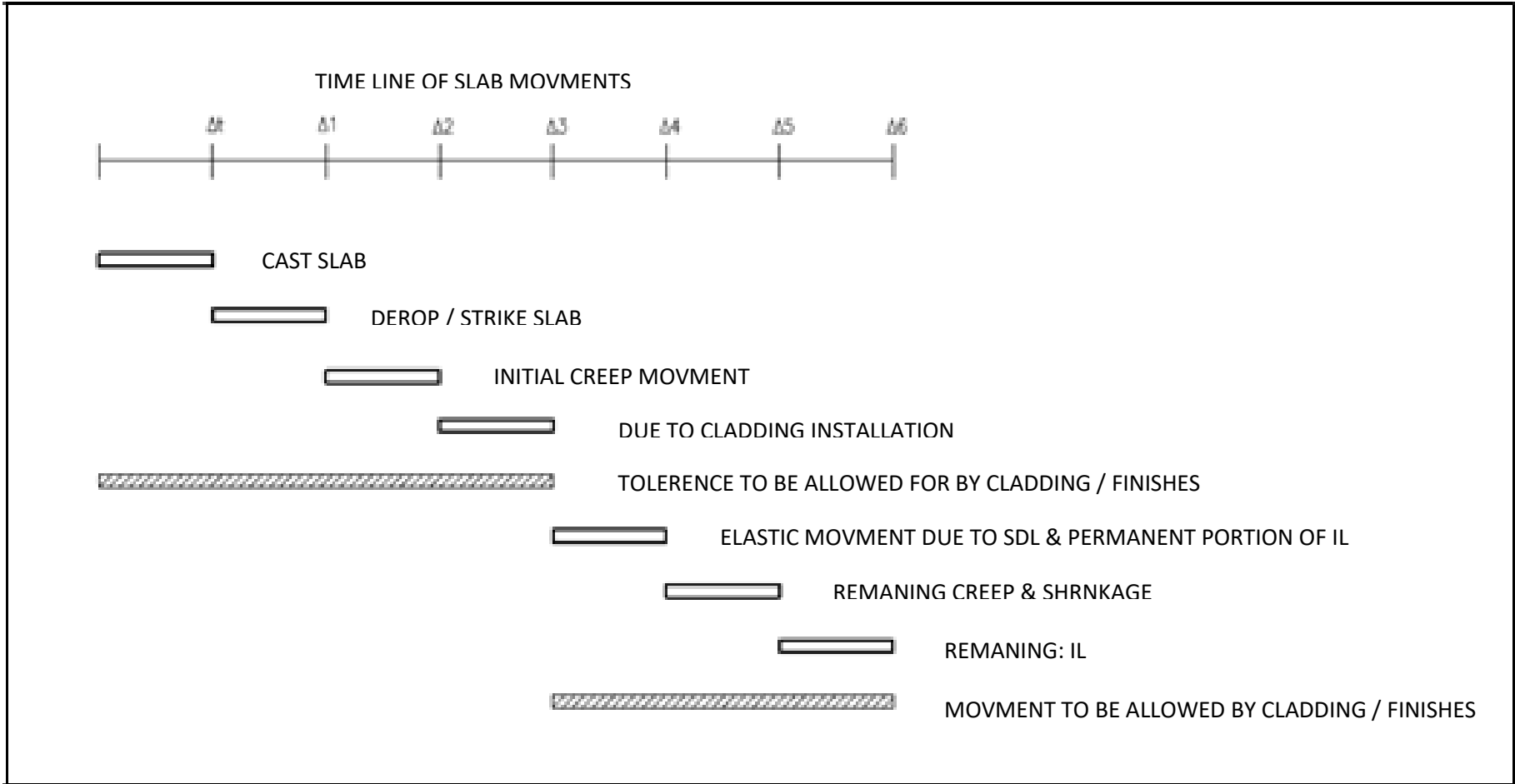

Figure 6.3 Movements and Tolerances Timeline

To assist in achieving a consistent interpretation, specific combinations of movements and tolerances have been identified and are defined in (Section 6.10).

6.9 Details of Structural Movement Limits

The following sets out the structural deflection limits for different structural conditions. For each condition, the actions (loads) considered in reference to these limits shall be those required for the relevant serviceability limit state (working loads), and may be reduced where appropriate in accordance with BS EN 1990 (2008) and (BS EN 1991 2008).

Movement is discussed below in its incremental components. (Section 6.11) describes the combination of movements and tolerances relevant to various follow on trade-offs and interfaces.

6.9.1 Vertical Deflection - Floor under Vertical Imposed and Dead Loading

The suspended floors have been designed in accordance with the deflection limits shown in Tables 6.1 and 6.2, which are based on those defined in section 7.4.1 of BS EN 1992-1-1 (2004). The deflection is assessed relative to supports. A negative number represents a sag, and a positive number represents a hog.

Table 6.1 Slab Deflection Criteria – Internal Conditions

| Type | Loads Applied | Deflection Limit |
|--|--|--|
| Initial Deflection (Prior to installation of cladding, partitions and finishes) | Self-weight of structure | + 5 mm - 10 mm |
| Incremental Deflection: (Long term additional deflection after installation of cladding, partitions , finishes and long term imposed loads + short term imposed loads) | Quasi-permanent loads + imposed (live) loads | + 10 mm - 20 mm or Span / 500 (the lesser of) |
| Total Long Term Deflection (combination of short term + incremental) | Quasi-permanent loads + imposed (live) loads | + 15 mm - 30 mm or Span / 250 (the lesser of) |

Table 6.2 Slab Deflection Criteria – Slab edge Conditions

| Type | Loads Applied | Deflection Limit |
|--|--|--|
| Initial Deflection (Prior to installation of cladding, partitions & finishes) | Self-weight of structure | + 5 mm - 10 mm |
| Incremental Deflection: (Long Term additional deflection after installation of cladding, partitions , finishes and long term imposed loads + short term imposed loads) | Quasi-permanent loads + imposed (live) loads | + 10 mm - 15 mm or Span / 500 (the lesser of) |
| Total Long Term Deflection (combination of short term + incremental) | Quasi-permanent loads + imposed (live) loads | + 15 mm - 25 mm or Span / 250 (the lesser of) |

Note: Quasi-permanent loads include all dead loads, superimposed dead loads plus a proportion of the imposed load considered as permanent. This proportion varies according to the proposed usage of the space, but is typically 30% for residential use.

6.9.2 Vertical Foundation Settlement

Differential settlement at the head of the pile under working load:

- At the head of the pile - between adjacent columns $< 10 \text{ mm}$ or $L/1000$
- At the head of the pile - between the core and adjacent columns $< 10\text{mm}$ or $L/1000$

The anticipated settlement of the piled foundations for H06C, H06D and H06EF is in the range of 5 – 15 mm, with the differential settlement between H06C and H06D, will be in the range of 5-10 mm, (Appendix B).

The total settlement for all rafts (except H10C) is 30 mm, H10C is limited to 42 mm.

6.9.3 Axial Shortening of Concrete Cores Walls and Columns

a) Vertical Elastic Shortening

The concrete columns and cores shorten elastically under loading as well as exhibiting inelastic shortening due to creep and shrinkage. It is assumed that geometrical lengthening will be provided via definition of super-elevation levels, to build out the elastic axial shortening due to the quasi-permanent serviceability combination in accordance with Eurocode design. This is the design assumption made to provide an installed core datum that accounts for axial shortening. Refer to (Section 6.5.6) for comments on creep and shrinkage.

The loading considered to find the maximum elastic shortening in cores is the Characteristic Serviceability Load Combination in accordance with A1.4 (BS EN 1990 2008).

b) Vertical Inelastic Shortening

Vertical inelastic time dependent shortening of the concrete core and columns is due to creep and shrinkage of the concrete.

This shortening of the core and columns, relative to the datum, is dependent on the construction sequence and programme.

For MP1 buildings (all under 20 storeys) vertical shortening is negligible.

7.10.4 Horizontal Deflection – Movement of the Structure under Wind Loading

The primary structure will deflect laterally under wind loading. Wind loads are based on peak gusts lasting for a short period and therefore it is permissible to use short term E values for the concrete in assessing these movements, provided that a cracked section analysis is used where appropriate.

Based on these assumptions the horizontal sway under wind loading in conjunction with long-term gravity loading will be limited to the values given in Table 7.3 below.

Table 6.3 Horizontal Movement Criteria, based on (Eurocode 2 2008)

| Condition | Deflection Limit |
|-------------------------------|--|
| Deflection of a single storey | $h / 400$ (where h=storey height) |
| Overall building sway | $H / 500$ (where H = total building height) |

This is comfortably inside the defined limits. It is recommended, however, that all follow-on trades and structural interfaces are designed based on the deflection limits set out in Table 6.4.

6.9.4 Horizontal Deflection – Movement of the Structure under Gravity Loading

When the centre of a building’s weight does not coincide with the centre of its vertical stiffness, the structure will deflect horizontally. The structural design aims to limit this affect to limit the movement and to limit the permanent lateral action; this applies to the stability core, although some movement is inevitable for a building. The building movement limits are set out in Table 6.4 below.

Table 6.4 Allowable Lateral Deflections due to Gravity Loads, (Eurocode 2 2008)

| Condition | Deflection Limit |
|--|---|
| Deflection due to structural self-weight | H / 2000 (where H=storey height) |
| Deflection due to total dead loads | H / 1500 (where H = total building height) |

Assessments indicate that building movements due to gravity loads are less than 10 mm and therefore are unlikely to require any pre-setting of the structure.

6.9.5 Movement of the Structure Subject to Thermal Actions

It is assumed that upon completion the structure is enclosed within the building envelope, a controlled temperature environment. Thermal movements for the structure are derived in accordance with BS EN 1991-1-5 (2002) assuming:

- c) The coefficient of thermal expansion of the concrete is $12 \times 10^{-6} / ^\circ\text{C}$

d) Table 5.1, BS EN 1991-1-5 (2002), the average inside temperature, $T_0 = (20\text{ °C} + 25\text{ °C})/2 = 22.5\text{ °C}$.

Table 6.4 Building Temperature Variation

| Building Temperature Differential | | | | |
|-----------------------------------|----------|-----------------|----------|------------------------|
| | T_{in} | $T_{out} \#\#$ | T^{**} | $\Delta T_u = T - T_0$ |
| Summer | 20 °C | 35 + 18 = 53 °C | 36.5 °C | 14 °C |
| Winter | 25 °C | -10 °C | 7.5 °C | -15 °C |

Thermal movement for the building under consideration is to be derived utilising the coefficient of thermal expansion of steel and concrete, $12 \times 10^{-6} / \text{°C}$, and a temperature differential of 30 °C. As a simplification, the temperature range experienced by the concrete can be assumed to range from 5 °C to 35 °C, hence the strain experienced by the concrete will be 0.36 mm/m.

6.10 Allowances Required due to Structural Movement and Tolerance

The movements summarised here are predicted maximum values and unless specifically noted otherwise are cumulative. Predicted differential movements between elements in the building can be derived from the movements described herein.

6.10.1 Slab Movement and Tolerance

This outlines the vertical slab movement and tolerance relative to supports, and breaks down the movement into key components.

Table 6.5 Breakdown of Vertical Slab Movement & Tolerance

| Δ | Tolerance | Description |
|------------|---|--|
| Δ_t | Construction Tolerance | Deviation from datum prior to formwork being struck |
| | Movement Type | Description |
| Δ_1 | Short term (elastic) deflection of structure self-weight only | Movement occurs instantaneously under self-weight of structure loading upon removal of back props. |
| Δ_2 | Initial time dependant creep movement due to self-weight of structure (up to time of application of cladding) plus any construction loads | Time dependent movement occurring between de-propping and the installation of cladding. |
| Δ_3 | Deflection due to installation of the cladding system | Deflection due to cladding installation – note for curtain wall facades, this component of deflection is taken out in cladding system adjustment during installation, and does not contribute to the movement “seen” by the cladding system. |
| Δ_4 | Short term (elastic) deflection due to superimposed dead loads (finishes etc.) + permanent proportion of live load | Immediate sag due to superimposed dead loads and the proportion of live load that is always there (typically taken as 30% of Imposed load for residential) representing furniture etc. |
| Δ_5 | Remaining time dependant movement of quasi- permanent loads | Time dependent creep movement that occurs due to dead and super-imposed dead loads less the short term creep movement that has already occurred as part of Δ_2 . Maximum movement is reached after approx. 30yrs. |
| Δ_6 | Elastic deflection of remaining (short term) live loads (recoverable) | Elastic movement due to the short term (transient) imposed live loads (e.g. people). |

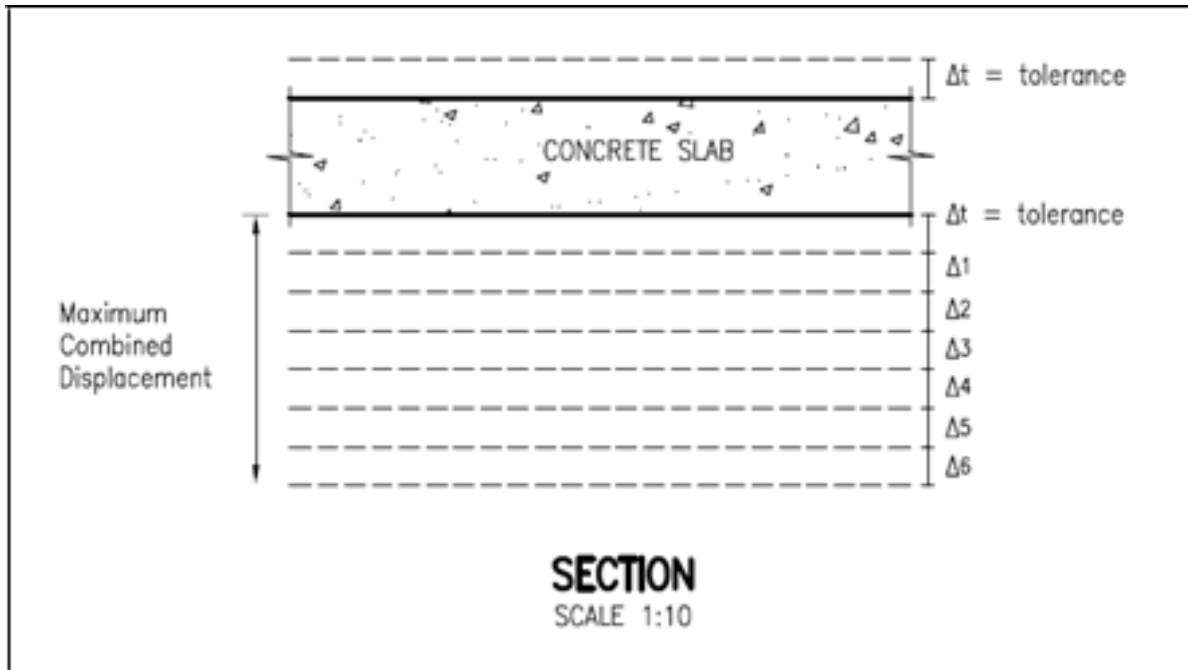

Figure 6.4 Breakdown of Slab Deflections

As described in previous sections, the design and detailing of the elements fixing onto the primary structure is controlled by the pre-fixing building movement (including construction tolerance), Δ_{initial} and post-fixing building movement, $\Delta_{\text{incremental}}$. The table below summarizes the movement combinations for the main trade items based on general construction practice.

Table 6.6 Movement Combinations for Main Trade Items

| Trade Elements | Δ initial | Δ incremental |
|---------------------|---|----------------------------------|
| External Cladding | $\Delta t + \Delta 1 + \Delta 2$ | $\Delta 3 + \Delta 4 + \Delta 5$ |
| Internal Partitions | $\Delta t + \Delta 1 + \Delta 2 + \Delta 3$ | $\Delta 4 + \Delta 5$ |

6.10.2 Vertical Movements Relevant to External Cladding

This section provides the vertical movement and tolerance conditions to be considered for the external cladding design.

Note: a negative sign denotes a decrease in differential displacement, while a positive sign denotes an increase.

Figure 6.5 shows the slab movement to be considered where the cladding is to be fixed between adjacent floors. Construction tolerance is included within initial slab deflections.

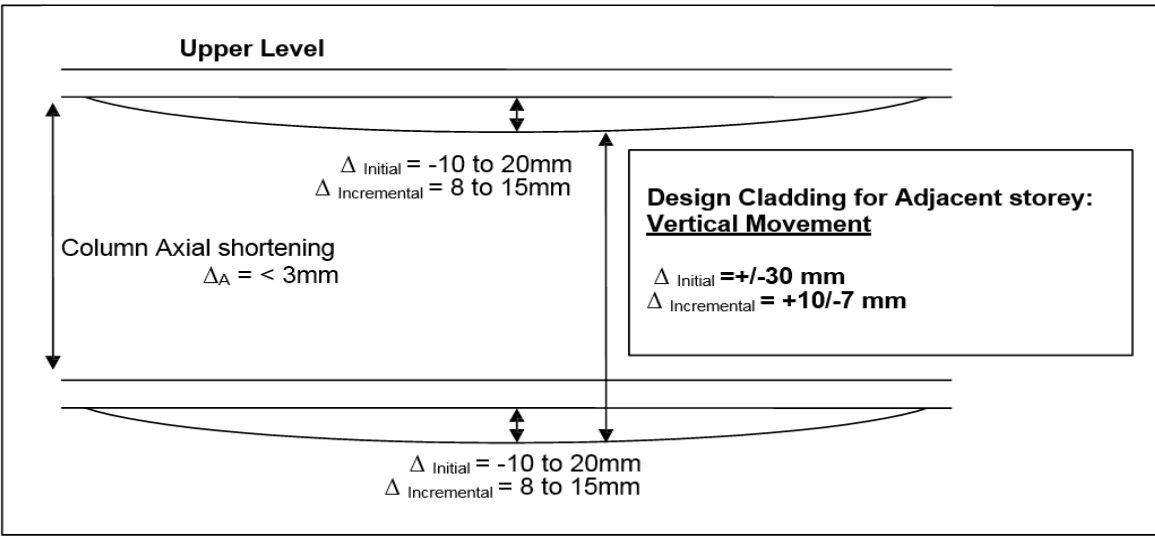

Figure 6.5 Edge Slab Deflection between Adjacent Floors (Robert Bird Group)

Note: These deflections are consistent with the deflection limits set out in (Section 6.10.1)

The above accounts only for slab deflection, and does not include displacement of supports at transfer structures. Where transfer structures are present, effects should be considered on a case-by-case basis and will be affected significantly by where the cladding is fixed (plan and storey). Refer to (Section 6.10.1) for deflection information for transfer structures.

Figure 6.6 below shows the condition where the ground floor slab experiences settlement and the Level 01 slab deflects at mid-span. A differential settlement occurs

between grids where different column load applies, and will be distributed linearly between the grids. With the upper level slab settling together with its foundations, the differential settlement between the grids will not have a significant effect on the floor to ceiling height. The width of the movement joint at ground level will be controlled by the deflection of the L01 slab.

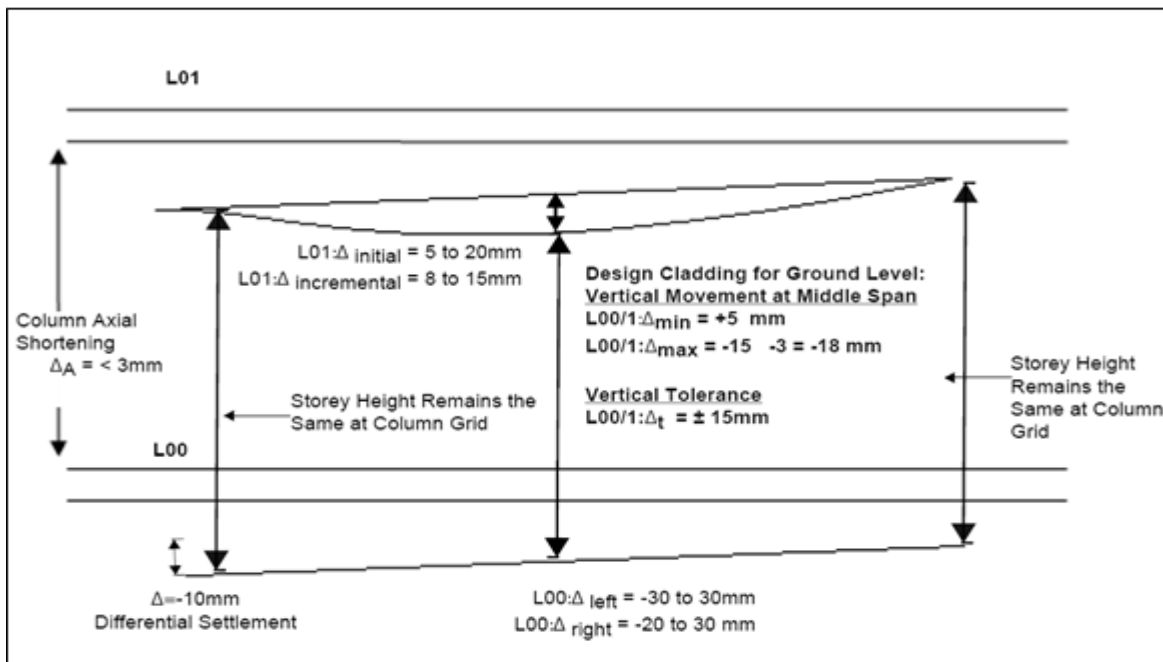

Figure 6.6 Ground Floor - Slab Edge Condition, (Robert Bird Group)

The external brickwork façade will be primarily supported at each level, but in some cases it is anticipated that the façade will be supported on brackets every two storeys, as Eurocode 2 (2008) predicts.

The supporting bracket shall be bolted onto the cast-in channel at the edge of the concrete slab. The vertical construction tolerance and the initial movement between the fixing levels will be accommodated by adjusting the fixing position along the bracket's slot. The predicted incremental movement after building the brickwork determines the width of the horizontal movement joint under the supporting bracket.

Figure 6.7, below, illustrated the predicted initial (tolerance) and incremental movement to be considered in the brickwork supporting system design.

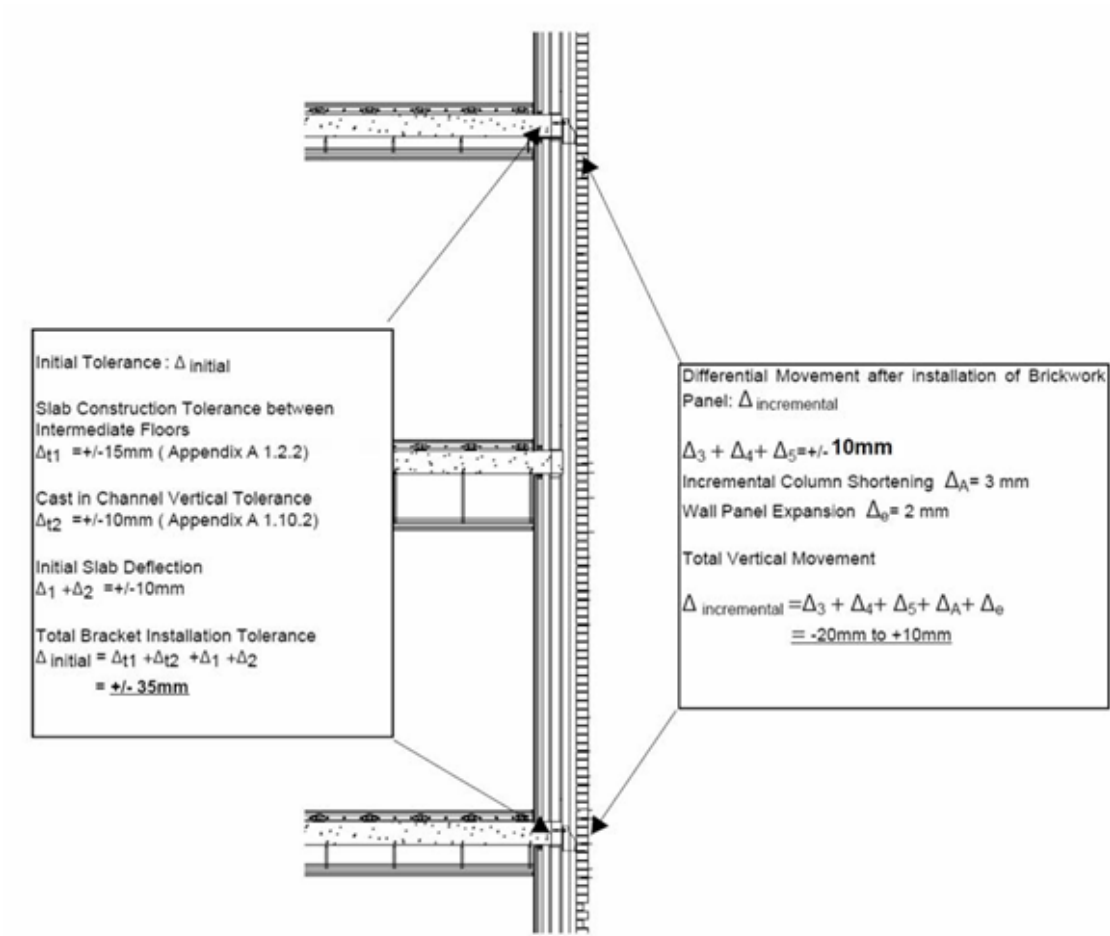

Figure 6.7 Brickwork Façade Supporting at the Concrete Slab Edge

6.11 Ceiling Zone Allowance for Slab Deflections

The ceiling void is required to include an allowance for slab tolerance and deflection. It is assumed that the ceiling will be installed after the installation of all floor finishes, partitions and party walls. It is also assumed that the ceiling will be installed to a true level and that the slab will therefore be out of position due to the following:

- Construction tolerance
- Slab movements due to $\Delta_1 + \Delta_2 + \Delta_3 + \Delta_4$

- Slab movement due to creep affects up until the time of ceiling installation (circa six months after slab casting).

This is summarised in Table 6.12.

Table 6.7 Ceiling Void Allowance for Slab Movement and Tolerance, (Robert Bird Group)

| Movement Component | Zone required |
|--------------------|---------------|
| Tolerance | +/- 10 |
| Movement | - 15 |
| Total | - 25 |

6.12 Structural Frame Construction Tolerance

The following is based on the tolerances specified by the National Structural Concrete Specifications 4th Edition (NSCS 2010) section 10. Where tolerances have been modified from those specified by NSCS they have been highlighted in bold.

6.12.1 Overall Structure

- Inclination

Location of any column, wall or floor edge, at any floor level, from any vertical plane through its intended design centre at base level in a multi-storey structure.

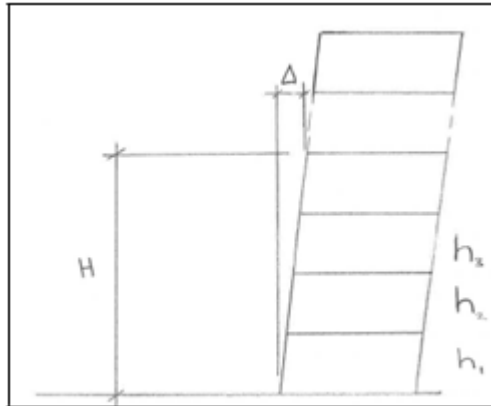

Figure 6.8 Inclination of Floor edge, Column and Walls

Permitted deviation $\Delta =$ the smaller of **25 mm** or $H / \left(200 n^{\frac{1}{2}}\right) \text{ mm}$

where

$h =$ free storey height in mm

$H =$ free height at location in mm $= \sum h_i$ in mm

$n =$ number of storeys where $n > 1$

- Level

Level of floors measured relative to the intended design level at the reference level.

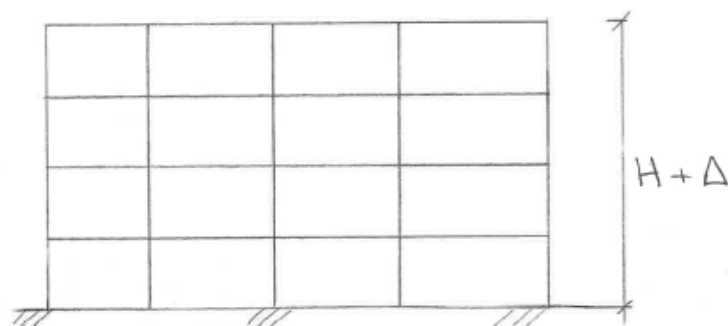

Figure 6.9 Design Level at the Reference Level

Permitted deviation Δ for:

$$H = < 10\text{m} \quad = 15\text{mm}$$

$$10\text{m} < H < 100\text{m} \quad = 0.5 (H+20) \text{ mm}$$

$$H > = 100\text{m} \quad = 0.2 (H+20) \text{ mm}$$

where

H = sum of the intended storey heights in m

6.13 Elements – Columns and Walls

The deviation or sum of any deviations of any individual element must not exceed the overall building structure tolerance given in (Section 6.13.1).

Position of the element centre line relative to:

- At base level, the intended design position.
- At any upper level, the actual location of the element at the level below.

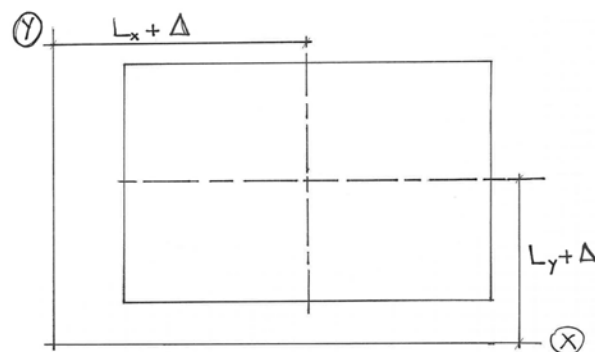

Figure 6.10 Columns and Walls, Position on Plan

Permitted deviation $\Delta = 10 \text{ mm}$, where L = distance to centreline from grid line

Inclination of a column or wall at any level in a single or multi-storey building is illustrated in Figure 6.11.

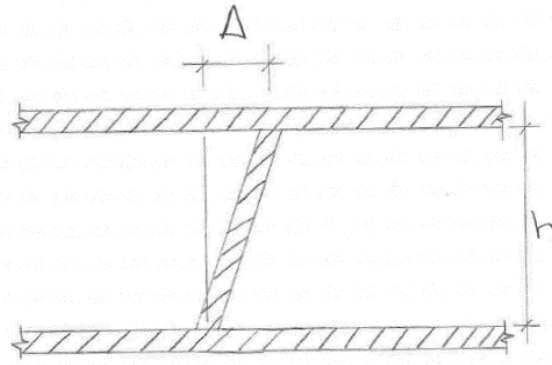

Figure 6.11 Vertically by Storey of the Structure

Permitted deviation Δ for:

$h \leq 10 \text{ m}$ Δ the larger of 15 mm or $h/400$

$h > 10 \text{ m}$ = the larger of 25 mm or $h/600$

where

h = height of element in mm

Offset between floors is illustrated in Figure 6.12.

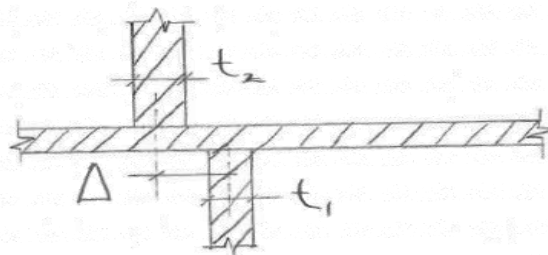

Figure 6.12 Offset between Floors

Permitted deviation Δ = the larger of 10 mm or $t / 30 \text{ mm}$, but not more than 20 mm

where

t = thickness in mm = $(t_1 + t_2) / 2$

Curvature of an element between adjacent storey levels is shown in Figure 6.13.

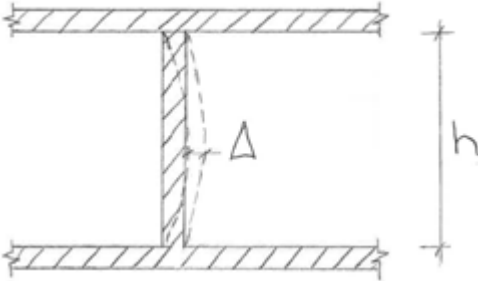

Figure 6.13 Curvature between Adjacent Floors

Permitted deviation Δ for:

$h \leq 10\text{m} = \text{the larger of } 15\text{mm or } h / 400$

$h > 10\text{ m} = \text{the larger of } 25\text{ mm or } h / 600$

where $h = \text{height of element in mm}$

Level of adjacent floors at supports is shown in Figure 6.14.

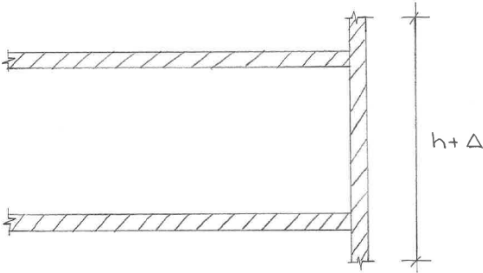

Figure 6.14 Curvature between Adjacent Floors, Side View

Permitted deviation $\Delta = 10\text{ mm}$, where $h = \text{storey height in mm}$

Distance between adjacent columns and walls, measured at corresponding points as shown in Figure 6.15.

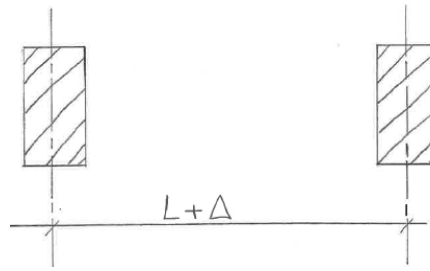

Figure 6.15 Distance between Adjacent Columns and Walls

Permitted deviation Δ = the larger of 20 mm or $L / 600$ mm, but not more than **20 mm**, where L = the distance between centrelines, in mm.

6.14 Elements – Beams and Slabs

Location of a beam to column connection measured relative to the column, as illustrated in Figure 6.16.

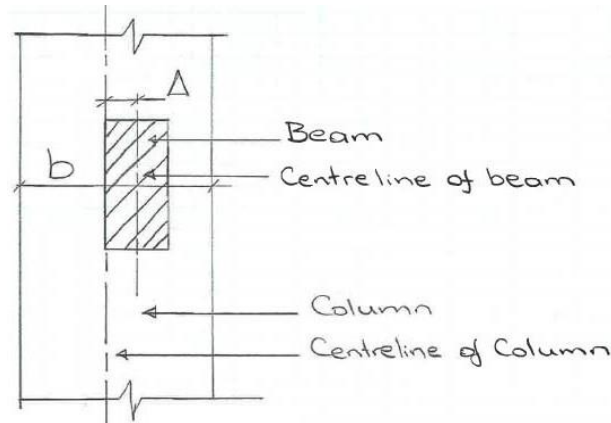

Figure 6.16 Location of Beam to Column Connection

Permitted deviation Δ = the larger of 20 mm or $b / 30$ mm, where b = the dimension of a column in the same direction as Δ in mm.

Position of bearing axis of support when structural bearings are used, as shown in Figure 6.17.

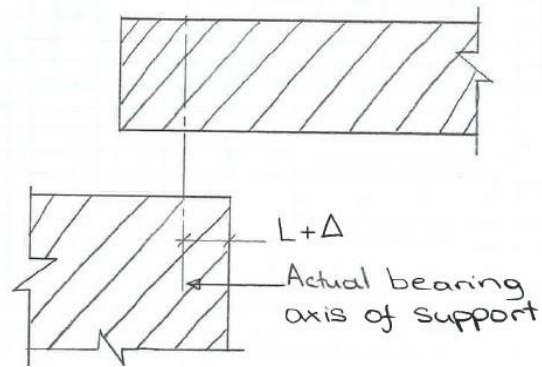

Figure 6.17 Position of Bearing Axis of Support

Permitted deviation Δ = the larger of 15 mm or $L / 20$ mm where L = the intended distance from edge in mm.

Figure 6.18 illustrates the horizontal straightness of beams.

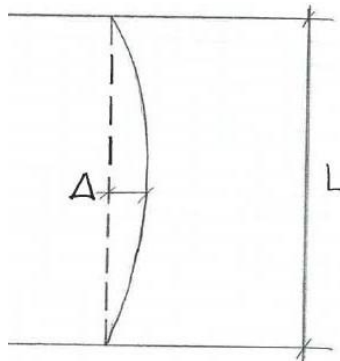

Figure 6.18 Straightness of Beams

Permitted deviation Δ = the larger of 15 mm or $L / 600$ mm, where L = the distance between supports.

Distance between adjacent beams, measured at corresponding points is illustrated in Figure 6.19 below.

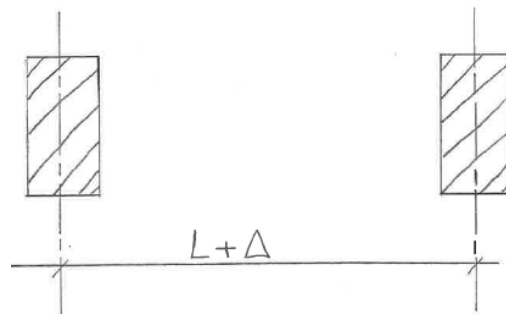

Figure 6.19 Distance between Adjacent Beams

Permitted deviation Δ = the larger of 20 mm or $L / 600$ mm but not more than 40 mm, where L = the distance between supports centre lines in mm.

The difference in level across a beam or slab at corresponding points in any direction is illustrated in Figure 6.20 below.

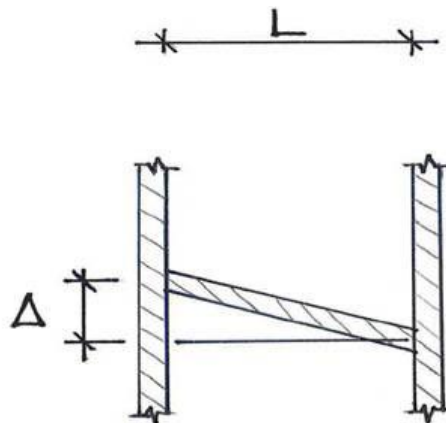

Figure 6.20 Inclination of Beams or Slab

Permitted deviation $\Delta = (10 + l / 500)$ mm, where L = span of element in mm.

The level of adjacent beams measured at corresponding points is shown in Figure 6.21 below.

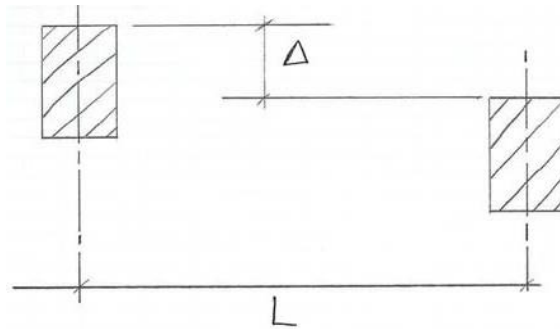

Figure 6.21 Level of Adjacent Beams

Permitted deviation $\Delta = (10 + L / 500)$ mm, where L = the distance between support centrelines in mm.

The position of the slab edge is illustrated in Figure 6.22 below.

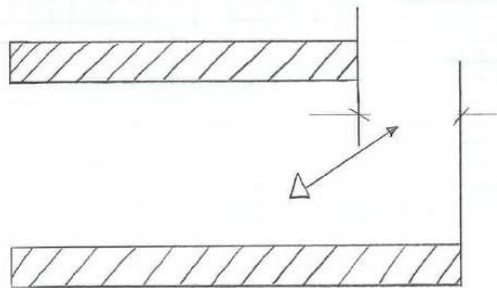

Figure 6.22 Position of Slab Edge

Permitted deviation $\Delta = 10$ mm.

6.15 Section Elements

Application to beams, columns and other elements covering length, breadth and depth.

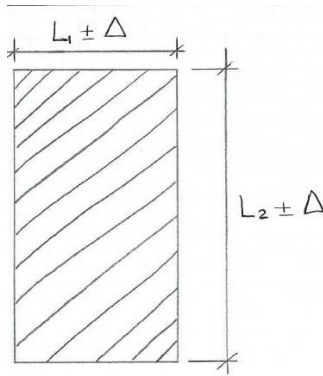

Figure 6.23 Cross-Section Beam, Colum and others Dimension of Elements

Permitted deviation $\Delta =$

$$L = 150 \text{ mm} \quad \Delta = 10 \text{ mm}$$

$$L = 400 \text{ mm} \quad \Delta = 10 \text{ mm}$$

$$L = 2500 \text{ mm} \quad \Delta = 20 \text{ mm}$$

With linear interpolation for intermediate values, where $l_1, l_2 =$ intended dimensions.

Applicable to beams, slabs, columns and other elements are illustrated in Figure 6.24 below.

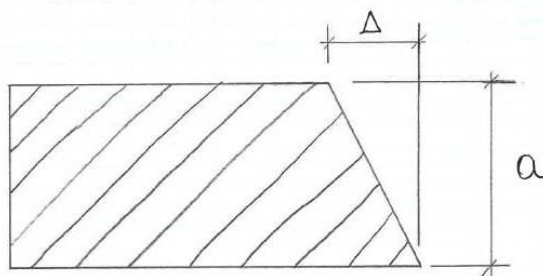

Figure 6.24 Cross-Section Slab, Beam and others Dimension of Elements

Permitted deviation $\Delta =$ the larger of 10 mm or $a / 25$ mm, but not more than 20 mm

where

$a =$ length in mm

6.16 Position of Reinforcement within Elements

Gives the tolerance of cover to reinforcement within an element as shown in Figure 6.25 below.

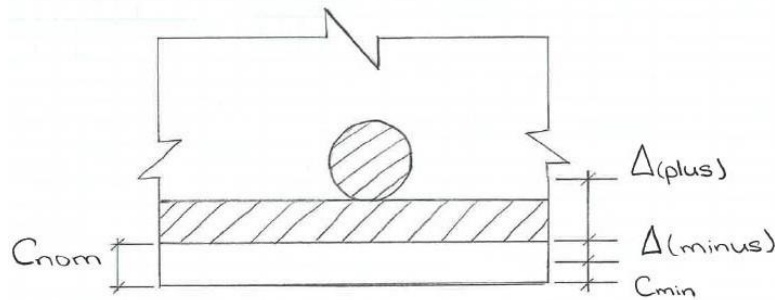

Figure 6.25 Cross-Sectional of Cover Dimension of Elements

Permitted deviation $\Delta_{(plus)}$ for

$$h \leq 150 \text{ mm} = +10 \text{ mm}$$

$$h \leq 400 \text{ mm} = +15 \text{ mm}$$

$$h \leq 2500 \text{ mm} = +20 \text{ mm}$$

Permitted deviation $\Delta_{(minus)} = 10 \text{ mm}$

where

c_{min} = required minimum cover

c_{nom} = nominal cover given on drawings

Δ = permitted deviation from c_{min}

H = height of cross-section

For foundation and members in foundations, permitted plus – deviations may be increased by 15 mm. The given minus-deviations apply.

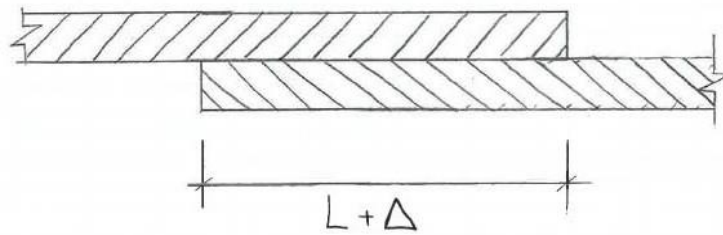

Figure 6.26 Length of Reinforcement Lap Joints

Permitted minus-deviation $\Delta = 0.06 L$ mm

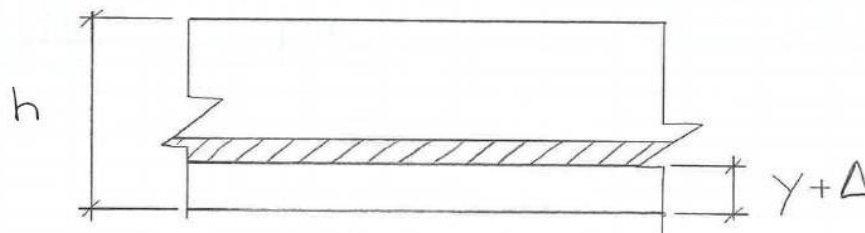

Figure 6.27 Location of Reinforcement and Ducts in Pre-stressed Elements

- Anchorages

Permitted location deviation Δ

= 25 mm horizontally

= 5 mm vertically

- Tendons

Permitted location deviation Δ

Horizontal

In beams = $0.03h$ (width) ≥ 5 mm = 30 mm

In slabs = 150 mm

Vertically

$$\Delta_{(plus)} \text{ if } h < 200 \text{ mm} = +h/40$$

$$\text{if } h < 200 \text{ mm} = +15 \text{ mm}$$

$$\Delta_{(minus)} \text{ all } h = -10 \text{ mm}$$

where

h for vertical section = depth in mm

h for plan section = width in mm

y =intended location in mm

6.17 Surface Straightness

In the Robert Bird Group specification and structural design analysis the following calculation has been certified

6.17.1 Flatness

The flatness of the surface of any element is illustrated in Figure 6.28 below.

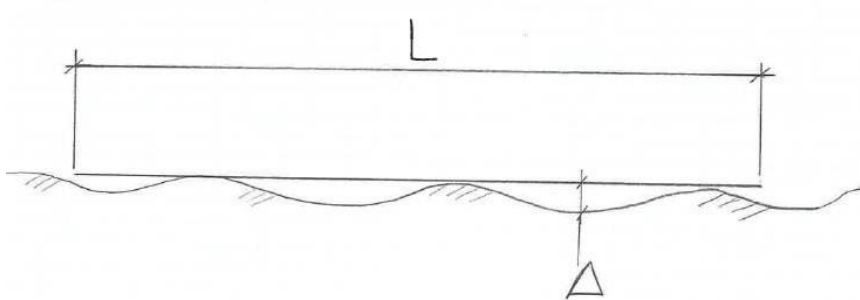

Figure 6.28 Flatness

- Basic unformed surface (Cl. 8.6.2.1 of NSCS)

Permitted global deviation $\Delta = 12 \text{ mm}$

Permitted local deviation = 5 mm

- Ordinary unformed surface (Cl. 8.6.2.2 of NSCS)

Permitted global deviation $\Delta = 9 \text{ mm}$

Permitted local deviation $\Delta = 3 \text{ mm}$

- Ordinary surface (Cl. 8.6.1.2 of NSCS)

Permitted global deviation $\Delta = 9 \text{ mm}$

Permitted local deviation $\Delta = 5 \text{ mm}$

- Plain surface (Cl. 8.6.1.3 of NSCS)

Permitted global deviation $\Delta = 9 \text{ mm}$

Permitted local deviation $\Delta = 3 \text{ mm}$

6.17.2 Edge Straightness

The straightness of the edge of a floor slab or element is shown in Figure 6.29 below.

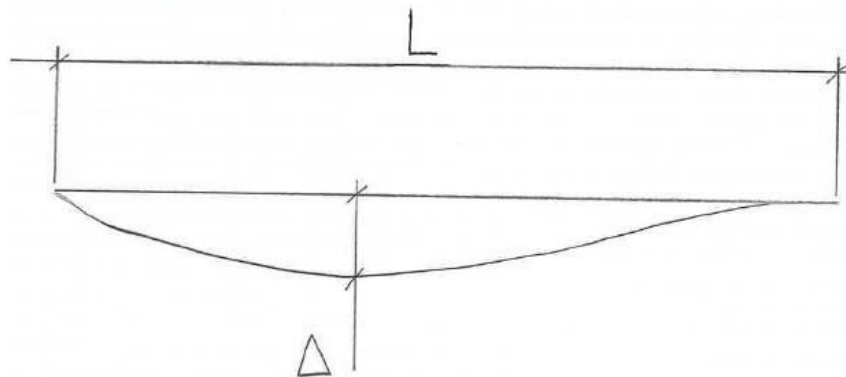

Figure 6.29 Edge Straightness

Permitted deviation Δ for

$L < 1\text{m} = 8 \text{ mm}$

$L > 1\text{m} = 8 \text{ mm/m}$, but no greater than 20 mm

Where L = length of edge

6.18 Discussion of Allowable Tolerances

This chapter specifies the allowable tolerances that the primary structural frame will be constructed to achieve, as well as describing the movements that the structure will experience during construction and the life of the building.

This chapter is intended to analyse the allowable positional variation of the structure due to movement and construction tolerance, and to inform what structural movements need to be allowed for in follow-on trade-offs and interfaces.

Section 2 of this chapter presents a summary of information regarding the scope of this study and about the buildings forming the MP1 scheme at Elephant & Castle, London.

Section 3 sets out the construction and tolerance requirements that the frame contractor had built to. Reference is also required to the tolerance where this had been modified from those specified by Construct National Structural Concrete Specification for Building Construction NSCS (2010). The implications of the construction tolerances are discussed, along with project specific tolerance requirements. It is recorded that some of the NSCS construction tolerance allowances have been made more onerous for this project.

Section 4 describes the loads that the structure is designed for, and how they cause the structure to move and deflect. Section 5 records the limitations of the movement assessment.

Section 6 discusses pre-cambering and pre-setting.

Section 7 records the construction programme and construction sequence assumptions which have been made as part in the assessment of building movements. It is noted that different construction programmes and sequences will change the building movements.

Usually, deterioration may be linked to water permeating the reinforced concrete, therefore the chances for this to occur may be reduced by considering good architectural requirements with sufficient drainage and protection of reinforced concrete sections.

Permeability is an essential feature of the concrete section that has an effect on durability. In some cases, however, it is important to take into account chemical and physical influences that will cause the reinforced concrete section to decay.

In concrete, a further necessary aspect of durability is the quality of protection that is applied to the reinforcement. Carbonation by weather may, in time, damage the alkalinity of the concrete surface, and if this expands the layer of reinforcement it may render the reinforcement steel vulnerable to corrosion due to the presence of oxygen and water.

When a concrete mixture is made with a sound inert aggregate, damage may not happen in the absence of an external effect. Since concrete is an extremely alkaline material, its durability to other alkalines is quite reasonable, however, it is very sensitive to attack by chemical acids or material that readily decompose to produce chemical acids. Concrete mixtures produced with Portland cements, are therefore not appropriate for use in cases where it comes into direct contact with these materials, which include fats, milk and beer.

Several natural salts could also attack concrete mixture, the two most widely noted being soluble sulphates and calcium chloride. These interact with a small constituent of the hydration products in various manners. The chloride should be in intensified solution, when it has a solvent impact on the concrete mixture in addition to its further most notable behaviour in promoting the corrosion of steel. Sulphates are only required to exist in quite small quantities to produce internal expansion of concrete with consequent cracking and strength damage.

Sulphates are the most common form of chemical attack issue for concrete mixtures because they will occur in sewage and groundwater. In such circumstances cements containing reduced elements of the vulnerable tricalcium aluminate, like sulphate resistant Portland cement, may be used. The addition of ground granulated blast furnace slag (GGBFS) or Pulverised Fuel Ash (Pfa) could also be advantageous.

Both sulphates and chlorides are present in sea water, and therefore the chemical actions vary, resulting in decreased sulphate loss. In spite of the fact that if the concrete is of poor quality, extreme loss could occur from the interaction of soluble magnesium with the hydrated compositions, well-formed Portland cement shapes have nonetheless been shown to be able to endure sea water (salty water) over the long term.

The problem of exposure classifications relevant to environmental situations is dealt with in detail in BS EN 206 (2013), BS 8500-1 (2015) and BS 8500-2 (2015) together with the provision of convenient concrete materials. BS 8500-2 (2015) recommends the exercise of a regulation of classification of the wide range of chemically extreme environments based on suggestions made by the UK Building Research Establishment (BRE Special Digest 1 2005).

In some circumstances liable to aggressive chemical attack Additional Protection Measures (APMs) such as determined surface protection, permeability formwork, site drainage or sacrificial layers could be suggested.

Bearing in mind the physical attack of the reinforced concrete section may also be examined, this may occur due to attrition or abrasion as may happen in shingle or sand, and by dry and alternate wetting. The final influence is of more significance in marine structures close to the water surface, and leads to stress developing if the actions generated are restrained. In addition it may be possible for crystal growth to develop from the drying out of salty sea water in pores and cracks, and this may lead to more internal stresses, and eventually cracking. Alternate thawing and freezing could also be another reason for physical loss, especially in runway slabs and roads and also in some situations where water in cracks and pores may freeze and expand, then causing to spalling.

It has been acknowledged that entrainment of a tiny percentage of air in the reinforced concrete section in the shape of tiny discrete bubbles gives the maximum effective protection against this types of attack. In spite of the fact that this reduction may reduce the strength of the reinforced concrete section, it is suggested by Eurocode 2 (2008) that between 4.0 and 6.0 per cent by volume of entrained air may be included in reinforced concrete sections that are expected to be subjected to drying and wetting together with extreme frost.

All these types of attack could be reduced by the production of a dense, well-cured concrete that is well-compacted with minimum permeability, thereby restricting loss to the surface area of the concrete section. Aggregates which can potentially react with the alkali matrix may be prevented or may be carefully controlled and limited, as

should those that exhibit abnormally high shrinkage characteristics. If this is done, permeability and then durability is influenced by:

- degree of compaction
- water cement ratio
- degree of hydration of cement
- aggregate form and density

A low water cement ratio is important to control the voids caused by hydration, which should be well advanced with the help of good curing methods. BS EN 206 (2013) suggests minimum curing times considering ambient conditions, concrete temperature, and concrete strength development rate and exposure classification. In addition, there is a demand for non-pour aggregates which resist attrition, and for adequate compaction. It is important that the mix is examined to have appropriate workability for the conditions in which it is to be used, and for this preseasoning of the cement content of the mix should be reasonably high.

BS EN 206 (2013) determines minimum cement contents for different exposure circumstances referring to cement types, in addition to the minimum strength and maximum water cement ratios which may be associated with minimum cover details as explained previously.

The outcome of thermal impact on durability may not be underestimated or ignored, and high cement content may only be applied in conjunction with a required cracking assessment. A cement content of 550 kg/m^3 is considered as an upper limit for common application.

Given that such calculations are considered, and that appropriate cover of sound concrete is provided to the reinforcement, decay of concrete is improbable. Even the

surface concrete could be influenced, therefore, and the steel may keep protected by an alkaline concrete matrix which has not been carbonated by the weather conditions. When this cover breaks down and chemicals and water can reach the reinforced steel, corrosion, rusting and consequent expansion cause sudden cracking and spalling of the cover concrete and can eventually cause serious damage, both visually and structurally, in some circumstances.

Steel and concrete in the shape of reinforcement or prestressed tendons offer reduced strength after being exposed to high temperatures. In spite of the fact that concrete has low thermal conductivity, and therefore good resistance to temperature rise, the strength starts to decrease significantly at temperatures above 300 °C and it has an inclination to spall at high temperatures. The range of this spalling is controlled by the type of aggregate, with siliceous materials being quite susceptible, whereas calcareous and lightweight aggregate concrete are only affected to a small extent. Steel reinforcement may retain around 50 % of its ordinary strength after reaching around 550 °C, however in case of prestressing tendons the corresponding temperature is 400 °C.

Thence as the temperature increases heat is transferred to the inner part of a concrete section, with a thermal tendency established in the concrete section. This tendency may be influenced by the region and mass of the section and the thermal properties of the concrete section, and will cause expansion and loss of strength. Considering the thickness and nature of cover, steel may increase in temperature and lose strength, hence causing deflections. Therefore, design should be aimed at supplying and maintaining sound cover of concrete as a protection, in order to delay the temperature increase in the reinforcement. The creeds, the presence of plaster and

other non-combustible finishes supports the cover protecting the reinforcement and could be considered in the plan.

Eurocode 2 (2008) indicates tabulated values of minimum dimension and covers for different forms of concrete section that are important to allow the section to resist high temperatures for a specified period of time. These tabulated values, which have been previously presented for siliceous aggregates will be considered sufficient for most usual cases. The period that a section is required to resist, both in regard to the strength in linkage to action loads and the inclusion of high temperature, may rely on the form and purpose of the building and minimum details are usually given by building regulations. Prestressed reinforced concrete sections may be examined separately in view of the grown vulnerability of the prestressing reinforced steel.

The detailing for the durability and serviceability limit state have been previously presented extensively, thus this paragraph is a short review of the elements that apply to the design and requirements of slabs. In spite of the fact that this paragraph is a summary at the end of the chapter it may be underlined that the design for the durability and serviceability limit states is just as necessary as the design for the ultimate limit state. Failures of buildings at the ultimate limit state (ULS) are frankly quite rare but may get a lot of publicity, whilst damage caused by serviceability and durability are much more widespread during the life of a structure and they may easily cause eventual structural damage or be one of the main causes of such damage. In addition poor examination and calculation may be the cause of damage such as damage to glass, windows and finishing, and disfigurement of the doors and floors and thus reduced working life.

Sufficient concrete cover to all the steel bars is crucial to avoid ingress of moisture and corrosion of the reinforced bars with resultant spalling and staining of the reinforced concrete. Cover of the concrete section is likewise needed for fire resistance. The requirement and the sizing of the steel bars and stirrups may take into account the dimensional tolerances during bending and fabrication of the reinforced cages so as to maintain needed concrete cover.

The minimum and maximum spacing of the reinforced bars may meet the specification in Eurocode 2 (2008) so that there is wide room for the flow and compaction of the concrete, however the gap should not be so large that there is a lack of resistance to cracking of the concrete caused by settlement, thermal movement and shrinkage.

For the same reason, the detailing for minimum and maximum percentage of steel in concrete sections needs to be examined.

6.9 Summary

The slab must be sufficiently stiff to avoid excessive deflections that may cause cracking of such features as partitions, glazing and floor finishes. This is quite common with long span slabs and beams or cantilevers. For beam sections, it is not important to work out required deflection calculations. Eurocode 2 (2008) recommends relationships and basic span-to-depth ratios to meet this requirement. Compression reinforced bars in the compression area of the span slabs, beams and cantilevers assist in resisting the long-term deflections caused by creep.

Many of the more commonly used relationships and tables to meet the requirements of Eurocode 2 (2008) are more fully presented.

Adequate working practices and quality control on the construction site are also necessary to guarantee such features are accurately examined and designed for in concrete mixes, ensuring the formwork is fixed and reinforcing bars with compaction and curing of the concrete and sufficient placement.

CHAPTER SEVEN: Discussion and Conclusions

In this thesis, the behaviour of restrained concrete slabs under load has been investigated. The focus of the research is the establishment and comparison of the serviceability limit state.

7.1 Aims of the Study

This research aims to provide a better understanding of reinforced concrete slab deflection.

This research aims to document the deflection of a concrete slab in a large residential building. The intention is to note any serviceability issues and to compare design models and assumptions with reality.

7.2 Deflection Limits

Limits on deformation were set many decades ago, when the forms of construction, partitions, finishes, cladding and service were very different from what they are now. It is possible, therefore, that the current limits are too conservative. In order to justify change, and enable more sustainable and economic designs, knowledge of the background to current limits and of current performance is needed. Part of that is to review the span-to-depth method of design.

Current design limits on deformation, such as Eurocode 2 are based on limits set many decades ago in ET ISO 4356 -1977 (2012), when the forms of construction, partitions, finishes, cladding, and services were very different to what they are now. It is possible, therefore, that the current limits are too conservative, and more research is thus needed to understand current performance in order to enable more sustainable and economic designs.

7.3 Methods of Controlling Deflection and Achievements

This research reviews the derivation of a technique for controlling deflections in the design of reinforced concrete slabs by using ratios of span to effective depth. This study shows how more current research permits considerable simplification of the original proposals while increasing their general accuracy.

The achievements of this research are:

- Obtained new accurate deflection data from a commercial building site, using various methods, including Hydrostatic Cells Levelling (HCL) and Precise Levelling.
- Comparing Hydrostatic Cells Levelling (HCL) and Precise Levelling results with (Bentley & Etabs) design software.
- Calibrated the Eurocode 2 rigorous method.

7.4 Contributions of the Study

The contribution of this research is answering the most fundamental deflection questions as below

- What are the traditional $L/250$ and $L/500$ deflection limits values based on?
Current design limits on deformation, such as Eurocode 2 are based on limits set many decades ago in ET ISO 4356 -1977 (2012).
- These values still adequate for modern structures according to site investigation of this research.

Site investigation and testing theory through observation and data collection was the main objectives of this research.

The appearance and usual utility of the building may be adversely affected when the computed sag of a beam, slab or cantilever subjected to quasi-permanent actions exceeds $\text{span}/250$. The sag is estimated close to the supports. Precamber could be considered to compensate for some or all of the deformation, but any upward deformation incorporated in the formwork could not usually exceed $\text{span}/250$.

Deformations that may damage adjacent parts of the building should be limited. For the deformation after construction, $\text{span}/500$ is generally an adequate limit for quasi-permanent actions. Other limits could be taken into account, relying on the sensitivity of adjacent parts.

The limit state of deflection could be examined by either:

- Limiting the span/depth ratio, or
- Comparing a calculated deflection with a limit value

7.5 Limitations

The actual deflections may vary from the calculated values, especially if the values of the moments used are relative to the calculating moment. The variation may rely on the dispersion of the material properties, on the environmental circumstances, on the action record, on the reinforcements at the supports and ground situation.

Determining deflections are usually presented as $\text{span}/250$ for overall deflection, and for deflection after non – structural installation, the determining deflection is $\text{span}/500$. Realistically, the codes set ultimate limitations but achieving the $\text{span}/250$ limitation is Eurocodes's objective. Hence, modular construction may demand accurate measurements and estimates of deflection.

The grillage and finite element methods are generally considered to be functional methods to obtain actual values of deflections. Limiting quasi-permanent / long-term deflection to $\text{span}/250$ is normal unless a specific demand is required, but if cladding or brittle partitions are being supported, control of the motion is set to $\text{span}/500$. In such circumstances it is necessary to execute a supplementary programme to estimate deflection values.

Technical Report no.67 (2008) recommends the shortening of a panel of columns (various concrete strengths and restraint percentages) and concludes that an ultimate shortening of 1.4mm/m is possible, for instance 4 – 5 mm in a typical structure height. The report indicates that it is hard to reduce the shortening considerable. A better technique is to limit the differential shortening by calculating all reinforced concrete columns to the same standard, and by conserving long obvious spans between various structural shapes, for instance between interior reinforced concrete columns and shear walls and cores on the one side and perimeter concrete columns on the other.

7.6 Standard Code of Design

Standard codes of design rules concentrate on structure to withstand externally applied actions, deriving the restraint needed to withstand axial actions, shear stresses and bending moments. Many reinforced concrete sections, however, are lightly loaded or are influenced especially by other loads, such as early-age shrinkages, creep, temperature and humidity effects and long-term drying shrinkage. These all produce movements, and although they hardly define the total capacity they do affect serviceability, especially through cracking. The Technical Report no.67 takes into account the different forms of movement and their constriction time.

Any deflection or cracking is generally at least the outcome of temperature and shrinkage added to early-age effects, and predominantly with assistances from other origin. The significant of movement is very dependent on whether it is reinforced or not; all reinforcement is partial as reinforcements will normally apply under the significant stresses that may be produced. In addition, creep is useful in decreasing the stresses generated by reinforcement, particularly at early ages. The probability of cracking occurring is hard to estimate, and the technique suggested by the Report is to predict that cracks will develop and to apply adequate restraint to control them.

7.7 Monitoring Slab Deflection

The Hydraulic Cell Levelling System monitoring vertical movement and temperature at Elephant and Castle site were removed from the block HC10 third floor slab in early January 2016 after 142 days of observing deflection on the slab using eight cells.

The result of deflections and temperatures are demonstrated in Figures and graphs supported with Finite Elements models.

The data indicate that the slab has not sagged much due to the back propping for 30 days. It does seem, however, that the slab was sloping down from the corner by 6 mm diagonally across the 12m bay due to column shortening.

A margin of deflection around 2 mm occurred, especially in the mid-span of the slab 12 x 7 m corner bay in block H10C, particularly on cell no. 6 and cell no. 7, the 2 mm deflection occurred at the beginning of the investigation after back propping the reinforced concrete corner bay slab. The back propping was applied seven days after pouring the slab.

The slab monitoring started from a very early stage in the casting when the slab was still wet. The Hydraulic Levelling Cells were positioned under the slab while the

workers were pouring the rest of the 3rd floor on the top. The indication suggests that the slab has been deformed by 2 mm, and it can be seen that the deflection started developing very slowly. Starting from 0 mm to 0.51 mm, and then by day 142 ending up with 2 mm.

7.8 Lessons Learnt

Deformations that may damage adjacent parts of the building could be limited. For the deformation after construction, span/500 is generally an adequate limit for quasi-permanent actions. Other limits could be considered, relying on the sensibility of adjacent parts.

- Personal lessons learnt as a researcher: as researcher patience developed as a motivation and encouragements though out research period.
- Lessons learnt in contacting research: developed technique and methodology in order to link and contact research purposes, thought out data collection on construction site and writing thesis development.

7.9 Future Work and Recommendations

The material properties need to be confirmed and tested to determine time dependent deflection. This cannot be considered as an effective alternative, however: structural engineers rarely have the time or the inclination for long term laboratory tests. Moreover, it is not guaranteed that the concrete material used on the construction site is the same as the test sample used in the laboratory. In fact, the computed deflection property of concrete is more often larger than the actual property, with coefficients of difference of more than 20 per cent sometimes. Hence, a probabilistic approach is needed in construction design to obtain better concrete properties, and the outcome of such methods needs to be considered.

Serviceability limitations for deflection in respect to pre-stressed and reinforced slab structures may be defined using several methods, from cracking control according to various codes of design and deflection limitation using either simple, or more advanced and refined methods. When designing methods to calculate serviceability in concrete slab building it is important to include the effect of shrinkage and creep on structures. In addition, a clearer understanding of concrete slab behaviour may be obtained from advanced analytical methods, for instance using different methods to monitor deflection on concrete slabs

7.10 Conclusions

The conclusions of the site investigation are that the Eurocode 2 tabulated deflection values and calculation methods are acceptable, and the span-to-depth ratio method is adequate to calculate the deflection. The thickness of the slab can be reduced, however, and the amount of reduction needs to be studied very carefully by using various methods to calculate deflection of concrete slabs and this could itself be a research topic.

The contribution of this study is that the Current Performance and the Design Deflection Limits to the Eurocode 2 calculations and tabulated values are acceptable.

It is highly recommended that this research project should continue by using different methods and techniques to investigate and calculate the deflection on reinforced concrete slabs for longer periods of 1-3 years. It is possible that if the investigation is carried out for longer by using various equipment and methods, this will give more data instead of using the Hydraulic Cell Levelling system only.

The research is carried out using a comparison study between various methods of deflection calculation and site investigation results to obtain the final outcome of

Current Performance and the Design Deflection Limits to the Eurocode 2 from different methods.

Design can be made to accommodate the deflection of structural members without causing damage to partitions or finishes. The problem can be tackled by considering immediate and long-time deflections separately.

Many techniques and methods of deflection calculation have been reviewed and studied carefully for each case. The effect of cracking on reinforced concrete flat slabs has been examined and reviewed closely.

Site investigation measurements for determining and controlling deflection of flat slabs have been reviewed and examined.

Various design code limitations have also been covered and evaluated in respect to deflection control.

The deflection of a section or building may not be such that it adversely affects its appearance or adequate performance. Appropriate limiting values of deformation considering the type and shape of the structure, of the finishes, partitions and fixings and upon the purpose of the structure may be determined.

Deflections must not exceed those that may be accommodated by other connected sections such as partitions, glazing, cladding, services or finishes. For instance, limitation could be demanded to ensure the proper operation of machinery or equipment supported by the building, or to prevent ponding on flat roofs.

The limiting deformation expressed below are derived from ISO 4356 - 1977 (2012) and may usually result in acceptable performance of structures such as dwellings,

offices, public structures or factories. Care may be considered to guarantee that the limits are adequate for the specific building and that there are no special demands.

The appearance and usual utility of the building may deteriorate when the computed sag of a beam, slab or cantilever subjected to quasi-permanent actions exceeds $\text{span}/250$. The sag is estimated close to the supports. Precamber could be considered to compensate for some or all of the deformation, however any upward deformation incorporated in the formwork should not usually exceed $\text{span}/250$.

Deformations that may damage adjacent parts of the building could be limited. For the deformation after construction, $\text{span}/500$ is generally an adequate limit for quasi-permanent actions. Other limits could be taken into account, relying on the sensibility of adjacent parts.

The limit state of deflection could be examined by either:

- Limiting the span/depth ratio, or
- Comparing a calculated deflection with a limit value

The actual deflections may vary from the calculated values, especially if the values of used moments are relative to the calculating moment. The variation may rely on the dispersion of the material properties, on the environmental circumstances, on the action record, or on the reinforcements at the supports and ground situation.

Any deflection or cracking is generally at least the outcome of temperature and shrinkage added to early-age effects, and often with contributions by other factors. The significance of movement is very dependent on whether it is reinforced or not; all reinforcement is partial as reinforcements will normally apply under the significant stresses that may be produced. In addition, creep is useful in decreasing the stresses

generated by reinforcement, particularly at early ages. The probability of cracking occurring is very hard to estimate, and the technique suggested by the thesis is to predict that cracks will develop and to apply adequate restraint to control them.

Generally, the first method (the permissible stress method) is no longer in use, although it remains a useful and simple method. Due to serious inconsistencies and based on distribution of elastic stress, this method is not applicable for concrete which is considered a semi-plastic material, nor is it usable if the deformations and loads are not proportional as in slender columns. In addition, the permissible stress method has been found to be unsafe in terms of stability of the structures, when the structures are under overturning loads.

In the second method (the load factor method), use of the material's ultimate strength is considered in the calculation. No safety factor is applied in this method to the material stresses, also it has no ability to consider the material's variability and, most importantly, this method cannot be recommended for calculating the cracking and deflection at actual load. As a result, this method also been superseded by more effective and moderate methods of limit state design.

The third method (the limit state design) is more popular and widely adapted within Europe because it overcomes the disadvantages of the two previous methods (the permissible stress method and the load factor method) by applying the safety partial factors to the loads and to the strengths of the material. In addition, the bulk of the factors could be diversified to be applied either in the ultimate state with the plastic status or at working load with the further range of elastic stress. It is important for such flexibility to obtain the full benefits from concrete's improvement and the properties of steel.

The objective of design is to achieve acceptable probabilities, that a building may not become unsuitable for its purposed use: that is, that it may not achieve a limit state. Any way in which a building may cease to be comfortable for use may constitute a limit state and the structure's aim is to avoid any such situation being achieved throughout the expected life of the building

Structures should have ability to withstand any collapse that may occur due to load actions and activities. The design should ensure the health and safety of the structure's occupants. The likelihood of overturning and buckling has to be considered in the design structure, as well as internal forces, such as explosions.

The most significant serviceability limit states can be described as:

- Deflection, the comfort of the structure users should not be adversely affected nor should the appearance or the efficiency of partitions and any other part of the structure be adversely affected
- Cracking, the efficiency, appearance and the structure's durability should not be affected by the damage caused by cracking
- Durability, in terms of the expected life of the structure and the structure's conditions of exposure. The durability has to be considered in design limits.

The limit states may also include:

- Fatigue, which needs to be taken into account if there is any possibility of cyclic loading
- Excessive vibration, which must be considered to avoid any discomfort that may cause damage and alarm

- Fire resistance, should be taken into account in terms of flame penetration, heat transfer and resistance to collapse
- Particular conditions; any other special circumstances may apply to the structures that are not included by other common limit states; for instance, seismic loads should be considered in design on demand

The proportional significance of any limit state may vary depending on the shape and form of the structures. The normal process of structural design is to identify which limit state is the crucial procedure for a specific structure to design for, since the demands of fire resistance and durability may affect the initial size of members and the selection of the right concrete class. In addition, all other pertinent limit states should be checked to ensure all limit states are satisfied by the outcomes obtained. Water retaining structures are excluded as a special cases, however, and hence the ultimate state is normally critical for concrete reinforcement in spite of subsequent checks of serviceability which may influence details of the structural design.

Generally, the design of prestressed concrete depends on the conditions of serviceability and ultimate limit state design. It is important to consider all possibilities of variable parameters to assess a specific limit state, such as material strength, all constructional tolerances and all loads for the structure.

This study evaluated column shortening in mid-rise reinforced concrete multi-story building, with focus on the effects of ambient temperature, relative humidity, cement hardening speed and aggregate type. The study approach used The Concrete Centre model for column shortening prediction produced insightful results.

The results indicate that the impact of the temperature on the total net shortening of columns need to be considered as negligible compared to that of the various factors

suggested. Nonetheless, to reduce the shortening of the columns in the study, observation should be given to the erection of the structure in warmer weather when possible.

This study also states that the overall net shortening of columns can be reduced by 20% to 10% in 12-and 24-storey structures by increasing the relative humidity from 50% to 80%. Additionally, cement hardening speed can be taken in to account as insignificant for structures up to 24-storey. However, in the case of a 12-storey structures, the impact of cement type on total net column shortening becomes essential.

Finally, the results also suggest that the aggregate type used when compared with the other factors considered has the most essential effect on column shortening. Changing the aggregate type can change the shortening by 27% with an ambient temperature of 5°C and 29% with an ambient temperature of 30°C.

The results of this study indicate that environmental factors that are the least controllable have less significant effect on column shortening. Column shortening can be significantly reduced by modifying controllable parameters such as the cement and aggregate types.

References

ACI Committee 209, (2008). *Guide for Modeling and Calculating Shrinkage and Creep in Hardened Concrete (Technical Report 209.2R-08)*, s.l.: American Concrete Institute.

Acker, P., (2003). Sur les Origines du Retrait et du Fluage du Béton. *Revue Française de Génie Civil*, Volume 7, pp. 761-776.

Agarwal, R. K. and Gardner, Noel, J. (1974) Form and Prop Requirements for Multistorey Flat Slab Type Buildings. *American Concrete Institute (ACI) Journal*, 71(11), p.559 - 569.

Akbas, D. S. (2015) Structural engineering and mechanics: large deflection analysis of edge cracked simple supported beams. *Journal of Techno press*, 54(4), p.433.

American Concrete Institute (ACI) (1982) *Deflection of Two - Way Reinforced Concrete Floor System. Deflection of Concrete Structures*. Detroit: American Concrete Institute (ACI) Committee.

American Concrete Institute (ACI) (1982) Prediction of Creep, Shrinkage, and Temperature Effects in Concrete Structures. Designing for Creep and Shrinkage in Concrete Structures. *American Concrete Institute (ACI) Committee Journal*, Detroit, p. 193 - 300.

American Concrete Institute (ACI) (1983), Building Code Requirements for Reinforced Concrete. *American Concrete Institute (ACI) Committee Journal*, Detroit, p.111.

Aslani, F., (2015). Creep behaviour of normal- and high-strength self-compacting concrete. *Structural Engineering and Mechanics*, 53(5), pp.921–938.

Atkins, R. M., Simpkins, P. G. and Yablon, A. D. (2016) Track of a fiber fuse: a rayleigh instability in optical waveguides. *Optics Letter*, 28(12), p. 974-976. *The optical society* [Online]. Available at: www.osapublication.org.uk [Accessed: 11 April 2016].

Baidya, N. & Mendis, P., (2010). *Monitoring of a Tall Building to Develop Axial Shortening Models Incorporating High Strength Concrete*. Melbourne, Victoria University.

Bazant, Z. & Baweja, S., (1995). Justification and Refinements of Model B3 for Concrete and Shrinkage 2. Updating and Theoretical Basis. *Materials and Structures*, 28(4), pp. 488-495

Bazant, Z. P., Wittmann, F. H., Kim, J. K. & Alou, F., (1987). *Statistical Extrapolation of Shrinkage Data- Part 1: Regression*. *ACI Materials Journal*, Issue 84, pp. 20-34.

British Standards Institution (BS 5606) (1990) *Guide to accuracy in building*. London: British Standards Institution (BSI).

British Standards Institution (BSI) (1991) *Action on structures*. London: British Standards Institution.

British Standards Institution (2014). *BS EN 1992-1-1:2004 Eurocode 2 : Design of concrete structures – Part 1-1: General rules for buildings*. London: British Standards Institution.

Beeby, A. W. And Narayanan, R. S. (1995) *Designers' handbook to Eurocode 2*. London: Thomas Telford.

Beeby, A. W. and Miles, J. R. (1969) Proposals for The Control of Deflection in The New Unified Code, *Concrete*, 3(3), p.101-110.

Beeby, A. W. (1971) Modified proposal for controlling deflections by means of ratios of span to effective depth. *Cement and Concrete Association, Technical Report 42*, p.456.

Beeby, A. W. (2001) Criteria for Slab Loading, *Proceeding of the Institution of Civil Engineers, Structural and Buildings*, 146(2), p.195-202.

Beeby, A. W. (1979) The prediction of crack widths in harden concrete. *Structural Engineer*, 47, p.3-15.

Beeby, A. W., Scott, R. H. and Jones, A. E. K. (2005) Revised Code Provisions for Long-Term Deflection Calculation, *Proceeding of the Institution of Civil Engineers, Structural and Buildings*, 158(1), p.71-75.

Blakey, F. A. (1961) Deformations of an Experimental Lightweight Flat Plate Structure. *The Institution of Engineering*, 3(1), 18 - 24.

Blakey, F. A. (1963) Australian Experiments with Flat Plates. *American Concrete Institute (ACI) Journal*, 60(4), p.515 - 525.

Blakey, F. A. and Beresford, F. D. (1965) Stripping of Formwork for Concrete in Building Relation to Structural Design. *Civil Engineering Transactions*, The Institution of Engineers, Australia, 7(2), p.92 - 96.

Branson, D. E. (1963) Instantaneous and Time - Dependent Deflections of Simple and Continuous Reinforced Concrete Beams. *Alabama Highway Department Bureau of Public Roads*, 7(1), p.1 - 78.

Branson, D. E. (1977) *Deformation of Concrete Structures*. New York: McGraw - Hill Book Company.

British Cement Association (2001) *Early striking and improved backpropping for efficient flat slab construction*. Berkshire: British Cement Association.

British Standards Institution. (1965) The structural use of reinforced concrete in building. *The Council for Codes of Practice*, 114, p. 95.

British Standards Institution. (1969) The structural use of concrete. *The Council for Codes of Practice*.

British Standards Institution (BS EN 1992-1-1) (2004) *Eurocode 2 Design of concrete structures, General rules and rules for building*. London: British Standards Institution (BSI).

British Standards Institution (BS 8110-1) (1997) *Structural use of concrete – code of practice for design and construction*. London: British Standards Institution (BSI).

British Standards Institution (BS 5606) (1990) *Guide to accuracy in building*. London: British Standards Institution (BSI).

British Standards Institution (BS 8500-1) (2015) *Concrete. Complementary British Standard to BS EN 206. Method of specifying and guidance for the specifier*. London: British Standards Institution (BSI).

British Standards Institution (BS 8500-2) (2015) *Concrete. Complementary British Standard to BS EN 206. Specification for constituent materials and concrete*. London: British Standards Institution (BSI).

British Standards Institution (2002) *Basis of structural design*. London: British Standards Institution (BSI).

British Standards Institution (2006) *Background paper to the uk national annex to bs en 1992*. London: British Standards Institution (BSI).

BS EN 1990 Eurocode 0 (2008) *Basic of structural design*. London: British Standard Institution.

BS EN 1991-1-1 Eurocode 1 (2002) *Action on structures*. London: British Standard Institution.

BS EN 1992-1-1 Eurocode 2 (2008) *Design of concrete structure – Part 1-1 general rules and rules for buildings*. London: British Standard Institution.

BS EN 206-1 (2006) *Method of specifying and guidance for specifier*. London: British standard Institution.

BS EN 206-1 (2013) *Concrete. Specification, performance, production and conformity*. London: British standard Institution.

BS 5655-6 (2011) *Lifts and service Lifts – part 6: code of practice for the selection, installation and location of new lifts*. London: British standard Institution.

Burrer, C., Esteve, J. and Lora-Tamayo, E. (1996) Resonant silicon accelerometers in bulk micromachining technology – an approach. *Microelectromech Syst*, 5(2), p.122 - 130.

Canadian Standards Association (CSA) (1997), Code for the Design of Concrete Structures for Buildings. *Rexdale*, Ontario, p.131.

Choi, H. S., Ho, G., Joseph, L. & Neville, M. (2012). *Outrigger Design in High-Rise Buildings*, Chicago: Council on Tall Buildings and Urban Habitat

CIRIA C660 (2007) *Early-age thermal crack control in concrete*. London: CIRIA.

CIRIA REP 136 (1995) *Formwork striking times: criteria, prediction and methods of assessment*. London: CIRIA.

Computer and Structures, Inc. (2012) ETABS CSi Analysis Reference Manual, Computer and Structures, Inc., Berkeley, California.

Concrete Society (2005) *Technical report no.58 on deflections in concrete slabs and beams*. Camberley: The Concrete Society.

Construct (2010) *National structural concrete specification for building construction*. 4th ed. Surrey: The Concrete Centre.

David, T. N. and Roland, R. (2000) *Scalable micro mechanical optical crossconnects: Proceedings of the LEOS 2000 held at Rio Grande*. Rio: Rio de Janeiro.

ES ISO (4356) (2012) *Bases for the design of structures – deformation of buildings at the serviceability limit states*. Addis Ababa: Ethiopian Standards Agency (ESA).

Fib (2014) Structural concrete: analytical and numerical evaluation of the design shear resistance of reinforced concrete slabs. *Journal of Fib*, 15(3), p.317-318.

Fintel, M., Ghosh, S. K. & Iyengar, H., (1987). *Column Shortening in Tall Structures- Prediction and Compensation*. Engineering Bulletin No. EB108. Portland Cement Association: Washington, DC.

Florides, M. M. and Cashell, K. A. (2016) Advances in steel-concrete composite structure: numerical modelling of composite floor slabs subject to large deflections. *Structures*, 9(0), p.112-122.

Gardner, N. J., (2004). *Comparison of Prediction Provisions for Drying Shrinkage and Creep of Normal Strength Concretes*. Canadian Journal for Civil Engineering, 31(5), pp. 767-775.

Gete (2016) *Hydrostatic levelling system using pressure measurement for the continuous monitoring of changes in height of buildings* [Online]. Available at:

http://www.getec-ac.de/download/en/pdf/GeTecInfo_hsw03E.pdf [Accessed: 24 Feb 2016].

Goodchild, C. H. and Webster, R. M. (2006) *Spreadsheets for concrete design to BS8110 and EC2, version 3*. Surry: The Concrete Centre.

Goodchild, C. H. (2000) *Rationalisation of Flat Slab Reinforcement*. Berkshire: British Cement Association.

Goodchild, C.H. (2009) *Economic Concrete Frame Elements to Eurocode 2*. The Construction Information Service (CIS) [Online]. Available at: <http://ihsti.com> [Accessed: 11 February 2014].

Gouverneur, D., Caspeelet, R. and Taerwe, L. (2015) Structural engineering and mechanics: strain and crack development in continuous reinforced concrete slabs subjected to catenary action. *Journal of Techno press*, 53(1), p.173.

Grundy, Paul and Kabaila, A. (1963) Construction Loads on Slabs with Props Formwork in Multistorey Building. *American Concrete Institute (ACI) Journal*, 60(12), p.1729 - 1738.

Hansoo, K. & Seunghak, S., (2014). *Reduction of Differential Column Shortening in Tall Buildings*. *International Journal of Civil, Environmental, Structural, Construction and Architectural Engineering*, 8(2), p. 1.

Heiman, J. L. (1974) A Comparison of Measured and Calculated Deflection of Flexural Members in Four Reinforced Concrete Building. *Deflection of Concrete Structures*, 57(1), p.515 - 545.

Hilleborg , A. (1996) *Strip method design handbook*. London: E & FN Sogn.

Hossain, T. R. and Vollum, R. L. (2002) Prediction of Slab Deflections and Validation Against Cardington Data. *Proceeding of the Institution of Civil Engineers, Structural and Buildings*, 152(3), p.235-248.

Hurd, M. K. (1981) *Formwork for Concrete*. 4th ed. Detroit: American Concrete Institute (ACI).

ISO (4356) (1977) *Bases for the design of structures – deformation of buildings at the serviceability limit states*. Erste Auflage, ISO/TC98/SC2.

IStructE (2004) *National strategy for implementation of the structural eurocodes*. London: The Office of the Deputy Prime Minister.

Jahromi, A. B., Rotimi, A., Tovi, S., Goodchild, C. and Rizzuto, J. (2017) *Evaluation of the influence of creep and shrinkage determinants on column shortening in mid-rise buildings*. Daejeon: Techno Press.

Jenkins, B. R. (1974) Tests on a Flat Plate Floor. *The Institution of Engineers*, 16(2), p.164 - 167.

Joseph, E. F., Vladimir, A. A. David, J. B. and James, A. W (1999) Wavelength Add-Drop Switching Using Tilting Micromirrors. *Lightwave Technology*, 17(5), p.904 - 911.

Johnson, R. P. and Anderson, D. (2004) *Designers' Guide to EN 1994-1-1 Eurocode 4 Design of composite steel and concrete structures General Rules and Rules for buildings*. London: Thomas Telford.

Jofriet, Jan C. and McNeice, Gregory, M. (1971) Finite Element Analysis of Reinforced Concrete Slabs. *American Society of Civil Engineering (ASCE)*, p.785 - 806.

Jofriet, Jan, C. (1973) Short - Term Deflections of Concrete Flat Plates. *American Society of Civil Engineering (ASCE)*, 99(st1), p.167 - 182.

Kamath, K., Shashikumar, R. & Shruthi. (2015). *Optimum Positioning of Outriggers to Reduce Differential Column Shortening Due to Long Term Effect in Tall Buildings*. *International Journal of Advanced Research in Science and Technology*, 4(3), pp. 353-357.

Kang, S., Eomt, T. and Kim, J. (2013) Structural engineering and mechanics: reshoring effects on deflections of multi-shored flat plate systems under construction. *Journal of Techno press*, 45(4), p.456.

Kluwer, A. R (1995) Creep and shrinkage prediction model for analysis and design of concrete structures— model B3. *Kluwer Academic publishers*, 28(6), p.89 - 108.

Kripanarayan, K. M. and Branson, D. E. (1976) Short - Time Deflections of Plates, Flat Slabs, and Two - Way Slabs. *American Concrete Institute (ACI) Journal*, 73(12), p.686 - 690.

Lasisi, Muhammed, Y. and NG, Simon, F. (1979) Construction Loads Imposed on High - Rise Floor Slabs. *Concrete International*, 1(2), p.24 - 29.

Lawrence, H. M and John, P. (2006) *Concrete Design to EN 1992*. 2nd ed. Oxford: Butterworth-Heinemann.

MacGinley, T. J. and Choo, B. S. (1990). *Reinforced Concrete Design Theory and Examples*. 2nd ed. London: E. & F.N. Spon.

Microsoft Corporation (2016). *Microsoft Excel 2016*., Microsoft Redmond campus, Redmond, Washington, United States.

Mohammadhassani, M., Pour, H., Jumaat, M., Jameel, M., Hakim, S. J. S and Zarga, M. (2013) Structural engineering and mechanics: applicatiob of the ANFIS model in deflection prediction of concrete deep beam. *Journal of Techno press*, 45(3), p.324.

Mola, F. & Pellegrini, L. M., (2010). '*Effects of Column Shortening in Tall R.C. Buildings*'. 35th Conference on our World in Concrete & Structures, Singapore, Singapore Concrete Institute.

Moragaspitiya, P. H., (2011). *Interactive Axial Shortening of Columns and Walls in High Rise Buildings*, Queensland: Faculty of Built Environment and Engineering- Queensland University of Technology.

Moragaspitiya, P., Thambiratnam, D., Perera, N. and Chan, T. (2010). *A numerical method to quantify differential axial shortening in concrete buildings*. *Engineering Structures*, 32(8), pp.2310–2317. Available at: <http://dx.doi.org/10.1016/j.engstruct.2010.04.006>.

Mosley, B., Bungey, J. and Hulse, R. (2007) *Reinforced concrete design to eurocode 2*. 6th ed. Hampshire: Palgrave Macmillan.

Moss, R. M. and Brooker, O. (2006) *How to Design Concrete Structures Using Eurocode 2*. Surry: MPA – The Concrete Centre.

Nielsen, Knud, E. C. (1952) *Load on Reinforced Concrete Floor Slabs and Their Deformations During Construction*. Stockholm: Swedish Cement and Concrete Research Institute, Royal Institute of Technology.

Nilson, Arthur, H. and Walters, Donald, B. JR. (1975) Deflections of Two - Way Floor System by the Equivalent Frame Method. *American Concrete Institute (ACI) Journal*, 72(5), p.210- 218.

Njomo, W.W. & Ozay, G., (2014). Minimization of differential column shortening and sequential analysis of RC 3D-frames using ANN. *Structural Engineering and Mechanics*, 51(6), pp.989–1003.

Pan, L.B., Liu, P.C. and Bakoss, S.L. (1993). *Long-term shortening of concrete columns in tall buildings*. *Journal of Structural Engineering* 119(7), pp.2258–2262.

Patel, P. V. & Poojara, S. D. (2014). *Axial Deformation of Columns in Multi-Story R.C. Buildings*. *International Journal of Civil Engineering Technology (IJCIET)*, 5(3), pp. 294-300.

Peabody, D. (1948) Continuous Frame Analysis of Flat Slabs. *Boston Society of Civil Engineering Journal*, 35(1).

Rangan, B. Vijaya (1976) Prediction of Long - Term Deflections of Flat Plates and Slabs. *American Concrete Institute (ACI) Journal*, 73(4), p.223 - 226.

Razavi, S., V., Jumaat, M., Z., El-Shafie, A., H. and Ronagh, H., R. (2015) Advances in concrete construction: load-deflection analysis prediction of CFRP strengthened RC slab using RNN. *Journal of Techno press*, 60(2), p.92.

Sbarounis, John A. (1983) *Multistorey Flat Plates – Measured and Computed One – Year Deflections*. Detroit: American Concrete Institute (ACI).

Sbarounis, John A. (1984) Multistorey Flat Plate Buildings - Effect of Construction Loads on Long - Term Deflections. *American Concrete Institute (ACI)*, 6(4), p.62 - 70.

Sbarounis, John, A. (1984) Multistorey Flat Plat Building - Construction Loads and Immediate Deflections. *Concrete International*, 6(2), p.70 - 77.

Scanlon, A. (1971) *Structural Engineering Report 38*. Alberta: Department of Civil Engineering, University of Alberta.

Scanlon, A. and Murry, D. W. (1982) Practical Calculation of Two - Way Slab Deflections. *Concrete International*, 4(11), p.43 - 50.

Shaikh, F.U.A. & Taweel, M., (2015). Compressive strength and failure behaviour of fibre reinforced concrete at elevated temperatures. *Advances in Concrete Construction*, 3(4), pp.283–293.

SlideShare, (2016). *Challenges and solutions for tall building design*. Available at <http://image.slidesharecdn.com/2014technicalseminarmaterial-141126005006-conversion-gate01/95/2014-technical-seminarmaterial-41-638.jpg?cb=1416963100>
(Accessed: 31 October 2016).

Tayag, T. J, Hoon, S. K, Marchetti, J. and Jafri, I. H (2003) Optical fiber interferometer for measuring the in situ deflection characteristics of microelectromechanical structures. *Society of Photo-Optical Instrument Engineers*, 42(1), p.105 - 111.

Taylor, P. J. (1967) Effects of Formwork Stripping Time on Deflections of Flat Slabs. *Australian Civil Engineering and Construction*, 8(2), p.31 - 35.

Taylor, P. J. (1970) Long - Term Deflection Calculation Methods for Flat Plates. *Constructional Review*, 43(2), p.68 - 74.

Taylor, P. J. (1977) Long – Time Deflection of Reinforced Concrete Flat Slabs and Plates. *American Concrete Institute (ACI)*, 74(11), P.556 – 561.

The Concrete Society, (2008) Axial shortening of concrete columns in high-rise buildings, Concrete Advice N0.33.

The Concrete Society (2008) *Technical report no.67 on Movement, restraint and cracking in concrete structures*. Camberley: The Concrete Society.

The Concrete Centre (2011) *How to Design Concrete Structures using Eurocode 2*.
Surry: MPA – The Concrete Centre.

The Concrete Society (2005) *Technical report no.58 on deflection in concrete slabs and beams*. Camberley: The Concrete Society.

The Concrete Centre, (2014). *Tall Buildings, structural design of concrete buildings up to 300m tall*. ISBN 978-1-908257-14-7 MPA The Concrete centre and Federation of internationale du beton (fib).

The Concrete Centre, (2016). *User guide to Excel spreadsheets for design to BS 8110: Part 1, 1997 (Amd. 3) and BS EN 1992: 2004 Part 1-1 and its UK National Annex*. 3rd ed. Surrey: The Concrete Centre.

The Concrete Countertop Institute, (2016). *Temperature and Relative Humidity: What they Mean for You and Your Concrete*. [Online]
Available at: <http://www.concretetopinstitute.com/temperature-and-relative-humidity-what-they-mean-for-you-and-your-concrete/>

[Accessed 20 07 2016].

Timoshenko, S. and Woinowsky - Krieger, S. (1959), *Theory of Plates and Shells*. McGraw - Hill Book Company, New York, p.580.

Tovi, S., Goodchild, C., Jahromi, B. A. and Sofroniou, A. (2016) A review of the span-to-depth ratio methods of design. *Proceedings of the fib Symposium*, 21 – 23 November 2016, Cape Town, South Africa.

Tovi, S., Goodchild, C. and Jahromi, B. A. (in press) *Deformation of Multi-Storey Flat Slabs, a Finite Elements Analysis and Precise Levelling*. Daejeon: Techno Press.

Tovi, S., Goodchild, C. and Jahromi, B. A. (2017) *Deformation of Multi-Storey Flat Slabs, a Site Investigation*. Daejeon: Techno Press.

UK Building Research Establishment (2005) *Third edition of BRE special digest 1 concrete in aggressive ground*. Watford: BRE Bookshop of the UK Building Research Establishment.

UK National Annex to Eurocode 2 (2004) *Design of concrete structure – Part 1-1 general rules and rules for buildings*. London: British Standard Institution.

Vanderbilt, M. D., Sozen, M. A. and Siess, C. P. (1965) Deflections of Multile - Panel Reinforced Concrete Floor Slabs. *American Society of Civil Engineering (ASCE)*, 91(1), p.77 - 101.

Vollum, R. L. (1999) *A Review of Slab Deflections in the in – situ Concrete Frame Building*. London: BRE Bookshop.

Vollum, R. L., Moss, R. M. and Hossain, T. R. (2002) Slab Deflections in the Cardington in-situ Concrete Frame Building. *Concrete Research*, 54(1), p.23 – 34.

Vollum, R. L. (2003) Investigation into Backprop Forces and Deflections at St George Wharf. *Concrete Research*, 55(5), p.449 – 460.

Vollum, R. L. (2004) *Backprop forces and deflection in flat slabs construction at St George Wharf*. London: BRE Bookshop.

Vollum, R. L. and Afshar , N. (2009) Influence of Concstruction Loading on Deflections in reinforced Concrete Slabs. *Concrete Research*, 61(1), p.3 – 14.

Washa, G. W. and Fluck, P. G. (1952) The Effect of Compressive Reinforcement on the Plastic Flow of Reinforced Concrete Beam. *American Concrete Institute (ACI) Journal*, 49(8), p.89 - 108.

Washa, G. W. and Fluck, P. G. (1956) Plastic Flow (Creep) of Reinforced Concrete Continuous Beams. *American Concrete Institute (ACI) Journal*, 52(5), p.549 - 561.

Yu, Wei – Wen. and Winter, George (1960) Instantaneous and Long - Term Deflection of Reinforced Concrete Beams Under Working Loads. *American Concrete Institute (ACI) Journal*, 57(1), p.29 - 50.

Zou, D. et al., (2014). *Influence of creep and drying shrinkage of reinforced concrete shear walls on the axial shortening of high-rise buildings*. *Construction and Building Materials*, 55, pp.46–56.

List of Appendixes

Appendix A

SHIVAN TOVI / PhD Research Project



GeTec Ingenieurgesellschaft mbH; Rotter Bruch 26a; 52068 Aachen
 Tel.: 0241/406607; Fax: 0241/406609; Email: getec-ac@t-online.de

Datasheet: Hydrostatic Levelling Cell

Cellnumber: SE2259 Deliverydate: Re getec UK

Inventarnummer: envec-Nr.:

Fluid: Water

Sensorproducer: Keller Druck Endress&Hauser

Measuring Range: 20 mbar 40 mbar 50 mbar

Calibration from: 30/07/2015 Antifreeze

| | | | | |
|----------------------|----------|----------|--|--|
| Temperatur [°C] | 20.0 | | | |
| Zeropoint (dry) [mA] | 4.035 | | | |
| Zeropoint [mm] | 128.9650 | 124.7092 | | |
| Scalefactor [mm/mA] | 31.9473 | 30.8930 | | |

| Value Transferunit[mm] | ↑ GTC_Visual [mA] | ↓ GTC_Visual [mA] | Meanvalue [mA] | delta [mm] |
|------------------------|-------------------|-------------------|-------------------|-------------|
| 0 | 5.932 | 5.928 | 5.930 | 0.13 |
| 100 | 9.066 | 9.064 | 9.065 | 0.06 |
| 200 | 12.192 | 12.192 | 12.192 | 0.00 |
| 300 | 15.321 | 15.320 | 15.321 | 0.03 |
| 400 | 18.453 | 18.453 | 18.453 | 0.00 |
| | | | | 0.04 |
| Value Transferunit[mm] | Meanvalue [mA] | Ü-funktion [mm] | Soll - Ist 1 [mm] | |
| 0 | 4.035 | -0.06 | 0.06 | |
| 100 | 7.170 | 100.10 | -0.10 | |
| 200 | 10.297 | 200.00 | 0.00 | |
| 300 | 13.426 | 299.94 | 0.06 | |
| 400 | 16.558 | 400.02 | -0.02 | |
| Transferaccuracy | | 0.02% | -0.08 | |

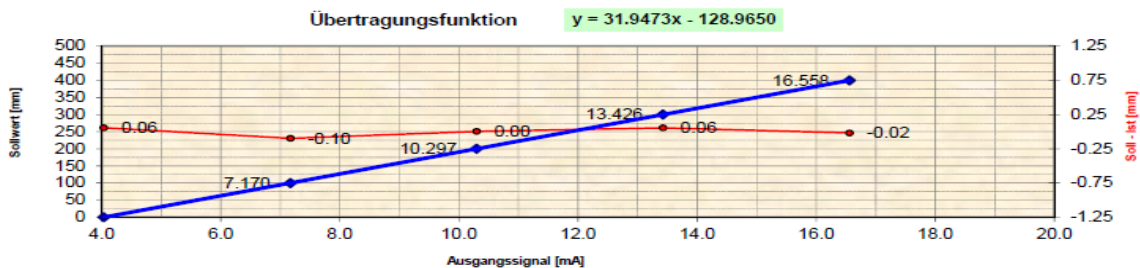

Bemerkung:

Manfred Jelds

30/07/2015



Datasheet: Hydrostatic Levelling Cell

Cellnumber: SE2351 Deliverydate: Re getec UK

Inventarnummer: envec-Nr.:

Fluid Water

Sensorproducer: Keller Druck Endress&Hauser

Measuring Range: 20 mbar 40 mbar 50 mbar

Calibration from: 30/07/2015 Antifreeze

| | | | | |
|----------------------|----------|----------|--|--|
| Temperatur [°C] | 20.0 | | | |
| Zeropoint (dry) [mA] | 4.023 | | | |
| Zeropoint [mm] | 128.5045 | 124.2639 | | |
| Scalefactor [mm/mA] | 31.9218 | 30.8684 | | |

| Value Transferunit[mm] | ↑ GTC_Visual [mA] | ↓ GTC_Visual [mA] | Meanvalue [mA] | delta [mm] |
|------------------------|-------------------|-------------------|----------------|-------------|
| 0 | 5.883 | 5.879 | 5.881 | 0.13 |
| 100 | 9.022 | 9.019 | 9.021 | 0.09 |
| 200 | 12.150 | 12.148 | 12.149 | 0.06 |
| 300 | 15.280 | 15.278 | 15.279 | 0.06 |
| 400 | 18.415 | 18.415 | 18.415 | 0.00 |
| | | | | 0.07 |

| Value Transferunit[mm] | Meanvalue [mA] | Ü-funktion [mm] | Soll - Ist 1 [mm] |
|------------------------|----------------|-----------------|-------------------|
| 0 | 4.023 | -0.08 | 0.08 |
| 100 | 7.163 | 100.14 | -0.14 |
| 200 | 10.291 | 200.00 | 0.00 |
| 300 | 13.421 | 299.92 | 0.08 |
| 400 | 16.557 | 400.02 | -0.02 |
| Transferaccuracy | | 0.02% | -0.11 |

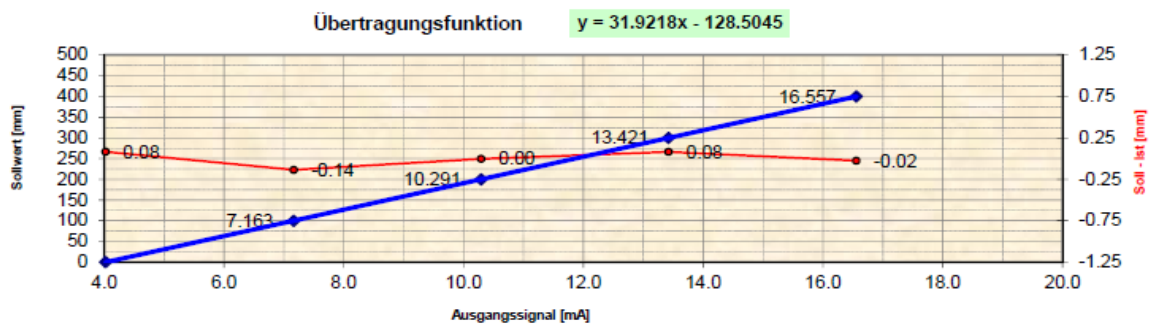

Bemerkung:

Manfred Jelle

30/07/2015



Datasheet: Hydrostatic Levelling Cell

Cellnumber: SE1669 Deliverydate: Re getec UK

Inventarnummer: envec-Nr.:

Fluid: Water

Sensorproducer: Keller Druck Endress&Hauser

Measuring Range: 20 mbar 40 mbar 50 mbar

Calibration from: 30/07/2015 Antifreeze

| | | | | |
|----------------------|----------|----------|--|--|
| Temperatur [°C] | 20.0 | | | |
| Zeropoint (dry) [mA] | 4.063 | | | |
| Zeropoint [mm] | 129.6735 | 125.3943 | | |
| Scalefactor [mm/mA] | 31.9173 | 30.8640 | | |

| Value Transferunit[mm] | GTC_Visual [mA] | GTC_Visual [mA] | Meanvalue [mA] | delta [mm] |
|------------------------|-----------------|-----------------|-------------------|--------------|
| 0 | 5.943 | 5.944 | 5.944 | -0.03 |
| 100 | 9.076 | 9.079 | 9.078 | -0.09 |
| 200 | 12.207 | 12.209 | 12.208 | -0.06 |
| 300 | 15.341 | 15.342 | 15.342 | -0.03 |
| 400 | 18.477 | 18.477 | 18.477 | 0.00 |
| | | | | -0.04 |
| Value Transferunit[mm] | Meanvalue [mA] | Ü-funktion [mm] | Soll - Ist 1 [mm] | |
| 0 | 4.063 | 0.01 | -0.01 | |
| 100 | 7.197 | 100.04 | -0.04 | |
| 200 | 10.328 | 199.95 | 0.05 | |
| 300 | 13.461 | 299.97 | 0.03 | |
| 400 | 16.597 | 400.04 | -0.04 | |
| Transferaccuracy | | 0.01% | -0.04 | |

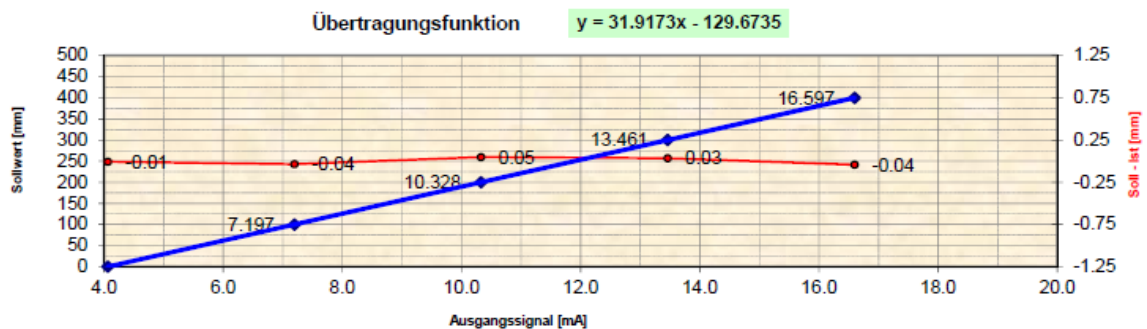

Bemerkung:

Manfred Jöckel

30/07/2015



Datasheet: Hydrostatic Levelling Cell

Cellnumber: SE2339 Deliverydate: Re getec UK

Inventarnummer: envec-Nr.:

Fluid Water

Sensorproducer: Keller Druck Endress&Hauser

Measuring Range: 20 mbar 40 mbar 50 mbar

Calibration from: 30/07/2015 Antifreeze

| | | | | |
|----------------------|----------|----------|--|--|
| Temperatur [°C] | 20.0 | | | |
| Zeropoint (dry) [mA] | 4.036 | | | |
| Zeropoint [mm] | 129.1532 | 124.8911 | | |
| Scalefactor [mm/mA] | 31.9734 | 30.9183 | | |

| Value Transferunit[mm] | ↑ GTC_Visual [mA] | ↓ GTC_Visual [mA] | Meanvalue [mA] | delta [mm] |
|-------------------------|-------------------|-------------------|-------------------|-------------|
| 0 | 5.898 | 5.895 | 5.897 | 0.09 |
| 100 | 9.035 | 9.031 | 9.033 | 0.12 |
| 200 | 12.156 | 12.154 | 12.155 | 0.06 |
| 300 | 15.282 | 15.278 | 15.280 | 0.12 |
| 400 | 18.411 | 18.411 | 18.411 | 0.00 |
| | | | | 0.08 |
| Value Transferunit[mm] | Meanvalue [mA] | Ü-funktion [mm] | Soll - Ist 1 [mm] | |
| 0 | 4.036 | -0.11 | 0.11 | |
| 100 | 7.173 | 100.18 | -0.18 | |
| 200 | 10.295 | 200.00 | 0.00 | |
| 300 | 13.420 | 299.91 | 0.09 | |
| 400 | 16.551 | 400.02 | -0.02 | |
| Transferaccuracy | | 0.03% | -0.13 | |

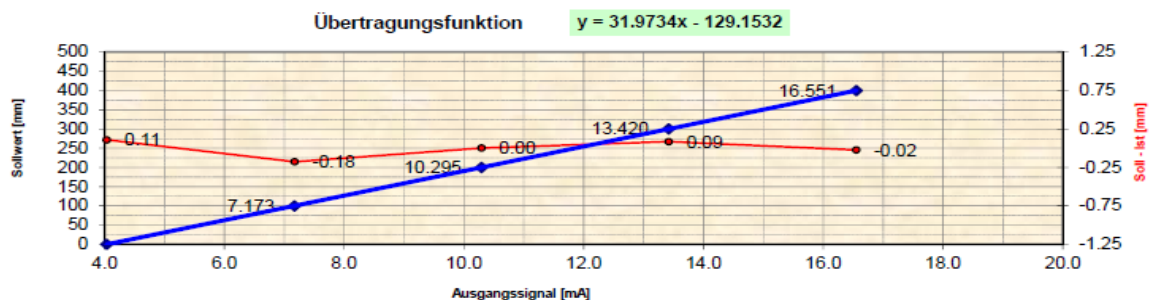

Bemerkung:

Manfred Jelds

30/07/2015



Datasheet: Hydrostatic Levelling Cell

Cellnumber: SE2856 Deliverydate: Re getec UK

Inventarnummer: envec-Nr.:

Fluid: **Water**

Sensorproducer: Keller Druck Endress&Hauser

Measuring Range: 20 mbar 40 mbar 50 mbar

Calibration from: 30/07/2015 Antifreeze

| | | | | |
|----------------------|----------|----------|--|--|
| Temperatur [°C] | 20.0 | | | |
| Zeropoint (dry) [mA] | 4.074 | | | |
| Zeropoint [mm] | 130.6787 | 126.3663 | | |
| Scalefactor [mm/mA] | 32.0456 | 30.9881 | | |

| Value Transferunit[mm] | ↑ GTC_Visual [mA] | ↓ GTC_Visual [mA] | Meanvalue [mA] | delta [mm] |
|------------------------|-------------------|-------------------|-------------------|-------------|
| 0 | 5.903 | 5.900 | 5.902 | 0.09 |
| 100 | 9.033 | 9.032 | 9.033 | 0.03 |
| 200 | 12.146 | 12.143 | 12.145 | 0.09 |
| 300 | 15.269 | 15.265 | 15.267 | 0.12 |
| 400 | 18.387 | 18.387 | 18.387 | 0.00 |
| | | | | 0.07 |
| Value Transferunit[mm] | Meanvalue [mA] | Ü-funktion [mm] | Soll - Ist 1 [mm] | |
| 0 | 4.074 | -0.12 | 0.12 | |
| 100 | 7.205 | 100.21 | -0.21 | |
| 200 | 10.317 | 199.94 | 0.06 | |
| 300 | 13.440 | 300.00 | 0.00 | |
| 400 | 16.560 | 399.98 | 0.02 | |
| Transferaccuracy | | 0.02% | -0.11 | |

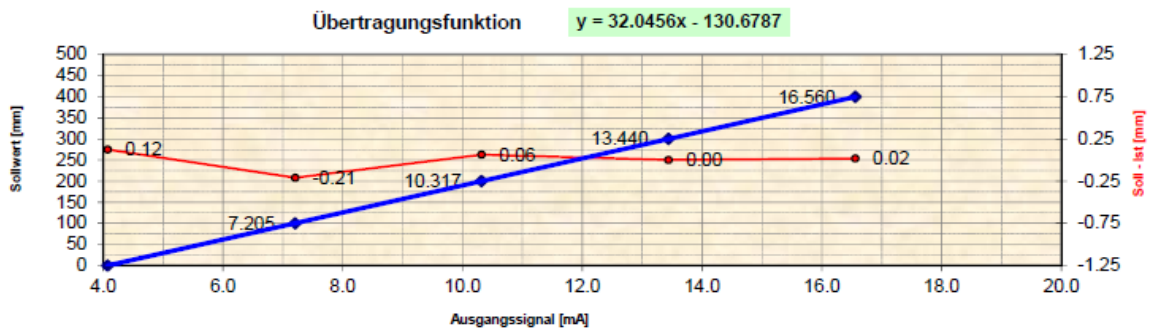

Bemerkung:

Manfred Jelle

30/07/2015



Datasheet: Hydrostatic Levelling Cell

Cellnumber: SE1672 Deliverydate: Re getec UK

Inventarnummer: envec-Nr.:

Fluid Water

Sensorproducer: Keller Druck Endress&Hauser

Measuring Range: 20 mbar 40 mbar 50 mbar

Calibration from: 30/07/2015 Antifreeze

| | | | | |
|----------------------|----------|----------|--|--|
| Temperatur [°C] | 20.0 | | | |
| Zeropoint (dry) [mA] | 4.046 | | | |
| Zeropoint [mm] | 129.0563 | 124.7974 | | |
| Scalefactor [mm/mA] | 31.8862 | 30.8340 | | |

| Value Transferunit[mm] | ↑ GTC_Visual [mA] | ↓ GTC_Visual [mA] | Meanvalue [mA] | delta [mm] |
|------------------------|-------------------|-------------------|-------------------|--------------|
| 0 | 5.924 | 5.926 | 5.925 | -0.06 |
| 100 | 9.065 | 9.067 | 9.066 | -0.06 |
| 200 | 12.196 | 12.198 | 12.197 | -0.06 |
| 300 | 15.333 | 15.334 | 15.334 | -0.03 |
| 400 | 18.472 | 18.472 | 18.472 | 0.00 |
| | | | | -0.04 |
| Value Transferunit[mm] | Meanvalue [mA] | Ü-funktion [mm] | Soll - Ist 1 [mm] | |
| 0 | 4.046 | -0.04 | 0.04 | |
| 100 | 7.187 | 100.11 | -0.11 | |
| 200 | 10.318 | 199.95 | 0.05 | |
| 300 | 13.455 | 299.96 | 0.04 | |
| 400 | 16.593 | 400.03 | -0.03 | |
| Transferaccuracy | | 0.02% | -0.08 | |

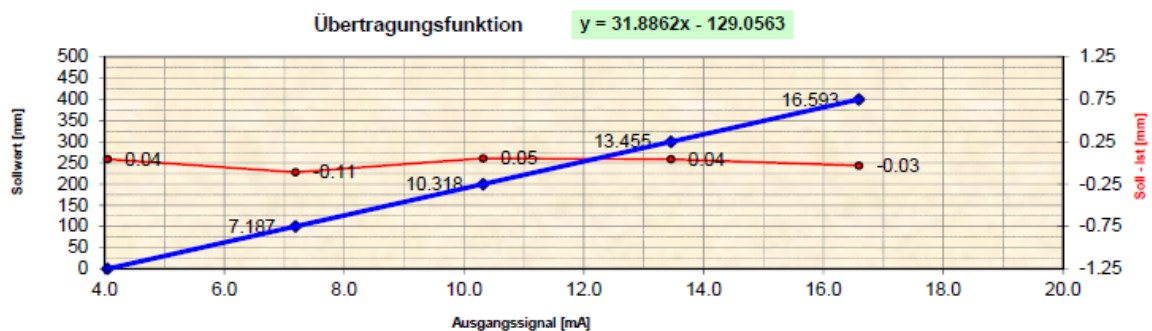

Bemerkung:

Manfred Jöls

30/07/2015



Datasheet: Hydrostatic Levelling Cell

Cellnumber: SE2341 Deliverydate: Re getec UK

Inventarnummer: envec-Nr.:

Fluid Water

Sensorproducer: Keller Druck Endress&Hauser

Measuring Range: 20 mbar 40 mbar 50 mbar

Calibration from: 30/07/2015 Antifreeze

| | | | | |
|----------------------|----------|----------|--|--|
| Temperatur [°C] | 20.0 | | | |
| Zeropoint (dry) [mA] | 4.052 | | | |
| Zeropoint [mm] | 129.6624 | 125.3835 | | |
| Scalefactor [mm/mA] | 31.9759 | 30.9207 | | |

| Value Transferunit[mm] | ↑ GTC_Visual [mA] | ↓ GTC_Visual [mA] | Meanvalue [mA] | delta [mm] |
|------------------------|-------------------|-------------------|-------------------|-------------|
| 0 | 5.917 | 5.913 | 5.915 | 0.12 |
| 100 | 9.052 | 9.048 | 9.050 | 0.12 |
| 200 | 12.174 | 12.170 | 12.172 | 0.12 |
| 300 | 15.301 | 15.298 | 15.300 | 0.09 |
| 400 | 18.427 | 18.427 | 18.427 | 0.00 |
| | | | | 0.09 |
| Value Transferunit[mm] | Meanvalue [mA] | Ü-funktion [mm] | Soll - Ist 1 [mm] | |
| 0 | 4.052 | -0.10 | 0.10 | |
| 100 | 7.187 | 100.15 | -0.15 | |
| 200 | 10.309 | 199.98 | 0.02 | |
| 300 | 13.437 | 299.98 | 0.02 | |
| 400 | 16.564 | 399.99 | 0.01 | |
| Transferaccuracy | | 0.02% | -0.08 | |

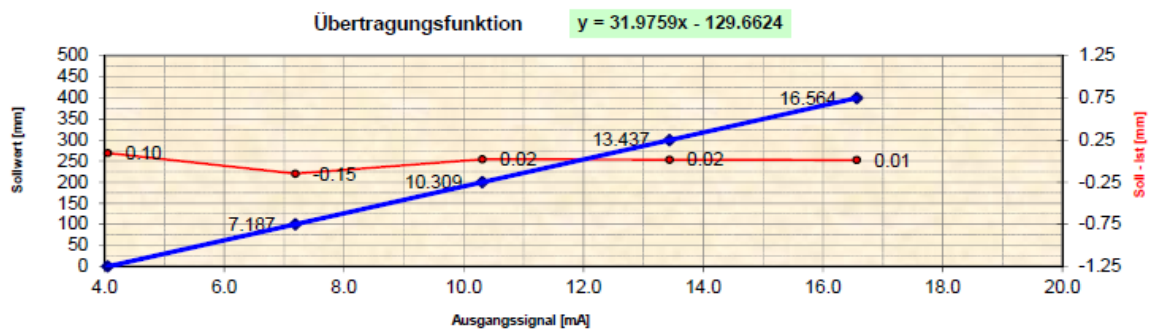

Bemerkung:

Manfred Jahn

30/07/2015



Datasheet: Hydrostatic Levelling Cell

Cellnumber: SE1624 Deliverydate: Re getec UK

Inventarnummer: envec-Nr.:

Fluid Water

Sensorproducer: Keller Druck Endress&Hauser

Measuring Range: 20 mbar 40 mbar 50 mbar

Calibration from: 30/07/2015 Antifreeze

| | | | | |
|----------------------|----------|----------|--|--|
| Temperatur [°C] | 20.0 | | | |
| Zeropoint (dry) [mA] | 4.050 | | | |
| Zeropoint [mm] | 129.7085 | 125.4281 | | |
| Scalefactor [mm/mA] | 32.0015 | 30.9455 | | |

| Value Transferunit[mm] | ↑ GTC_Visual [mA] | ↓ GTC_Visual [mA] | Meanvalue [mA] | delta [mm] |
|-------------------------|-------------------|-------------------|-------------------|--------------|
| 0 | 5.933 | 5.933 | 5.933 | 0.00 |
| 100 | 9.063 | 9.066 | 9.065 | -0.09 |
| 200 | 12.186 | 12.188 | 12.187 | -0.06 |
| 300 | 15.311 | 15.311 | 15.311 | 0.00 |
| 400 | 18.434 | 18.434 | 18.434 | 0.00 |
| | | | | -0.03 |
| Value Transferunit[mm] | Meanvalue [mA] | Ü-funktion [mm] | Soll - Ist 1 [mm] | |
| 0 | 4.050 | -0.10 | 0.10 | |
| 100 | 7.182 | 100.11 | -0.11 | |
| 200 | 10.304 | 200.03 | -0.03 | |
| 300 | 13.428 | 300.01 | -0.01 | |
| 400 | 16.551 | 399.95 | 0.05 | |
| Transferaccuracy | | 0.01% | -0.05 | |

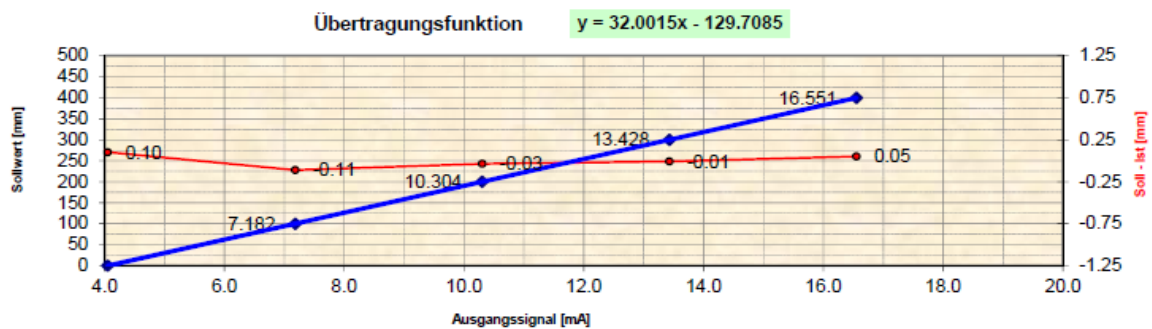

Bemerkung:

Manfred Jahn

30/07/2015

Appendix B

Eurban Structural CLT Tolerances



TOLERANCE GUIDANCE

MANUFACTURING TOLERANCES

Manufacturing tolerances can be assumed to be as follows:

| | | |
|--------------|---|--------|
| manufactured | overall panel length | ± 3 mm |
| | overall panel width | ± 3 mm |
| components | overall panel thickness | ± 1 mm |
| | position and size of cuts / cut outs to panel | ± 5 mm |
| | position and size of openings within panel | ± 5 mm |

BUILD TOLERANCES

For clarity and ease of reference, the Eurban build tolerances has been summarised below:

| | | |
|-------------------|---|----------------------|
| building | overall plan dimension, L < 30m | ± 20 mm |
| | overall plan dimension, L > 30m | ± 20 mm + 0.25(L-30) |
| | overall height dimension, L < 30m | ± 20 mm |
| | overall verticality | ± 25 mm |
| walls and columns | space between walls and columns up to | ± 24 mm |
| | straightness in 5m | ± 6 mm |
| | abrupt changes across joints - visual | ± 3 mm |
| | abrupt changes across joints - non-visual | ± 5 mm |
| | verticality up to 7m high | ± 14 mm |
| | plan position relative to nearest reference | ± 15 mm |
| beams and floors | level variation from target plane | ± 20 mm |
| | straightness in 6m | ± 10 mm |
| | level variation across 5m | ± 10 mm |
| | abrupt changes across joints - visual | ± 3 mm |
| | abrupt changes across joints - non-visual | ± 5 mm |
| | plan position relative to nearest reference | ± 10 mm |
| openings | elevation position relative to nearest | ± 15 mm |
| | structural opening height up to 3m | ± 11mm |
| | structural opening width up to 3m | ± 10mm |
| | | |

Appendix C

Concrete Tickets H10C



| A J MORRISROE & SONS LTD | | | | |
|---|---|---------------------------|----------------------------|-----------------------|
| CONCRETE LOG SHEET | | | | |
| PROJECT: | | | | |
| CHECKLIST REF: | | | SHEET No. 65 | |
| AREA: | Block H10 C GF rft pour 1 = 228m ³ | | WEATHER: | Sunny all day 18°C |
| DATE OF CONCRETE: 22/6/15 | | TIME POUR STARTED: 08:45 | | |
| TOTAL VOLUME OF CONCRETE: 228m ³ | | TIME POUR FINISHED: 19:00 | | |
| MIX: | C45 mix 3 xypex / C45 | | SLUMP: 54 +/- mm | |
| CEMENT TYPE: | Cem I / CEM I | | M.C.C.: 360 / 360 | |
| W/C RATIO | 0.45 / 0.55 | | AGGREGATE SIZE: 20mm | |
| ADMIXTURE: | Splas + xypex / splas | | | |
| CUBES TAKEN REF: | | DELIVERY TICKET REF: | LOCATION OF CONCRETE | |
| Apm MPI 135 A-D | | 0375116 | As above highlighted | |
| Apm MPI 136 A-D | | 636524 | As above highlighted | |
| | | | | |
| | | | | |
| | | | | |
| | | | | |
| | | | | |
| | | | | |
| SAMPLING CARRIED OUT BY: | | MADAN. | | |
| DELIVERY TICKETS | VOLUME OF CONCRETE | | TICKET DETAILS CHECKED BY: | ACTUAL SLUMP |
| | THIS TICKET | RUNNING TOTAL | | |
| 0375116 C45 xypex | 7.6 | 7.6 | L.Henry | 180 |
| 0375121 C45 xypex | 7.6 | 15.2 | - | |
| 0366524 C45 xypex | 7.6 | 22.8 | - | |
| 036535 C45 xypex | 7.6 | 30.4 | - | |
| 0375130 C45 xypex | 7.6 | 38.0 | - | |
| 0375132 C45 xypex | 7.6 | 45.6 | - | |
| 0375134 C45 xypex | 7.6 | 53.2 | - | 175 |
| 0375138 C45 xypex | 7.6 | 60.8 | - | |
| 0375140 C45 xypex | 7.6 | 68.4 | - | |
| 636547 C45 xypex | 7.6 | 76.0 | - | |
| | 7.6 | 83.6 | - | |
| | 7.6 | 91.2 | - | |
| | 7.6 | 98.8 | - | |
| | 7.6 | 106.4 | - | |
| | 7.6 | 114.0 | - | 215 |
| | 7.6 | 121.6 | - | |
| | 7.6 | 129.2 | - | |
| | 7.6 | 136.8 | - | |

A J MORRISROE & SONS LTD
CONCRETE LOG SHEET

PROJECT:
CHECKLIST REF: Hloc ramp pour 2 = 12.5 + 110 wall GF = 32 SHEET No. 69
AREA: H13C rftt pour 1 = WEATHER: Sunny all day 27°C.
Black P staircase GF pour 3 = 7.6m³
DATE OF CONCRETE: 26/6/15 TIME POUR STARTED: 0900
TOTAL VOLUME OF CONCRETE: 197.6m³ TIME POUR FINISHED: 1840
MIX: C45 xypex C60 xypex C60 10mm / C45 MIX S SLUMP: 54 +/- mm
CEMENT TYPE: Cem I, Cem I, CUB v22, CUB v M.C.C.: 360, 340, 340, 340
W/C RATIO: 0.45, 0.55, 0.55, 0.55 AGGREGATE SIZE: 20mm, 10mm
ADMIXTURE:

| CUBES TAKEN REF: | DELIVERY TICKET REF: | LOCATION OF CONCRETE |
|------------------------|----------------------|-----------------------------|
| <u>Apn MPI 152 A-D</u> | <u>0341528</u> | <u>As above highlighted</u> |
| <u>Apn MPI 153 A-D</u> | <u>0341544</u> | <u>As above highlighted</u> |
| <u>Apn MPI 154 A-D</u> | <u>0341547</u> | <u>As above highlighted</u> |
| <u>Apn MPI 155 A-D</u> | <u>0341590</u> | <u>As above highlighted</u> |
| | | |
| | | |
| | | |
| | | |
| | | |
| | | |

SAMPLING CARRIED OUT BY: MADAN

| DELIVERY TICKETS | VOLUME OF CONCRETE | | TICKET DETAILS CHECKED BY: | ACTUAL SLUMP |
|--------------------------|--------------------|---------------|----------------------------|--------------|
| | THIS TICKET | RUNNING TOTAL | | |
| <u>0341528 C45 xypex</u> | <u>7.6</u> | <u>7.6</u> | <u>L Henry</u> | <u>190</u> |
| <u>0341529 C60 10mm</u> | <u>7.6</u> | <u>15.2</u> | | |
| <u>0341529 C45 MIX S</u> | <u>7.6</u> | <u>22.8</u> | | |
| <u>0341532 C45 MIX S</u> | <u>7.6</u> | <u>30.4</u> | | |
| <u>0341535 C45 MIX S</u> | <u>7.6</u> | <u>38.0</u> | | |
| <u>0341536 C45 MIX S</u> | <u>7.6</u> | <u>45.6</u> | | |
| <u>0341537 C45 MIX S</u> | <u>7.6</u> | <u>53.2</u> | | |
| <u>0341544 C60 xypex</u> | <u>7.6</u> | <u>60.8</u> | | <u>175</u> |
| <u>0341547 C45 MIX S</u> | <u>7.6</u> | <u>68.4</u> | | |
| <u>0341552 C45 MIX S</u> | <u>7.6</u> | <u>76.0</u> | | |
| <u>0341560 C45 MIX S</u> | <u>7.6</u> | <u>83.6</u> | | |
| <u>0341562 C45 MIX S</u> | <u>7.6</u> | <u>91.2</u> | | |
| <u>0341565 C45 MIX S</u> | <u>7.6</u> | <u>98.8</u> | | |
| <u>0341567 C45 MIX S</u> | <u>7.6</u> | <u>106.4</u> | | |
| <u>0341571 C45 MIX S</u> | <u>7.6</u> | <u>114.0</u> | | |
| <u>0341574 C45 MIX S</u> | <u>7.6</u> | <u>121.6</u> | | |
| <u>0341579 C45 MIX S</u> | <u>7.6</u> | <u>129.2</u> | | |
| <u>0341588 C45 MIX S</u> | <u>7.6</u> | <u>136.8</u> | | |

A J MORRISROE & SONS LTD
CONCRETE LOG SHEET

PROJECT: _____

CHECKLIST REF: _____ SHEET No. **72**

AREA: **H10 c wall GF pour 1 = 36m³ + 4m³ H10 c pump station base**
H13A 2nd floor floor 121.6m³ WEATHER: **Sunny all day.**

DATE OF CONCRETE: **30/6/15** TIME POUR STARTED: **10:33**

TOTAL VOLUME OF CONCRETE: **129.2m³** TIME POUR FINISHED: **19:55**

MIX: **Mix 4 C60 Xypex, Mix 6 + RET** SLUMP: **54 +/- mm**

CEMENT TYPE: **CEM1, CEM1** M.C.C.: **340, -**

W/C RATIO **0.55** AGGREGATE SIZE: **20mm**

ADMIXTURE: **Xypex + RET, Splas + RET**

| CUBES TAKEN REF: | DELIVERY TICKET REF: | LOCATION OF CONCRETE |
|------------------------|----------------------|-----------------------------|
| Ajm MPI 164 A-D | 0341742 | As above highlighted |
| Ajm MPI 165 A-D | 0341743 | As above highlighted |
| Ajm MPI 166 A-D | 0341786 | As above highlighted |
| Ajm MPI 167 A-D | 0341787 | As above highlighted |
| Ajm MPI 168 A-D | 0341802 | As above highlighted |
| Ajm MPI 169 A-D | 0341806 | As above highlighted |
| | | |
| | | |
| | | |

SAMPLING CARRIED OUT BY: **MADAN.**

| DELIVERY TICKETS | VOLUME OF CONCRETE | | TICKET DETAILS CHECKED BY: | ACTUAL SLUMP |
|----------------------------|--------------------|---------------|----------------------------|--------------|
| | THIS TICKET | RUNNING TOTAL | | |
| 0341742 Mix 4 Xypex | 76 | 76 | L Harvey | 200 |
| 0341743 Mix 6 C60 | 76 | 152 | | 165 |
| 0341753 Mix 6 C60 | 76 | 228 | | |
| 0341756 Mix 6 C60 | 76 | 304 | | |
| 0341759 Mix 6 C60 | 76 | 380 | | |
| 0341762 Mix 6 C60 | 76 | 456 | | |
| 0341765 Mix 6 C60 | 76 | 532 | | |
| 0341768 Mix 6 C60 | 76 | 608 | | |
| 0341771 Mix 6 C60 | 76 | 684 | | |
| 0341774 Mix 6 C60 | 76 | 760 | | |
| 0341777 Mix 6 C60 | 76 | 836 | | |
| 0341780 Mix 6 C60 | 76 | 912 | | |
| 0341783 Mix 6 C60 | 76 | 988 | | |
| 0341786 Mix 6 C60 | 76 | 1064 | | |
| 0341789 Mix 6 C60 | 76 | 1140 | | |
| 0341817 Mix 6 C60 | 76 | 1216 | | |
| 0341818 Mix 6 C60 | 76 | 1292 | | 165 |
| 0341824 Mix 6 C60 | 76 | 1368 | | |

MORRISROE Block E lift core GF 10.2m³

A J MORRISROE & SONS LTD

CONCRETE LOG SHEET

PROJECT: H10c lift pit + brach mass fill = 68.4m³, Block C basement retaining wall pour 1 = 10

CHECKLIST REF: SHEET No. 73

AREA: Block C GF Core 15.2m³, Basement slab top up = 22.8m³
 WEATHER: sunny all day 33°C

DATE OF CONCRETE: 01/07/15 TIME POUR STARTED: 0850

TOTAL VOLUME OF CONCRETE: 142.3 TIME POUR FINISHED: 1715

MIX: C45 mix 1, C45 mix 5, C60 mix 2, C60 mix 4 SLUMP: 54 +/- mm

CEMENT TYPE: CEM I, CEM II/B, CEM III/B, CEM I M.C.C.: 340, 340, 340

W/C RATIO: 0.55, 0.55, 0.55, 0.55 AGGREGATE SIZE: 20mm

ADMIXTURE: ~~Ret~~ Ret, ~~Ret~~ Ret, ~~Ret~~ Ret, ~~Ret~~ Ret

| CUBES TAKEN REF: | DELIVERY TICKET REF: | LOCATION OF CONCRETE |
|------------------|----------------------|----------------------|
| Apm MPI 170 A-D | 0341852 | As above highlighted |
| Apm MPI 171 A-D | 0341840 | As above highlighted |
| Apm MPI 172 A-D | 0341851 | As above highlighted |
| Apm MPI 173 A-D | 0341847 | As above highlighted |
| Apm MPI 174 A-D | 0341862 | As above highlighted |
| Apm MPI 175 A-D | 0341882 | As above highlighted |
| | | |
| | | |
| | | |
| | | |

SAMPLING CARRIED OUT BY: MADAN

| DELIVERY TICKETS | VOLUME OF CONCRETE | | TICKET DETAILS CHECKED BY: | ACTUAL SLUMP |
|---------------------------|--------------------|---------------------|----------------------------|--------------|
| | THIS TICKET | RUNNING TOTAL | | |
| 0341852 C45 mix 1 | 7.6 | 7.6 | L. Huang | 175 |
| 0341856 C45 mix 1 | 7.6 | 15.2 | - | - |
| 0341840 C45 mix 5 | 7.6 | 22.8 | - | 170 |
| 0341845 C45 mix 5 | 7.6 | 30.4 | - | 180 |
| 0341851 C45 mix 5 | 7.6 | 38.0 | - | - |
| 0341847 C60 mix 2 | 7.6 | 45.6 | - | - |
| 0341852 C60 mix 2 | 7.6 | 53.2 | - | - |
| 0341854 C45 mix 5 | 7.6 | 60.8 | - | - |
| 0341855 C45 mix 5 | 7.6 | 68.4 | - | - |
| 0341857 C45 mix 5 | 7.6 | 76 | - | - |
| 0341862 C45 mix 5 | 7.6 | 83.6 | - | 180 |
| 0341863 C45 mix 5 | 7.6 | 91.2 | - | - |
| 0341866 C45 mix 5 | 7.6 | 98.8 | - | - |
| 0341870 C45 mix 5 | 7.6 | 106.4 | - | - |
| 0341872 C45 mix 5 | 7.6 | 114.0 | - | - |
| 0341873 C45 mix 5 | 7.6 | 121.6 | - | - |
| 0341874 C60 mix 4 x y x z | 7.6 | 129.2 | - | - |
| 0341882 C60 mix 4 x y x z | 7.6 | 136.8 | - | 160 |
| 0341884 C45 mix 1 | 5.5 | 142.3m ³ | - | - |

A J MORRISROE & SONS LTD
CONCRETE LOG SHEET

PROJECT: _____
 CHECKLIST REF: _____ SHEET No. **78**
 AREA: **Block H13A 2nd floor part 2 = 152 c.m³**
Block H10C Gf part 3, adjacent block = 30.4 m³ WEATHER: **Humid, Cloudy**
22°C
 DATE OF CONCRETE: **7/7/15** TIME POUR STARTED: **0820**
 TOTAL VOLUME OF CONCRETE: **182.4 m³** TIME POUR FINISHED: **1805**
 MIX: **C50 Mix 6, C60 mix 7, C45 mix 5** SLUMP: **54 +/- mm**
 CEMENT TYPE: **Cem I, C11B-UTSR, C11B-U** M.C.C.: **340, 340**
 W/C RATIO: **0.55, 0.55** AGGREGATE SIZE: **20mm**
 ADMIXTURE: **Splas, Splas + RET, splas**

| CUBES TAKEN REF: | DELIVERY TICKET REF: | LOCATION OF CONCRETE |
|------------------------|----------------------|-----------------------------|
| Apm MPI 190 A-F | 0357310 | As above highlighted |
| Apm MPI 191 A-F | 0357337 | As above highlighted |
| Apm MPI 192 A-D | 0357353 | As above highlighted |
| Apm MPI 193 A-D | 0357370 | As above highlighted |
| Apm MPI 194 A-D | 0357387 | As above highlighted |
| | | |
| | | |
| | | |
| | | |
| | | |

SAMPLING CARRIED OUT BY: **MADAN**

| DELIVERY TICKETS | VOLUME OF CONCRETE | | TICKET DETAILS CHECKED BY: | ACTUAL SLUMP |
|--------------------------|--------------------|---------------|----------------------------|--------------|
| | THIS TICKET | RUNNING TOTAL | | |
| 0357310 C50 MIX 6 | 76 | 76 | — | |
| 0357310 C50 MIX 6 | 76 | 152 | — | 180 |
| 0357315 C50 MIX 6 | 76 | 228 | — | |
| 0357319 C50 MIX 6 | 76 | 304 | — | |
| 0357321 C50 MIX 6 | 76 | 380 | — | |
| 0357322 C50 MIX 6 | 76 | 456 | — | |
| 0357326 C50 MIX 6 | 76 | 532 | — | |
| 0357337 C50 MIX 6 | 76 | 608 | — | 190 |
| 0357338 C50 MIX 6 | 76 | 684 | — | |
| 0357341 C50 MIX 6 | 76 | 760 | — | |
| 0357346 C50 MIX 6 | 76 | 836 | — | |
| 0357351 C50 MIX 6 | 76 | 912 | — | |
| 0357353 C50 MIX 6 | 76 | 988 | — | 175 |
| 0357358 C50 MIX 6 | 76 | 1064 | — | |
| 0357359 C50 MIX 6 | 76 | 1140 | — | |
| 0357359 C50 MIX 6 | 76 | 1216 | — | |
| 0357362 C50 MIX 6 | 76 | 1292 | — | |
| 0357364 C50 MIX 6 | 76 | 1368 | — | |
| 0357367 C50 MIX 6 | 76 | 1444 | — | |
| 0357370 C50 MIX 6 | 76 | 1520 | — | |

A J MORRISROE & SONS LTD CONCRETE LOG SHEET

| | | | |
|---|--------------------------|------------------------|--|
| PROJECT: Lift pit Basement slab H10A = 5.2m ² | | SHEET No. 83 | |
| CHECKLIST REF: Blasting H10 C = 10m ³ | | WEATHER: Overcast 20°C | |
| AREA: Block H10C GF raft slab pour 3 = 197.6m ³ Snoozebox + 1100 wall H10C grid floor = 7.6m ³ | | | |
| DATE OF CONCRETE: 13/7/15 | TIME POUR STARTED: 1020 | | |
| TOTAL VOLUME OF CONCRETE: 190m ³ | TIME POUR FINISHED: 1950 | | |
| MIX: C45 mix 5, C60 mix 2, C60 mix 4 | SLUMP: 54 +/- mm | | |
| CEMENT TYPE: CUB-V, CUB-V+SE, CEM1 | M.C.C.: 340, 340, 340 | | |
| W/C RATIO: 0.55, 0.55, 0.55 | AGGREGATE SIZE: 20mm | | |
| ADMIXTURE: Splos, Spbstret | | | |

| CUBES TAKEN REF: | DELIVERY TICKET REF: | LOCATION OF CONCRETE |
|------------------|----------------------|----------------------|
| Apm MPI 217 A-D | 0365748 | As above highlighted |
| Apm MPI 218 A-D | 0365770 | " " |
| Apm MPI 219 A-D | 0365778 | " " |
| Apm MPI 220 A-D | 0365789 | " " |
| Apm MPI 221 A-D | 0365790 | " " |
| Apm MPI 222 A-D | 0365813 | " " |
| | | |
| | | |
| | | |
| | | |

SAMPLING CARRIED OUT BY: MADAN

| DELIVERY TICKETS | VOLUME OF CONCRETE | | TICKET DETAILS CHECKED BY: | ACTUAL SLUMP |
|-------------------|--------------------|---------------|----------------------------|--------------|
| | THIS TICKET | RUNNING TOTAL | | |
| 0365748 C45 mix 5 | 7.6 | 7.6 | W. Haney | 180 |
| 0365751 C45 mix 5 | 7.6 | 15.2 | " " | |
| 0365753 C45 mix 5 | 7.6 | 22.8 | " " | |
| 0365762 C45 mix 5 | 7.6 | 30.4 | " " | |
| 0365763 C45 mix 5 | 7.6 | 38.0 | " " | |
| 0365770 C45 mix 5 | 7.6 | 45.6 | " " | 180 |
| 0365771 C45 mix 5 | 7.6 | 53.2 | " " | |
| 0365774 C45 mix 5 | 7.6 | 60.8 | " " | |
| 0365776 C45 mix 5 | 7.6 | 68.4 | " " | |
| 0365778 C45 mix 5 | 7.6 | 76.0 | " " | 200 |
| 0365785 C45 mix 5 | 7.6 | 83.6 | " " | |
| 0365789 C60 mix 2 | 7.6 | 91.2 | " " | 190 |
| 0365790 C45 mix 5 | 7.6 | 98.8 | " " | |
| 0365793 C45 mix 5 | 7.6 | 106.4 | " " | |
| 0365794 C45 mix 5 | 7.6 | 114.0 | " " | |
| 0377101 C45 mix 5 | 7.6 | 121.6 | " " | |
| 0365813 C60 mix 4 | 7.6 | 129.2 | " " | 170 |
| 0365813 C45 mix 5 | 7.6 | 136.8 | " " | 180 |

A J MORRISROE & SONS LTD
CONCRETE LOG SHEET

| | | | |
|---|--------------------------|-----------------------------|--|
| PROJECT: [REDACTED] | | SHEET No. 85 | |
| CHECKLIST REF: H06A/C core slab @ grid lines = 10m ² | | WEATHER: Cloudy, humid 23°C | |
| AREA: Block H10c 1st floor = 50.9 m ² Block F lift shaft core = 10 m ² 1st floor | | | |
| DATE OF CONCRETE: 16/7/15 | TIME POUR STARTED: 1100 | | |
| TOTAL VOLUME OF CONCRETE: 78.9 m ³ | TIME POUR FINISHED: 1730 | | |
| MIX: [REDACTED] C45 mix 1 | SLUMP: 54 +/- mm | | |
| CEMENT TYPE: [REDACTED] CFM 1 | M.C.C. [REDACTED] 360 | | |
| W/C RATIO: 0.45 | AGGREGATE SIZE: 20mm | | |
| ADMIXTURE: Splas + RET | | | |

| CUBES TAKEN REF: | DELIVERY TICKET REF: | LOCATION OF CONCRETE |
|------------------|----------------------|----------------------|
| Apm MPI 233 A-F | 0229570 | As above highlighted |
| Apm MPI 234 A-F | 0229586 | - |
| Apm MPI 235 A-D | 0229600 | - |
| | | |
| | | |
| | | |
| | | |
| | | |
| | | |

SAMPLING CARRIED OUT BY: MADAN

| DELIVERY TICKETS | VOLUME OF CONCRETE | | TICKET DETAILS CHECKED BY: | ACTUAL SLUMP |
|-------------------|--------------------|---------------|----------------------------|--------------|
| | THIS TICKET | RUNNING TOTAL | | |
| [REDACTED] | 7.6 | 7.6 | [REDACTED] | [REDACTED] |
| 0229570 C45 mix 1 | 7.6 | 15.2 | - | 140 |
| 0229571 C45 mix 1 | 7.6 | 22.8 | | |
| 0229573 C45 mix 1 | 7.6 | 30.4 | | |
| 0229578 C45 mix 1 | 7.6 | 38.0 | | |
| 0229586 C45 mix 1 | 7.6 | 45.6 | | 170 |
| 0229588 C45 mix 1 | 7.6 | 53.2 | | |
| 0229592 C45 mix 1 | 7.6 | 60.8 | | |
| 0229596 C45 mix 1 | 7.6 | 68.4 | | |
| 0229600 C45 mix 1 | 7.6 | 76.0 | | |
| 0229605 C45 mix 1 | 2.9 | 78.9 | | |
| | | | | |
| | | | | |
| | | | | |
| | | | | |
| | | | | |

A J MORRISROE & SONS LTD
CONCRETE LOG SHEET

PROJECT: 20th Verticals Block D level 2 = 15.7m³
 CHECKLIST REF: Pair 4 SHEET No. 88
 AREA: Block Hioc raft slab = 288.8
 5th Columns H13A 3rd floor, 2nd cols + 2nd walls H13C 1st floor = 7.6m³
 WEATHER: overcast 20°C
 DATE OF CONCRETE: 20/7/15 TIME POUR STARTED: 0820
 TOTAL VOLUME OF CONCRETE: 311.6m³ TIME POUR FINISHED: 21:00
 MIX: C45 MIX 5, C60 MIX 2 SLUMP: 54 +/- mm
 CEMENT TYPE: CUB-V, C11B-V+SE M.C.C.: 340, 340
 W/C RATIO: 0.55, 0.55 AGGREGATE SIZE: 20mm
 ADMIXTURE: Splas, Splas+RET

| CUBES TAKEN REF: | DELIVERY TICKET REF: | LOCATION OF CONCRETE |
|---------------------|----------------------|-----------------------|
| Apm MPI 243 A-D | 0229796 | As above highlighted. |
| Apm MPI 244 A-D | 0229815 | --- |
| Apm MPI 245 A-D | 0229832 | --- |
| Apm MPI 246 A-D | 0229856 | --- |
| Apm MPI 247 A-D | 0229875 | --- |
| Apm MPI 248 A-D C60 | 0229874 | --- |
| Apm MPI 249 A-D | 0229889 | --- |

SAMPLING CARRIED OUT BY: MADAN

| DELIVERY TICKETS | VOLUME OF CONCRETE | | TICKET DETAILS CHECKED BY: | ACTUAL SLUMP |
|-------------------|--------------------|---------------|----------------------------|--------------|
| | THIS TICKET | RUNNING TOTAL | | |
| 0229796 C45 MIX 5 | 7.6 | 7.6 | L. Henry | 120 |
| 0229797 C45 MIX 5 | 7.6 | 15.2 | --- | --- |
| 0229798 C45 MIX 5 | 7.6 | 22.8 | --- | --- |
| 0229802 C45 MIX 5 | 7.6 | 30.4 | --- | --- |
| 0229803 C45 MIX 5 | 7.6 | 38.0 | --- | --- |
| 0229804 C45 MIX 5 | 7.6 | 45.6 | --- | --- |
| 0229806 C45 MIX 5 | 7.6 | 53.2 | --- | --- |
| 0229815 C45 MIX 5 | 7.6 | 60.8 | --- | 140 |
| 0229818 C45 MIX 5 | 7.6 | 68.4 | --- | --- |
| 0229830 C45 MIX 5 | 7.6 | 76.0 | --- | --- |
| 0229831 C45 MIX 5 | 7.6 | 83.6 | --- | --- |
| 0229832 C45 MIX 5 | 7.6 | 91.2 | --- | 110 |
| 0229834 C45 MIX 5 | 7.6 | 98.8 | --- | --- |
| 0229837 C45 MIX 5 | 7.6 | 106.4 | --- | --- |
| 0229840 C45 MIX 5 | 7.6 | 114.0 | --- | --- |
| 0229843 C45 MIX 5 | 7.6 | 121.6 | --- | --- |
| 0229844 C45 MIX 5 | 7.6 | 129.2 | --- | --- |
| 0229851 C45 MIX 5 | 7.6 | 136.8 | --- | --- |
| 0229856 C45 MIX 5 | 7.6 | 144.4 | --- | 160 |

M MORRISROE

7th Columns H13A 4th floor = 3.5m²

A J MORRISROE & SONS LTD

CONCRETE LOG SHEET

Block E liftcase 1st floor = 10m²
 PROJECT: SNA verticals block D = 11m²
 CHECKLIST REF: 1st wall 4th floor H10C = 7.6m² SHEET No. 99
 AREA: Block H10C level of floor 2 = 22.8m² WEATHER: overcast 21°C
 DATE OF CONCRETE: 05/08/15 TIME POUR STARTED: 15:05
 TOTAL VOLUME OF CONCRETE: 59.7m³ TIME POUR FINISHED: 17:05
 MIX: C45 mix 1, C60 mix 2 SLUMP: 54 +/- mm
 CEMENT TYPE: CEM I, C11B-V+SP M.C.C.: 360, 340
 W/C RATIO 0.45, 0.55 AGGREGATE SIZE: 20mm
 ADMIXTURE: Splas + RET, Splas + RET

| CUBES TAKEN REF: | DELIVERY TICKET REF: | LOCATION OF CONCRETE |
|------------------|----------------------|----------------------|
| Apr MPI 286 A-D | 0228659 | As above highlighted |
| Apr MPI 287 A-F | 0228680 | - |
| | | |
| | | |
| | | |
| | | |
| | | |
| | | |
| | | |
| | | |
| | | |

SAMPLING CARRIED OUT BY: MADAN

| DELIVERY TICKETS | VOLUME OF CONCRETE | | TICKET DETAILS CHECKED BY: | ACTUAL SLUMP |
|-------------------|--------------------|---------------|----------------------------|--------------|
| | THIS TICKET | RUNNING TOTAL | | |
| 0228680 C45 mix 1 | 7.6 | 7.6 | h. Henry | 165 |
| 0228681 C45 mix 1 | 7.6 | 15.2 | - | - |
| 0228685 C45 mix 1 | 7.6 | 22.8 | - | - |
| 0228689 C60 mix 2 | 7.6 | 30.4 | - | 180 |
| 0228688 C60 mix 2 | 7.6 | 38.0 | - | - |
| 0228692 C60 mix 2 | 7.6 | 45.6 | - | - |
| 0228700 C60 mix 2 | 6.5 | 52.1 | - | - |
| 0228693 C60 mix 2 | 7.6 | 59.7 | - | - |
| | | | | |
| | | | | |
| | | | | |
| | | | | |
| | | | | |
| | | | | |
| | | | | |
| | | | | |
| | | | | |
| | | | | |

A J MORRISROE & SONS LTD
CONCRETE LOG SHEET

PROJECT: *level 04*
 CHECKLIST REF: *Block H100 level 01 pour 3 = 80.5m³* SHEET No. *104*
 AREA: *1 No well Block D 3rd floor = 2m³* WEATHER: *overcast 20°C*
Schock bracket infills BIKD, level 03 & 7m³
 DATE OF CONCRETE: *11/8/15* TIME POUR STARTED: *12:20*
 TOTAL VOLUME OF CONCRETE: *85.2m³* TIME POUR FINISHED: *17:15*
 MIX: *C45 MIX 1, C60 MIX 2* SLUMP: *54 +/- mm*
 CEMENT TYPE: *CEM1, C11B-V+SP.* M.C.C.: *360, 340.*
 W/C RATIO *0.45, 0.55* AGGREGATE SIZE: *20mm*
 ADMIXTURE: *spas +RET, spas +RET*

| CUBES TAKEN REF: | DELIVERY TICKET REF: | LOCATION OF CONCRETE |
|------------------------|----------------------|------------------------------|
| <i>Apn MPI 300 A-D</i> | <i>0340925</i> | <i>As above highlighted.</i> |
| <i>Apn MPI 301 A-F</i> | <i>0197574</i> | <i>- -</i> |
| <i>Apn MPI 302 A-F</i> | <i>0197589</i> | <i>- -</i> |
| | | |
| | | |
| | | |
| | | |
| | | |
| | | |

SAMPLING CARRIED OUT BY: **MADAN**

| DELIVERY TICKETS | VOLUME OF CONCRETE | | TICKET DETAILS CHECKED BY: | ACTUAL SLUMP |
|--------------------------|--------------------|---------------|----------------------------|--------------|
| | THIS TICKET | RUNNING TOTAL | | |
| <i>0340925 C45 mix 1</i> | <i>7.6</i> | <i>7.6</i> | <i>L. Henry</i> | |
| <i>0340927 C45 mix 1</i> | <i>7.6</i> | <i>15.2</i> | <i>- -</i> | |
| <i>0197574 C45 mix 1</i> | <i>7.6</i> | <i>22.8</i> | <i>- -</i> | |
| <i>0340930 C45 mix 1</i> | <i>7.6</i> | <i>30.4</i> | <i>- -</i> | |
| <i>0197578 C45 mix 1</i> | <i>7.6</i> | <i>38.0</i> | <i>- -</i> | |
| <i>0197580 C45 mix 1</i> | <i>7.6</i> | <i>45.6</i> | <i>- -</i> | |
| <i>0340934 C45 mix 1</i> | <i>7.6</i> | <i>53.2</i> | <i>- -</i> | |
| <i>0197582 C45 mix 1</i> | <i>7.6</i> | <i>60.8</i> | <i>- -</i> | |
| <i>0197591 C45 mix 1</i> | <i>7.6</i> | <i>68.4</i> | <i>- -</i> | |
| <i>0197589 C45 mix 1</i> | <i>7.6</i> | <i>76.0</i> | <i>- -</i> | |
| <i>0340950 C45 mix 1</i> | <i>6.5</i> | <i>82.5</i> | <i>- -</i> | |
| <i>0340946 C60 mix 2</i> | <i>2.7</i> | <i>85.2</i> | <i>- -</i> | |
| | | | | |
| | | | | |
| | | | | |
| | | | | |
| | | | | |

A J MORRISROE & SONS LTD
CONCRETE LOG SHEET

| | | | |
|---|---|---------------------------|--|
| PROJECT: | | SHEET No. 112 | |
| CHECKLIST REF: | | WEATHER: Overcast 20°C | |
| AREA: | Black Hicc levoc pour 1 = 165.1m ³ | | |
| DATE OF CONCRETE: 20/6/15 | | TIME POUR STARTED: 10:05 | |
| TOTAL VOLUME OF CONCRETE: 163.1m ³ | | TIME POUR FINISHED: 19:30 | |
| MIX: Mix 6 C50 | | SLUMP: 54 +/- mm | |
| CEMENT TYPE: CEM I | | M.C.C.: - | |
| W/C RATIO - | | AGGREGATE SIZE: 20mm | |
| ADMIXTURE: SplasTRET | | | |

| CUBES TAKEN REF: | DELIVERY TICKET REF: | LOCATION OF CONCRETE |
|------------------|----------------------|-----------------------|
| Apn MPI 331 A-F | 0661163 | As above highlighted. |
| Apn MPI 332 A-F | 0661171 | - - |
| Apn MPI 333 A-F | 0661197 | - - |
| Apn MPI 334 A-F | 0661215 | - - |
| Apn MPI 335 A-F | 0661221 | - - |
| | | |
| | | |
| | | |
| | | |
| | | |

SAMPLING CARRIED OUT BY: MADAN

| DELIVERY TICKETS | VOLUME OF CONCRETE | | TICKET DETAILS CHECKED BY: | ACTUAL SLUMP |
|-------------------|--------------------|---------------|----------------------------|--------------|
| | THIS TICKET | RUNNING TOTAL | | |
| 0661162 C50 Mix 6 | 7.6 | 7.6 | L. Henry | |
| 0661163 C50 Mix 6 | 7.6 | 15.2 | - - | 150 |
| 0661168 C50 Mix 6 | 7.6 | 22.8 | - - | |
| 0661169 C50 Mix 6 | 7.6 | 30.4 | - - | |
| 0661170 C50 Mix 6 | 7.6 | 38.0 | - - | |
| 0661171 C50 Mix 6 | 7.6 | 45.6 | - - | 140 |
| 0661172 C50 Mix 6 | 7.6 | 53.2 | - - | |
| 0661177 C50 Mix 6 | 7.6 | 60.8 | - - | |
| 0661194 C50 Mix 6 | 7.6 | 68.4 | - - | |
| 0661197 C50 Mix 6 | 7.6 | 76.0 | - - | 140 |
| 0661206 C50 Mix 6 | 7.6 | 83.6 | - - | |
| 0661207 C50 Mix 6 | 7.6 | 91.2 | - - | |
| 0661214 C50 Mix 6 | 7.6 | 98.8 | - - | |
| 0661215 C50 Mix 6 | 7.6 | 106.4 | - - | 160 |
| 0661216 C50 Mix 6 | 7.6 | 114.0 | - - | |
| 0661219 C50 Mix 6 | 7.6 | 121.6 | - - | |
| 0661221 C50 Mix 6 | 7.6 | 129.2 | - - | 180 |
| 0661225 C50 Mix 6 | 7.6 | 136.8 | - - | |

| A J MORRISROE & SONS LTD | | | | | |
|---|--------------------|----------------------|----------------------------|---------------------------|--|
| CONCRETE LOG SHEET | | | | | |
| PROJECT: MPI | | | | | |
| CHECKLIST REF: H10C Level 2 pour 2 = 186.4m ³ | | | | SHEET No. 119 | |
| AREA: H06F Level 2 U-wall, lift core = 18.8m ³ | | | | WEATHER: clear skies 19°C | |
| DATE OF CONCRETE: 28/08/18 | | | TIME POUR STARTED: 10:30 | | |
| TOTAL VOLUME OF CONCRETE: 217.8m ³ | | | TIME POUR FINISHED: 18:00 | | |
| MIX: C50 Max 6 30mm | | | SLUMP: 54 +/- mm | | |
| CEMENT TYPE: CEM1 | | | M.C.C.: 340 | | |
| W/C RATIO: 0.55 | | | AGGREGATE SIZE: 20mm | | |
| ADMIXTURE: SP18H1ET | | | | | |
| CUBES TAKEN REF: | | DELIVERY TICKET REF: | | LOCATION OF CONCRETE | |
| AJM MPI 356A-F | | 0658214 | | As above highlighted | |
| 357A-F | | 0658227 | | ↓ | |
| 358A-F | | 0658239 | | | |
| 359A-D | | 0658242 | | | |
| 360A-D | | 0658267 | | | |
| | | | | | |
| | | | | | |
| | | | | | |
| | | | | | |
| | | | | | |
| | | | | | |
| SAMPLING CARRIED OUT BY: | | Madam | | | |
| DELIVERY TICKETS | VOLUME OF CONCRETE | | TICKET DETAILS CHECKED BY: | ACTUAL SLUMP | |
| | THIS TICKET | RUNNING TOTAL | | | |
| 0658214 C50 Max 6 | 7.6 | 7.6 | SILW10351009 | 185 | |
| 0666156 | | 15.2 | | | |
| 0666157 | | 22.8 | | | |
| 0658222 | | 30.4 | | | |
| 0666161 | | 38 | | | |
| 0658223 | | 45.6 | | | |
| 0658224 | | 53.2 | | | |
| 0658227 | | 60.8 | | 710 | |
| 0666164 | | 68.4 | | | |
| 0658229 | | 76 | | | |
| 0658228 | | 83.6 | | | |
| 0666165 | | 91.2 | | | |
| 0658232 | | 98.8 | | | |
| 0658231 | | 106.4 | | | |
| 0666168 | | 114 | | | |
| 0666170 | | 121.6 | | | |
| 0658239 | ✓ | 129.2 | ✓ | 190 | |
| | ✓ | 136.8 | ✓ | | |

A J MORRISROE & SONS LTD

CONCRETE LOG SHEET

PROJECT: MPI H13A level 6 upstand + 6 no columns = 3.8m³ H10C level 2 pour 3 = 109.7m³

CHECKLIST REF: H10C level 3 6 no columns = 3m³

SHEET No. 123

AREA: H06E level 2 u-wall = 2.6m³

H06C level 3 stair case + u-wall = 18m³

WEATHER: mild, dry 18.5°C

DATE OF CONCRETE: 03/09/15

TIME POUR STARTED:

TOTAL VOLUME OF CONCRETE: 129.6m³

TIME POUR FINISHED:

MIX: CS0 M16.6 CS0 M16.2

SLUMP: 54 +/- mm

CEMENT TYPE: CEM1 C13-V+SR

M.C.C.: - 340

W/C RATIO: - 0.55

AGGREGATE SIZE: 20mm

ADMIXTURE: SPUS+RET SPUS+RET

| CUBES TAKEN REF: | DELIVERY TICKET REF: | LOCATION OF CONCRETE |
|------------------|----------------------|----------------------|
| A.S.M.MPI 376A-F | 06S91032 | As above highlighted |
| 377A-F | 0666332 | |
| 378A-D | 06S91052 | |
| 379A-D | 06S91082 | |
| 370A-D | 06S1074 | |
| | | |
| | | |
| | | |
| | | |
| | | |
| | | |
| | | |

SAMPLING CARRIED OUT BY: Madan

| DELIVERY TICKETS | VOLUME OF CONCRETE | | TICKET DETAILS CHECKED BY: | ACTUAL SLUMP |
|--------------------|--------------------|---------------|----------------------------|--------------|
| | THIS TICKET | RUNNING TOTAL | | |
| 06S91032 CS0-M16.6 | 7.6 | 7.6 | J. WILKINSON | 185 |
| 06S91058 | | 15.2 | | |
| 06S91039 | | 22.8 | | |
| 06S91040 | | 30.4 | | |
| 06S91043 | | 38 | | |
| 06S91046 | | 45.6 | | |
| 06S91048 | | 53.2 | | |
| 0666331 | | 60.8 | | |
| 0666332 | | 68.4 | | 190 |
| 06S91051 | | 76 | | |
| 06S91052 | | 83.6 | | |
| 06S91054 | | 91.2 | | |
| 0666338 | | 98.8 | | |
| 0666341 | | 106.4 | | |
| 06S91082 | | 114 | | 195 |
| 06S91087 ✓ | | 121.6 | | |
| 06S91074 CS0 M16.2 | | 129.2 | | |
| 06S91084 ✓ | ✓ | 136.8 | | |
| 06S91090 ✓ | 2.8 | 139.6 | | |

A J MORRISROE & SONS LTD

CONCRETE LOG SHEET

PROJECT: *MPI H13A level 2 cup board + 6 no columns = 3.8m³ H10C level 2 pour 3 = 129.7m³*
 CHECKLIST REF: *H10C level 3 6 no columns = 3m³* SHEET No. *123*
 AREA: *H06E level 2 u-wall = 7.6m³ H06C level 3 staircase + u-wall = 18m³* WEATHER: *partly dry 18.5°C*
 DATE OF CONCRETE: *03/09/15* TIME POUR STARTED:
 TOTAL VOLUME OF CONCRETE: *139.6m³* TIME POUR FINISHED:
 MIX: *C50/Mix 6 C60/Mix 2* SLUMP: *54 +/- mm*
 CEMENT TYPE: *CEM1 C13-V+SR* M.C.C.: *- 340*
 W/C RATIO *- 0.55* AGGREGATE SIZE: *20mm*
 ADMIXTURE: *SPURS+RET SPURS+RET*

| CUBES TAKEN REF: | DELIVERY TICKET REF: | LOCATION OF CONCRETE |
|-------------------------|----------------------|-----------------------------|
| <i>A.S.M.MPI 376A-F</i> | <i>06S91032</i> | <i>to above highlighted</i> |
| <i>377A-F</i> | <i>0666332</i> | |
| <i>378A-D</i> | <i>06S91052</i> | |
| <i>379A-D</i> | <i>06S91082</i> | |
| <i>380A-D</i> | <i>06S1074</i> | |
| | | |

SAMPLING CARRIED OUT BY: *Madan*

| DELIVERY TICKETS | VOLUME OF CONCRETE | | TICKET DETAILS CHECKED BY: | ACTUAL SLUMP |
|---------------------------|--------------------|---------------|----------------------------|--------------|
| | THIS TICKET | RUNNING TOTAL | | |
| <i>06S91032 C50-Mix 6</i> | <i>7.6</i> | <i>7.6</i> | <i>J. WINGGERSLOOT</i> | <i>185</i> |
| <i>06S91038</i> | | <i>15.2</i> | | |
| <i>06S91039</i> | | <i>22.8</i> | | |
| <i>06S91040</i> | | <i>30.4</i> | | |
| <i>06S91043</i> | | <i>38</i> | | |
| <i>06S91046</i> | | <i>45.6</i> | | |
| <i>06S91048</i> | | <i>53.2</i> | | |
| <i>0666331</i> | | <i>60.8</i> | | |
| <i>0666332</i> | | <i>68.4</i> | | <i>190</i> |
| <i>06S91051</i> | | <i>76</i> | | |
| <i>06S91052</i> | | <i>83.6</i> | | |
| <i>06S91054</i> | | <i>91.2</i> | | |
| <i>0666338</i> | | <i>98.8</i> | | |
| <i>0666341</i> | | <i>106.4</i> | | |
| <i>06S91082</i> | | <i>114</i> | | <i>195</i> |
| <i>06S91087</i> ✓ | | <i>121.6</i> | | |
| <i>06S1074 C60-Mix 2</i> | | <i>129.2</i> | | |
| <i>06S1084</i> | ✓ | <i>136.8</i> | | |
| <i>06S1090</i> ✓ | <i>2.8</i> | <i>139.6</i> | ✓ | |

MORRISROE

Block D level of brace slab = 21m³

Basement drainage = 4.0

A J MORRISROE & SONS LTD

CONCRETE LOG SHEET

15th vete Block

PROJECT: Block D balcony slab level 02 infill slab = 7.6m³

CHECKLIST REF: Block D ground floor + 2nd floor reinforcement = 6m³ SHEET No. 129

AREA: Block D level of pour 2 = 52m³
Block D jump core 10th - 11th = 25m³ WEATHER: Sunny, mild 21°C

DATE OF CONCRETE: 11/9/15 TIME POUR STARTED: 09:35

TOTAL VOLUME OF CONCRETE: 193.6m³ TIME POUR FINISHED: 18:25

MIX: C45 mix 1, C60 mix 2 SLUMP: 54 +/- mm

CEMENT TYPE: CEM I, C11B-U+SP M.C.C.: 350, 340

W/C RATIO 0.45, 0.55 AGGREGATE SIZE: 20mm

ADMIXTURE: Splas + RET, Splas + RET

| CUBES TAKEN REF: | DELIVERY TICKET REF: | LOCATION OF CONCRETE |
|---------------------|----------------------|----------------------|
| Agm MPI 406 A-F | 0350133 | As above highlighted |
| Agm MPI 407 A-F | 0350150 | As above highlighted |
| Agm MPI 408 A-F | 0350152 | As above highlighted |
| Agm MPI 409 A-F | 0676193 | As above highlighted |
| Agm MPI 410 A-F | 0676198 | As above highlighted |
| Agm MPI 411 A-D c60 | 0676205 | As above highlighted |
| | | |
| | | |
| | | |
| | | |

SAMPLING CARRIED OUT BY: MADAN

| DELIVERY TICKETS | VOLUME OF CONCRETE | | TICKET DETAILS CHECKED BY: | ACTUAL SLUMP |
|------------------|--------------------|---------------|----------------------------|--------------|
| | THIS TICKET | RUNNING TOTAL | | |
| 0350133 C45 mix | 7.6 | 7.6 | hllay | 190 |
| 0350136 | 7.6 | 15.2 | - | |
| 0350138 | 7.6 | 22.8 | - | |
| 0350140 | 5.6 | 28.4 | - | |
| 0350142 | 7.6 | 36.0 | - | |
| 0350147 | 7.6 | 43.6 | - | |
| 0350150 | 7.6 | 51.2 | - | |
| 0350151 | 7.6 | 58.8 | - | |
| 0350152 | 5.6 | 64.4 | - | |
| 0350155 | 7.6 | 72 | - | |
| 0676180 | 7.6 | 79.6 | - | |
| 0676182 | 7.6 | 87.2 | - | |
| 0676186 | 7.6 | 94.8 | - | |
| 0676188 | 7.6 | 102.4 | - | |
| 0676191 | 7.6 | 110 | - | |
| 0676193 | 7.6 | 117.6 | - | |
| 0676195 | 7.6 | 125.2 | - | |
| 0676198 | 7.6 | 132.8 | - | |

A J MORRISROE & SONS LTD

CONCRETE LOG SHEET

PROJECT: H13A 2nd floor staircase + 2 no wells = 14m³ SHEET No. 132

CHECKLIST REF: Block E 3rd floor staircase + 2 no wells = 14m³ SHEET No. 132

AREA: Block C level OS = 77 m³
Block C upstairs level OS = 1.3 m³ WEATHER: Unsettled 16°C

DATE OF CONCRETE: 15/09/15 TIME POUR STARTED: 0840

TOTAL VOLUME OF CONCRETE: 163.8 m³ TIME POUR FINISHED: 1800

MIX: C60 mix 2, C45 mix 1, C45 mix 5 SLUMP: 5 +/- mm

CEMENT TYPE: CUB-USE, CEM, CUB-V, CEM M.C.C.: 340, 360, 390, 360

W/C RATIO 0.55, 0.45, 0.55, 0.45 AGGREGATE SIZE: 20mm

ADMIXTURE: Splas+RET, Splas, Splas, Splas+RET

| CUBES TAKEN REF: | DELIVERY TICKET REF: | LOCATION OF CONCRETE |
|------------------|----------------------|----------------------|
| Apr mpt 419 A-D | 0676387 | As above highlighted |
| Apr mpt 420 A-F | 0676398 | - |
| Apr mpt 421 A-F | 0676405 | - |
| Apr mpt 422 A-D | 0676422 | - |
| Apr mpt 423 A-F | 0676428 | - |
| | | |
| | | |
| | | |
| | | |
| | | |

SAMPLING CARRIED OUT BY: Madan

| DELIVERY TICKETS | VOLUME OF CONCRETE | | TICKET DETAILS CHECKED BY: | ACTUAL SLUMP |
|-----------------------|--------------------|---------------|----------------------------|--------------|
| | THIS TICKET | RUNNING TOTAL | | |
| 0676387 C60 mix 2 | 7.6 | 7.6 | L. Haney | 180 |
| 0676394 C60 mix 2 | 7.6 | 15.2 | - | - |
| 0676398 C45 mix 1 | 7.6 | 22.8 | - | - |
| 0676399 C45 mix 1 | 7.6 | 30.4 | - | - |
| 0676400 C45 mix 1 | 7.6 | 38.0 | - | - |
| 0676401 C45 mix 1 | 7.6 | 45.6 | - | - |
| 0676402 C45 mix 1 | 7.6 | 53.2 | - | - |
| 0676405 C45 mix 1 | 7.6 | 60.8 | - | - |
| 0676407 C45 mix 1 | 7.6 | 68.4 | - | - |
| 0676408 C45 mix 1 | 7.6 | 76.0 | - | - |
| 0676413 C45 mix 1 | 7.6 | 83.6 | - | - |
| 0676418 C45 mix 1 | 7.6 | 91.2 | - | - |
| 0676425 C45 mix 1 | 7.6 | 98.8 | - | - |
| 0676437 C45 mix 1 | 7.6 | 106.4 | - | - |
| 0676422 C45 mix 5 | 7.6 | 114.0 | - | - |
| 0676428 C45 mix 5 | 7.6 | 121.6 | - | - |
| 0676431 C45 mix 1 (H) | 7.6 | 129.2 | - | - |
| 0676434 C45 mix 1 (H) | 7.6 | 136.8 | - | - |
| 0676437 C45 mix 1 (H) | 7.6 | 144.4 | - | - |

31 MORRISROE Black Hhoc 6th floor 2nd wall + 1st col = 3^{m3}

A J MORRISROE & SONS LTD
CONCRETE LOG SHEET

PROJECT: Black Hhoc level of pour 1 = 34.5^{m3}
 CHECKLIST REF: Black Hhoc 3rd floor 7th cols = 3.5^{m3} SHEET No. 133
 AREA: Black F level of pour 1 = 45.6^{m3} WEATHER: Torrential rain all day 14°C
 Basement car park slab pour 9 = 53.2^{m3}
 DATE OF CONCRETE: 16/9/15 TIME POUR STARTED: 09:25
 TOTAL VOLUME OF CONCRETE: 144.3^{m3} TIME POUR FINISHED: 17:25
 MIX: C45 MIX 1, C45 MIX 5, C60 MIX 2 SLUMP: 54 +/- mm
 CEMENT TYPE: CEM I, CUB V, CUB V+SR M.C.C.: 360, 340, 340
 W/C RATIO 0.45, 0.55, 0.55 AGGREGATE SIZE: 20mm
 ADMIXTURE: splas+RET, splas, splas+RET

| CUBES TAKEN REF: | DELIVERY TICKET REF: | LOCATION OF CONCRETE |
|------------------|----------------------|-----------------------|
| Agm MPI 424 A-F | 0676469 | As above highlighted, |
| Agm MPI 425 A-D | 0676485 | - |
| Agm MPI 426 A-D | 0671502 | - |
| Agm MPI 427 A-F | 0671522 | - |
| Agm MPI 428 A-D | 0671536 | - |
| | | |
| | | |
| | | |
| | | |
| | | |

SAMPLING CARRIED OUT BY: MADAN

| DELIVERY TICKETS | VOLUME OF CONCRETE | | TICKET DETAILS CHECKED BY: | ACTUAL SLUMP |
|-------------------|--------------------|---------------|----------------------------|--------------|
| | THIS TICKET | RUNNING TOTAL | | |
| 0676469 C45 mix 1 | 7.6 | 7.6 | W. King | 190 |
| 0676471 | 7.6 | 15.2 | - | - |
| 0676472 | 7.6 | 22.8 | - | - |
| 0676477 | 7.6 | 30.4 | - | - |
| 0676478 | 7.6 | 38.0 | - | - |
| 0676482 | 7.6 | 45.6 | - | - |
| 0676483 C45 mix 5 | 7.6 | 53.2 | - | - |
| 0676485 | 7.6 | 60.8 | - | 115 |
| 0676488 | 7.6 | 68.4 | - | - |
| 0676496 | 7.6 | 76.0 | - | - |
| 0676500 | 7.6 | 83.6 | - | - |
| 0671502 | 7.6 | 91.2 | - | 160 |
| 0671509 | 7.6 | 98.8 | - | - |
| 0671516 C45 mix 1 | 7.6 | 106.4 | - | - |
| 0671519 | 7.6 | 114 | - | - |
| 0671522 | 7.6 | 121.6 | - | 200 |
| 0671528 | 7.6 | 129.2 | - | - |
| 0671530 | 7.6 | 136.8 | - | - |
| 0671529 C60 MIX 2 | 7.6 | 144.4 | - | 190 |

MORRISROE BIK H13A roof upstand = 2m³
 BIK H13C 4th floor column = 1m³ BIK H13C 5th floor 5th cols + 2m³

A J MORRISROE & SONS LTD
CONCRETE LOG SHEET

PROJECT:
 CHECKLIST REF: SHEET No. 139
 AREA: H10B raft slab pour 2 = 76m³
 H10C level 03 pour 4 = 44m³ WEATHER: Sunny mild 20°C
 DATE OF CONCRETE: 23/9/15 TIME POUR STARTED: 0940
 TOTAL VOLUME OF CONCRETE: 148.6m³ TIME POUR FINISHED: 1745
 MIX: C45 mix 5, C45 mix 1, C60 mix 2 SLUMP: 54 +/- mm
 CEMENT TYPE: CWB, CEM1, C113-VR SL M.C.C.: 340, 360, 340
 W/C RATIO 0.55, 0.45, 0.55 AGGREGATE SIZE: 20mm
 ADMIXTURE: splas, splas + RET, splas + ret.

| CUBES TAKEN REF: | DELIVERY TICKET REF: | LOCATION OF CONCRETE |
|------------------|----------------------|----------------------|
| Apn MPI 447 A-D | 0671951 | As above highlighted |
| Apn MPI 448 A-D | 0671961 | |
| Apn MPI 449 A-F | 0671972 | |
| Apn MPI 450 A-D | 0665508 | |
| | | |
| | | |
| | | |
| | | |
| | | |
| | | |

SAMPLING CARRIED OUT BY: MADAN

| DELIVERY TICKETS | VOLUME OF CONCRETE | | TICKET DETAILS CHECKED BY: | ACTUAL SLUMP |
|-------------------|--------------------|---------------|----------------------------|--------------|
| | THIS TICKET | RUNNING TOTAL | | |
| 0671950 C45 mix 5 | 7.6 | 7.6 | h. h. h. | |
| 0671951 C45 mix 5 | 7.6 | 15.2 | | 200 |
| 0671952 C45 mix 5 | 7.6 | 22.8 | | |
| 0671955 C45 mix 5 | 7.6 | 30.4 | | |
| 0671958 C45 mix 5 | 7.6 | 38.0 | | |
| 0671960 C45 mix 5 | 7.6 | 45.6 | | |
| 0671961 C45 mix 5 | 7.6 | 53.2 | | 180 |
| 0671963 C45 mix 5 | 7.6 | 60.8 | | |
| 0671964 C45 mix 5 | 7.6 | 68.4 | | |
| 0671965 C45 mix 5 | 7.6 | 76.0 | | |
| 0671967 C45 mix 1 | 7.6 | 83.6 | | |
| 0671969 C45 mix 1 | 7.6 | 91.2 | | |
| 0671972 C45 mix 1 | 4.6 | 98.8 | | 175 |
| 0671974 C45 mix 1 | 7.6 | 106.4 | | |
| 0671984 C45 mix 1 | 7.6 | 114.0 | | |
| 0671985 C45 mix 1 | 7.6 | 121.6 | | |
| 0671988 C45 mix 1 | 7.6 | 129.2 | | |
| 0665509 C45 mix 1 | 7.6 | 136.8 | | |
| 0665514 C45 mix 1 | 4.2 | 141.0 | | |

M MORRISROE

Block F level 05 1400 columns = 7m³ + 1m³ wall = 8m³, H13A left

A J MORRISROE & SONS LTD
CONCRETE LOG SHEET

| | | | |
|---------------------------|---|---------------------------|--|
| PROJECT: | | SHEET No. 146 | |
| CHECKLIST REF: | | WEATHER: Sunny mid 18°C | |
| AREA: | Block H10C level 04 = 109.3m ³ Block D jumpcore level 13 = 24.5m ³ | | |
| DATE OF CONCRETE: | 01/10/15 | TIME POUR STARTED: 11:35 | |
| TOTAL VOLUME OF CONCRETE: | 172.8m ³ | TIME POUR FINISHED: 19:05 | |
| MIX: | C45 mix 1 | SLUMP: 84 +/- mm | |
| CEMENT TYPE: | CEM I | M.C.C.: 360 | |
| W/C RATIO: | 0.45 | AGGREGATE SIZE: 20mm | |
| ADMIXTURE: | Splas + RET | | |

| CUBES TAKEN REF: | DELIVERY TICKET REF: | LOCATION OF CONCRETE |
|------------------|----------------------|-----------------------|
| Apn mp1 474 A-F | 0677666 | As above highlighted. |
| Apn mp1 475 A-F | 0677690 | - |
| Apn mp1 476 A-F | 0677693 | - |
| Apn mp1 477 A-F | 0677730 | - |
| | | |
| | | |
| | | |
| | | |
| | | |
| | | |

SAMPLING CARRIED OUT BY: MADAN

| DELIVERY TICKETS | VOLUME OF CONCRETE | | TICKET DETAILS CHECKED BY: | ACTUAL SLUMP |
|-------------------|--------------------|---------------|----------------------------|--------------|
| | THIS TICKET | RUNNING TOTAL | | |
| 0677666 C45 mix 1 | 7.6 | 7.6 | L. Henry | |
| 0677676 | 7.6 | 15.2 | - | |
| 0677678 | 7.6 | 22.8 | - | |
| 0677688 | 7.6 | 30.4 | - | |
| 0677689 | 7.6 | 38.0 | - | |
| 0677690 | 7.6 | 45.6 | - | |
| 0677693 | 7.6 | 53.2 | - | |
| 0677698 | 7.6 | 60.8 | - | |
| 0677700 | 7.6 | 68.4 | - | |
| 0677702 | 7.6 | 76.0 | - | |
| 0677706 | 7.6 | 83.6 | - | |
| 0677714 | 7.6 | 91.2 | - | |
| 0677715 | 7.6 | 98.8 | - | |
| 0677719 | 7.6 | 106.4 | - | |
| 0677726 | 7.6 | 114 | - | |
| 0659577 | 5.6 | 119.6 | - | |
| 0677730 | 7.6 | 127.2 | - | |
| 0677731 | 7.6 | 134.8 | - | |

A J MORRISROE & SONS LTD
CONCRETE LOG SHEET

PROJECT: Block E+F 1st of pair 1 = 24.5m³ /
 CHECKLIST REF: Block H10C 1st of pair 3 = 63.5m³ / SHEET No. 158
 AREA: Block E+F 1st of pair 3 = 70m³ /
 HOGA ramp = 7m³ / WEATHER:
 DATE OF CONCRETE: 15/10/15 TIME POUR STARTED: 09:30
 TOTAL VOLUME OF CONCRETE: 195.6m³ TIME POUR FINISHED: 16:55
 MIX: C45 Mix 1 (NO RET + RET) SLUMP: +/- mm
 CEMENT TYPE: CEM1 M.C.C.:
 W/C RATIO 0.45 AGGREGATE SIZE: 20mm
 ADMIXTURE: Splas / splas + RET

| CUBES TAKEN REF: | DELIVERY TICKET REF: | LOCATION OF CONCRETE |
|--------------------------|----------------------|-----------------------|
| Ajm MPI S13 A-F | 0675731 | As above highlighted. |
| Ajm MPI S14 A-F | 0660225 | |
| Ajm MPI S15 A-D H3 verbs | 0660235 | |
| Ajm MPI S16 A-F | 0675761 | |
| Ajm MPI S17 A-F | 0675784 | |
| | | |
| | | |
| | | |
| | | |
| | | |

SAMPLING CARRIED OUT BY: MADAN

| DELIVERY TICKETS | VOLUME OF CONCRETE | | TICKET DETAILS CHECKED BY: | ACTUAL SLUMP |
|----------------------|--------------------|---------------|----------------------------|--------------|
| | THIS TICKET | RUNNING TOTAL | | |
| 0675730 Mix 1 NO RET | 7.6 | 7.6 | L. Henry | |
| 0675731 | 7.6 | 15.2 | - - | 175 |
| 0660221 | 7.6 | 22.8 | - - | |
| 0675735 | 7.6 | 30.4 | - - | |
| 0660225 | 7.6 | 38.0 | - - | 190 |
| 0660232 | 5.6 | 43.6 | - - | |
| 0660233 | 7.6 | 51.2 | - - | |
| 0675740 | 7.6 | 58.8 | - - | |
| 0675742 | 7.6 | 66.4 | - - | |
| 0660235 Mix 1 + RET | 7.6 | 74 | - - | 175 |
| 0675749 | 7.6 | 81.6 | - - | |
| 0660237 | 5.6 | 87.2 | - - | |
| 0660238 | 7.6 | 94.8 | - - | |
| 0675756 | 7.6 | 102.4 | - - | |
| 0675761 | 7.6 | 110.0 | - - | 175 |
| 0346641 | 7.6 | 117.6 | - - | |
| 0675772 | 7.6 | 125.2 | - - | |
| 0675776 | 7.6 | 132.8 | - - | |

A J MORRISROE & SONS LTD

CONCRETE LOG SHEET

PROJECT: HISC Core wall extension = 1.5m

CHECKLIST REF: _____ SHEET No. 159

AREA: Block 0 level to par 1 = 87m³ WEATHER: Overcast 15°C

DATE OF CONCRETE: 16/10/15 TIME POUR STARTED: 10:00

TOTAL VOLUME OF CONCRETE: 123.6m³ TIME POUR FINISHED: 17:45

MIX: C45 mix 1 + RET SLUMP: 84 +/- mm

CEMENT TYPE: CEM I (EM1) M.C.C.: 340, 360

W/C RATIO: 0.55, 0.45 AGGREGATE SIZE: 20mm

ADMIXTURE: Superplastic, splash RET

| CUBES TAKEN REF: | DELIVERY TICKET REF: | LOCATION OF CONCRETE |
|-----------------------------|----------------------|-----------------------------|
| <u>As highlighted above</u> | <u>0675821</u> | <u>As highlighted above</u> |
| <u>Am mpi 519 A-F</u> | <u>0675822</u> | <u>- -</u> |
| <u>Am mpi 520 A-F</u> | <u>0675838</u> | <u>- -</u> |
| | | |
| | | |
| | | |
| | | |
| | | |
| | | |

SAMPLING CARRIED OUT BY: MADAN

| DELIVERY TICKETS | VOLUME OF CONCRETE | | TICKET DETAILS CHECKED BY: | ACTUAL SLUMP |
|--------------------------------|--------------------|---------------|----------------------------|--------------|
| | THIS TICKET | RUNNING TOTAL | | |
| <u>0675821 C45 mix 1</u> | <u>7.6</u> | <u>7.6</u> | <u>6 1/2</u> | <u>20</u> |
| <u>0675822</u> | <u>11.6</u> | <u>11.6</u> | <u>-</u> | <u>-</u> |
| <u>0675822 C45 mix 1 + RET</u> | <u>7.6</u> | <u>19.2</u> | <u>- -</u> | <u>190</u> |
| <u>0675823</u> | <u>7.6</u> | <u>26.8</u> | <u>- -</u> | <u>-</u> |
| <u>0675825</u> | <u>7.6</u> | <u>34.4</u> | <u>- -</u> | <u>-</u> |
| <u>0675829</u> | <u>7.6</u> | <u>42.0</u> | <u>- -</u> | <u>-</u> |
| <u>0675832</u> | <u>7.6</u> | <u>49.6</u> | <u>- -</u> | <u>-</u> |
| <u>0675838</u> | <u>7.6</u> | <u>57.2</u> | <u>- -</u> | <u>-</u> |
| <u>0675839</u> | <u>7.6</u> | <u>64.8</u> | <u>- -</u> | <u>-</u> |
| <u>0675840</u> | <u>7.6</u> | <u>72.4</u> | <u>- -</u> | <u>-</u> |
| <u>0675841</u> | <u>7.6</u> | <u>80.0</u> | <u>- -</u> | <u>-</u> |
| <u>0675848</u> | <u>7.6</u> | <u>87.6</u> | <u>- -</u> | <u>-</u> |
| <u>0675849</u> | <u>7.6</u> | <u>95.2</u> | <u>- -</u> | <u>-</u> |
| <u>0675850</u> | <u>7.6</u> | <u>102.8</u> | <u>- -</u> | <u>-</u> |
| <u>0675852</u> | <u>7.6</u> | <u>110.4</u> | <u>- -</u> | <u>-</u> |
| <u>0675851</u> | <u>7.6</u> | <u>118.0</u> | <u>- -</u> | <u>-</u> |
| <u>0675859</u> | <u>5.6</u> | <u>123.6</u> | <u>- -</u> | <u>-</u> |

A J MORRISROE & SONS LTD

CONCRETE LOG SHEET

PROJECT: Block E level 05 staircase + riser wall + stairwell = 14.5m²

CHECKLIST REF: SHEET No. 162

AREA: Block F 11 no cols level 06 = 5.5m²
Block D 6 no walls = 11.3 - level 10 WEATHER:

DATE OF CONCRETE: 20/10/15 TIME POUR STARTED: 09:10

TOTAL VOLUME OF CONCRETE: 163.1m³ TIME POUR FINISHED: 18:20

MIX: C45 mix 1B + C45 mix 1A SLUMP: 54/- mm

CEMENT TYPE: C11B-V4SR / CEM1 M.C.C.: 340, 360

W/C RATIO 0.55 0.45 AGGREGATE SIZE: 20mm

ADMIXTURE: Splas, splas + RET

| CUBES TAKEN REF: | DELIVERY TICKET REF: | LOCATION OF CONCRETE |
|------------------|----------------------|----------------------|
| Agm mpl 528 A-F | 0656523 | As above highlighted |
| Agm mpl 529 A-F | 0656536 | - |
| Agm mpl 530 A-F | 0656547 | - |
| Agm mpl 531 A-F | 0656542 | - |
| | | |
| | | |
| | | |
| | | |
| | | |
| | | |

SAMPLING CARRIED OUT BY: MADAN

| DELIVERY TICKETS | VOLUME OF CONCRETE | | TICKET DETAILS CHECKED BY: | ACTUAL SLUMP |
|--------------------|--------------------|---------------|----------------------------|--------------|
| | THIS TICKET | RUNNING TOTAL | | |
| 0656519 C45 mix 1B | 7.6 | 7.6 | L. Henry | 205 |
| 0656523 | 7.6 | 15.2 | - | 210 |
| 0656525 | 7.6 | 22.8 | - | 215 |
| 0656530 | 7.6 | 30.4 | - | 200 |
| 0656535 | 7.6 | 38.0 | - | |
| 0656536 | 7.6 | 45.6 | - | |
| 0656540 | 7.6 | 53.2 | - | |
| 0656542 | 7.6 | 60.8 | - | |
| 0656547 | 7.6 | 68.4 | - | |
| 0656550 | 7.6 | 76.0 | - | |
| 0656553 | 7.6 | 83.6 | - | |
| 0656559 C45 mix 1A | 7.6 | 91.2 | - | |
| 0656562 | 7.6 | 98.8 | - | |
| 0656574 | 7.6 | 106.4 | - | |
| 0656567 | 7.6 | 114 | - | |
| 0656584 | 7.6 | 121.6 | - | |
| 0656586 | 7.6 | 129.2 | - | |
| 0656592 | 7.6 | 136.8 | - | |

Block H13c upstairs roof = 3m²

A J MORRISROE & SONS LTD

CONCRETE LOG SHEET Block H13c stairs F9+F10 = 3m²

PROJECT: Block H13c roof pour 2 = 40m³, Block H10c level 06 pour 2 = 27m³

CHECKLIST REF: SHEET No. 163

AREA: Basement left ramp = 228m²
 WEATHER: Wet rain all day 15°C

DATE OF CONCRETE: 21/10/15 TIME POUR STARTED: 10:30

TOTAL VOLUME OF CONCRETE: 1216m³ TIME POUR FINISHED: 18:00

MIX: 45 MIX 5, 45 MIX 1A, 45 MIX 4
 SLUMP: 54 +/- mm

CEMENT TYPE: CUB 5, CEM I, CEM I
 M.C.C. 340, 360, 380

W/C RATIO 0.55, 0.45, 0.55
 AGGREGATE SIZE: 20mm

ADMIXTURE: SPAS, splasRET, -plex RET

| CUBES TAKEN REF: | DELIVERY TICKET REF: | LOCATION OF CONCRETE |
|------------------|----------------------|----------------------|
| Apm MPI 533 A-F | 0656653 | - |
| Apm MPI 534 A-F | 0656682 | - |
| Apm MPI 535 A-F | 0656685 | - |
| | | |
| | | |
| | | |
| | | |
| | | |
| | | |

SAMPLING CARRIED OUT BY: MADAN

| DELIVERY TICKETS | VOLUME OF CONCRETE | | TICKET DETAILS CHECKED BY: | ACTUAL SLUMP |
|------------------|--------------------|---------------|----------------------------|--------------|
| | THIS TICKET | RUNNING TOTAL | | |
| 0656640 Mix 5 | 7.6 | 7.6 | 6.8 | |
| 0656652 | 7.6 | 15.2 | | |
| 0656660 | 7.6 | 22.8 | | |
| 0656686 Mix 1A | 7.6 | 30.4 | | |
| 0656653 | 7.6 | 38.0 | | |
| 0656656 | 7.6 | 45.6 | | 220 |
| 0656670 | 7.6 | 53.2 | | 205 |
| 0656673 | 7.6 | 60.8 | | 195 |
| 0656682 | 7.6 | 68.4 | | 210 |
| 0656685 | 7.6 | 76.0 | | |
| 0656689 | 7.6 | 83.6 | | |
| 0656699 | 7.6 | 91.2 | | |
| 0656702 | 7.6 | 98.8 | | |
| 0656710 | 7.6 | 106.4 | | |
| 0656711 | 7.6 | 114.0 | | |
| 0656707 | 7.6 | 121.6 | | |

Appendix D

Certificate of Mix Design



Account Number : 50204824
 A J Morrisroe & Sons Ltd
 Unit 4 Oaks Court
 Warwick Road
 Borehamwood
 WD6 1GS

F.A.O :

Date : 29-Jun-15

Certificate of Mix Design

Our Ref CT : 139147725
 Site/Project : MASTER PLAN HEYGATE ESTATE
 HEYGATE STREET
 ELEPHANT AND CASTLE SE17 1

Your Ref :
 From : Stepney

Mix Specifications

| Mix | Mix Ref | Description | Agg Size | Cement Type | Target Slump |
|----------|----------|--------------------------------|----------|-------------|--------------|
| 20194326 | MIX6+RET | C40/50 PUMP + S/PLAS + RET | 20 | CEMI | S4 |
| 20194328 | MIX1+RET | C35/45 M360 W45 + S-PLAS + RET | 20 | CEMI | S4 |

Mix Design

| Materials | | | | DRY Batch Weights Kg/m ³ | | | |
|--------------------|---------------------------|------------------|------------------|-------------------------------------|----------|--|--|
| Type | Primary Source | | Secondary Source | 20194326 | 20194328 | | |
| CEM I | Cemex | Rugby | Cemex Tilbury | 400 | 380 | | |
| 0/4 MP Sand | Cemex | Angerstein | Cemex Northfleet | 775 | 784 | | |
| 04/20 Limestone | Cemex | Doveholes | Cemex Raynes | 1064 | 1079 | | |
| SPLAS | Cemex | ISOFLEX 561X(ml) | | 2400 | 2280 | | |
| Retarder | Cemex | CR800(ml) | | 600 | 570 | | |
| FREE W/C | Free Water / Cement Ratio | | | 0.42 | 0.43 | | |
| A/C Ratio | Aggregate/Cement Ratio(%) | | | 4.60 | 4.90 | | |
| % Fines | Fines Content(%) | | | 42 | 42 | | |
| Total Cementitious | Total Cement Content | | | 400 | 380 | | |

*Mix Design details given may be subject to variation both in weight and source, given natural variation in material properties and source availability

Additional Information

Signed :

M. Pemberton
 Readymix Technical Support

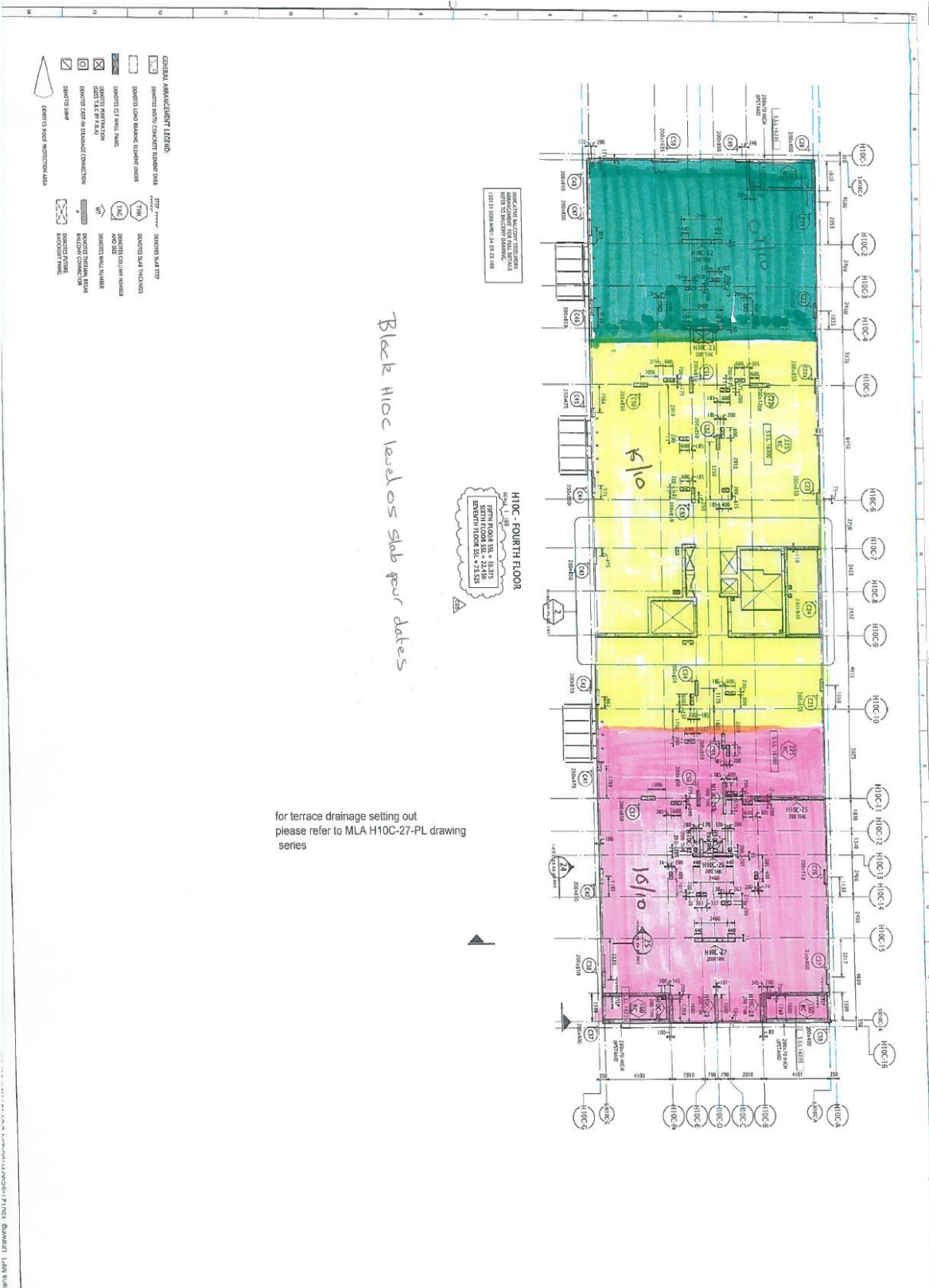

Block H10C leads to slab pour dates

for terrace drainage setting out
please refer to MLA H10C-27-PL drawing
series

THE INFORMATION ABOVE AND PERTAINING TO THE PRELIMINARY ARCHITECTURAL DRAWING IS FOR INFORMATION ONLY AND IS NOT TO BE USED FOR CONSTRUCTION. THE CLIENT ACCEPTS FULL RESPONSIBILITY FOR THE ACCURACY OF THE INFORMATION PROVIDED. THE ARCHITECT ASSUMES NO LIABILITY FOR THE ACCURACY OF THE INFORMATION PROVIDED. THE ARCHITECT'S LIABILITY IS LIMITED TO THE PROFESSIONAL SERVICES PROVIDED. THE ARCHITECT'S LIABILITY IS LIMITED TO THE PROFESSIONAL SERVICES PROVIDED. THE ARCHITECT'S LIABILITY IS LIMITED TO THE PROFESSIONAL SERVICES PROVIDED.

Land Lease
 ELEPHANT and CASTLE - MPI
 Block H10C
 General Arrangement Plan
 5th, 6th, 7th Floors (Similar)
 Scale: 1:100
 Date: 11/10/21
 Project: South Gardens MPI

Appendix F

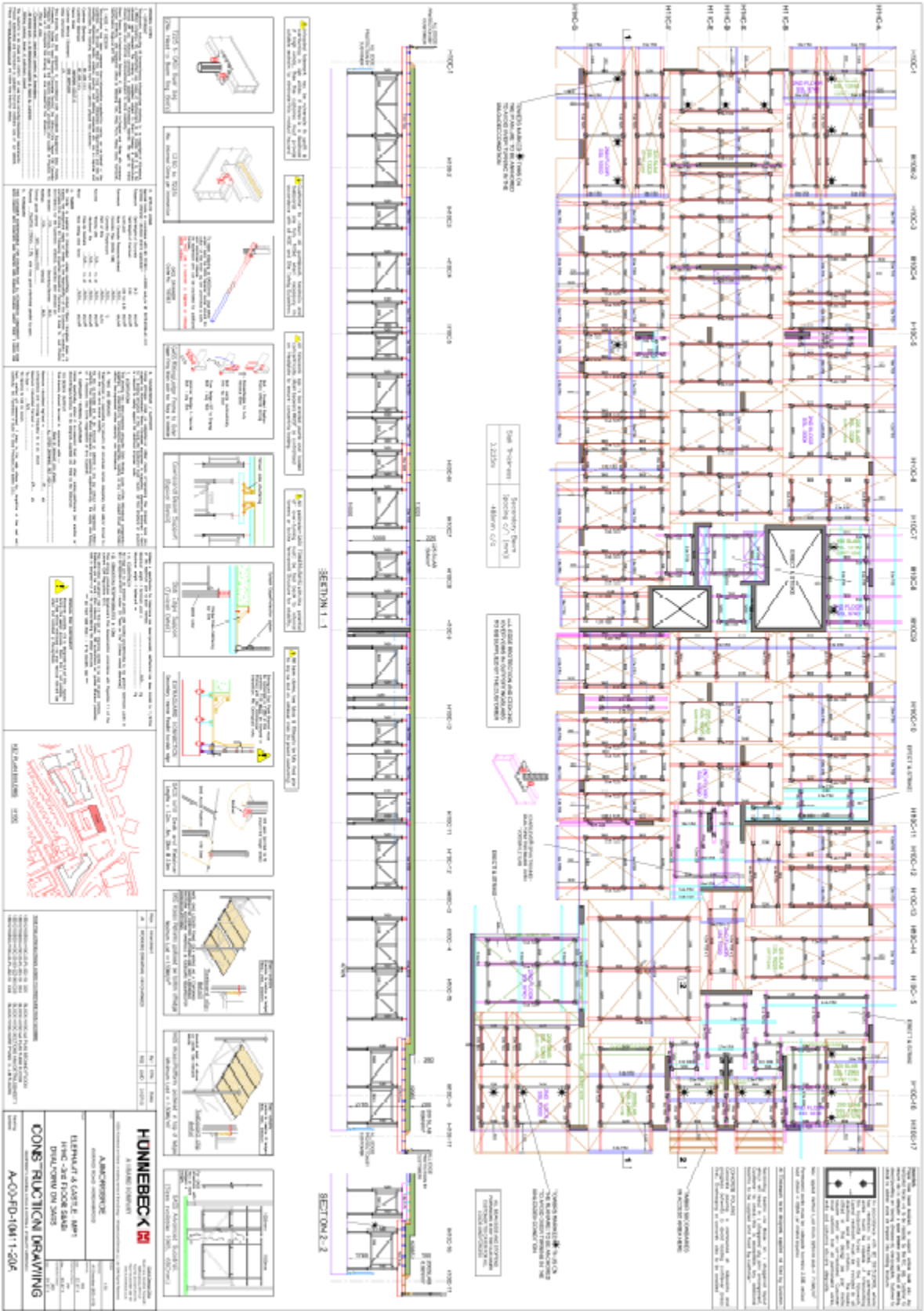

Appendix G

Site Observation Record

| PhD Project: Deflection of Concrete Slabs | | PhD Researcher: Shivan Tovi University of West London |
|---|---|---|
| Site Observation Record. Ver.ST-1 (Ground Floor) | | 30 Oct 2015 |
| Date | Action | Notes |
| | Foundation | |
| | Concrete casting column | |
| | Pouring Slab | |
| | Formwork insulation | |
| | Removal | 2-3 clear but - f 1/2 |
| | Propping Installation | 4 BAG ← |
| | Propping removal | same clear |
| | Curing | 2 weeks after 1/2 |
| | Strike | |
| | Temperature | as per record |
| | Humidity | N/A |
| | Grade of concrete | all C45, level 2 CSO transfer slab |
| | Water cement ratio | as per record |
| | Exposer class | as per concrete spec |
| | Levelling and location of levelling point highlighted on the plan of the building | surveys |

Appendix H

In Summary:

| Calculation Sheet | | Sheet Ref. S.SS.15 | |
|---|---|-------------------------------------|--|
| Project/ Name | | Contract Number | Sheet No. of |
| Shivan Tovi PhD Project - Elephant & Castle MP1 - Block (H10C) | | | 1 12 |
| Title | | | |
| Striking of Slabs | | | |
| Based on the 'Early striking and improved backpropping for efficient flat slab Construction and CIRIA Report 136 | | | |
| Design Data: Design Loads as load plan 30/05/14 | | | |
| Concrete grade used for slab striking calculations= | | | |
| Concrete Strength | | 45 N/mm ² | |
| Transfer Slabs | | 50 N/mm ² | |
| Calculation Sheet for relevant conditions attached. | | | |
| In Summary: | | Striking Strength | |
| Type: | Design Strength | Characteristic Strength: (a) | Striking Strength: (b) |
| 02 First Floor | | | |
| 01 First Floor, 250mm Slab, Zone-03 (ACCESS) | 45.0 N/mm ² | 23.7 N/mm ² | 29.7 N/mm ² |
| 02 First Floor, 350mm Slab, Zone-16 (PLANT) | 45.0 N/mm ² | 17.5 N/mm ² | 21.9 N/mm ² |
| 03 First Floor, 250mm Slab, Zone-01 (RESIDENTIAL) | 45.0 N/mm ² | 31.3 N/mm ² | 39.1 N/mm ² |
| 03 Second Floor | | | |
| 01 Second Floor, 800mm Slab, Zone 01 (RESIDENTIAL) | 50.0 N/mm ² | 20.0 N/mm ² | 20.0 N/mm ² # |
| 02 Second Floor, 800mm Slab, Zone 03 (ACCESS) | 50.0 N/mm ² | 20.0 N/mm ² | 20.0 N/mm ² # |
| 03 Second Floor, 700mm Slab, Zone 01 (RESIDENTIAL) | 50.0 N/mm ² | 20.0 N/mm ² | 20.0 N/mm ² # |
| # Transfer Structure Therefore Reduced to 20N/mm ² | | | |
| 04 Third Floor + Typical Floors | | | |
| 01 Third Floor, 225mm Slab, Zone-01 (RESIDENTIAL) | 45 N/mm ² | 27.3 N/mm ² | 34.2 N/mm ² |
| 02 Third Floor, 200mm Slab, Zone-09 (GREEN ROOF) | 45 N/mm ² | 14.7 N/mm ² | 18.4 N/mm ² # |
| 03 Eighth Floor, 250mm Slab, Zone-06 (TERRACE) | 45 N/mm ² | 22.0 N/mm ² | 27.5 N/mm ² |
| 05 Roof | | | # Recommend Minimum 20 N/mm ² |
| 01 Roof, 250mm Slab, Zone-12 (ROOF) | 45 N/mm ² | 23.7 N/mm ² | 29.7 N/mm ² |
| Notes: | | | |
| (a) | CHARACTERISTIC STRENGTH TO BE USED ONLY WITH MATURITY METHOD OF DETERMINING IN-SITU CONCRETE STRENGTH (THERMO COUPLES) | | |
| (b) | MEAN STRENGTH TO BE USED WITH SITE MADE STRIKING CUBES STRENGTH GIVEN TO BE COMPARED WITH AVERAGE VALUE FROM MINIMUM 4NO TEMPERATURE MATCH CURED CUBES. | | |
| Note: Beams / thickenings acting as transfer structures not considered as strengths given above sufficient. | | | |
| Note: Striking assumes that you will be striking within completed bays of structure with supports (columns, walls etc) all round with no sections of slab cantilevering in the temporary case when they would otherwise be supported by a column / wall. In these situations you will need to leave sufficient falsework in place to maintain an edge support until such time as the structure is supported to the next column / wall position. | | | |
| Prepared by | ST | Date | 09/06/2015 |
| Approved by | | Date | |
| | | Date | 09/06/2015 |

Calculation Sheet no.1

| <u>Location</u> | <u>% of Design strength</u> | | | | |
|---|-----------------------------|------|---|-------|-----|
| First Floor: | % | CEM | I | CIIIA | 50% |
| GGBS | | | | | |
| First Floor, 250mm Slab, Zone-03 (ACCESS) | 53 | 1to2 | | | 4 |
| First Floor, 350mm Slab, Zone-16 (PLANT) | 39 | 1to2 | | | |
| 2to3 | | | | | |
| First Floor, 250mm Slab, Zone-01 (RESIDENTIAL) | 70 | 4.00 | | | |
| 7to8 | | | | | |
| Second Floor: | | | | | |
| Second Floor, 800mm Slab, Zone 01 (RESIDENTIAL) | 40 | 1to2 | | | 3 |
| Second Floor, 800mm Slab, Zone 03 (ACCESS) | 40 | 1to3 | | | 3 |
| Second Floor, 700mm Slab, Zone 01 (RESIDENTIAL) | 40 | 1to4 | | | 3 |
| Third Floor + Typical Floors: | | | | | |
| Third Floor, 225mm Slab, Zone-01 (RESIDENTIAL) | 61 | 2to3 | | | 5 |
| Third Floor, 200mm Slab, Zone-09 (GREEN ROOF) | 33 | 1to2 | | | |
| 2to3 | | | | | |
| Eighth Floor, 250mm Slab, Zone-06 (TERRACE) | 49 | 1to2 | | | |
| 3to4 | | | | | |

First Floor, 250mm Slab, Zone-03 (ACCESS)

Determination of Strength for early striking of flat slabs having thickness 350mm or less (Based on Early Striking and improved backpropping for efficient flat slab construction practice guide by British Cement Association 2001)

Self-weight of slab:

Total thickness of concrete (mm) = 250 $A = 6.00 \text{ kN/m}^2$

Construction load (kN/m^2) = 1.5 $B = 1.50 \text{ kN/m}^2$

(Allows for falsework to slab above and / or limited storage of materials)

Design Working load:

Imposed Dead = 2.0

Imposed Live = 3.0 $C = 5. \text{ kN/m}^2$

| Calculation Sheet | | Sheet Ref. | |
|---|------------------------|--|-------------------------------|
| | | S.SS.15 | |
| Project/Contract Name | | Contract Number | Sheet No. of |
| Shivan Tovi PhD Project - Elephant & Castle MP1 - Block (H10C) | | | 3 of 12 |
| Title | | | |
| Striking of Slabs | | First Floor, 250mm Slab, Zone-03 (ACCESS) | |
| <u>Determination of Strength for early striking of flat slabs having thickness 350mm or less</u> | | | |
| <u>(Based on Early Striking and improved backpropping for efficient flat slab construction practice guide by BCA)</u> | | | |
| Self weight of slab: | | | |
| Total thickness of concrete (mm) = | 250 | A = | 6.00 kN/m ² |
| Construction load (kN/m ²) = | 1.5 | B = | 1.50 kN/m ² |
| (Allows for falsework to slab above and / or limited storage of materials.) | | | |
| Design Working load: | | | |
| Imposed Dead= | 2.0 | | |
| Imposed Live = | 3.0 | C = | 5.00 kN/m ² |
| W.ser (A+C) = | 11.0 kN/m ² | (total unfactored design service load, kN/m ²) | |
| W (A+B) = | 7.5 kN/m ² | (total unfactored construction load on the slab considered, kN/m ²) | |
| f _{cu} = | 45 N/mm ² | (characteristic strength of the concrete, N/mm ²) | |
| f _c = | 23.7 N/mm ² | (required characteristic concrete strength to be able to strike the flat slab, N/mm ²) | |
| <u>Determination 1</u> | | | |
| W/Wser ≤ 1 | W/Wser= | 0.682 | <1 |
| <u>Determination 2</u> | | | |
| f _c ≥ f _{cu} (W/Wser) ^{1.67} | | | |
| Hence f _c ≥ | | 23.7 | N/mm ² |
| <u>Correction for average cube strength results:</u> | | | |
| Consider correction from characteristic concrete strength to average of cube test results, use factor suggested in 'Guide to flat slab formwork and falsework' by Pallet (Annexe D4) of x1.25, therefore: | | | |
| Mean of at least 4no air cured cube results = | 1.25 x | 23.7 = | <u>29.7</u> N/mm ² |
| Prepared by | ST | Date | 09/06/2015 |
| Approved by | | Date | |
| Date | 09/06/2015 | | |

Calculation Sheet no.3

First Floor, 350mm Slab, Zone-16 (PLANT)

Determination of Strength for early striking of flat slabs having thickness 350mm or less (Based on Early Striking and improved backpropping for efficient flat slab construction practice guide by British Cement Association 2001)

Self-weight of slab:

Total thickness of concrete (mm) = 350 $A = 8.40 \text{ kN/m}^2$

Construction load (kN/m^2) = 1.5 $B = 1.50 \text{ kN/m}^2$

(Allows for falsework to slab above and / or limited storage of materials)

Design Working load:

Imposed Dead = 1.5

Imposed Live = 7.5 $C = 9.00 \text{ kN/m}^2$

| Calculation Sheet | | | | Sheet Ref. | |
|---|--|------------------------|--|------------------------|----|
| | | | | S.SS.15 | |
| Project/Contract Name | | | Contract Number | Sheet No. | of |
| Shivan Tovi PhD Project - Elephant & Castle MP1 - Block (H10C) | | | | 4 | 12 |
| Title | | | | | |
| Striking of Slabs First Floor, 350mm Slab, Zone-16 (PLANT) | | | | | |
| <u>Determination of Strength for early striking of flat slabs having thickness 350mm or less</u> | | | | | |
| <u>(Based on Early Striking and improved backpropping for efficient flat slab construction</u> | | | | | |
| <u>practice guide by BCA)</u> | | | | | |
| Self weight of slab: | | | | | |
| Total thickness of concrete (mm) = | | 350 | A = 8.40 kN/m ² | | |
| Construction load (kN/m ²) = | | 1.5 | B = 1.50 kN/m ² | | |
| (Allows for falsework to slab above and / or limited storage of materials.) | | | | | |
| Design Working load: | | | | | |
| Imposed Dead = | | 1.5 | | | |
| Imposed Live = | | 7.5 | C = 9.00 kN/m ² | | |
| W.ser (A+C) = 17.4 kN/m ² (total unfactored design service load, kN/m ²) | | | | | |
| W (A+B) = 9.9 kN/m ² (total unfactored construction load on the slab considered, kN/m ²) | | | | | |
| f _{cu} = | | 45 N/mm ² | (characteristic strength of the concrete, N/mm ²) | | |
| f _c = | | 17.5 N/mm ² | (required characteristic concrete strength to be able to strike the flat slab, N/mm ²) | | |
| <u>Determination 1</u> | | | | | |
| W/Wser ≤ 1 | | W/Wser = | 0.569 < 1 | | |
| <u>Determination 2</u> | | | | | |
| fc ≥ fcu (W/Wser) ^{1.67} | | | | | |
| Hence fc ≥ | | 17.5 N/mm ² | | | |
| <u>Correction for average cube strength results:</u> | | | | | |
| Consider correction from characteristic concrete strength to average of cube test results, use factor suggested in 'Guide to flat slab formwork and falsework' by Pallet (Annexe D4) of x1.25, therefore: | | | | | |
| Mean of at least 4 no air cured cube results = | | 1.25 x | 17.5 = | 21.9 N/mm ² | |
| Prepared by PSN Date 09/06/2015 Approved by Date | | | | | |
| Checked by GH Date 09/06/2015 | | | | | |

Calculation Sheet no.4

First Floor, 250mm Slab, Zone-01 (RESIDENTIAL)

Determination of Strength for early striking of flat slabs having thickness 350mm or less (Based on Early Striking and improved backpropping for efficient flat slab construction practice guide by British Cement Association 2001)

Self-weight of slab:

Total thickness of concrete (mm) = 350 $A = 8.40 \text{ kN/m}^2$

Construction load (kN/m^2) = 1.5 $B = 1.50 \text{ kN/m}^2$

(Allows for falsework to slab above and / or limited storage of materials)

Design Working load:

Imposed Dead = 2.4

Imposed Live = 1.5 $C = 3.90 \text{ kN/m}^2$

| Calculation Sheet | | | | Sheet Ref. | |
|---|----------|-------------------|--|--|------------|
| | | | | S.SS.15 | |
| Project/Contract Name | | | Contract Number | | Sheet No. |
| Shivan Tovi PhD Project - Elephant & Castle MP1 - Block (H10C) | | | | | 5 |
| Title | | | of 12 | | |
| Striking of Slabs | | | First Floor, 250mm Slab, Zone-01 (RESIDENTIAL) | | |
| <u>Determination of Strength for early striking of flat slabs having thickness 350mm or less</u> | | | | | |
| <u>(Based on Early Striking and improved backpropping for efficient flat slab construction practice guide by BCA)</u> | | | | | |
| Self weight of slab: | | | | | |
| Total thickness of concrete (mm) = | 350 | A = | 8.40 | kN/m ² | |
| Construction load (kN/m ²) = | 1.5 | B = | 1.50 | kN/m ² | |
| (Allows for falsework to slab above and / or limited storage of materials.) | | | | | |
| Design Working load: | | | | | |
| Imposed Dead = | 2.4 | | | | |
| Imposed Live = | 1.5 | C = | 3.90 | kN/m ² | |
| W.ser (A+C) = | 12.3 | kN/m ² | | (total unfactored design service load, kN/m ²) | |
| W (A+B) = | 9.9 | kN/m ² | | (total unfactored construction load on the slab considered, kN/m ²) | |
| f _{cu} = | 45 | N/mm ² | | (characteristic strength of the concrete, N/mm ²) | |
| f _c = | 31.3 | N/mm ² | | (required characteristic concrete strength to be able to strike the flat slab, N/mm ²) | |
| Determination 1 | | | | | |
| W/Wser ≤ 1 | W/Wser = | 0.805 | < 1 | | |
| Determination 2 | | | | | |
| f _c ≥ f _{cu} (W/Wser) ^{1.67} | | | | | |
| Hence f _c ≥ | 31.3 | | N/mm ² | | |
| <u>Correction for average cube strength results:</u> | | | | | |
| Consider correction from characteristic concrete strength to average of cube test results, use factor suggested in 'Guide to flat slab formwork and falsework' by Pallet (Annexe D4) of x1.25, therefore: | | | | | |
| Mean of at least 4 no air cured cube results = | 1.25 x | 31.3 = | 39.1 N/mm ² | | |
| Prepared by | | ST | Date | | 09/06/2015 |
| Approved by | | | Date | | |
| Date | | 09/06/2015 | | | |

Calculation Sheet no.5

Second Floor, 800mm Slab, Zone 01 (RESIDENTIAL)

Early Striking, Using Sadgrove's Relationship: based on CRIA Report (CIRIA REP 136 1995)

Self-weight of slab:

Total thickness of concrete (mm) = 800 $A = 19.2 \text{ kN/m}^2$

Construction load (kN/m^2) = 1.5 $B = 1.50 \text{ kN/m}^2$

Design Working load:

Self-Weight = 19.2

Imposed Dead = 2.4

Imposed Live = 1.5 $C = 3.90 \text{ kN/m}^2$

Striking load as a proportion of design load = $A + B / C = 0.90$

Second Floor, 800mm Slab, Zone 03 (ACCESS)

Early Striking, Using Sadgrove's Relationship: based on CRIA Report (CIRIA REP 136 1995)

Self-weight of slab:

Total thickness of concrete (mm) = 800 $A = 19.2 \text{ kN/m}^2$

Construction load (kN/m^2) = 1.5 $B = 1.50 \text{ kN/m}^2$

Design Working load:

Self-Weight = 19.2

Imposed Dead = 2.0

Imposed Live = 3.0 $C = 24.2 \text{ kN/m}^2$

Striking load as a proportion of design load = $A + B / C = 0.86$

| | | | |
|--|--|---|-----------------------------|
| Calculation Sheet | | Sheet Ref. S.SS.15 | |
| Project/Contract Name Shivan Tovi PhD Project Elephant & Castle MP1 - Block (H10C) | | Contract Number | Sheet No. of 7 12 |
| Title Striking of Slabs Second Floor, 800mm Slab, Zone 03 (ACCESS) | | | |
| <u>Early Striking, Using Sadgrove's Relationship</u> (CIRIA Report 136) | | | |
| 1. | Self weight of slab: Total thickness of concrete (mm) = | <input style="width: 80px;" type="text" value="800"/> | A = 19.2 kN/m ² |
| 2. | Construction load (kN/m ²) = | <input style="width: 80px;" type="text" value="1.5"/> | B = 1.5 kN/m ² |
| 3. | Design Working load: Self Weight = | 19.2 | |
| | Imposed Dead = | <input style="width: 80px;" type="text" value="2.0"/> | |
| | Imposed Live = | <input style="width: 80px;" type="text" value="3.0"/> | C = 24.2 kN/m ² |
| | Striking load as a proportion of design load = $A + B / C =$ | | 0.86 |
| 4. | Multiply this proportion by the grade of concrete used, to obtain characteristic strength: f_{cu} (N/mm ²) = | <input style="width: 80px;" type="text" value="50"/> | |
| | Therefore, $f_{cu} (A + B) / C =$ | | 43 N/mm ² |
| 5. | Multiply by 1.25 to obtain the mean strength require for temperature matched cubes: Therefore, $1.25 \times f_{cu} (A + B) / C =$ | | 53 N/mm ² |
| Therefore, require average temperature matched cube result of no less than 53 N/mm ² | | | |
| Prepared by: ST | | Date: <u>09/06/2015</u> | Approved by: |
| | | Date: <u>09/06/2015</u> | Date: |

Calculation Sheet no.7

Second Floor, 700mm Slab, Zone 01 (RESIDENTIAL)

Early Striking, Using Sadgrove's Relationship: based on CRIA Report (CIRIA REP 136 1995)

Self-weight of slab:

Total thickness of concrete (mm) = 700 $A = 16.8 \text{ kN/m}^2$

Construction load (kN/m^2) = 1.5 $B = 1.50 \text{ kN/m}^2$

Design Working load:

Self-Weight = 16.8

Imposed Dead = 2.4

Imposed Live = 1.5 $C = 20.7 \text{ kN/m}^2$

Striking load as a proportion of design load = $A + B / C = 0.88$

| | | | |
|--|--|---|-----------------------------|
| Calculation Sheet | | Sheet Ref. S.SS.15 | |
| Project/Contract Name Shivan Tovi PhD Project Elephant & Castle MP1 - Block (H10C) | | Contract Number | Sheet No. of 8 12 |
| Title Striking of Slabs Second Floor, 700mm Slab, Zone 01 (RESIDENTIAL) | | | |
| <u>Early Striking, Using Sadgrove's Relationship</u> (CIRIA Report 136) | | | |
| 1. | Self weight of slab: Total thickness of concrete (mm) = | <input style="width: 80px;" type="text" value="700"/> | A = 16.8 kN/m ² |
| 2. | Construction load (kN/m ²) = | <input style="width: 80px;" type="text" value="1.5"/> | B = 1.5 kN/m ² |
| 3. | Design Working load: Self Weight = | 16.8 | |
| | Imposed Dead = | <input style="width: 80px;" type="text" value="2.4"/> | |
| | Imposed Live = | <input style="width: 80px;" type="text" value="1.5"/> | C = 20.7 kN/m ² |
| | Striking load as a proportion of design load = $A + B / C =$ | | 0.88 |
| 4. | Multiply this proportion by the grade of concrete used, to obtain characteristic strength: f_{cu} (N/mm ²) = | <input style="width: 80px;" type="text" value="50"/> | |
| | Therefore, $f_{cu} (A + B) / C =$ | | 44 N/mm ² |
| 5. | Multiply by 1.25 to obtain the mean strength require for temperature matched cubes: Therefore, $1.25 \times f_{cu} (A + B) / C =$ | | 55 N/mm ² |
| Therefore, require average temperature matched cube result of no less than 55 N/mm ² | | | |
| Prepared by: ST | | Date: <u>09/06/2015</u> | Approved by: |
| | | Date: <u>09/06/2015</u> | Date: |

Calculation Sheet no.8

Third Floor, 225mm Slab, Zone-01 (RESIDENTIAL)

Determination of Strength for early striking of flat slabs having thickness 350mm or less (Based on Early Striking and improved backpropping for efficient flat slab construction practice guide by British Cement Association 2001)

Self-weight of slab:

Total thickness of concrete (mm) = 225 $A = 5.40 \text{ kN/m}^2$

Construction load (kN/m^2) = 1.5 $B = 1.50 \text{ kN/m}^2$

(Allows for falsework to slab above and / or limited storage of materials)

Design Working load:

Imposed Dead = 2.4

Imposed Live = 1.5 $C = 3.90 \text{ kN/m}^2$

Third Floor, 200mm Slab, Zone-09 (GREEN ROOF)

Determination of Strength for early striking of flat slabs having thickness 350mm or less (Based on Early Striking and improved backpropping for efficient flat slab construction practice guide by British Cement Association 2001)

Self-weight of slab:

Total thickness of concrete (mm) = 200 $A = 4.80 \text{ kN/m}^2$

Construction load (kN/m^2) = 1.5 $B = 1.50 \text{ kN/m}^2$

(Allows for falsework to slab above and / or limited storage of materials)

Design Working load:

Imposed Dead = 4.5

Imposed Live = 3.0 $C = 7.50 \text{ kN/m}^2$

Eighth Floor, 250mm Slab, Zone-06 (TERRACE)

Determination of Strength for early striking of flat slabs having thickness 350mm or less (Based on Early Striking and improved backpropping for efficient flat slab construction practice guide by British Cement Association 2001)

Self-weight of slab:

Total thickness of concrete (mm) = 250 $A = 6.00 \text{ kN/m}^2$

Construction load (kN/m^2) = 1.5 $B = 1.50 \text{ kN/m}^2$

(Allows for falsework to slab above and / or limited storage of materials)

Design Working load:

Imposed Dead = 2.5

Imposed Live = 3.0 $C = 5.50 \text{ kN/m}^2$

| Calculation Sheet | | | | Sheet Ref. | |
|---|----------|-------------------|-------------------------------|--|------------|
| | | | | S.SS.15 | |
| Project/Contract Name | | | Contract Number | | Sheet No. |
| Shivan Tovi PhD Project - Elephant & Castle MP1 - Block (H10C) | | | | | 11 |
| Title | | | of 12 | | |
| Striking of Slabs Eighth Floor, 250mm Slab, Zone-06 (TERRACE) | | | | | |
| <u>Determination of Strength for early striking of flat slabs having thickness 350mm or less</u> | | | | | |
| <u>(Based on Early Striking and improved backpropping for efficient flat slab construction practice guide by BCA)</u> | | | | | |
| Self weight of slab: | | | | | |
| Total thickness of concrete (mm) = | 250 | A = | 6.00 | kN/m ² | |
| Construction load (kN/m ²) = | 1.5 | B = | 1.50 | kN/m ² | |
| (Allows for falsework to slab above and / or limited storage of materials.) | | | | | |
| Design Working load: | | | | | |
| Imposed Dead = | 2.5 | | | | |
| Imposed Live = | 3.0 | C = | 5.50 | kN/m ² | |
| W.ser (A+C) = | 11.5 | kN/m ² | | (total unfactored design service load, kN/m ²) | |
| W (A+B) = | 7.5 | kN/m ² | | (total unfactored construction load on the slab considered, kN/m ²) | |
| f _{cu} = | 45 | N/mm ² | | (characteristic strength of the concrete, N/mm ²) | |
| f _c = | 22.0 | N/mm ² | | (required characteristic concrete strength to be able to strike the flat slab, N/mm ²) | |
| <u>Determination 1</u> | | | | | |
| W/Wser ≤ 1 | W/Wser = | 0.652 | < 1 | | |
| <u>Determination 2</u> | | | | | |
| f _c ≥ f _{cu} (W/Wser) ^{1.67} | | | | | |
| Hence f _c ≥ | 22.0 | | N/mm ² | | |
| <u>Correction for average cube strength results:</u> | | | | | |
| Consider correction from characteristic concrete strength to average of cube test results, use factor suggested in 'Guide to flat slab formwork and falsework' by Pallet (Annexe D4) of x1.25, therefore: | | | | | |
| Mean of at least 4 no air cured cube results = | 1.25 x | 22.0 = | <u>27.5</u> N/mm ² | | |
| Prepared by | | ST | Date | | 09/06/2015 |
| Approved by | | | Date | | |
| Date | | 09/06/2015 | | | |

Calculation Sheet no.11

Roof, 250mm Slab, Zone-12 (ROOF)

Determination of Strength for early striking of flat slabs having thickness 350mm or less (Based on Early Striking and improved backpropping for efficient flat slab construction practice guide by British Cement Association 2001)

Self-weight of slab:

Total thickness of concrete (mm) = 250 $A = 6.00 \text{ kN/m}^2$

Construction load (kN/m^2) = 1.5 $B = 1.50 \text{ kN/m}^2$

(Allows for falsework to slab above and / or limited storage of materials)

Design Working load:

Imposed Dead = 3.5

Imposed Live = 1.5 $C = 5.00 \text{ kN/m}^2$

| Calculation Sheet | | Sheet Ref. | |
|---|------------------------|--|-------------------------------|
| | | S.SS.15 | |
| Project/Contract Name | | Contract Number | Sheet No. of |
| Shivan Tovi PhD Project - Elephant & Castle MP1 - Block (H10C) | | | 12 12 |
| Title | | | |
| Striking of Slabs Roof, 250mm Slab, Zone-12 (ROOF) | | | |
| <u>Determination of Strength for early striking of flat slabs having thickness 350mm or less</u> | | | |
| <u>(Based on Early Striking and improved backpropping for efficient flat slab construction practice guide by BCA)</u> | | | |
| Self weight of slab: | | | |
| Total thickness of concrete (mm) = | 250 | A = 6.00 kN/m ² | |
| Construction load (kN/m ²) = | 1.5 | B = 1.50 kN/m ² | |
| (Allows for falsework to slab above and / or limited storage of materials.) | | | |
| Design Working load: | | | |
| Imposed Dead = | 3.5 | | |
| Imposed Live = | 1.5 | C = 5.00 kN/m ² | |
| W.ser (A+C) = | 11.0 kN/m ² | (total unfactored design service load, kN/m ²) | |
| W (A+B) = | 7.5 kN/m ² | (total unfactored construction load on the slab considered, kN/m ²) | |
| f _{cu} = | 45 N/mm ² | (characteristic strength of the concrete, N/mm ²) | |
| f _c = | 23.7 N/mm ² | (required characteristic concrete strength to be able to strike the flat slab, N/mm ²) | |
| <u>Determination 1</u> | | | |
| W/Wser ≤ 1 | W/Wser = | 0.682 | < 1 |
| <u>Determination 2</u> | | | |
| f _c ≥ f _{cu} (W/Wser) ^{1.67} | | | |
| Hence f _c ≥ | | 23.7 | N/mm ² |
| <u>Correction for average cube strength results:</u> | | | |
| Consider correction from characteristic concrete strength to average of cube test results, use factor suggested in 'Guide to flat slab formwork and falsework' by Pallet (Annexe D4) of x1.25, therefore: | | | |
| Mean of at least 4 no air cured cube results = | 1.25 x | 23.7 = | <u>29.7</u> N/mm ² |
| Prepared by | ST | Date | 09/06/2015 |
| Approved by | | Date | |
| | | Date | 09/06/2015 |

Calculation Sheet no.12

Appendix I

Hydrostatic Cell Levelling

1 Introduction

The Getec liquid levelling system detects the changes in hydrostatic pressure relative to a reference cell which is located out of the zone of influence. This change is used to calculate the vertical deformations.

Getec Hydrostatic Levelling Cells provide an accurate and near real time method to measure vertical movements.

2 Work Introduction and Specification

The cells are manufactured by Getec AG. Both measurement and reference cells were used. The small size of the measuring device (about 10 cm) versus traditional liquid level gauge systems (50 cm) allows for a more discreet installation. Table 1 shows the technical data.

Table 1 Technical Data

| Technical Data | |
|----------------------------|-----------------|
| Measuring range (typical) | 200mm to 500 mm |
| Resolution | 0.02 mm |
| Linear | ≤ 0.2 mm |
| Stability | 0.2 mm per year |
| Operating Temperature | -20°C to 80°C |
| Compensated Range | 0°C to 50°C |

3 Principle of Measurement

The Getec hydrostatic levelling system pressure transmitter measures pressure differences compared against a reference measuring point as illustrated in Figure 1. The sensor is energised and the output measured in Millimetre Ampere (mA). This analogue value is converted to a height difference in engineering units using a unique linear factor generated during cell calibration and supplied by the manufacturer. The reference level is defined by the liquid horizon in a header tank. All the measuring points are connected to the header tank via a tube and therefore to the reference level. Because the header tank is not linked to the measuring circuit, changes in the level of the liquid (liquid losses, changes in barometric pressure and temperature) have no influence on the measurement results.

The pressure transmitters were available in different measuring ranges from 10cm up to 10m and different sensors can be combined in one system. Eight sensors were used in the investigation. Sets of cells were been linked to each other via a small hole drilled through the party wall. The movement monitored by the cells was relative only: absolute values were derived by monitoring externally.

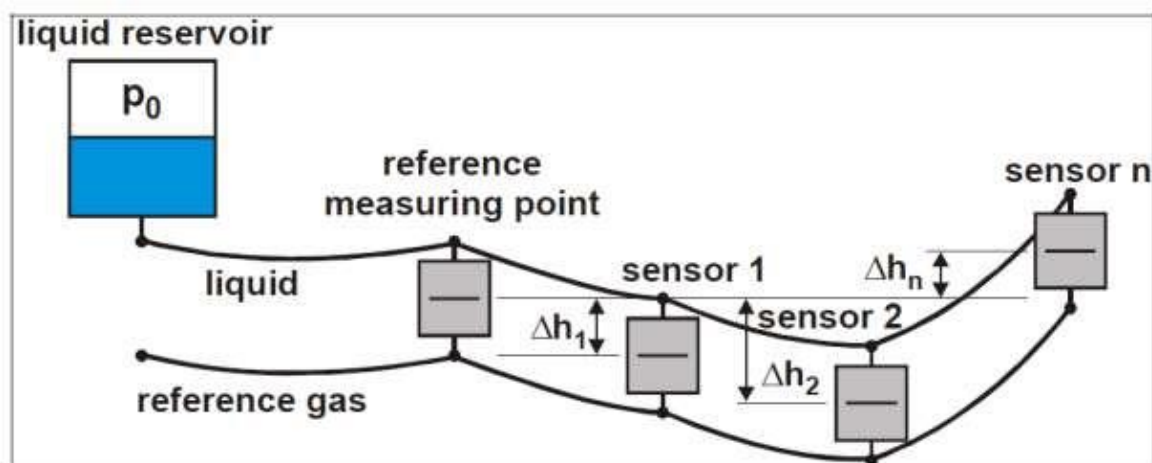

Figure 1 Principle of Operation

4 Range and Accuracy

An actual accuracy of ± 0.3 mm was achieved. Although the range is dependent on sensor type, typically instruments with a range of 500 mm were used.

5 Logging System and Power Requirements

The logging system was microprocessor based. Eight sensors were connected to a multiplexor, and numerous multiplexors could be connected to a single data logger, depending on site constraints. Each data logger required a 240 VAC supply. With permission, this was taken from the building supply. Sensors required a 24 VDC supply, usually via a suitable 240 VAC to 24 VDC transformer. If a suitable 240 VAC supply was not available, an un-switched fused spur was installed by a suitably qualified electrician. The data were then uploaded from the data logger to the Grout Control server at regular intervals via a cellular network and were also stored on a hard drive. Power consumption was between 20 to 25 watts an hour. This equated to between £0.06 and £0.075 a day based on £0.125 per kW/h.

6 Data Format

Data were stored in the following format as illustrated in Figure 3.9 Chapter Three; Logger id: date: time: sensor id: raw reading: temperature reading: engineering unit. These data were stored on the Grout Control server.

7 Typical Installation Methodology

7.1 Sensors

The sensors were installed using 2 or 48 mm expanding anchor bolts of a suitable length dependent on the material they are being fixed to. If expanding anchor bolts would not hold because of the friable nature of the fixing medium, a 10 mm diameter

hole was drilled, the hole cleaned out with a puffer bottle and Hilti Hit HY 50 adhesive and 8 mm threaded studding used. Any supplementary bracket required for the installation of the sensors was provided by Hayward Baker during the installation process. The reservoir was mounted in the same fashion. A multiplexor was installed either on a suitable structure at an agreed location, or on a suitable bracket using 8 mm expanding anchor bolts. Sensors were connected to the multiplexor via cable glands. Each sensor was terminated with bootlace ferrules and connected to the required sensor channel as illustrated in Figure 2 below.



Figure 2 Typical Cell Installation

7.2 Locations and Sensors Numbers

The locations of all hydrostatic levelling cells and reference reservoirs and associated information were recorded, together with the sensor serial number. The as-built positions of the data and logger boxes and cabling were also noted. The information

was lodged with the photographic condition survey. The sensor locations were plotted on appropriate CAD drawings for display using gtcVisual.

7.3 Calibration

Once fully installed, the system was energised and a set of readings taken to ensure that the sensors, data boxes and microprocessor were working correctly. Once the system was working correctly, temperature and sensor output were monitored to observe the effects of temperature on the readings. A thermal coefficient for each sensor was then calculated and applied.

7.4 Validation

Each sensor was disconnected in turn to check that it had been installed into the correct channel. Water was then added to the water reservoir and the increase in height noted. The data from each sensor was then checked to ensure that the same difference ($\pm 0.15\text{mm}$) was observed.

7.5 Presentation Format

Data from instruments was collected by gtcVisual via downloads from the site logger boxes. Data presentation was in both plain and graphical view. Other site measurements such as surveying can be added to the gtcVisual database.

7.6 Decommissioning and Reinstatement

Once the monitoring work were completed, all hardware was removed. Studs and bolts were cut flush and driven further in so that they were below the surface. The remaining void was filled with a suitable filling medium.

8 Summary and Deflection Results from the Site Investigation

The Hydraulic Cell Levelling System monitoring vertical movement and temperature at Elephant and Castle site were removed from the block HC10 third floor slab in early January 2016 after 142 days of observing deflection on the slab using eight cells as described earlier.

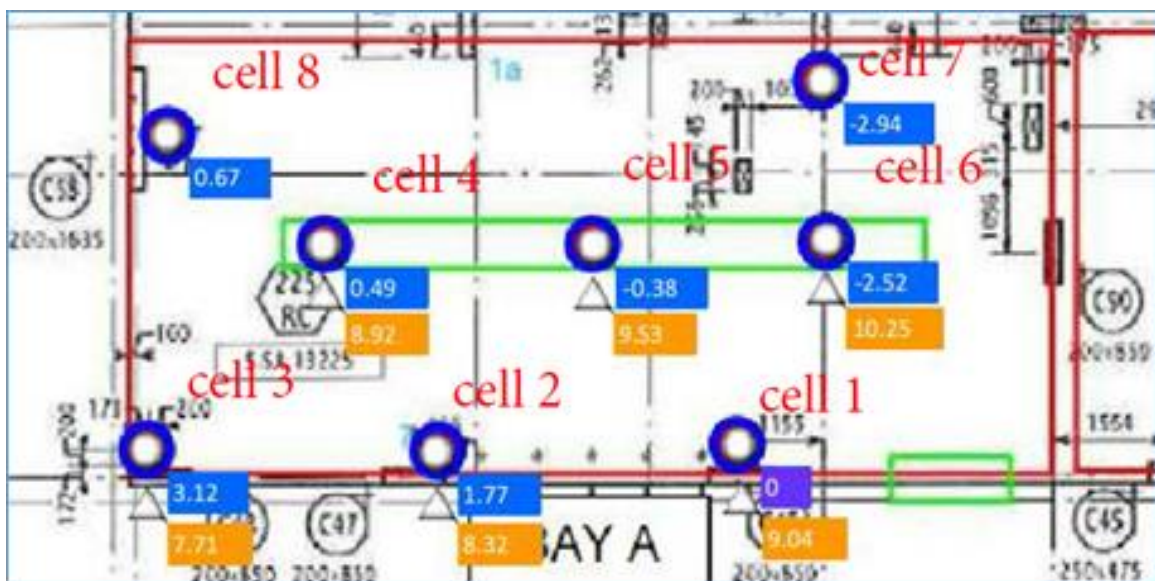

Figure 3 Deflection of Reinforced Concrete Slab, Site Investigation

From (Figure 3), the location of cells can be clearly identified, the numbers in the blue boxes above are vertical movement in mm after 142 days of monitoring, and the numbers in orange boxes show the temperatures of each hydraulic cell level.

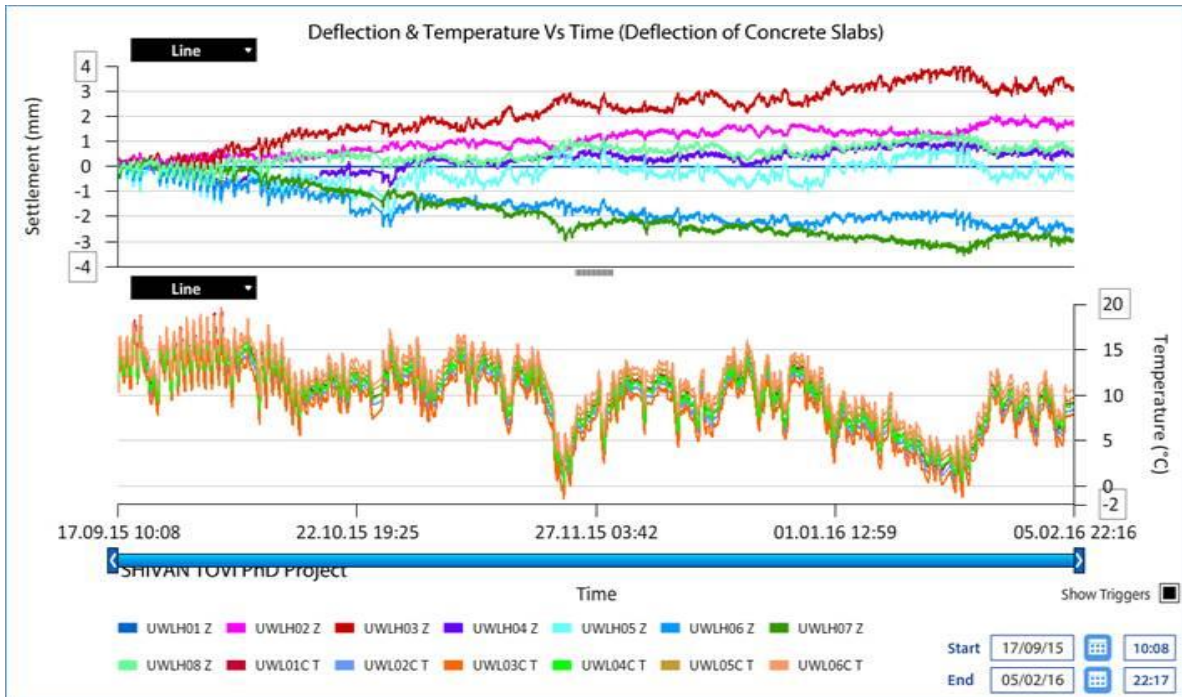















Figure 4 Deflection and Temperature Vs Time (Deflection of Concrete Slab)

The deflection and temperature results are set out in Figure 4. The upper part of the graph shows the deflection results while the lower part shows the temperature results. The deflection and temperature results are colour coded in the graph and presented in Table 2 as follows:

Table 2 Technical Data

| Deflection (Cell ID) | Location (Figure 8.4) | Colour code (Graph 8.1) | Maximum value (mm) |
|----------------------|-----------------------|---|--------------------|
| UWL01Z | Cell 1 |  | 0(Benchmark) |
| UWL02Z | Cell 2 |  | 1.77 |
| UWL03Z | Cell 3 |  | 3.12 |
| UWL04Z | Cell 4 |  | 0.49 |
| UWL05Z | Cell 5 |  | -0.38 |
| UWL06Z | Cell 6 |  | -2.52 |

| | | | |
|---------|--------|---|--------------|
| UWL07Z | Cell 7 |  | -2.94 |
| UWL08Z | Cell 8 |  | 0.67 |
| UWL01CT | Cell 1 |  | 9.04 |
| UWL02CT | Cell 2 |  | 8.32 |
| UWL03CT | Cell 3 |  | 7.71 |
| UWL04CT | Cell 4 |  | 8.92 |
| UWL05CT | Cell 5 |  | 9.53 |
| UWL06CT | Cell 6 |  | 10.25 |

The data indicate that the slab did not sag much at all due to the back propping for 30 days. It does seem, however, that the slab was sloping down from the corner by 6 mm diagonally across the 12 m bay.

A margin of deflection of around 2 mm occurred especially in the mid-span of the slab 12 x 7 m corner bay in block H10C, particularly on cell no. 6 and cell no. 7, the 2 mm deflection occurred at the beginning of the investigation after back propping reinforced concrete corner bay slab. The back propping was applied 7 days after pouring the slab.

Slab monitoring started from a very early stage of the casting when the slab was still wet. The hydraulic levelling cells were positioned under the slab while the workers were pouring the rest of the third floor on the top. Figure 3 and Figure 4 illustrate that the slab was deformed by 2 mm, and it can be seen that the deflection started developing very slowly. Initially from 0 mm to 0.51 mm, and then by day 142 ending up at 2 mm.

The conclusion of the site investigation is that the Eurocode 2 tabulated deflection values and calculation methods are acceptable, and the span-to-depth ratio method

is adequate to calculate the deflection. There is the potential, however, to reduce the thickness of the slab but the amount of reduction needs to be studied very carefully using various calculation methods, and this could itself be a research topic.