



Durham E-Theses

Agrobacterium tumefaciens: chemotaxis and crop protection

Ashby, Alison Mary

How to cite:

Ashby, Alison Mary (1988) *Agrobacterium tumefaciens: chemotaxis and crop protection*, Durham theses, Durham University. Available at Durham E-Theses Online: <http://etheses.dur.ac.uk/6723/>

Use policy

The full-text may be used and/or reproduced, and given to third parties in any format or medium, without prior permission or charge, for personal research or study, educational, or not-for-profit purposes provided that:

- a full bibliographic reference is made to the original source
- a [link](#) is made to the metadata record in Durham E-Theses
- the full-text is not changed in any way

The full-text must not be sold in any format or medium without the formal permission of the copyright holders.

Please consult the [full Durham E-Theses policy](#) for further details.

Agrobacterium tumefaciens : Chemotaxis and
crop protection.

by

Alison Mary Ashby

A thesis submitted to the Department of Botany

University of Durham

In accordance with the requirements for the degree of
Doctor of Philosophy

July 1988

The copyright of this thesis rests with the author.
No quotation from it should be published without
his prior written consent and information derived
from it should be acknowledged.



19 SEP 1988

For My Parents and Andrew

Declaration

I declare that the work contained within this thesis submitted by me for the degree of Doctor of Philosophy is my own original work, except where due reference is made to coworkers, and has not been submitted for a degree at this or any other University.

Agrobacterium tumefaciens : Chemotaxis and crop protection

Alison Mary Ashby

ABSTRACT

Chemotaxis in *Agrobacterium tumefaciens* was studied. Several plant derived monocyclic phenolic compounds were analysed for their ability to act as chemoattractants for *A. tumefaciens* C58C¹ and as inducers of the Ti-plasmid virulence operons. The results divided the phenolics into 4 groups. A strong correlation between *vir*- inducing ability and Ti-plasmid requirement for chemotaxis was established and chemical structure rules for *vir* induction and chemotaxis are outlined. Furthermore, *virA* and *virG* were found to be the Ti-plasmid virulence genes required for chemotaxis towards the monocyclic phenolic compound acetosyringone.

Chemotaxis towards both monocotyledonous and dicotyledonous plant extracts was analysed. Undiluted shoot and root extracts from both sources elicited a response from both Ti-plasmid harbouring and cured *A. tumefaciens* C58C¹. However, when diluted extracts of Wheat and Kalanchoe shoot homogenate were analysed, a distinct enhancement of chemotaxis was conferred by the Ti-plasmid, suggesting that recognition of, and attraction towards, susceptible plants is not the step blocked in monocot transformation. Analysis of cell wall material revealed that native cell wall components are not required for chemotaxis of *A. tumefaciens* C58C¹ towards plant extracts.

Results obtained on chemotaxis along with current knowledge of *vir*- induction allowed the development of a novel idea involving *Agrobacterium* as a biocontrol agent.

A chitinase gene from *Serratia marcescens* was manipulated such that its promotor was removed. The promotorless cassette was linked to the *virB* promotor from an octopine Ti-plasmid and the construct introduced into *Agrobacterium* harbouring *virA* and *virG*.

The potential benefit of this biocontrol system with respect to other existing biocontrol systems is that expression of the pesticidal gene is regulated by components of wound exudate and therefore is a conservative process, pesticide being produced only when a plant is wounded, at a time when it is most susceptible to attack by plant pathogens, and then exclusively in the microrhizosphere around the wound site.

The copyright of this thesis rests with the author. No quotation from it should be published without her prior written consent and information derived from it should be acknowledged.

Acknowledgements

Firstly I would like to extend my sincere thanks to my supervisors Dr. Charlie Shaw and Dr. Martin Watson for their support and advice throughout my PhD. I am particularly grateful to Charlie for his belief in preliminary results and embryonic ideas and for his commitment in seeing them through to reality.

I am grateful to ICI Agrochemicals Division (Jealott's Hill, Bracknell) for financial support. Especially to Nigel Poole, Keith Powell and David Rhodes for their help, kindness and stimulating discussions over the last two years.

Sincere thanks are due to Christine Shaw, Deb Saunders, Gwynneth Walker and Catherine Lilley for technical assistance; to Denise Hughes and Paul Sidney for help with the figures; and to everyone in the Botany department for making my three years in Durham so enjoyable.

This work would not have been as pleasurable or as easy without the practical assistance and friendship of past and present members of the Durham *Agrobacterium* group, namely Greg, Catherine, Andy, Chris, Christine, Gary, Alan, Mustafa, Kahlid and Gavin.

I would also like to thank my parents for their continuous encouragement and financial support throughout my education and Doris Wharton for many intellectual discussions over the last six months.

Finally, all my love to Andrew (x), thankyou for helping to make a dream become a reality!

Abbreviations

All abbreviations used here are as in the "Instructions to Authors", Biochemical Journal 225 (1985) 1-26, with the following exceptions:

bp	=	Base pairs
kb	=	Kilobase pairs
DNAase	=	Deoxyribonuclease
EtBr	=	Ethidium Bromide
dNTP	=	Deoxyribonucleoside triphosphate
ddNTP	=	Dideoxyribonucleoside triphosphate
SDS	=	Sodium dodecyl sulphate
SSC	=	Saline sodium citrate
PEG	=	Polyethylene glycol
A ₂₆₀	=	Absorbance at 260nm
A ₂₈₀	=	Absorbance at 280nm
X-Gal	=	5-dibromo-4-chloro-3-indoylgalactoside
IPTG	=	Isopropylthiogalactoside
5'	=	5' terminal phosphate of a DNA molecule
3'	=	3' terminal hydroxyl of a DNA molecule
c.p.m	=	Counts per minute
DTT	=	Dithiothreitol
BSA	=	Bovine serum albumin
DMSO	=	Dimethylsulphoxide
AS	=	Acetosyringone
Amp	=	Ampicillin

Abbreviations continued:-

Rif	=	Rifampicin
Km	=	Kanamycin
Cb	=	Carbenicillin
Cm	=	Chloramphenicol
Tet	=	Tetracycline
Ti-plasmid	=	Tumour inducing plasmid
T-DNA	=	Transfer DNA

Memorandum

The following publications have been achieved as a result of this initial research:

1. Ashby, A.M., Watson, M.D. and Shaw, C.H. (1987). *FEMS*, 41, 189.
2. Ashby, A.M., Watson, M.D., Shaw, C.H. and Richards, A.J.M. (1986). European Patent Appl. EP 0 256682 A2.
3. Ashby, A.M., Watson, M.D., Loake, G.J., and Shaw, C.H. (1988). *J. Bacteriol*, (in press).
4. Ashby, A.M., Lilley, C., Richards, A.J.M., Watson, M.D., and Shaw, C.H. (1988). *App. Env. Micro* (submitted).
5. Shaw, C.H., Ashby, A.M., and Watson, M.D. (1986). *Nature*, 324, 415.
6. Shaw, C.H., Ashby, A.M., Brown, A., Royal, C., Loake, G.J., and Shaw, C.H. (1988). *Molec. Microbiol*, 2(3), 413.
7. Shaw, C.H., Ashby, A.M., Loake, G.J., and Watson, M.D. (1988). "One small step: The missing link in Crown Gall". *Oxford Surveys of Plant Molecular and Cell Biology*. Vol5, (in press).
8. Loake, G.J., Ashby, A.M., and Shaw, C.H. (1988). *J. Gen. Micro*, 134, 1427.
9. Munoz Aguilar, J.M., Ashby, A.M., Richards, A.J.M., Loake, G.J., Watson, M.D., and Shaw, C.H. (1988). *J. Gen. Micro*, (in press).

Contents.

Chapter 1 Introduction		
1.1	The Genus <i>Agrobacterium</i>	1
1.2	The aetiology of the infection process	2
1.2.1	Attachment	2
1.2.2	Microfibril synthesis	3
1.2.3	β -1,2-Glucan	4
1.2.4	Attachment to monocot cell surfaces	4
1.3	The Ti-plasmid	5
1.3.1	T-DNA	6
1.3.2	The virulence region	7
1.3.2.1	Plant derived <i>vir</i> -inducing phenolics	8
1.3.2.2	<i>virA</i> and <i>virG</i>	8
1.3.2.3	<i>virA</i>	8
1.3.2.4	<i>virG</i>	9
1.3.2.4.1	Mode of action of <i>virA</i> and G: a summary	9
1.3.2.5	<i>virB</i>	9
1.3.2.6	<i>virC</i>	10
1.3.2.7	<i>virD</i>	10
1.3.2.8	<i>virE</i>	10
1.4	Other Rhizobacteria	11
1.4.1	<i>Rhizobium</i>	11
1.4.1.1	The infection process	12
1.4.1.2	Nodulation (<i>nod</i>) genes	13
1.4.1.3	Structure and function of <i>nod</i> genes	13
1.4.1.4	Inducer molecules	14
1.4.1.5	Inhibitor molecules	14
1.4.2	<i>Pseudomonas</i>	15
1.4.3	<i>Azospirillum</i>	16

1.5	Bacterial chemotaxis	16
1.5.1	Components of the chemotaxis system	18
1.5.1.1	Periplasmic binding proteins	18
1.5.1.2	Transducer proteins	18
1.5.1.3	Receptors associated with the PTS	19
1.5.2	Detection of chemotactic stimuli	19
1.5.2.1	Receptors and transducers	19
1.5.2.2	Structural and functional domains	19
1.5.2.3	Receptor and transducer specificities	20
1.5.2.4	Adaption	21
1.5.3	Flagella structure	22
1.5.3.1	The flagellar filament	22
1.5.3.2	The flagellar hook	22
1.5.3.3	The basal body	23
1.5.3.4	Molecular biology of flagella components	23
1.5.3.5	Regulation of expression	23
1.5.4	Information flow during bacterial chemotaxis	24
1.6	Chemotaxis in the rhizosphere	25
1.7	Biological control agents	26
1.7.1	Natural biological control agents	27
1.7.2	Microorganisms having direct effects on crop yield	28
1.7.3	Microbial inoculants indirectly beneficial to crop yield	28
1.7.3.1	<i>Agrobacterium</i> as a natural biocontrol agent	28
1.7.4	Plant growth promoting pseudomonads	29
1.7.5	Monitoring bacterial movement	31
1.7.6	<i>Bacillus thuringiensis</i> : a natural biological control agent.	31
1.7.7	Fungal biocontrol agents	32
1.7.8	Fungi as biocontrol agents against insects and mites	32

1.7.9	Biological control of weeds	33
1.8	Aims and objectives of this research	33
Chapter2 Materials and methods		
2.1	Materials	35
2.1.1	Bacterial strains and plasmid vectors	36
2.1.2	Glassware and other equipment	36
2.1.3	Growth media and antibiotics	36
2.2	Methods	37
2.2.1	Chemotaxis assays	37
2.2.1.1	Preparation of motile bacteria	37
2.2.1.2	Microscopic examination	37
2.2.1.3	The capillary assay	38
2.2.1.4	The blindwell assay	39
2.2.1.5	A comparison of the two methods	39
2.2.1.6	Preparation of plant homogenates	40
2.2.1.6.1	Wheat homogenates	40
2.2.1.6.2	Kalanchoe homogenates	40
2.2.1.6.3	Tobacco homogenates	41
2.2.1.7	Protoplast isolation	41
2.2.1.8	Conjugating plasmids into <i>Agrobacterium</i>	42
2.2.1.9	The vir-induction assay	42
2.2.1.10	The 3-keto-lactose assay	43
2.2.1.11	The p-nitrophenyl beta-D-N,N'-diacetyl chitobiose assay.	43
2.2.2	General techniques	43
2.2.2.1	Storage of bacteria	43
2.2.2.2	Phenol:chloroform extraction of DNA	44
2.2.2.3	Precipitation of DNA with ethanol	44
2.2.2.4	Dialysis of DNA solutions	44

2.2.2.5	Spectrophotometric quantitation of DNA	45
2.2.2.6	Pretreatment of RNAase A	45
2.2.3	Enzymatic reactions	45
2.2.3.1	Restriction endonuclease digests	45
2.2.3.2	Dephosphorylation of DNA	45
2.2.3.3	Phosphorylation of synthetic oligo linkers	46
2.2.3.4	Ligation of DNA fragments	46
2.2.3.5	Exo III and Mung bean deletions of DNA	46
2.2.4	Agarose gel electrophoresis	48
2.2.5	DNA fragment isolation: the LMP method	48
2.2.6	Transfer of DNA to nitrocellulose	48
2.2.7	³² P end-labelling of DNA	49
2.2.8	Prehybridization and hybridization	49
2.2.9	Autoradiography	50
2.2.10	Preparation of plasmid DNA	50
2.2.10.1	The mini-preparation	50
2.2.10.2	The 50ml method	51
2.2.10.3	The large scale method	51
2.2.11	Preparation of competent cells	52
2.2.12	Transformation of plasmid DNA	53
2.2.13	Construction of M13 clones for sequencing	53
2.2.14	Preparation of single-stranded M13 templates	54
2.2.15	DNA sequencing by the di-deoxynucleotide chain termination method.	54
2.2.16	Preparation and use of polyacrylamide gels	55
2.2.17	Total protein estimations	56
2.2.17.1	The Folin-Lowry method	56
2.2.17.2	The Bio-Rad microassay procedure	57

Chapter 3 Chemotaxis in *Agrobacterium tumefaciens*

3.1	Introduction	58
3.2	Growth curve of <i>A. tumefaciens</i> C58C ¹ (pTiB6S3)	59
3.3	Isolation of motile bacteria	59
3.4	Time course experiments	59
3.5	Neutralization of phenolic acids	60
3.5.1	Chemotaxis towards sodium chloride	61
3.6	Chemotaxis towards phenolic compounds	61
3.6.1	Introduction	61
3.6.2	Group 1 phenolics	62
3.6.3	Group 2 phenolics	63
3.6.4	Group 3 phenolics	63
3.6.5	Group 4 phenolics	63
3.6.6	Chemotaxis towards natural monocot and dicot homogenates.	64
3.6.6.1	Introduction	64
3.6.6.2	Chemotaxis towards Tobacco and Wheat	64
3.6.6.3	Tobacco	64
3.6.6.4	Wheat	65
3.7	Ti-plasmid involvement in chemotaxis towards Wheat and Kalanchoe shoot extracts	65
3.8	The effects of cell wall components on chemotaxis towards natural homogenates	67
3.9	Discussion	67
3.9.1	Dose response curves	68
3.9.2	Monocyclic phenolic compounds	68
3.9.2.1	Category 1 phenolics	68
3.9.2.2	Other phenolic categories	69
3.9.3	Structures of phenolic attractants	70

3.9.4	<i>virA</i> and G are the Ti-plasmid genes involved in specific chemotaxis towards acetosyringone	70
3.9.5	Postulated models for the AS binding site	71
3.9.6	The relevance of chemotaxis towards phenolics to the <i>Agrobacterium</i> :plant interaction	72
3.9.7	Chemotaxis towards plant homogenates	73
3.9.7.1	Ti-plasmid enhancement of chemotaxis towards dilute extracts of Wheat and Kalanchoe shoot	74
3.9.8	A detailed scenario of <i>Agrobacterium</i> 's behaviour in the rhizosphere	75

Chapter 4 A plant protection method involving chemotaxis

4.1	Introduction	77
4.1.1	The active molecule	78
4.2	The mark 01 and 02 constructs	79
4.3	The mark 1 construct	81
4.3.1	The chitinase cassette	81
4.4	The <i>virB</i> promoter cassette	82
4.4.1	Subcloning the Sall/ClaI fragment from pSM30	82
4.4.2	Isolation of the 1.3kb <i>virB</i> promoter fragment	83
4.4.3	Controlled deletions into pDUB2510	84
4.4.4	Synthesis of an oligonucleotide	86
4.4.5	Linking the deleted <i>virB</i> fragment to the chitinase cassette.	86
4.5	The final construct	87
4.5.1	Sequencing the <i>virB</i> oligo fragment	87
4.6	Introducing pDUB2512 into <i>Agrobacterium</i>	88
4.6.1	Transforming HB101(pVK257) with pDUB2512	88
4.6.2	Introducing the cointegrate into C58C ¹	89
4.6.3	The 3-keto-lactose assay	89

4.7	Chemotaxis of C58C ¹ (pDUB2513) towards AS and monocot and dicot homogenates	90
4.8	AS induced chitinase production	90
4.8.1	The plate method	91
4.8.2	Hydrolysis of p-nitrophenyl- β -D-N,N'-diacetylchitobiose	91
4.9	Discussion	92
4.9.1	The chitinase of <i>Serratia marcescens</i>	94
4.9.2	The <i>virB</i> promotor	95
4.9.3	The effect of pH on induction	96
4.9.4	Introducing the constructs into <i>Agrobacterium</i>	97
4.9.4.1	Mark 01 and 02	97
4.9.4.2	Mark 1	98
4.9.5	The predicted effectiveness of the construct against fungi and insect pests	99
4.9.6	Chemotaxis of C58C ¹ (pDUB2513)	100
	Chapter 5 A summary.	101
	References	106

Delightful task! to rear the tender thought. To teach the young idea how
to shoot.

James Thomson.

Chapter 1
Introduction

Chapter 1

1.1 The genus *Agrobacterium*

Agrobacterium tumefaciens is a soil phytopathogen that was first identified in 1907 by Smith and Townsend (1) as the causal agent of crown gall diseases of plants, and was at that time christened *Bacterium tumefaciens*. After several modifications of the genus name, it was left to Conn (2) in 1942 to classify the bacterium as *Agrobacterium tumefaciens*, following the breakdown of the genus *Phytomonas* which originally included a great array of Agrobacteria, Pseudomonads, Xanthomonads and Corynebacteria. Since then, other plant diseases such as hairy root and cane gall, have been shown to be caused by members of the genus *Agrobacterium*, namely, *A. rhizogenes* (3) and *A. rubi* (4) respectively.

Morphologically, the agrobacteria are short, encapsulated gram-negative parallel-sided rods with rounded ends, 0.6-1.0 μ m wide and 1.5-3.0 μ m long. They are commonly motile, possessing one to six peritrichous flagella (one or two being subpolar), which may extend to five times the length of the cell (5). The guanine-cytosine content of their DNA ranges from 58-62% (6).

Agrobacterium tumefaciens is found predominantly in the rhizosphere where it constitutes a common component of the soil microflora and has been demonstrated to survive in this niche for several years (7). The number of bacteria isolated from directly around the roots being about a thousand times greater than in the surrounding soil (8), a phenomenon thought to be due to the attraction of bacteria towards the growing parts of the roots (9). Avirulent forms of *Agrobacterium* often make up as much as 99% of the total population (10), however, the percentage population of virulent agrobacteria can be as high as 50% (11).

A recent survey of the host range of *Agrobacterium* induced tumours re-



vealed that highly susceptible plant families were those that could accumulate polyphenolic compounds. Conversely, non-sensitive plant families did not have this ability. Such results demonstrate that polyphenolic compounds are of great importance in the *Agrobacterium* : plant interaction (12).

Agrobacterium tumefaciens can incite crown gall tumours upon the aerial parts of most dicotyledonous (13) and a limited number of monocotyledonous (14) plants. The initial event in the *Agrobacterium*-plant interaction was generally assumed to be cell-cell binding (15) where communication with the plant cell wall results in bacteria adhering to the plant cell surface. However; Schroth in 1971, made the qualitative observation that *A. tumefaciens* was attracted towards root tips (9), which suggests that the primary step in the interaction may extend further than merely cell-cell contact. The subsequent events, namely the transfer of a small segment of DNA (transfer or T- DNA) from the *Agrobacterium* tumour inducing plasmid (Ti- plasmid) into the plant genome is initiated and as yet the mechanistic details of this process have not been elucidated. The T-DNA encodes several genes which by virtue of possessing the correct eukaryotic regulatory signals, are transcribed and translated in the plant and result in the production of the tumorous phenotype.

1.2 The aetiology of the infection process.

1.2.1 Attachment

Bacterial binding to plant cell surfaces may play an important role in the *Agrobacterium* : plant interaction.

Evidence that adsorption of *A. tumefaciens* to the surfaces of susceptible plant tissues is a prerequisite for tumour formation was presented by Lippincott and co- workers (15-18). They used tumour inhibition assays to measure the effects of both bacterial and plant cell wall components on inhibition of tumour formation by applied virulent *Agrobacterium* species and were able to conclude

that discrete binding sites for attachment of *Agrobacterium* exist and that such binding sites contained lipopolysaccharide (LPS). On separating the LPS into its component O antigen and lipid A fractions they were able to demonstrate that only the O antigen fraction was inhibitory (19). It was suggested that the bacterial LPS fraction interacted directly with a pectic component of the plant cell wall.

More recent studies using the technique of direct binding yielded results to the contrary. Kluepfel and Pueppke (20,21) , using a system in which bacterial adsorption to potato tuber tissues was measured directly, rather than inferred from tumour induction experiments, demonstrated that most LPS preparations and several pectic compounds had no inhibitory effect on adsorption. It was suggested that the adsorption of *A. tumefaciens* to plant cells may be less specific than originally thought, and occurred by a purely physical process (physisorption). Adsorption of *A. tumefaciens* to potato tuber cells was accurately described (20).

The nature or existence of the plant cell wall receptor for attachment has yet to be elucidated, however, in view of the fact that bacteria are able to bind as efficiently to heat killed and glutaraldehyde fixed cells as they are to living ones, it has been demonstrated that the plant receptor is not synthesized in response to the bacterium.

1.2.2 Microfibril synthesis.

Production of cellulose microfibrils by *A. tumefaciens* in response to attachment to carrot cell suspension cultures (22-25), protoplasts (26) and to tobacco leaf and callus (27) has been well documented. Cellulose production is not required for virulence as some mutants defective for cellulose production still maintain the virulent phenotype. The genes responsible for cellulose microfibril production and attachment have been mapped to the chromosomal DNA and Ti-plasmid (23,28).

Synthesis of cellulose microfibrils anchors *A. tumefaciens* to the cell wall and entraps other agrobacteria, resulting in the formation of large aggregates at the cell surface. Fibril synthesis is mediated by attachment to the susceptible plant cell; plant cell type or culture conditions or both determining the amount of fibril synthesis (22).

1.2.3 β -1,2-Glucan.

The chromosomal virulence locus *chvB* (29) is involved in the synthesis of β -1,2-glucan, a polysaccharide thought to play a role in attachment of *A. tumefaciens* to plant cells and therefore in crown gall tumour formation. The *chvB* locus is approximately 8.5kb long and contains a 7kb region which encodes for a large membrane protein involved in the synthesis of the cyclic β -1,2-glucan (30). The second chromosomal virulence gene involved in attachment is designated *chvA* (29). Although its functional role has yet to be identified, it has been demonstrated that mutations in the transcriptional unit does not effect β -1,2-Glucan synthesis. Recently a third genetic locus was identified as being important in the attachment and virulence phenotype of *A. tumefaciens*. This was termed the *pscA* locus and is structurally and functionally related to the *exoC* symbiosis locus of *R. meliloti*. The locus is thought to play an important role in extracellular polysaccharide production (31). The actual roles played by the *chvA* gene product(s), the *pscA* gene product(s) and β -1,2- Glucan have yet to be elucidated.

1.2.4 Attachment to monocot cell surfaces.

Lippincott and Lippincott (17) demonstrated that cell walls of monocotyledonous plants did not inhibit *Agrobacterium* mediated tumour formation on pinto bean leaves and suggested that the apparent resistance to crown gall by this plant type was a result of the bacterium's inability to bind to monocotyledonous cell wall. However, more recently the binding of agrobacteria to monocots has been reported (32-34,25). Although the numbers of virulent

agrobacteria bound to monocots is lower than found bound to dicots, binding has been demonstrated in wheat, oats, corn, rice and sorghum tissue cultures (25,34) as well as on *Asparagus officinalis* (33) cells and on bamboo (32). These results demonstrate that the monocot resistance to crown gall disease by *A. tumefaciens* is not a consequence of bacterial inability to bind to monocot tissue.

1.3 The Ti-plasmid

The Ti-plasmid is essential for virulence. It is usually approximately 200kb in size, however, Ti-plasmids as large as 500kb have been reported (35). There are two regions of this plasmid that are essential for pathogenicity, namely, the T-DNA, which is transferred to, and stably maintained in transformed cells; and the virulence region, which appears to be involved in surface interactions between the bacterium and plant cell, processing, transfer, and integration of the T-DNA. There is a third region of the Ti-plasmid that contains the genes for the catabolism of opines, which are unusual amino acid derivatives. Ti-plasmids are often classified depending on the type of opine produced in transformed tissue.

Octopine [N2-(1-D-carboxyethyl)-L-arginine] is degraded by *A. tumefaciens* harbouring octopine Ti-plasmids to arginine and pyruvic acid whereas nopaline [N2-(1-D-dicarboxypropyl)-L-arginine] is degraded by *A. tumefaciens* harbouring nopaline Ti-plasmids to arginine and 2-ketoglutaric acid. Arginine is then converted to ornithine by a chromosomally encoded arginase activity and ornithine converted to proline via an ornithine cyclase activity which is a Ti-plasmid determined trait (36).

Another class of Ti-plasmids are the Agropine type which induce the synthesis of agropine (37), agrocinopines C and D (38) and leucinopine (39). The agropine Ti-plasmids were originally termed "null type" due to the inability to identify opines in their tumours (40). Several non-oncogenic plasmids encoding opine catabolism have been identified in *A. tumefaciens* and *A. radiobacter*

strains which are only partially related to Ti-plasmids (41). Most *Agrobacterium* strains also harbour cryptic "megaplasmids" (42) and some contain plasmids smaller than Ti-plasmids, among them being a plasmid encoding the bacteriocin agrocin 84 (43), however, most are without an identified function (44).

1.3.1 T-DNA

The T-DNA was first identified as the portion of the Ti-plasmid reproducibly integrated into the plant genome. In all of the naturally occurring Ti-plasmids studied, the T-DNA is flanked by 25bp direct repeat sequences termed the T-DNA borders (45) the right border being essential for transfer (46,47). Recently it was demonstrated that a conserved sequence that flanked the right border was required for enhancement of T-DNA transmission, termed "overdrive" (48). In nopaline tumours the T-DNA is a continuous segment, about 23kb long (49,50,51). However, in octopine tumours the T-DNA is more variable, having a 13.5kb constant segment (TL) and occasionally an additional 6-7kb fragment termed TR (48-53).

The T-DNAs of both octopine and nopaline plasmids contain a conserved region (common DNA) containing three genetic loci which are responsible for hormone independence and other hormone controlled reactions. The three loci encode the following oncogenic functions : (a) the tumour morphology shoot locus (*tms*), (b) the tumour morphology large locus (*tml*), (c) the tumour morphology root locus (*tmr*). There is a fourth locus that does not map within the conserved (common) DNA termed the opine synthase locus. The *tms* locus encodes two transcripts necessary for the biosynthesis of IAA in transformed plant cells. Transcript 1 encodes a tryptophan 2-monooxygenase (58) which catalyses the conversion of tryptophan to indole-3-acetamide (IAM) and transcript 2 encodes an amidohydrolase (59) which converts IAM into indole-3-acetic acid (IAA). Transcript 4 of the T-DNA lies within the *tmr* locus and encodes an enzyme involved in cytokinin biosynthesis (60). Transcript 3 encodes the opine

synthase gene products *ocs* or *nos*. In octopine Ti-plasmids the *ocs* gene lies within the TL-DNA and encodes lysopine dehydrogenase (formerly octopine synthase). In nopaline Ti-plasmids the *nos* gene which encodes nopaline synthase lies to the right of the conserved DNA and the *acs* gene which encodes agrocinopine synthase, lies to the left. DNA sequence data has shown that both octopine (61) and nopaline (62) synthesis genes have promoter elements that are of eukaryotic origin suggesting that the expression of T-DNA is directly regulated by the plant cell.

In total, eight transcripts have been identified in the TL-DNA of octopine Ti-plasmids (63-66) and five are transcribed from sequences common to both octopine and nopaline T-DNA (figure 1.3.1).

1.3.2 The virulence region

The virulence (*vir*) region is approximately 35Kb in length and lies to the left of the T-DNA on the Ti-plasmid. The *vir* region of both octopine and nopaline Ti-plasmids is composed of several complementation groups (65). In the nopaline type Ti-plasmids the designation is *virA*, *virB*, *virC*, *virD*, *virE* and *virG* (figure 1.3.2), however, in the octopine type Ti-plasmids *virF* is included. DNA sequence comparisons demonstrate considerable homology between octopine and nopaline *vir* regions.

The virulence loci are tightly regulated by two control mechanisms. The first involves the positive regulation of *virB*, *virC*, *virD* and *virE* expression by the *virA* and *virG* gene products in response to plant exudates (68). The second is independent of the *virA* / *virG* mechanism and acts on only a subset of the *vir* genes. The control mechanism is mediated by the *ros* locus (69,70). Mutations in *ros* (chromosomal or megaplasmid) cause a pleiotrophic phenotype that includes a dry, irregular colony morphology due to the absence of the major acidic capsular polysaccharide, and the inability to grow at low temperatures. It was demonstrated that *ros* mutants show elevated expression of *virC* and

Figure 1.3.1

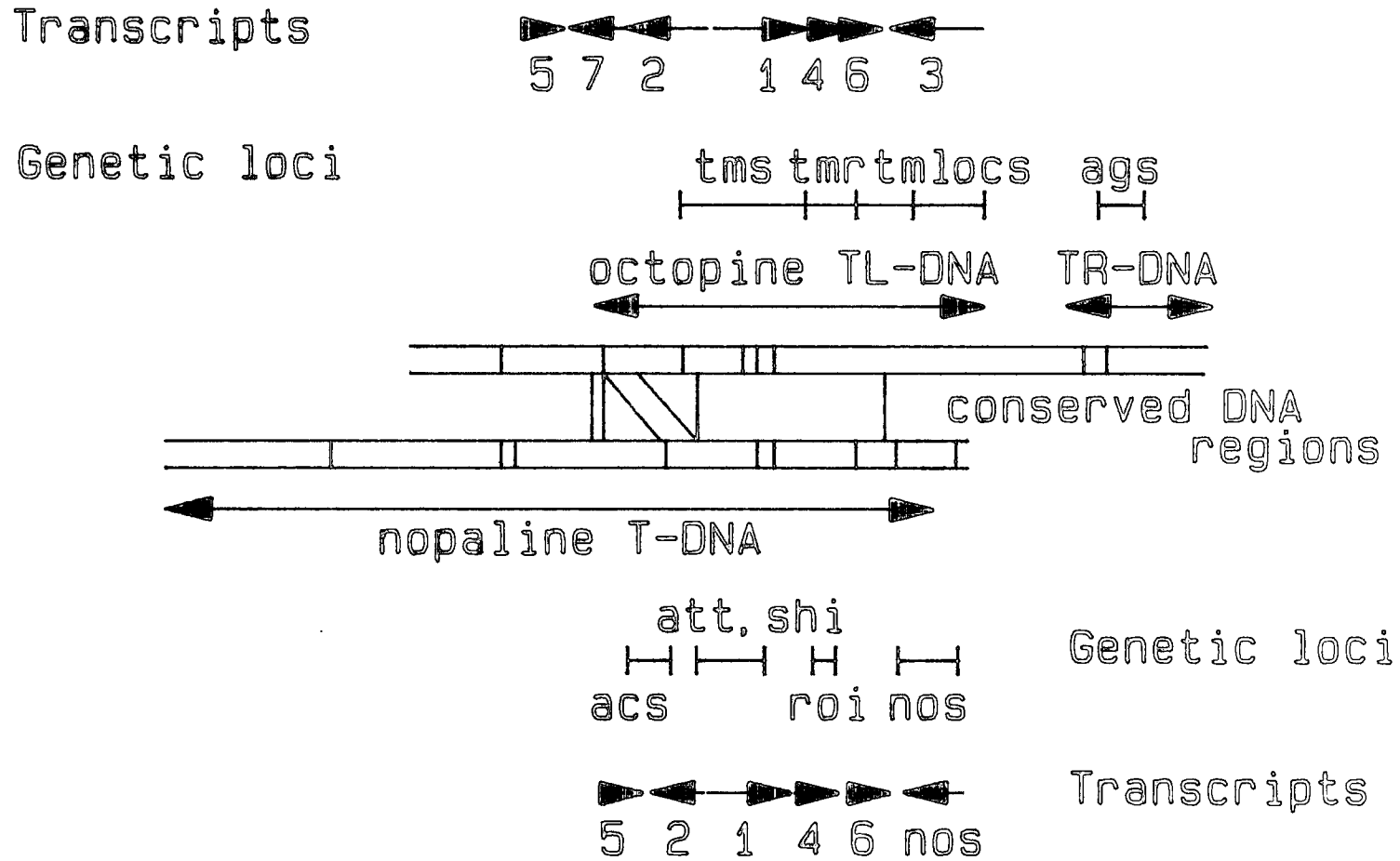
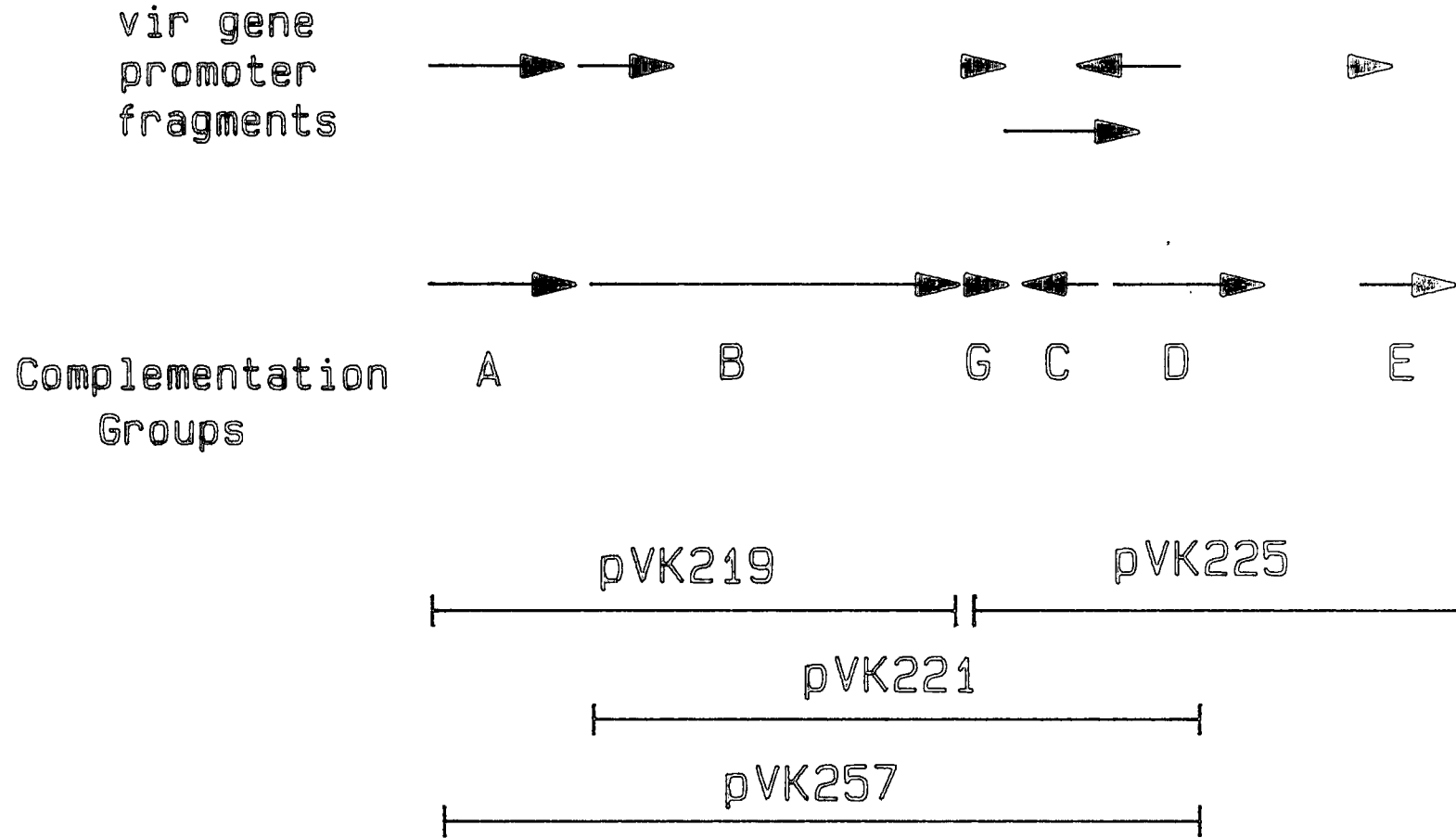

Figure 1.3.2



virD but have no effect on the other *vir* loci. It has been suggested that *ros* may function as a repressor- type regulator (69,70).

1.3.2.1 Plant derived *vir*-inducing phenolics

Agrobacterium vir expression is efficiently induced by molecules that display a similar structure to that of acetosyringone (71) . Such molecules include sinapinic acid (71), syringic acid (71) vanillin (72) and p- hydroxybenzoic acid (72) (figure 1.3.2.1). By comparing the structures of phenolic compounds that could induce the virulence region with structures of phenolics that had no inducible effects, Bolton *et. al.* predicted that the presence of a 4' hydroxyl group was important for *vir* induction (72).

1.3.2.2 *virA* and *virG*

virA and *virG* are the regulatory loci (73) which are both constitutively expressed. However, in the presence of plant cells or plant derived phenolic inducers of the virulence region, such as acetosyringone, the expression of *virB* C,D,E and G becomes greatly increased. *virA* and *virG* are both required for acetosyringone induction of the virulence operon.

1.3.2.3 *virA*

Antibody studies revealed that the 92KDa *virA* protein was localized in the bacterial inner membrane (74) and functions as an environmental sensor of plant derived phenolic inducer molecules. The amino acid sequence of *virA* demonstrated homology to the *cheA* protein which functions as a central regulator of bacterial chemotaxis and also shows homology to several other bacterial regulatory proteins (75). This evidence was supported recently with the finding that the *virA* and *virG* proteins are essential for chemotaxis towards acetosyringone (76) and suggested that the function of *virA* in the inner membrane may be that of a chemoreceptor.

Fig 1.3.2.1

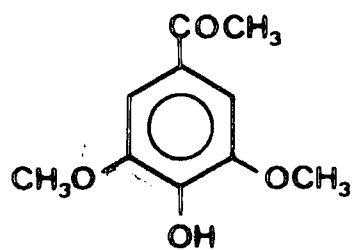

Acetosyringone

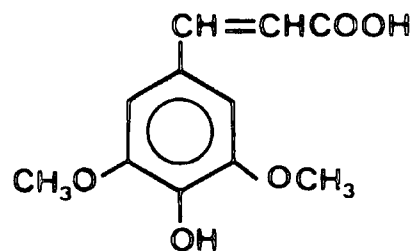

Sinapinic acid

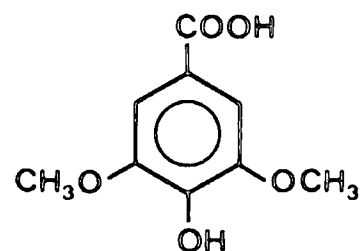

Syringic acid

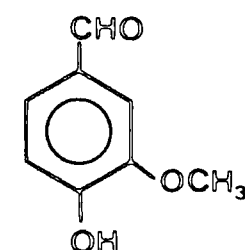

Vanillin

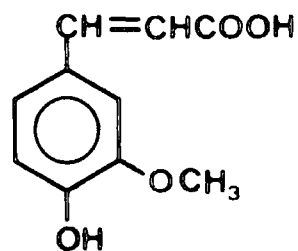

Ferulic acid

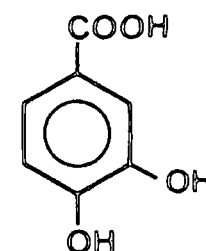

3,4 dihydroxy - benzoic acid

1.3.2.4 *virG* .

The *virG* locus encodes a 30KDa protein which is constitutively expressed, plant inducible and self regulated in a complex fashion. Two distinct and differentially regulated transcripts are produced. Sequence analysis of the *virG* protein revealed significant homology with the *Escherichia coli ompR*, *phoB* and *dye* proteins which are all positive regulatory elements for genes encoding envelope proteins (77,78).

Such results suggested that the *virG* protein was a positive regulatory protein that together with the plant signal molecule , directs the transcriptional activation of the plant inducible *vir* and *pin* (plant inducible) promoters.

A simple hypothesis for the mode of action of the *virG* protein was proposed by Stachel and Zambryski (73) who suggested that the protein may be a DNA binding protein that once induced, undergoes a conformational change, and interacts with specific *vir* promoter sequences to enhance their recognition by RNA polymerase.

1.3.2.4.1 mode of action of *virA* and *virG* : a summary

virA is proposed to encode a membrane-associated protein that transmits (either directly or via a second messenger) the environmental signal; this step results in the intracellular activation of the *virG* protein, which positively regulates transcription of *vir* and *pin* promoter sequences.

1.3.2.5 *virB*

The *virB* operon is the largest operon within the virulence region, containing at least 11 open reading frames. Recent evidence suggests that the *virB* proteins are membrane associated (79). It has therefore been proposed that they are involved in the formation of a transmembrane structure (or pore) which mediates the passage of the transferred DNA molecule through the bacterial and plant cell membranes (79).

1.3.2.6 *virC*

The *virC* complementation group encodes two proteins, *virC1* (25KDa) and *virC2* (22KDa), which are involved in host range specificity (80,81). The stop codon of *virC1* and the start codon of *virC2* are separated by only two nucleotides suggesting that the two genes may be translationally coupled.

The *virC* locus is transcribed in a counterclockwise direction, in contrast to the other *vir* loci, and is constitutively expressed in the *ros* mutant.

As well as its involvement in host specificity, the *virC* locus may be involved in the processing of T-DNA by enhancing the efficiency of endonucleolytic cleavage by *virD* proteins (82).

1.3.2.7 *virD*

The *virD* operon encodes four proteins, *virD1* (16.2KDa), *virD2* (47.4KDa), *virD3* (21.4) and *virD4* (72.4), the first two providing all of the endonucleolytic activity required to cleave the T-DNA at its 25bp border repeat sequences (83). After cleavage both double stranded (84) and single stranded (85) T-DNA molecules are thought to be present. It has recently been demonstrated that the *virD2* protein remains covalently attached to the 5' end of the T-strands forming a protein-DNA complex that could be stably transferred to the plant cell (86). The mechanistic roles played by these two proteins in the T-DNA transfer process is analogous to that of bacterial conjugation (87) where *mob* and *oriT* function to transfer single stranded DNA to recipient bacteria (88). This analogy is supported by the recent finding that *oriT* and *mob* functions of the broad host range plasmid RSF1010 can replace the requirement for *Agrobacterium* border sequences for transfer into plant cells (89).

1.3.2.8 *virE*

The *virE* operon has the capacity to code for three proteins of 9, 7, and 60 kilodaltons. Mutations in *virE* can be complemented by mixed infections with

wild type helper strains of *A. tumefaciens* suggesting that the *virE* product(s) synthesized by one bacterium could be exported and utilized during the infection process by another bacterium (90). Recently it has been demonstrated that the largest of the proteins encoded by the *virE* genes is a single stranded DNA binding protein that associates with the T-strand (91). It is postulated that another function of the *virE* operon is to produce a soluble factor (integrase) that may be involved in the integration of T-DNA into the plant genome (92).

1.4 Other Rhizobacteria.

1.4.1 *Rhizobium*

Rhizobium and *Agrobacterium* are taxonomically related (93) and their plant symbiotic states have many characteristics in common (94).

Their close association was exemplified when research demonstrated homologies between certain genes [ie the *ndvA*, *ndvB* and *exoC* loci of *R. meliloti* and the *chvA*, *chvB* and *pscA* loci of *A. tumefaciens* (95,96)]. It was also demonstrated that nitrogen fixing nodules could be induced by *Agrobacterium tumefaciens* harbouring *R. phaseoli* plasmids (97), that expression of *R. meliloti* nod genes occurred in *Agrobacterium* backgrounds (98) and that the *Agrobacterium tumefaciens* plasmid encoding agrocin 84 production could be expressed in *R. meliloti* (99). More recently it was demonstrated that cellulose plays an important role in attachment of *Rhizobium leguminosarum* to pea root hair tips (100) in a similar way to the involvement of cellulose in binding *Agrobacterium*. Another recent finding is that both *Agrobacterium* and *Rhizobium* contain reiterated DNA sequences (101), a characteristic common to eukaryotic genomes and finally it was demonstrated that *R. meliloti* encodes genes for the synthesis of an opine-like compound, that are closely linked and on the sym plasmid (102).

Rhizobium infects plant roots and causes cortical cell divisions leading to the

formation of nitrogen fixing nodules. The rhizobia generally infect the legume family, *leguminosae*; different species being defined by the subset of host plants infected. These symbiotic nitrogen fixing bacteria are divided into three genera; *Rhizobium* (including *R. leguminosarum* var *viciae*, *R. meliloti*, *R. trifoli* and *R. phaseoli*), *Azorhizobium* (formerly *R. sesbania*) and *Bradyrhizobium* (formerly *R. japonicum*).

1.4.1.1 The infection process.

The initial stage of the infection process is the recognition of plant derived compounds exuded from the host legume. Such activating compounds were identified as flavonoids, either flavones or flavanones.

Recognition induces a chemotactic response which probably plays an important role in directing the movement of the bacteria towards the plant source (103). The chemotactic response observed to several flavanoids may well be a specific response requiring the presence of certain *nod* genes, a characteristic that would directly correlate with the initial stages of the *Agrobacterium*:plant interaction (104).

Once at the plant surface it is believed that the bacteria interact with lectin components of the host cell wall. Attachment may then enable host cell wall polysaccharide-degrading enzymes to modify the cell surface of adhering Rhizobia. Modified *Rhizobium* cell wall polysaccharides may then initiate the series of events that induce host responses ready for infection (105). The binding of *Rhizobium* to the host plant surface bears some similarity to the binding of *Agrobacterium* to a susceptible plant source in that attachment triggers the processes that lead to infection. Following attachment, infective Rhizobia induce root hair curling (106) and become entrapped as the root hair curls back on itself forming a structure similar to that of a shepherds crook. The infection thread starts as an invagination of the root-hair membrane and the tip follows the host cell nucleus to the base of the root hair cell, through the wall of the

adjacent cell and down through several layers of cortical tissue. Root cortical cells appear to be induced to divide before the infection thread reaches suggesting that diffusible bacterial signal molecule(s) may initiate the formation of a new nodule meristem. The infection thread divides on reaching the developing nodule meristem and enters many of the dividing plant cells. Rhizobia then bud off from the tips of the infection thread and become encapsulated by a host derived peribacteroid membrane. The bacteria then divide and enlarge to form "bacteroids" which when mature are active in nitrogen fixation, a process requiring both bacterial (eg. nitrogenase) and plant (eg. leghaemoglobin and glutamine synthase) derived gene products.

1.4.1.2 Nodulation (*nod*) genes.

The genes involved in the early stages of infection and host range specificity reside on large indigenous ("symbiotic") plasmids in most *Rhizobium* strains and are termed *nod* genes. In *R. leguminosarum* (107) and *R. trifolii* (108) the *nod* genes lie within a 14kb region and in *R. meliloti* lie within two regions separated by about 12kb (109). In *B. japonicum* the *nod* genes are found on the chromosome (110).

1.4.1.3 Structure and function of *nod* genes.

The *nodA*, B and C genes are required for root hair curling (111) and are conserved in different Rhizobia since mutations in these genes can be complemented by the corresponding genes from other species (112). The *nodA* gene product has been reported to be in the cytoplasmic fraction (113) whereas the *nodC* gene product appears to be membrane associated (114). Two other gene loci present downstream from the *nodC* gene in *R. leguminosarum* var *viciae* are *nodI* and *nodJ* whose gene products are thought to be membrane associated and together with *nodC* may form a membrane-bound transport system (115). The *nodD* gene is the only *nod* gene that is expressed constitutively. It is responsible for the transcriptional activation of the other *nod* genes when inducer

molecules (such as flavanoids) derived from the host plant are present. This mode of action may be directly compared with that of *virG* in *Agrobacterium* and suggests that *nodD* may behave as a positive regulator molecule.

The *nodE* and *nodF* gene products inhibit nodulation. Mutations in these genes are not complemented by genes from other species suggesting a possible involvement in host range specificity (115). Two other genes believed to be involved in host specificity are *nodG* and *nodH*. *NodI* and *nodJ* share the same transcriptional unit as *nodA*, B and C and are thought to be involved in uptake of plant derived metabolites (116). Other genes identified include *nodK* (in slow growing *Rhizobium*) and *nodL* and *nodM* (in *R. leguminosarum* var *viciae*), however, the role played by these genes is unknown.

1.4.1.4 Inducer molecules.

Detailed analysis of extracts and exudates from roots of host legumes revealed that the activating compounds were flavanoids (117,118). The major activating compound from *alfalfa* was luteolin; from clover, 7,4'-dihydroxyflavone; and from pea, apigenin-7- O-glucoside. Some of the inducers are active for a wide range of rhizobia, however, others show species specificity (such as hesperitin for *R. leguminosarum*. var *viciae*). A comparison of structures of non-inducible and inducible flavanoids demonstrated that activity was dependent on the molecule having hydroxyl or glycosidic substitutions at position 7 on the A ring and position 4 on the B ring (figure 1.4.1.4).

1.4.1.5 Inhibitor molecules.

Plant derived compounds termed "nod offs" have the ability to antagonize the induction of *nod* genes by activator molecules (or "nod ons") (118). Anti-inducer molecules include certain flavanols, isoflavanoids and monocyclic phenolics such as acetosyringone. Both the activating and anti-inducer molecules share many structural similarities and it is thought that the antagonistic effects

Fig 1.4.1.4

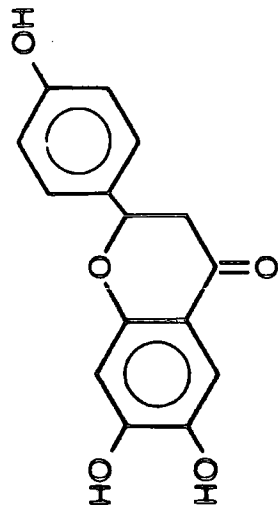

Apigenin

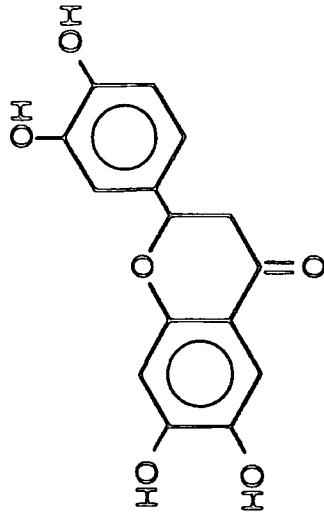

Luteolin

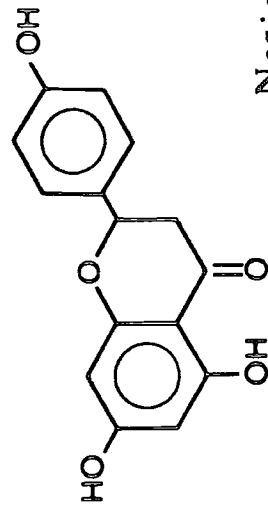

Narigenin

may be due to direct competition for binding with the *nodD* gene product.

Bacterial recognition of plant derived molecules appears to play a pivotal role in the rhizosphere associations observed between both *Agrobacterium* and *Rhizobium* and their specific host plant.

1.4.2 *Pseudomonas*

The association of the tumour forming bacterium *Pseudomonas savastanoi* with oleander and olive plants has strong similarities to the *Agrobacterium*:plant association in that both produce neoplastic overgrowths as a result of auxin and cytokinin overproduction. In this respect, the tryptophan 2-mono-oxygenase gene of *Pseudomonas savastanoi*, responsible for the conversion of IAM to IAA, has been demonstrated to show sequence homology with transcript 2 of the T-DNA (119,120). The production of cytokinin is another feature of tumour formation and both *P.savastanoi* and *A. tumefaciens* harbour genes encoding trans-zeatin biosynthesis. It was thought that no homology was evident between the *tzs* gene of nopaline Ti-plasmids which is responsible in part, for cytokinin production (121) and the genes for trans-zeatin production in *Pseudomonas* (122), However Roberto *et. al.* reported to the contrary (123).

Binding of bacteria to the host plant surface is as important in the *Pseudomonas*:plant interaction as it is in both the *Agrobacterium* and *Rhizobium* : plant associations. However, in contrast to the positive effects binding has on the *Agrobacterium* and *Rhizobium* interactions, in *Pseudomonas*, bacterial binding serves to abort the disease-causing interaction. Virulent plant pathogenic pseudomonads remain free in the intercellular spaces whereas avirulent strains become adsorbed to the plant cell surfaces and fail to induce tumours (124).

Plant-growth promoting forms of *Pseudomonas* have also been identified and these will be discussed in great detail in a later section.

1.4.3 *Azospirillum*.

Azospirillum are free-living diazotrophs that are easily isolated from the soil environment. The bacteria can promote crop yield under certain conditions, however, very little is known about how *Azospirillum* interacts with plants (125). Recent studies have revealed that there is homology between gene loci in some *Azospirillum* species and the *chv* region in *Agrobacterium tumefaciens* (120).

1.5 Bacterial chemotaxis.

Chemical communication is of utmost importance in biology and indeed was stated to be one of the fundamental attributes of life itself (127).

Communication between bacteria and their environment first came to light exactly a century ago when Pfeffer identified the presence of chemotactic responses by microorganisms towards a solution of attractant in a capillary tube (128). Adler (129) repeated Pfeffer's studies and modified the assay to enable a quantitative study of the phenomenon to be made. Over the last decade a revival has taken place in chemotaxis research and although a full understanding of the chemotactic system has not been elucidated, a more indepth understanding of the molecular events has enabled speculative models for chemotaxis to be proposed (130,131).

Chemotaxis in bacteria is defined as the detection of temporal or spatial changes in concentrations of specific chemicals; behaviorally responding to these changes and then adapting to the new concentration of chemical stimulus, thereby influencing the movement of bacteria up a concentration gradient towards the source of attraction.

Most research into the chemotactic phenomenon has, to date, been performed on bacteria within the family *Enterobacteriaceae*; namely, *Escherichia coli* and *Salmonella typhimurium*. At least two molecular complexities appear

to be involved in the chemotactic processes of these bacteria; the first being the molecular device allowing the measurement of gradients of chemical stimuli and the second being the bacterial flagellar motor.

In the absence of spatial or temporal gradients of chemoattractants bacteria propel themselves by a series of straight runs that terminate in a tumble (132). In *E. coli* and *S. typhimurium* runs involve rotation of all or most of the flagellar motors in a counter clockwise direction (CCW) whereas tumbles result from movement of flagellar motors in a clockwise direction (CW) (133). It is not clear if reversal of all, a majority or a single flagellar motor is sufficient to produce a tumble (134). Tumbling events usually last for less than a second and result in a nearly random reorientation of the bacterium (132), the probability of a tumble occurring being independent of the last tumble (132). Tumbles are only seen in the enteric bacteria and as a result of such events the bacterium undergoes the classic random walk in three dimensions (132).

In the presence of a chemical stimulus the rate of tumble is determined by the direction the bacterium is moving in the gradient. If the bacterium is moving in a favourable direction the rate of tumbling is less than in the absence of a gradient and if the bacterium is moving in a less favourable direction the rate of tumbling is approximately the same as that observed without a gradient (135), the overall effect being the movement of cells in the favourable direction. Bacteria are unable to directly turn towards a source of attractant (132), instead they increase the time spent going in favourable directions by suppressing tumbling. Bacteria are able to maintain a record of their environment over the recent past and if the current environment is detected to be more favourable than the previously recorded one, then tumbles are suppressed. However, if the environment is detected to be less favourable than that previously detected then tumbling is enhanced. The record is continually updated, adaptation taking minutes if a large chemostimulus is applied and seconds for smaller gradients of stimuli

(136). If after this time the environmental and recorded levels do not differ then the bacterium returns to the classic random walk pattern.

The chemotactic response to temporal and spatial gradients may therefore be described as consisting of two phases; an excitatory phase which is fast but not instantaneous and results in the modification of the rate of tumbling, followed by an adaptive phase which is slower, ranging from seconds to minutes, corresponding to the cells updating their record of the environment during the recent past.

1.5.1 Components of the chemotaxis system.

A whole range of chemoattractant molecules have been identified, some of which share the same receptor binding proteins. The known chemoreceptors fall into three distinct categories :-

1.5.1.1 Periplasmic binding proteins

Periplasmic binding proteins are primarily involved with transport of molecules across the periplasmic space but some have a distinct role in chemotaxis (137). Examples include the maltose binding protein (MBP), galactose binding protein (GBP) and the ribose binding protein (RBP). Not all periplasmic binding proteins are chemoreceptors, even though there is much structural similarity with those that do function as receptors (138).

To communicate with the cytoplasm the periplasmic binding proteins must first interact with a second class of receptor molecules termed transducer proteins.

1.5.1.2 Transducer proteins

Transducer proteins (139,140) span the inner membrane and provide the pathway for transmembrane signal production (141). Such proteins not only function as receptors for the periplasmic binding proteins but can also func-

tion as primary receptors. For example the Tar protein in *E. coli* mediates signals from the maltose binding protein (139) as well as directly binding aspartate (142). These membrane proteins are also involved in the methylation and demethylation events which accompany adaptation (135) and are therefore termed MCP'S (methyl accepting chemotaxis proteins).

1.5.1.3 Receptors associated with the PTS

The third type of receptors are associated with responses to sugars such as glucose, that are transported by the phosphotransferase system (PTS). The receptors are the enzyme II proteins involved in the binding and phosphorylation of sequestered sugar residues (143). Adaptation to stimuli mediated by this class of receptor appears to be methylation independent (144).

1.5.2 Detection of chemotactic stimuli

1.5.2.1 Receptors and transducers

Four homologous proteins (Tsr, Tar, Trg and Tap) have been identified as transducer proteins in *E. coli*. Tsr and Tar bind some amino acids directly as well as interacting with periplasmic binding proteins (142), and all four transducers are involved in adaption (141).

1.5.2.2 Structural and functional domains

There are distinct regions on the Tsr and Tar (145) and probably on the Trg (146) and Tap (147) proteins that provide all of the transducer functions. These structural and functional domains have been determined by both DNA sequence analysis and amino acid sequence comparisons (figure 1.5.2.2). Most of the amino terminal portion of each transducer lies in the periplasmic ^{side of the} membrane whereas the carboxyl terminal portion resides on the cytoplasmic side. Each transducer protein has two highly hydrophobic areas termed TMI and TMII which may serve as membrane spanning segments involved in ligand induced conformational changes (146). The amino terminal domain is involved

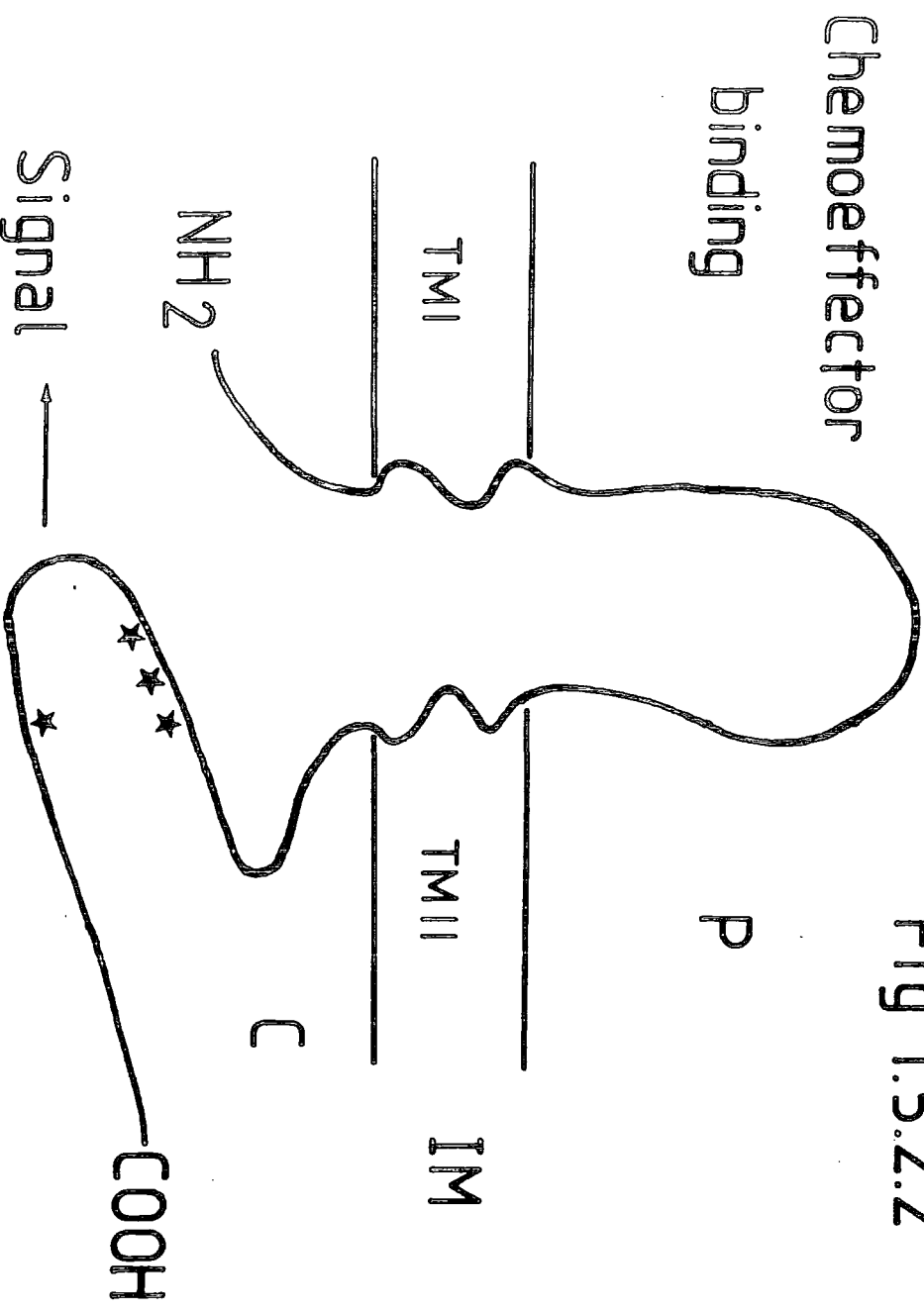

Fig 1.5.2.2

primarily with the binding of chemoattractants and repellents (148) whereas the carboxyl terminal domain is involved in interactions with signal molecules and in adaptation. Adaptation involves the methylation of specific glutamate residues which in all four transducer proteins are clustered in two sequences separated by 200 amino acids (149).

1.5.2.3 Receptor and transducer specificities.

It was demonstrated that a mutation in a gene encoding a receptor or transducer wipes out chemotactic responses to some chemoattractants but does not affect cell motility and chemotaxis towards other chemotactic stimuli (141). Analysis of mutants (150,151) led to the determination of specificities of receptor and transducer proteins in *E. coli* and *S. typhimurium* (figure 1.5.2.3).

For most amino acids a single protein acts as chemoreceptor and transducer. Tsr (taxi to serine and from repellents) is the receptor-transducer protein for serine, alanine, glycine, and the non-metabolizable amino acid analogue α -amino isobutyric acid (152). Tsr also mediates a response to the repellent leucine (152).

The Tar protein (taxi to aspartate and from repellents) is the receptor-transducer for the attractants aspartate, α -methyl aspartate and glutamate and for the repellents Co^{2+} and Ni^{2+} (152,153). Many of the sugar (137) and dipeptide (154) chemoattractants interact with periplasmic binding proteins that are distinct from the transducer proteins. Direct binding to periplasmic binding proteins brings about a conformational change that allows the receptor-attractant complex to interact with one of the four transducer proteins. An example being the peptide binding protein, that functions not only as a component of the peptide transport system (140,154) but also as a receptor for dipeptides and some tripeptides. The dipeptide-complexed binding protein interacts with the Tap transducer (140).

Figure 1.5.2.3

	Transducer	Stimulus	Gene	MCP
amino-acids and repellents	TSR	serine	tsr	Tsr
	TAR	alanine glycine leucine aspartate glutamate Ni ²⁺ , Co ²⁺	tar	Tar
Some sugars and dipeptides	TRG	galactose	mg1B	Trg
	TAR	ribose	rbsB	Trg
	TAP	maltose	malE	Tar
		dipeptides	dpp	Tap
PTS sugars	PTS Enzyme	glucose	ptsG	?
		mannose	ptsM	
		fructose	ptsF	
		mannitol	mt1A	
		glucitol	gutA	
galactitol	gatA			

Similarly some of the sugar transport components act as chemoreceptors. The periplasmic maltose binding protein (MBP) interacts with the Tar transducer when bound to maltose (155) and the ribose and galactose binding proteins with the transducer Trg (taxis to ribose and galactose) when bound to ribose and galactose respectively (139,156).

1.5.2.4 Adaptation : The methylation and demethylation of transducer proteins (MCP'S).

The transducer proteins undergo posttranslational modifications that play an important role in the adaptation phenomenon. Methyl groups are transferred by a chemotaxis specific methyltransferase (the product of the *cheR* gene) from S-adenosylmethionine to the transducer proteins which result in the conversion of specific glutamate residues to γ -glutamyl methyl esters (157,158). For this reason the transducer proteins are often referred to as methyl accepting chemotaxis proteins (MCP'S). Five methylation sites have been identified for Trg (159) and Tsr (160), four for Tar (161) and a similar number for Tap. Methyl groups are removed by the action of the *cheB* protein which functions as a chemotaxis specific methylesterase and catalyzes the hydrolysis of the γ -glutamyl methyl ester bond forming methanol and regenerating the γ - carboxylates of the glutamic acid residues (162).

In *E. coli*, *S. typhimurium* (163,130) and *B. subtilis* (164) MCP methylation is thought to play an important role in the adaptation process. *E. coli* and *S. typhimurium* show increased levels of MCP methylation in response to adaptation to positive stimuli and decreased levels in response to negative stimuli (130). Conversely, in *B. subtilis* attractant stimuli cause decreased MCP methylation levels and repellent stimuli evoke increased levels of methylation (165). A given stimulus only affects the methylation state of the transducer responsible for its detection (166) and therefore the activity of the methyltransferase and / or methylesterase will be regulated by the concentration of the specific

chemoeffector.

1.5.3 Flagella structure in *S. typhimurium* and *E. coli*.

Each flagellar organelle has three main substructures referred to as the flagellar filament, the flagella hook, and the basal body (figure 1.5.3). The small motors responsible for the propeller-like rotation of the flagella reside at the base of each flagellum (167), and are powered by proton motive force (168).

1.5.3.1 The flagellar filament.

The filament is a long ($10\mu\text{m}$), thin (diameter 20nm) rigid structure and is comprised of identical subunits of flagellin. In *E. coli* this 54KD protein is encoded by the *hag* gene (169), however, in *S. typhimurium* there are two genes, H1 and H2 which encode similar but distinct flagellin proteins (170).

When the majority of flagella on a single bacterium rotate in a CCW direction the individual filaments interact to produce a flagellar bundle that propels the cell at speeds ranging from $20\text{-}60\mu\text{m s}^{-1}$. In *A. tumefaciens* speeds of up to $60\mu\text{m s}^{-1}$ have been recorded (171). Some of the soil bacteria such as *Rhizobium* and *Pseudomonas* species possess novel types of flagella which have been termed 'complex' (172). In *Rhizobium meliloti* such complex structures form right handed helices that rotate in only a CW direction or not at all (173).

1.5.3.2 The flagellar hook.

The flagellar hook is thought to function as a flexible universal joint (134) transmitting the rotational movement of the motor to the filament to enable propulsion of the bacterium in the favoured direction. The flagellar hook is composed primarily of a single 42KD protein encoded by the *flaK* gene (174). The length being regulated by the *flaE* gene product (175). Three other hook-associated proteins termed HAP1, HAP2, and HAP3 are responsible for defining the proximal and distal ends of the flagellar filament (176). HAP1 and HAP3 are localized at the hook filament junction and are encoded by *flaW(flacS)* and

Fig 1.5.3

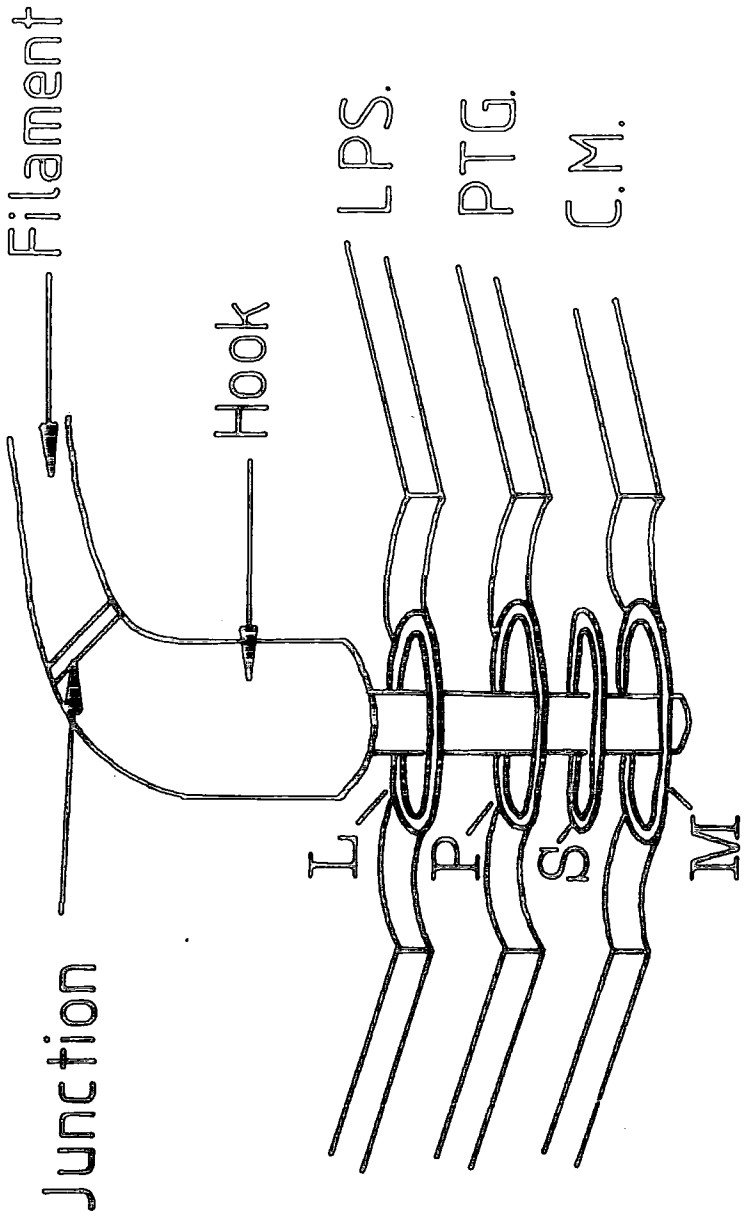

flaU (*flaT*) of *S. typhimurium* (*E. coli*) respectively. HAP2 is localized at the tip of the flagellar filament and functions in the assembly of flagellin monomers. It is encoded by the *flaV* (*flaC*) gene.

1.5.3.3 The basal body

The basal body is the most complex of the flagellar components and is comprised of approximately nine proteins. Four ring like structures termed lipopolysaccharide (L), peptidoglycan (P), stator (S), and motor (M) surround a central rod that terminates at the flagella hook (see figure 1.5.3). The following genes have been assigned to be associated with the following morphological features of the basal body apparatus : *flaAII.1* and *flaM* (65 and 39KD) are associated with the M ring, *flaFV* (42KD) with the hook, *flaFVI* and *FVII* (32 and 30KD) with the rod, *flaFVIII* with the L ring, *flaFIX* (39KD) with the P ring, *flaU* and *flaW* (31 and 59KD) with the filament-hook junction, *flaV* (48, 53KD) with the tip of the flagellar filament, and H1 and H2 with the flagellar filament (176,177,178). Two other genes, *motA* and *motB* encode integral membrane proteins that may function as oxido-reductases, required for movement of the S/M ring (179).

1.5.3.4 Molecular biology of flagella components.

Over 30 genes are necessary for flagella assembly and function (134) and these are located at three major regions of the *E. coli* chromosome.

1.5.3.5 Regulation of expression.

Transcription of all of the flagellar genes is regulated by a cascade mechanism (figure 1.5.3.1). The first genes in the cascade being *flaI* and *flbB* which are directly controlled by catabolite repression (180). Since transcription of all other flagellar genes requires the expression of *flaI* and *flbB*, catabolite repression indirectly regulates the cascade process. Expression of *flaI* and *flbB* (group 1) is required for expression of genes in groups 2 and 3. Group 3 gene products

Figure 1.5.3.1

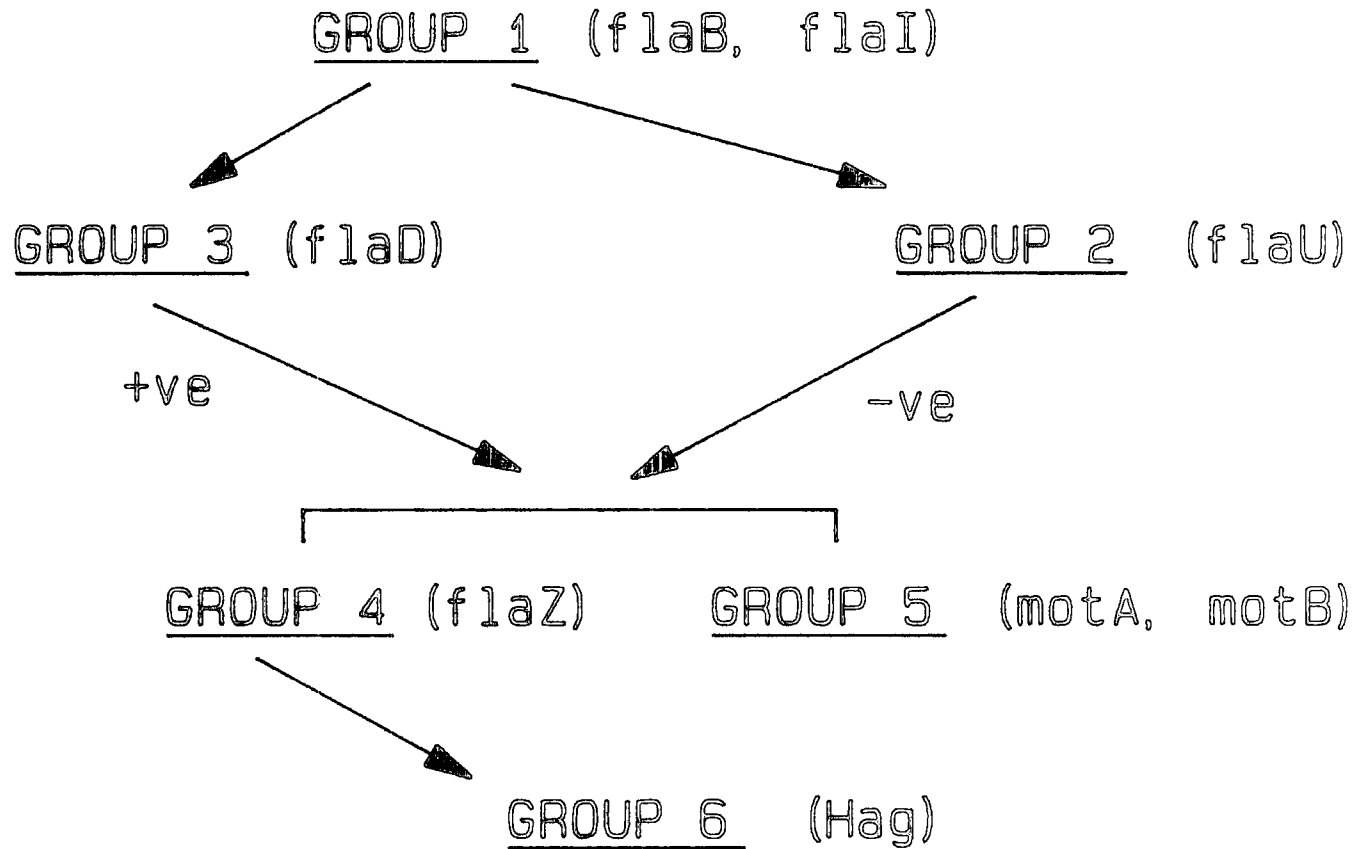

control the expression of group 4 and 5 genes and group 4 (*flaZ*) must be expressed to obtain flagellin (*hag*) expression. It was recently demonstrated that the group 2 gene *flaU* and the group 3 gene *flaD* encoded products that served as negative and positive effectors, respectively, of the genes located beneath them in the regulatory cascade (181).

1.5.4 Information flow during bacterial chemotaxis.

Several models have been described in an attempt to explain the flow of information during the chemotactic process (130,131). The best interpretation is as follows (figure 1.5.4a and 1.5.4b) :- An attractant (A) can bind directly to a methyl accepting chemotaxis receptor (R) or via a periplasmic binding protein. On binding an attractant, the receptor-attractant complex (R-A) produces a positive signal (smooth swimming signal, CCW flagella rotation). The bacterial cell responds by slowly adding methyl groups (M) from S- adenosyl methionine to the R-A complex converting R-A into R-A-M. This reaction being catalysed by the *cheR* gene product (methyltransferase). The R-A-M complex is rapidly equilibrated to R-M which produces a negative signal (tumbling, CW flagella rotation). The products of *cheA* and *cheW* communicate with the R-A complex and the flagella motor and play a pivotal role in the chemotaxis signalling pathway (182).

The tumble and smooth swimming signals are integrated and directed to the flagella motor and are regulated by the *cheY* (182,183) and *cheZ* (182,183,184) gene products which regulate CW and CCW rotation of the flagella, respectively. When both the positive and negative signals (R-M and R-A) are in equilibrium, adaption to the positive stimulus is achieved. If at this point the attractant is removed then all of the methylated receptors become R-M and all of the unmethylated receptors become R. Since the bias is now on the negative signal (R-M) then the flagella rotate in a CW direction and the bacterium tumbles. In order to adapt to the negative stimulus, methyl groups are removed

Figure 1.5.4a

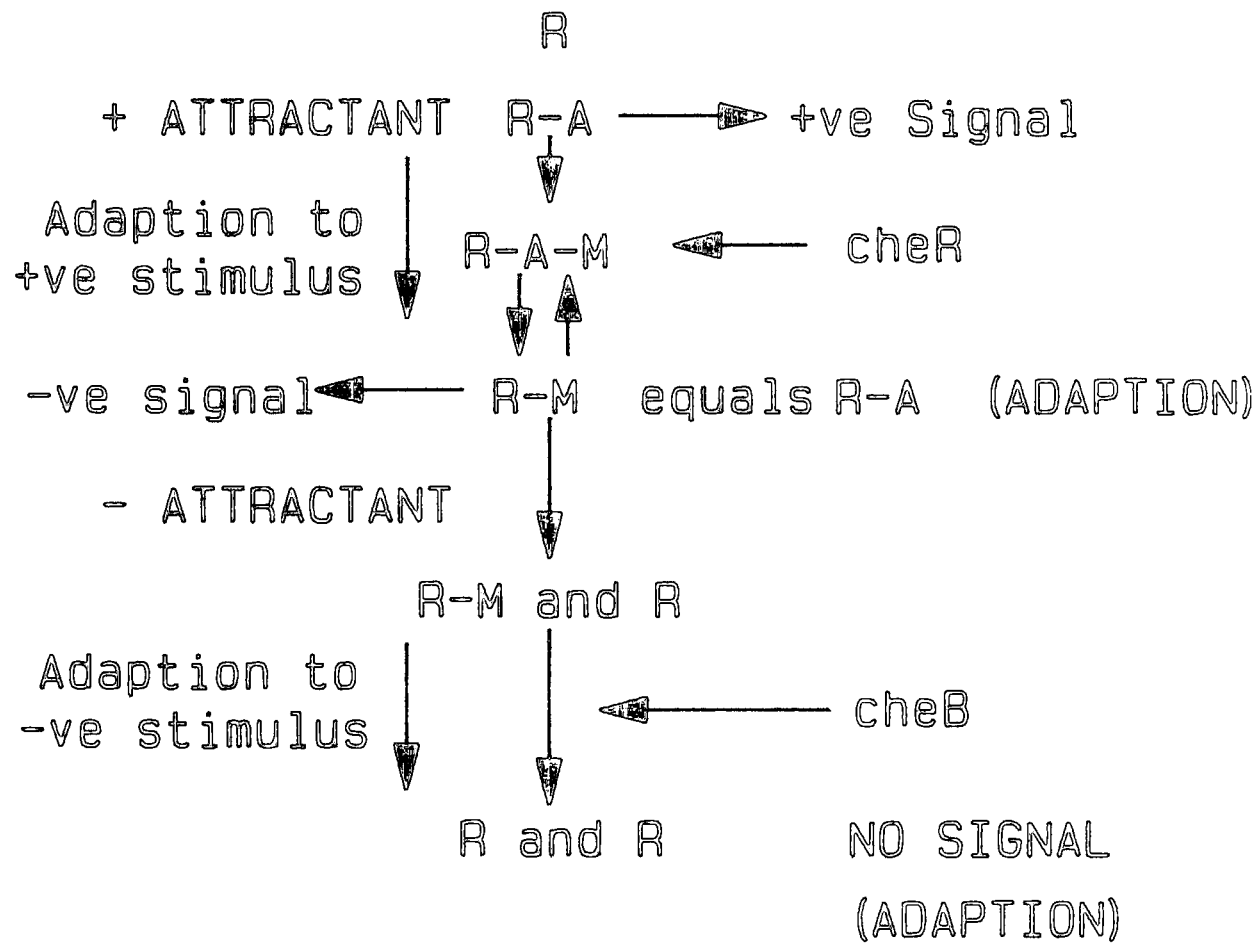
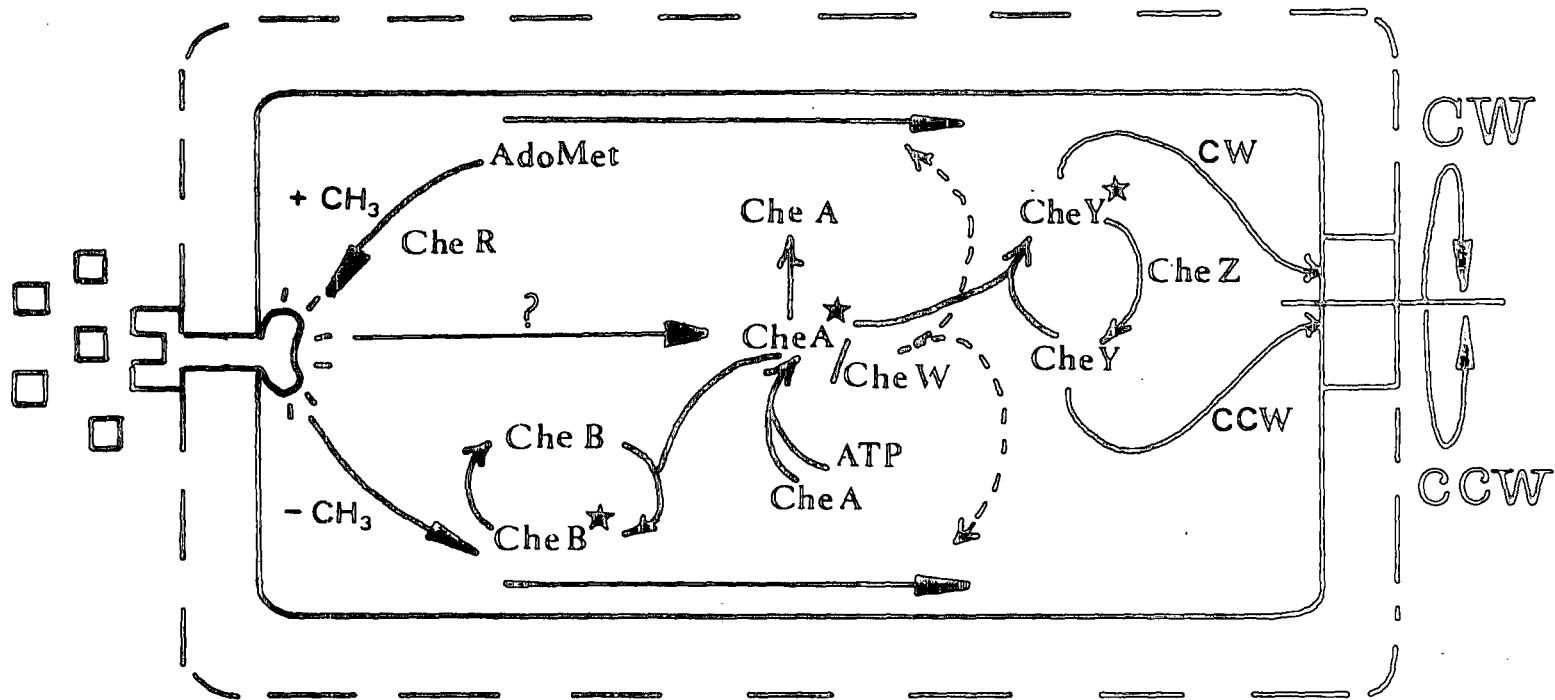

Fig 1.5.4 b



from the receptor, resulting in the production of methanol. This reaction is catalysed by the *cheB* gene product (methylesterase). The result being that all R-M complexes are converted to R, which is the stable receptor state and therefore produces no signal. The bacterium has therefore adapted to the negative stimulus effect.

The *cheA* gene shares much homology with the *virA* gene from *A. tumefaciens* as well as other positive regulator genes (185). It functions in this fashion by regulating both the *cheB* and *cheY* gene products and therefore having a regulatory effect on tumbling displayed during CW rotation of the flagellar apparatus.

1.6 Chemotaxis in the rhizosphere.

It is well documented (104,186,187,188,189) that many rhizobacteria display the phenomenon of chemotaxis. Both *Rhizobium* and *Agrobacterium* were shown to accumulate around the roots of certain plants (190,191,192). More recently it has been demonstrated that *Rhizobium* (189,193,194), *Pseudomonas* (187,188), and *Azospirillum* (187,195), all respond chemotactically towards natural plant extracts. Over the last two years it has become apparent that *A. tumefaciens* also displays the phenomenon of chemotaxis (104,173,186).

Rhizobium was shown to be chemotactically attracted to several plant derived flavones (103) and *P. putida* to aromatic acids (196), suggesting that chemotaxis may well play a role in guiding these rhizobacteria to the susceptible plant source in the environment of the rhizosphere. It has been demonstrated that chemotactic movement of bacteria in the rhizosphere does occur (195,197,198) and that the motility of bacteria may play an important role in the colonization of roots. Hafele and Lindow demonstrated that flagellar motility conferred epiphytic fitness advantages upon the ice-nucleation strain, *P.syringae* (199). It was demonstrated that *P.aeruginosa* cells were able to migrate through moist soil a distance of 2cm in 24 hours (197) and *P. putida*,

a distance of 2cm in 48 hours to imbibing soybean seeds in raw soil (198). *Azospirillum brasilense* Cd was also shown to migrate towards plants and move horizontally, in a controlled environment, distances of 30cm and vertically, distances of up to 40cm. Horizontal movement under field conditions was at least 160cm and vertical movement at least 50cm. It was concluded that *A. brasilense* Cd demonstrated both horizontal and vertical movement in various soil types and that the movement was highly dependent upon the presence of a plant source (195), further emphasizing the belief that motility is important in root colonization.

1.7 Biological control agents: microbial inoculants.

The recent concern expressed about the growing side effects that chemical pesticides have on non-target organisms and indeed on the environment has improved the political and economic climate of biological control.

New useful chemical methods for pest control are becoming harder to find and the problem of biological resistance greatly reduces the life span of those currently in use. Biological crop protectants have therefore received much attention since they afford a safer and more directional alternative to the conventional chemical approach.

For many centuries, farmers and agriculturalists have employed the use of natural biological control agents in the quest to eradicate some of the major crop diseases. Over the last few decades, and even in present day crop management, natural biological control agents are still employed.

There are a great variety of biological control agents available, their economic importance being determined by two main attributes : virulence and persistence. The biological control agent being virulent with respect to the specific pathogen against which it is desired to be active and avirulent with respect to non-targeted organisms, humans, and the environment. The biological con-

trol agent would also be required to persist in the microenvironment for the duration of the targeted pathogens active life span but would be deterred from infesting that environment and becoming a pest of its own accord.

The use of biological control is very broad encompassing the use of transgenic plants for pest control and increased crop yield (200), predator/parasite interactions, natural microbial control agents that directly effect increased crop yield (201) and those that have effect indirectly by controlling pathogen attack (202) and genetically modified natural microbial control agents effective against a targeted pathogen (203).

The probability of expanding current development on natural microbial control systems and modifying such systems genetically to enhance the natural biological response is believed to have a success time span of 5-10 years whereas the introduction and expression of desirable pesticidal genes in agriculturally important crop plants is estimated to be achieved over a much longer time span of 10-20 years (204). Since the development of natural microbiological control agents, genetically modified natural biological control agents, and in particular the development of bacteria associated with the plant rhizosphere as biocontrol agents are of relevance to this research, they will now be discussed in more detail.

Microbial biological control can be divided into two component areas : the delivery system (ie the microorganism employed), and the active molecule (ie the pesticidal protein or growth promoting agent).

1.7.1 Natural biological control agents.

Natural microbial control agents have been employed for many years in an effort to both increase crop yield directly by providing useful growth substrates for the plant, and indirectly by reducing crop damage by the removal of deleterious microorganisms and/or chemicals from the environment.

1.7.2 Microorganisms having direct effects on crop yield.

Direct effects on crop yield have been demonstrated by microbial groups that supply plants with combined nitrogen. These include the symbiotic nitrogen fixing rhizobia in legumes (201), actinomycetes in nonleguminous trees (205), and blue green algae in symbiosis with water ferns (206). Bacteria within the genus *Azospirillum* in their associations with grasses and legume roots, not only supply combined nitrogen but also affect the development and function of their hosts thus improving mineral and water uptake (207). Other microorganisms known to be beneficial to crop yield are the phosphate solubilizers, plant growth promoting pseudomonads, and mycorrhizal fungi (206).

1.7.3 Microbial inoculants indirectly beneficial to crop yield

1.7.3.1 *Agrobacterium* as a natural biological control agent.

The first natural system to be commercially developed to control a plant disease in soil was that of *A. radiobacter*. The bacterium (acting as the delivery system) produces the bacteriocin agrocin 84 (the active molecule) which is a low molecular weight adenine nucleotide-like compound that is effective against many of the agrocin non-producing pathogenic strains of *A. tumefaciens* and therefore is efficient in alleviating crown gall tumour disease (208). Recently it has been demonstrated that certain biotype 2 strains of *A. tumefaciens* also possess a functional agrocin 84 however, it is not as effective at controlling crown gall as its *A. radiobacter* counterpart (209). Agrocin 84 was found to be effective against strains harbouring a nopaline Ti-plasmid (210) however it has since been demonstrated that uptake of agrocin 84 is dependent on the ability of the strain to utilize agrocinopines (211), agrocin 84 being able to mimic agrocinopine A and therefore be transported into the susceptible cell via the Ti-plasmid encoded agrocinopine permease system. Agrocinopine Ti-plasmid containing strains of *A. tumefaciens* are not frequently isolated around grapevines which offers one explanation for the inability of the agrocin 84 system to function effectively

in controlling crown gall on this plant type (212). Recently, however, Webster and coworkers (213) demonstrated that a biotype 2 strain of *A. tumefaciens* produced an agrocin that was effective against grapevine isolates, and that sensitivity to the protein was not a Ti-plasmid determined trait.

Genetic modifications have increased *Agrobacterium's* usage as a biological control agent. The *A. radiobacter* plasmid pAgK84 has been modified to prevent it from being transferred to *A. tumefaciens* under field conditions and therefore increases the efficiency of the agrocin 84 system for biocontrol (214). A second modification involved the cloning of the *Bacillus thuringiensis* δ endotoxin gene into the chromosome of *A. radiobacter* (215).

1.7.4 Plant-growth-promoting fluorescent pseudomonads.

A second type of indirect biological control currently being employed is that of the plant-growth-promoting fluorescent pseudomonads, whom upon inoculation are able to suppress the deleterious effects of other microbial pathogens (216). Fluorescent pseudomonads are highly motile and are good root colonizers (217). They also possess a very versatile metabolism enabling them to utilize a wide variety of plant derived substrates and themselves produce an array of secondary metabolites that are effective against other microorganisms (216,218,219).

Several hypotheses have been put forward to explain how these rhizobacteria promote plant growth (218,220), the most favourable being an overall reduction in numbers of rhizosphere microorganisms (bacteria and fungi) as a result of competition for iron (Fe). The plant-growth-promoting fluorescent pseudomonads (the delivery system) produce secondary metabolites termed siderophores (the active molecule) in iron limiting environments. The siderophores are small molecules (Mr 1000 to 1500) composed of a quinoline-type chromophore and a linear peptide with a δ -N-hydroxyornithine as the C-terminal amino acid (221), and have an extremely high affinity (approximately 10^{11} times greater) than

the hydroxamate based siderophore of fungi for chelating ferric ion (Fe^{3+}) complexes (218). The siderophore system in pseudomonads therefore affords the bacterium good antagonistic properties for iron chelation.

Schippers and coworkers demonstrated that mutants obtained by transposon mutagenesis which had lost the ability to produce siderophores in vitro, also lost all plant-growth-promoting properties although they were still as efficient as the wild type strain in colonizing the root matrix (222).

Two examples of successful biological control employing the pseudomonad system is the control of the specific soil borne pathogen *Gaumannomyces graminis* var. *tritici* which is the causal organism of the take-all disease of wheat (219) and the second being the suppression of *Fusarium oxysporum* wilt (218).

Genetic developments have resulted in the transfer of genes encoding siderophores from one pseudomonad strain to another enabling full advantage to be taken of both bacterial colonizing ability and efficiency of active molecule. This has been achieved by Advanced Genetic Sciences (A.G.S) by transferring a gene encoding a siderophore from *P.fluorescens* to *P.putida*, an extremely effective root colonizer. They have also integrated the siderophore sequence into the chromosome of *P.putida* (223).

The genetically modified system appears to be effective against *Pythium*, a fungus that infects seedlings of cotton and other vegetables.

Another problem encountered in agriculture is frost damage to plants which can result in serious losses of valuable crops. The causal agents being *Pseudomonas syringae* and *Erwinia herbicola*, who reside as epiphytes on the leaf surface and cause nucleation of ice which results in frost damage. Research into this system revealed that the symptoms could be eradicated when an antagonistic non-ice nucleating bacterium was applied to the plant surface (224). Genetic manipulation of the *Pseudomonas* genome allowed well characterized

deletions to be made which removed the ice nucleation phenotype (203). Such strains were no longer able to elicit the ice nucleation phenotype on plants in growth chamber experiments.

1.7.5 Monitoring bacterial movement in the rhizosphere.

A very valuable project has been undertaken by Clemson University, SC and Monsanto who are monitoring the movement of *Pseudomonas fluorescens* that has been tagged with a complement of genes from *E.coli* allowing it to utilize lactose. A simple test distinguishes the engineered strain from the wild type, thus allowing bacterial movement to be closely recorded. This type of experiment is of utmost importance to the development of genetically modified biological control agents since it offers a method of following the movement of tagged bacteria in the rhizosphere and therefore allows analysis of the risks of infestation to other soils. Results demonstrated that the engineered bacterium remains in close proximity to the plant root system and is not found dispersed at distances away from the plant source (New Scientist, 18th February 1988).

1.7.6 *Bacillus thuringiensis*: a natural biocontrol agent.

Many common insecticides employed today are formulated with *Bacillus thuringiensis*. The Gram-positive spore forming bacterium produces a sporulation specific protein called δ -endotoxin that has insecticidal activity specifically directed against insects belonging to the orders *Lepidoptera* and *Diptera*, the former order containing many of the insect pest species of importance in agriculture (225). The majority of the *B. thuringiensis* species active against the *Lepidoptera* produce the insecticidal protein in the form of a bipyramidal crystal which upon ingestion, causes the insect larvae to stop eating and die within a few days following paralysis. The δ -endotoxins are thought to act as feeding poisons which destroy the gut epithelia (226).

A product consisting of a *Bacillus* formulation commercially available as a

biocontrol insecticide is "Dipel" which is manufactured by Abbott laboratories (U.S.A). It consists of *B. thuringiensis* (δ -endotoxin plus spores) and is targeted against numerous species of *Lepidoptera* (227).

Much research has been directed towards the cloning and expression of the δ -endotoxin in other more efficient root colonizing bacteria such as *Pseudomonas* (228) and *Agrobacterium* (215) as well as blue green algae (229).

Mycogen were the first company to get approval from the American Environmental Protection Agency (E.P.A) to field test their genetically engineered B.T. δ -endotoxin in dead *Pseudomonas* cells (228). The trials clearly demonstrated that the genetically modified δ -endotoxin was effective in the rhizosphere.

1.7.7 Fungal biological control agents.

The biological control of soil-borne plant pathogens by the application of fungal species is another potential non-chemical method of plant disease control, involving processes such as antagonism, competition, hypovirulence, and cross protection. Several fungi including *Penicillium* and members of the genus *Trichoderma* have been successfully employed as antagonists against plant pathogenic fungi (230).

1.7.8 Fungi as biocontrol agents of insects and mites.

The control of insects and mites poses a serious problem for conventional chemical methods of pathogen control since many non-targeted insects are affected and the incidence of resistance to chemical pesticides is rising among plant pathogenic insect species. For this reason several biological control systems have been sought after in an attempt to alleviate the problems (231). Several fungal systems have been identified as strong candidates for biological control. These include *Verticillium lecanii* for the control of aphids, *Beauveria bassiana* for the control of the Colorado potato beetle, *Hirsutella thompsonii* for controlling mites, and members of the *entomophthorales* which are effective

against a range of insect pests (231,232).

1.7.9 Biological control of weeds.

Conventional chemical methods of weed control have proven inefficient in many cases and therefore it has recently come to light that alternatives to herbicides may be developed from existing fungal plant pathogens (233). Examples of the successful attempts at microbial weed control are the use of *Colletotrichum gloeosporioides* to control weeds in rice (234), *Alternaria cassiae* against *Cassia obtusifolia* (235) and *Phytophthora palmivora* as a biocontrol agent against milkweed vine, a major weed pest in citrus growing areas of Florida (236).

1.8 Aims and objectives of this research.

The discovery early on in my PhD that *Agrobacterium tumefaciens* displayed the phenomenon of chemotaxis, initiated an indepth study of this process with a view to demonstrating how important this phenomenon is in the environment of the rhizosphere.

One of the main objectives was to accumulate data on chemotaxis towards natural homogenates of both dicotyledonous and monocotyledonous origin and assess the role played by the Ti-plasmid in the response. Secondly, a range of plant derived monocyclic phenolic compounds were analysed with a view to correlating their ability to induce the Ti-plasmid virulence operons, with Ti-plasmid encoded chemotaxis.

The data obtained on chemotaxis in *Agrobacterium* enabled a biological picture of events occurring in the rhizosphere to be postulated, and operational rules concerning structures of phenolic compounds required for Ti-plasmid encoded chemotaxis to be established.

Following on from these discoveries a novel concept for a genetically engineered biopesticide was developed. The idea for this pesticidal delivery system is based on the discoveries made in Ti-plasmid encoded chemotaxis together

with the known properties of virulence induction.

The main objectives here were to subclone one of the virulence promotor fragments and to link this 'cassette' to a suitable pesticidal gene lacking promotor sequences. In this way pesticide would be produced under the control of a virulence promotor and therefore would be expressed only in the presence of *vir*-inducing components such as the monophenolic, acetosyringone. Having achieved this aim, the next objective was to mobilize the construct into *Agrobacterium* C58C¹ harbouring the regulatory genes, *virA* and *virG* and to ensure that the Ti-plasmid encoded chemotactic trait towards acetosyringone was still evident and that the pesticidal protein was produced and secreted only in the presence of acetosyringone.

Chapter 2
Materials and methods

Chapter 2 : Materials and methods.

2.1 Materials.

All chemicals and biological reagents, with the exception of those listed below, were from Sigma Chemical Company Ltd, Poole, Dorset.

Restriction endonucleases, T4 DNA ligase, 5-bromo-4-chloro-3-indoyl- β -D-galactoside (X-Gal), Tris (hydroxy methyl) aminomethane, Agarose, LMP Agarose and the M13 sequencing kit were from Bethesda Research Labs (U.K) Ltd. BRL, Cambridge, U.K., The Boeringer Corporation (London) Ltd, Lewes, East Sussex or New England Biolabs, CP Labs Ltd, Bishops Stortford, Herts, U.K.

Yeast extract was from Sterlin Ltd, Teddington, U.K.

BBL trypticase peptone was from Becton Dickinson and Co, Cockeysville, M.D., U.S.A.

Bacto agar was from Difco Labs, Detroit, Michigan, U.S.A.

Caesium Chloride and Sodium Chloride were from Koch-light Ltd, Haverhill, Suffolk, U.K.

Sephadex G-10 and Ficoll 400 were from Pharmacia Fine Chemicals, Uppsala, Sweden.

Nitrocellulose filters were from Schleicher and Schuell, Postfach 4, D-3354, Dassel.

3MM paper was from Whatman Ltd., Maidstone, Kent, U.K.

Acrodisc filters were from Gelman Sciences Inc., Ann Arbor, Michigan, U.S.A.

Minisart filters and 13mm Blindwell filters were from Sartorius GmbH, Postfach 3243, D-3400 Gottingen, W.Germany.

High vacuum grease was from Dow Corning S.A., Seneffe, Belgium.

Polaroid 667 film was from Polaroid (U.K.) Ltd., St Albans, Hertfordshire.

Radiochemicals were from Amersham International p.l.c.,
Amersham, Bucks, U.K.

Murashige and Skoog (MS) medium was from Flow Labs, Irvine, Scotland.

Acetosyringone, Vanilyl alcohol, Ferulic acid and Vanillin were from Aldrich Chemicals.

Phenolic solutions were sterilized by filtration and all other solutions, with the exception of solutions used in electrophoresis and Southern blotting, were sterilized by filtration or autoclaving.

2.1.1 Bacterial strains and plasmid vectors.

All bacterial strains and plasmid vectors used during the course of this research are outlined in table 2.1.1.

2.1.2 Glassware and other equipment.

All glassware, plasticware and other equipment used in the manipulation of DNA and in the growth and maintenance of bacterial cultures, was autoclaved or filter sterilized before use.

2.1.3 Growth media and antibiotics.

The composition of media and concentrations of antibiotic used in the growth and maintenance of both *A. tumefaciens* and *E. coli* strains are listed in table 2.1.3.1 and 2.1.3.2.

Figure 2.1.1

<u>Strains</u>	<u>Remarks</u>	<u>References</u>
<u>A. tumefaciens</u>		
C58C1 (pDUB1003D31)	+ + + vir. onc. nos	285
C58C1 (pTiB6S3)	+ + + vir. onc. ocs	286
C58C1	isogenic counterpart cured of Ti-plasmid.	287
A348 (pSM30)	virB: lacZ fusion plasmid.	68
<u>E. coli</u>		
JM83	<u>ara</u> , Δ (<u>lac-proAB</u>), <u>rpsL</u> (=strA) ϕ 80, <u>lacZ</u> Δ M15.	BRL
JM101	Δ <u>lacpro</u> , <u>supE</u> , <u>thi</u> , F' <u>traD36</u> , <u>proAB</u> <u>lacI^q</u> Δ M15.	BRL
<u>Plasmids.</u>		
pUC19		267
pCHIT1251	Chitinase +ve	263
pCHIT310		263
pVK257	cosmid clone (virA, B, G, C).	288
<u>Bacteriophages.</u>		
M13mp18	multiple cloning site.	BRL
M13mp19		

Figure 2.1.3.1

L-broth

10g Tryptone
5g Yeast extract
5g NaCl
(1.5% Bacto agar)
per litre.

Chemotaxis medium

10^{-4} M EDTA pH7.0
with KOH pellets
 10^{-2} M Phosphate buffer
pH7.0
Phosphate buffer.
1M KH_2PO_4 pH with
1M KOH.

MS medium

4.7g MS salts per litre
plus 0.8% bacto agar.

MS induction medium (pH5.7)

As above plus 30g sucrose,
0.1g myoinositol, 180mg KH_2PO_4
1mg d-Biotin, 40mg X.Gal.

MinA

76mls Distilled water
20mls 5x salts
1ml 20% Glucose
0.1ml MgSO_4
(added aseptically).

MinA-Chitin.

As above plus
0.5g pure chitin.

MinA-Phenolic

MinA pH5.7 or pH7.0
plus 10^{-4} M Phenolic
and 0.04mg.ml^{-1} X.Gal.

5X MinA salts.

52.5g K_2HPO_4
22.5g KH_2PO_4
1g $(\text{NH}_4)_2\text{SO}_4$
2.5g Na Citrate. $2\text{H}_2\text{O}$
per litre.

Table 2.1.3.2

<u>Antibiotic.</u>	<u>Stock solution.</u> (mg.ml ⁻¹)	<u>Working Concⁿ</u> (ug.ml ⁻¹)
Rifampicin (Rif)	50	100
Kanamycin (Kan)	25	25/50
Chloramphenicol (Cm)	12.5	25
Ampicillin (Amp)	25	50
Carbenicillin (Cb)	50	100
Tetracycline (Tc)	2.5	10
Streptomycin (Sm)	150	20* (300+/1000++)
Spectinomycin (Sp)	50	50* (100+/200++)

2.2 Methods.

2.2.1 Chemotaxis assays.

2.2.1.1 Preparation of motile bacteria.

Motile bacteria were periodically obtained by inoculating a loopfull of a stock culture of bacteria onto the centre of an L-swarm plate (table 2.1.3.1 and figure 3.3) and allowing the colony to spread to the periphery of the plate. Motile bacteria will spread to the edge of the plate as metabolites are expended, therefore providing a suitable method for enrichment of motile populations. Bacteria from the edge of a swarm were reinoculated onto a fresh L-swarm plate and the procedure repeated at least three times before inoculating bacteria from the perimeter of the final swarm onto selective media. Single colonies of motile bacteria were taken from the master plate for chemotaxis assays.

Exponential phase cells were prepared by inoculating 200 μ l of an overnight culture of *Agrobacterium* into 10mls of L-broth (or MinA) and growing the culture at 28°C with shaking to an O.D₅₉₀ of 0.3. Stationary phase cultures were prepared by diluting approximately 1ml of an overnight culture in 4mls of chemotaxis medium (table 2.1.3.1) to give an O.D₅₉₀ of around 0.3 to 0.4.

Cultures of exponential and stationary phase cells were centrifuged at 3600g for ten minutes at 15°C and pellets washed in chemotaxis medium. After repeating the washing procedure twice, the final pellet was resuspended in up to 10mls of chemotaxis medium.

2.2.1.2 Microscopic examination.

After washing and resuspension in chemotaxis medium, motility of each strain was checked using a Nikon Optiphot microscope utilizing phase contrast optics.

2.2.1.3 The Capillary assay.

A modified version of Adler's method (129) was developed for use with *Agrobacterium*. The bacterial pool was formed by laying a U-tube (bent from a melting point capillary tube and sealed at both ends) between a microscope slide and a cover slip. For large numbers of assays the microscope slides were replaced by a glass plate (figure 2.2.1.3).

Phenolic acids were neutralized with potassium hydroxide (refer to section 3.5) and 0.1M stock solutions prepared. Water soluble phenolics were diluted in chemotaxis medium (table 2.1.3.1) to 0.1M and stocks of non-water soluble phenolics were stored dissolved in a suitable solvent, diluted to 10^{-3} M in chemotaxis medium and neutralized to pH 7.0 just prior to use. The effects of diluted solvent on chemotaxis within the peak chemotactic range of non-water soluble phenolics was checked and found to be negligible.

All phenolic compounds were filter sterilized through $0.25\mu\text{m}$ disposable filters (Gelman Sciences Inc.) prior to use and assayed within the range 10^{-3} to 10^{-9} M.

Solutions were drawn up into a plastic capillary tube and the tube sealed at one end with high vacuum grease (Dow Corning). Capillaries were handled with forceps throughout the assay and were inserted (without rinsing) open end first into the pool containing 0.3ml of bacterial suspension (section 2.2.1.1). The assay was left for 60 minutes at room temperature (refer to figure 3.4.1).

After incubation the capillary was removed and its exterior washed with a thin stream of sterile distilled water from a wash bottle. The sealed end was broken and the contents diluted in 1mM saline solution. Serial dilutions down to 10^{-5} were made and 0.1ml of each dilution spread onto L-agar plates plus appropriate antibiotic. Plates were incubated at 28°C for 48hrs and colonies counted using a colony counter (Gallenkamp).

Fig 2.2.1.3

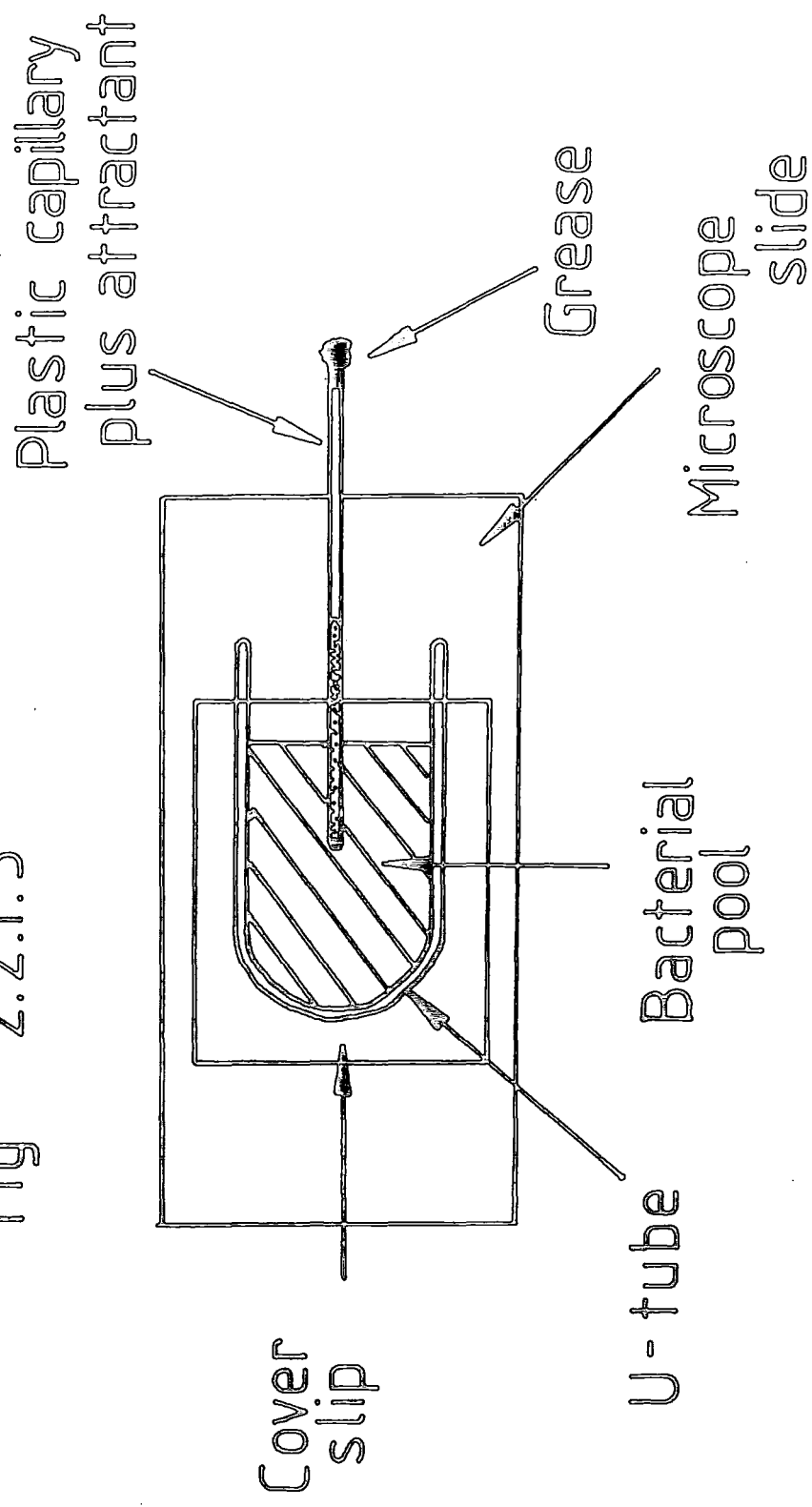

2.2.1.4 The blindwell assay.

The Blindwell assay was a modified version of that of Armitage et. al., (246). The lower chamber (refer to figure 2.2.1.4) of a blindwell chemotaxis apparatus was filled with 200 μ l of washed, motile bacteria and a 13mm diameter nitrocellulose filter (Sartorius; pore size 8 μ m) sealed in place over the bacterial suspension with a hollow, threaded teflon plug. 400 μ l of attractant was pipetted into the hollow of the teflon plug (upper chamber) and the top sealed (avoiding air bubbles) with Nescofilm (Nippon Shoji Kaisha Ltd., Osaka, Japan). The Nescofilm prevents gas production interfering with the results, maintains an aerobic environment and also prevents bacteria from being forced through the membrane when the top chamber is screwed down (246). After 90 minutes inverted at room temperature, 200 μ l of suspension was removed from the top chamber into 20mls of Isoton (Coulter Electronic) and the number of bacteria attracted into the top chamber were counted using a Coulter Counter TA11/PCA. Background counts of Isoton alone were subtracted from the values before plotting.

2.2.1.5 A comparison of the two chemotaxis methods.

The quantity used to measure the effectiveness of the chemotactic response, namely, the number of bacteria entering a capillary tube or traversing a membrane in a set incubation time, is an arbitrary value that is dependent on several factors that are, in fact, unrelated to the intrinsic cell- stimulus interaction (247). For the capillary assay, factors to take into consideration are the length and diameter of the capillary tube; and both assays will be effected by the diffusivity of the attractant and incubation time. Although both chemotaxis methods were viable in that chemotactic peaks above the control value were obtained at the same concentration for a specific phenolic compound using both methods, the numbers of replicates possible for the chemotaxis assay was limited by the plating out procedure and therefore, statistically, the results were

Fig 2.2.1.4

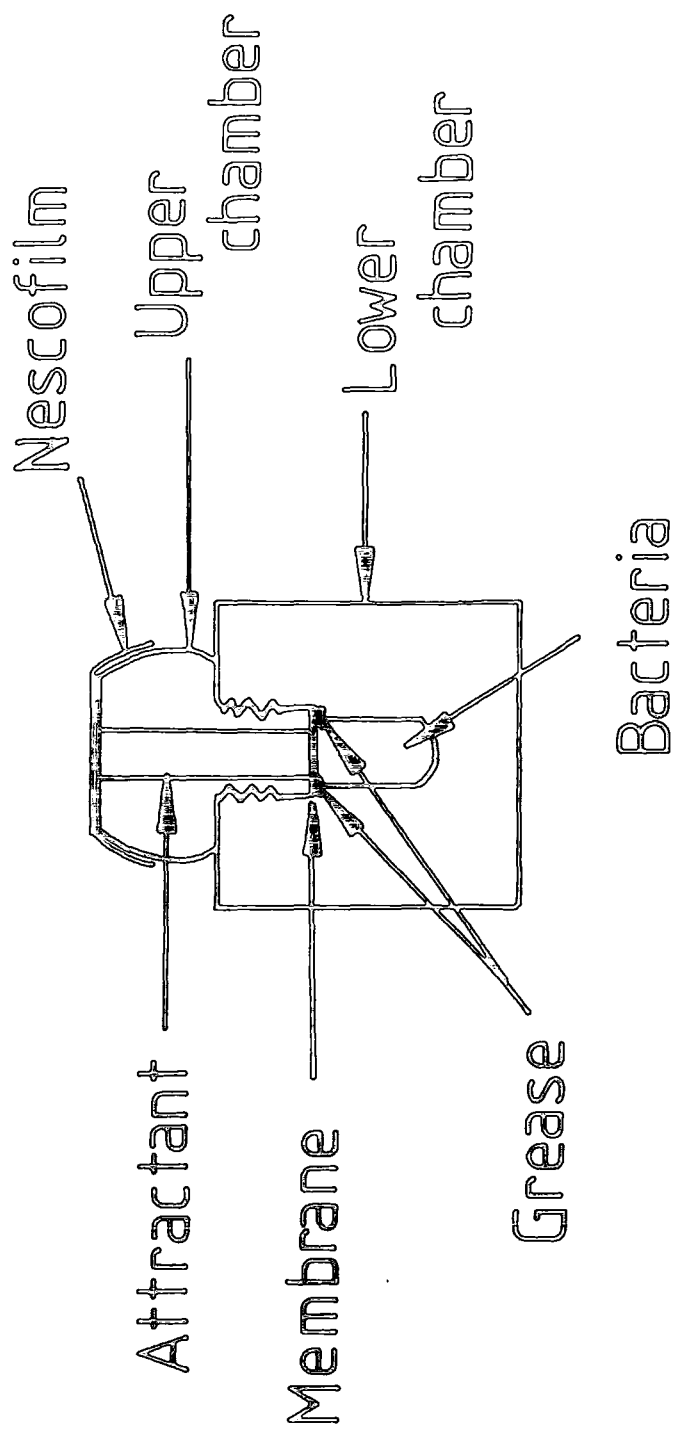

less satisfying (and therefore assays employing this technique were repeated on at least three separate occasions). Conversely, many replicates of each sample could be assayed using the Coulter counter facility and therefore results were statistically more reliable. For this reason, the majority of chemotaxis assays were performed using the blindwell chamber technique.

2.2.1.6 Preparation of plant homogenates.

2.2.1.6.1 Wheat homogenates.

Wheat seedlings were germinated on tissue paper in a moist atmosphere for 3-4 days. Germinated plantlets were embedded in Amberlite and allowed to grow for approximately 2 to 3 weeks in a growth room with continuous light.

15g wet weight of leaves and shoots were blended in a Waring blender for 2-3 minutes (on/off) with 100mls of chemotaxis medium. 6g of root material was washed in sterile distilled water and blended with 60mls of chemotaxis medium. Both root and shoot extracts were centrifuged at 9000rpm for 10 minutes and the supernatants collected. Half of each sample was autoclaved at 121°C for 20 minutes and the other half filter sterilized through a 0.4µm disposable filter (Sartorius). Protein contents were estimated at 120µg.ml⁻¹ for wheat shoot homogenate and 2µg.ml⁻¹ for root homogenates, using the Folin/Lowry assay (section 2.2.17.1).

2.2.1.6.2 Kalanchoe homogenates.

Kalanchoe plantlets were immersed in $2\% (v/v) Ca$ hypochlorite for 5 to 10 minutes and washed 4 or 5 times in sterile distilled water. Plantlets were embedded into sterile compost (John Innes No2) and allowed to grow with continuous light for several weeks.

Homogenates were prepared as for wheat (section 2.2.1.6.1) and protein contents of supernatants determined as 120µg.ml⁻¹ for shoot and 14µg.ml⁻¹ for root extracts using the Folin/Lowry method.

2.2.1.6.3 Tobacco homogenates.

Tobacco seedlings were sterilized in 10mls of 2% calcium hypochlorite in a syringe for 15 minutes. The solution was then pushed through the millipore filter, trapping seeds on the surface. Seedlings were washed 3 or 4 times with sterile distilled water and the filter wiped over the top of 1/2 MS agar (table 2.1.3.1). Seedlings were germinated in a growth room with continuous light for 3 to 4 weeks.

Roots from 120 plantlets (60mg wet weight) were crushed using sand and a grinder. 1ml of sterile chemotaxis medium was added and the solution centrifuged at 1300rpm for 5 minutes. The supernatant was split and half autoclaved and the other filter sterilized. 200mg wet weight of tobacco shoots were crushed and resuspended in 2mls of chemotaxis medium. The supernatant was treated as above. Total protein concentrations of all tobacco samples were low.

2.2.1.7 Protoplast isolation.

Protoplast isolation was by the method of Reinert and Yeoman (248). A large leaf was taken from a tobacco plant and the shoot tip sealed with wax. The leaf was sterilized using sodium hypochlorite (section 2.2.1.6.2) and the lower epidermis removed. The leaf was cut in half and one half incubated in the dark for 16hrs in CPW10 (248), and the other in CPW10 plus 0.4% cellulase and 0.1% macerozyme. The non-digested half was homogenized as described in section 2.2.1.6.1 and resuspended in chemotaxis medium to a final protein concentration of $70\mu\text{g}\cdot\text{ml}^{-1}$ (sample L). Large material was removed from the digested leaf half and the protoplast suspension centrifuged at 50g for 10 minutes. The pellet was resuspended in 10mls of CPW20 (CPW10 plus 20% sucrose, 248) and CPW10. The mixture was centrifuged at 50g for 10 minutes and the protoplast interface removed and washed twice in CPW10. After microscopic enumeration, half of the protoplasts were resuspended in chemotaxis medium and sonicated (sample P0), and the other half regenerated in To (249) for 48hrs, until cell walls were

visible by calcofluor staining, then sonicated in chemotaxis medium (sample P48). All samples were adjusted to total protein concentrations of $70\mu\text{g.ml}^{-1}$ to ensure that the relative amounts of biological material were equal.

2.2.1.8 Conjugating plasmids into *Agrobacterium* : The

Triparental mating procedure.

The method used to conjugate plasmids into *Agrobacterium* was a modified version of that of Ditta et. al., (250). The conjugate plasmid, pDUB2513 (ref. chapter 4) was conjugated into *Agrobacterium* C58C¹ using pRK2013 as helper plasmid.

Equal volumes of donor (HB101(pDUB2513) and HB101(pRK2013)) and recipient (C58C¹) cultures were mixed and $100\mu\text{l}$ inoculated onto an L-agar plate and incubated overnight at 28°C . $100\mu\text{l}$ of donor and recipient cultures were plated out as controls. 3ml of 10^{-2}M MgSO_4 was added to each plate and a suspension of bacteria obtained. This was removed to a sterile tube and serial dilutions made in 1mM saline solution. 100 , 10^{-1} and 10^{-2} dilutions of the triparental mating mixture were plated onto L-Rif.Km.Cb and numbers of donor and recipient cells in the mating mixture calculated by plating onto L.Km (HB101(pRK2013)), L.Km.Amp (HB101(pDUB2513)) and L-Rif (C58C¹). Donor and recipient strains were plated separately onto L-Rif.Km.Cb as a control measure. Plates were incubated at 28°C for 48hr and colonies counted using an electronic colony counter (GallenKamp).

2.2.1.9 The vir-induction assay.

The vir-induction assay was essentially that of Bolton et. al., (72). *Agrobacterium tumefaciens* A348(pSM30) (ref. section 2.1.1) was streaked out onto MS medium (section 2.1.3) plus 0.1mg.ml^{-1} X-gal, 1% bacto agar and $50\mu\text{M}$ phenolic (pH5.7 with potassium phosphate buffer). Plates were incubated at 28°C for 3 days and bacterial streaks checked for blueness and compared with a control

plate lacking phenolic.

2.2.1.10 The 3-Keto-lactose assay.

The method used was that of Bernaerts and De Ley (251). The test identifies 3-keto-lactose production which produces a characteristic yellow colour when reacted with Benedicts reagent (173g Trisodium Citrate, 100g Sodium Carbonate, 173g Copper Sulphate per litre). Presumptive *Agrobacterium* strains were streaked onto CaCO₃ medium (2% CaCO₃, 1.5% agar, 2% glucose and 1% yeast extract) and incubated overnight at 28°C. A loopfull of bacteria were then plated onto Lactose agar (1% lactose, 0.1% yeast extract, 2% agar) and plates incubated at 28°C for 48hrs. After this period, plates were swamped with Benedicts reagent and left at room temperature for up to 2 hours until a yellow zone could be seen around bacterial colonies.

2.2.1.11 The p-nitrophenyl- β -D-N,N'-diacetylchitobiose assay for chitinase production.

The assay used was a modified version of that of Roberts and Selitrennikoff (252). The chromogenic substrate was dissolved at 300 μ gml⁻¹ in 0.05M phosphate buffer (pH6.0) containing 0.02% (w/v) NaN₃. 200 μ l aliquots were inoculated into 0.8ml eppendorf tubes in an ice bath. Chitinase supernatants (100 μ l) were added to the tubes and incubated at 50°C for at least 6-8hrs if not overnight. After incubation 100 μ l of solution was pipetted into microtitre plates and the absorbance read at O.D₄₁₀ using a Titertek Multiscan MCC plate reader.

2.2.2 General techniques.

2.2.2.1 Storage of bacteria.

Bacterial cultures were stored on inverted agar plates sealed with Nescofilm for up to 4-6 weeks at 4°C. For long term storage single colonies were streaked out onto selective agar or inoculated into L-broth plus selection. Bacteria from

the purified streak were used to inoculate 1ml of L- broth and 1ml of 80% (v/v) glycerol added. Alternatively, 1ml of bacterial culture was directly mixed with 1ml of 80% glycerol. Cultures were stored at -80°C and phenotypes checked by antibiotic selection every 6-12 months.

2.2.2.2 Phenol:Chloroform extraction of DNA.

DNA samples were deproteinised by the addition of 1 vol. of redistilled phenol equilibrated with T.E. buffer (10mM Tris, 1mM ethylenediaminetetracetic acid (EDTA)) pH8.0. The phases were mixed by vortexing for 10 seconds and then separated by centrifugation at 13000g in a microfuge (MSE Microcentaur) for 3 minutes., or for larger samples, at 10000g in a Sorvall RC-5B centrifuge for 10 minutes. The aqueous phase was re-extracted with 1 vol. of phenol:chloroform:isoamylalcohol (25:24:1) followed by 1 vol. chloroform:isoamylalcohol (24:1) to remove excess phenol.

2.2.2.3 Precipitation of DNA with ethanol.

0.1 vol. of 3M sodium acetate and 3 vol. of ethanol were added to the DNA solution, mixed by vortexing and stored at -80°C for 20 minutes or -20°C for 60 minutes. In mini- preparations where sodium or potassium acetate was already present in the DNA solution, the sodium acetate was excluded in the ethanol precipitation step. Precipitates were collected by centrifugation at 13000g for 10 minutes in a microfuge, or at 12000g for 20 minutes at 4°C in the Sorvall RC-5B centrifuge. Pellets were washed in 80% ethanol, dried under vacuum and resuspended in sterile distilled water or T.E. buffer.

2.2.2.4 Dialysis of DNA solutions.

Dialysis tubing (Medicell International Ltd., London) was prepared by boiling for 10 minutes in 2% (w/v) sodium carbonate solution, followed by 5 washes in distilled water and boiling for 5 minutes in distilled water. The tubing was stored for several weeks at 4°C and washed well with distilled water before use.

The DNA solution was placed inside of the tubing avoiding air bubbles and each end secured with a clip. The samples were dialysed against 2 litres of T.E. buffer at 4°C with stirring for 24 hrs and the buffer changed at least 2 times.

2.2.2.5 Spectrophotometric quantitation of DNA solutions.

1/20 or 1/50 dilutions of DNA samples were read at 260 and 280nm. A pure DNA sample has an $A_{260/280}$ ratio of 1.8. An A_{260} of 1.0 is equivalent to a concentration of DNA of 1mg.ml^{-1} and therefore concentrations of DNA samples could be calculated.

2.2.2.6 Pretreatment of RNAase A.

Ribonuclease A was dissolved in water to a final concentration of 10mg.ml^{-1} and boiled at 90°C for 10 minutes to inactivate contaminating DNAase. Aliquots were stored at -80°C.

2.2.3 Enzymatic reactions used in the manipulation of DNA.

2.2.3.1 Restriction endonuclease digests.

10X stocks of restriction buffers were made as described in Maniatis (253) and table 2.2.3.1.

DNA was digested with restriction enzyme (1-2 units), 1/10 vol. 10X restriction buffer and the volume made up with distilled water. Plasmid and bacteriophage DNA's were generally incubated for at least 2 hrs at the appropriate temperature. The reaction was terminated with stop dye (ref. table 2.2.3.1).

2.2.3.2 Dephosphorylation of DNA.

Recircularization of digested plasmid DNA was minimized by removing the 5' phosphates from both ends of the linear DNA by the action of calf intestinal phosphatase.

Table 2.2.3.1

Stock solutions (μ l)	<u>Restriction enzyme buffers.</u>		
	<u>Low</u>	<u>Medium</u>	<u>High</u>
NaCl (5M)	0	100	200
Tris pH7.4 (1M)	100	100	500
MgSO ₄ (1M)	100	100	100
DTT (1M)	10	10	0
Sterile water	790	690	200

per ml

Stop dye: -

1ml 10% SDS
2mls 250mM EDTA pH8.0
0.2mls 1M Tris pH8.0
5mls Glycerol
10mg Bromophenol blue
make up to 10mls with dH₂O.

Plasmid DNA was digested to completion with excess restriction enzyme and the mixture phenol:Chloroform extracted, ethanol precipitated and resuspended in 40 μ l of T.E. buffer. 4 μ l of 10X phosphatase buffer (0.5M Tris.Cl (pH9.0), 10mMCl₂, 1mM ZnCl₂, 10mM Spermidine) and 1 μ l (10U) of calf intestinal phosphatase were added and the reaction incubated at 37°C for 30 min. 4.8 μ l of fresh 0.1M Nitrilotriacetic acid (NTA) was added and the reaction incubated at 70°C for 15 min. The mixture was phenol:Chloroform extracted, ethanol precipitated and the DNA resuspended at a final concentration of 0.1 μ g.ml⁻¹.

2.2.3.3 Phosphorylation of synthetic oligo linkers.

Prior to ligation the 5' ends of synthetic linkers were phosphorylated by the action of polynucleotide kinase. 1 μ l (approx 1 μ g), 7 μ l of double deionized water, 1 μ l 10X ligase kinase buffer (0.66M Tris.Cl pH7.6, 10mM ATP, 10mM Spermidine, 0.1M MgCl₂, 150mM DTT, 2mg.ml⁻¹ BSA) and 1 μ l (2U) of polynucleotide kinase were mixed and incubated at 37°C for 1 hour. The reaction mixture was heated to 90°C and allowed to cool slowly before an aliquot (approx 0.25 μ g of linker DNA) was removed and used in the ligation reaction.

2.2.3.4 Ligation of DNA fragments and synthetic linkers.

DNA fragments were mixed in the ratio 3:1 insert to vector and 0.1 vol. 10X ligase buffer (0.66M Tris.HCl pH7.5, 50mM MgCl₂, 50mM DTT and 10mM ATP) and 2 units of T4 DNA ligase (254) were added. The ligation cocktail was incubated at 15°C overnight. 0.5 vol. of the ligation mix was used to transform competent *E. coli* cells (section 2.2.13).

2.2.3.5 Exonuclease III and Mung Bean deletions of DNA.

Deletions of varying lengths were produced simultaneously by setting up a single reaction for Exonuclease III and removing aliquots at varying time points (255). The enzyme specifically digests DNA sequences with 5' overhangs cre-

ating a population of DNA molecules with single stranded tails. The tails are removed by the action of Mung Bean nuclease (256), which specifically degrades single stranded DNA, resulting in duplex DNA molecules with deletions. The advantage of using exonuclease III as opposed to Bal 31 for controlled deletions is that deletions can be made in one direction only by digesting with two enzymes contained within a polylinker sequence, one producing a 3' overhang and the other a 5' overhang. Since *exo* III is specific for 5' overhangs, deletions will occur in one direction only. This strategy was adopted to delete all of the downstream coding sequences from the *virB* promoter fragment.

For each time point the reaction contained 5 μ g of double digested DNA, 12.5 μ l of 2X *Exo* buffer (100mM Tris-Cl pH8.0, 10mM MgCl₂, 20 μ g.ml⁻¹ tRNA), 2.5 μ l of fresh 100mM 2- Mercaptoethanol, 1 μ l Exonuclease III (20U. μ g⁻¹) and H₂O to 25 μ l. 25 μ l of solution was removed at each time point and added to 175 μ l of Mung Bean stop buffer (40 μ l 5X Mung Bean buffer (150mM NaAc pH5.0, 250mM NaCl, 5mM ZnCl, 25% Glycerol) plus 135 μ l of water). Once all time points were collected, each sample was heated at 68°C for 15 min and then placed on ice. 15 units of Mung Bean nuclease (previously diluted with 1X Mung Bean dilution buffer (10mM NaAc pH5.0, 0.1mM ZnAc, 1mM Cystine, 0.005% Triton X-100, 50% Glycerol)) were added to each time point tube and incubated for 30 min at 30°C. 4 μ l of 20% SDS, 10 μ l 1M Tris-Cl pH9.5, 20 μ l 8M LiCl and 250 μ l of Phenol:Chloroform were added, the tubes vortexed for 1 min, centrifuged for 1 min and the upper aqueous layer removed and re-extracted with chloroform. 10ng.ml⁻¹ of tRNA and 0.5ml of cold ethanol were added, tubes chilled on ice for 10 min and centrifuged in a bench microfuge for 20 min. Pellets were washed in ethanol, dried under vacuum and resuspended in 15 μ l of T.E. buffer. 1 μ l was used in the ligation reaction, performed at 4°C overnight, incorporating BamHI linkers and 7 μ l loaded onto a 0.7% agarose gel for analysis.

2.2.4 Agarose gel electrophoresis.

Agarose was dissolved in 200mls of 1X Alecs buffer (0.04M Tris-acetate, 0.001M EDTA pH7.7 plus $3\mu\text{g}\cdot\text{ml}^{-1}$ EtBr) by heating in a microwave for 6 minutes. The percentage agarose depended on the size of DNA fragment (refer to Maniatis et. al.,(253)). The gel was poured into a horizontal 180 x 150mm perspex mould sealed to a glass plate with high vacuum grease (Dow Corning). When set, the mould was removed and the agarose gel immersed into a tank containing 1X Alecs buffer. DNA samples were loaded into wells and electrophoresed for 4-5 hrs at 100V or overnight at 30V. After electrophoresis the gels were visualized under long wave ultraviolet light (302nm) and photographed using a red filter and Polaroid 667 film.

2.2.5 DNA fragment isolation using the low melting point

(LMP) method.

DNA samples were loaded onto a LMP agarose gel and electrophoresis carried out at 30V overnight. After electrophoresis the gel was viewed under U.V light and the required fragments removed from the gel with a sterile scalpel. The agarose containing the DNA fragment was heated to 65°C and 2 vol. of 50mM Tris.HCl, 0.5mM EDTA pH8.0 were added. The solution was mixed and incubated at 37°C for a few minutes. The sample was phenol extracted (section 2.2.2.2) and ethanol precipitated (section 2.2.2.3) for 1hr at -20°C . The sample was precipitated by centrifugation and the pellet washed in 80% ethanol, dried down under vacuum and resuspended in sterile distilled water.

2.2.6 Transfer of DNA to nitrocellulose.

A modified method of Southern (257) was employed. The agarose gel was photographed (section 2.2.4) and then soaked in denaturation buffer (1.5M NaCl, 0.5M NaOH) for 1 hour with continuous shaking, rinsed in distilled water and then soaked in neutralization buffer (3M NaCl, 0.5M Tris) for 1 hour.

The gel was equilibrated in 10X SSC (1.5M NaCl, 0.15M NaCitrate pH7.0) for several minutes and then placed on top of Whatman 3MM paper previously soaked in 10X SSC and positioned on a glass plate such that the paper dipped into a reservoir of 10X SSC. A piece of nitrocellulose was soaked in distilled water and then immersed in 2X SSC for 2-3 minutes. The nitrocellulose was placed on top of the gel, avoiding air bubbles. 3 immersed sheets of 3MM were added followed by 3 dry sheets and then several layers of absorbent nappies. The apparatus was maintained in place by a glass plate and a lead weight and transfer of DNA to nitrocellulose allowed to proceed overnight.

After transfer the nitrocellulose filter was soaked in 6X SSC for 5 minutes and dried at room temperature. The filter was dried to completion in a vacuum oven at 80°C and stored between two sheets of 3MM paper until required.

2.2.7 ³²P end-labelling of DNA.

The 5' ends of a '30 mer' oligonucleotide were phosphorylated incorporating ³²P γ ATP. 1μl (1μg) of DNA was mixed with 5μl of 10X ligase kinase buffer (section 2.2.2.3), 11μl (110μCi) ³²P γ-ATP, 2μl (10-20 units) of polynucleotide kinase and brought to a final volume of 50μl with distilled water. The reaction mixture was maintained at 37°C for 45 min (covered with a lead pot). The solution was passed down a G10 sephadex column and incorporated probe separated from unincorporated ³²P γ-ATP by collecting aliquots at regular time intervals. Aliquots were checked for incorporation by diluting 10μl of each sample in scintillation fluid and counting in a scintillation counter. Samples from the first peak were pooled and approximately 5 x 10⁷ C.P.M of radioactivity added to the hybridization fluid in each bag.

2.2.8 Prehybridization and Hybridization methods.

The dried filter (ref. section 2.2.6) was soaked in 6X SSC for 2 min and placed between heat-sealable plastic. Three sides of the plastic were heat sealed

and 30mls of prehybridization fluid (6X SSC, 0.5% SDS, 5X Denharts solution (0.1% Ficoll, 0.1% Polyvinylpyrrolidone, 0.1% BSA (fraction V) added. Air was removed from the bag and the fourth side sealed. The filter was prehybridized for 2-4 hrs at 65°C in a shaking water bath. After this period the prehybridization fluid was removed and 15-20 mls of hybridization buffer (6X SSC, 0.01M EDTA, 5X Denharts solution, 0.5% SDS, 100 μ g.ml⁻¹ denatured salmon sperm DNA) added. The DNA probe was added to a final concentration of approximately 1x10⁷ C.P.M and the bag sealed avoiding air bubbles. Hybridization was overnight at 65°C.

Filter washes after hybridization varied depending on the required stringency (low salt concentrations resulting in high stringency washes). For most purposes, filters were washed at relatively low stringency in 3X SSC/0.5% SDS. Four or five washes were made at 15 min intervals in 3X SSC/ 0.5% SDS followed by three to four washes in 3X SSC alone. The filter was placed on a glass plate and covered with cling film ready for autoradiography.

2.2.9 Autoradiography.

Filters were taped to a piece of Whatman 3MM paper on a glass plate and the orientation marked with radioactive ink. The filter was covered in cling film and a pre-flashed film (Fuji RX saftey) was placed pre-flashed side down onto the filter. An intensifying screen (Dupont Lighting plus) was placed over the film followed by a glass plate and the setup held in place with bulldog clips. The plates were placed in black bags inside a light tight box and incubated at -80°C overnight. Films were developed in Phenisol developer (Kodak) and fixed in Kodafix (Kodak).

2.2.10 Preparation of plasmid DNA.

2.2.10.1 Mini-preparation.

A modified method of Birnboim and Doly (258) was used. An overnight

culture of *E. coli* was grown plus antibiotic selection and 1.5mls aliquoted into a sterile eppendorf tube. The suspension was centrifuged for 1-2 minutes in a microfuge, the supernatant removed and the tube inverted onto tissue paper. 100 μ l of ice cold solution 1 (1% glucose, 10mM EDTA pH8.0, 25mM Tris.HCl pH8.0 and 2mg.ml⁻¹ lysozyme) was added, the solution vortexed for 30 seconds and allowed to stand at room temperature for 5 minutes. 200 μ l of freshly prepared solution 2 (0.2N NaOH, 1% SDS) was added, mixed by inversion and stored on ice for 5 minutes. 150 μ l of ice cold KoAc (pH4.8) was added, the tube vortexed briefly and stored on ice for a further 5 minutes. Chromosomal DNA and other debris was pelleted by centrifugation at 13000g for 5 minutes at 4°C. The supernatant was removed to a clean tube and phenol chloroform extracted and ethanol precipitated. The pellet was washed in 70% ethanol, dried under vacuum and resuspended in T.E buffer plus DNAase free (section 2.2.2.6) RNAase at a concentration of 20 μ g.ml⁻¹.

2.2.10.2 The 50ml method.

The 50ml method enables greater yields of DNA to be obtained. The method is essentially a scaled up version of the mini-prep method (section 2.2.10.1) where samples are centrifuged using the Sorvall 8x50 rotor.

2.2.10.3 Large-scale DNA preparation.

10mls of L-broth was inoculated with a single bacterial colony and grown up overnight with selection. The 10ml inoculum was added to 1 litre of L-broth plus selection and allowed to grow up overnight. Plasmids were amplified (where applicable) once the culture had reached an O.D₆₀₀ of 0.6 with 170 μ g.ml⁻¹ of chloramphenicol. Pellets were harvested by centrifugation at 10000g for 10 minutes in 500ml Sorvall tubes using the 6x500 rotor. Supernatants were removed and pellets dried before adding 10mls of solution 1. The pellets were resuspended and left for 30 minutes at room temperature. 20mls of solution 2 was added and the mixture kept on ice for 10 minutes. 15mls of ice cold 3M sodium

acetate pH4.8 was added, mixed well and left on ice for a further 10 minutes.

Lysed cells were centrifuged in 50ml Sorvall tubes at 19000rpm for 20 minutes at 4°C and supernatants poured into clean corex tubes. An equal volume of isopropanol was added to the supernatant and the mixture allowed to precipitate for 30 minutes at room temperature. DNA pellets were obtained by centrifugation at 12000rpm (15°C) using the HB4 Sorvall rotor, washed in 70% ethanol, dried under vacuum and resuspended in T.E buffer. An exact amount of Caesium chloride was added depending on the final volume of sample (20.6g in 27mls or 29.8g in 39mls). Ethidium bromide was added (to final concentration of 120 μ g.ml⁻¹) and the solution added to a quickseal centrifuge tube (Beckman) using a syringe and needle. The tubes were balanced, heat sealed and centrifuged at 44000rpm for 17-20hrs at 15°C. After centrifugation the tube was carefully removed from the rotor and observed under U.V illumination. Usually two bands were clearly visible, the upper band corresponding to chromosomal DNA and the more highly fluorescent lower band corresponding to plasmid DNA.

The lower band was removed from the gradient and an equal volume of isopropanol saturated with CsCl was added to remove the EtBr. Once the sample was clean (bottom layer) it was dialysed against T.E. buffer (section 2.2.2.4) and an aliquot taken to check the purity and concentration of the DNA sample (section 2.2.2.5).

2.2.11 Preparation of competent cells.

This was a modification of the method of Mandel and Higa (259). 100mls of L-broth was inoculated with 1ml of an overnight culture of *E. coli* cells and incubated at 37°C with shaking until an O.D₆₀₀ of 0.3-0.4 was reached (2-3hrs). Cells were stored on ice for 10 minutes and then centrifuged at 4000g for 5 minutes at 4°C. The supernatant was discarded and the pellet resuspended in 0.5 vol. ice cold 50mM CaCl₂:10mM Tris.HCl. The cell suspension was

maintained on ice for 15 minutes and re-centrifuged as before. The pellet was resuspended in 1/15 vol. of 50mM CaCl₂: 10mM Tris.HCl, dispensed into 200μl aliquots and left on ice for at least 1 hour prior to use.

N.B Competent JM101 cells for use in M13 transformations were resuspended in 50mM CaCl₂ rather than 50mM CaCl₂: 10mM Tris.HCl.

2.2.12 Transformation of competent cells with plasmid DNA.

0.5 vol. of the ligation mix was added to 200μl of competent cells and the mixture stored on ice for 30 minutes. Controls of undigested vector, digested and religated vector and 50mM CaCl₂ were included. Cells were heat shocked for 2 minutes at 42°C, placed back on ice for 5 minutes and 1ml of L-broth added. The tube was incubated at 37°C for 1 hour to allow for expression of resistance genes. 100μl of 10⁰, 10⁻¹ and 10⁻² dilutions were plated onto selective media and incubated overnight at 37°C.

2.2.13 Construction of M13 clones for sequencing.

Standard methods (260) were employed in M13 cloning and dideoxysequencing was carried out using a BRL sequencing kit.

0.1μg of M13 vector DNA (either mp18 or mp19) was digested with the appropriate restriction enzymes and a third of the digested mixture was used in the ligation reaction. Fragments to be ligated and sequenced were first isolated using the L.M.P procedure (section 2.2.5). The ligations were maintained at 15°C overnight.

Competent cells of JM101 were prepared as described in section 2.2.11 and 5, 10 and 15μl aliquots of ligation cocktail was added to 100μl aliquots of competent cells and left on ice for 10-30 minutes. Controls of undigested vector, digested and religated vector and 50mM CaCl₂ were included. Cells were heat shocked at 42°C for 90 seconds and placed back on ice. 200μl of fresh log phase cells, 10μl of 100mM IPTG and 20μl of 10% X-Gal were added and the mixture

added to 3mls of soft agar (at 50°C). This was poured on top of an L-agar plate and when set, the plates were inverted and incubated at 37°C overnight.

Transformants were selected as a result of the formation of colourless (white) plaques, produced as a result of insertional inactivation of the β -galactosidase gene (260). White plaques were picked off directly for template preparation.

2.2.14 Preparation of single-stranded M13 DNA templates.

50ml of 2YT broth was inoculated with 100 μ l of an overnight culture of JM101 cells and 2ml aliquots added to sterile McCartney bottles. Single white plaques were picked and inoculated into each bottle and a single blue plaque was taken as a control. 1.5ml of each culture was centrifuged in a microcentrifuge for 5 minutes and the supernatants removed to a fresh eppendorf. Supernatants were re-centrifuged and 1ml aliquoted into a clean tube. 200 μ l of 20% (w/v) PEG, 2.5M NaCl were added, vortexed and left at room temperature for 20 minutes. Supernatants were centrifuged at low speed (8000rpm) in a microcentrifuge for 5 min and pellets resuspended in 100 μ l of T.E buffer. The DNA was extracted with phenol and then chloroform and ethanol precipitated with 0.1 vol. 3M sodium acetate (pH6.0) and 3 vol. ethanol at -20°C for 1hr. The DNA was pelleted by centrifugation, washed in 80% ethanol, dried under vacuum and resuspended in 20 μ l of T.E. buffer. 2 μ l samples were loaded onto a 0.7% agarose gel and electrophoresed with control M13 single stranded DNA as size standard.

2.2.15 DNA sequencing by the di-deoxynucleotide chain

termination method.

DNA was sequenced by the method of Sanger et. al. (261) using the BRL kit and manufacturers' instructions. 10mM stocks of dNTPs were diluted in double deionized distilled water to a final concentration of 0.5mM and used to prepare the nucleotide mixes (Table 2.2.16).

Figure 2.2.16

<u>dNTP</u>	G	<u>N⁰ Mixes</u>		C
		A	T	
10x Polymerase reaction buffer.	20	20	20	20
dGTP	1	20	20	20
dTTP	20	20	1	20
dCTP	20	20	20	1

Chase solution = 0.5mM dATP.

ddNTP mixes (10mM stock)

			<u>+ double deionized distilled water.</u>	<u>Final volume.</u>
ddGTP (0.5mM)	1ul		19ul	20
ddATP (0.125mM)	1ul		79ul	80
ddTTP (1.0mM)	1ul		9ul	10
ddCTP (0.5mM)	1ul		19ul	20

For the annealing reactions, 5 μ l of template DNA (section 2.2.14) was mixed with 4.5 μ l of distilled water, 2 μ l of M13 17bp primer and 1 μ l of 10X polymerase reaction buffer. The mixture was heated to 90°C for 5 min and allowed to cool slowly to room temperature.

1 μ l of 0.1M DTT, 1 μ l of ³⁵S-dATP and 1 μ l DNA polymerase (Klenow fragment, diluted in kit dilution buffer to 2U/ μ l) were added to each template/primer mix. An equal volume of the appropriate N^o and ddNTP solutions were mixed and 2 μ l aliquots added to the correct G,A,T or C tubes and the mixtures centrifuged in a microcentrifuge. 3 μ l of template DNA was added to each of the four nucleotide solutions, centrifuged and incubated at 30°C for 20 min. 1 μ l of dATP chase was added to each tube and tubes incubated for a further 15 min. 3 μ l of formamide dyes (0.1% (w/v) xylene cyanol, 0.1% (w/v) bromophenol blue, 10mM Na₂EDTA, 95% (v/v) deionized formamide) were added and samples stored at -20°C until required. Before loading, samples were heated to 90°C for 3 min and loaded directly onto DNA sequencing gels.

2.2.16 Preparation and use of polyacrylamide gels in DNA sequencing.

Two glass sequencing plates were washed and one side of each, cleaned 5-6 times with 100% ethanol and once with "repelcote" (Hopkin and Williams, Romford, U.K.). 0.4mm spacers were arranged on the larger glass plate and the smaller glass plate placed on top, ensuring that clean surfaces were innermost. The plates were taped with Whatman yellow tape.

A solution of 38% acrylamide and 2% bis-acrylamide was prepared and stored at 4°C. 20ml of this solution was added to 42g of urea and 10ml of 10X TBE buffer (121.1g Tris, 55g boric acid, 7.4g Na₂EDTA per litre) and the final volume made up to 100ml with distilled water. The acrylamide solution was degassed, 0.8ml 10% ammonium persulphate solution and 20 μ l of TEMED

(N,N,N',N'-tetramethyl-ethylene diamine) added and the mixture poured between the glass plates using a 100ml syringe. A well comb was inserted and the gel allowed to set for at least 2 hours at room temperature. (or overnight covered with cling film).

Once the gel was set the yellow tape was removed from the base of the gel and the comb removed. Gels were set up vertically in a sequencing tank with the base submerged in a reservoir of TBE buffer and the top sealed with high vacuum grease to a second reservoir of buffer. An aluminium sheet was clamped across one glass plate to aid heat dissipation and the wells were cleared of urea by flushing with buffer.

The gel was pre-electrophoresed at 50mA until the voltage reached 1500V (approximately 1-2hr). Samples were boiled and loaded in the order G,A,T,C for each template and the gel electrophoresed at 50mA (1500V) for 90 minutes (when the bromophenol blue reached the base of the gel) or 4-5hr (until 30 min after the xylene cyanol had reached the base of the gel). The gel was removed from the apparatus and the two plates separated. A sheet of Whatman 3MM paper was placed on top of the acrylamide gel and lifted. The position of samples were marked and the gel covered with polythene. The gel was dried under vacuum at 80°C for at least 3 hr. Autoradiography was as described in section 2.2.10 except that the film was placed directly in contact with the dried gel surface. 5' to 3' sequences were read directly from the autoradiograph.

2.2.17 Total protein estimations.

2.2.17.1 The Folin : Lowry method.

20 μ l of 5M NaOH and 500 μ l of solution C (2g Na₂HCO₃, 2ml 5M NaOH, 0.01% CuSO₄, 0.02% NaKtartrate per 100ml) were added to 0.1ml of protein sample and the sample maintained at room temperature for 10 min. 0.1ml Folin's reagent (50:50 with deionized water) was added, the mixture vortexed

and left for a further 30 min. Absorbances were read at $O.D_{750}$ and protein concentrations calculated from a calibration curve of BSA.

2.2.17.2 The Bio-Rad Microassay procedure.

1ml of dye reagent concentrate (Bio-Rad Laboratories, Herts, U.K) was mixed with 4ml of distilled water and 2 vol of this mixture added to protein samples in microtitre plates (Gibco, BRL). Samples were mixed and left for up to 1hr before reading in a Titertek Multiskan MCC plate reader (Flow labs) at 595nm (filter 8). Protein concentrations were calculated from a standard calibration curve for BSA.

Chapter 3
Chemotaxis in *Agrobacterium tumefaciens*

Chapter 3

Chemotaxis in *Agrobacterium tumefaciens*.

3.1 Introduction.

Certain bacteria are able to detect and respond to temporal changes in concentration of specific chemicals and then adapt to the new concentration. This phenomenon is termed chemotaxis and influences the bacterium's ability to move up a concentration gradient towards a source of attractant or away from a high concentration of repellent.

Chemotaxis in the rhizobacteria is well documented (104,186,187,188,189), however, chemotaxis in *A. tumefaciens* has only been recognized in the last three years as a result of this initial research.

A. tumefaciens is a soil phytopathogen that incites crown gall tumours on susceptible plants by transferring a small segment of DNA from its Ti-plasmid into the host genome (13). The transfer of T-DNA is tightly regulated and occurs only after prior induction of *virA* and G by plant derived phenolic compounds (68), as discussed in chapter 1. It therefore appears that bacterial : plant signalling plays an important role in the *Agrobacterium* : host interaction.

Since *Agrobacterium* was found to recognize a wide variety of plant derived phenolics as inducers of the virulence region it seemed feasible to predict that this recognition extended further, and involved a chemotactic response that resulted in the movement of virulent bacteria up a concentration gradient of plant derived metabolites to the site of cell wounding.

This chapter concentrates on the chemotactic response of *A. tumefaciens* towards plant derived phenolic compounds, as well as the response observed towards dicot and monocot homogenates. The importance of the Ti-plasmid in evoking responses to the above attractants is discussed and a biological scenario for the events occurring in the *Agrobacterium* : plant interaction is outlined.

3.2 Growth curve of *A. tumefaciens* C58C¹(pTiB6S3)

For the purpose of the chemotaxis assays it was important to determine the O.D₅₉₀ reading that corresponded to the exponential phase of growth and also to determine the viable count of bacteria at that stage.

2mls of an overnight culture of C58C¹(pTiB6S3) was inoculated into 100mls of L-Broth in a 250ml baffled flask and incubated at 28°C with shaking. Samples were removed at regular intervals for turbidity measurements to be determined. Serial dilutions of each time sample were plated onto L-agar plates and viable counts obtained. Figure 3.2 shows log₁₀ No viable cells against log₁₀ O.D₅₉₀. One could calculate that with an O.D₅₉₀ of 0.3; the cells were in exponential phase at a concentration of approximately 10⁸ml⁻¹. In view of this result, bacteria were harvested at an O.D₅₉₀ of approximately 0.3 for all chemotaxis assays involving the use of exponential phase cells.

3.3 Isolation of motile bacteria.

Motile bacteria were obtained periodically by inoculating a loopfull of stock culture into the centre of a swarm plate (L-Swarm, see materials and methods and figure 3.3). The idea being that motile bacteria will migrate to the edge of the plate as metabolite is expended, therefore providing a suitable method for the enrichment of motile populations.

At least three passages through swarm plates were made before inoculating bacteria from the perimeter of the final swarm onto selective media. Single colonies of motile bacteria were picked from the selective plate for chemotaxis assays.

3.4 Time course experiments with : a) The capillary assay and b) The blindwell assay.

A time course for the chemotactic response of *Agrobacterium tumefaciens*

Figure 3.2

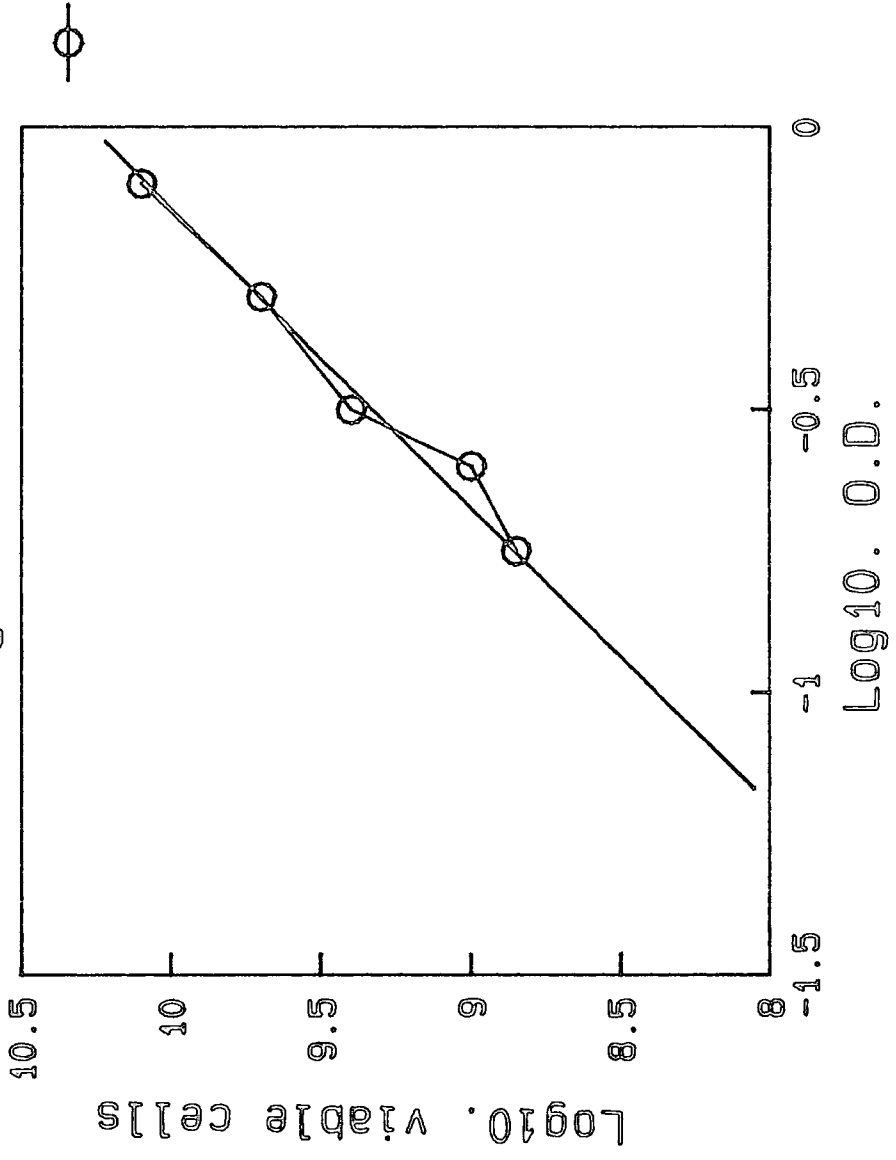
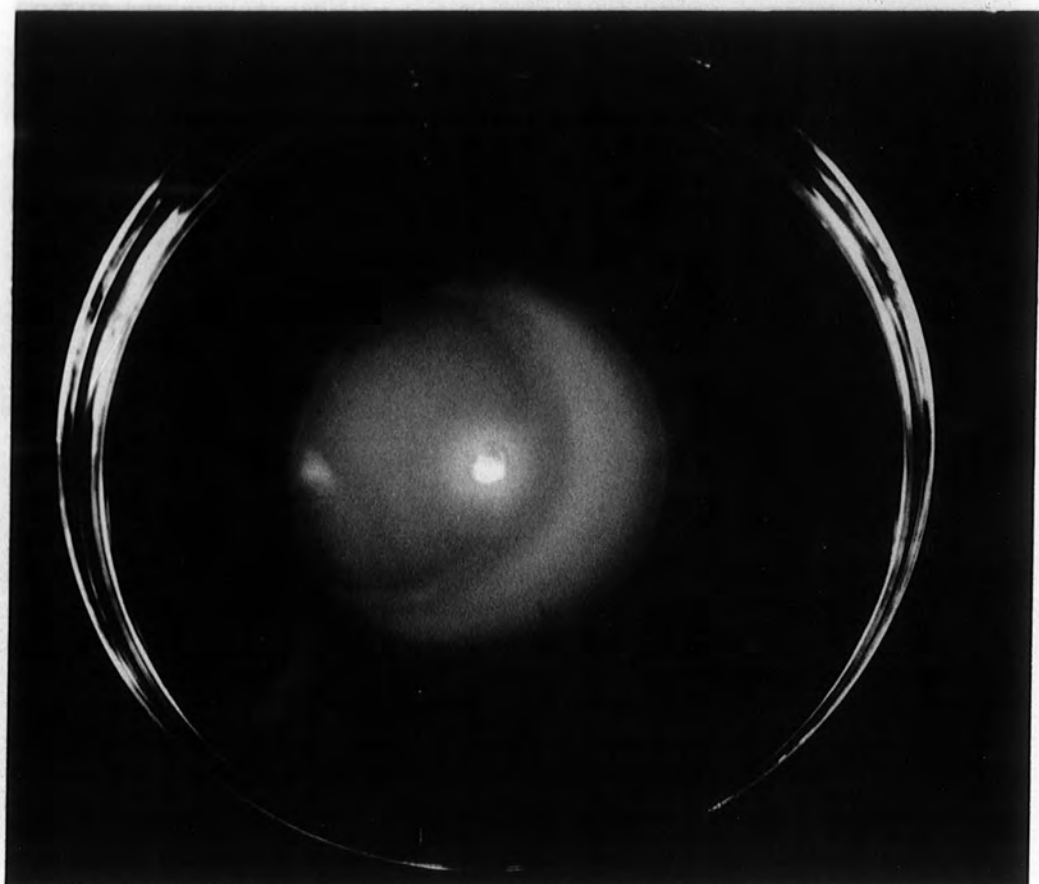

Fig 3.3



was monitored for both the capillary and the blindwell assay using L-Broth as the standard attractant. Such information enabled suitable incubation times for later chemotaxis assays to be calculated.

a) The capillary assay.

200 μ l of an overnight culture of *Agrobacterium tumefaciens* C58C¹ was inoculated into 10mls of L-Broth to give an O.D₅₉₀ of 0.05. Cells were grown to exponential phase (O.D₅₉₀ = 0.3), washed and resuspended in chemotaxis medium (see materials and methods). The assay was performed at ambient temperature for 90 minutes, removing capillaries at predetermined time points.

Figure 3.4.1 demonstrates that the maximum number of bacteria had entered the capillary by approximately 50-60 minutes in response to L-Broth. From this it was predicted that an incubation time of 60 minutes was applicable for the capillary assay.

b) The blindwell assay.

A motile culture of *Agrobacterium tumefaciens* C58C¹ was prepared as above. Motile bacteria were inoculated into one chamber of the blindwell apparatus and L-Broth into the other (see chapter 2). Samples were removed at predetermined time points.

Figure 3.4.2 demonstrates that a maximum response is observed after 90-100 minutes at room temperature (25°C). All chemotaxis assays employing this technique were incubated for at least 90 minutes at room temperature. The higher incubation time for a maximum response with this assay was probably due to the fact that bacteria were impeded by the pores of a nitrocellulose membrane.

3.5 Neutralization of phenolic acids.

It was of utmost importance to ensure that the pH of the assay system

Figure 3.4.1

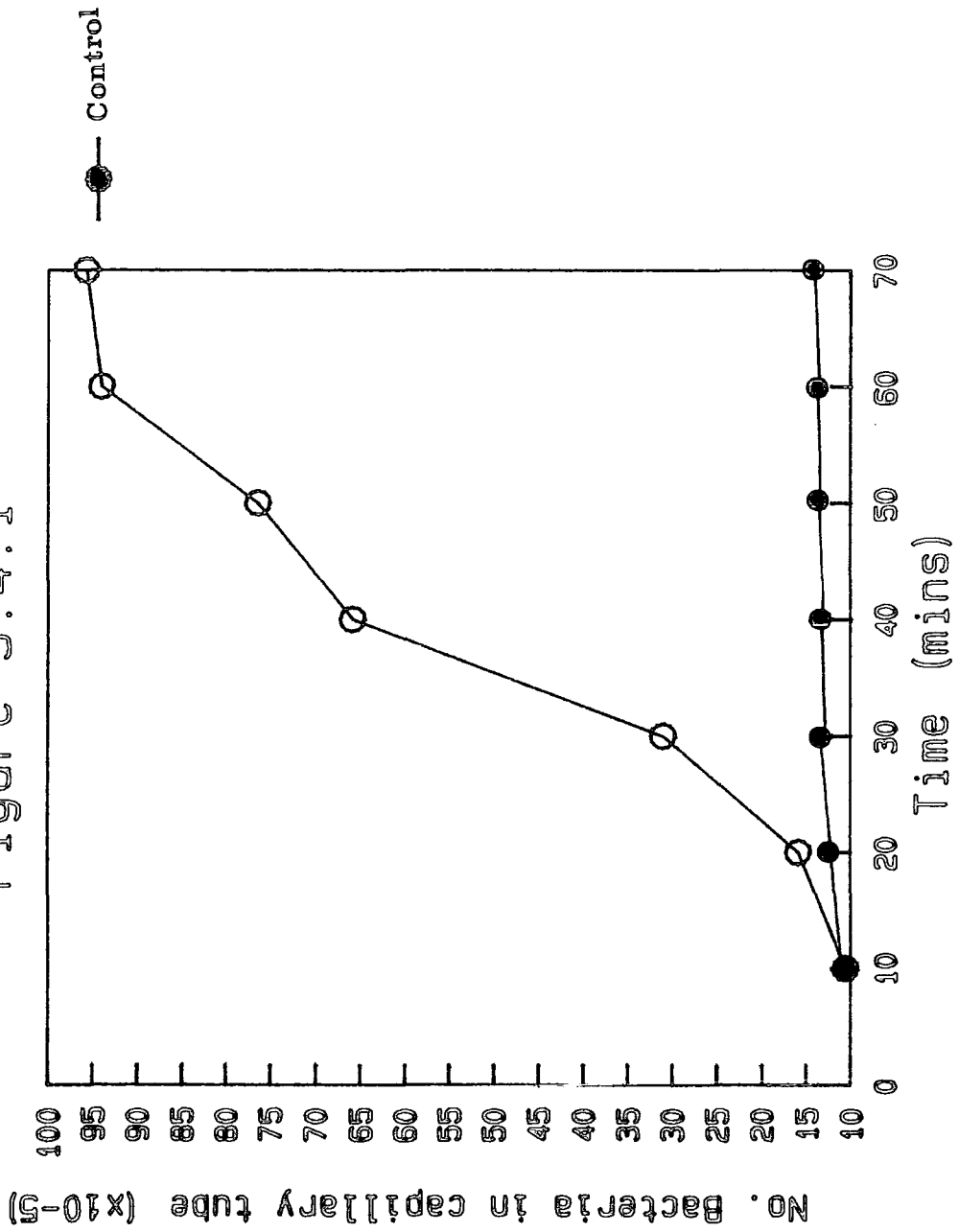
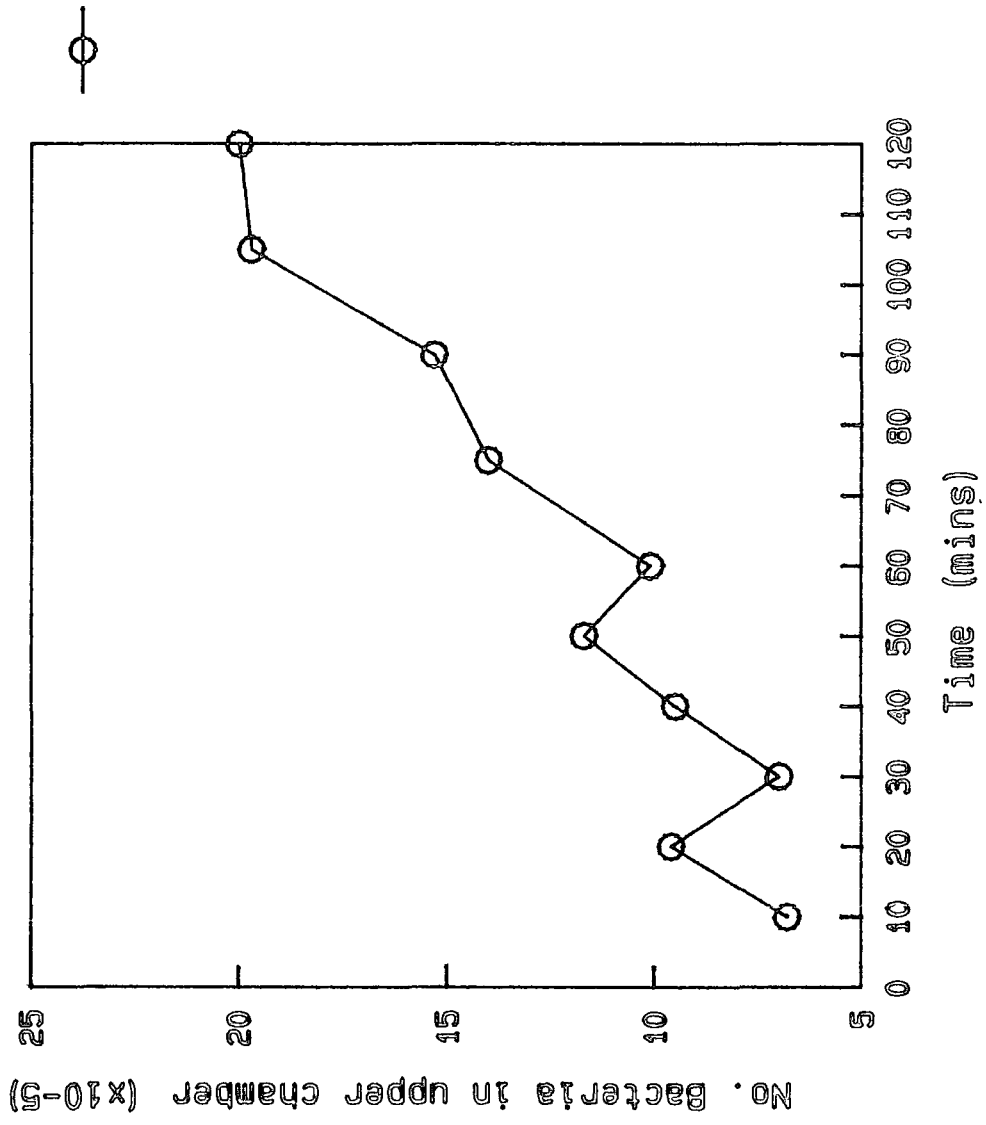

Figure 3.4.2



remained constant at pH 7.0 as fluctuations away from this value may have resulted in chemotactic responses evoked by H⁺ ions rather than true attraction towards phenolics. Such a response could mask an attraction towards a phenolic compound, or indeed give a false indication that a phenolic compound was a chemoattractant, particularly in the case of phenolic compounds that give a chemotactic optimum at high concentrations. Thus it was important to neutralize phenolic acid solutions. Before neutralization with NaOH, chemotaxis towards Na⁺ ions was analysed.

3.5.1 Chemotaxis towards sodium chloride.

Motile *A. tumefaciens* C58C¹ and C58C¹(pDUB1003Δ31) were grown to exponential phase in MinA plus glucose (as described in materials and methods), washed and resuspended in chemotaxis medium. Chemotactic assays were performed in quadruplicate employing the blindwell chamber technique.

Results clearly demonstrate that both strains respond to NaCl at a concentration of 10⁻³M indicating an enhanced cell motility or chemotaxis towards either Na⁺ or Cl⁻ ions at this concentration (figure 3.5.1). In order to determine which of the two ions was responsible, chemotaxis of C58C¹(pDUB1003Δ31) towards KCl was assessed. Since chemotaxis medium consists of 10⁻²M KPO₄ and 10⁻⁴M K₂EDTA, any effects at 10⁻³M for K⁺ ions would be saturated, therefore a response with KCl would be indicative of attraction towards Cl⁻ ions only. No response was observed towards KCl (figure 3.5.1), confirming that the initial response observed with NaCl was a result of attraction towards Na⁺ ions. For this reason, all phenolic acids were neutralized with KOH.

3.6 Chemotaxis towards phenolic compounds.

3.6.1 Introduction.

Lignin is an abundant polymer and constitutes a large percentage of the plant cell wall. It is synthesized by the plant and forms an intricate network

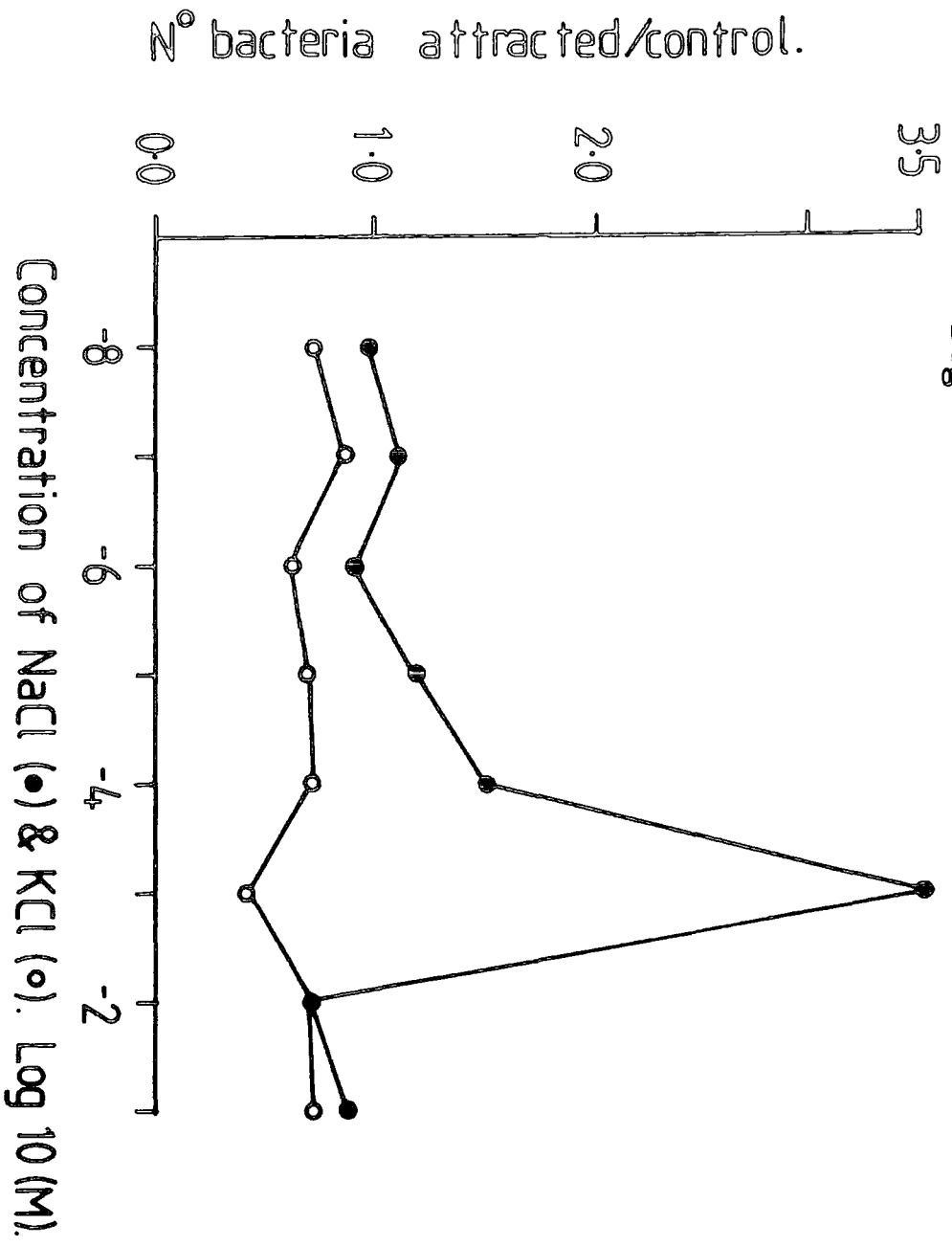

Fig 3.5.1

around cellulose microfibrils, enhancing the strength of the cell wall.

Lignin is synthesized from phenylpropanoid monomers by the action of peroxidase (237) and linked by an array of different bonds, eventually making up the three dimensional structure. There are two forms of lignin, namely, the hardwood or syringyl lignin and the softwood or Guaiacyl lignin.

On wounding a plant cell exudes a conglomerate of aliphatic and aromatic compounds, some of which include breakdown products and biosynthetic precursors of the cell wall polymer, lignin. Stachel *et. al.* (71) and Bolton *et. al.*(72) have demonstrated that plant derived phenolic compounds such as acetosyringone and sinnapinic acid are inducers of the Ti-plasmid virulence region, and more recently De Cleene (12) outlined the importance of phenolic compounds on the susceptibility of plants to *Agrobacterium tumefaciens*. The presence of compounds termed oligosaccharines (238) have been found to increase the levels of acetosyringone present in leaf discs (A. Darvill, personal communication) and the production of acetosyringone by the plant cell has been found to involve an active process (M. Van Montagu, personal communication), emphasising that the recognition system has evolved to guide agrobacteria towards susceptible plants rather than to dying cells.



In view of accumulating evidence for the importance of phenolic compounds in the *Agrobacterium* : plant interaction, the role of phenolic compounds in chemotaxis was analysed.

12 phenolic compounds of related structure were analysed for their ability to act as chemoattractants for *Agrobacterium tumefaciens* C58C¹ and as inducers of the Ti- plasmid virulence operons. The results divided the phenolics into four groups (see table 3.6) and each will be discussed in turn.

3.6.2 Group 1 phenolics.

The first category of phenolics were compounds that were strong to moder-

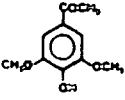
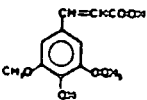
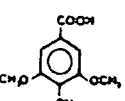
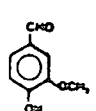
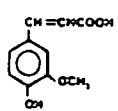
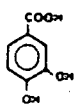
Table 3.6

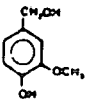
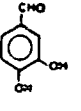
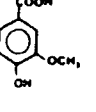
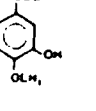
<u>Plant Phenolic</u>	<u>Structure</u>	<u>Vir-inducer</u>	<u>Chemotaxis</u>	<u>Peak Conc^a</u>	<u>TA plasmid required</u>
Acetoxyringone		+ ^a	+	10 ⁻⁷	+
Sinapinic acid		+ ^a	+	10 ⁻⁷	+
Syringic acid		+ ^a	+	10 ⁻⁷	+
Vanillin		+ ^b	+	10 ⁻⁴	+
Ferulic acid		+ ^c	+	10 ⁻⁴	+
3,4 dihydroxy - benzoic acid		+ ^b	+	10 ⁻²	+
Catechol		+ ^b	+	10 ⁻²	-
p-hydroxy benzoic acid		+ ^b	+	10 ⁻³	-
Vanillyl alcohol		- ^c	+	10 ⁻²	-
3,4 dihydroxy - benzaldehyde		- ^c	+	10 ⁻²	-
Vanillic acid		- ^b	-	NC	NC
Isovanillic acid		- ^c	-	NC	NC

ate inducers of the Ti-plasmid virulence operons (as determined using the induction assay (materials and methods) and as demonstrated by Stachel *et. al.* (71), and Bolton *et. al.* (72), and were chemoattractants for Ti-plasmid harbouring strains only. These include; acetosyringone (figure 3.6.2.1) giving a chemotactic optimum of 10^{-7} M (104), sinapinic acid (figure 3.6.2.2a) at 10^{-7} M (239), syringic acid (figure 3.6.2.2b) at 10^{-7} M (239), ferulic acid (figure 3.6.2.3a) at 10^{-4} M (239), vanillin (figure 3.6.2.3b) at 10^{-4} M (239) and 3,4-dihydroxybenzoic acid (figure 3.6.2.4) at 10^{-2} M.

3.6.3 Group 2 phenolics.

Within the second category were phenolic compounds that were moderate inducers of the virulence region and were chemoattractants for both Ti-plasmid harbouring strains and Ti-plasmid lacking strains of *Agrobacterium*. These include catechol (figure 3.6.3.1a) with a chemotactic optimum of 10^{-2} M and p-hydroxybenzoic acid (figure 3.6.3.1b) at 10^{-3} M.

3.6.4 Group 3 phenolics.

Within the third category of phenolic compounds were the weak or non inducers of the virulence region. Such compounds were chemoattractants for both cured and Ti-plasmid harbouring strains and included vanillyl alcohol (figure 3.6.4.1a) with a chemotactic optimum of 10^{-2} M (104) and 3,4- dihydroxy benzaldehyde (figure 3.6.4.1b) with an optimum at 10^{-2} M.

3.6.5 Group 4 phenolics.

The fourth category of phenolic compounds were those that could neither induce the virulence region nor act as chemoattractants for *Agrobacterium*. These include vanillic acid and isovanillic acid (figure 3.6.5).

The results indicate that there is strong correlation between the *vir* inducing ability of a phenolic compound and its requirement for a Ti-plasmid encoded function for chemotaxis.

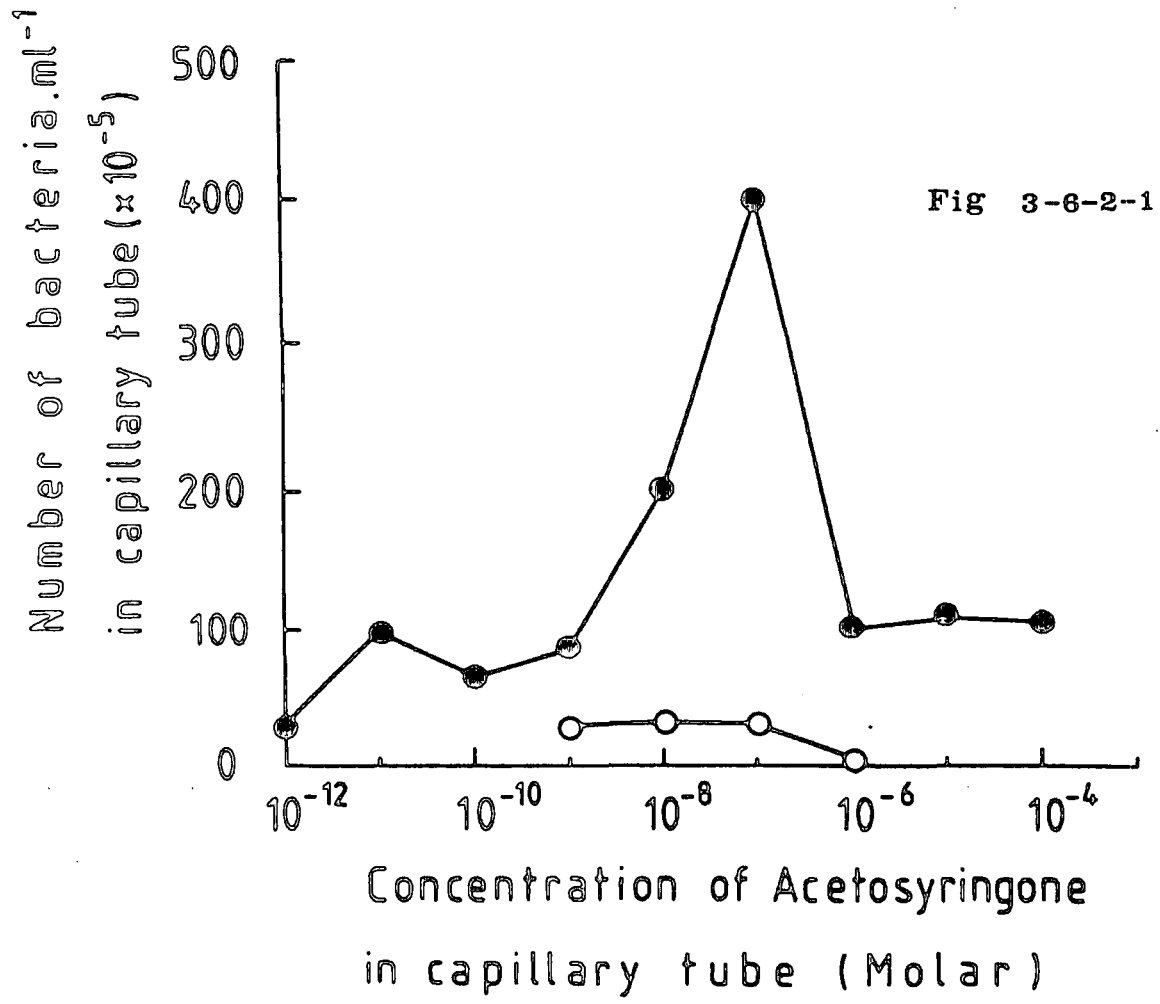

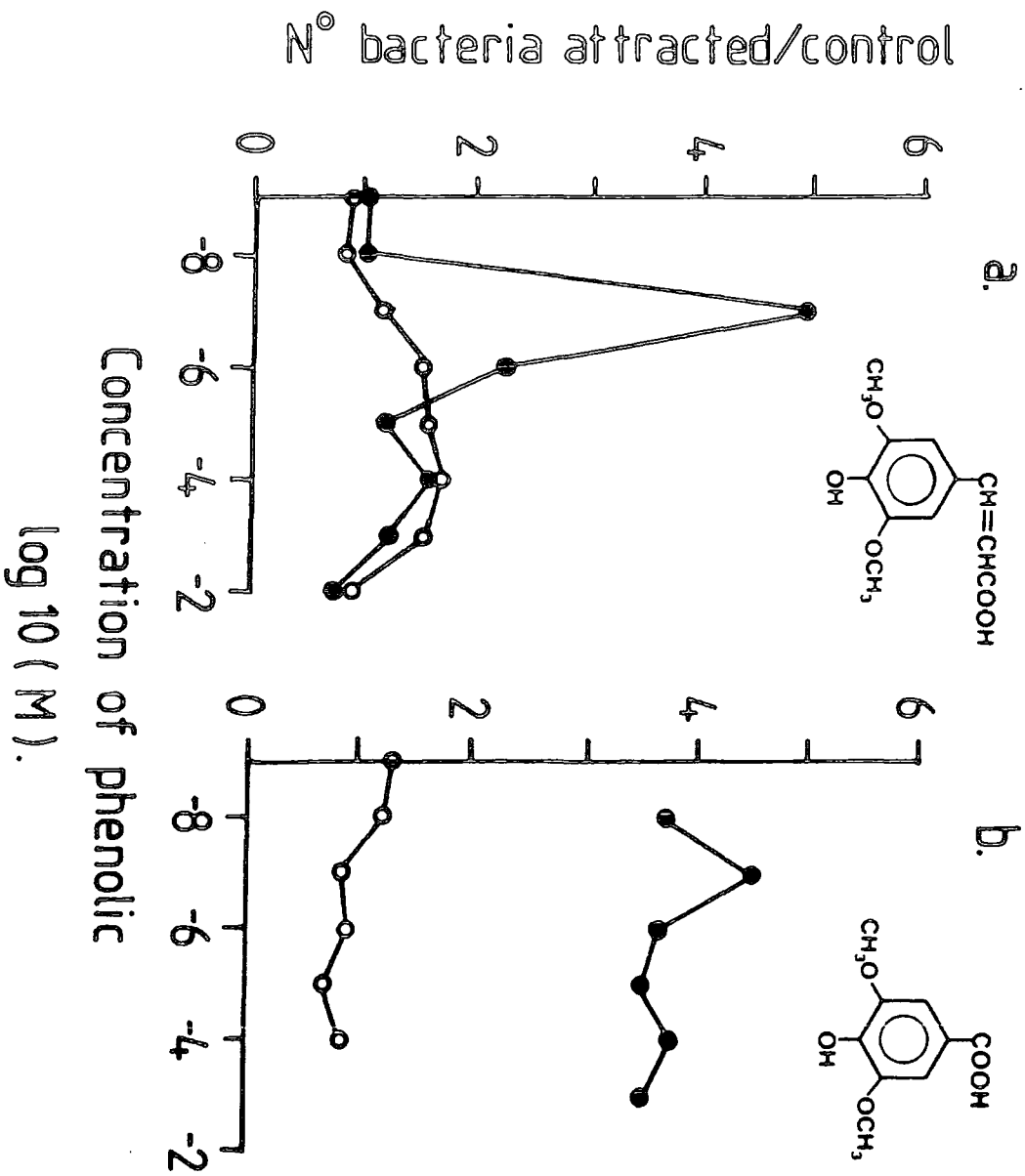

N° bacteria attracted/control

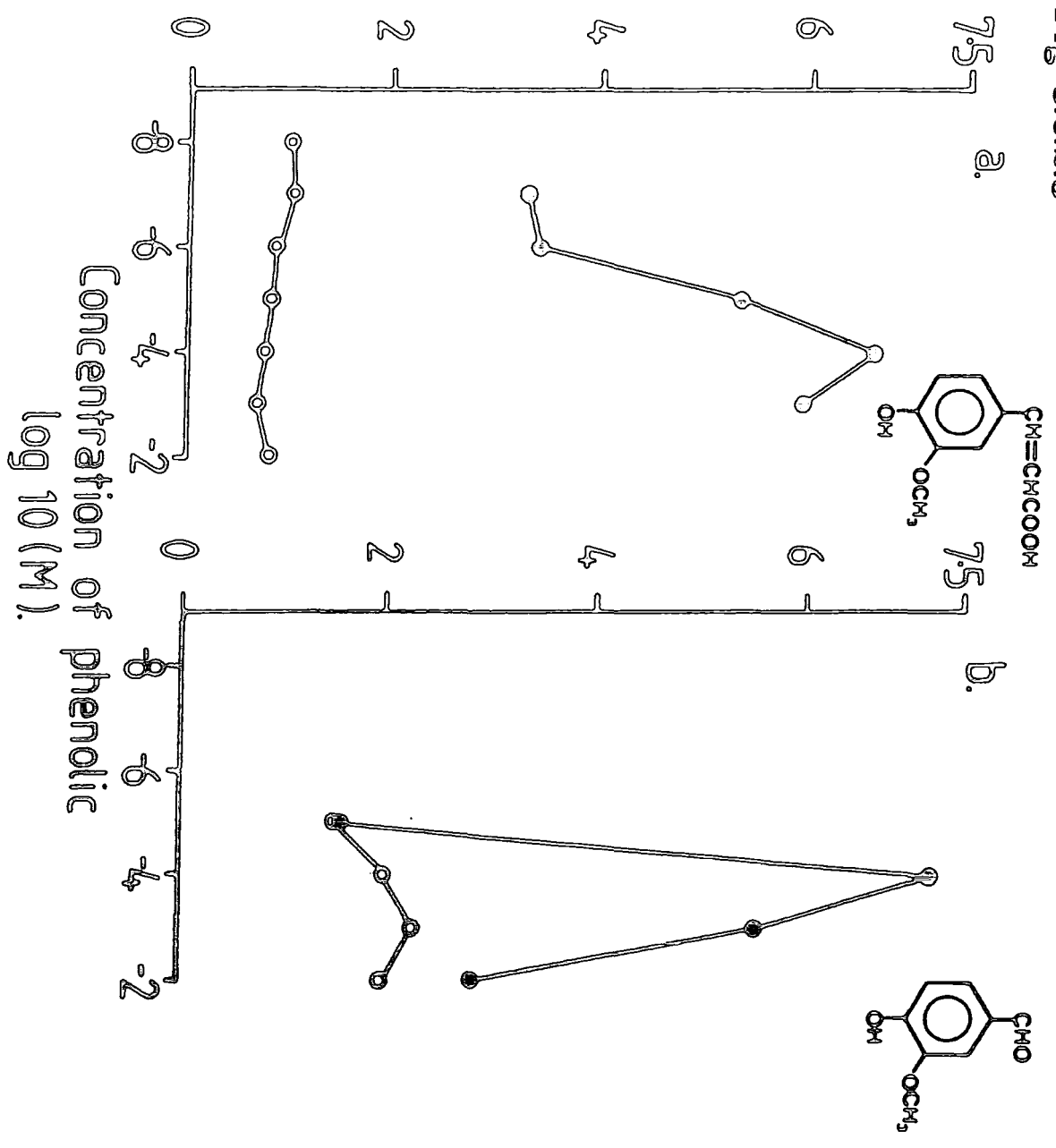
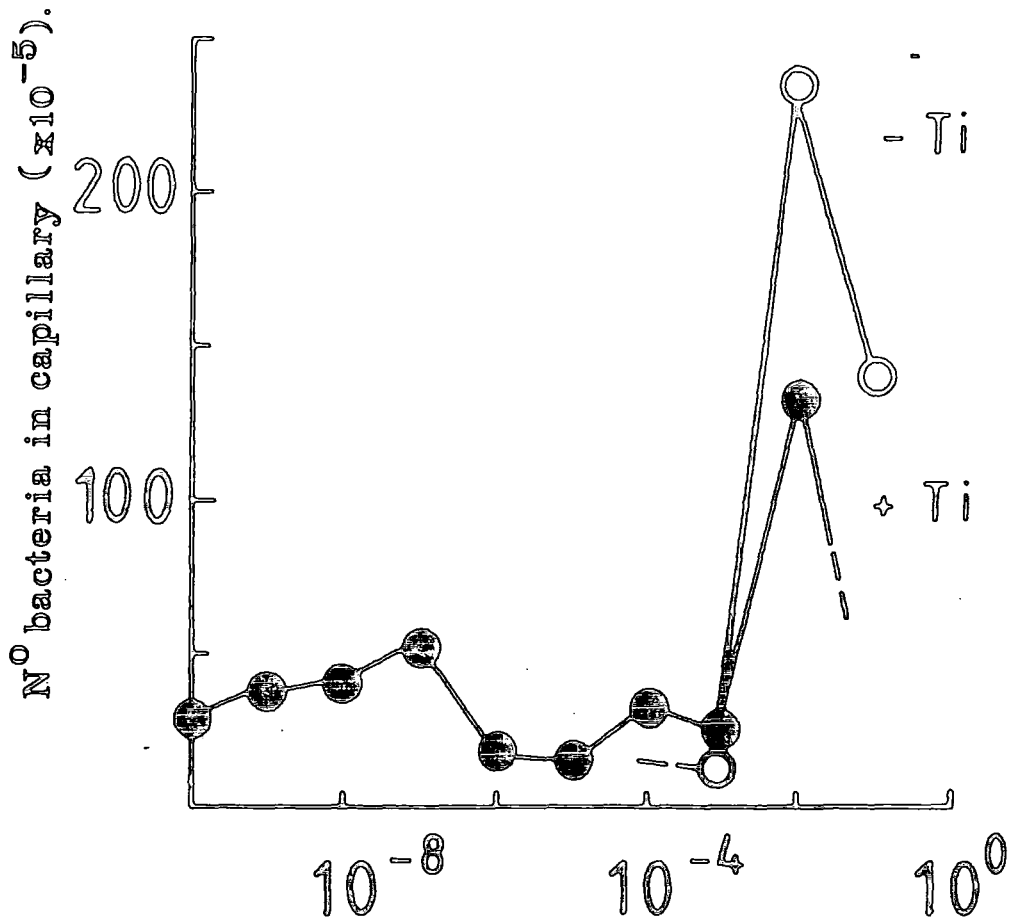

Fig 3.6.2.4



CONC^N of 3-4 dihydroxy - benzoic acid

(Molar)

Figure 3.6.3.1

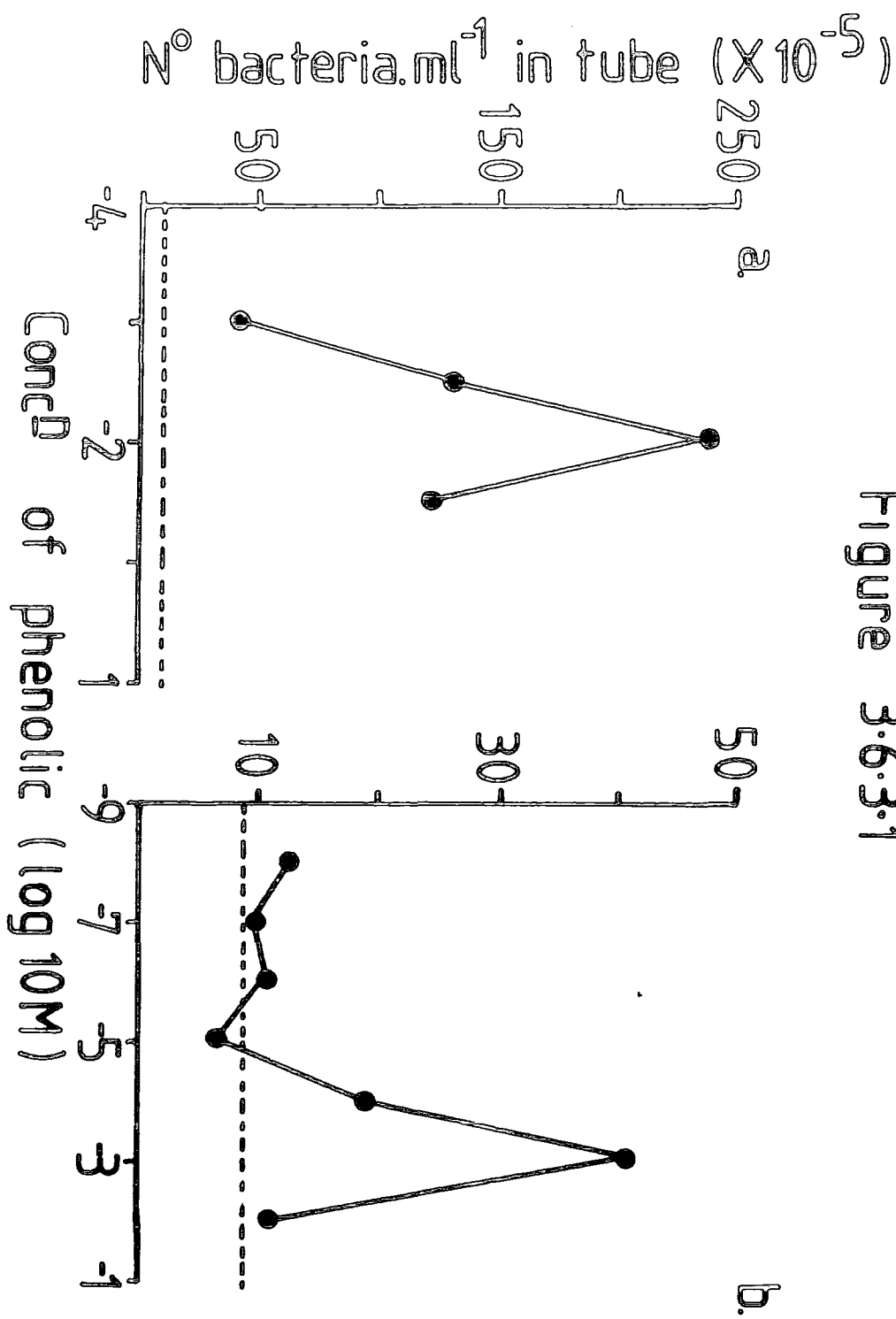

Fig. 3-6-4-1

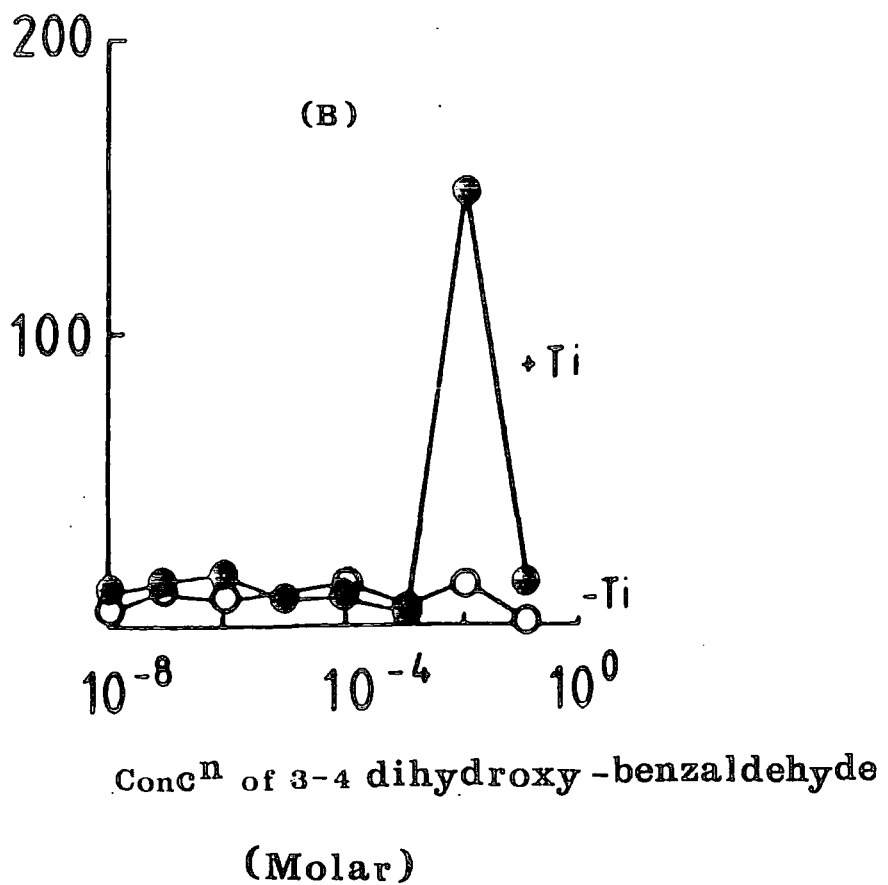
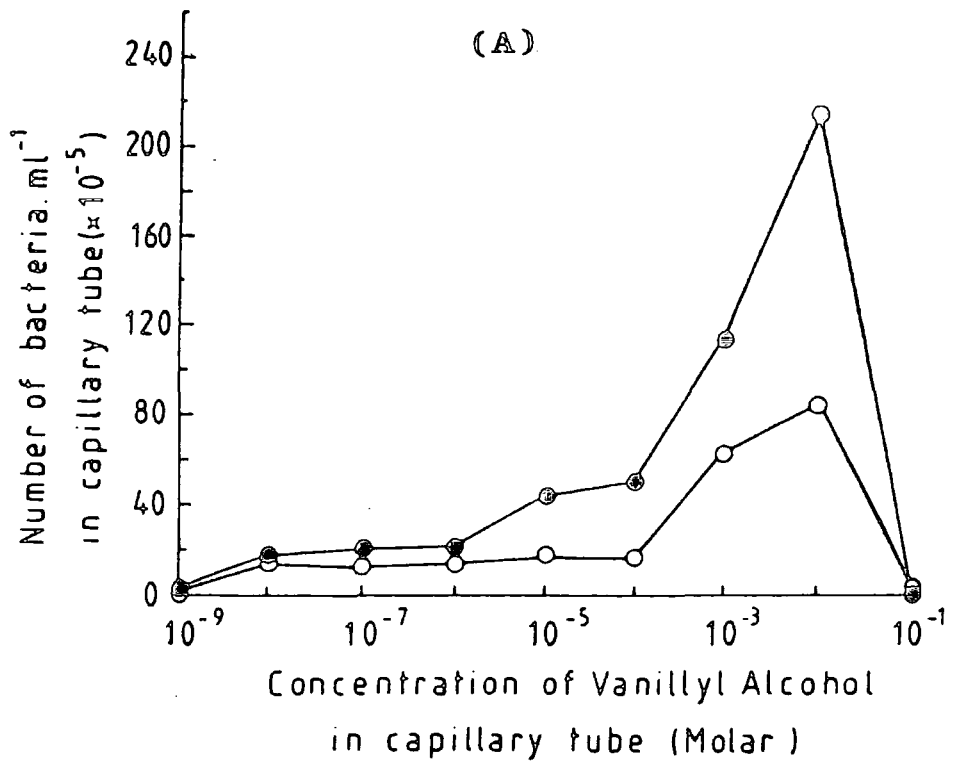
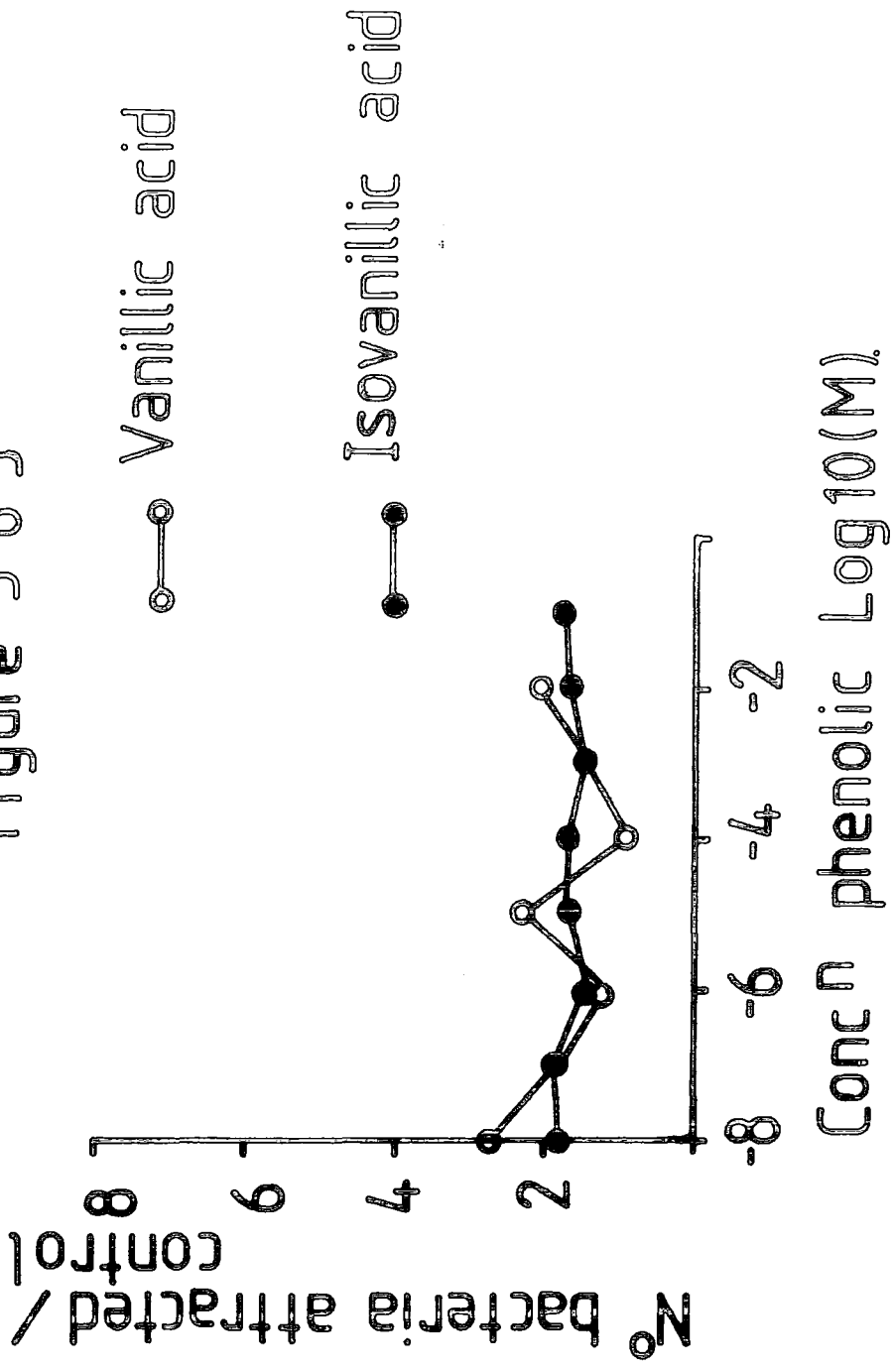

Figure 3.6.5



3.6.6 Chemotaxis towards natural monocot and dicot

homogenates.

3.6.6.1 Introduction.

A. tumefaciens C58C¹ possesses a highly sensitive chemotaxis system which responds to a whole range of plant derived sugars, amino acids (171), and as demonstrated in the last section, a range of phenolic compounds (104,239). It seems feasible to suggest that it is the exudation of these compounds from the plant that accounts for the bacterium's prevalence in the environment of the rhizosphere (10). For this reason, chemotaxis towards natural extracts was investigated.

3.6.6.2 Chemotaxis of C58C¹(pDUB1003Δ31) towards tobacco and wheat homogenates.

Shoot and root homogenates of tobacco SR1, *Kalanchoe* and wheat were prepared as described in the materials and methods. Half of each extract was filter sterilized and the other half autoclaved to check for the presence of heat labile chemotactic components.

Both exponential and stationary phase cultures of *Agrobacterium tumefaciens* C58C¹(pDUB1003Δ31) were grown in L-broth and washed in chemotaxis medium and all experiments were performed using the capillary assay.

3.6.6.3 Chemotaxis towards tobacco homogenates.

Three experiments were performed in duplicate for both exponential and stationary phase cells towards both autoclaved root and shoot extract and filter sterilized root and shoot extract (figure 3.6.6.3). The amounts of total protein in tobacco homogenates was lower than that of *Kalanchoe* and wheat since less shoot and root material was originally prepared, however chemotaxis towards both root and shoot extracts was observed. Chemotaxis towards shoot extract

N° bacteria in capillary ml⁻¹
($\times 10^{-6}$)

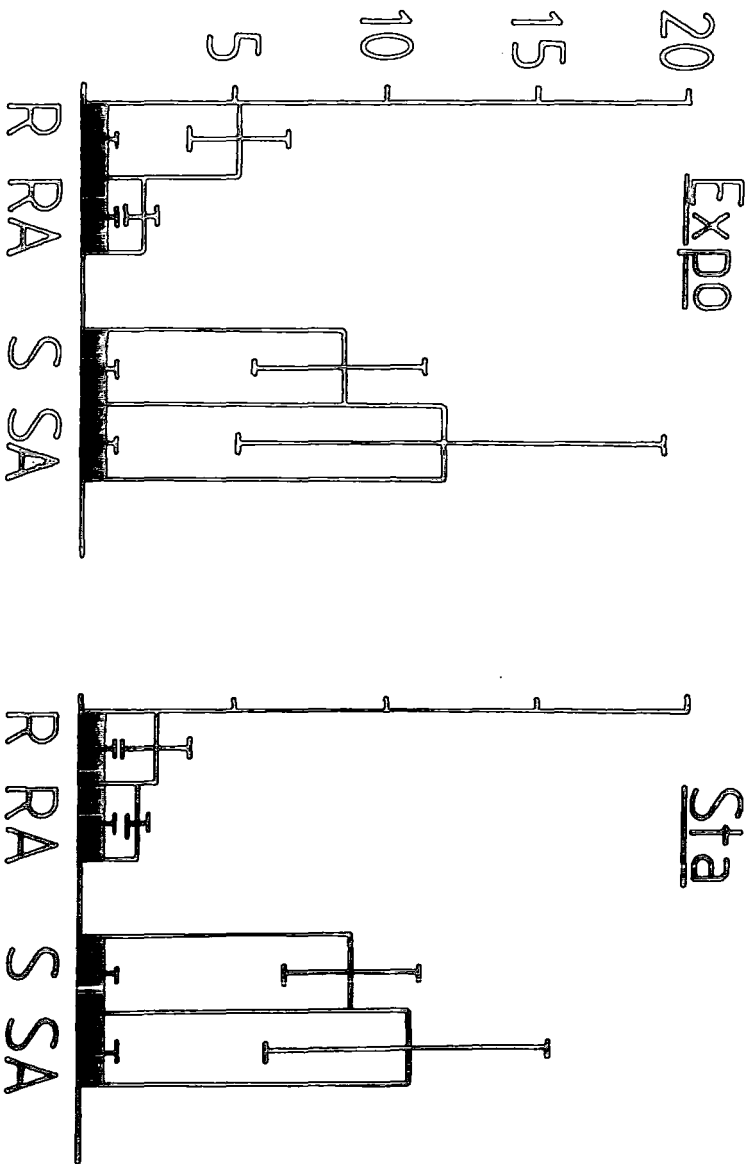

Fig 3.6.6.3

was comparable for both exponential phase cells and stationary phase cells and there was no appreciable difference in chemotactic response towards autoclaved and filter sterilized extracts. Chemotaxis towards tobacco root extracts was less obvious with a response being evident only for filter sterilized extract with exponentially grown cells (figure 3.6.6.3).

3.6.6.4 Chemotaxis towards wheat homogenates.

The overall response towards wheat homogenates was considerably greater than that observed with tobacco homogenates since the total amount of root and shoot material was greater and therefore the total protein concentration was greater. Chemotaxis towards wheat shoot homogenate was roughly comparable for both exponential and stationary phase cells (figure 3.6.6.4) for both autoclaved and filter sterilized extracts. However, there appeared to be a significant decline in chemotactic response of stationary phase cells towards autoclaved extract that was not observed in the case of exponentially grown bacteria. Chemotaxis towards wheat root extracts followed a similar pattern; the response towards filter sterilized extract being roughly of the same order of magnitude with both exponential and stationary phase cells, the same applying to root extract. However, again there seemed to be a significant decline in chemotactic response of stationary phase cells that was not observed with exponential phase cells. All responses were compared with a control consisting of chemotaxis medium only.

3.7 Ti-plasmid involvement in chemotaxis towards wheat and *Kalanchoe* shoot extracts.

It was important to establish the role played by the Ti-plasmid in chemotactic responses towards both dicotyledonous and monocotyledonous homogenates and for this reason both wheat and *Kalanchoe* shoot extract were analysed using C58C¹(pDUB1003 Δ 31) and its isogenic counterpart C58C¹, which lacks a

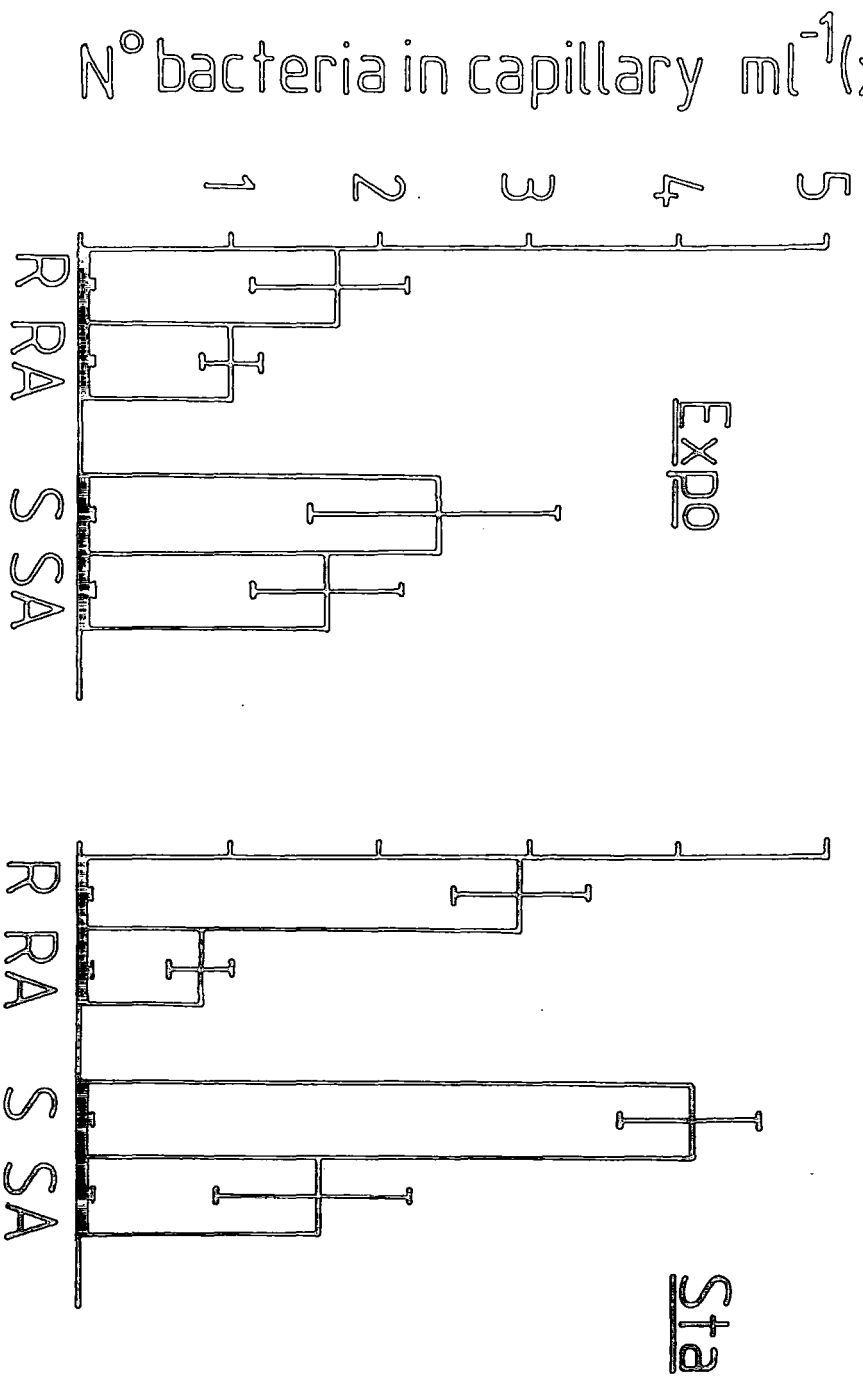

Fig 3.6.6.4

Ti-plasmid.

a) Chemotaxis towards concentrated shoot extracts.

Both *Kalanchoe* and Wheat shoot homogenates were prepared using equal amounts of leaf and stem material and the total protein contents of both samples was $120\mu\text{gml}^{-1}$. The concentrated extracts were assayed as chemoattractants for both the Ti-plasmid harbouring strain and the Ti-plasmid lacking strain of *A. tumefaciens* (figure 3.7.1). The results clearly demonstrated that there was no appreciable difference between chemotactic responses of the cured and Ti-plasmid harbouring strains.

b) Chemotaxis towards diluted shoot extracts.

The effects of diluting both *Kalanchoe* and wheat shoot extract through the concentration range $120\mu\text{gml}^{-1}$ to $10\mu\text{gml}^{-1}$ total protein, and assaying them as chemoattractants for mixed (1:1) populations of cured and Ti-plasmid harbouring strains was analysed (figure 3.7.2 and 3.7.3). Shoot extracts were diluted in chemotaxis medium to total protein concentrations of 120, 60, 50, 40, 30, 20 and $10\mu\text{gml}^{-1}$. Overnight cultures of *A. tumefaciens* C58C¹ and C58C¹(pDUB1003 Δ 31) were diluted in chemotaxis medium to an O.D₅₉₀ = 0.34. Both cultures were washed in chemotaxis medium and mixed in a 1:1 ratio just prior to performing the assay.

Figures 3.7.2 and 3.7.3 clearly demonstrate that a distinct enhancement of chemotaxis was conferred by the Ti- plasmid at low concentrations of *Kalanchoe* and wheat shoot extract. A two-fold dilution of the extract resulted in equivalent attraction of both strains, however, increasing the dilution factor resulted in increased attraction by the Ti-plasmid harbouring strain relative to the cured strain. It was observed that a maximum enhancement of 2:1, Ti- plasmid harbouring relative to cured strain was achieved at $30\mu\text{gml}^{-1}$ of wheat shoot extract (figure 3.7.2) and 1.75:1 for *Kalanchoe* shoot extract (fig-

Figure 3.7.1

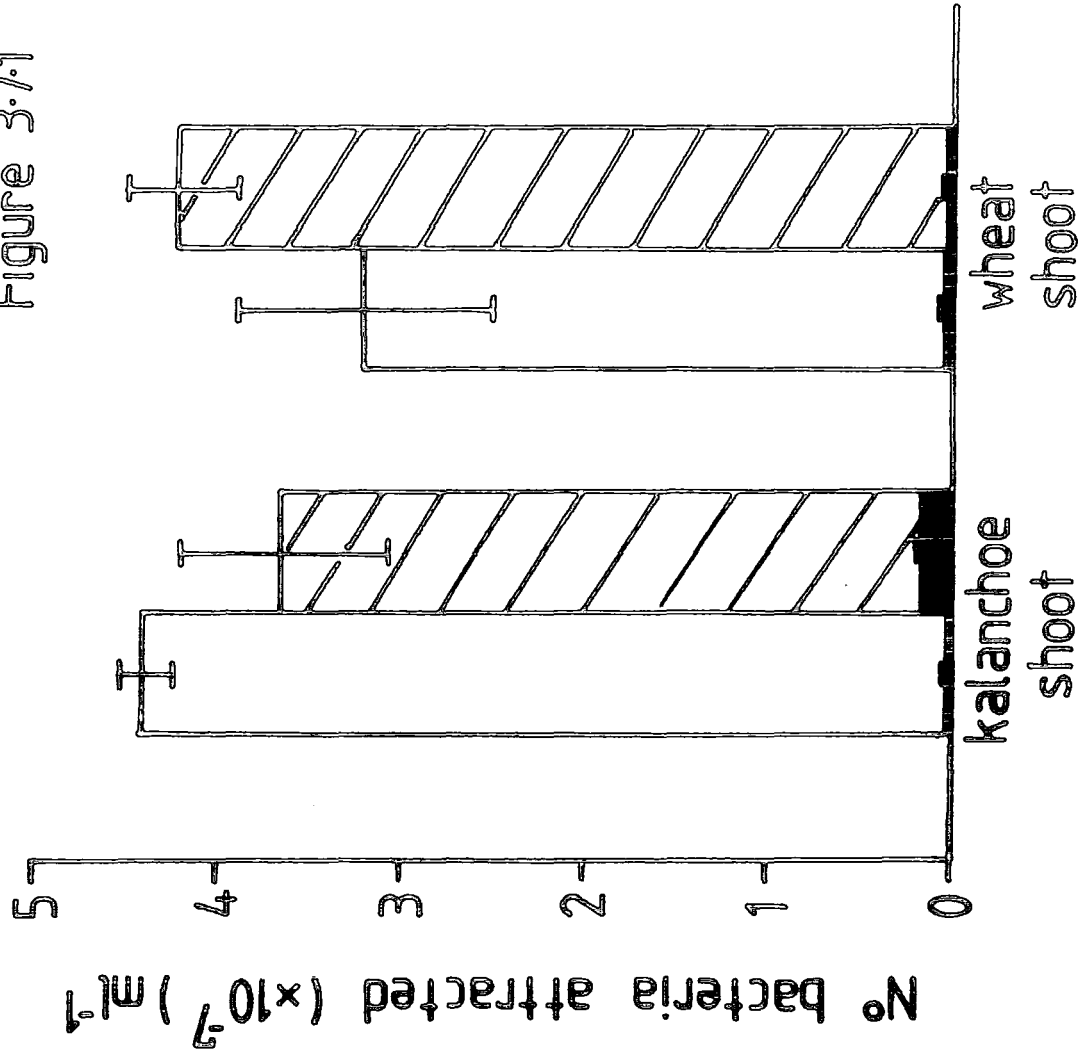

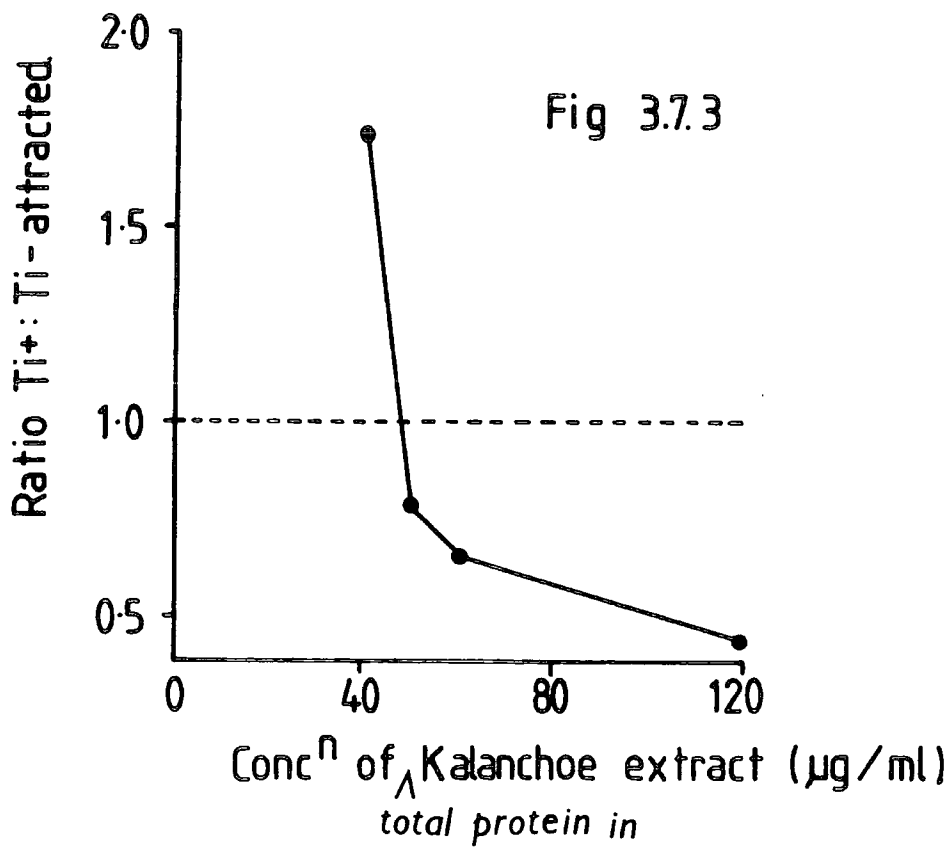
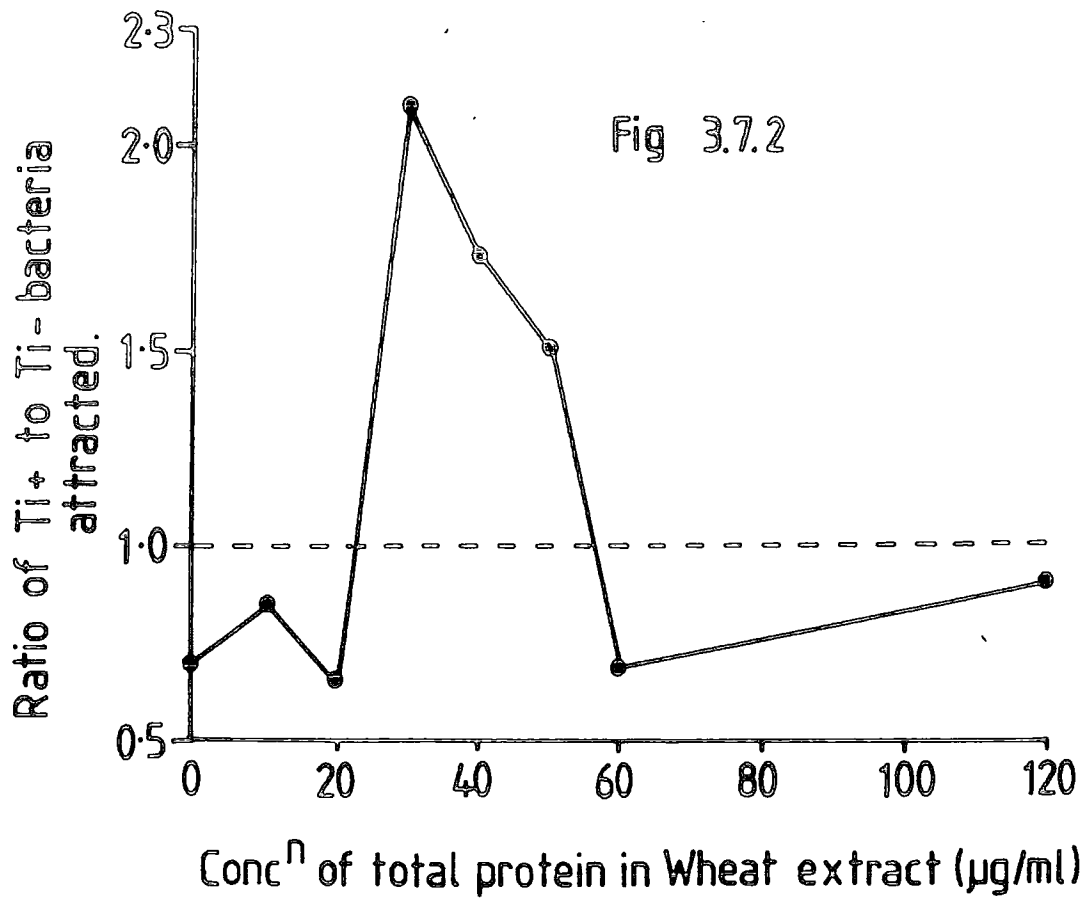

ure 3.7.3) at $40\mu\text{gml}^{-1}$ total protein. At dilutions lower than $20\mu\text{gml}^{-1}$ total protein, significant chemotaxis was not observed above the control value.

3.8 The effects of cell wall components on chemotaxis of

C58C¹(pDUB1003Δ31) towards natural homogenates.

To assess whether cell wall components were involved in chemotaxis of *A. tumefaciens* towards natural extracts, homogenates were prepared from freshly isolated leaf protoplasts, regenerating protoplasts, and leaf material from the same tobacco leaf (outlined in materials and methods) and each sample diluted to $70\mu\text{gml}^{-1}$ total protein. The homogenates were tested as chemoattractants for *A. tumefaciens* C58C¹(pDUB1003Δ31).

Figure 3.8 demonstrates that equivalent chemotactic responses were obtained for all three samples. This indicates that the presence of a cell wall, whether freshly regenerated or of mature tissue, does not increase the chemotactic response evoked by *Agrobacterium*. No apparent increase in chemotactic response in the presence of cell wall material suggests that no major chemoattractant is present by this tissue. These results are supported by the finding that acetosyringone and other vir-inducing phenolics are produced by metabolically active cells within the cell cytosol and are not liberated by sloughed off cells or decaying cell wall material (M. Van Montagu, personal communication).

3.9 Discussion.

It was originally perceived that the initial interaction between *Agrobacterium* and a susceptible plant was bacterial cell-plant cell binding (15,16,17,18). However; observations demonstrating that *Agrobacterium* species were attracted towards roots (9), and that certain plant derived phenolic compounds act as inducers of the Ti-plasmid virulence region (71,72), suggested that the bacterial-plant interaction extended further than the binding of bacteria to the plant cell wall and involved bacterial recognition of plant derived exudates. It was this

Figure 3.8

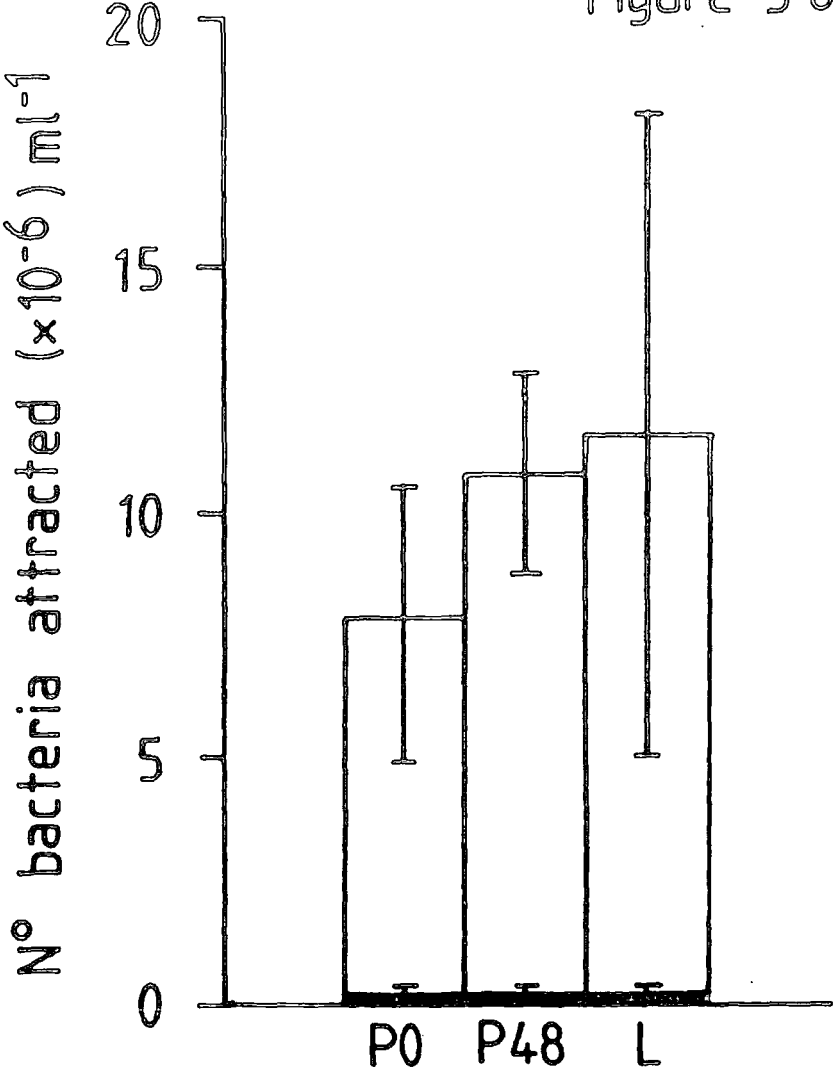

realization that led to the current study of chemotaxis in *Agrobacterium tumefaciens*.

3.9.1 Dose response curves.

The dose-response curves obtained for all of the phenolic compounds tested are similar in shape to those reported in *E. coli*, having the characteristic peak at the maximal chemoattractant concentration which drops off at increased concentrations. This apparent drop in attraction is in fact an artifact of the experiment and results from the concentration of attractant being so high that a gradient of concentration takes longer to achieve and therefore bacteria cannot respond in the time available during the assay (129).

3.9.2 Monocyclic phenolic compounds.

3.9.2.1 Category 1 phenolics.

The results obtained for category 1 phenolics suggests that the group actually represents two subcategories which are differentiated by the sensitivity of the chemotactic response. Therefore; acetosyringone, sinapinic acid and syringic acid would reside in one subcategory which evoke extremely sensitive responses, responding to concentrations at least 100 times lower than the concentration required to produce maximum induction; while vanillin, ferulic acid and 3,4-dihydroxybenzoic acid, reside in the second subcategory which evoke chemotactic responses several orders of magnitude higher. The chemotactic optimum for these phenolics correlates well with the fact that they are not as strong inducers as the first subcategory, requiring a higher concentration to obtain the optimum inducible response.

There are two exceptions, namely catechol and p-hydroxy benzoic acid which both act as virulence inducers according to Bolton *et. al.* (72) yet act as chemoattractants for *A. tumefaciens* lacking a Ti-plasmid. In contrast to Bolton *et. al.* (72), a recent review by Melchers and Hooykaas (340) stated that in

their experiments, catechol and p-hydroxy benzoic acid do not act as inducers of the *vir* genes. In view of this result, the data obtained on chemotaxis towards these two phenolics is no longer an anomaly and the results as a whole suggest a strong correlation between *vir* inducing ability and Ti-plasmid requirement for chemotaxis.

3.9.2.2 Other phenolic categories.

The results obtained with the other categories of phenolic compounds suggested that their presence in the environment of the rhizosphere may act to enhance the overall population of both avirulent and virulent strains of *Agrobacterium*.

The importance of polyphenolic compounds on host specificity in the *Agrobacterium*-plant interaction was recently reviewed by DeCleene (12). It was concluded that those plants able to accumulate polyphenolic compounds were highly susceptible to *Agrobacterium* mediated tumours whereas those unable to accumulate such compounds were not sensitive. Although this study concentrates on chemotactic responses towards monophenolic compounds (ie one phenolic ring), it is important to remember that polyphenolic compounds are synthesized from individual monophenolic derivatives and that such polyphenolics eventually form the polymer, lignin. Both the biosynthesis and degradation of this polymer will produce byproducts that are both monophenolic and polyphenolic in nature. The finding that polyphenolics are of importance in host specificity and therefore in the *Agrobacterium*-plant interaction is of great relevance to the data presented here since one may postulate that the chemotactic response towards phenolic compounds initially derived from polyphenolics is the initial step determining this interaction.

3.9.3 Structures of phenolic chemoattractants.

The spectrum of compounds assayed above allow certain operational rules to be established regarding the degree of substitution of the benzene ring necessary to produce both a highly sensitive chemotactic response and an optimum response for *vir* induction. Bolton et al (72) established that a 4' hydroxyl group was important in *vir* induction. All of the compounds tested except isovanillic acid have a 4' hydroxyl group but fit into four distinct categories with regard to the chemotactic and *vir* inducing properties they evoke. For optimum Ti-plasmid determined chemotaxis and *vir* induction, the presence of a 4' hydroxyl group, 3' and 5' O-methyl groups and a polar side chain at the 1' position appear to be important (76). Loss of O-methyl groups results in a loss of sensitivity but not specificity, unless other substitutions are altered. It is clear from this data that a chemotactic response determined by a Ti-plasmid is in general much more sensitive than those encoded elsewhere.

3.9.4 *virA* and *virG* are the Ti-plasmid virulence genes

involved in specific chemotaxis towards acetosyringone.

in our laboratory

It was demonstrated that *A. tumefaciens* C58C¹ containing Ti-plasmids with Tn5 insertions in *virB*, C, D and E exhibited marked chemotaxis towards acetosyringone at a concentration of 10⁻⁶M. However, Ti-plasmids with mutations in *virA* or G were unable to confer the responsive phenotype. When cosmid clones were analysed it was demonstrated that when pVK219 (*virAB*), pVK221 (*virBGC*), pVK225 (*virGCDE*) and pVK257 (*virABGC*) were mobilized into cured *A. tumefaciens* C58C¹, only pVK257 was able to elicit the chemotactic response at 10⁻⁷M.

The results suggest that *virA* and G are required for chemotaxis of *A. tumefaciens* towards acetosyringone and suggest a multifunctional role for *virA* and G in both chemotaxis and *vir* induction (76).

The observed peak at 10^{-6} M for the *vir* mutants is probably due to an alteration in receptor affinity, a phenomenon often observed with mutants in *E. coli* (341).

The *virA* protein is localized in the inner membrane and has been shown to share homology with the *cheA* protein of *S.typhimurium*, which acts as a positive regulator of chemotaxis (185). It is proposed that the *virA* protein transmits (either directly or via a second messenger) environmental signals which are picked up by the *virG* protein. This protein shares homology with the *cheY* protein as well as other bacterial regulatory proteins. The roles played by the *virA* and *G* proteins appears to be dual in that at low ligand concentrations, *virA* and *G* are functional in the specific Ti-plasmid determined chemotactic response towards acetosyringone (76), and at higher concentrations the system acts to initiate the induction of the other virulence genes (71,72).

3.9.5 Postulated models for the acetosyringone binding site.

The dual function of the *virA* and *G* proteins has yet to be elucidated, however, it is feasible to predict that this dual effect may be experienced at the acetosyringone binding site.

The simplest model that may be envisaged is one based on the structure of the haemoglobin molecule. Haemoglobin is responsible for carrying oxygen and is found in the red blood cells of vertebrates. The molecule consists of four polypeptide subunits; 2 α and 2 β . There are four haem groups, one per subunit, and therefore four binding sites for oxygen. On binding the first oxygen the molecule undergoes a shift in two of the four subunits which opens up the complex and enhances the binding of additional oxygen. The mechanism is described as an 'allosteric effect' and haemoglobin as an 'allosteric protein' (342). A similar allosteric effect may occur in the acetosyringone binding protein, however, whether *virA* functions as a monomer or a multimer has yet to be determined. One can hypothesise that the *virA* protein may complex to

form dimers, tetramers etc in the inner membrane, the final arrangement forming the receptor complex. Each *virA* protein subunit having one active site for acetosyringone binding. On binding of the first acetosyringone molecule the complex may undergo allostery, opening up the complex and revealing more binding sites. In this instance signals may be directed towards the chemotaxis apparatus, however, once the full complement of acetosyringone binding domains are occupied the signal gets directed towards induction of virulence gene expression (figure 3.9.5a).

A similar allosteric effect may apply to a single protein subunit having several active domains for the phenolic, where binding of the first molecule causes a shift which exposes the remaining binding domains (figure 3.9.5b).

A further model involving *virA* monomers is the comparison model. Here one may hypothesise that an array of acetosyringone (AS) monomers line the periplasmic membrane and are constantly signalling to one another. If one receptor binds AS it signals to others around it. If surrounding monomers do not have bound AS then chemotaxis up the concentration gradient of AS continues. Once all receptors are full the message is relayed from the receptors and the bacterium halts the chemotactic machinery. At this stage where the concentration of bound AS is high, *vir* induction may occur (ref. figure 3.9.5c).

3.9.6 The relevance of chemotaxis towards monophenolic compounds to the *Agrobacterium*-plant interaction.

Chemotaxis towards certain plant derived phenolic compounds (104,239,186) has been shown not to be a Ti-plasmid determined trait and therefore offers an explanation for the relative abundance of *Agrobacterium* in the rhizosphere (10).

However, virulent *Agrobacterium* will be guided towards a susceptible plant source by the release of lignin derived vir-inducible phenolics such as sinapinic

Fig 3.9.5

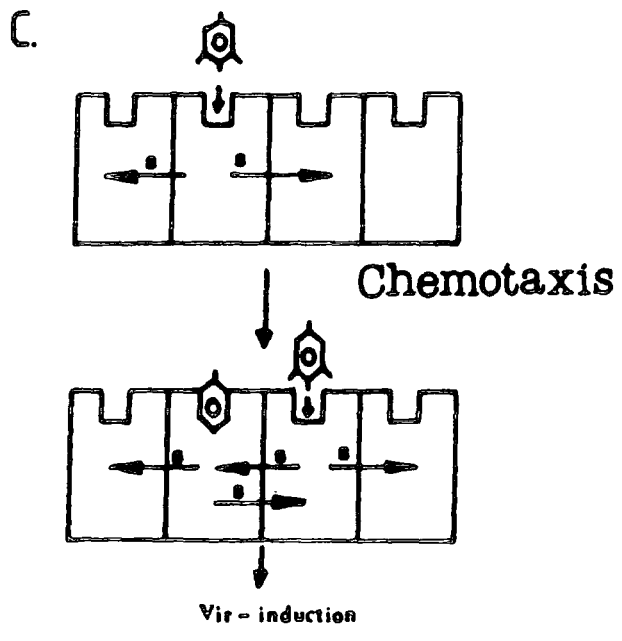
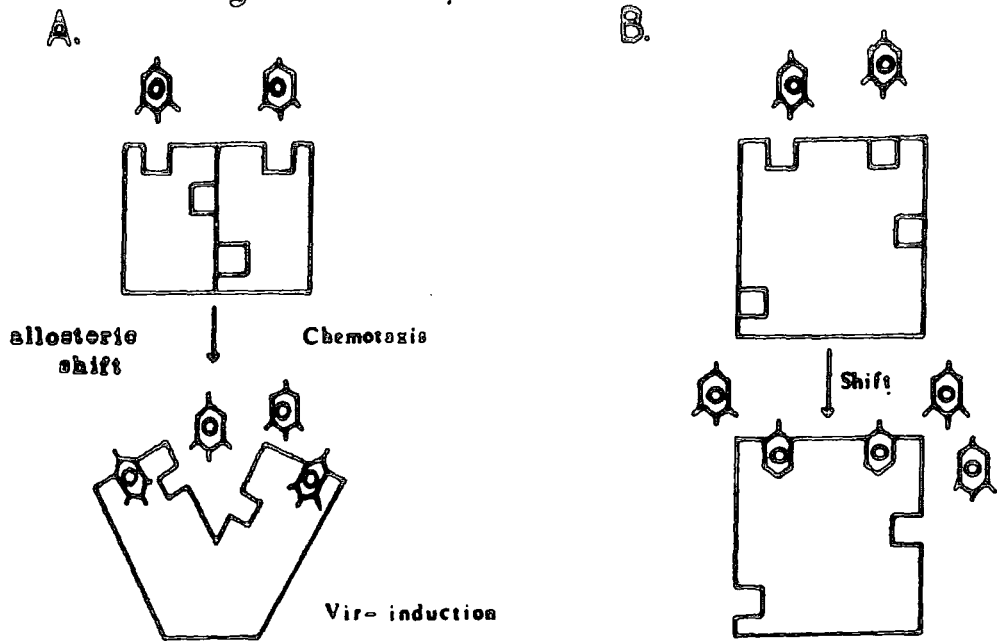

acid and acetosyringone, move up a concentration gradient of such phenolics, resulting in attraction towards the wound site. Once at the wound site where the concentration of *vir* inducible phenolic compounds will be high, induction of the virulence operons occurs and T-DNA is transferred to the plant genome (13). The apparent Ti-plasmid enhancement of chemotaxis towards plant phenolic inducers of the virulence region would increase the competitive advantage of virulent strains over the majority of avirulent strains in an otherwise stressful environment.

3.9.7 Chemotaxis towards plant homogenates.

a) Dicotyledonous extracts.

Chemotactic responses towards tobacco extracts were lower than those of *Kalanchoe* since less root and shoot material was taken to produce homogenates. However, the results clearly demonstrate that *Agrobacterium tumefaciens* can respond chemotactically towards such extracts.

Both stationary and exponential phase cells evoked a response towards tobacco shoot and autoclaving the extract did not effect the response observed. Conversely, only exponential phase cells exhibited a response towards root extract and autoclaving completely abolished the response. The results suggest that with root extracts, *Agrobacterium* may be responding to chemoattractants that are denatured by autoclaving, or to components that are hydrolyzed or degraded by the autoclaving step. The observation that only exponential cells respond to root extract may be indicative of loss of some chemoreceptor sites during the latter stages of the cell cycle or simply an artifact due to the fact that only low levels of material were used.

b) Monocotyledonous homogenates.

The amounts of wheat shoot and root material used to prepare homogenates was much greater than that used for tobacco and accordingly chemotactic re-

sponses were greater.

Exponentially grown cells were equally attracted towards root and shoot extracts regardless of whether or not the samples had been autoclaved, suggesting that bacteria in this state respond to chemotactic components that are either heat labile or not degraded or hydrolysed during the autoclaving step. Conversely, the autoclaving step may eliminate some chemotactic components but at the same time make available new attractants by hydrolysis or degradation therefore producing a net result of no change in chemotactic response.

The response pattern obtained with stationary phase cells differed significantly. Although a response was observed in all cases whether autoclaved or filter sterilized extracts were being examined, there was a marked decrease in response to both autoclaved root and shoot extracts when compared with the filter sterilized extracts. This suggests that stationary phase cells are attracted towards components that are heat sensitive and are therefore degraded or hydrolysed to non-chemoattractive components by autoclaving. Such a result may suggest that exponential phase cells are able to respond to a much greater array of chemoattractants by virtue of possessing more receptor domains.

3.9.7.1 Ti-plasmid enhancement of chemotaxis towards dilute extracts of Wheat and *Kalanchoe*.

The presence of a Ti-plasmid in C58C¹ enhances the chemotactic response of the bacterium towards dilute extracts of wheat (figure 3.7.2) and *Kalanchoe* (figure 3.7.3) demonstrating that the Ti-plasmid plays an important role in chemotaxis towards natural extracts. The chemotactic response of *A. tumefaciens* C58C¹ appears to be due to diffusible factors in the homogenates. Although native cell wall components are not required for attraction (figure 3.8), this does not rule out the possibility that cell wall precursors of lignin may be involved. In this regard it is interesting that acetosyringone and other monocyclic

phenolic inducers are thought to be obtained from the degradation of polyphenolic components of lignin or as biosynthetic precursors of this polymer. The Ti-plasmid determined chemotaxis to low concentrations of acetosyringone, sinapinic acid, syringic acid and other plant phenolic inducers correlates well with the Ti-plasmid enhancement of chemotaxis towards both monocot and dicot homogenates. The role of chemotaxis in the *Agrobacterium*-plant interaction must be in guiding the bacterium towards the plant, the initial attraction involving a spatial separation of the two organisms and therefore recognition would occur at low attractant concentrations.

A limited number of monocots are susceptible to infection by *Agrobacterium* (14) and recent reports have attempted to correlate the decreased numbers of vir-inducers in monocots with their apparent non-susceptibility (343,344), although the evidence is conflicting. The results obtained with *A. tumefaciens* C58C¹ indicate that both monocots and dicots are equally potent as chemoattractants and that there is Ti-plasmid enhancement of attraction towards dilute extracts. Since Ti-plasmid functions are also required for chemotaxis towards plant phenolic inducers of the virulence region, this strongly suggests that recognition of, and attraction towards, susceptible plants is not the step blocked in the monocot transformation.

3.9.8 A detailed scenario of *Agrobacterium*'s behaviour in the environment of the rhizosphere.

The relative abundance of avirulent agrobacteria in the \wedge ^{microrhizosphere around plants} may be due to attraction towards some phenolic compounds (104,239,186) as well as to plant derived sugars (171).

Virulent agrobacteria will be attracted into the vicinity of a susceptible plant by low concentrations of plant exudate such as acetosyringone. The concentration required for chemotaxis being at least 100 fold lower than that causing

vir-induction, thus virulent bacteria are guided towards the wound sites. Once at the wound site where the concentration of phenolic is high, induction of the virulence region occurs and T-DNA is transferred into the plant genome (345).

The observed Ti-plasmid enhancement of chemotaxis towards plant phenolic inducers of the virulence region and natural extracts suggests that this trait would provide virulent *Agrobacteria* with an advantage in an otherwise stressful habitat.

Chapter 4

A plant protection method involving chemotaxis

Chapter.4

4.1 Introduction.

Agrobacterium tumefaciens is a natural rhizosphere microorganism and is a good root colonizer (9). Agrobacteria are attracted towards susceptible plants by responding chemotactically to specific biosynthetic phenolic precursors of lignin that are released during the wounding process (104,186). Once at the plant surface where the concentration of vir-inducing phenolic compounds are sufficient to cause induction of the Ti-plasmid virulence operons, T-DNA transfer into the plant genome occurs (245).

The results demonstrating that the presence of a Ti- plasmid enhances the chemotactic response of *A. tumefaciens* towards both monocot and dicot homogenates (239) and that the Ti-plasmid plays a pivotal role in chemotaxis towards plant derived phenolic inducers of the virulence region, resulted in the formulation of an idea for a possible application of this process in developing *A. tumefaciens* and other rhizobacteria as biological control agents (262).

The idea concerns bacteria that can detect very low levels of plant wound exudate, move chemotactically to the site of wounding and produce pesticidal material under the control of a virulence gene promotor, as a result of vir induction by high concentrations of phenolic wound exudate (figure 4.1). The potential benefit of this system with respect to other existing microbiological control systems is that the expression of genes for pesticidal proteins is regulated by components of wound exudate and is therefore a conservative process, pesticide being produced only when a plant is wounded, at the time when it is most susceptible to attack by plant pathogens, and then exclusively in the microrrhizosphere around the wound site.

Once the plant has healed itself it will no longer release the phenolic activating compounds and the expression of the pesticide will be diminished.

Fig 4.1

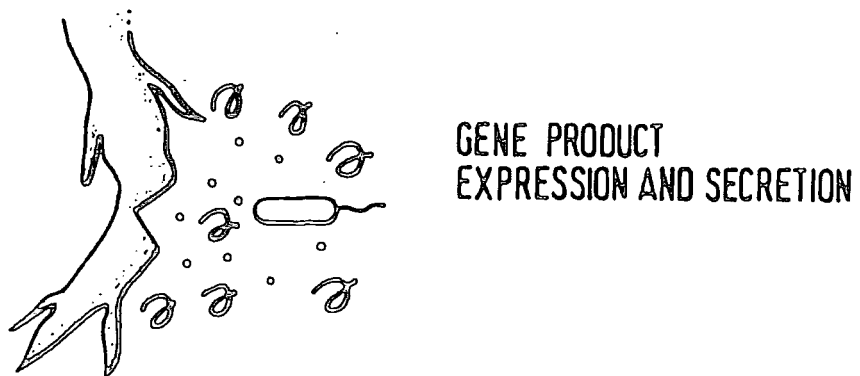
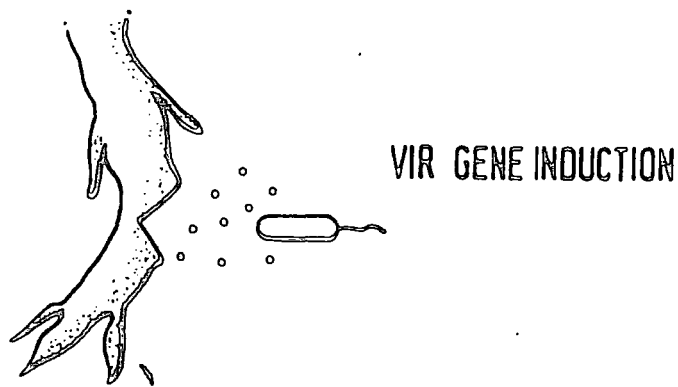
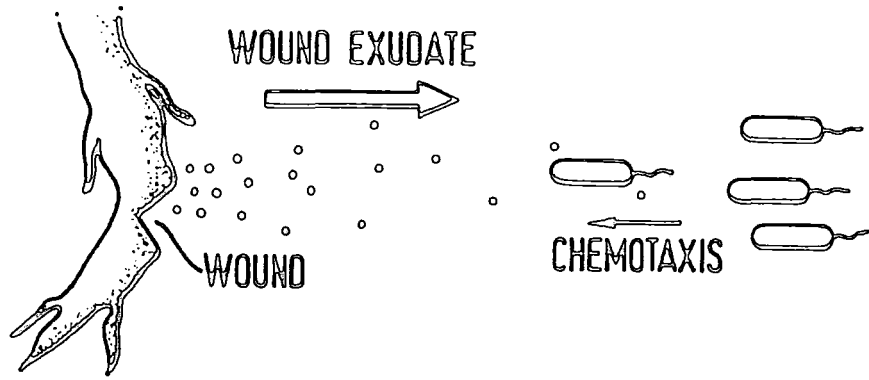

A large number of economically important plant diseases occur through opportunist pathogen infection of a plant wound and therefore this idea potentially offers significant technical and commercial advantages over other biological and conventional chemical control systems since it will be effective for a much wider range of crop protection problems.

4.1.1 The active molecule.

Any natural microbiological control molecule could be used in this system, either alone or with other pesticidally active molecules. Useful pesticidally active proteins include the δ endotoxin from *Bacillus thuringiensis*, siderophores from *Pseudomonas fluorescens*, glucanases and mannanases capable of degrading fungal cell walls, and chitinases capable of degrading fungal cell walls and the mouthparts of insects.

The pesticidally active protein chosen for the initial development of the novel biocontrol agent was one of the chitinase genes from *Serratia marcescens* (263).

Chitinase is the active enzyme that catalyzes the breakdown of chitin, a β -1,4-linked polymer of N-acetylglucosamine. Chitin is quite frequently found in nature and constitutes an important component of the cell walls of fungi and the exoskeleton of many insects (264).

Several bacteria have been shown to be chitinase producers (264), and the protein is also produced by plants during the wound response (291). *Serratia marcescens* is a Gram-negative soil bacterium that produces several chitinases (264,265), some of which have been cloned (265,263).

Since *Serratia marcescens* and *Agrobacterium* are both Gram-negative soil bacteria it seemed feasible to predict that the *Serratia* chitinase genes would function in *Agrobacterium* and produce proteins that were both secreted and active.

The choice of virulence promoter was based on both its inducibility by plant phenolic compounds (ie whether or not the promoter was constitutively expressed and plant inducible or solely plant inducible and therefore regulated by the presence of vir-inducible phenolic derivatives) and the levels of expression achieved. The idea was to choose an inducible promoter that was highly expressed in the presence of vir-inducible phenolics such as acetosyringone. For this reason, the *virB* promoter was chosen (266,276).

Two of the chitinase genes were recently cloned (263) and *E. coli* harbouring chitinase plasmids were therefore available. pCHIT1251 and pCHIT310 harbouring the chitinase genes which encode a 58KD and 52KD protein respectively, were kindly donated by John Bedbrook (AGS, Berkeley).

The plasmid pSM30 harbouring the *virB* promoter and coding sequences was kindly provided by Scott Stachel (Rijksuniversiteit, Gent).

4.2 Cloning of the *S. marcescens* chitinase genes into *A. tumefaciens* C58C¹ The mark 01 and mark 02 constructs.

It was of utmost importance to check that the *Serratia marcescens* chitinases could be expressed and secreted by *Agrobacterium* as any regulatory or physiological barriers would have prevented this pesticidal protein from being included in the final cassette.

pCHIT1251 (263) is a plasmid derived from the plasmid pUC8 (267), harbouring a 2.5kb HindIII - EcoRI fragment carrying a chitinase gene from *S. marcescens* (figure 4.2). The plasmid is unable to replicate in *Agrobacterium* and therefore has to acquire functions allowing it to do so. This was achieved using a very simple strategy.

pGV1106 Km^r, Gm^r, Nm^s (268) is a broad host range plasmid that carries the origin of replication of the W-type plasmid Sa (269) and is therefore able to replicate in *Agrobacterium* (figure 4.2). It is unrelated to the normal resident

Fig 4.2

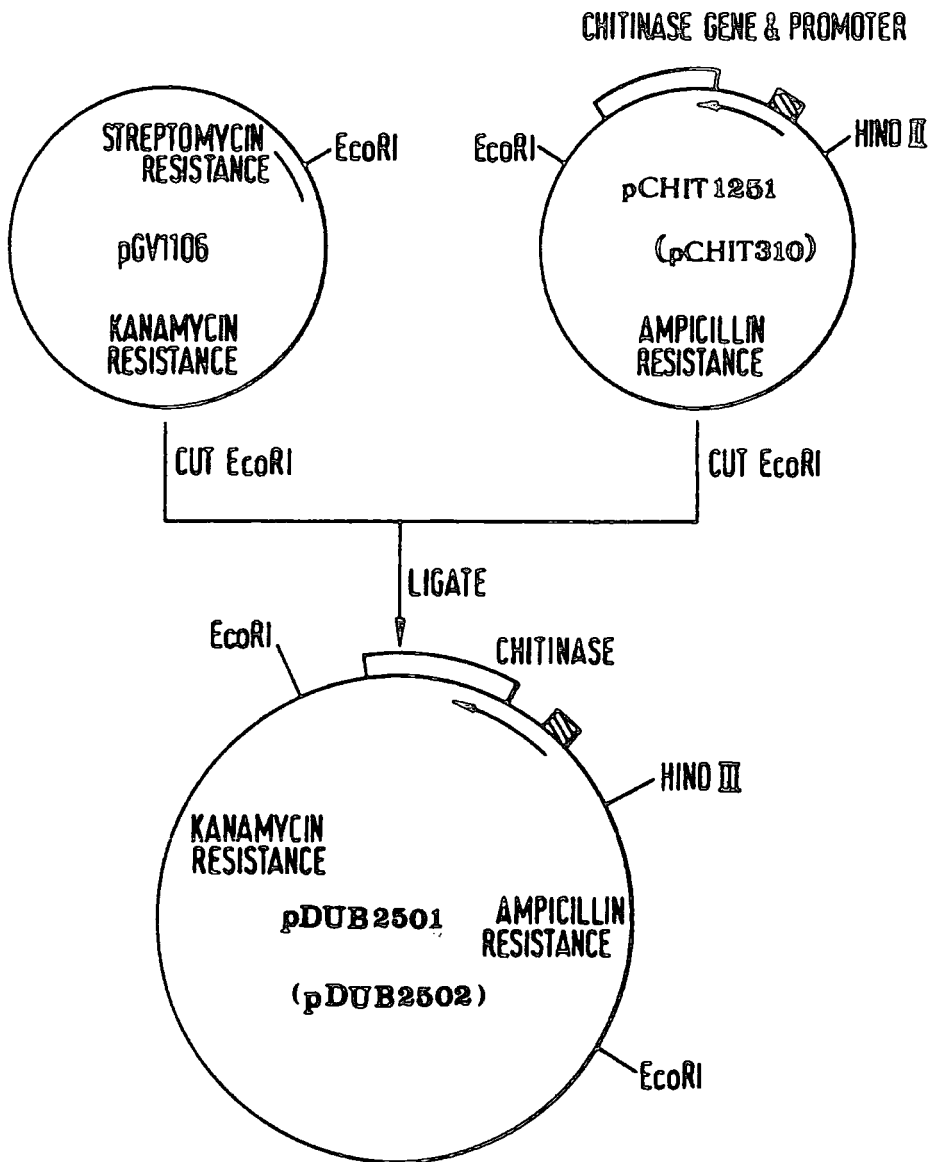

Ti-plasmid and when conjugated into *A. tumefaciens* will not produce a virulent phenotype.

Conveniently, both pGV1106 and pCHIT1251 have a unique EcoRI site and it was therefore possible to ligate (see materials and methods chapter) both plasmids together via their respective EcoRI sites, to form the plasmid pDUB2501 (figure 4.2). The construct will replicate in *Agrobacterium* and carries the *S. marcescens* chitinase gene expressed from its normal promoter.

A second chitinase plasmid, pCHIT310, was also ligated to pGV1106 via the unique EcoRI sites forming pDUB2502.

Ligated plasmids were transformed into *E. coli* JM83 and transformants selected on L-Amp/Km (see materials and methods chapter).

Both pDUB2501 and pDUB2502 were conjugated into *A. tumefaciens* C58C¹ Rif by the double mating procedure, as described in the materials and methods, to produce C58C¹ (mark 01) and C58C¹ (mark 02) respectively.

Agrobacterium C58C¹ harbouring the mark 01 and 02 plasmids was plated onto MinA chitin medium (as described in chapter 2) and incubated for 4 days @ 28°C. After this time period, zones of clearing were evident around the bacterial streaks, indicative of chitinase activity. The isogenic control strain, C58C¹ lacking this construct did not produce zones of clearing on the MinA chitin media.

These results clearly demonstrate that there were no physiological or regulatory blocks preventing the expression and production of the *Serratia* chitinase in *Agrobacterium*.

4.3 The mark 1 construct : the *virB*-chitinase cassette.

4.3.1 The chitinase cassette.

From sequence analysis (263) the chitinase coding region was found to lie between the EcoRI and NruI sites of the chitinase fragment in pCHIT1251. A straightforward strategy involving restriction digests was therefore employed to separate the chitinase coding region from upstream promoter sequences.

A common restriction site was required in order to fuse the final cassettes together and therefore a suitable linker sequence had to be incorporated into each cassette. The phosphorylated (see chapter 2) synthetic linker sequence chosen was BamHI:-

5'- pG G G A T C C C - 3'

A pure plasmid preparation of pCHIT1251 (figure 4.2) was obtained (see chapter 2) and 1 μ g digested with NruI in NruI buffer (see chapter 2) for 3 hours at 37°C. The reaction mix was phenol/chloroform extracted, ethanol precipitated and resuspended in 10 μ l of sterile distilled water (see chapter 2). The digested plasmid was ligated overnight at 4°C incorporating 0.1 μ g of phosphorylated BamHI linkers. The ligation mix was heated to 80°C to denature the ligase and digested with 10 units of BamHI in medium buffer for 5 hours @ 37°C. The sample was then loaded onto a 0.7% low melting point (LMP) agarose gel (chapter 2) to separate ligated from unincorporated linkers. The fragment was isolated by the low melting point procedure, as outlined in chapter 2 and resuspended in 20 μ l of sterile distilled water.

The efficiency of incorporation of synthetic phosphorylated linkers is usually quite low so in an effort to increase the chance of picking up a transformant that had incorporated BamHI linkers, a BamHI fragment harbouring a Km^r marker (see chapter 2) was ligated to the presumptive pCHIT1251 plasmid with BamHI ends after the LMP agarose gel step. By adding this fragment to the reaction

mix it was possible to select directly for Km^r , the Km^r fragment being able to replicate only if ligated into BamHI ended pCHIT1251.

Competent JM83 cells (see chapter 2) were transformed with the ligated plasmid and transformants selected on L-Amp/ Km . Transformants were obtained, the efficiency of transformation being very low at $8 \times 10^1 \mu g^{-1} DNA$

Transformant colonies were purified on fresh L-Amp/ Km plates and mini-preparations of DNA obtained (chapter 2). Restriction analysis revealed that the BamHI Km^r fragment had been incorporated into all of the transformants analysed and therefore BamHI linkers had attached to the blunt ended NruI site of pCHIT1251 in the initial step. Digestion of this plasmid (pDUB2503) with EcoRI (High buffer) and BamHI (Medium buffer) produced three fragments; a fragment at 1.1kb, corresponding to the Km^r gene, a fragment at approximately 2.6kb corresponding to EcoRI-BamHI cut pUC8 plus the upstream promoter sequences of the chitinase gene and a fragment at approximately 2.25kb corresponding to the EcoRI-BamHI chitinase coding region lacking upstream promoter sequences but maintaining the Shine Dalgarno sequence and translation initiation codon. The latter fragment was isolated using the low melting point method and formed the chitinase 'cassette'.

4.4 The *virB* promoter cassette.

4.4.1 Subcloning the Sall-ClaI fragment from pSM30.

Plasmid pVCK242 (270) containing the Tn3HoHoI transposon inserted adjacent to the *virB* promoter region forms the plasmid pSM30 Km^r (73), kindly donated by Scott Stachel.

The promoter sequence of *virB* is located at the beginning of the Sall 13a fragment (73) as shown in figure 4.4.1. Within pSM30 the promoter region of *virB* could be isolated by digesting the plasmid with Sall and ClaI and isolating a fragment corresponding to approximately 5kb. This fragment contains approx-

Figure 4.4.1

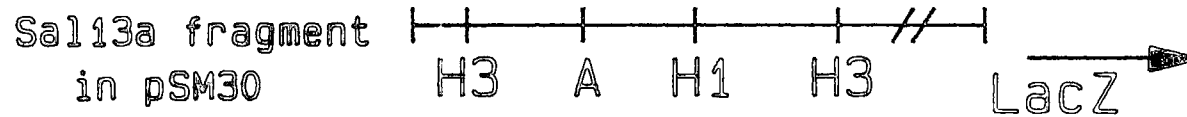
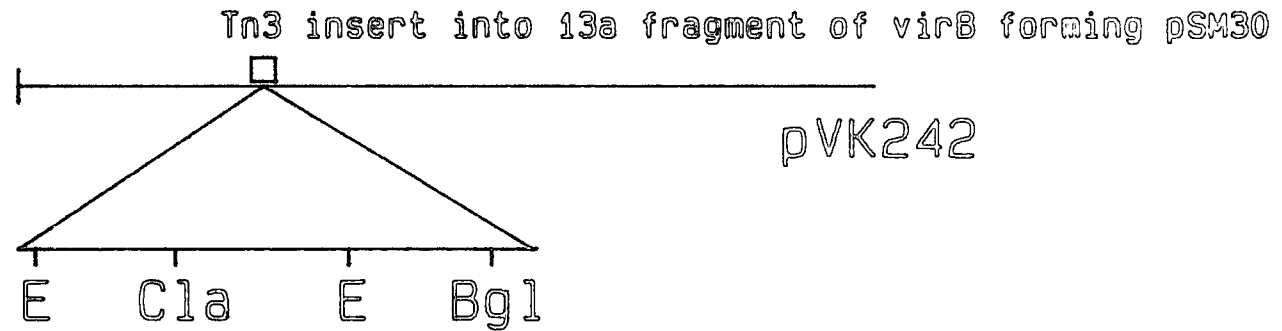
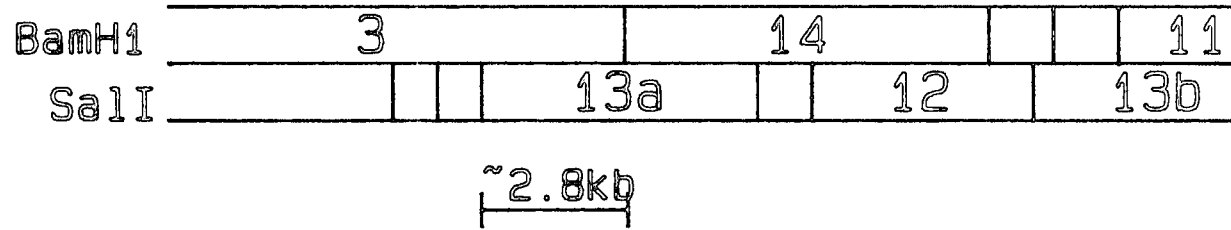

imately 2.7kb from Sall 13a and 2.3kb from the inserted transposon Tn3HoHoI (figure 4.4.1). Restriction analysis of this fragment would ascertain a) if the BamHI site lay to the left or right of the Tn3HoHoI insert (figure 4.4.1) and b) if the 1.3kb HindIII fragment containing the *virB* promoter sequences (73) was present.

A conjugation (see chapter 2) was performed between *A. tumefaciens* A348(pSM30) and *E. coli* K514 and transconjugants selected on $50\mu\text{gml}^{-1}$ kanamycin. A mini preparation (50ml) was performed on one of the positive transconjugants using a scaled up version of the alkali-lysis method (chapter 2) and a reasonable yield was obtained.

pSM30 was digested with Sall and BscI (an exact isochizomer of ClaI) in high buffer for 3 hours at 37°C and the digest run on a low melting point agarose gel (0.7% w/v) at 30V overnight. Fragments approximating to 5kb were isolated and ligated to pBR322 Sall/BscI.

$15\mu\text{l}$ of the ligation cocktail was used to transform competent cells of JM83 and transformants selected on $50\mu\text{gml}^{-1}$ Ampicillin.

The insertion of the Sall-ClaI fragment from pSM30 into pBR322 will disrupt the tetracycline (Tet) gene and will render the transformant tet sensitive. For this reason all of the transformants were restreaked onto Amp plates and also streaked onto tet plates, therefore screening for the insertion.

Mini preparations from several of the Amp^r Tet^s transformants were made and DNA analysed by restriction digestion.

4.4.2 Isolation of the 1.3kb HindIII presumptive *virB* promoter fragment.

DNA analysis of transformants harbouring a fragment from pSM30 approximating to 4.6kb cloned into pBR322 contained the 1.3kb HindIII presumptive *virB* promoter fragment. The plasmid was designated pDUB2504. Further analysis with BamHI revealed that the BamHI site lies to the right of the Tn3HoHoI

insert (figure 4.4.1). If this site lay to the left of the Tn3HoHoI insert, a simple digest with Sall and BamHI would have separated the *virB* promoter sequence from the majority of *virB* coding region and Tn3HoHoI sequences.

Southern hybridization with an oligonucleotide probe (20mer) synthesized from a published *virB* promoter sequence (271) to pDUB2504 digested with HindIII revealed that the 1.3kb fragment did indeed hybridize to the *virB* promoter sequence.

The 1.3kb HindIII fragment from pDUB2504 was subcloned into pUC19 (267) forming pDUB2510.

4.4.3 Controlled deletions of pDUB2510 to remove 3' downstream coding sequences.

The strategy adopted to delete all of the downstream coding sequences from the *virB* promoter fragment employed the use of the enzyme exonuclease III. The enzyme specifically digests DNA sequences with 5' protruding ends or 3' ends from blunt ends, but will not digest 3' overhangs. Single stranded DNA tails are then removed by the action of Mung Bean nuclease (256), which specifically degrades single stranded DNA, resulting in duplex DNA molecules with deletions. The advantage of using exonuclease III as opposed to Bal 31 for controlled deletions is that deletions can be made in one direction only by digesting with two enzymes contained within a polylinker sequence, one producing a 3' overhang and the other a 5' overhang. Since exo III is specific for 5' overhangs, deletions will occur in one direction only.

The amounts of DNA deleted is determined by both the incubation time and the temperature of the reaction, a specific number of bases being removed in a given time at a given temperature. This procedure was adopted to produce controlled deletions in one direction into pDUB2510.

A large scale plasmid preparation of pDUB2510 was made and caesium

chloride gradient purified (chapter 2). 30 μ g of DNA was digested with 60 units of BamHI and KpnI overnight at 37°C. The digest was ethanol precipitated (see chapter 2) and the pellet resuspended in 30 μ l of sterile distilled water.

The following reaction was set up :-

30 μ l DNA

75 μ l 2X Exo III buffer (see chapter 2)

15 μ l fresh 100mM 2-mercaptoethanol

6 μ l Exo III (20 μ l/ μ g)

24 μ l water

150 μ l Total volume.

Samples were incubated at 30°C (230bp min⁻¹) and unidirectional degradation from the BamHI site took place. 25 μ l (5 μ g of plasmid DNA) aliquots were removed at 3.5, 4.0, 4.5, 5.0, 5.5, and 6.0 minutes into stop buffer (see chapter 2) and treated with Mung Bean Nuclease (256,272). Deleted plasmid was recircularized by ligation, incorporating a BamHI linker sequence (refer to section 4.3.1).

Deleted plasmids were transformed into JM83 and selected on L-Amp plates.

Mini-preparations of deleted plasmid DNA were made and the extent of the deletions measured by digesting the plasmids with Hind III and BamHI (figure 4.4.3a).

The deleted plasmid pDUB2509 giving a Hind III/BamHI fragment of approximately 0.47kb was of particular interest as this deletion was most likely to have extended closest to the predicted start of the *virB* promoter sequence. The extent of the deletion was measured by cloning the 0.47kb fragment into M13mp19 and carrying out DNA sequencing employing the method of Sanger

Fig 4.4.3a

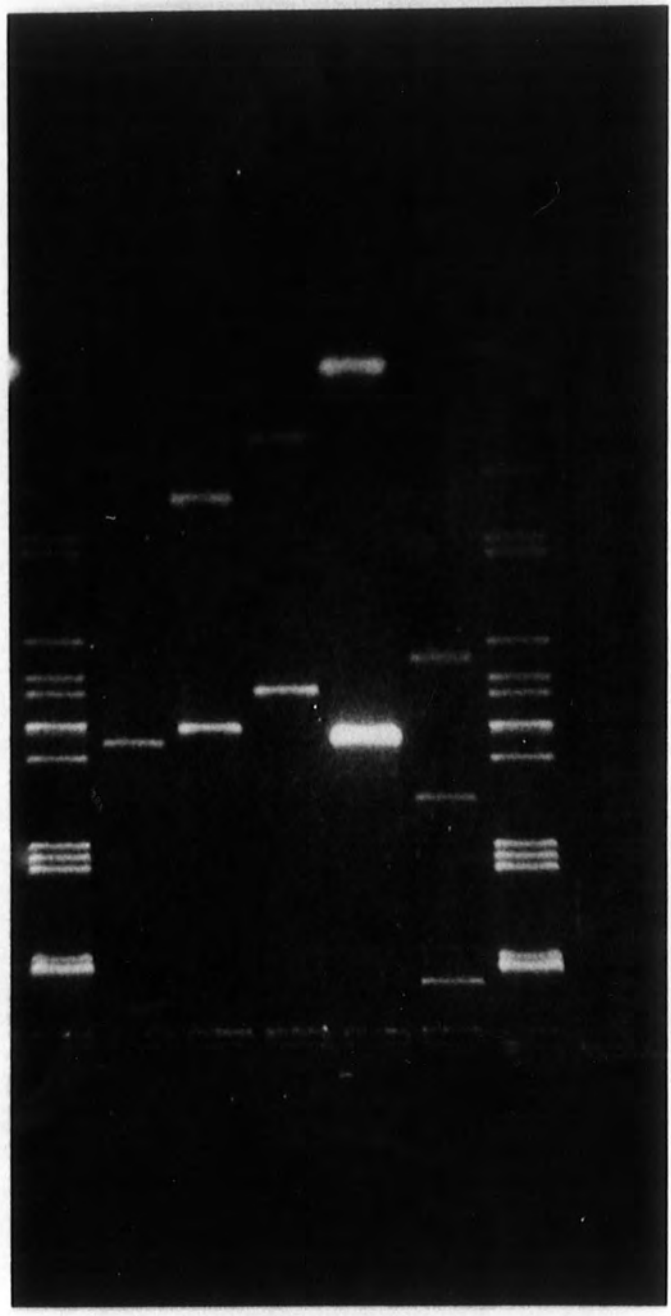

1

7

(refer to chapter 2).

Sequence analysis revealed that the deleted plasmid pDUB2509 was approximately 30bp short of the required length having the -35 sequence intact but having lost the -10 and transcription initiation sequences (figure 4.4.3b).

4.4.4 Synthesis of a synthetic oligonucleotide.

Both plus and minus strands of a 32bp synthetic oligonucleotide, corresponding to the -10 and transcription initiation sequences of the *virB* promoter region were made using a oligonucleotide synthesizer (Applied Biosystems 3801A).

1 μ g of each strand was mixed in a final volume of 20 μ l, heated to 95°C and cooled slowly to allow annealing to take place. 10 μ l (1 μ g) of the annealed mixture was phosphorylated by the action of polynucleotide kinase (chapter 2). Figure 4.4.4 outlines the DNA sequences of both strands where the 5' end of the plus strand carried a *Sau3A* restriction cleavage site and the 5' end of the complementary strand carried a *BamHI* cleavage site. By doing this, one could ensure that once linked to the deleted *virB* sequence the 32' mer' oligonucleotide would remain intact and could not be cleaved at the 5' end by digestion with *BamHI*. This fragment would therefore form the complete *HindIII*-*BamHI* *virB* promoter cassette and could be removed and used to form any *virB* promoter-linked cassette.

4.4.5 Linking the deleted *virB* fragment to the chitinase cassette.

Whilst the oligonucleotide was being synthesized the deleted *virB* cassette and chitinase cassette were fused and the Δ *virB*-chitinase cassette ligated into pUC19 (figure 4.4.5). The Δ *virB*-chitinase plasmid pDUB2511 was transformed into *E. coli* JM83 and transformants selected on X-Gal (see chapter 2) and ampicillin plates by the appearance of white colonies. 8 mini preparations were made and all plasmid preps contained both the 0.47kb deleted *virB*

Figure 4.4.3b

pDUB2509

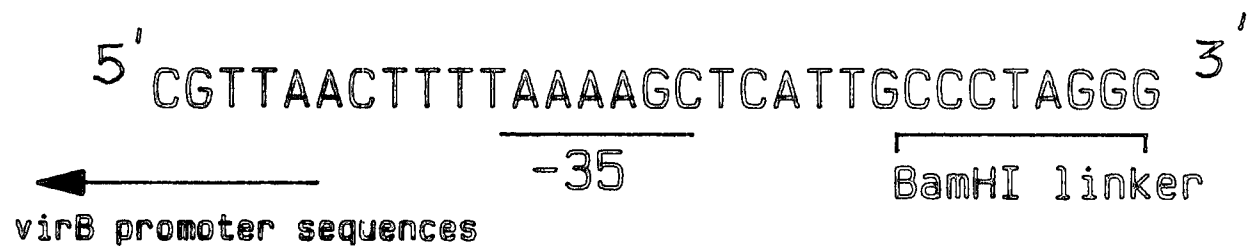

Sequence lost: -

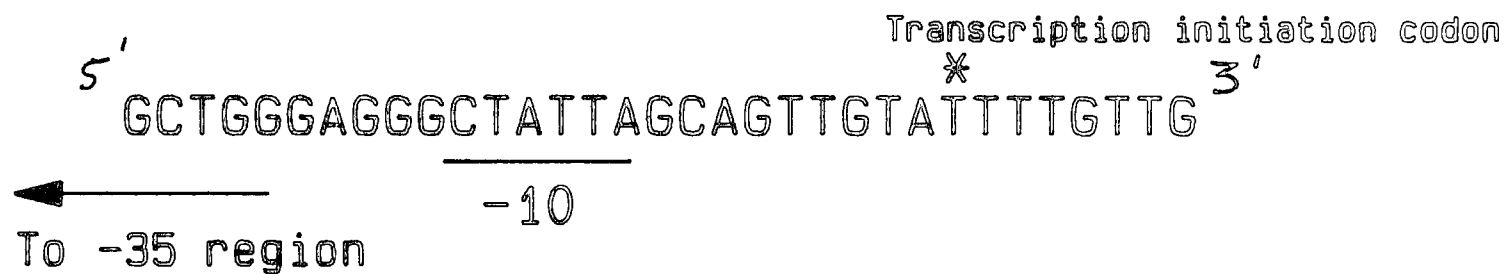

Figure 4.4.4

"32 mer" Oligonucleotide: -



Complementary strand: -



Fig 4.4.5

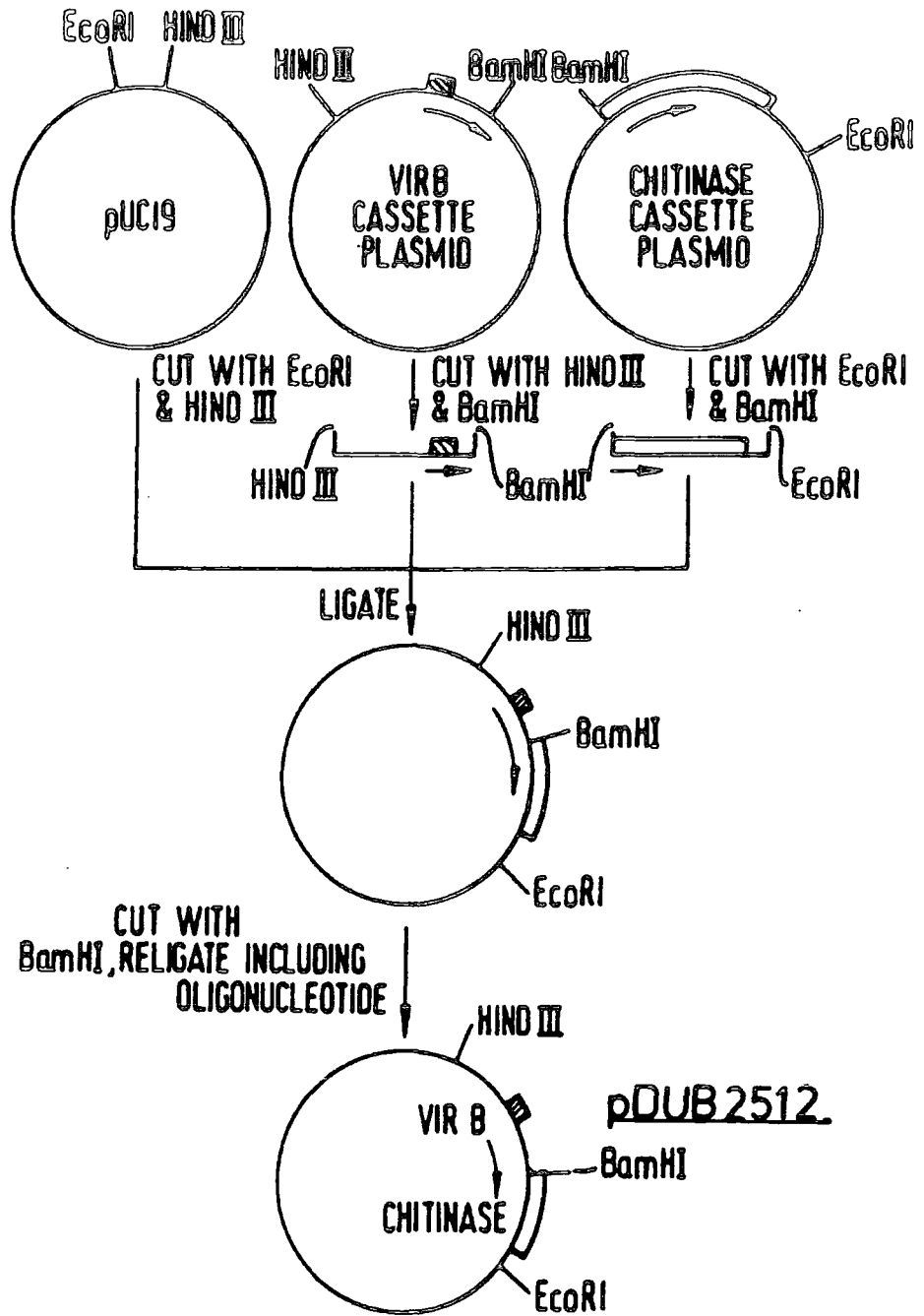

cassette and the 2.51kb chitinase cassette.

4.5 Linking the *virB* oligonucleotide to deleted *virB*- chitinase cassette : the final construct.

0.5 μ g of Δ *virB*-chitinase was digested with BamHI to completion at 37°C. 0.25 μ g of annealed and phosphorylated (refer section 4.4.4) 32 'mer' *virB* oligonucleotide was added and the two were ligated together by the action of T4 DNA ligase at 15°C overnight. 10 μ l of ligation cocktail was used to transform JM83 and transformants were selected on L-Amp plates. 40 transformants were purified onto fresh L-Amp plates and 20 mini prepped using the alkali lysis method. Transformant DNA's were digested with both HindIII and BamHI in medium buffer for four hours at 37°C. Samples were run on a 2% (w/v) agarose gel overnight at 30V with lambda PstI as size marker. A 2% (w/v) gel allows resolution between small DNA fragments and therefore the correct orientation of the 32 'mer' ligated via its Sau3A end to the *virB* promoter cassette should be visualized as an increase (of 32 base pairs) when compared with digested pDUB2511 lacking the inserted oligonucleotide.

Figure 4.5a clearly demonstrates that the inserted oligonucleotide could be visualized on the 2% gel and that it was inserted in one copy only. Figure 4.5b shows the completed *virB*-chitinase plasmid, pDUB2512 digested with BamHI/EcoRI, EcoRI/HindIII and BamHI/HindIII revealing the 2.25kb chitinase fragment, the complete *virB* promoter plus chitinase coding region fragment (2.75kb), and the 0.5kb *virB* promoter fragment, respectively.

4.5.1 Sequencing the *virB*-oligo fragment.

To ensure that only one copy of the oligonucleotide had been fused to the deleted *virB* fragment and to confirm the restriction analysis which demonstrated that the inserted oligonucleotide was in the correct orientation, the 0.5kb *virB* fragment was isolated and cloned into M13mp19 for single stranded

M13 sequencing. Figure 4.5.1 gives the sequence obtained from the fused *virB*-oligo fragment and compares it to the published *virB* promoter sequence (271). The sequence demonstrated that indeed only one copy of the 32 "mer" had been inserted and that the orientation with respect to the rest of the promoter sequence was correct.

In order to link the *virB* oligonucleotide to the deleted *virB* fragment, a *Sau3A* site had to be incorporated (from the 5' end of the oligonucleotide). Since *Sau3A* and *BamHI* have compatible ends the 5' *Sau3A* site would link the deleted *virB* promoter fragment to the oligonucleotide leaving a *BamHI* site at the 3' end (see figure 4.4.3b). In doing this, 5 bases between the -35 and -10 regions were altered. However, the exact number of bases between the -35 and -10 regions remained constant (figure 4.5.1).

4.6 Introducing pDUB2512 into *Agrobacterium*.

4.6.1 Transforming HBI01 pVK257 with pDUB2512

pVK257 is a cosmid clone containing a segment of the octopine *vir* region harbouring *virA*, B, G and C (273). The regulatory *vir* genes; *virA* and G, required for both induction of the virulence operon (73) and chemotaxis towards acetosyringone (76) are therefore present.

By introducing pDUB2512 into HBI01(pVK257) the two plasmids are able to form a cointegrate by homologous recombination between *virB* sequences. The resultant cointegrate having both ampicillin and kanamycin resistance markers, could be mobilized into *Agrobacterium* using the helper plasmid pRK2013 (as shown in figure 4.6.1) by the triparental mating procedure (chapter 2).

Competent cells of HBI01(pVK257) were prepared and 200 μ l used to transform the *virB*-chitinase plasmid, pDUB2512. Transformants were selected on L-Amp/Kan after an overnight incubation at 37°C. Several colonies were restreaked onto fresh L-Amp/Kan plates and one transformant used as the donor

Fig 4.5

A

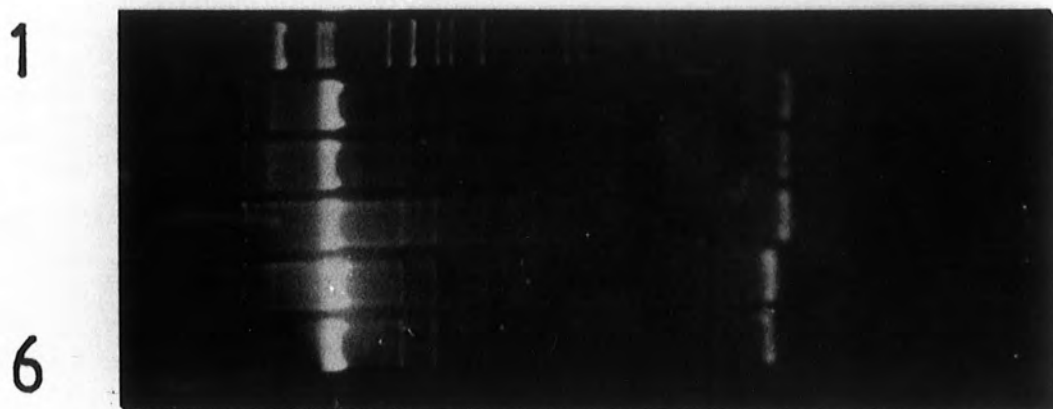

B

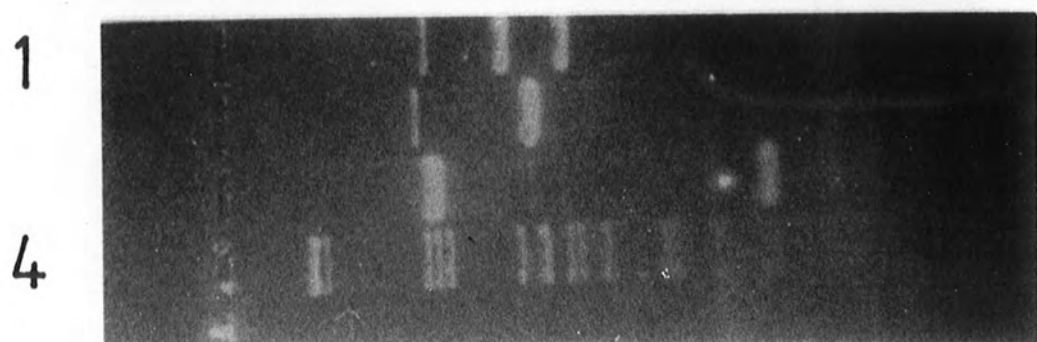

Figure 4.5.1

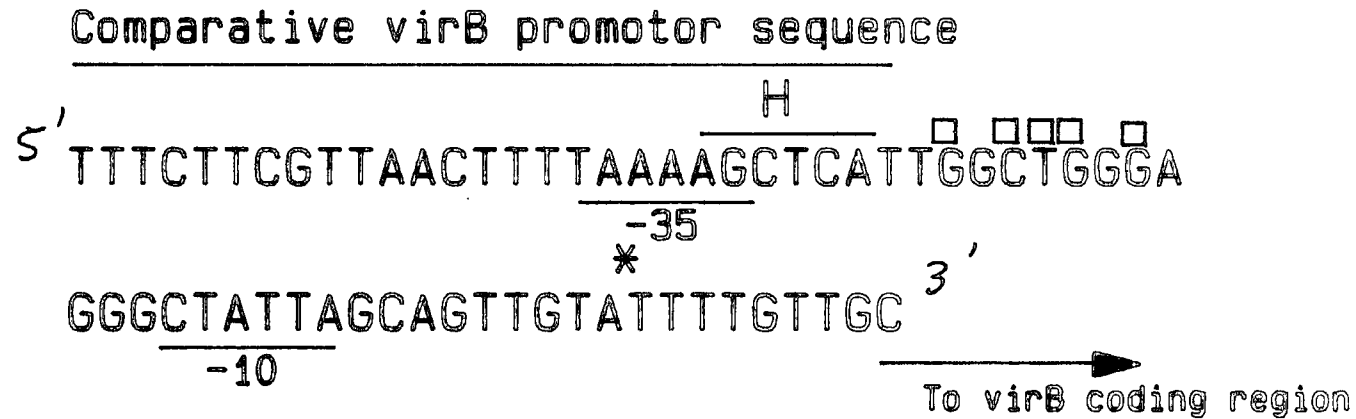
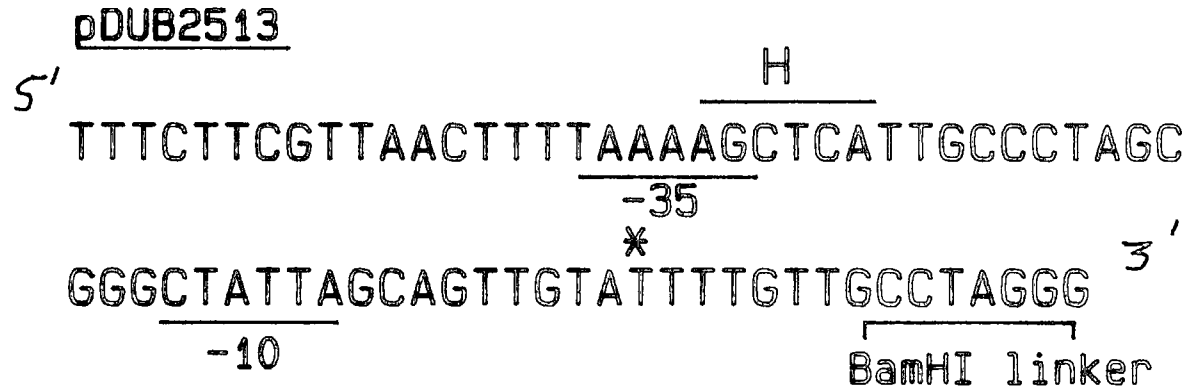
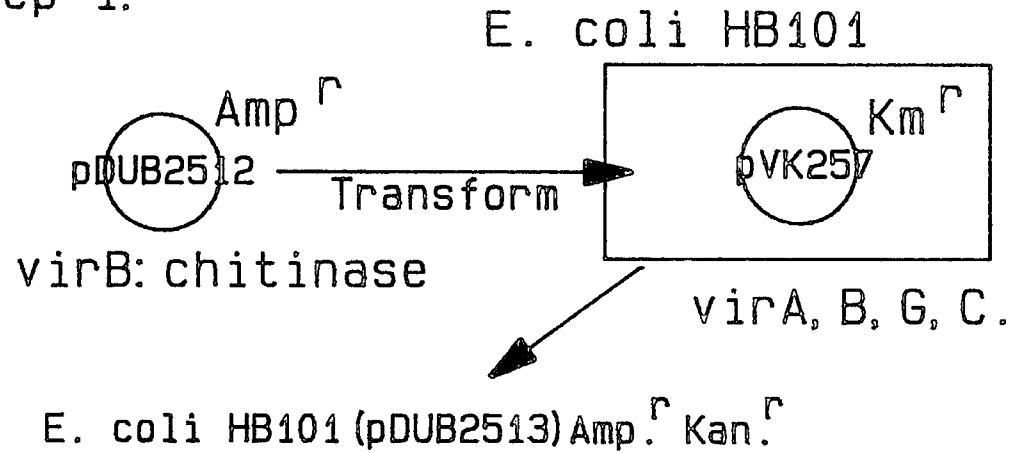
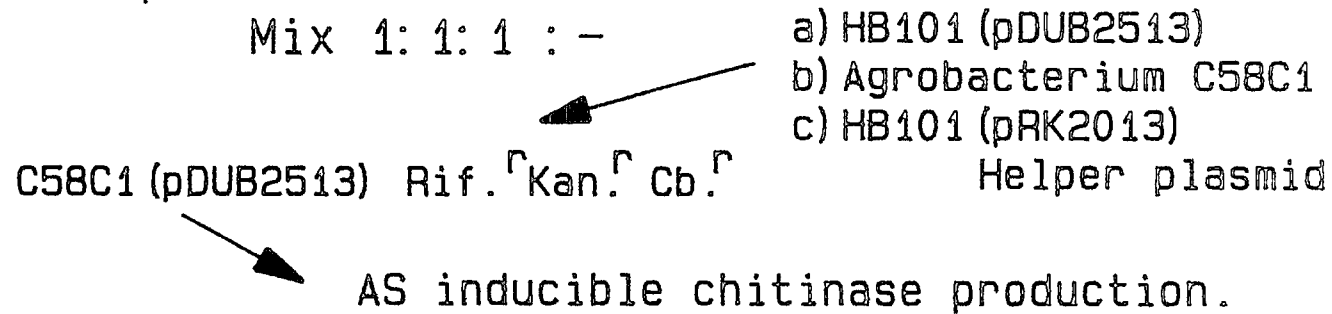

Figure 4.6.1

Step 1: -



Step 2: -



strain for the triparental mating.

4.6.2 Introducing the cointegrate into *A. tumefaciens* C58C¹.

An equal volume of *Agrobacterium* C58C¹ (Rif), *E. coli* HB101, and *E. coli* HB101(pDUB2512) were mixed and plated onto L-agar without antibiotic and incubated overnight at 28°C. The contents of the plate was diluted in 10⁻²M MgSO₄ and serial dilutions plated onto L-Rif/Km/Cb to select for transconjugants. In *Agrobacterium*, carbenicillin is preferred rather than ampicillin and is therefore substituted in crosses requiring ampicillin selection. Donor strains and the recipient strain were individually plated onto L- Rif/Km/Cb and no growth was observed. The numbers of donor and recipients in the mix was calculated by plating dilutions onto L-Km (for HB101 pRK2013), L-Km/Amp (for HB101 pDUB2512) and L-Rifampicin (for *A. tumefaciens* C58C¹).

From a cross of approximately 1x10¹⁰ donor and 1x10¹⁰ recipient cells, 4x10⁴ transconjugants were obtained giving a conjugation efficiency of 4 transconjugants per 10000 parental cells. 8 presumptive transconjugants were plated onto fresh L-Rif/Km/Cb plates and incubated at 28°C for 48 hours (figure 4.6.1).

The resultant *Agrobacterium* strain harbouring pDUB2512 and pVK257 as a cointegrate plasmid was designated C58C¹(pDUB2513).

4.6.3 3-Keto-lactose assay for *Agrobacterium* species.

Agrobacteria have several unusual biochemical activities which prove useful in their identification, one being the production of 3-keto-monosaccharides or -disaccharides (251).

The 8 purified transconjugants, *A. tumefaciens* C58C¹ and *E. coli* HB101 were assayed for 3-keto-lactose production following the method of Bernaerts and De Ley (251) as described in the materials and methods chapter.

All of the transconjugants gave a positive result and therefore the cointe-

grate, pDUB2513 had been successfully introduced into *Agrobacterium* (figure 4.6.3).

4.7 Chemotaxis of C58C¹(pDUB2513) towards acetosyringone and monocot and dicot homogenates.

A motile population of *Agrobacterium tumefaciens* C58C¹(pDUB2513) was prepared and a bacterial suspension prepared for chemotaxis as described in chapter 2. The bacterial suspension was observed under a Nikon Optiphot microscope with phase contrast optics prior to performing the chemotaxis assay, and bacteria were found to be highly motile. A stock solution of acetosyringone (pH 7.0) was diluted in the range 10^{-5} to 10^{-8} M, and both wheat and kalanchoe shoot extracts were assayed at $120\mu\text{gml}^{-1}$ total protein. Chemotaxis medium (see materials and methods chapter) was used as the control.

The results (ref. figures 4.7.1 and 4.7.2) show that C58C¹ harbouring the *virB*-chitinase plasmid plus *virA* and G maintains the chemotactic trait towards acetosyringone. The chemotactic optimum being 10^{-6} M, a result comparable with that of the virulence mutants (76). The shift in chemotactic optimum may be a result of the manipulations incurred during the construction of the cointegrate plasmid or may simply be due to the fact that the full complement of virulence genes are not present, resulting in some modification at the receptor site.

Chemotaxis was also evident with both wheat and kalanchoe shoot extracts, with values comparable with the original Ti-plasmid containing strain, pDUB1003 Δ 31 (ref. figure 3.7.1).

4.8 Acetosyringone induced chitinase production in C58C¹(pDUB2513).

Having introduced the construct into *Agrobacterium* with the full complement of *vir* genes required for induction, it was of interest to see if expression of

Figure 4.6.3

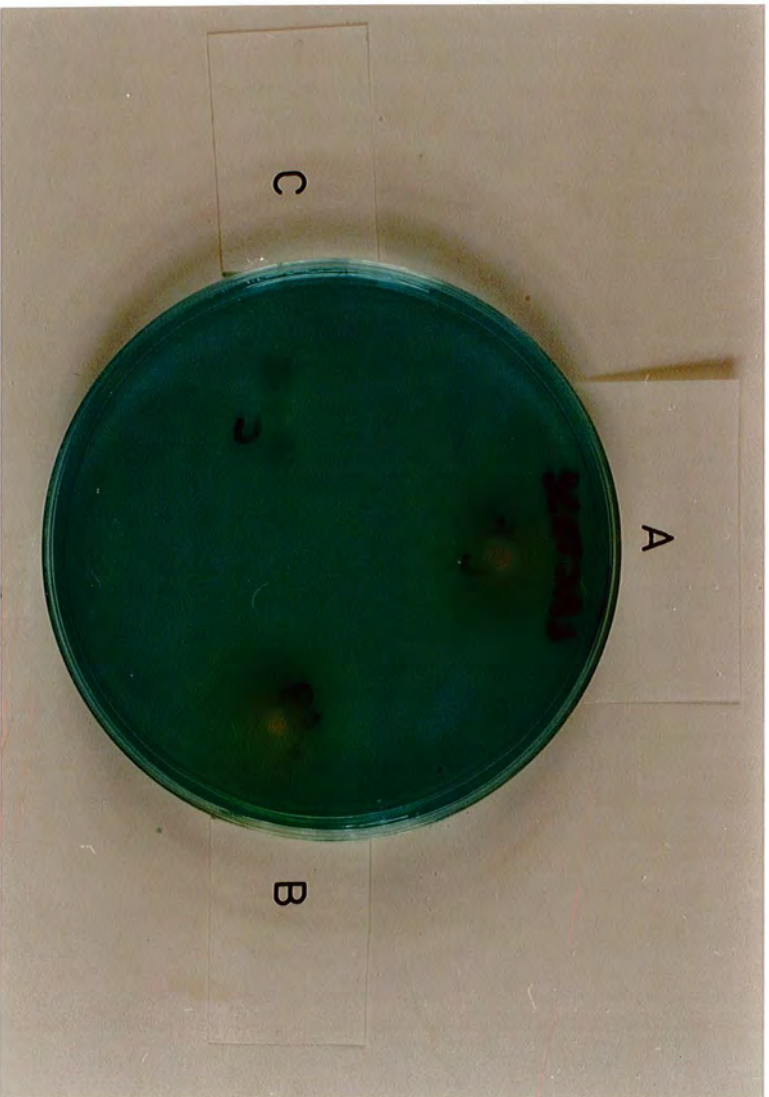
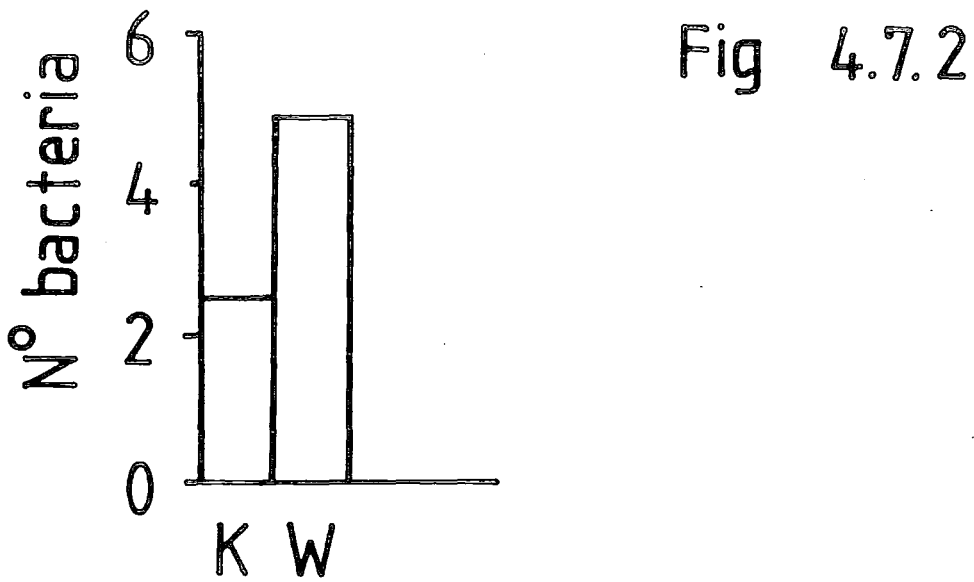
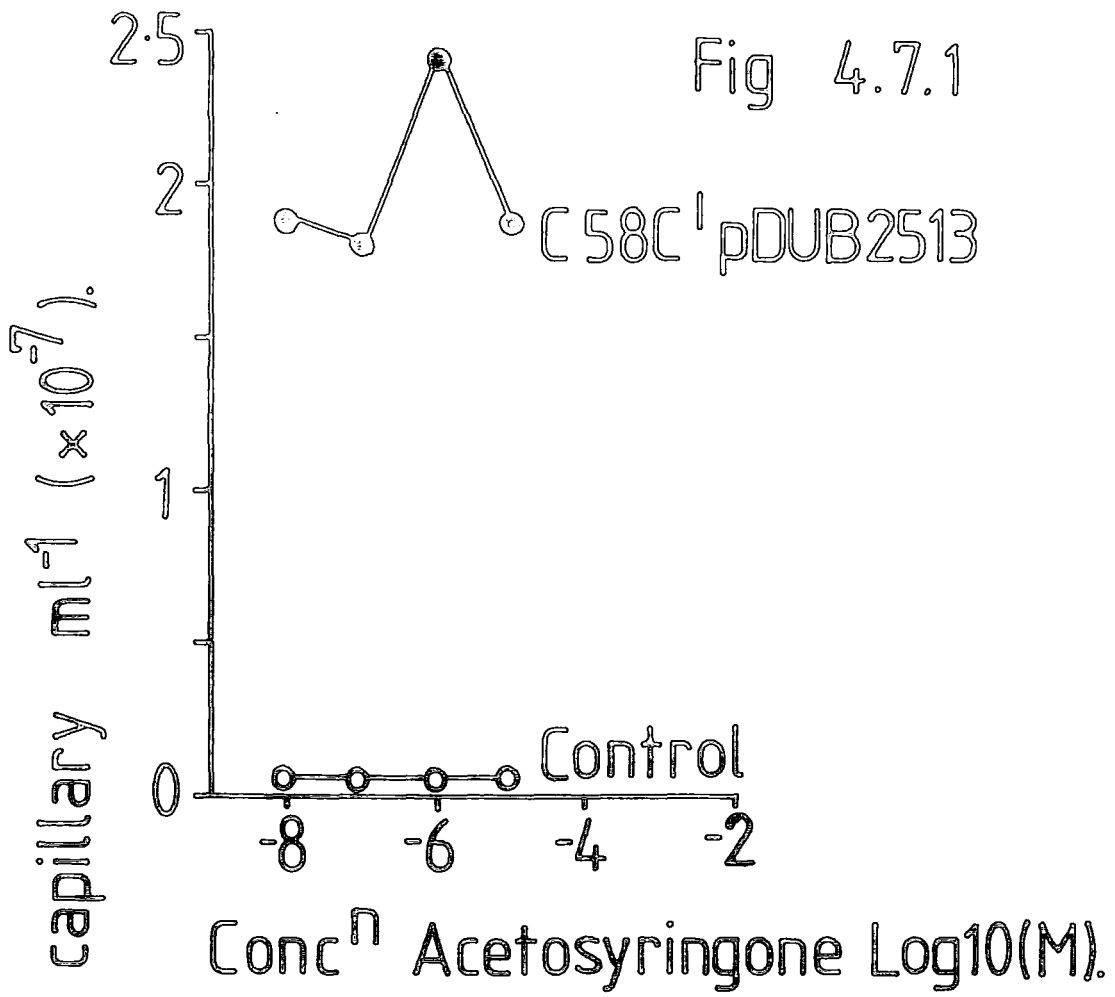

Figure 4.7.1 A dose response curve of motility of *A. tumefaciens* (pDUB2513) towards acetosyringone.

Figure 4.7.2 Chemotaxis of *A. tumefaciens* C58C¹(pDUB2513) towards shoot extracts of Wheat and Kalanchoe.



the cloned pesticidal gene was directly regulated by the presence of *vir*-inducible phenolics such as acetosyringone (AS). This was achieved in two ways :-

4.8.1 The plate method.

Agrobacterium tumefaciens C58C¹(pDUB2513), harbouring the *virB*-chitinase construct, and the isogenic strain, C58C¹ lacking a constructed plasmid, were plated onto MinA chitin agar (pH7.0) and MS medium plus chitin (pH5.7) (ref. chapter 2) and incubated at 28°C.

After 4 days of incubation, a zone of clearing was evident around the C58C¹(pDUB2513) streak on MinA chitin (pH7.0) plus AS but not on MinA chitin alone. No zone of clearing around C58C¹(pDUB2513) was evident on either of the MS chitin plates at pH5.7. The isogenic strain lacking the construct showed no signs of clearing throughout the incubation period on either of the chitin media, with and without AS. Figure 4.8.1 shows the results obtained with MinA chitin (pH7.0) plus and minus AS.

4.8.2 Hydrolysis of the chromogenic trisaccharide analogue p-nitrophenyl- β -D-N,N'-diacetylchitobiose.

Recently it was reported that the chromogenic compound p-nitrophenyl- β -D-N,N'-diacetylchitobiose was a suitable substrate for bacterial exochitinases (252). The exochitinolytic splitting of diacetylchitobiose results in the liberation of p-nitrophenol. The amounts of p-nitrophenol liberated being measured directly from absorbance readings at 405nm.

An overnight suspension of *Agrobacterium tumefaciens* C58C¹(pDUB2513) was grown in both MinA and MS liquid media (see chapter 2) plus antibiotics at 28°C in a shaking water bath. Approximately 1.5mls of bacteria were taken from the MinA overnight and the MS overnight to 100mls of fresh MinA plus antibiotic and fresh MS plus antibiotic, respectively, and allowed to grow to exponential phase at 28°C with shaking. Once the bacterial suspensions had

Fig 4.8.1

A



B



reached exponential phase the samples were split 50:50. Acetosyringone was added at a concentration of 10^{-4} M to one flask from each media type and the time recorded as time 0 for induction. Samples were taken over a 24hour period and supernatants assayed for chitinase activity (refer to chapter 2).

Again no activity was observed in MS media plus and minus AS (pH5.7). However, this was not the case in MinA medium (pH7.0). When AS was present in the medium, C58C¹(pDUB2513) was producing chitinase activity within 8 hours of induction. This activity had increased dramatically after 24 hours when compared with the activity produced by the same strain in MinA medium only (figure 4.8.2).

The total protein value of C58C¹(pDUB2513) supernatant after 24 hours induction with AS was determined using the micro plate assay (as described in materials and methods) and calculated at approximately $15\mu\text{gml}^{-1}$. The total protein readings for C58C¹(pDUB2513) in MinA medium minus AS, MS medium plus AS and MS medium minus AS were $3.5\mu\text{gml}^{-1}$, $4.5\mu\text{gml}^{-1}$ and $4.5\mu\text{gml}^{-1}$, respectively.

These results along with the qualitative plate observation clearly demonstrate that expression and secretion of the *virB* linked chitinase gene is regulated by the presence of *vir*-inducing phenolic compounds such as acetosyringone and that induction is observed at pH7.0 and not pH5.7.

4.9 Discussion.

Conventional methods of applying pesticides such as fungicides and insecticides to plants suffer the disadvantage that precise application to the desired location is somewhat impractical and therefore pesticides are often applied by spraying in a widespread and haphazard manner. The result being that often more pesticide has to be introduced into the environment than would be necessary if the pesticide were applied accurately, in the location of the plant and

Figure 4.8.2

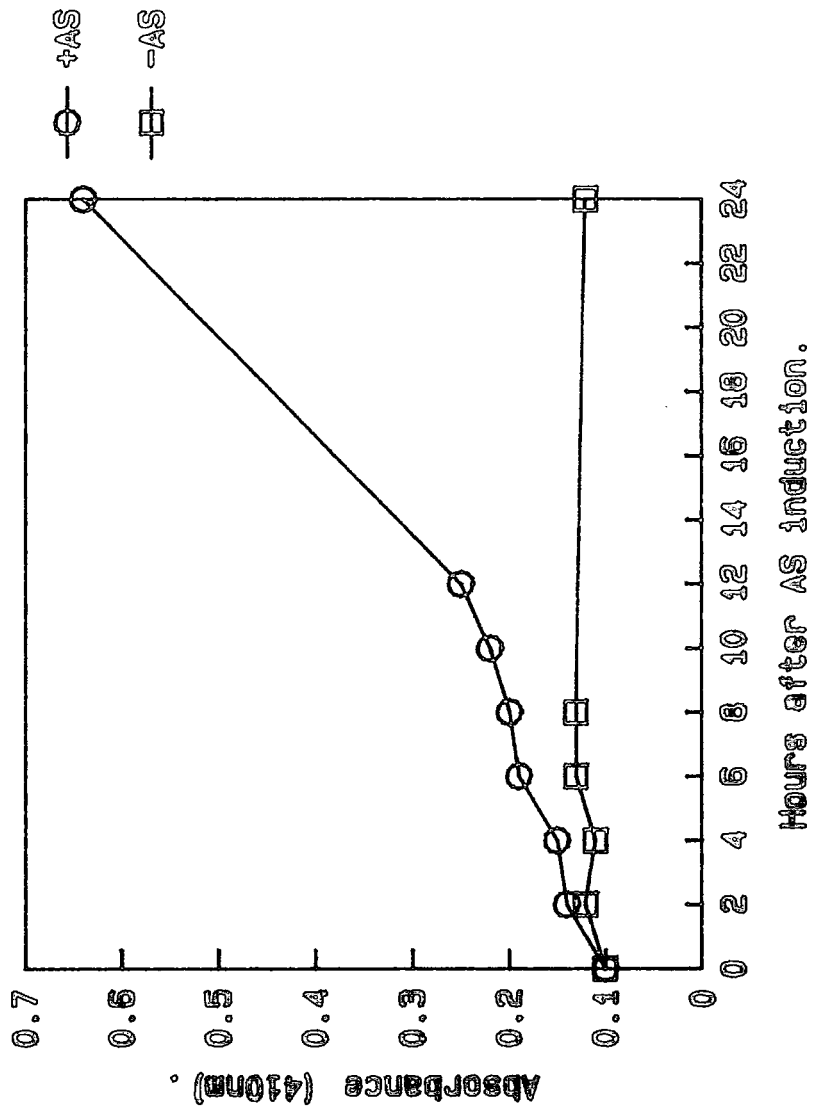

released only in the event of plant attack by pests.

The idea for the plant treatment method resulted from the discovery that *Agrobacterium tumefaciens* exhibited a chemotactic response towards several plant metabolites including a range of the *vir*-inducing phenolic compounds such as acetosyringone. This discovery, along with information available on *vir*-induction allowed the formulation of a possible application of the chemotactic process in crop protection.

The idea concerns bacteria that can detect and respond to very low concentrations of plant wound exudate by moving chemotactically to the site of the wound and once there; producing a pesticidal material under the control of a virulence gene promoter, as a result of *vir* induction by high concentrations of phenolic wound exudate (figure 4.1).

The main advantage of this system is that pesticide will be produced only when required at the desired location. In this way the system is conservative and also avoids the inefficiency of previous conventional methods.

The *vir* promoter-pesticide cassette will be active for many crop species, of both monocot and dicot origin since chemotaxis (239), and indeed the presence of *vir*-inducing compounds (243) have been identified in both plant types. This system therefore offers several advantages over the transgenic plant system which, at present requires the manipulation of each plant type before application in a biocontrol system and also is limited in that expression of pesticidal material is generally constitutive and also systemic.

In constructing the *virB*-pesticide cassette, the choice of pesticidal protein was rather wide in that a whole range of pesticidally active enzymes are known (262). These include chitinases, glucanases and mannanases which are enzymes capable of digesting fungal cell walls. Other pesticidally active substances include the δ -endotoxin from *Bacillus thuringiensis*, active against the *Lepidoptera*

as well as siderophores which can prevent the growth of pathogens by chelating iron from the environment around the plant.

Chitinase was chosen as the pesticidally active substance for the initial construct for three main reasons :- a) much literature was available on chitinases, b) *Serratia marcescens* produced several highly active chitinases, two of which had been recently cloned, and c) there were both qualitative and quantitative assays available to evaluate chitinase activity.

4.9.1 The chitinase of *Serratia marcescens*.

Serratia marcescens is one of the most active organisms for the production of chitinase (264). The enzyme system in *S. marcescens* is extracellular and is thought to be composed of three main factors; a) a factor responsible for the hydrolysis of crystalline chitin, b) chitinases which function to degrade accessible chitin into component subunits of the monomer, N-acetyl glucosamine, and c) chitobiase which functions to break down the dimer chitobiose to liberate N-acetyl glucosamine (264).

Chitinases can be classified as either "exochitinases" or "endochitinases" depending on their mode of action upon chitin. Recently, Robbins *et. al.* proposed that exochitinase activity should be defined as the ordered release of successive diacetylchitobiose units from the non-reducing end of chitin chains, and that endochitinase activity be defined as the random cleavage at internal points in chitin chains (274). It was proposed that the differing modes of action of the two types of chitinase may account for the marked difference in antifungal activity (275).

Five chitinolytic proteins have been identified in *S. marcescens* and a 58 kilodalton chitinase found to be the most abundant (265). This protein was believed to function as an endochitinase (263,264), and thus its mode of action would enhance its effectiveness against both fungal and insect chitin (263,275). For

this reason, the 58kd endochitinase gene contained on the plasmid pCHIT1251 (263) was isolated and used in the *vir* promoter-pesticidal gene construct.

4.9.2 The *virB* promoter.

The *virB* promoter is one of the more highly expressed of the *vir* promoters and is solely inducible by plant phenolics via *virA* and G (266,276). It was therefore chosen as the most suited promoter for the cassette.

Controlled deletions of downstream promoter sequences (see section 4.4.3) resulted in a deleted fragment that lacked the -10 and transcriptional initiation sequences but had maintained the -35 region of the promoter. Therefore in order to correct this deletion and obtain an intact promoter sequence, a 32 mer oligonucleotide with the required sequence derived from published information was synthesized and linked to the deleted promoter fragment. In doing this, 5 bases within the -10 and -35 region were altered (ref. figure 4.5.1); 3 from purines to pyrimidines, 1 from a pyrimidine to a purine and one from the pyrimidine, thymidine to the pyrimidine, cytosine. Although 5 base changes were made, the distance between the -10 and -35 sequences remained constant and the -10 and -35 sequences were maintained. The two hexameric sequences which appear to be conserved in all of the *vir* inducible promoters (271) were not affected. The exact function of these hexameric sequences is unknown, however, it may seem feasible to predict that such conserved sequences have a regulatory role in controlling transcription by binding a positive regulator molecule (ie. the VirG protein). Such a hypothesis is supported by the evidence that short sequences upstream of the transcription initiation sites in the lactose, galactose and arabinose operons as well as sequences upstream of the bacteriophage lambda PL and PR promoters, have been implemented in positive regulation (277- 282).

4.9.3 The effect of pH on induction.

The pH optimum for induction of virulence promoters was believed to be pH5.7 (68), however, it has recently been demonstrated that this pH dependence appears only to apply for octopine Ti-plasmids and not plasmids of the nopaline type (283). In view of the fact that the *virB* promoter was derived from an octopine type Ti-plasmid (276) one would predict that the promoter would be highly pH dependent and that maximum chitinase production would occur at pH5.7. However, this was not the case. At pH5.7 in both MinA and MS media, no chitinase activity was evident, whereas at pH7.0 in MinA medium, chitinase was produced when the *virB* promoter was induced by acetosyringone. When the control strain A348(pSM30) was plated onto MinA plus and minus acetosyringone at both pH5.7 and pH7.0, induction was evident in both cases when inducer was present. This suggests that the pH dependent response observed in MS medium plus acetosyringone (276) does not hold in MinA medium. Although this result explains why chitinase production was evident at pH7.0, it does not account for the lack of chitinase production at pH5.7. One prediction would be that the loss of activity at pH5.7 may have resulted from instability of the enzyme in MinA medium at this pH, however, under optimum conditions for activity, pure enzyme has been demonstrated to be stable (264,284). To check this hypothesis, *Serratia marcescens* was plated onto MinA chitin at pH7.0 and pH5.7. The results clearly demonstrated that the control organism produced chitinase only at pH7.0 in the medium used. In fact, *S. marcescens* not only lacked the ability to produce chitinase but also lacked the ability to produce red pigmentation, however, growth of the organism was not affected. Therefore, the most favourable explanation for loss of chitinase activity at pH5.7 is that native state, unpurified chitinase is not stable at this pH.

It seems unlikely that the modifications made to the *virB* promoter sequence on cloning (section 4.9.2 and figure 4.5.1) would have effected the pH profile

for induction since both hexameric sequences (271) are intact and the distance between the -35 and -10 regions remain constant. Although to date, there is no available evidence in the literature for pH mutations, this does not eliminate the possibility of their existence, and indeed may well offer an explanation for the observed pH shift for induction with C58C¹(pDUB2513). It may well be of interest to explore this possibility further.

4.9.4 Introducing the constructs into *Agrobacterium*

4.9.4.1 The mark 01 and 02 strains.

S. marcescens is a Gram-negative soil bacterium that is closely related to *E. coli*. It seemed feasible to predict that *S. marcescens* may also be closely related to *Agrobacterium* at that expression of cloned genes from *S. marcescens* should therefore be possible in *Agrobacterium* species.

The final *virB*-chitinase cassette (figure 4.6.1) contained *Agrobacterium* sequences up to the transcriptional initiation codon which included the -35 and -10 regions from the *Agrobacterium* promoter; and the Shine Dalgarno, translational initiation and coding sequences from the *S. marcescens* chitinase.

Synthesis of a functional protein depends on three main processes; namely, transcription of the appropriate gene, efficient translation of the mRNA and, in many cases, post-translational processing of the nascent polypeptide (ie cleavage of a signal sequence whose function is to direct the protein through the cell membrane).

The main limits on synthesis of chitinase from the *virB*-chitinase cassette were not with the transcriptional process since *Agrobacterium*'s own RNA Polymerase should function to recognize the *virB* promoter sequences. Problems at the translational level were not envisaged since the Shine Dalgarno sequence from the *S. marcescens* chitinase was almost identical to the Shine Dalgarno sequence from *virB*, sharing a common sequence of " AAGGA " (79,263) and

having an almost identical number of bases prior to the translational start codon. For this reason it seemed feasible to predict that this sequence would be recognized by the 16s ribosomal RNA sequences from *Agrobacterium*. The main concern was that post-translational modification (ie ineffective cleavage of the signal sequence or degradation of the nascent polypeptide) may be affected in the *Agrobacterium* system, possibly resulting in an inactive chitinase enzyme.

In order to assess this possibility, the mark 01 and 02 constructs were assembled and introduced into *Agrobacterium* (refer to section 4.2). Clearing of chitin plates confirmed that no post-translational defects were evident and that it was viable to introduce the mark 1 construct into *Agrobacterium*.

4.9.4.2 The mark 1 construct.

Having confirmed that the chitinase gene from *S. marcescens* could be successfully expressed in *Agrobacterium tumefaciens*, the next step was to introduce the inducible *virB*-chitinase construct into *Agrobacterium* harbouring both *virA* and G and to ensure that chitinase expression was observed only in the presence of *vir*-inducing phenolics such as acetosyringone.

This was achieved by relying on a homologous recombination event between pVK257 and pDUB2513 at the *virB* sequences (refer to section 4.6.2). pDUB2513 does not have the ability to replicate in *Agrobacterium* and therefore in the event of conjugation into *Agrobacterium*, the plasmid would be lost. However, if such a plasmid formed a cointegrate by homologous recombination with pVK257, the cointegrate plasmid would be transferred during the conjugation event and would be stably maintained under antibiotic selection. This was the criterion used in introducing the mark 1 construct into *Agrobacterium*.

Although it is difficult to predict, one may perceive that the cross-over resulting in the formation of the cointegrate occurred upstream of the mismatch caused by altering the 5 bases between the -35 and -10 regions of the promoter,

since there are approximately 470 matched bases in this region at which a cross over event could occur.

One major disadvantage of such a cointegrate plasmid is that one would predict that it would be highly unstable without antibiotic selection. For this reason it would be advantageous to clone both the *virA* and *virG* genes, and the *virB*-chitinase cassette onto a broad host range non-oncogenic plasmid capable of replicating in *Agrobacterium* (ie pGV1106 (268)). A second modification would be to clone the *virA*, *virG* and *virB*-chitinase cassette into the chromosome of *Agrobacterium*. In this way the construct would be more stable and the risks of transfer to other agrobacteria are reduced.

4.9.5 The predicted effectiveness of the *virB*-chitinase construct against fungi and insect pests.

It was originally believed that the 58KD protein isolated from *Serratia marcescens* was an endochitinase (263,264) and therefore cleaved chitin at random sites within the chain. The chitinase was shown to be highly effective against *Fusarium oxysporum* infection of pea plants (263). It therefore seemed reasonable to predict that this chitinase would be as effective when linked up to the *virB* promoter from *Agrobacterium*. However, recent evidence has shown that the 58KD chitinase from *S. marcescens* is in fact an exochitinase (252) and probably would only be effective if other components of the chitinase system were present. Indeed, the results obtained with the p-nitrophenyl- β -D-N,N'-diacetylchitobiose test (refer to section 4.8.2) on *Agrobacterium tumefaciens* C58C¹(pDUB2513) suggested that the protein was an exochitinase (252,274). It has yet to be seen if this construct is effective against fungal and insect pests, however, there are many more pesticidally active genes that could be inserted next to the *virB* cassette which may prove to be of more value. These include the δ endotoxin from *Bacillus thuringiensis*, endochitinases from plant or bacterial sources, as well as combinations of pesticidal genes.

It may be that the chitinase gene from pCHIT310 will prove to be more active against fungi and insects in view of the fact that it is distinctly different from the chitinase of pCHIT1251.

4.9.6 Chemotaxis of C58C¹(pDUB2513).

The chemotactic trait towards acetosyringone was maintained due to the presence of the *virA* and G proteins, both of which are essential for this specific response (76).

The results presented in this chapter have demonstrated that pesticidally active genes can be linked to virulence gene promoters, the effect being that expression of such linked pesticidal proteins occurs only in the presence of *vir*-inducing compounds such as acetosyringone.

The advantage of this system over other biocontrol systems is that the production of pesticidal protein is regulated, pesticide being produced only when and where it is needed. For this reason, the process is conservative, reducing the energy constraint placed on the bacterium.

Chapter 5
A summary

Chapter.5 A summary.

Until recently it was believed that the initial stage in the *Agrobacterium*-plant interaction was binding of the bacterium to the surface of susceptible plant cells (15-18, 240). This hypothesis has a basic weakness in that it assumes either chance interaction with a wound site or permanent association with the plant source, implying the continual presence of agrobacteria in the microrhizosphere surrounding plant roots. However, this does not explain why agrobacteria are prevalent throughout the rhizosphere, constituting a common component of the soil microflora (10,11).

It was Schroth who first identified attraction of agrobacteria to roots (9). However, it has become apparent in the last 2 years as a result of this research that *Agrobacterium* has evolved a highly sensitive mechanism that is responsible for attracting and guiding it towards susceptible plant cells and one may envisage that this 'chemotactic process' is the missing link in the *Agrobacterium*:plant interaction. The chemotaxis machinery is encoded by both chromosomal (171) and Ti-plasmid genes (104,76,239), the latter evoking a highly specific interaction with plant phenolic compounds. Since less than 1% of agrobacteria present in the rhizosphere are virulent, Ti-plasmid enhanced chemotaxis would increase the competitive advantage of virulent over the majority of avirulent agrobacteria in an otherwise stressful environment. Furthermore, compounds identified so far as highly specific chemoattractants for virulent agrobacteria are monocyclic plant derived phenolics that are also classified as strong inducers of the Ti-plasmid virulence region and are therefore involved in *vir*-induction, the initial event leading to T-DNA transfer to the plant cell. This strong correlation between the *vir* inducing ability of a phenolic and Ti-plasmid requirement for chemotaxis further emphasizes the relevance of bacterial:plant cell signalling in the *Agrobacterium*:plant interaction. Not surprisingly, other lignin components have been identified as *vir*-inducers. These include compounds such as



coniferyl alcohol and 2'4'4'-trihydroxy-3-methoxy chalcone (E.W. Nester, personal communication) which are both involved in the phenyl propanoid pathway of lignin biosynthesis. It would be of interest to analyse these 'new' inducers as chemoattractants for *Agrobacterium* and indeed to look more closely at lignin biosynthesis and identify further compounds which function both as inducers and chemoattractants of Ti-plasmid harbouring strains. It may be that there are several other phenolic or non phenolic compounds that have yet to be included. Machida *et. al.* (243), recently reported that seeds of wheat and oats contained *vir* gene inducing substances which displayed different characteristics to the *vir* inducing phenolics so far identified (71,72). Such substances are large molecular weight compounds that when added to culture medium containing *Agrobacterium*, are degraded to form smaller subunits. One could hypothesize that it is in fact these smaller subunits, which may well be phenolic, that traverse the membrane of *Agrobacterium* and evoke the inducing *vir*-expression response.

Further analysis led to the discovery that *virA* and *virG* are the Ti-plasmid functions required for specific chemotaxis towards acetosyringone (76) and this suggests a bifunctional role for these two proteins. From this data one may infer that *virA* and G are responsible for specific chemotaxis towards all of the highly inducible phenolic compounds but as yet this has not been elucidated. The relative similarities between *virA* and *cheA* (75) are indicative of *virA* functioning as a chemoreceptor which may well utilize a methionine dependent MCP system. Certainly where chromosomally encoded taxes are involved, *Agrobacterium* appears to utilize this type of system (G.L. Loake, personal communication), and recent evidence from our laboratory is consistent with an MCP system operating for Ti-encoded chemotaxis towards acetosyringone (C.H.Shaw personal communication).

Chemotaxis in the *Enterobacteriaceae* has been well studied (128-170,174-

184), however, until very recently the underlying mechanism determining the flow of information from the chemoreceptor to the flagellar motor in bacterial chemotaxis was little understood. The discovery by Melvin Simon and coworkers (289) that information flow is governed by a phosphorylation cascade process has opened up the 'black box' of understanding that has existed between the binding a chemoeffector through to transducing the signal into flagellar rotation. The phosphorylation cascade involves the CheA, CheB, CheY and CheZ proteins (289,290). This information has revolutionized the understanding of the chemotactic signalling process occurring during chemotaxis in the *Enterobacteriaceae* and will undoubtedly be of much value when such systems are evaluated in *Agrobacterium* and other rhizosphere microorganisms. Indeed it has been demonstrated that other prokaryotic systems are regulated by phosphorylation cascades, one example being the regulation of glutamine synthase by phosphorylation of the NtrC protein by the NtrB kinase (292). Amino acid sequence homologies between CheA, NtrB, and VirA are indicative of such proteins functioning in a similar fashion. However, from our understanding of the function of the VirA protein in both chemotaxis (76) and gene expression (73) it would appear that *virA* combines both *cheA* and *ntrB* functions.

Molecular recognition within the rhizosphere is of utmost importance and relevance to bacterial-plant interactions. Movement in response to molecular signals originating from plants and indeed other microorganisms, has been demonstrated (187-195), and some rhizosphere bacteria have been shown to move distances as great as 160cm in the soil (195). *Agrobacterium* has evolved a highly sensitive chemotaxis system capable of responding to low concentrations of sugars (171) as well as low concentrations of *vir*-inducible phenolic compounds (104,239); the latter response being highly specific, occurring only in strains harbouring the virulence genes; A and G. This highly sensitive response developed by *Agrobacterium* may best be explained by the paucity of nutrients available within the rhizosphere niche. Indeed, rhizobacteria may well

have evolved such highly sensitive and therefore, possibly more highly developed chemotaxis systems as a method of overcoming the limitations imposed by the rhizosphere. Certainly in *Rhizobium* and *Pseudomonas* (both of whom share many similarities with *Agrobacterium*), a more complex flagellar structure is evident (172), suggestive of a more highly evolved system.

Chemotaxis in the rhizosphere has an ecological relevance since it is a process which allows microorganisms to migrate to the site of a host source, by recognizing minute levels of chemoeffective signals released by the host in a highly limiting environment. The highly sensitive chemotaxis response evoked by rhizobacteria such as *Agrobacterium* and *Rhizobium* may well be of far greater relevance to microbial ecology than the more weakly sensitive system demonstrated by the "gut bacteria"; *E.coli* and *S.typhimurium*. In the latter case, the bacteria respond to concentrations of chemoattractant consistent with concentrations of substrates that would be experienced in the confines of the gut. However, within the gut there is constant muscular contraction and therefore constant movement of metabolites, suggesting that the chemotaxis phenomenon, although requiring around 2% of total cell protein (293), would be of only secondary importance. Conversely, responses observed with *Agrobacterium* are realistic in view of the paucity of nutrients within their niche and the fact that movement would be essential in order to get to the source of nutrient. Chemotaxis within the rhizosphere therefore appears to play a primary role in bacterial:plant interactions. For this reason, the importance of studying the chemotactic phenomenon in the rhizobacteria is paramount.

Signalling events occurring between microorganisms and between microorganism and host are instrumental in the formation of a complex network of interactions within the rhizosphere. A greater understanding of such interactions will allow the application of such events for crop benefit.

Several interactions are currently being developed for this purpose (Ref.

Chapter 1), these include:- the use of *Agrobacterium* as a natural biological control agent against crown gall; *Rhizobium* for increased nodulation; plant growth promoting *Pseudomonads*; and indeed several fungi as natural biological control agents of insects and mites.

Advances in molecular genetics have resulted in the manipulation of certain natural biological control agents to increase their competitive advantage as crop protectants. However, most biocontrol systems developed by such manipulations are based on using the organism solely as a vehicle. Although such systems are capable of delivering pesticidal material and therefore act as biocontrol agents, the main flaw is that the system is constitutive for pesticide production and therefore cannot be regulated. The biocontrol idea presented in this thesis is a unique regulated biocontrol system and it is hoped that it is the first of many refined and elegant methods of microbial biological control. Many interesting pesticidal genes are available and with a greater understanding of molecular recognition in the rhizosphere situation, the development of regulated biocontrol systems will pave the way for crop protection in the future.

References

References

1. Smith, E.F., and Townsend, C.O. (1907). *Science*, **25**, 671.
2. Conn, H.J. (1942). *J. Bact*, **44**, 353.
3. Riker, A.J., Banfield, W.M., Wright, W.H., Keitt, G.W., and Sagen, H.E. (1930). *J. Agr. Res*, **41**, 507.
4. Hildebrand, E.M. (1940). *J. Agr. Res*, **61**, 685.
5. Lippincott, J.A., Lippincott, B.B., and Starr, M.P. (1978) *The Bacteria*. Chapter 68.
6. Kesters, K., De Ley, J., Sneath, P.H.A., and Sackin, M. (1973). *J. Gen. Micro*, **78**, 227.
7. Patel, M.K. (1929). *Phytopathology*, **19**, 295.
8. New, P.B., and Kerr, A. (1972). *J. App. Bact*, **35**, 279.
9. Schroth, M.N., Weinhold, A.R., McCain, A.H., Hildebrand, D.C., and Ross, N. (1971). *Hilgardia*, **40**, 537.
10. Kerr, A. (1969). *Aust. J. Biol. Sci*, **22**, 111.
11. Kerr, A. (1974). *Soil Science*, **188**, 168.
12. De Cleene, M. (1988). *FEMS*, **54**, 1.
13. Nester, E.W., Gordon, M.P., Amasino, R.M., and Yanofsky, M.F. (1984). *Ann. Rev. Pl. Physiol*, **35**, 387.
14. Schafer, W., Gorz, A., and Kahl, G. (1987). *Nature*, **327**, 529.
15. Lippincott, B., and Lippincott, J.A. (1969). *J. Bact*, **97** 620.
16. Lippincott, J.A., and Hebeulein, G.T. (1965). *Am. J. Bot*, **52**, 856.
17. Lippincott, J.A., and Lippincott, B.B. (1978). *Science*, **199**, 1075.
18. Lippincott, J.A., Lippincott, B.B., and Scott, J.J. (1984).

- In M. J. Klug and C. N. Reddy (ed), Current perspectives in microbial ecology. American Society for Microbiology, Washington, D.C. p230.
19. Whatley, M.H., Lippincott, B.B., and Lippincott, J.A. (1976).
Abstr. Annu. Meet. Am. Soc. Microbiol. B8 p 12.
 20. Kluepfel, D.A., and Pueppke, S.G. (1985). *App. Env. Micro*,
49(6), 1351.
 21. Kluepfel, D.A., and Pueppke, S.G. (1986). *App. Env. Micro*,
51(5), 1130.
 22. Deasey, M.C., and Matthyse, A.G. (1984). *Phytopathology*,
74, 991.
 23. Matthyse, A.G. (1983). *J. Bact*, 154, 906.
 24. Matthyse, A.g., Holmes, K.V., and Gurlitz, R.H.G. (1981).
J. Bact, 145, 583.
 25. Ohyama, K., Pelcher, L.E., Schaefer, A., and Fowke, L.C. (1979)
Plant. Physiol, 63, 382.
 26. Matthyse, A.G., Holmes, K.V., and Gurlitz, R.H.G. (1982).
Physiol. Plant. Pathol, 20, 27.
 27. Hisamatsu, M., Amemura, A., Matsuo, T., Matsuda, H., and Harda,
T. (1982). *J. Gen. Micro*, 128, 1873.
 28. Matthyse, A.G., and Steele, E. (1984). *Phytopathology*,
74, 834.
 29. Douglas, C.J., Staneloni, R.J., Rubin, R.A., and Nester, E.W.
(1985). *J. Bact*, 161, 850.
 30. Zorreguita, A., Geremia, R.A., Cavaignac, S., Cangelosi, G.A.,
Nester, E.W., and Ugalde, R.A. (1988). *Molec. Plant. Microbe. Int*
(submitted).
 31. Marks, J.R., Lynch, T.J., Karlinsey, J.E., and Thomashow, M.
F. (1987). *J. Bact*, 169, 5835.
 32. Douglas, C.J., Halperin, W., Gordon, M., and Nester, E.W.

- (1985). *J. Bact.* **161**, 764.
33. Draper, J., Mackenzie, I.A., Davey, M.R., and Freeman, J.P. (1983). *Plant. Sci. Lett.* **29**, 227.
34. Matthyse, A.G., and Gurlitz, R.H.G. (1982). *Physiol. Plant. Pathol.* **21**, 381.
35. Unger, L., Ziegler, S.F., Huffman, G.A., Knauf, V.C., Peet, R., Moore, L.W., Gordon, M.P. and Nester, E.W. (1985). *J. Bact.* **164**, 723.
36. Farrand, S.K., and Dessaux, Y. (1986). *J. Bact.* **167**, 732
37. Guyon, P., Chilton, M-D., Petit, A., and Tempe, J. (1980). *Proc. Natl. Acad. Sci. USA*, **77**, 2693.
38. Ellis, J.G., and Murphy, P.J. (1981). *Mol. Gen. Genet.* **181**, 36.
39. Chang, C.C., Chen, C-M., Adams, B.R., and Trost, B.M. (1983) *Proc. Natl. Acad. Sci. USA*, **80**, 3573.
40. Sciaky, D., Montoya, A.L., and Chilton, M-D. (1978). *Plasmid*, **1**, 238.
41. Knauf, V.C., Panagopoulos, C.G., and Nester, E.W. (1983). *J. Bact.* **153**, 1535.
42. Chilton, M-D., Tepfer, D.A., Petit, A., David, C., Casse-Delbart, F., and Tempe, J. (1982) *Nature*, **295**, 432.
43. Slota, J.E., and Ferrand, S.K. (1982). *Plasmid*, **8**, 175.
44. Perry, K.L., and Kado, C.I. (1982). *J. Bact.* **151**, 343.
45. Holsters, M., Villarroe, R., Gielen, J., Seurinck, J., De Greve, H., Van Montagu, M., and Schell, J. (1983). *Mol. Gen. Genet.* **190**, 35.
46. Shaw, C.H., Watson, M.D., Carter, G.H., and Shaw, C.H. (1984). *Nucl. Acids. Res.* **12**(15), 6031.
47. Wang, K., Herrera-Estrella, L., Van Montagu, M., and Zambryski,

- P. (1984). *Cell*, **38**, 455.
48. Peralta, E.G., Hellmiss, R., and Ream, W. (1986). *EMBO. J.*, **5**(6), 1137.
49. Slightom, J.L. (1985). *EMBO. J.*, **4**, 3069.
50. De Beuckeleer, M., De Block, M., De Greve, H., Depicker, A., De Vos, R., De Vos, G., De Wilde, M., Dhæse, P., Dobbelaere, M.R., Engler, G., Genetello, C., Hernalsteens, J-P., Holsters, M., Jacobs, A., Schell, J., Seurinck, J., Silva, B., Van Haute, E., Van Montagu, M., Van Vliet, F., Villarroel, R., and Zaenen, I. (1978). *Proc. Int. Conf. Plant. Pathog. Bact.* 4th, 115
51. Lemmers, M., De Beuckeleer, M., Holsters, M., Zambryski, P., Depicker, A., Hernalsteens, J-P., Van Montagu, M., and Schell, J. (1980). *J. Mol. Biol.* **144**, 353.
52. Zambryski, P., Holsters, M., Kruger, K., Depicker, A., Schell, J., Van Montagu, M., and Goodman, H. (1980). *Science*, **209**, 1385.
53. Chilton, M-D., Drummond, M.H., Merlo, D.J., Sciaky, D., Montoya, A.L., Gordon, M.P., and Nester, E.W. (1977). *Cell*, **11**, 263.
54. Merlo, D.J., Nutter, R.C., Montoya, A.L., Garfinkel, D.J., Drummond, M.H., Chilton, M-D., Gordon, M.P., and Nester, E.W. (1980). *Molec. Gen. Genet.*, **177**, 637.
55. Thomashow, M.F., Nutter, R., Montoya, A.L., Gordon, M.P., and Nester, E.W. (1980). *Cell*, **19**, 729.
56. De Beuckeleer, M., Lemmers, M., De Vos, G., Willmitzer, L., Van Montagu, M., and Schell, J. (1981). *Molec. Gen. Genet.*, **183**, 283.
57. Ooms, G., Bakker, A., Molendijk, L., Wullems, G.J., Gordon, M.P., Nester, E.W. and Schilperoort, R.A. (1982). *Cell*, **30**, 589.

58. Van Onckelen, H., Prinsen, E., Inze, D., Rudelsheim, P.,
Van Lijsebettens, M., Follin, A., Schell, J., Van Montagu, M., and
De Greef, J. (1986). *FEBS*, 198(2), 357.
59. Kemper, E., Waffenschmidt, S., Weiler, E.W., Rausch, T.,
and Schroder, J. (1985). *Planta*, 163, 257.
60. Buchmann, I., Marner, F.-J., Schroder, G., Waffenschmidt, S.,
and Schoder, J. (1985). *EMBO. J.*, 4(4), 853.
61. De Greve, H., Leemans, J., Hernalsteens, J.P., Thia-Toong,
L., De Benckleer, M., Willmitzer, L., Olten, L., Van Montagu, M.,
and Schell, J. (1982). *Nature*, 300, 752.
62. Depicker, A., Stachel, S., Dhaese, P., Zambryski, P.,
and Goodman, H.M. (1982). *J. Molec. Appl. Genet*, 1, 561
63. Nester, E.W., Gordon, M.P., Amasino, R.M., and Yanofsky, M.F.
(1984). *Ann. Rev. Plant. Physiol*, 35, 387.
64. Ream, L.W., Gordon, M.P., and Nester, E.W. (1983). *Proc. Natl.
Acad. Sci. USA*, 80, 1660.
65. Hille, J., Hoekema, A., Hoojkaas, P., and Schilperoort, R.
(1984). In D.P.S. Verma and T. Hohn (ed), *Plant gene research*.
Springer-Verlag, New York, p. 287.
66. Inze, D., Follin, A., Van Lijsebettens, M., Simoens, C.,
Genetello, C., Van Montagu, M., and Schell, J. (1984). *Mol. Gen.
Genet*, 194, 265.
67. Hooykaas, P.J.J., Hofker, M., den Dulk-Ras, H., and
Schilperoort, R.A. (1984). *Plasmid*, 11, 195.
68. Stachel, S.E., Nester, E.W., and Zambryski, P.C. (1986)
Proc. Natl. Acad. Sci. USA, 83, 379.
69. Close, T.J., and Kado, C.I. (1985). *J. Bact*, 164, 774.
70. Close, T.J., Rogowsky, P.M., Kado, C.I., Winans, S.C.,
Yanofsky, M.F., and Nester, E.W. (1987). *J. Bact*, 169, 5113.

71. Stachel, S.E., Messens, E., Van Montagu, M., and
Zambryski, P.C. (1985). *Nature*, **318**, 624.
72. Bolton, G.W., Nester, E.W., and Gordon, M.P. (1986).
Science, **232**, 983.
73. Stachel, S.E., and Zambryski, P.C. (1986). *Cell*, **46**, 325
74. Leroux, B., Yanofsky, M.F., Winans, S.C., Ward, J.E.,
Ziegler, S.F., and Nester, E.W. (1987). *EMBO J.*, **6**, 849.
75. Stock, A., Chen, T., Welsh, D., and Stock, J. (1988).
P.N.A.S. (USA), **85**, 141403.
76. Shaw, C.H., Ashby, A.M., Brown, A., Royal, C., Loake, G.J.,
and Shaw, C.H. (1988). *Molec. Microbiol.*, **2**(3), 413.
77. Melchers, L.S., Thompson, D.V., Idler, K.B., Schilperoort,
R.A., and Hooykaas, P.J.J. (1986). *Nuc. Acids. Res.*, **14**(24),
9933.
78. Winans, S.C., Ebert, P.R., Stachel, S.E., Gordon, M.P.,
and Nester, E.W. (1986). *Proc. Natl. Acad. Sci. USA*, **83**, 8278.
79. Ward, J.E., Akiyoshi, D.E., Reier, D., Datta, A., Gordon, M.P.,
and Nester, E.W. (1988). *J. Biol. Chem.* (in press).
80. Yanofsky, M.F., and Nester, E.W. (1986). *J. Bact.*, **168**,
244.
81. Close, T.J., Tait, R.C., Rempel, H.C., Hirooka, T., Kim, L.,
and Kado, C.I. (1987). *J. Bact.*, **169**, 2336.
82. Horsch, R.B. (1986). *Proc. Natl. Acad. Sci. USA*,
83, 2571.
83. Yanofsky, M.F., Porter, S.G., Young, C., Albright, L.M.,
Gordon, M.P., and Nester, E.W. (1986). *Cell*, **47**, 471.
84. Koukolikova-Nicola, Z., Shillito, R.D., Hohn, B., Wang, K.,
Van Montagu, M., and Zambryski, P.C. (1985). *Nature*, **313**, 191.
85. Stachel, S.E., Timmerman, B., and Zambryski, P.C. (1986).

Nature, 322, 706.

86. Young, C., and Nester, E.W. (1988). *J. Bact*, (submitted).
87. Stachel, S.E., and Zambryski, P.C. (1986). *Cell*, 47, 155.
88. Willets, N., and Wilkins, B. (1984). *Microbiol. Rev*, 48 24.
89. Buchanan-Wollaston, V., Passiatore, J.E., and Cannon, F. (1987). *Nature*, 328, 172.
90. Otten, L., De Greve, H., Leemans, J., Hain, R., Hooykaas, P., and Schell, J. (1984). *Mol. Gen. Genet*, 195, 159.
91. Christie, P.J., Ward, J.E., Winans, S.C., and Nester, E.W. (1988). *Cell*, (submitted).
92. Hille, J., Van Kan, J., and Schilperoort, R. (1984). *J. Bact*, 158, 754.
93. De Ley, J., Bernaerts, M., Rassel, A., and Guilmont, A. (1966). *J. Gen. Micro.* 43,7.
94. Vance, C.P. (1983). *Ann. Rev. Micro*, 37, 399.
95. Dylan, T., Ielpi, L., Stanfield, S., Kashyap, L., Douglas, C., Yanofsky, M., Nester, E.W., Helinski, D.R., Ditta, G. (1986). *Proc. Natl. Acad. Sci. USA*, 83, 4403.
96. Cangelosi, G.A., Hung, L., Puvanesarajah, V., Stacey, G., Ozga, D.A., Leigh, J.A., and Nester, E.W. (1987). *J. Bacteriol*, 169, 2086.
97. Martinez, E., Palacios, R., and Sanchez, F. (1987). *J. Bact*, 169, 2828.
98. Yelton, M.M., Mulligan, J.T., and Long, S R. (1987). *J. Bacteriol*, 169, 3094.
99. Hendson, M., and Thomson, J.A. (1986). *J. Appl. Bacteriol*, 60, 147.

100. Smit, G., Kijne, J.W., and Lugtenberg, B.J.J. (1987).
J. Bacteriol, **169**, 4294.
101. Flores, M., Gonzalez, V., Brom, S., Martinez, E.,
Pinero, D., Romero, D., Davila, G., and Palacios, R. (1987).
J. Bacteriol, **169**, 5782.
102. Murphy, P.J., Heycke, N., Banfalvi, Z., Tate, M.E., De
Bruijn, F., Kondorosi, A., Tempe, J., and Schell, J. (1987).
Proc. Natl. Acad. Sci. USA, **84**, 493.
103. Munoz Aguilar, J.M., Ashby, A.M., Richards, A.J.M., Loake, G.,
Watson, M.D., and Shaw, C.H. (1988). J. Gen. Micro. (submitted).
104. Ashby, A.M., Watson, M.D., and Shaw, C.H. (1987). FEMS
41,189.
105. Halverston, L.J., and Stacey, G. (1986). Microbiol.
Rev, **50**, 193.
106. Callaham, D.A., and Torrey, J.G. (1981). Can. J. Bot,
59, 1647.
107. Downie, J.A., Hombrecher, G., Ma, Q.S., Knight, C.D.,
Wells, B., and Johnston, A.W.B. (1983) M.G:G **190**, 359.
108. Schofield, P.R., Ridge, R.W., Rolfe, B.G., Shine, J.,
and Watson, J.M. (1984). Plant. Mol. Biol, **3**, 3.
109. Kondorosi, E., Banfalvi, Z., and Kondorosi, A. (1984)
Mol. Gen. Genet. **193**, 445.
110. Rossen, L., Davis, E.O., and Johnston, A.W.B. (1987).
TIBS **12**, 430.
111. Rossen, L., Johnston, A.W.B., and Downie, J.A. (1984).
Nuc. Acids. Res, **12**, 9497.
112. Fisher, R.F., Tu, J.K., and Long, S.R. (1985). App.
Env. Micro, **49**, 1432.
113. Schmidt, J., John, M., Weineke, U., Krussmann, H-D., and

- Schell, J. (1986). Proc. Natl. Acad. Sci. USA, 83, 9581.
114. John, M., Schmidt, J., Weineke, U., Kondorosi, E.,
Kondorosi, A., and Schell, J. (1985). EMBO. J, 4, 2425.
115. Evans, I.J., and Downie, J.A. (1986). Gene, 43, 95.
116. Sherman, C.A., Rossen, L., Johnston, A.W.B., and Downie, J.A.
(1986). EMBO. J, 5, 647.
117. Redmond, J.W., Bately, M., Djordjevic, M.A., Innes, R.W.,
Kuempel, P.L., and Rolfe, B.G. (1986). Nature, 323, 632.
118. Firmin, J.L., Wilson, K.E., Rossen, L., and Johnston, A.W.B.
(1986). Nature, 324, 90.
119. Follin, A., Budar, F., Genetello, C., Van Montagu, M., and
Schell, J. (1985). Mol. Gen. Genet, 201, 178.
120. Yamada, T., Palm, C.J., Brooks, B., and Kosuge, T. (1985).
Proc. Natl. Acad. Sci. USA, 82, 6522.
121. Beaty, J.S., Powell, G.K., Lica, L., Reigier, D.A.,
MacDonald, E.M.S., Hommes, N.G., and Morris, R.O. (1986). Mol. Gen.
Genet, 203, 274.
122. Akiyoshi, D.E., Reigier, D.A., and Gordon, M.P. (1987).
J. Bact, 169, 4242.
123. Roberto, F., Yamada, T., and Kosuge, T. (1986). In
Fallen Leaf Lake Conference Abstracts, September 11-14th, on
"The genus *Agrobacterium* and crown gall"
124. Pueppke, S.G. (1984). in Plant Microbe Interactions,
Molecular and Genetic Perspectives (Kosuge, T., and Nester, E.W.,
eds), Macmillan.
125. Patriquin, D.C., Dobereiner, J., and Jain, D.K. (1983).
Can. J. Microbiol, 29, 900.
126. Waelkens, F., Maris, M., Verreth, C., Vanderleyden, J.,
and Van Gool, A. (1987). FEMS 43, 241.

127. Wilson, E.O. (1965). *Science*, **153**, 1064.
128. Pfeffer, W. (1888). *Unters. Bot. Inst. Tubingen*, **2**, 582.
129. Adler, J. (1973). *J. Gen. Micro*, **74**, 77.
130. Springer, M.S., Goy, M.F., and Adler, J. (1979). *Nature*, **280**, 279.
131. Stewart, R.C., and Dahlquist, F.W. (1987). *Chem. Rev*, **87**, 997.
132. Berg, H.C., and Brown, D.A. (1972). *Nature*, **239**, 500.
133. Larsen, S.H., Reader, R.W., Kort, E.N., Tso, W.W., and Adler, J. (1974). *Nature*, **249**, 74.
134. Macnab, R.M., and Aizawa, S.-I. (1984). *Annu. Rev. Biophys. Bioeng*, **13**, 51.
135. Berg, H.C., and Tedesco, P.M. (1975). *Proc. Natl. Acad. Sci. USA*, **72**, 3325.
136. Block, S.M., Segall, J.E., and Berg, H.C. (1983). *J. Bact*, **154**, 312.
137. Hazelbauer, G.L. (1975). *J. Bact*, **122**, 206.
138. Mowbray, S.L., and Petsko, G.A. (1983). *J. Biol. Chem*, **258**, 7991.
139. Koman, A., Harayama, S., and Hazelbauer, G.L. (1979). *J. Bact*, **138**, 739.
140. Manson, M.D., Blank, V., Brade, G., and Higgins, C.F. (1986). *Nature*, **321**, 253.
141. Hazelbauer, G.L., and Harayama, S. (1983). *Int. Rev. Cytol*, **81**, 33.
142. Foster, D.L., Mowbray, S.L., Jap, B.K., and Koshland, D.E., Jr. (1985). *J. Biol. Chem*, **260**, 11706.
143. Adler, J., and Epstein, W. (1977). *Proc. Natl. Acad. Sci. USA*, **71**, 2895.

144. Pecher, A., Renner, I., and Lengeler, J. (1983). In mobility and recognition in cell biology; de Gruyter: Berlin, p517.
145. Krikos, A., Conley, M.P., Boyd, A., Berg, H.C., and Simon, M.I. (1985). *Proc. Natl. Acad. Sci. USA*, **82**, 1326.
146. Bollinger, J., Park, C., Harayama, S., and Hazelbauer, G.L. (1984). *Proc. Natl. Acad. Sci. USA*, **81**, 3287.
147. Krikos, A., Mutoh, N., Boyd, A., and Simon, M.I. (1983). *Cell*, **33**, 615.
148. Park, C., and Hazelbauer, G.L. (1986). *J. Bact*, **167**, 101.
149. Springer, W.R., and Koshland, D.E., Jr. (1977). *Proc. Natl. Acad. Sci. USA*, **74**, 3659.
150. Kondoh, H., Ball, C.B., and Adler, J. (1977). *Proc. Natl. Acad. Sci. USA*, **76**, 260.
151. Slocum, M.K., and Parkinson, J.S. (1985). *J. Bact*, **163**, 586.
152. Tso, W.-W., and Adler, J. (1974). *J. Bact*, **118**, 560.
153. Mesibov, R., and Adler, J. (1972). *J. Bact*, **112**, 315.
154. Higgins, C.F., and Gibson, M.M. (1986). *Methods Enzymol*, **125**, 365.
155. Kowai, O., and Hayashi, H.J. (1979). *J. Biochem. (Tokyo)*, **86**, 27.
156. Ordal, G.W., and Adler, J. (1974). *J. Bact*, **117**, 517.
157. Kleene, S.J., Toews, M.L., and Adler, J. (1977). *J. Biol. Chem*, **252**, 3214.
158. Van Der Werf, P., and Koshland, D.E., Jr. (1977). *J. Biol. Chem*, **252**, 2793.
159. Nowlin, D.M., Bollinger, J., and Hazelbauer, G.L. (1987). *J. Biol. Chem*, **262**, 6039.
160. Kehry, M.R., Bond, M.W., Hunkapiller, M.W., and

- Dalquist, F.W. (1983). *Proc. Natl. Acad. Sci. USA*, **80**, 3599.
161. Terwilliger, T.C., and Koshland, D.E., Jr. (1984). *J. Biol. Chem.*, **259**, 7719.
162. Stock, J.B., and Koshland, D.E., Jr. (1978). *Proc. Natl. Acad. Sci. USA*, **65**, 3659.
163. Boyd, A., and Simon, M.I. (1982). *Annu. Rev. Physiol.*, **44**, 501.
164. Ordal, G.W., and Nettleton, D.O. (1983). In *The Microbiology of the Bacilli*; Academic: New York; p53.
165. Goldman, D.J., Worobec, S.W., Siegel, R.B., Hecker, R.V., and Ordal, G.W. (1982). *Biochemistry*, **21**, 915.
166. Goy, M.F., Springer, M.S., and Adler. (1977). *Proc. Natl. Acad. Sci. USA*, **74**, 4964.
167. Silverman, M., and Simon, M.I. (1974). *Nature*, **249**, 73.
168. Manson, M.D., Tedesco, P., and Berg, H.C. (1980). *J. Mol. Biol.*, **138**, 541.
169. Kuwajima, G., Asaka, J.-I., Fujiwara, T., Fujiwara, T., Node, K., and Kondo, E. (1986). *J. Bact.*, **168**, 1479.
170. Joys, T.M. (1985). *J. Biol. Chem.*, **260**, 15758.
171. Loake, G.J., Ashby, A.M., and Shaw, C.H. (1988). *J. Gen. Micro.*, **134**, 1427.
172. Schmitt, R., Raska, I., and Mayer, F. (1974). *J. Bact.*, **117**, 844.
173. Gotz, R., and Schmitt, R. (1987). *J. Bact.* **169**, 3146.
174. Komeda, Y., Silverman, M., and Simon, M.I. (1978). *J. Bact.*, **133**, 364.
175. Suzuki, T., and Iino, T. (1981). *J. Bact.*, **148**, 973.
176. Ikeda, T., Homma, M., Iino, T., Asakura, S., and Kamiya, R. (1987). *J. Bact.*, **169**, 1168.

177. Jones, C.J., Homma, M., and Macnab, R.M. (1987). *J. Bact*, **169**, 1489.
178. Aizawa, S.I., Dean, G.E., Jones, C.J., Macnab, R.M., and Hamaguchi, S. (1985). *J. Bact*, **161**, 836.
179. Hilmen, M., and Simon, M.I. (1976). In cell motility, Cold Spring Harbour Laboratory: Cold Spring Harbour, NY, p35.
180. Silverman, M., and Simon, M.I. (1974). *J. Bact*, **120**, 1196.
181. Komeda, Y. (1986). *J. Bact*, **168**, 1315.
182. Wolfe, A.J., Colney, P., Kramer, T., and Berg, H.C. (1987). *J. Bacteriol*, **169**, 1878.
183. Kuo, S.C., and Koshland, D.E., Jr. (1987). *J. Bacteriol*, **169**, 1307.
184. Stock, A.M., and Stock, J.B. (1987). *J. Bact*, **169**, 3301.
185. Winans, S.C., Ebert, P.R., Stachel, S.E., Gordon, M.P., and Nester, E.W. (1986). *Proc. Natl. Acad. Sci. USA*, **83**, 8278.
186. Parke, D., Ornston, L.N., and Nester, E.W. (1987). *J. Bacteriol*, **169**, 5336.
187. Bashan, Y. (1986). *J. Gen. Micro*, **132**, 3407.
188. Arora, D.K., Filonow, A.B., and Lockwood, J.L. (1983). *Can. J. Micro*, **29**, 1104.
189. Mandimba, G., Heulin, T., Bally, R., Guckert, A., and Balandreau, J. (1986). *Plant and Soil*, **90**, 129.
190. Faharaeus, G. (1957). *J. Gen. Micro*, **16**, 374.
191. Schroth, M.N., and Ting, W-P. (1966). *Phytopathology*, **56**, 899.
192. Gulash, M., Ames, P., Larosiliere, R.C., and Bergman, K. (1984). *Appl. Env. Micro*, **48**, 149.
193. Gitte, R.R., Vittal Rai, P., and Patil, R.B. (1978).

- Plant and Soil, 50, 553.
194. Gaworzewska, E.T., and Charlile, M.J. (1982). *J. Gen. Micro*, 128, 1179.
 195. Bashan, Y., and Levanony, H. (1987). *J. Gen. Micro*, 133 3473.
 196. Harwood, C.S., Rivelli, M., and Ornston, L.N. (1984). *J. Bacteriol*, 160, 622.
 197. Griffin, D.M., and Quail, G. (1968). *Aust. J. Biol. Sci*, 21, 579.
 198. Scher, F.M., Kloepper, J.W., and Singleton, C.A. (1985). *Can. J. Microbiol*, 31, 570.
 199. Haefele, D.M., and Lindow, S.E. (1987). *Appl. Env. Micro*. 53, 2528.
 200. Vaeck, M., Reynaerts, A., Hofte, H., Jansens, S., De Beuckeleer, M., Dean, C., Zabeau, M., Van Montagu, M., and Leemans, J. (1987). *Nature*, 328, 33.
 201. Fred, E.B., Baldwin, I.L., and McCoy, E. (1932). *Root nodule bacteria and leguminous plants*, University of Wisconsin Press, Madison, 5, 343.
 202. Thomson, J.A. (1986). *Tibtech*, August p219.
 203. Orser, C.S., Lostein, R., Staskawicz, B.J., Dahlbeck, D., Lahue, E., Williss, D.K., Lindow, S.E., and Panopoulos, N.J. (1984). In *Proc. 2nd Working Group Pseudomonas syringae pathovars*, The Hellenic Phytopathological Society, Sounion, Greece, p94.
 204. Hardy, R.W.F. (1985). In *Nitrogen Fixation Research Progress*, Evans, H.J., Bottomley, P.J., and Newton, W.E., Eds., Martinus Nijhoff, London, p683.
 205. Torrey, J.G. and Tjepkema, J.D. (1983). *Can. J. Bot*, 61 2765.

206. Okon, Y., and Hadar, Y. (1987). *CRC Crit. Rev. Biotech*, **6**, 61.
207. Brown, M.E. (1982). In *Bacteria and Plants*, Rhodes-Roberts, M., and Skinner, F.A., Eds., Academic Press, London, p25.
208. Kerr, A., and Tate, M.E. (1984). *Microbiol. Sci*, **1**, 1.
209. Van Zyl, F.G.H., Strijdom, B.W., and Staphorst, J.L. (1986). *Appl. Env. Micro*, **52**, 234.
210. Engler, G., Holsters, M., Van Montagu, M., Schell, J., Hernalsteens, J.P., and Schilperoort, R. (1975). *Mol. Gen. Genet*, **138**, 345.
211. Ellis, J.G., and Murphy, P.J. (1981). *Mol. Gen. Genet*, **181**, 36.
212. Thomson, J.A. (1986). In *Innovative approaches to Plant Disease Control*, Chet, I., Ed., John Wiley and Sons, New York.
213. Webster, J., Dos Santos, M., and Thomson, J.A. (1986). *Appl. Env. Micro*, **52**, 217.
214. Kerr, A. et. al. (1988) Abstract taken from REGEM conference, Cardiff UK.
215. Obukowicz, M.G., Perlak, F.J., and Watrud, L.S. (1986). *European Patent Appl. EP 0200708*.
216. Schroth, M.N., and Hancock, J.G. (1982). *Science*, **216**, 1376.
217. De Weger, L.A., Van Der Vlugt, C.I.M., Wijfjes, A.H.M., Bakker, P.A.H.M., Schippers, B., and Lutenberg, B. (1987). *J. Bacteriol*, **169**, 2769.
218. Baker, R., and Scher, F.M. (1987). In *Innovating Approaches to plant Disease Control*, Chet, I., Ed., John Wiley and Sons, New York.
219. Weller, D.M. (1983). *Phytopathology*, **73**, 264.

220. Kloepper, J.W., and Schroth, M.N. (1981).
Phytopathology, 71, 1020.
221. Philson, S.B., and Llinas, M. (1982). J. Biol. Chem,
257, 8081.
222. Marugg, J.D., Vanspanje, M., Hoekstra, W.P.M.,
Schipper, B., and Weisbeck, P.J. (1985). J. Bact, 164, 563.
223. Bioprocessing Technology, July 1987, p3.
224. Lindow, S.E. (1982). In Phytopathogenic Prokaryotes,
Vol. 1, Mount, M.S. and Lacy, G.H., Eds., Academic Press, NY, p335.
225. Andrews, R.E., Jr, Faust, R.M., Wabiko, H., and Raymond,
K.C. (1987). CRC Critical. Rev. Biotech, 6, 163.
226. Luthy, P., and Ebersold, H.R. (1981). Pharmacol. Ther,
13(2), 257.
227. Khachatourians, G.G. (1986). TIBTECH (May), p120.
228. Bioprocessing Technology, July 1985, p1.
229. Bioprocessing Technology, March 1987, p5.
230. Papavizas, G.C., and Lewis, J.A. (1985). Annu. Rev.
Phytopathol, 23, 23.
231. Miller, L.R., Lingg, A.J., and Bulla, L.A., Jr. (1986).
Science, 219, 715.
232. Hall, R.A., and Papierok, A. (1982). Parasitology, 84,
205.
233. TeBeest, D.O., and Templeton, G.E. (1985). Plant. Dis,
69, 6.
234. Templeton, G.E., TeBeest, D.O., and Smith, R.J., Jr.
(1984). Crop. Prot, 3, 409.
235. Walker, H.L., and Boyette, C.D. (1985). Weed. Sci, 33,
212.
236. Riding, W.H., Schoulties, C.L., El-Ghall, N.E., and

- Mitchel, D.J. (1977). Proc. Int. Soc. Citriculture, 3, 877.
237. Evans, C. (1987). Process. Biochem. August p102.
238. Albersheim, P., and Darvill, A.G. (1985). Scientific American. September. p44.
239. Ashby, A.M., Watson, M.D., Loake, G.L., and Shaw, C.H. (1988). J. Bacteriol, (in press).
240. Melchers, L.S., and Hooykaas, P.J.J. (1987). Oxford Surveys of plant molecular and cell biology, 4, 167.
241. Adler, J. (1969). Science, 166, 1588.
242. Stryer, L. (1981). Biochemistry^{2nd edition} Chapter 4 p65. (W H Freeman & Co, eds).
243. Usami, S., Morikawa, S., Takebe, I., and Machida, Y. (1987). Mol. Gen. Genet, 209, 221.
244. Okker, R.J.H., Spaink, H., Hille, J., van Brussel, T.A.N., Lutenberg, B., and Schilperoort, R.A. (1984). Nature, London 312, 564.
245. Shaw, C.H., Ashby, A.M., and Watson, M.D. (1986). Nature, 324, 415.
246. Armitage, J.P., Josey, D.P., and Smith, D.G. (1977). J. Gen. Micro, 102, 199.
247. Rivero-Hudec, M., and Lauffenburger, D.A. (1986). Biotech. Bioeng XXV111, 1178.
248. Reinert, J., and Yeoman, M.M. (1982). Plant Cell and Tissue Culture : A Laboratory Manual, Springer. Verlag, Berlin, Heidelberg. N.Y.
249. Caboche, M. (1980). Planta, 149, 7.
250. Ditta, G., Stanfield, S., Corbin, D. and Helinsk, D.R. (1980). Proc. Natl. Acad. Sci USA, 77, 7347.
251. Bernaerts, M.J., and DeLey, J. (1963). Nature, 197, 406.

252. Roberts, W.K., and Selitrennikoff, C.P. (1988). *J. Gen. Micro*, **134**, 169.
253. Maniatis, T., Fritsch, E.M., and Sambrook, J. (1982). *Molecular cloning: a laboratory manual*. Cold Spring Harbor Laboratory, N.Y.
254. Weiss, B., Jacquemin-Sablon, A., Live, T.R., Fareed, G.C., and Richardson, C.C. (1968). *J. Biol. Chem*, **243**, 4543.
255. Bluescript Exo/Mung DNA Sequencing System : Instruction manual, Stratagene, San Diego, C.A. 92121.
256. Henikoff, S. (1984). *Gene*, **28**, 351.
257. Southern, E.M. (1975). *J. Mol. Biol*, **98**, 503.
258. Birnboim, H.C., and Doly, J. (1979). *Nuc. Acids. Res*, **7**, 1513.
259. Mandel, M., and Higa, A. (1970). *J. Mol. Biol*, **53**, 159.
260. Messing, J. (1983). *Methods. Enzymol*, **101**, 20.
261. Sanger, F., Nicklen, S., and Coulson, A.R. (1977). *Proc. Natl. Acad. Sci U.S.A*, **74**, 5463.
262. Ashby, A.M., Watson, M.D., Shaw, C.H., and Richards, A.J.M.(1986). *European Patent Appl. No EP 0 256 682 A2*.
263. Jones, J.D.J., Grady, K.L., Suslow, T.V., and Bedbrook, J.R. (1986). *The EMBO. J*, **5**, 467.
264. Monreal, J., and Reese, E.T. (1969). *Can. J. Micro*, **15**, 689.
265. Fuchs, R.L., McPherson, S.A., and Drahos, D.J. (1986). *App. Env. Micro*, **51**, 504.
266. Rogowsky, P.M., Close, T.J., Chimera, J.A., Shaw, J.J., and Kado, C.I. (1987). *J. Bact*, **169**, 5101.
267. Vieira, J., and Messing, J. (1982). *Gene*, **19**, 259.
268. Leemans, J., Deblaere, R., Willmitzer, L., DeGreve, H.,

- Hernalsteens, J.P., Van Montagu, M., and Schell, J. (1982). *EMBO. J*, **1**, 147.
269. Leemans, Langenakens, J., DeGreve, H., Deblaere, R., Van Montagu, M., and Schell, J. (1982). *Gene*, **19**, 361.
270. Stachel, S.E., An, G., Flores, C., and Nester, E.W. (1985). *EMBO. J*, **4**(4), 891.
271. Das, A., Stachel, S.E., Ebert, P., Allenza, P., Montoya, A., and Nester, E.W. (1986). *Nuc. Acids. Res*, **14**, 1355.
272. Hoheisel, J., and Pohl, F.M. (1986). *Nuc. Acids. Res*, **14**, 3605.
273. Knauf, V.C., and Nester, E.W. (1982). *Plasmid*, **8**, 45.
274. Robbins, P.W., Albright, C., and Benfield, B. (1988). *J. Biol. Chem*, **263**, 443.
275. Roberts, W.K., and Selitrennikoff, C.P. (1988). *J. Gen. Micro*, **134**, 169.
276. Stachel, S.E., and Nester, E.W. (1986). *EMBO. J*, **5**, 1445.
277. Gilbert, W. (1976). In *RNA Polymerase*, R. Losick and M. Chamberlin, eds. p719, Cold Spring Harbor Lab., NY.
278. de Crombrughe, B., Busby, S., and Buc, H. (1984). *Science*, **224**, 831.
279. de Crombrughe, B., and Pastan, I. (1978). In *the Operon*, J. Miller and W. Reznikoff, eds. p304. Cold Spring Harbor Lab., NY.
280. Greenfield, L., Boone, T., and Wilcox, G. (1978). *Proc. Natl. Acad. Sci. USA*, **75**, 4724.
281. Ptashne, M. (1978). In *The Operon*, J. Miller and W. Reznikoff, eds. p325. Cold Spring Harbor Lab., NY.
282. Rosenberg, M., Court, D., Shimalake, H., Brady, C., and Wulff, D. (1978). In *The Operon*, J. Miller and W. Reznikoff, eds.

- p345. Cold Spring Harbor Lab., NY.
283. Manorama, J.C., and Amasino, R.M. (1988). *J. Bact* 170, 790.
284. Roberts, R.L., and Cabib, E. (1982). *Analytical. Biochem*, 127, 402.
285. Shaw, C.H., Carter, G.H., Watson, M.D., and Shaw, C.H. (1984). *Nuc. Acids. Res*, 12, 7831.
286. De Greve, H., Decraemer, H., Seurinck, J., Van Montagu, M., and Schell, J. (1981). *Plasmid*, 6, 325.
287. Van Larebeke, N., Engler, G., Holsters, M., Van den Elsacker, S., Zaenen, I., Schilperoort, R.A., and Schell, J. (1974). *Nature*, 252, 169.
288. Knauf, V.C., and Nester, E.W. (1982). *Plasmid*, 8, 45.
289. Hess, J.F., Oosawa, K., Kaplan, N., and Simon, M. (1988). *Cell*, 53, 79.
290. Parkinson, J.S. (1988). *Cell*, 53, 1.
291. Schlumbaum, A., Mauch, F., Vogeli, U., and Boller, T. (1986). *Nature*, 324, 365.
292. Ninfa, A.J., Reitzer, L.J., and Magasanik, B. (1987). *Cell*, 50, 1039.
293. Macnab, R.M. (1987). Flagella, in *E. coli* and *S. typhimurium*: cellular and molecular biology. American. Soc. Micro. (Washington DC) p70.

