



Durham E-Theses

Optimization and the convergence of perturbation series

Nicholls, Jennifer Ann

How to cite:

Nicholls, Jennifer Ann (1990) *Optimization and the convergence of perturbation series*, Durham theses, Durham University. Available at Durham E-Theses Online: <http://etheses.dur.ac.uk/6148/>

Use policy

The full-text may be used and/or reproduced, and given to third parties in any format or medium, without prior permission or charge, for personal research or study, educational, or not-for-profit purposes provided that:

- a full bibliographic reference is made to the original source
- a [link](#) is made to the metadata record in Durham E-Theses
- the full-text is not changed in any way

The full-text must not be sold in any format or medium without the formal permission of the copyright holders.

Please consult the [full Durham E-Theses policy](#) for further details.

The copyright of this thesis rests with the author.
No quotation from it should be published without
his prior written consent and information derived
from it should be acknowledged.

Optimization

and the

Convergence of Perturbation Series

A thesis presented for the degree of

Doctor of Philosophy

by

Jennifer Ann Nicholls

University of Durham

Department of Physics

June 1990



25 JUN 1991

ABSTRACT

This thesis is concerned with the possible sums of perturbation series in massless, renormalizable field theories. It shows that, given a free choice of scheme, the limit of the sequence of approximants is arbitrary. Restricting the choice to finite schemes, in particular “zero schemes”, yields a perturbatively unique limit to the sequence of approximants. An operational method for calculating perturbative expansions in the class of zero schemes is discussed.

A comparison of various optimization schemes is given for a few phenomenological examples in QCD and QED.

ACKNOWLEDGEMENTS

I would like to thank Chris Maxwell for his supervision and guidance throughout this project.

Thanks also go to Mike Pennington, without whose encouragement I would never have come here in the first place, or survived my first year.

Other people who have supported me here are many and various, but four in particular stand out. On the work front is David Pentney, who patiently answered innumerable questions, often trivial, on physics, computing and marking third year problem sheets. At the other end of the scale is Hannah Furlong, who worked hard to keep me sane and was a much needed female presence in a male dominated environment. With a foot in each of these two camps are Alan Birch and Mike Wade, physics, computing and \TeX advisors, friends and confidants.

I am grateful for the financial assistance, through an Overseas Research Student Award, of the Committee of Vice-Chancellors and Principals of British Universities, without which I could not have afforded to study in Britain.

Finally, I am indebted to my parents for their support, financial, emotional and moral, and for their continued belief in me.

To Mum and Dad

CONTENTS

	Page
Abstract	
Title	
Acknowledgements	i
Dedication	ii
Contents	iii
Statement of copyright	vi
Declaration	vii
Chapter One INTRODUCTION	
1.1 Historical Background	1
1.2 Thesis Outline	5
Chapter Two THE ROUTE TO PERTURBATION THEORY	
2.1 Gauge Theory	6
2.2 Quantization and Perturbation Theory	8
2.3 Calculating Observable Quantities	14
2.4 The Extension to Spinor Theories	16
2.5 ... and Gauge Theories	17
2.6 Renormalization	19
2.7 Renormalization of Spinor and Gauge Field Theories	24
2.8 The β -function and Dimensional Transmutation	26
2.9 The Renormalization Group Equation	28
2.10 Large Orders in Perturbation Theory	29
Chapter Three VARIOUS RENORMALIZATION SCHEMES	
3.1 Introduction	34
3.2 Notation	35
3.3 The Effective Charge Scheme	38
3.4 The Principle of Minimal Sensitivity	42

3.5	The Pennington-Wrigley Approximation	43
Chapter Four THE POSSIBLE SUMS OF PERTURBATION SERIES		
4.1	Introduction	45
4.2	Some Necessary Proofs	46
4.3	The Set of Possible Limits	50
4.4	Possible Limits of the EC and PW Schemes	56
4.5	Restriction to “Finite” Schemes	60
4.6	$\widetilde{\text{PMS}}$	64
4.7	The $\widetilde{\text{PMS}}$ Limit Considered Graphically	68
4.8	The Case for Non-Zero c	74
4.9	Finite Schemes	83
4.10	The Behaviour of Perturbation Series at High Orders	86
4.11	Discussion and Summary	88
Chapter Five TECHNOLOGY		
5.1	Introduction	91
5.2	The Reversion Coefficients	91
5.3	The Scheme Invariants	93
5.4	The Effective Charge Scheme	95
5.5	The Pennington-Wrigley Approximation	95
5.6	The $\widetilde{\text{PMS}}$ Scheme	96
5.7	The Principle of Minimal Sensitivity	97
Chapter Six CALCULATIONS IN QCD ...		
6.1	Introduction	100
6.2	The $R_{e^+e^-}$ Ratio	101
6.3	Speculations on the High Order Behaviour of the e^+e^- Series Coefficients	106
6.4	τ Decay	108
Chapter Seven ... AND QED		
7.1	Introduction	122

7.2	The On-Shell Scheme	123
7.3	The Fine Structure Constant	124
7.4	The Anomalous Magnetic Moment of the Electron	125
7.5	Conclusion	129
	Conclusion	131
	References	132

STATEMENT OF COPYRIGHT

The copyright of this thesis rests with the author. No quotation from it should be published without her prior consent and information derived from it should be acknowledged.

DECLARATION

I declare that no material in this thesis has previously been submitted for a degree at this or any other university.

The research described in chapters four, five, six and seven has been carried out in collaboration with Dr C.J. Maxwell, part of which has been published as follows:

- (i) “Scheme dependence of the QCD R ratio in $O(\alpha_s^3)$ perturbation theory.”
C.J. Maxwell and J.A. Nicholls, *Phys. Lett.* **B213** 217 (1988)
- (ii) “On the perturbative QCD calculation of the R ratio for τ decay”
C.J. Maxwell and J.A. Nicholls, *Phys. Lett.* **B236** 63 (1989)

1 Introduction

1.1 Historical Background

In the early 19th century a scientist, or natural philosopher as they were then known, could be well versed in all areas of study, but as the century progressed and the body of knowledge expanded ever more rapidly, this was no longer possible, and specialization was forced upon them. Gradually each of the disciplines became more distinct and they grew further apart. This process has accelerated over the years and not only are new subjects coming into existence, but within disciplines more and more specialization is required so that it is now possible to only know and understand a tiny fraction of all science. The tiny fraction with which this thesis deals is the optimization of perturbation theory in massless renormalizable field theories – the longer the title, the more specialized and restricted the topic.

This topic is embedded in the larger field of high energy particle physics – the area which concerns itself with the structure of matter, something that has fascinated people for centuries. The subject has evolved somewhat from the primitive classification into the four basic elements of earth, air, fire and water, aided greatly by the early alchemists who held to this view. Their failures in the search for the Elixir of Life and a method for transmuting “base” metals into gold may have been disappointing for them, but provided a sound base for the discipline today known as Chemistry. They isolated many elements and compounds, and established some of their physical properties, which gave Mendeleev the footing on which to place his Table of Elements.

Unfortunately for Mendeleev, from work in spectroscopy and the discovery of radioactivity and “cathode rays” (correctly interpreted as free electrons) it was shown that his “elements” are not the basic constituents of matter as he thought, but complex composite objects. Geiger and Marsden’s experiment provided further evidence for the structure of the atom, and led Rutherford to propose the nuclear model of the atom. Bohr’s model of the atom finally tied quantum theory into the theory of the structure of matter, which many had been trying to do, and was able to explain such phenomena as the Balmer series of the hydrogen spectrum. It wasn’t until the neutrino was suggested to account

for the continuous energy spectrum of the electron in β -decay, and the discovery of the neutron, that a reasonable model of the nucleus could be put forward that adequately explained such phenomena as radioactivity, although the force that bound the protons and neutrons was still a mystery.

The neutron itself was a puzzle at first. Its mass was surprisingly close to that of the proton, and it soon became clear that the pp -, nn - and pn -forces were of equal strength within experimental error – a property called charge independence. A new property called isospin was proposed in direct analogy to spin. It was suggested that the proton and neutron were two different states of the same particle, dubbed the nucleon; which had isospin $I = \frac{1}{2}$. The proton was the state with $I_3 = +\frac{1}{2}$, the neutron $I_3 = -\frac{1}{2}$. Charge independence means that the forces in the three states that form the isotriplet pp, nn and $(pn + np)/\sqrt{2}$ are equal – in other words the forces are invariant under isospin transformations. As with ordinary spin, isospin transformations form the symmetry group $SU(2)$ and play an important role in nuclear physics.

It was Yukawa who first suggested that the force that bound nucleons was different from the weak force encountered in β -decay. He saw the inverse relation between the range of a force and the mass of the particle mediating the force. In electrodynamics the range of the Coulomb potential is infinite corresponding to the photon being massless, so from the fact that the strong nuclear force has a range of about 10^{-13} cm, he predicted a particle whose mass was approximately 200 times that of the electron – the particle we know as the pion. This was the first attempt to associate nuclear forces with a field, inspired by the successes of Quantum Electrodynamics, QED, which had just predicted the existence of the positron. Although it finally proved not to be the correct answer, it changed the way physicists viewed forces.

A few years later, a particle of the required mass was detected in cosmic ray experiments. Although initially hailed as Yukawa's meson, its properties were inconsistent with those Yukawa predicted. It turned out to be a muon. The pion itself was not found for another 11 years, by which time a neutral pion had been predicted to save charge independence, so the pion was now considered to be a mass-degenerate isospin triplet. Even before the experimental discovery of the pion two new "V-particles" were detected and over the next few years more evidence was accumulated which pointed to the existence of a new quantum

number – called strangeness. For years the desire to connect strangeness and isospin in a larger symmetry went unfulfilled. It wasn't until the known number of particles had multiplied to the point where they could no longer all be believed to be fundamental, that the breakthrough came. Gell-Mann, Ne'eman, and Speiser and Tarski independently showed that the ^{the} observed particles fell into representations of $SU(3)$, and predicted the existence of Ω^- meson because one of the representations was not full. Later, Gell-Mann and Zweig further postulated quarks and antiquarks to fill the 3 and 3^* representations respectively, claiming mesons were composites of $q\bar{q}$ and baryons of 3 quarks.

Quarks were at first accepted only as useful mnemonics, a major argument against them being their fractional charge. Another argument against quarks was that the wave function of baryons appeared to contravene the Pauli exclusion principle; the three-quark wave function was symmetric in all variables, a situation not tenable by particles such as baryons which obey Fermi statistics. Among the suggested remedies was Han and Nambu's proposal that the quarks carry a new 3 valued degree of freedom such that the baryon wave function in terms of quarks, was antisymmetric. Another $SU(3)$ symmetry was associated with this new freedom. Eight gauge vector fields were introduced to carry this new interaction. These formed an octet under the new $SU(3)$ but a singlet in flavour $SU(3)$, so that hadrons were singlets in the new symmetry. It was also pointed out that this new force did not contribute to electromagnetism. So was introduced the idea of the colour force as the strong nuclear force, although it was some years before it was accepted as such.

Direct evidence for such structure in nucleons came in 1967 with the deep inelastic scattering of electrons off protons. Electrons were scattered over much larger angles than were predicted by assuming nucleons to be fundamental, showing that particles existed inside the proton. This discovery led to the parton model, parton being the name given to these particles as they were not immediately associated with quarks.

One of the major contributions to the synthesis of the parton model and the quark model, and hence the acceptance of Quantum Chromodynamics, QCD , as the theory of strong interactions, came about through what is known as the R-ratio. This is defined to be the ratio of the cross section for e^+e^- annihilation

to form hadrons to the cross section for e^+e^- annihilation to form $\mu^+\mu^-$;

$$R = \frac{\sigma(e^+e^- \rightarrow \text{hadrons})}{\sigma(e^+e^- \rightarrow \mu^+\mu^-)}. \quad (1.1)$$

The denominator is the zeroth order result for a pure QED process and can be simply calculated,

$$\sigma(e^+e^- \rightarrow \mu^+\mu^-) = \frac{4\pi\alpha^2}{3s}, \quad (1.2)$$

where s is the square of the centre of mass energy, and α is the QED coupling constant. The numerator can be factored into two parts. The contribution from QED corresponds to $e^+e^- \rightarrow q\bar{q}$, which has a zeroth order cross section given by

$$\sigma(e^+e^- \rightarrow q\bar{q}) = N_c Q_f^2 \sigma(e^+e^- \rightarrow \mu^+\mu^-), \quad (1.3)$$

where N_c = number of colours and Q_f is the charge on the quark of flavour f . The QCD factor comes from $q\bar{q} \rightarrow \text{hadrons}$. Due to the confining nature of the QCD coupling this last process has unit probability, so the R ratio is given by

$$R = N_c \sum_f Q_f^2, \quad (1.4)$$

where the sum is over all quark flavours that interact at this energy, \sqrt{s} .

Obviously the value of R depends on the number of colours, and after initial confusion caused by unforeseen resonances, experiment was shown to favour 3 colours. QCD had finally arrived as the theory of strong interactions, and together with electroweak theory, provides the best explanation of the structure of matter given present knowledge.

Whilst there are as yet many unanswered questions, and the goal of unifying the four known forces still lies beyond the reach of modern physics, it is at least in a position to tell the alchemists why their attempts to transmute base metals to gold, in experiments with energies of the order of a few eV, were doomed to failure, although the biologists are not quite ready for a definite statement on the Elixir of Life!

1.2 Thesis Outline

A brief review of where perturbation theory comes from, starting from gauge theory, using the path integral formalism and giving a sketchy outline of renormalization, is presented in chapter 2, which ends with a short discussion on the behaviour of the high orders in perturbation series expansions. Notation to be used throughout the rest of the thesis will be introduced in chapter 3, as will the most prominent optimization schemes. Chapter 4 contains a detailed look at possible limits of the sequence of perturbative approximants. In particular, it shows that, given a free choice of scheme, any limit desired may be obtained by choosing a suitable sequence of schemes. For the effective charge [1] and Pennington-Wrigley [2,3] approximation of the Principle of Minimal Sensitivity [4], the claim will be made that these schemes either become undefined or the most likely finite limit is zero. The restriction to “finite schemes” is suggested, and the possible limits discussed with numerical examples given. The computational methods of implementing the various optimization procedures, and the way of moving from scheme to scheme for a given physical process, are detailed in the fifth chapter. The final two chapters look at various physical processes in QCD and QED respectively.

Throughout the thesis massless, renormalizable field theories are dealt with to avoid the complication due to mass renormalization. Further, only processes which can be calculated without recourse to a fragmentation model are considered, again to avoid unnecessary complications which at this point would merely cloud the issue. When this subject is more fully understood will be the time to include the above effects.

2 The Route to Perturbation Theory

2.1 Gauge Theory

The developments in understanding the physical world went hand in hand with developments in mathematics, as hinted above. The need to model quantum effects and to incorporate the known symmetries and associated quantum numbers led to the development of many new ideas, not least among them being gauge field theories – the mathematical formulation of chromodynamics and electroweak theory.

It has long been known that a Lagrangian density, commonly referred to simply as a Lagrangian, can be constructed to be invariant under a group of transformations. To see this consider a set of M Dirac four component spinor fields, which for convenience will be written in a column vector and denoted by ψ . For the sake of simplicity the group $SU(N)$ will be used, with the fields transforming under an M -dimensional irreducible representation of $SU(N)$;

$$\psi(x) \rightarrow U(\alpha_a)\psi(x), \quad (2.1)$$

where $U(\alpha_a)$, an $M \times M$ matrix, can be written

$$U(\alpha_a) = \exp(i\alpha_a T_a). \quad (2.2)$$

and $a = 1, \dots, N^2 - 1$. Here the α_a are arbitrary real constants, and the T_a are traceless, hermitian matrices which form an M -dimensional irreducible representation of the generators of $SU(N)$. The T_a may be chosen such that

$$\text{Tr}(T_a T_b) \propto \delta_{ab}. \quad (2.3)$$

The constant of proportionality then chosen fully specifies the structure constants, f_{abc} , of the Lie algebra of the group that the T_a must obey;

$$[T_a, T_b] = i f_{abc} T_c. \quad (2.4)$$

The Lagrangian

$$\mathcal{L} = i\bar{\psi} (\gamma_\mu \partial^\mu) \psi. \quad (2.5)$$

is invariant under the transformation (2.1). This invariance is called global,

since each of the group parameters, α_a , is the same at every space-time point. The question was then asked, if the group parameters are now made functions of space-time, can a Lagrangian be constructed which is invariant under this extended group of transformations, and if so, how?

The Lagrangian (2.5) is obviously not invariant under this new transformation due to the fact that the derivative now acts upon $U(\alpha_a(x))$. The way to proceed is to define a new operator to replace the derivative, so that the invariance of the Lagrangian is maintained. Hence the covariant derivative, as the new operator is called, must obey

$$\mathcal{D}_\mu \psi \rightarrow U(\alpha_a(x)) \mathcal{D}_\mu \psi. \quad (2.6)$$

To construct such an operator, vector gauge fields $G_{a\mu}$ must be introduced - one for each generator of the group. The term "gauge" field is an historical misnomer, but it has stuck. By writing \mathcal{D}_μ as

$$\mathcal{D}_\mu = \partial_\mu + ig G_\mu, \quad (2.7)$$

where $G_\mu \equiv G_{a\mu} T_a$, and by requiring (2.6) to hold, it can be shown that these new fields must transform as

$$G_\mu(x) \rightarrow G'_\mu(x) = U(\alpha_a(x)) \left(G_\mu(x) - \frac{i}{g} \partial_\mu \right) U^{-1}(\alpha_a(x)), \quad (2.8)$$

A kinetic term for the gauge fields can be constructed by first defining the tensor

$$\begin{aligned} F_{a\mu\nu} T_a &\equiv F_{\mu\nu} \equiv -\frac{i}{g} [\mathcal{D}_\mu, \mathcal{D}_\nu] \\ &= \partial_\mu G_\nu - \partial_\nu G_\mu + ig [G_\mu, G_\nu] \\ &= (\partial_\mu G_{a\nu} - \partial_\nu G_{a\mu} - gf_{abc} G_{b\mu} G_{c\nu}) T_a, \end{aligned} \quad (2.9)$$

which transforms as

$$F_{\mu\nu}(x) \rightarrow F'_{\mu\nu}(x) = U(\alpha_a(x)) F_{\mu\nu}(x) U^{-1}(\alpha_a(x)). \quad (2.10)$$

The kinetic term,

$$-\frac{1}{4} F_{a\mu\nu} F_a^{\mu\nu} \propto \text{Tr}(F_{\mu\nu} F^{\mu\nu}), \quad (2.11)$$

is clearly invariant, due to the cyclic properties of trace. The full Lagrangian

invariant under $SU(N)$ is then

$$\begin{aligned}\mathcal{L} &= i\bar{\psi}\gamma^\mu\mathcal{D}_\mu\psi - \frac{1}{4}F_{a\mu\nu}F_a^{\mu\nu} \\ &= \mathcal{L}(\psi) + \mathcal{L}(G_a^\mu).\end{aligned}\tag{2.12}$$

The non-Abelian nature of the gauge group leads to the self-interaction of the gauge fields as their kinetic term contains terms such as

$$gf_{abc}(\partial_\mu G_{a\nu})G_b^\mu G_c^\nu\tag{2.13}$$

and

$$\frac{g^2}{4}f_{abc}f_{aef}G_{b\mu}G_{c\nu}G_e^\mu G_f^\nu,\tag{2.14}$$

which give rise to three- and four-point interactions of the gauge fields. The case is somewhat simpler if the gauge group is the Abelian group $U(1)$, as there is only one generator and corresponding field. The above analysis is the same except all terms containing structure constants are dropped, as obviously the single generator commutes with itself. Hence, $F_{\mu\nu}$ becomes

$$F_{\mu\nu} = \partial_\mu G_\nu - \partial_\nu G_\mu,\tag{2.15}$$

and the kinetic term only contains terms quadratic in the field G , describing the free propagation of the gauge particle, and not allowing any self-interaction. Note that in both Abelian and non-Abelian cases gauge invariance prohibits a mass term for the gauge fields.

If in the $U(1)$ case the Dirac field is identified with the electron and the gauge field with the photon, then (2.12) is the Lagrangian for QED. Similarly, choosing the group to be $SU(3)$ and associating the three Dirac fields with three quarks of different colours and the eight gauge fields with the gluons, (2.12) is the QCD Lagrangian.

2.2 Quantization and Perturbation Theory

These, however, are the classical Lagrangians, yielding classical theories. To quantize the theory the path integral formalism will be employed. As this is

exceedingly complex and lengthy if done in full, the main idea will be sketched using a scalar field theory, and complications due to quantizing spinor and gauge field theories will be commented on later. A more detailed review of the subject can be found in such books as Bailin and Love [5], Itzykson and Zuber [6], etc, and references found therein.

If the Lagrangian is no more than quadratic in the time derivatives of the field, then the transition amplitude from the vacuum at $t = -\infty$ to the vacuum at $t = +\infty$ in the presence of a source term $J(x)\phi(x)$, may be written

$$W[J] = N \int \mathcal{D}\phi \exp \left(i \int d^4x (\mathcal{L}(\phi, \partial_\mu \phi) + J\phi) \right), \quad (2.16)$$

where $\mathcal{D}\phi$ denotes a path integral over all functions ϕ , the normalization, N , is chosen so that $W[0] = 1$, and $\hbar \equiv 1 \equiv c$. For a more general Lagrangian, the canonical momentum must be defined, and $W[J]$ written in terms of a path integral over both ϕ and π , and the action written in terms of the Hamiltonian. However, the integral over π will not be exact, and whilst $W[J]$ may be written in the form of (2.16), the Lagrangian involved will be an effective Lagrangian - not the proper one for the theory due to the approximations made when integrating over π .

As it stands, (2.16) is not well defined, as the integrand is oscillatory. A convergence factor of $\exp(-\frac{1}{2}\epsilon\phi^2)$ with $\epsilon > 0$, may be introduced for scalar fields. More usually, a Wick rotation to Euclidean space is made, the path integral evaluated for fields which vanish at infinity, and the answer is continued back to Minkowski space. In the following discussion it will be implicit that this has happened, unless otherwise stated.

The Lagrangian for the free-field case, denoted by the subscript 0, is

$$\mathcal{L}_0 = \frac{1}{2} \partial_\mu \phi_0 \partial^\mu \phi_0 + \frac{1}{2} \mu^2 \phi_0^2, \quad (2.17)$$

where μ is the mass of the particle associated with the field. The Euler-Lagrange equation derived from this Lagrangian is the classical field equation for a neutral free scalar field, known as the Klein-Gordon wave equation,

$$(\partial^\mu \partial_\mu + \mu^2) \phi_0(x) = 0. \quad (2.18)$$

The Klein-Gordon operator, $(\partial^\mu \partial_\mu + \mu^2)$ is denoted by K_x .

In this case, (2.16) becomes

$$W_0[J] = N_0 \int \mathcal{D}\phi_0 \exp\left(i \int d^4y (\mathcal{L}_0 + J\phi_0)\right), \quad (2.19)$$

with N_0 chosen so that $W[0] = 1$. It can be evaluated exactly to be

$$W_0[J] = \exp\left(-\frac{i}{2} \int d^4x' \int d^4x J(x') \Delta_F(x' - x) J(x)\right), \quad (2.20)$$

where Δ_F is the Feynman propagator

$$\Delta_F(x' - x) = \int \frac{d^4p}{(2\pi)^4} e^{-ip \cdot (x' - x)} \tilde{\Delta}_F(p), \quad (2.21)$$

and $\tilde{\Delta}_F(p)$ is its Fourier transform,

$$\tilde{\Delta}_F(p) = (p^2 - \mu^2 + i\epsilon)^{-1}. \quad (2.22)$$

The $i\epsilon$ in the Feynman propagator, with $\epsilon \rightarrow 0^+$, was introduced to avoid the poles in p_0 when $p^2 = \mu^2$, when continuing back from Euclidean to Minkowski space. The above set of equations (2.20)-(2.22) define the generating functional for the free-field theory, so called because from it the Green's functions may now be generated.

Functionally differentiating (2.16) with respect to the source, J , brings down a factor of $i\phi$, so

$$\frac{\delta^n W[J]}{\delta J(x_1) \dots \delta J(x_n)} = N i^n \int \mathcal{D}\phi \phi(x_1) \dots \phi(x_n) \exp\left(i \int d^4x (\mathcal{L} + J\phi)\right), \quad (2.23)$$

which is proportional to the expression for the vacuum to vacuum expectation value for a time ordered product of n field operators, also known as an n -particle Green's function

$$\begin{aligned} G^{(n)}(x_1 \dots x_n) &= \left\langle 0 \left| \mathsf{T} \left(\hat{\phi}(x_1) \dots \hat{\phi}(x_n) \right) \right| 0 \right\rangle \\ &= (-i)^n \frac{\delta^n W[J]}{\delta J(x_1) \dots \delta J(x_n)} \Big|_{J(x)=0}, \end{aligned} \quad (2.24)$$

where T is the time ordering operator, and $\hat{\phi}$ denotes a quantum field operator. So (2.24) relates an expression involving a classical field, ϕ , to an expression containing a quantum operator, $\hat{\phi}$.

From this, and using the fact that the Green's function is symmetric in its variables, $W[J]$ can be written

$$W[J] = \sum_{n=0}^{\infty} \frac{(i)^n}{n!} \int d^4x_1 \dots \int d^4x_n G^{(n)}(x_1 \dots x_n) J(x_1) \dots J(x_n), \quad (2.25)$$

where the $n = 0$ term is 1.

The Green's functions, and hence the generating functional, are closely related to the scattering amplitudes of the theory. Unfortunately $W[J]$ can only be evaluated exactly in the free-field case, and so a perturbative expansion for $W[J]$ must be derived. If the Lagrangian is now written as the sum of the free-field Lagrangian, \mathcal{L}_0 , and a piece involving the interaction terms, \mathcal{L}_1 , proportional to some expansion parameter, λ , then the integrand of (2.16) can be written

$$\begin{aligned} \exp\left(i \int d^4x (\mathcal{L} + J\phi)\right) &= \sum_{n=0}^{\infty} \frac{i^n}{n!} \int d^4x_1 \dots d^4x_n \mathcal{L}_1(\phi(x_1)) \dots \mathcal{L}_1(\phi(x_n)) \\ &\quad \exp\left(i \int d^4x (\mathcal{L}_0 + J\phi)\right), \end{aligned} \quad (2.26)$$

where the series expansion of the exponential of the interaction term has been used, and the $n = 0$ term is defined to be 1.

Since functionally differentiating $\exp(i \int d^4x (\mathcal{L}_0 + J\phi))$ with respect to J pulls down a factor of $i\phi$, it can be shown that

$$\begin{aligned} \left(\int d^4x \mathcal{L}_1(\phi)\right) \exp\left(i \int d^4y (\mathcal{L}_0 + J\phi)\right) \\ = \int d^4x \mathcal{L}_1\left(-i \frac{\delta}{\delta J(x)}\right) \exp\left(i \int d^4y (\mathcal{L}_0 + J\phi)\right). \end{aligned} \quad (2.27)$$

Taking the operator $\int d^4x \mathcal{L}_1\left(-i \frac{\delta}{\delta J(x)}\right)$ outside the functional integral in (2.16) since it is independent of ϕ , and using (2.19), (2.16) becomes

$$\begin{aligned} W[J] &= N \exp\left(i \int d^4x \mathcal{L}_1\left(-i \frac{\delta}{\delta J(x)}\right)\right) \int \mathcal{D}\phi \exp\left(i \int d^4y (\mathcal{L}_0 + J\phi)\right) \\ &= \sum_{n=0}^{\infty} \frac{i^n}{n!} \int d^4x_1 \dots d^4x_n \mathcal{L}_1\left(-i \frac{\delta}{\delta J(x_1)}\right) \dots \mathcal{L}_1\left(-i \frac{\delta}{\delta J(x_n)}\right) W_0[J], \end{aligned} \quad (2.28)$$

with N chosen so that $W[0] = 1$, and the $n = 0$ term is defined to be 1.

Since $W_0[J]$ is known, and \mathcal{L}_1 is proportional to the expansion parameter λ , (2.28) represents a perturbative expansion of $W[J]$ as a power series in λ . The Green's functions for the perturbation series can now be derived by using (2.24) and substituting (2.20)-(2.22) for $W_0[J]$. For example, in $\lambda\phi^4$ theory, where \mathcal{L}_1 is $\lambda\phi^4$, and \mathcal{L}_0 and $W_0[J]$ are given by (2.17) and (2.20) respectively, to first order in λ , $W[J]$ is

$$W[J] = W_0[J] - \frac{i\lambda}{4!} \int d^4x \frac{\delta^4 W_0}{\delta J^4(x)} + O(\lambda^2). \quad (2.29)$$

Now

$$\frac{\delta W_0}{\delta J(x)} = - \int d^4y i\Delta_F(x-y) J(y) W_0[J], \quad (2.30)$$

so substituting into the previous equation gives

$$\begin{aligned} W[J] = W_0[J] & \left(1 - \frac{i\lambda}{4!} \int d^4x \left[3(i\Delta_F(0))^2 \right. \right. \\ & - 6i\Delta_F(0) \int d^4y_1 d^4y_2 i\Delta_F(x-y_1) i\Delta_F(x-y_2) J(y_1) J(y_2) \\ & + \int d^4y_1 d^4y_2 d^4y_3 d^4y_4 i\Delta_F(x-y_1) i\Delta_F(x-y_2) i\Delta_F(x-y_3) \\ & \left. \left. i\Delta_F(x-y_4) J(y_1) J(y_2) J(y_3) J(y_4) \right] + O(\lambda^2) \right). \end{aligned} \quad (2.31)$$

with $W_0[0] = 1$. The Green's functions may be found using (2.24). For the 2-particle Green's function this yields

$$\begin{aligned} G^{(2)}(x_1, x_2) = i\Delta_F(x_1 - x_2) & \left(1 - \frac{i\lambda}{8} \int d^4x (i\Delta_F(x-x))^2 \right) \\ & - \frac{i\lambda}{2} \int d^4x i\Delta_F(x_1 - x) i\Delta_F(x - x) i\Delta_F(x - x_2) + O(\lambda^2). \end{aligned} \quad (2.32)$$

In a free-field theory, $\lambda = 0$, the free-field Green's function, $G_0^{(2)}(x_1, x_2)$, is just the first term, and represents the propagation of a scalar particle from x_1 to x_2 . This may be represented diagrammatically by a line from x_1 to x_2 . When $\lambda \neq 0$, the additional terms are generated by interactions – in the case of the third term this is a self-interaction of the scalar field. Propagators whose argument is zero are represented by a loop at x . Since x is an arbitrary point, and the Green's function does not depend on it, it is integrated over. However, these loop

integrals, as they are called, may give rise to infinities which must be removed by a process known as renormalization before a finite answer can be obtained. This process will be introduced in §2.6 and following sections. The factor of $-i\lambda$ occurs at every vertex, and numeric factors, like the $\frac{1}{2}$ and $\frac{1}{8}$ which appear in (2.32), are symmetry factors. So, diagrammatically, $G^{(2)}(x_1, x_2)$ is

$$G^{(2)}(x_1, x_2) = \text{---} \overset{x_1}{\text{---}} \text{---} \overset{x_2}{\text{---}} + \overset{x}{\infty} \text{---} \overset{x_1}{\text{---}} \text{---} \overset{x_2}{\text{---}} + \text{---} \overset{\circ}{\text{---}} \overset{x}{\text{---}} \text{---} \overset{x_2}{\text{---}} + o(\lambda^2) \quad (2.33)$$

The second term is called an unconnected diagram for obvious reasons. These diagrams are known as Feynman diagrams and the associated factors as Feynman rules. Using the diagrams and rules, it is possible to construct all the Green's functions for the theory.

By defining a new functional, $X [J]$, via

$$iX [J] \equiv \ln W [J], \quad (2.34)$$

a specialized class of Green's functions, called connected Green's functions, denoted $G_c^{(n)}$, can be defined

$$iX [J] = \sum_{n=1}^{\infty} \frac{i^n}{n!} \int d^4x_1 \dots \int d^4x_n G_c^{(n)}(x_1, \dots, x_n) J(x_1) \dots J(x_n), \quad (2.35)$$

with

$$i^n G_c^{(n)}(x_1, \dots, x_n) = i \left. \frac{\delta^n X [J]}{\delta J(x_1) \dots \delta J(x_n)} \right|_{J=0}. \quad (2.36)$$

When represented diagrammatically, each diagram that contributes to a Green's function has no subunits that are not connected to the rest of the diagram by at least one line. So terms like the second term in (2.33) do not appear.

A further refinement is to define one-particle-irreducible (OPI) Green's functions - all of whose graphs can not be split into smaller graphs by cutting only one line. To define these functions, what is known as the classical field, ϕ_c , is

introduced,

$$\phi_c(x) = \frac{\delta X [J]}{\delta J(x)}. \quad (2.37)$$

The effective action $\Gamma[\phi_c]$, defined by

$$\Gamma[\phi_c] = W[J] - \int d^4x J(x)\phi_c(x), \quad (2.38)$$

can not usually be evaluated exactly in an interacting theory, and a functional expansion is made:

$$\Gamma[\phi_c] = \sum_{n=1}^{\infty} \frac{i^n}{n!} \int d^4x_1 \dots \int d^4x_n \Gamma^{(n)}(x_1, \dots, x_n) \phi_c(x_1) \dots \phi_c(x_n), \quad (2.39)$$

where $\Gamma^{(n)}$ is the OPI Green's function referred to above. A further difference between connected and OPI Green's functions is that while each external leg of a connected Green's function has a propagator factor associated with it, the OPI Green's function does not.

It is often more convenient to work in momentum space, and by taking the Fourier transform of the Green's functions, the Feynman rules can be written in momentum space.

2.3 Calculating Observable Quantities

In a physical process the incoming and outgoing particles are taken to be asymptotically free, and hence are "on-mass-shell", ie $p_i^2 = \mu^2$ where μ is the mass of the particle associated with the free scalar field, ϕ_0 , and p_i is the four-momentum of the i^{th} particle. The boundary conditions on $W[J]$ are insufficient to ensure this, so $W[J]$ contains terms involving particles which are not on-mass-shell. Hence, Green's functions are not physical observables.

By imposing boundary conditions that ensure that incoming and outgoing particles are asymptotically free, it is possible to derive a functional, $S[\phi_0]$, which yields the physically observable scattering amplitudes of the theory. $S[\phi_0]$ is given in terms of $W[J]$ via

$$S[\phi_0] = \exp \left(\int d^4x \phi_0(x) (\partial^\nu \partial_\nu + \mu^2) \frac{\delta}{\delta J(x)} \right) W[J] \Big|_{J=0}. \quad (2.40)$$

By expanding the exponential as a power series, and using (2.24), (2.40) can be

written as

$$S[\phi_0] = \sum_{n=0}^{\infty} \frac{i^n}{n!} \int d^4x_1 \dots d^4x_n \phi_0(x_1) \dots \phi_0(x_n) K_{x_1} \dots K_{x_n} G^{(n)}(x_1, \dots, x_n), \quad (2.41)$$

where K_x is the Klein-Gordon operator defined above. The term involving $G^{(n)}$ is associated with the physical process which has n incoming or outgoing particles, and as these free particles are momentum eigenstates, it is convenient to now work in momentum space, so $S[\phi_0]$ is rewritten

$$S[\phi_0] = \sum_{n=0}^{\infty} \frac{i^n}{n!} \int \frac{d^4p_1}{(2\pi)^4} \dots \frac{d^4p_n}{(2\pi)^4} (2\pi)^4 \delta^4(p_1 + \dots + p_n) (\mu^2 - p_1^2) \dots (\mu^2 - p_n^2) \tilde{G}^{(n)}(p_1, \dots, p_n) \int d^4x_1 \dots d^4x_n e^{i(p_1x_1 + \dots + p_nx_n)} \phi_0(x_1) \dots \phi_0(x_n). \quad (2.42)$$

$(2\pi)^4 \delta^4(p_1 + \dots + p_n) \tilde{G}^{(n)}$ is the Fourier transform of $G^{(n)}$, the delta-function arising from the translational invariance of the Green's functions. The $(\mu^2 - p_i^2)$ factors arise from the action of the Klein-Gordon operators on the exponential in the Fourier transform representation of $G^{(n)}$. ϕ_0 can be written in terms of Fourier components

$$\phi_0(x) = \int \frac{d^3k}{(2\pi)^3} \frac{1}{2k_0} \left(a(k) e^{-ik \cdot x} + a^*(k) e^{ik \cdot x} \right), \quad (2.43)$$

where $k_0 \equiv (\mathbf{k}^2 + \mu^2)^{\frac{1}{2}}$, so integrating over d^4x with weight $e^{ip \cdot x}$, yields

$$\int d^4x e^{ip \cdot x} \phi_0(x) = \int d^3k \frac{2\pi}{2k_0} (a(k) \delta(p - k) + a^*(k) \delta(p + k)). \quad (2.44)$$

This implies that $p_j^2 = k^2 = \mu^2$, hence ensuring that only those Green's functions whose external legs are on-mass-shell contribute to $S[\phi_0]$, as is required of a physical process. The delta-functions further ensure that $a(k)$ contributes only if $p_{j0} > 0$ (hence equal to $+k_0$), and $a^*(k)$ only if $p_{j0} < 0$. So the part of ϕ_0 involving $a(k)$ is associated with an incoming particle, and the $a^*(k)$ part with an outgoing particle. Hence for a scattering process with n particles, m of which

are incoming and $n - m$ outgoing, the scattering amplitude S_{fi} may be found from $S[\phi_0]$ by the relation

$$S_{fi} = [\rho(q_1) \dots \rho(q_n)]^{-1} \frac{\delta^n S[\phi_0]}{\delta a(q_1) \dots \delta a(q_m) \delta a^*(q_{m+1}) \dots \delta a^*(q_n)} \Big|_{a=a^*=0}, \quad (2.45)$$

where $\rho(q_i) = (2\pi)^{-3} (2q_{i0})^{-1}$ is the covariant momentum integration weight function. Evaluating at $a = a^* = 0$ ensures that only $G^{(n)}$ contributes to S_{fi} . Performing this differentiation yields

$$S_{fi} = (2\pi)^4 \delta^4(q_1 + \dots + q_m - q_{m+1} - \dots - q_n) \mathcal{M}_{fi}, \quad (2.46)$$

where the Lorentz invariant amplitude \mathcal{M}_{fi} is defined to be

$$\mathcal{M}_{fi} = (-i)^n (q_1^2 - \mu^2) \dots (q_n^2 - \mu^2) \tilde{G}^{(n)}(q_1, \dots, q_m, -q_{m+1}, \dots, -q_n), \quad (2.47)$$

and a perturbative approximation to the real scattering amplitude can now be made.

2.4 The Extension to Spinor Theories ...

The extension to spinor and gauge field theories is not trivial. The spinor fields require anticommuting Grassmann variables in the classical field theory to yield the correct results when quantized. The generating functional for a theory of a spinor field, ψ , with external source, σ , which is a Grassmann variable, is

$$W[\sigma, \bar{\sigma}] = N' \int \mathcal{D}\bar{\psi} \mathcal{D}\psi \exp\left(i \int d^4x (\mathcal{L} + \bar{\psi}\sigma + \bar{\sigma}\psi)\right), \quad (2.48)$$

where \mathcal{L} is the classical Lagrangian of the theory, see (2.12), and N' , the normalization, is chosen so that $W = 1$ when $\sigma = 0$. In a way analogous to (2.24), the Green's functions can be written

$$\begin{aligned} G^{(2n)}(x_1, \dots, x_n, y_1, \dots, y_n) &= \left\langle 0 \left| T \left(\hat{\psi}(x_1) \dots \hat{\psi}(x_n) \bar{\hat{\psi}}(y_1) \dots \bar{\hat{\psi}}(y_n) \right) \right| 0 \right\rangle, \\ &= (-1)^n \frac{\delta^{(2n)} W[\sigma, \bar{\sigma}]}{\delta \bar{\sigma}(x_1) \dots \delta \bar{\sigma}(x_n) \delta \sigma(y_1) \dots \delta \sigma(y_n)}, \end{aligned} \quad (2.49)$$

and are now antisymmetric in each set of indices x_i and y_i , as is necessary for fermions. Like the scalar field case, the generating functional can be exactly

evaluated only for the free-field case, which has the Lagrangian given by (2.5), yielding

$$W_0[\sigma, \bar{\sigma}] = \exp\left(-i \int d^4x' \int d^4x \bar{\sigma}(x') S_F(x' - x) \sigma(x)\right), \quad (2.50)$$

where $S_F(x' - x)$ is the propagator for the free Dirac field

$$S_F(x' - x) = \int \frac{d^4p}{(2\pi)^4} e^{-ip \cdot (x' - x)} \tilde{S}_F(p), \quad (2.51)$$

with Fourier transform

$$\begin{aligned} \tilde{S}_F(p) &= (\gamma^\mu p_\mu - m + i\epsilon)^{-1} \\ &\equiv \frac{\gamma^\mu p_\mu + m}{p^2 - m^2 + i\epsilon}. \end{aligned} \quad (2.52)$$

The $i\epsilon$ has been introduced to resolve the ambiguity of the pole at $p^2 = m^2$ as in the scalar case.

2.5 ... and Gauge Theories

Whilst a method analogous to scalar field theories works for spinor field theories, with gauge field theories the situation is more complex and this naïve procedure leads to overcounting degrees of freedom. This arises because $\int \mathcal{D}G_\mu$ implies integration over all gauge fields, including those connected by gauge transformations, thus introducing spurious infinities. Faddeev and Popov suggested introducing a gauge fixing term to keep the path integral in a particular gauge. A gauge may be chosen by imposing a set of conditions, usually involving the derivative of the gauge fields

$$F_a(G_b^\mu) = \partial_\mu G_a^\mu - f_a(x) = 0, \quad (2.53)$$

where the $f_a(x)$ are given functions. After a lot of work, $W[J]$ for a gauge theory with Lagrangian given by (2.5) is

$$\begin{aligned} W[J_{a\mu}] &\propto \int \mathcal{D}G_\mu \det\left(\frac{\delta F_a(x')}{\delta \alpha_b(x)}\right) \delta[F_a] \\ &\quad \times \exp\left(i \int d^4x (\mathcal{L}(G_{a\mu}) + J_a^\mu G_{a\mu})\right), \end{aligned} \quad (2.54)$$

where the α_a are the gauge parameters defined above, $\mathcal{L}(G_{a\mu})$ is given by (2.12), and $\delta[F_a]$ is a functional delta-function which fixes the gauge. The determinant

and delta function must be expressed in terms of exponentials if a perturbation series is to be developed. Multiplying (2.54) by the constant

$$\int \mathcal{D}f_c \exp\left(-\frac{i}{2\xi} \int d^4x f_a^2(x)\right), \quad (2.55)$$

where the f_a are defined in (2.53), and ξ is an arbitrary constant known as the gauge fixing parameter, allows (2.54) to be written

$$W[J_a^\mu] \propto \int \mathcal{D}G^\mu \det\left(\frac{\delta F_a(x')}{\delta \alpha_b(x)}\right) \exp\left(i \int d^4x \left(\mathcal{L}(G_{a\mu}) + J^{a\mu}G_{a\mu} - \frac{1}{2\xi} (\partial^\mu G_{a\mu})^2\right)\right), \quad (2.56)$$

due to the action of the delta-function. The constant can be absorbed into the normalization.

To convert the determinant requires the introduction of what are known as the Faddeev-Popov ghost fields – fields which are not physical fields but merely devices to enable the determinant to be written as an exponential. The ghost fields are complex Grassmann variables, η_a , with spin 0. After more work the generating functional for a gauge theory with Lagrangian \mathcal{L} , may be written

$$W[J_a^\mu] \propto \int \mathcal{D}G^\mu \int \mathcal{D}\eta^* \mathcal{D}\eta \times \exp\left(i \int d^4x \left(\mathcal{L}(G_{a\mu}) + J_a^\mu G_{a\mu} - \frac{1}{2\xi} (\partial^\mu G_{a\mu})^2 + \mathcal{L}_{FP}\right)\right), \quad (2.57)$$

where \mathcal{L}_{FP} is the Lagrangian for the ghost fields

$$\mathcal{L}_{FP} = \partial_\mu \eta_a^* (\partial^\mu \eta_a + g f_{abc} \eta_b G_c^\mu). \quad (2.58)$$

As for the scalar field theory, Green's functions and hence Feynman rules may now be evaluated. The ghost fields, being unphysical fields, never appear as external legs of a diagram that contributes to a physical process – they only occur in loops – and are necessary to maintain gauge invariance. Physical quantities are also independent of the gauge fixing parameter, ξ , although quantities such as Green's functions may depend on it.

The above Lagrangians for spinor and gauge fields, with attendant ghost fields and gauge fixing terms, together with the source terms, may be combined to give the full Lagrangian for theories such as QCD and QED;

$$\begin{aligned}
W [J_a^\mu, \sigma, \bar{\sigma}] = N \int \mathcal{D}\bar{\psi} \mathcal{D}\psi \int \mathcal{D}G^\mu \int \mathcal{D}\eta^* \mathcal{D}\eta \\
\exp \left(i \int d^4x \left(\mathcal{L}(\psi) + \mathcal{L}(G_{a\mu}) - \frac{1}{2\xi} (\partial^\mu G_{a\mu})^2 \right. \right. \\
\left. \left. + \mathcal{L}_{FP} + J_a^\mu G_{a\mu} + \bar{\psi}\sigma + \bar{\sigma}\psi \right) \right). \quad (2.59)
\end{aligned}$$

2.6 Renormalization

Unfortunately, when an attempt is made to evaluate the Feynman diagrams that contribute to a physical process, it is found that diagrams that contain one or more loops may result in infinities. As the momentum of the loop is unrestricted, these infinities arise from terms such as

$$\int d^4k \frac{1}{(k^2 - \mu^2)^m}, \quad (2.60)$$

where k is the momentum around the loop. For large values of k , this integral goes as

$$\int d|k| \frac{|k|^3}{|k|^{2m}}. \quad (2.61)$$

For $m = 3$ this integral is convergent, but for $m = 2$ a logarithmic divergence arises, and if $m = 1$ the divergence is quadratic.

To get finite answers the Lagrangian in use until now, known as the bare Lagrangian, can not be used as it stands. By absorbing the infinities of the bare fields and parameters into multiplicative constants, renormalized fields and parameters can be defined. The Lagrangian now consists of the counterterms and a set of terms which has the same structure as the bare Lagrangian, but the fields and parameters used are the renormalized ones. If these replacements are insufficient to remove the infinities the theory is deemed unrenormalizable. For the sake of simplicity the scalar field theory $\lambda\phi^4$ will be used to illustrate the discussion, and the extension to spinor and gauge field theories will be discussed later.

Before being able to renormalize the theory, it is necessary to regularize the expressions of the perturbative expansion to give a precise meaning to what are otherwise merely formal, divergent expressions. To preserve local gauge invariance, dimensional regularization can be used, in which a space-time continuum of 2ω dimensions replaces the normal four dimensions. This reduces the powers of $|k|$ coming from the volume element in (2.60), and makes the integral finite for $\omega < 2$. However, the Green's functions now depend on ω , and those Green's functions which in four dimensions were divergent, now, usually, have poles at $\omega = 2$. To see this, consider the following integral, which contributes to the 2-particle OPI Green's function, $\Gamma^{(2)}$,

$$\lambda\Delta_F(0;\mu) = \lambda \int \frac{d^4k}{(2\pi)^4} (k^2 - \mu^2 + i\epsilon)^{-1}, \quad (2.62)$$

where μ is the mass of the particle associated with the scalar field, and λ is the coupling constant. In 2ω dimensions this becomes

$$\lambda\Delta_F(0;\omega,\mu) = -i\lambda \int \frac{d^{2\omega}\bar{k}}{(2\pi)^{2\omega}} (\bar{k}^2 + \mu^2)^{-1}, \quad (2.63)$$

where a Wick rotation to Euclidean space has been performed.

Although in four dimensions λ is dimensionless, in 2ω dimensions this is not the case. Requiring the action,

$$S = \int d^{2\omega}x \mathcal{L}, \quad (2.64)$$

to be dimensionless, implies that the field, ϕ , and the coupling constant, λ , have dimensions given by

$$\begin{aligned} [\phi] &= M^{\omega-1} \\ [\lambda] &= M^{4-2\omega}. \end{aligned} \quad (2.65)$$

Hence it is possible to define a dimensionless parameter, $\hat{\lambda}$, via

$$\hat{\lambda} \equiv \lambda M^{2\omega-4}, \quad (2.66)$$

where M is an arbitrary parameter with the dimensions of mass.

On integration, (2.63) becomes

$$\begin{aligned}\lambda\Delta_F(0;\omega,\mu) &= \frac{-i\mu^{2\omega-2}}{(4\pi)^\omega} \frac{\hat{\lambda}}{(M^2)^{\omega-2}} \Gamma(1-\omega) \\ &= \frac{i\mu^2\hat{\lambda}}{16\pi^2} \left(\frac{1}{2-\omega} + \Gamma'(1) + 1 - \ln\left(\frac{\mu^2}{4\pi M^2}\right) + O(\omega-2) \right),\end{aligned}\tag{2.67}$$

where the dimensionless quantity $\frac{\mu^2}{M^2}$ has been expanded in powers of $\omega-2$, and the gamma function has been expanded about its pole at $\omega-2$. As stated above, the regularized integral now has a pole at $\omega-2$.

As renormalization is not a physically based process there is nothing to indicate a specific method for removing the pole at $\omega=2$. A variety of ways of carrying out this process exist, and these methods are known as renormalization schemes, RSs. Choosing a RS indicates the exact way of removing the pole at $\omega=2$, and may include the removal of some incidental finite parts. A more complete description of renormalization schemes will be given later. Once the diagrams have been renormalized, the limit as $\omega\rightarrow 2$ is taken, and the finite parts remaining are the values of the diagrams in the RS used, and at the chosen mass scale. These finite parts do not depend on the way the integrals were regularized – only on the RS.

In the case of spinor theories it is possible to define the anticommutator and trace of the gamma matrices in d dimensions, and hence the identities for contractions and traces of products of gamma matrices. So dimensional regularization is possible in theories with spinors, with the exception of those diagrams which have an odd number of γ_5 matrices.

Taking as the bare Lagrangian

$$\mathcal{L}_B = \frac{1}{2} (\partial_\mu \phi_B) (\partial_\mu \phi_B) - \frac{1}{2} \mu_B^2 \phi_B^2 - \frac{1}{4!} \lambda_B \phi_B^4,\tag{2.68}$$

where μ_B is the bare mass and λ_B is the bare coupling, the bare scalar field can be written

$$\phi_B = Z^{\frac{1}{2}} \phi,\tag{2.69}$$

where Z is known as the wave function renormalization constant. Because of

quantum corrections, Z differs from 1 by an infinite amount, and may be written

$$Z = 1 + \delta Z. \quad (2.70)$$

The renormalized mass and coupling constants may be written in a similar style

$$\mu_B^2 = (\mu^2 + \delta\mu^2) Z^{-1}, \quad (2.71a)$$

$$\lambda_B = (\lambda + \delta\lambda) Z^{-2}. \quad (2.71b)$$

This form with explicit factors of Z is chosen so that the renormalized Lagrangian has the same structure as the bare Lagrangian. Again $\delta\mu^2$ and $\delta\lambda$ are non-zero due to quantum corrections from the interactions, and so can be written as power series in the coupling, λ :

$$\delta\mu^2 = \sum_{i=1}^{\infty} \delta\mu_i^2, \quad (2.72a)$$

$$\delta Z = \sum_{i=1}^{\infty} \delta Z_i, \quad (2.72b)$$

$$\delta\lambda = \sum_{i=2}^{\infty} \delta\lambda_i, \quad (2.72c)$$

where the power series for $\delta\lambda$ starts at $O(\lambda^2)$.

Substituting (2.69), (2.71a) and (2.71b) into (2.68), and using (2.70), the Lagrangian may be written

$$\begin{aligned} \mathcal{L}_B = & \frac{1}{2} (\partial_\mu \phi) (\partial_\mu \phi) - \frac{1}{2} \mu^2 \phi^2 - \frac{1}{4!} \lambda \phi^4 \\ & + \frac{1}{2} \delta Z (\partial_\mu \phi) (\partial_\mu \phi) - \frac{1}{2} \delta\mu^2 \phi^2 - \frac{1}{4!} \delta\lambda \phi^4, \end{aligned} \quad (2.73)$$

This Lagrangian has the above-mentioned structure; the first three terms on the right hand side have the same structure as the bare Lagrangian, (2.68), and the remaining terms are the counterterms,

$$\delta\mathcal{L} = \frac{1}{2} \delta Z (\partial_\mu \phi) (\partial_\mu \phi) - \frac{1}{2} \delta\mu^2 \phi^2 - \frac{1}{4!} \delta\lambda \phi^4. \quad (2.74)$$

An alternate way of splitting (2.73) is to notice that the first two terms form the free-field Lagrangian for the renormalized fields, see (2.17). The remaining

terms, denoted \mathcal{L}_1 , are the interaction terms of the theory;

$$\mathcal{L}_1 = \frac{1}{4!}\lambda\phi^4 + \delta\mathcal{L}. \quad (2.75)$$

Using the procedure outlined above in §2.2, the Feynman rules for this Lagrangian can be derived, and are found to be the same as before with the addition of two rules associated with the counterterms. The OPI Green's functions for the renormalized theory are functions of the renormalized parameters and the counterterm parameters. For example, the 2-particle OPI Green's function in momentum space, to first order in λ is

$$\tilde{\Gamma}^{(2)}(p, -p) = p^2 (1 + \delta Z_1) - \left(\mu^2 + \frac{1}{2}\lambda i\Delta_F(0) + \delta\mu_1^2 \right) + O(\lambda^2), \quad (2.76)$$

where the first term in each of (2.72a) and (2.72b) has been used. Upon substitution of (2.67), (2.76) becomes

$$\begin{aligned} \tilde{\Gamma}^{(2)}(p, -p) &= p^2 (1 + \delta Z_1) - \mu^2 - \delta\mu_1^2 \\ &\quad + \frac{\hat{\lambda}\mu^2}{32\pi^2} \left(\frac{1}{2-\omega} + \Gamma'(1) + 1 - \ln \left(\frac{\mu^2}{4\pi M^2} \right) + O(\omega - 2) \right) \\ &\quad + O(\lambda^2). \end{aligned} \quad (2.77)$$

Since $\tilde{\Gamma}^{(2)}$ is a physical, and therefore observable, quantity, it must be finite as $\omega \rightarrow 2$, which means that

$$\begin{aligned} \delta\mu_1^2 - \frac{\hat{\lambda}\mu^2}{32\pi^2} \frac{1}{2-\omega} &\rightarrow \text{constant}, \\ \delta Z_1 &\rightarrow \text{constant}. \end{aligned} \quad (2.78)$$

A calculation of $\tilde{\Gamma}^{(4)}$ to order λ^2 yields, as $\omega \rightarrow 2$,

$$\frac{3\lambda\hat{\lambda}}{32\pi^2} \frac{1}{2-\omega} - \delta\lambda_2 \rightarrow \text{constant}. \quad (2.79)$$

The infinities cancel, leaving a finite part. These as yet unspecified pieces depend on the renormalization scheme chosen – i.e. the way in which the divergences are removed – and are somewhat arbitrary. For example, in the “minimal subtraction” scheme, MS, the coefficients in the expansions (2.72a)-(2.72c) are chosen

so that only the poles are cancelled – equivalent to setting all the “constants” in (2.78) and (2.79) equal to zero. Rewriting (2.72a), for instance, as

$$\delta\mu^2 = \mu^2 \left(c_0 \left(\hat{\lambda}, M/\mu, \omega \right) + \sum_{n=1}^{\infty} \frac{c_n \left(\hat{\lambda}, M/\mu \right)}{(2-\omega)^n} \right), \quad (2.80)$$

in the MS scheme, c_0 is chosen to be zero so no extra finite parts are added or subtracted, and $c_1^{MS} = \frac{\hat{\lambda}}{32\pi^2}$. So $\tilde{\Gamma}^{(2)}$ in the MS scheme becomes

$$\tilde{\Gamma}^{(2)MS}(p, -p) = p^2 - \mu^2 + \frac{\lambda\mu^2}{32\pi^2} \left(\Gamma'(1) + 1 - \ln \left(\frac{\mu^2}{4\pi M^2} \right) \right) + O(\lambda^2), \quad (2.81)$$

where the limit as $\omega \rightarrow 2$ has been taken.

In expanding the $(4\pi)^{2-\omega}\Gamma(2-\omega)$ which occurs in dimensional regularization, a $\Gamma'(1)$ and a $\ln(4\pi)$ always appear. By subtracting these two extra terms along with the term containing the pole, a related scheme, denoted \overline{MS} , is defined. In QCD this is the most computationally convenient scheme, the only three loop results having been calculated in this scheme.

In general, the coefficients in the expansions of $\delta\mu^2$, $\delta\lambda$ and δZ depend on the ratio M/μ , but the MS scheme belongs to a special class of schemes where the coefficients are mass independent, and are the only ones to be considered here. For a fuller discussion on renormalization schemes, see chapter 3.

2.7 Renormalization of Spinor and Gauge Field Theories

Fortunately the extension to QCD and QED, with both spinor and gauge fields, is not quite as complicated as might be assumed from the number of different interaction terms in the Lagrangian. It is possible to prove that gauge invariance of the bare Lagrangian implies gauge invariance of the renormalized Lagrangian, and hence only a single renormalized coupling is needed. As in the scalar field case, the bare fields are written in terms of the renormalized fields and the multiplicative constants called wave function renormalization constants

$$\begin{aligned} G_{Ba}^\mu &= Z_G^{\frac{1}{2}} G_a^\mu \\ \psi_B &= Z_\psi^{\frac{1}{2}} \psi \\ \eta_{Ba} &= Z_\eta^{\frac{1}{2}} \eta_a. \end{aligned} \quad (2.82)$$

By again requiring the Lagrangian to be of the form

$$\mathcal{L}_B = \mathcal{L} + \delta\mathcal{L}, \quad (2.83)$$

where \mathcal{L} has the same structure as \mathcal{L}_B , see (2.59), but with renormalized fields and parameters, and $\delta\mathcal{L}$ contains the counterterms, it can be shown that ξ_B and g_B obey the following relations:

$$\begin{aligned} \xi_B^{-1} &= \xi^{-1} Z_\xi Z_G^{-1} \\ g_B &= g Z_1 Z_\eta^{-1} Z_G^{-\frac{1}{2}} \\ &= g Z_2 Z_\psi^{-1} Z_G^{-\frac{1}{2}} \\ &= g Z_3 Z_G^{-\frac{3}{2}} \\ &= g Z_4^{\frac{1}{2}} Z_G^{-1}. \end{aligned} \quad (2.84)$$

Since there is only one bare and one renormalized coupling constant, the renormalization constants must have the following relationships:

$$Z_1 Z_\eta^{-1} = Z_2 Z_\psi^{-1} = Z_3 Z_G^{-1} = Z_4^{\frac{1}{2}} Z_G^{-\frac{1}{2}}. \quad (2.85)$$

The renormalization constants can be written in a fashion similar to (2.69)-(2.71b), ie

$$\begin{aligned} Z_i &= 1 + \delta Z_i & i &= G, \psi, \eta \\ Z_j &= 1 + K_j & j &= 1, \dots, 4, \xi \end{aligned} \quad (2.86)$$

where again the δZ 's have power series expansions in terms of the dimensionless renormalized coupling, \hat{g} , defined by

$$g = \mu^{\frac{\epsilon}{2}} \hat{g}, \quad (2.87)$$

where the number of dimensions is $4 - \frac{\epsilon}{2}$, and μ is the renormalization point. It is this quantity, \hat{g} , on which the Green's functions depend.

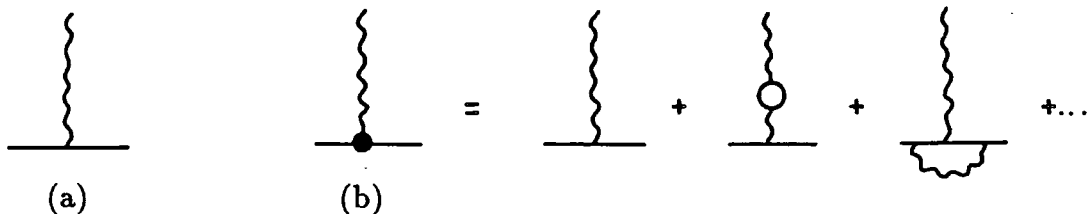

Figure 2.1 The bare coupling in the unrenormalized theory is given by one diagram, see (a). In the renormalized theory, an infinite series of diagrams contribute to the effective coupling, see (b).

So $\delta\mathcal{L}$ is of the form

$$\begin{aligned}
\delta\mathcal{L} = & -\frac{1}{4}\delta Z_A (\partial_\mu G_{a\nu} - \partial_\nu G_{a\mu}) (\partial^\mu G_a^\nu - \partial^\nu G_a^\mu) - \frac{K_\xi}{2\xi} (\partial_\mu G_a^\mu)^2 \\
& + \delta Z_\eta \partial_\mu \eta_a^* \partial^\mu \eta_a + \delta Z_\psi \bar{\psi} i \gamma^\mu \partial_\mu \psi + g K_1 \partial_\mu \eta_a^* \eta_b G_c^\mu f_{abc} \\
& - g K_2 \bar{\psi} \gamma^\mu T_a \psi G_{a\mu} + g K_3 f_{abc} G_b^\mu G_c^\nu \partial_\mu G_{a\nu} \\
& - \frac{g^2}{4} K_4 f_{abc} f_{ade} G_b^\mu G_c^\nu G_{d\mu} G_{e\nu}.
\end{aligned} \tag{2.88}$$

Alternatively, the Lagrangian (2.83) can be split into the free-field Lagrangian for the renormalized fields, \mathcal{L}_0 , see (2.5), and a Lagrangian containing the interaction terms of the theory, \mathcal{L}_1 . In this form, and using the procedure outlined above, it may be used to generate the Green's functions and Feynman rules for the theory.

2.8 The β -function and Dimensional Transmutation

In the bare theory, the coupling is just a parameter, and is represented by a single diagram, see figure 2.1a. However, in the process of renormalization, the renormalized, “dressed” or effective coupling is represented by an infinite series of diagrams, see figure 2.1b. Contributions from loop diagrams will be RS dependent, and hence depend on the renormalization point, μ . So the renormalized coupling is a much more complex quantity than its bare counterpart.

The dependence of \hat{g} on μ can be found by using the fact that the bare coupling, g_B , is independent of μ ,

$$\mu \frac{dg_B}{d\mu} = 0. \tag{2.89}$$

g_B and \hat{g} are related by, see (2.84),

$$\begin{aligned} g_B &= g Z_2 Z_\psi^{-1} Z_G^{-\frac{1}{2}} \\ &= \mu^{\frac{\epsilon}{2}} \hat{g} Z_2 Z_\psi^{-1} Z_G^{-\frac{1}{2}}. \end{aligned} \quad (2.90)$$

Using (2.86), and keeping only the first term of the expansions in \hat{g} , this becomes

$$g_B = \mu^{\frac{\epsilon}{2}} \hat{g} \left(1 - \frac{b_0 \hat{g}^2}{\epsilon} \right), \quad (2.91)$$

where b_0 is a linear combination of the three lowest term coefficients of each of the series expansions of the δZ 's:

$$b_0 = \frac{1}{(4\pi)^2} \left(\frac{11}{3} C_2(A) - \frac{4}{3} T_2(F) N_f \right). \quad (2.92)$$

$C_2(A)$ and $T_2(F)$ are factors which depend only on the gauge group, and N_f is the number of fermions which couple to the gauge boson. Differentiating and rearranging gives

$$\begin{aligned} \mu \frac{\partial \hat{g}}{\partial \mu} &= -\frac{\epsilon}{2} \hat{g} - b_0 \hat{g}^3 \\ &= -b_0 \hat{g}^3, \end{aligned} \quad (2.93)$$

in the limit $\epsilon \rightarrow 0$, that is in four dimensions.

The solution of this equation may be found by integration:

$$\frac{-1}{b_0} \int_{\hat{g}_0}^{\hat{g}} \frac{d\hat{g}'}{d\hat{g}'^3} = \int_{\mu_0}^{\mu} \frac{d\mu}{\mu}, \quad (2.94)$$

where $\hat{g}_0 = \hat{g}(\mu_0)$, and μ_0 is some value of μ . So

$$\frac{1}{2b_0} \left(\frac{1}{\hat{g}^2} - \frac{1}{\hat{g}_0^2} \right) = \ln \left(\frac{\mu}{\mu_0} \right), \quad (2.95)$$

and rearranging yields

$$\frac{1}{\hat{g}^2} - 2b_0 \ln \left(\frac{\mu}{m} \right) = \frac{1}{\hat{g}_0^2} - 2b_0 \ln \left(\frac{\mu_0}{m} \right), \quad (2.96)$$

where m is an arbitrary massive constant introduced temporarily to take care of dimensions. Since the right hand side is a constant, it can be written in the

more convenient form of $-2b_0 \ln\left(\frac{\Lambda}{m}\right)$, where Λ is a constant with dimensions of mass, and must be determined experimentally. So

$$\hat{g}^2 = \frac{1}{2b_0 \ln\left(\frac{\mu}{\Lambda}\right)}. \quad (2.97)$$

The appearance of a massive constant in a theory whose Lagrangian has only dimensionless parameters is known as dimensional transmutation. The constant appears as the theory does not uniquely define the first derivative of \hat{g} , since it does not give a boundary condition – this must be supplied by experiment. Stevenson claims that this is because “the Lagrangian we input is not one single theory but a one-parameter set of theories with different bare coupling constants, g_B ” [7].

Since the renormalization point is somewhat arbitrary, it is usually taken to be some characteristic momentum of the process under consideration, such as the momentum transfer in deep inelastic scattering. Hence the coupling is taken to be a function of momentum, and is called the running coupling. ^{The RHS of} Equation (2.93), which governs the evolution of \hat{g} with momentum, is called the β -function. The constant, b_0 , depends only on the gauge group and the number of fermions that couple to the gauge boson. If b_0 is negative, then the coupling increases with momentum, so for large distances the coupling goes to zero, and the theory becomes free. This is the case in QED. The situation for QCD on the other hand, where b_0 is positive, is quite different. The coupling now decreases with increasing momentum, leading to asymptotic freedom. For low momentum, the coupling grows, implying the possibility of confinement. In this region perturbation theory is no longer valid.

2.9 The Renormalization Group Equation

In calculating a physical quantity or Green’s function, an infinite number of parameters, one for each order of perturbation theory, is needed to prescribe the RS used. Physical quantities and bare Green’s functions are independent of these parameters, so under any change of parameter, in particular the renormalization point, μ , $\tilde{\Gamma}_B^{(n)}$ is invariant. This can be used to show how its renormalized counterpart, $\tilde{\Gamma}^{(n)}$ and \hat{g} and ξ , the coupling constant and the gauge parameter respectively, must change under a change in μ .

Consider an n -particle OPI Green's function, $\tilde{\Gamma}^{(n)}(p_1, \dots, p_n, \hat{g}, \xi, \mu)$ with n_G gauge field and n_ψ fermion field external legs. $\tilde{\Gamma}^{(n)}$ is related to $\tilde{\Gamma}_B^{(n)}$ via

$$\tilde{\Gamma}^{(n)}(p_1, \dots, p_n, \hat{g}, \xi, \mu) = Z_G^{\frac{n_G}{2}} Z_\psi^{\frac{n_\psi}{2}} \tilde{\Gamma}_B^{(n)}(p_1, \dots, p_n, g_B, \xi_B), \quad (2.98)$$

where Z_G and Z_ψ are as given in §2.7. Differentiating with respect to μ yields

$$\begin{aligned} \mu \frac{d}{d\mu} \tilde{\Gamma}^{(n)} &= \left(\mu \frac{\partial}{\partial \mu} + \mu \frac{\partial \hat{g}}{\partial \mu} \frac{\partial}{\partial \hat{g}} + \mu \frac{\partial \xi}{\partial \mu} \frac{\partial}{\partial \xi} \right) \tilde{\Gamma}^{(n)} \\ &= \left(\frac{n_G}{2} Z_G^{-1} \mu \frac{\partial Z_G}{\partial \mu} + \frac{n_\psi}{2} Z_\psi^{-1} \mu \frac{\partial Z_\psi}{\partial \mu} \right) Z_\psi^{\frac{n_\psi}{2}} Z_G^{\frac{n_G}{2}} \tilde{\Gamma}_B^{(n)} \end{aligned} \quad (2.99)$$

where each partial differentiation is done holding the other parameters fixed. The dimensionless coefficients can be written

$$\begin{aligned} \beta_{\hat{g}} &= \mu \frac{\partial \hat{g}}{\partial \mu} \\ \beta_\xi &= \mu \frac{\partial \xi}{\partial \mu} \\ \gamma_G &= Z_G^{-\frac{1}{2}} \mu \frac{\partial Z_G^{\frac{1}{2}}}{\partial \mu} \\ \gamma_\psi &= Z_\psi^{-\frac{1}{2}} \mu \frac{\partial Z_\psi^{\frac{1}{2}}}{\partial \mu}. \end{aligned} \quad (2.100)$$

$\beta_{\hat{g}}$, β_ξ , γ_G and γ_ψ have perturbation series expansions which depend on \hat{g} and the RS chosen, with $\beta_{\hat{g}}$ as given above, see (2.93).

Using (2.100) and (2.98), (2.99) becomes

$$\left(\mu \frac{\partial}{\partial \mu} + \beta_{\hat{g}} \frac{\partial}{\partial \hat{g}} + \beta_\xi \frac{\partial}{\partial \xi} - n_G \gamma_G - n_\psi \gamma_\psi \right) \tilde{\Gamma}^{(n)}(p_1, \dots, p_n, \hat{g}, \xi, \mu) = 0, \quad (2.101)$$

the renormalization group equation for $\tilde{\Gamma}^{(n)}$.

2.10 Large Orders in Perturbation Theory

Despite the ability to remove infinities through renormalization, and the improvement due to the renormalization group equation, there is still reason to believe that perturbation series in QCD and QED are divergent, and at best are

asymptotic. There is evidence that the β -function coefficients grow as $n!$, and it is not definite whether the β -functions are Borel summable. Even if they are, do they recover the original function or are there terms which are invisible to perturbation theory?

As far back as 1952 Dyson had shown that perturbation series in QED were divergent [8]. His argument was that if the QED coupling constant is replaced by one with the same magnitude but opposite sign, so that opposite charges now repelled, the ground state of this theory would be very different from QED as it is known. A perturbation around the “trivial” QED vacuum would not describe this new theory well at all. Hence, in QED perturbation series are non-analytic in α at $\alpha = 0$, where α is the QED coupling constant, and hence have zero radius of convergence. Itzykson and Zuber [6] use the following example to illustrate Dyson’s argument. An ordinary integral is sufficient to model what happens in the path integral case so

$$Z(g) = \frac{1}{\sqrt{2\pi}} \int_{-\infty}^{\infty} d\phi \exp \left\{ - \left(\frac{1}{2}\phi^2 + g\phi^4 \right) \right\}. \quad (2.102)$$

Although the integral is well defined for g away from the negative real axis, it blows up as g approaches that axis, and hence $g = 0$ is an essential singularity. If $\frac{1}{2}\phi^2 + g\phi^4$ is taken to be a caricature of the action of a field, with the ϕ as the value of the field at a point, then negative values of g correspond to the situation where the “potential” is not bounded below. $Z(g)$ can be expanded as a power series in g :

$$Z(g) = \sum_{k=0}^{\infty} Z_k g^k, \quad (2.103)$$

where

$$Z_k = \frac{(-1)^k}{\sqrt{2\pi}} \int_{-\infty}^{\infty} d\phi \frac{\phi^{4k}}{k!} \exp - \left(\frac{1}{2}\phi^2 \right) \quad (2.104a)$$

$$= (-1)^k 4^k \frac{\Gamma(2k + \frac{1}{2})}{\sqrt{\pi} k!} \quad (2.104b)$$

This can be used to show that in the complex g plane with a cut along the

negative real axis, the power series in g is asymptotic:

$$\left| Z(g) - \sum_{k=0}^n Z_k g^k \right| < \frac{4^{n+1} \Gamma(2n + \frac{3}{2})}{\sqrt{\pi} (n+1)!} \frac{|g|^{n+1}}{[\cos(\frac{1}{2} \arg g)]^{2n + \frac{3}{2}}}. \quad (2.105)$$

That is, for fixed n , the right hand side of (2.105) can be made arbitrarily small for small g .

In the above example, for large k it is possible to use Stirling's formula for $k!$ in (2.104b), but in general an exact evaluation of (2.104a) is not feasible, and the method of steepest descents must be employed to find an approximation to it. Here both methods yield the same result

$$Z_k \sim \frac{(-16)^k}{\sqrt{\pi}} \exp\left(\left(k - \frac{1}{2}\right) \ln k - k\right) \quad (2.106)$$

for large k .

In real field theories some work has been done towards finding a general form for the β -function coefficients at large k . Lipatov [9] showed that in a ϕ^4 theory, the high-order β -function coefficients go as

$$\begin{aligned} \beta_k &\sim (-1)^k \frac{C}{16\pi^2} k^4 \left(\frac{k}{e}\right)^k \\ &\sim (-1)^k k! k^{\frac{7}{2}} C \left(1 + O\left(\frac{1}{k}\right)\right), \end{aligned} \quad (2.107)$$

using Stirling's approximation. The constant $C \sim 2.75$ in the momentum subtraction scheme in which Lipatov worked, and is the only factor in (2.107) which is RS dependent.

It is interesting to compare the values given by this approximate expression with the exact one calculated by Chetyrkin *et al* [10] and Kazakov [11], despite being outside the region of validity and the fact that Chetyrkin *et al* and Kazakov use the minimal subtraction scheme; see table (2.1), which shows that even for low values of k the approximation holds well. The coefficients show alternating sign behaviour, and grow rapidly, although the growth is more like 10^k than $k!$ at present.

	exact	approximate
β_2	1.5	0.15
β_3	-2.83	-1.90
β_4	16.27	20.9
β_5	-135.80	-229.
β_6	1420.69	2610.

Table 2.1 Exact and approximate β -function coefficients in $\lambda\phi^4$ theory.

Exact calculations of the QED β -function coefficients up to four loops have been made, see Gorishny et al [12], and although the alternating sign behaviour is hinted at, the growth is nowhere near factorial. As far as the perturbation series itself is concerned, the QED expansion parameter, α , is sufficiently small that it is expected that the series will not start to diverge until after about $\pi/\alpha \sim 400$ terms; a fairly reasonable number of terms. For QCD the situation is somewhat more drastic as the coupling is much larger and non-perturbative phenomena play a greater rôle, and it is expected that perhaps only the first few terms will converge.

However, there are ways of summing divergent series if they obey certain criteria. One such method is Borel summation, where the Borel transform $F_B(u)$ is defined from the perturbation series (2.103)

$$F_B(u) = \sum_{k=0}^{\infty} \frac{Z_k u^k}{k!}. \quad (2.108)$$

The series will have some radius of convergence in the complex u plane. Providing $F_B(u)$ may be continued along the positive real axis and does not grow too fast at infinity, the original function is found from

$$Z(g) = \int_0^{\infty} du e^{-\frac{u}{g}} F_B(u). \quad (2.109)$$

If $F_B(u)$ has a singularity on the positive real axis then obviously this method fails. Such a pole might arise from fixed sign coefficients in the series expansion. While it is encouraging that Lipatov's approximation shows alternating sign, work by Bogomolny and Fatayev [13] suggests that for Yang-Mills theories, the β -function coefficients do not have this type of behaviour. Further, Borel

summation recovers the original function only if it did not involve perturbatively invisible terms such as $\exp\left(-\frac{1}{g}\right)$. Terms whose derivatives vanish along the positive real axis do not contribute to the series expansion, and it is known that contributions to physical quantities do come from “higher twist” terms of this form. So perturbation theory is not expected to be the whole answer for a physical quantity.

Even if perturbation series in QCD can be summed, how does this function relate to the real physical observable in question? How significant are the contributions from non-perturbative phenomena such as renormalons and higher twist terms, which so far have been neglected? These questions have yet to be answered although much work has been done on this subject, but it is beyond the scope of this thesis to review such work, although they will be briefly discussed again in §4.10.

3 Various Renormalization Schemes

3.1 Introduction

As has been indicated in the previous chapter, theoretical estimates of physical quantities may be calculated from the appropriate renormalized Lagrangian using perturbation theory. This estimate, if summed to all orders, would be independent of the RS chosen, since the RS has no physical significance, but in practice the whole series is not calculated. The number of diagrams needed to evaluate each order in perturbation theory grows exceedingly rapidly, (for the anomalous magnetic moment of the electron in QED, 891 diagrams are needed to evaluate the coefficient of the fourth order in α , and 12,672 for the fifth order), and the sheer technical difficulty in merely evaluating a multiloop diagram make these calculations prohibitively expensive in time and computing. At present only the first few terms in any series is known, and it is likely to remain that way in the foreseeable future. So any approximation depends on the RS used to calculate it.

Formally, the dependence is such that a quantity calculated in two RSs to order α^n , where α is the expansion parameter, will differ by a term of order α^{n+1} . That is

$$R^{(n)}(RS) = R^{(n)}(RS') + O(\alpha^{n+1}). \quad (3.1)$$

At this order the approximant, $R^{(n)}$, is a function of the $n - 1$ variables that specify the RS – one for each order in α . So choosing a RS is equivalent to choosing a point on the $n - 1$ dimensional surface defined by $R^{(n)}$. Hence it may be possible to choose the RS in such a way as to obtain, at n^{th} order, almost any answer.

Note that at zeroth order only tree-level diagrams, those involving no loops, contribute to $R^{(0)}$; hence there is no need to renormalize these diagrams, and $R^{(0)}$ does not depend on any RS parameters. At first order, the coefficient of the couplant, a , is also an RS invariant, so $R^{(1)}$ depends linearly on the couplant, and hence the renormalization point, τ .

As the RS's themselves have no physical significance, there is nothing to indicate which is the “best” or “right” RS to use. Presumably, as only the

first few terms are known, those RS which give the closest approximation to the experimental result are the “best” – assuming that non-perturbative phenomena play an insignificant part. However, such a definition of “best” would rather compromise the predictive power of perturbation theory.

It could be asked why this problem does not seem to occur in QED where exceedingly good agreement is achieved between theoretical calculations and experimental measurement, in particular the calculation of the anomalous magnetic moment of the electron. The expansion parameter used is the fine structure constant, $\alpha \simeq 1/137$, defined at low energies. The scheme associated with this value of α is known as the “on-shell” scheme. This is because α is defined to be the effective charge of the electron in threshold Thompson scattering, ie scattering of on-shell photons off on-shell electrons. This scheme works well for low energy processes, ie those with characteristic energies of the order of the electron mass, like the anomalous magnetic moment of the electron. For high energy processes however, where the centre of mass energy is several orders of magnitude higher, using this RS does not give a good approximation. A higher scale for the renormalization point gives better answers – and the corresponding value of α is larger.

Various suggestions for choosing the “optimum” RS have been made, and this chapter will review these methods, having first introduced some necessary notation. The notation is based on that used by Stevenson [4].

3.2 Notation

In practice, calculations are made using $\alpha = \hat{g}^2/4\pi$ as the expansion parameter, with β -function

$$\beta(\alpha) \equiv 4\pi \frac{\partial \alpha}{\partial \ln \left(\frac{\mu}{\Lambda}\right)^2} = -\beta_0 \alpha^2 - \frac{\beta_1}{4\pi} \alpha^3 - \dots, \quad (3.2)$$

where $\beta_0 = (4\pi)^2 b_0$, with b_0 as given in §2.8. In this thesis however, the expansion parameter $a = \alpha/\pi$ will be used. a is called the couplant, and the associated

β -function is

$$\begin{aligned} b \frac{\partial a}{\partial \tau} &= \beta(a) \\ &= -ba^2 (1 + ca + c_2 a^2 + \dots) \\ &= 2\pi^2 \beta(\alpha), \end{aligned} \quad (3.3)$$

where

$$\begin{aligned} \tau &= b \ln \left(\frac{\mu}{\Lambda} \right) \\ b &= \frac{\beta_0}{2} = \frac{1}{6} (11C_2(A) - 4N_f T_2(F)) \\ c &= \frac{\beta_1}{\beta_0} \\ c_2 &= \frac{\beta_2}{4\beta_0} \\ &\text{etc.} \end{aligned} \quad (3.4)$$

b and c are scheme and process invariant, depending only on the gauge group and the number of flavours. The β -function can be integrated to obtain τ as a function of a ;

$$\tau = \frac{1}{a} + c \ln \left(\frac{ca}{1+ca} \right) + \int_0^a dx \frac{(c_2 + c_3 x + \dots)}{(1+cx)(1+cx+c_2 x^2 + \dots)}. \quad (3.5)$$

As said before, the boundary condition for (3.3) is not given by the theory, but must be determined experimentally, and results in the RS-dependent parameter Λ . The Λ defined by (3.5), denoted $\tilde{\Lambda}$, is related to the more conventional Λ defined by Buras et al [14], by a RS independent factor

$$\tilde{\Lambda} = \Lambda \left(\frac{2c}{b} \right)^{-\frac{5}{6}}. \quad (3.6)$$

For details of the definition of $\tilde{\Lambda}$ see appendix A of [4].

The higher β -function coefficients, c_2, c_3, \dots , are RS dependent. In fact, together with τ (and hence the renormalization point μ), they can be shown to completely specify the RS [15]. Hence, the couplant and the coefficients of the physical quantity are functions of the τ and the c_i . The dependence of the couplant, a , on the c_j is given by the $\beta_j(a)$:

$$\beta_j(a) \equiv \frac{\partial a}{\partial c_j} \quad (3.7a)$$

$$= -\hat{\beta}(a) \int_0^a \frac{x^{j+2} dx}{(\hat{\beta}(x))^2} \quad j \geq 2 \quad (3.7b)$$

$$= \frac{a^{j+1}}{j-1} \sum_{i=0}^{\infty} W_i^j a^i, \quad (3.7c)$$

where the W_i^j depend only on the c_i . They are defined recursively via

$$W_i^j = \frac{-1}{j+i-1} \sum_{n=1}^i (j+i-1-2n) c_n W_{i-n}^j \quad (3.8)$$

$$W_0^j \equiv 1.$$

The power series representation in (3.7c) is found by expanding the denominator of the integrand in (3.7b), using

$$(1+y)^{-2} = \left(\sum_{i=0}^{\infty} (-y)^i \right)^2, \quad (3.9)$$

where $y = (cx + c_2x^2 + \dots)$. Hence this expression is only valid for $|y| < 1$.

At n^{th} order, the couplant is defined by the truncated β -function,

$$\begin{aligned} \frac{\partial a^{(n)}}{\partial \tau} &= \hat{\beta}^{(n)}(a^{(n)}) \\ &= -a^{(n)2} (1 + ca^{(n)} + \dots + c_{n-1} a^{(n)n}). \end{aligned} \quad (3.10)$$

with corresponding integrated equation

$$\tau_n = \frac{1}{a^{(n)}} + c \ln \left(\frac{ca^{(n)}}{1 + ca^{(n)}} \right) + \int_0^{a^{(n)}} dx \frac{(c_2 + c_3x + \dots + c_{n-1}x^{n-3})}{(1+cx)(1+cx+c_2x^2+\dots+c_{n-1}x^{n-1})}. \quad (3.11)$$

The β_j -functions are now

$$\frac{\partial a^{(n)}}{\partial c_j} = \beta_j^{(n)}(a^{(n)}) \quad (3.12a)$$

$$= -\hat{\beta}^{(n)}(a^{(n)}) \int_0^a \frac{x^{j+2} dx}{(\hat{\beta}^{(n)}(x))^2} \quad j = 2, \dots, n-1 \quad (3.12b)$$

$$= \frac{a^{(n)j+1}}{j-1} \sum_{i=0}^{\infty} W_i^j a^{(n)i}. \quad (3.12c)$$

The sum in (3.12c) still goes to infinity, but for $m > n-1$, $c_m = 0$.

Without loss of generality, the perturbation series for some physical quantity, R , can be written in the form

$$R = a^M (1 + r_1 a + r_2 a^2 + r_3 a^3 + \dots), \quad (3.13)$$

where the couplant, a , and the r_i have been calculated in some scheme. For example, the QCD $R_{e^+e^-}$ ratio defined by (1.1) has the expansion

$$R_{e^+e^-}(Q) = \left(3 \sum_i q_i^2 \right) (1 + a + r_1 a^2 + \dots), \quad (3.14)$$

but a related quantity, $\tilde{R}_{e^+e^-}$, can be written in the form of (3.13), with $M = 1$;

$$\begin{aligned} \tilde{R}_{e^+e^-} &= \frac{R_{e^+e^-}(Q) - 3 \sum_i q_i^2}{3 \sum_i q_i^2} \\ &= a (1 + r_1 a + r_2 a^2 + \dots). \end{aligned} \quad (3.15)$$

The series discussed in this thesis will have $M = 1$, but the extension to general M is straightforward, and does not significantly change the discussions.

The n^{th} order approximant to R is then defined to be

$$R^{(n)} = a^{(n)} \left(1 + r_1 a^{(n)} + r_2 a^{(n)2} + \dots + r_{n-1} a^{(n)n-1} \right), \quad (3.16)$$

where $a^{(n)}$ is defined by (3.10).

3.3 The Effective Charge Scheme

In a similar fashion to the QED on-shell scheme where the expansion parameter is defined to be the physically observable fine structure constant, $\alpha = e^2/4\pi$ – the effective charge of the electron at low energies – Grunberg [1] suggests defining the physical quantity, R , to be equal to the “effective charge”, a . This is done by defining all the higher order coefficients in the expansion of R to be zero, ie $r_1 = r_2 = \dots = 0$, leaving only the lowest order term with a coefficient

of 1. So the n^{th} order approximant in this scheme is

$$R^{(n)} = a^{(n)}. \quad (3.17)$$

$a^{(n)}$ now obeys a β -function whose coefficients are scheme invariant quantities, [4]

$$\begin{aligned} \hat{\beta}^{(n)}(a^{(n)}) &= \frac{\partial a^{(n)}}{\partial \tau} \\ &= -a^{(n)2} \left(1 + \rho_1 a^{(n)} + \rho_2 a^{(n)2} + \dots + \rho_{n-1} a^{(n)n-1} \right) \\ &\equiv \hat{\rho}^{(n)}(a^{(n)}), \end{aligned} \quad (3.18)$$

where ρ_1 is defined to be c , the scheme invariant defined in §3.2. These coefficients, together with ρ_0 , the zeroth order invariant, see below, are process dependent. Other sets of scheme invariant quantities can be defined for each process by adding scheme independent pieces to the ρ_i , but throughout this discussion the only scheme invariants referred to will be those that form the β -function coefficients in the effective charge, EC, scheme.

The ρ_i are polynomial functions of the series coefficients in any other scheme and the parameters that define the scheme - ie the β -function coefficients in that scheme. Dhar [16] showed this relationship to be

$$\begin{aligned} \sum_{m=0}^n r_m F_{n-m}^{(m+1)} &= 0 \\ \sum_{m=0}^n (n-m+1) \rho_m v_{n-m} &= \sum_{m=0}^n c_m F_{n-m}^{(m+2)}, \end{aligned} \quad (3.19)$$

where the r_m and c_m are as defined above, and the F obey the recursive relation

$$\begin{aligned} F_p^{(n+1)} &= \sum_{m=0}^p v_m F_{p-m}^{(n)} \quad n \geq 1 \\ F_p^{(1)} &= v_p. \end{aligned} \quad (3.20)$$

By eliminating the v_i from the equations, an explicit form for the relationship

between the ρ_i and the r_i and c_i can be found. The first few are found to be

$$\begin{aligned}\rho_0 &= \tau - r_1 \\ \rho_1 &= c \\ \rho_2 &= c_2 + r_2 - r_1\rho_1 - r_1^2 \\ \rho_3 &= c_3 + 2r_3 - 4r_2r_1 - 2r_1\rho_2 - r_1^2\rho_1 + 2r_1^3.\end{aligned}\tag{3.21}$$

It can be shown that in general

$$\rho_k = c_k + (k-1)r_k + \dots,\tag{3.22}$$

where the dots indicate terms involving ρ_j and c_j , $j < k$.

τ is as defined in §3.2. The equation for ρ_0 comes from renormalization group arguments [17] which give the relationship

$$\tau' - r_1(\tau') = \tau - r_1(\tau),\tag{3.23}$$

since r_1 is a linear function of τ only, as will be shown in §3.4. In EC, $r_1(\tau') = 0$, and τ' is written as ρ_0 , yielding the above equation.

Once the ρ_i are known, if the c_i are known in some new RS, then obviously the r_i may be found, and vice versa, and the approximation to the physical quantity in this RS may be evaluated. The form of the expressions for the ρ_i guarantees that schemes exist in which the r_i can have any chosen values. Thus the perturbation series may be given any desired form by a suitable choice of the RS.

An alternate way of generating the ρ_i was found by Maxwell [55]. To show this, some notation must first be introduced, and for the rest of the chapter both a and R are being considered to all orders. For a power series, $R(a)$, which starts at $O(a)$, its inverse or reversed series, $a(R)$, is defined by

$$a(R) = R + K_2R^2 + K_3R^3 + \dots,\tag{3.24}$$

The K_i , known as the reversion coefficients, are multinomials of the r_i , and their

general form was first obtained by McMahon [19]:

$$K_n = \sum \frac{(n+1)(n+2)\dots(n+s)}{p!q!\dots} (-1)^{s+1} r_i^p r_j^q \dots \quad (3.25)$$

The number of series coefficients in each term of the expansion is determined by the constraints

$$pi + qj + \dots = n - 1 \quad (3.26a)$$

$$n \geq i > j > \dots \geq 0, \quad (3.26b)$$

and s is defined by

$$s + 1 \equiv p + q + \dots \quad (3.27)$$

If the perturbation series begins at order M , the K_i are the reversion coefficients of $R^{\frac{1}{M}}$.

The β -function of a couplant, a , defined in some RS is related to the β -function of a couplant, a' , defined in the scheme RS' by the equation

$$\beta'(a') = \frac{da'}{da} \beta(a(a')), \quad (3.28)$$

which holds at every order in the coupling. The primed scheme can be chosen to be EC where $R'^{(n)} \equiv a'^{(n)}$ and $\hat{\beta}'^{(n)}(a'^{(n)}) = \hat{\rho}^{(n)}(R'^{(n)})$. A physical quantity, R , is independent of any RS used to calculate a perturbative approximant, $R^{(n)}$, to it. Hence, the perturbative approximant, if summed to all orders, would also be independent of the RS used. Formally therefore, two perturbative expansions, calculated in different schemes but summed to all orders, are equivalent, $R = R'$. Hence $\hat{\beta}'(a') = \hat{\rho}(R') = \hat{\rho}(R)$, and the relationship (3.28) becomes

$$\hat{\rho}(R) = \frac{\hat{\beta}(a(R))}{\frac{da(R)}{dR}}. \quad (3.29)$$

This may now be expanded as a power series in R . By equating powers of R an expression for the ρ_i in terms of the reversion coefficients is found:

$$-(n+1)K_{n+1} + \sum_{r=0}^n c_r \sum_{\sigma_i=n+2} K_{i_1} K_{i_2} \dots K_{i_{r+2}} - \sum_{i=1}^n i K_i \rho_{n+1-i} = 0, \quad n \geq 1, \quad (3.30)$$

where $i_k = \{1, 2, \dots, n+1\}$, $K_1 \equiv 1 \equiv c_0$. The notation $\sum_{\sigma_i=m}$ indicates the constrained sum, $i_1 + i_2 + \dots = m$.

It turns out that the v_i introduced in Dhar's method are just the K_i of Maxwell's method, so the two are equivalent. However, in later chapters it will be more convenient to use (3.25) and (3.30).

3.4 The Principle of Minimal Sensitivity

The final scheme to be considered here was suggested by Stevenson [4]. He argued that since the final result, R , is totally RS independent, the renormalization scheme should be chosen at each order so that the approximant, $R^{(n)}$, is minimally sensitive to small changes in the scheme parameters, hence the name – principle of minimal sensitivity (PMS). So the RS to be used at order n is \overline{RS} , defined by,

$$\left. \frac{\partial R^{(n)}}{\partial \tau} \right|_{\tau=\bar{\tau}} = 0 \quad (3.31a)$$

$$\left. \frac{\partial R^{(n)}}{\partial c_j} \right|_{c_j=\bar{c}_j} = 0 \quad (3.31b)$$

where $j = 2, 3, \dots, n-1$. In other words, the PMS condition is the ^{stationary} point on the $n-1$ dimensional surface that is $R^{(n)}(\tau, c_2, \dots, c_{n-1})$.

Explicit equations for the PMS conditions can be found by expanding the equations in (3.31), and using the β - and β_j -functions defined in § 3.2. So (3.31a) becomes

$$\frac{\partial R^{(n)}}{\partial \tau} = \sum_{k=0}^{n-1} \left(a^{k+1} \frac{\partial r_k}{\partial \tau} - r_k (k+1) a^{k+2} \sum_{j=0}^{n-1} c_j a^j \right), \quad (3.32)$$

where $r_0 \equiv 1$. It is implicit from now on that a means $a^{(n)}$, unless otherwise stated. Using the fact that to order n the same quantity in different schemes differs by a term of order $n+1$, the τ dependence of the r_k can be found,

$$\frac{\partial r_k}{\partial \tau} = \sum_{j=0}^{k-1} (j+1) r_j c_{k-j-1}. \quad (3.33)$$

where $c_0 \equiv 1 \equiv r_0$. Repeating the operation for (3.31b), and using (3.12c), yields

$$\frac{\partial r_k}{\partial c_j} = \begin{cases} -\frac{1}{j-1} \sum_{m=0}^{k-j} (m+1) r_m W_{k-j-m}^j & 2 \leq j \leq k \\ 0 & j > k \end{cases} \quad (3.34)$$

Notice that when $k = 1$, $\frac{\partial r_1}{\partial c_j} = 0$, and therefore r_1 depends only on τ . In fact $\frac{\partial r_1}{\partial \tau} = 1$, so r_1 depends linearly on τ with coefficient 1. Hence (3.21) the first equation in is justified. In general, r_k depends only on τ and c_2, \dots, c_k .

Setting the remaining terms of the derivatives of $R^{(n)}$ with respect to τ and the c_j equal to zero, and hence imposing the PMS condition, a set of coupled equations may be found.

$$a^{n+1} \sum_{k=0}^{n-1} a^k \sum_{m=k}^{n-1} (m+1) r_m c_{n+k-m-1} = 0 \quad (3.35a)$$

$$\int_0^a \frac{x^{j+2} dx}{(\hat{\beta}^{(n)}(x))^2} - \frac{a^{j-1}}{j-1} \left(\frac{\sum_{k=0}^{n-j-1} a^k \sum_{m=0}^k (m+1) r_m W_{k-m}^j}{\sum_{k=0}^{n-2} a^k \sum_{m=0}^k (m+1) r_m c_{k-m}} \right) = 0. \quad (3.35b)$$

The solution to these $n - 1$ equations in terms of τ and c_j , $j = 2, \dots, n - 1$, give the PMS β -function coefficients for this process at order n . Once these are known, the r_i and hence $R^{(n)}$ can be calculated.

3.5 The Pennington-Wrigley Approximation

The set of equations given in (3.35) are highly non-linear, and hence extremely difficult to solve. A way of getting approximate answers was suggested independently by Pennington [2] and Wrigley [3]. In the expression for $\partial R^{(n)} / \partial c_j$ the series expansion for $\beta_j(a)$, (3.12c), is used instead of the integral expression (3.12b). The full PMS condition requires that the sum of the remaining terms – an infinite number – be set to zero. The Pennington-Wrigley, PW, approximation requires that only the term $O(\alpha^{n+1})$ be set to zero, and the rest of the terms ignored. This leads to series coefficients which are proportional to the β -function coefficients:

$$r_k^{(n)} = \frac{1}{k+1} \left(\frac{n-1-2k}{n-1} \right) c_k^{(n)}, \quad (3.36)$$

where the superscript (n) denotes the n^{th} order coefficients. They will be different in each order, but as $n \rightarrow \infty$, $r_k^{(n)} \rightarrow \frac{1}{k+1} c_k^{(n)}$. τ_n is given by

$$\tau_n = \rho_0 + \frac{c}{2} \left(\frac{n-3}{n-1} \right). \quad (3.37)$$

Substituting (3.36) into (3.22) yields

$$\begin{aligned} \rho_k &= \left(1 + \frac{k-1}{k+1} \left(1 - \frac{2k}{n-1} \right) \right) c_k^{\text{PW}} + \dots \\ &\xrightarrow{n \rightarrow \infty} 2c_k^{\text{PW}} + \dots \end{aligned} \tag{3.38}$$

for large k , and the dots indicate terms involving ρ_j , $j < k$. This shows that the c_k^{PW} are closely related to the ρ_k , indicating that PW and EC are closely related.

4 The Possible Sums of Perturbation Series

4.1 Introduction

As has been shown in chapter 3, when a perturbative expansion of a physical quantity in a massless, renormalizable field theory is calculated, a fixed renormalization scheme, RS, need not be used. Instead, a different scheme may be chosen at each order. That is, for a physical quantity, R , with perturbation expansion (3.13),

$$R = a(1 + r_1 a + r_2 a^2 + \dots), \quad (4.1)$$

at each order $R^{(n)}(S_n)$ can be computed, where S_n denotes the scheme used at order n . As shown by Stueckelberg and Peterman [15], and mentioned above, S_n may be parameterized by the variables $\{\tau_n, c_2^{(n)}, c_3^{(n)}, \dots, c_{n-1}^{(n)}\}$, that is, by the renormalization point and the β -function coefficients. So for $n \geq 2$, $R^{(n)}$ is a function of these $n-1$ variables. Formally, to $O(a^n)$ $R^{(n)}$ is independent of S_n , but, as will be illustrated below, the numerical variation can be important.

The question “what is the range of limits obtained by choosing all possible sequences of renormalization schemes in successive orders?” is the most fundamental statement of the problem of scheme dependence. That is, for any sequence S_1, S_2, S_3, \dots , of schemes, does the sequence of approximants, $R^{(n)}(S_n)$, converge to a limit,

$$R_{lim} = \lim_{n \rightarrow \infty} R^{(n)}(S_n), \quad \{S_n\}, \quad (4.2)$$

and if so, is the limit unique? As discussed in §2.10, it has long been thought likely that in a fixed scheme, such as minimal subtraction, the sequence of approximants is divergent. At best the sequence is asymptotic, in which case it might be possible to obtain the Borel sum of the divergent series from the first few terms of the series (perhaps the first π/α in QED, but only ~ 3 in QCD [20]).

However, a challenge to this conventional wisdom will be discussed in §4.10. It is hoped that when the whole set of renormalization group equivalent perturbation series is considered, not just a series in a fixed scheme, perturbation

theory can be convergent. This idea was suggested by Stevenson in [21], in which he constructed a toy model which mimicked real field theory. In a fixed scheme the perturbative expansion of the “physical quantity” is asymptotic but Borel summable. However, by using the PMS principle to pick the renormalization point at each order, the sequence of approximants tends to a finite limit which is perturbatively equivalent to the Borel sum of the series in a fixed scheme. The question to be considered here however, is the more general one raised earlier, about all possible limits.

Unfortunately, it will be concluded that any limit is possible, that is, R_{lim} can have any real value. This holds irrespective of the details of the perturbation series in a fixed scheme. So for $n \geq 3$, it will be shown that, given a value for $\Lambda_{\overline{MS}}$, any desired value for the approximant, $R^{(n)}$, can be found by making a suitable choice of scheme.

4.2 Some Necessary Proofs

In order to prove the claim that any value for $R^{(n)}$ may be obtained, the dependence of the series coefficients, r_i , on the renormalization point, τ , and on the highest, and next to highest, β -function coefficients must be known. In this section it will be shown that

$$r_n \sim \tau^n - \frac{c_n}{n-1} - 2\tau \frac{c_{n-1}}{n-2}, \quad (4.3)$$

where \sim indicates that only leading terms in τ are considered.

The necessary ingredients for the discussion are the relationship between the reversion coefficients and the series coefficients, (3.25), and between the reversion coefficients and the scheme invariants, (3.30). The first is given by

$$K_n = \sum \frac{(n+1)(n+2)\dots(n+s)}{p!q!\dots} (-1)^{s+1} r_i^p r_j^q \dots, \quad (4.4)$$

where the number of series coefficients in each term of the expansion is determined by the constraints

$$pi + qj + \dots = n - 1 \quad (4.5a)$$

$$n \geq i > j > \dots \geq 0, \quad (4.5b)$$

and s is defined by

$$s + 1 \equiv p + q + \dots \quad (4.6)$$

The relationship between the reversion coefficients and the scheme invariants is

$$(n + 1)K_{n+1} = \sum_{r=0}^n c_r \sum_{\sigma_i=n+2} K_{i_1} K_{i_2} \dots K_{i_{r+2}} - \sum_{i=1}^n i K_i \rho_{n+1-i}, \quad n \geq 1, \quad (4.7)$$

where $i_k = \{1, 2, \dots, n + 1\}$, $K_1 \equiv 1 \equiv c_0$. The notation $\sum_{\sigma_i=m}$ indicates the constrained sum, $i_1 + i_2 + \dots = m$.

To prove a general result needed in the following proofs, consider the case where each of the coefficients of the original series is equal to one, so

$$R(a) = a(1 + a + a^2 + a^3 + \dots). \quad (4.8)$$

This has sum $R(a) = a/(1 - a)$. Inverting this yields

$$\begin{aligned} a(R) &= \frac{R}{1 + R} \\ &= R - R^2 + R^3 - R^4 + \dots, \end{aligned} \quad (4.9)$$

and so the reversion coefficients are $K_i = (-1)^{i-1}$. From (4.4) it can be seen that

$$\sum \frac{(n + 1)(n + 2) \dots (n + s)}{p!q! \dots} (-1)^{s+1} = (-1)^{n-1}, \quad (4.10)$$

with (4.5) and (4.6) holding.

To show that $r_n \sim \tau^n$, it is first necessary to show that $K_{n+1} \sim (-\tau)^n$ using a proof by induction. By definition $K_1 \equiv 1$, and from (4.4) and (3.21) it can be seen that

$$\begin{aligned} K_2 &= -\tau + \rho_0 \sim -\tau \\ K_3 &= c_2 - \rho_2 + (\rho_0 - \tau)^2 + c(\rho_0 - \tau) \sim \tau^2. \end{aligned} \quad (4.11)$$

Assume that $K_n \sim (-\tau)^{n-1}$, which is true for $n = 1, 2, 3$. In the second term on the right hand side of (4.7) the maximum power of τ is from K_n since the ρ_i ,

being scheme invariants, are independent of τ . In the first term of (4.7) the sum is constrained such that

$$i_1 + i_2 + \dots + i_{r+2} = n + 2. \quad (4.12)$$

This means, by the assumption that $K_n \sim (-\tau)^{n-1}$, that the coefficient of c_r is

$$(-\tau)^{i_1-1} \times (-\tau)^{i_2-1} \times \dots \times (-\tau)^{i_{r+2}-1} = (-\tau)^{n-r}. \quad (4.13)$$

So the term with the maximum power of τ is $r = 0$. As this term has τ to a higher power than that from the second term, the contribution from the second term may be ignored, as only leading terms are considered here. Hence

$$\begin{aligned} (n+1)K_{n+1} &\sim 2K_1K_{n+1} + \sum_{i=2}^n (-\tau)^n \\ (n-1)K_{n+1} &\sim (n-1)(-\tau)^n, \end{aligned} \quad (4.14)$$

so $K_{n+1} \sim (-\tau)^n$ for all n .

Again a proof by induction is used to show that $r_n \sim \tau^n$, using the above result. Assume $r_n \sim \tau^n$, which is true for r_1 , see (3.21) and (3.33) and comments in §3.4. In the expansion of K_{n+1} in terms of the r_i , (4.4), there is only one term which has r_n , and it always occurs with coefficient -1 . So K_{n+1} can be written

$$K_{n+1} = -r_n + \sum \frac{(n+2)\dots(n+1+s)}{p!q!\dots} (-1)^{s+1} r_i^p r_j^q \dots, \quad (4.15)$$

but now condition (4.5b) is $n > i > j \dots \geq 0$. Using the assumption, this becomes

$$\begin{aligned} K_{n+1} &\sim -r_n + \tau^n \sum \frac{(n+1)(n+2)\dots(n+s)}{p!q!\dots} (-1)^{s+1} \\ &\sim -r_n + \tau^n ((-1)^n + 1), \end{aligned} \quad (4.16)$$

where the result (4.10) has been used to evaluate the sum. Using the fact that $K_{n+1} \sim (-\tau)^n$ completes the proof by yielding the desired result, $r_n \sim \tau^n$.

(4.4) and (4.7) are used again to show the dependence of r_n on c_n via the K_{n+1} . r_n doesn't depend on any higher β -function coefficients, c_j , $j > n$, see (3.34). As τ depends on c_n , the leading τ dependence must also be considered. From (4.7) it can be seen that c_n appears explicitly only once with coefficient

$$\sum_{\sigma_i=n+2} K_{i_1} \dots K_{i_{n+2}}. \quad (4.17)$$

There is only one way of choosing $n+2$ objects such that their sum is $n+2$, so the coefficient is $K_1^{n+2} = 1$. Hence

$$\begin{aligned} (n+1)K_{n+1} &\sim 2K_1K_{n+1} + \sum_{i=2}^n K_iK_{n+2-i} + c_n \\ (n-1)K_{n+1} &\sim (n-1)(-\tau)^n + c_n. \end{aligned} \quad (4.18)$$

So

$$K_{n+1} \sim (-\tau)^n + \frac{c_n}{(n-1)}. \quad (4.19)$$

Using (4.16) yields

$$r_n \sim \tau^n - \frac{c_n}{(n-1)}. \quad (4.20)$$

A similar analysis for the dependence of r_n on the next β -function coefficient, c_{n-1} , can be carried out. Again from (4.7) it can be seen that c_{n-1} appears once explicitly with coefficient

$$\sum_{\sigma_i=n+2} K_{i_1} \dots K_{i_{n+1}} = (n+1)K_2K_1^n. \quad (4.21)$$

The term $2K_2K_n$ must also be separated out from the first sum in (4.7), as K_n also depends on c_{n-1} , see (4.19). Hence the important terms in (4.7) are

$$\begin{aligned} (n+1)K_{n+1} &\sim 2K_1K_{n+1} + 2K_2K_n + \sum_{i=3}^{n-1} (n+1)c_{n-1}K_2 \\ (n-1)K_{n+1} &\sim 2(-\tau)^n \left((-\tau)^{n-1} + \frac{c_{n-1}}{n-2} \right) + (n-3)(-\tau)^n - (n+1)c_{n-1}\tau \\ &= (-\tau)^n - \tau c_{n-1} \left(\frac{2 + (n-2)(n+1)}{(n-1)(n-2)} \right). \end{aligned} \quad (4.22)$$

From (4.4) two terms must now be separated from the sum, as both r_n and r_{n-1}

depend on c_{n-1} . The coefficient of r_{n-1} is $(n+2)r_1$. Hence

$$K_{n+1} = -r_n + (n+2)r_1 r_{n-1} + \sum \frac{(n+2)\dots(n+1+s)}{p!q!\dots} (-1)^{s+1} r_i^p r_j^q \dots, \quad (4.23)$$

with (4.5a) and (4.6) unchanged, but (4.5b) becomes $n-1 > i > j \dots \geq 0$.

Using (4.22), (4.20), the result $r_n \sim \tau^n$ and (4.10) yields

$$r_n \sim \tau^n - 2\tau \frac{c_{n-1}}{n-2}, \quad (4.24)$$

and hence the dependence of r_n on the leading powers of τ , c_n and c_{n-1} is

$$r_n \sim \tau^n - \frac{c_n}{(n-1)} - 2\tau \frac{c_{n-1}}{(n-2)}. \quad (4.25)$$

4.3 The Set of Possible Limits

For $n \geq 2$, $R^{(n)}$ is a function of the $n-1$ variables that parametrize the RS, i.e. $R^{(n)} = R^{(n)}(a, c_2, \dots, c_{n-1})$, where either the couplant, a , or the renormalization point, τ , may be considered to be the $(n-1)^{th}$ free parameter. By examining the surface $R^{(n)}$ it is possible to show what limits, R_{lim} , can exist as $n \rightarrow \infty$.

The case for $n = 2$ is special and will be dealt with first. It can easily be shown that $R^{(2)}$ is bounded from above. The β -function at this order is, (3.10),

$$b \frac{\partial a}{\partial \tau} = -ba^2(1+ca), \quad (4.26)$$

with associated integrated β -function,

$$\tau = \frac{1}{a} + c \ln \left(\frac{ca}{1+ca} \right). \quad (4.27)$$

So using $\rho_0 = \tau - r_1$, (3.21), $R^{(2)}$ becomes

$$\begin{aligned} R^{(2)} &= a + r_1 a^2 \\ &= 2a + a^2 \left(c \ln \left(\frac{ca}{1+ca} \right) - \rho_0 \right). \end{aligned} \quad (4.28)$$

So as

$$\begin{aligned} a \rightarrow 0 & & R^{(2)} &\rightarrow 0 \\ a \rightarrow +\infty & & R^{(2)} &\rightarrow -\infty \end{aligned} \quad (4.29)$$

provided $\rho_0 > 0$. The derivative of $R^{(2)}$ with respect to a is positive at $a = 0$, so $R^{(2)}$ will always have the form shown in figure 4.1 when $\rho_0 > 0$.

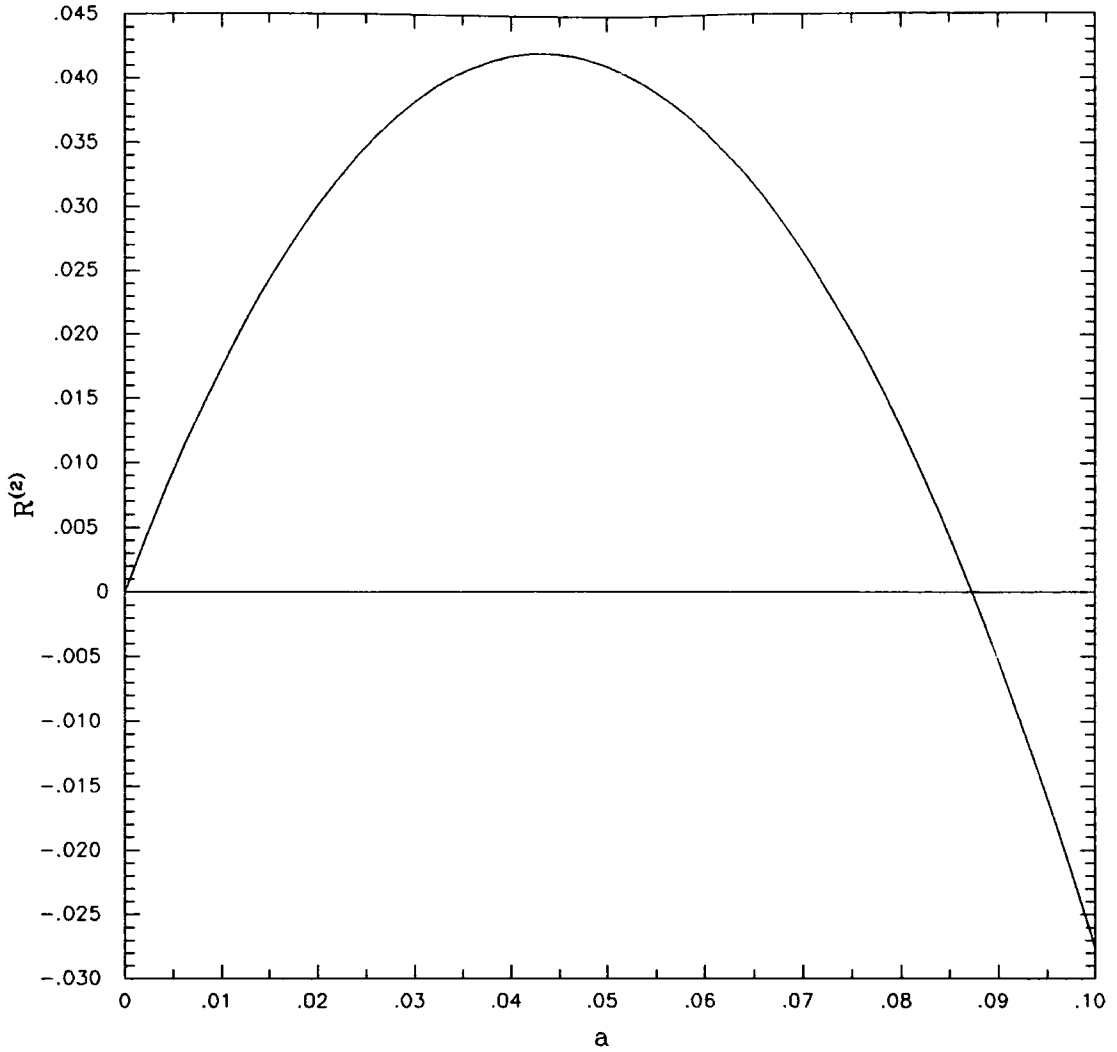

Figure 4.1 $R^{(2)}$ as a function of the couplant, a . This is the general shape that $R^{(2)}$ will have, regardless of the physical process, provided $\rho_0 > 0$.

For $n \geq 3$, if the surface of $R^{(n)}$ was bounded above or below, then obviously the claim that any value for $R^{(n)}$ may be obtained is invalid. To see that this is not the case, consider the following argument.

Consider the truncated perturbation expansion, (3.13),

$$R^{(n)} = a(1 + r_1 a + r_2 a^2 \dots + r_{n-1} a^{n-1}). \quad (4.30)$$

Using the integrated β -function (3.11) and the result obtained in §4.2, i.e. $r_n \sim \tau^n$, it can be seen that

$$\begin{aligned}
r_i a^i &\sim \left(\int_0^{a^{(n)}} dx \frac{(c_2 + c_3 x + \dots + c_{n-1} x^{n-3})}{(1 + cx)(1 + cx + c_2 x^2 + \dots + c_{n-1} x^{n-1})} \right. \\
&\quad \left. + \frac{1}{a} + c \ln \left(\frac{ca}{1 + ca} \right) \right)^i a^i, \quad \forall i < n - 1 \\
&\rightarrow 1 \quad \text{as } a \rightarrow 0.
\end{aligned} \tag{4.31}$$

Hence

$$R^{(n)} \rightarrow 0 \quad \text{as } a \rightarrow 0, \quad \forall n. \tag{4.32}$$

As $a \rightarrow \infty$, the dominant term in (4.30) is

$$\begin{aligned}
r_{n-1} a^n &\sim a^n \left(-\frac{c_{n-1}}{n-2} \right. \\
&\quad \left. + \left(\int_0^{a^{(n)}} dx \frac{(c_2 + c_3 x + \dots + c_{n-1} x^{n-3})}{(1 + cx)(1 + cx + c_2 x^2 + \dots + c_{n-1} x^{n-1})} \right)^{n-1} \right).
\end{aligned} \tag{4.33}$$

If there is no pole in the integrand, the integral is finite. So $R^{(n)} \rightarrow +\infty$ as $a \rightarrow \infty$ if the integral term is larger than $\frac{c_{n-1}}{n-2}$, and $-\infty$ if it is not. If there is a pole in the integrand, then the situation is the same as the next case to be discussed where $c_{n-1} \rightarrow -\infty$ for fixed a . It will be shown that $R^{(n)} \rightarrow +\infty$ for n odd, and $-\infty$ for n even.

For fixed a , the only term which depends on c_{n-1} is r_{n-1} , see (3.34). Using (4.20) and the integrated β -function, it can be seen that

$$\begin{aligned}
r_{n-1} &\sim \left(-\frac{c_{n-1}}{n-2} + \left(\frac{1}{a} + c \ln \left(\frac{ca}{1 + ca} \right) \right. \right. \\
&\quad \left. \left. + \int_0^{a^{(n)}} dx \frac{(c_2 + c_3 x + \dots + c_{n-1} x^{n-3})}{(1 + cx)(1 + cx + c_2 x^2 + \dots + c_{n-1} x^{n-1})} \right)^{n-1} \right).
\end{aligned} \tag{4.34}$$

However, as $c_{n-1} \rightarrow -\infty$ a pole occurs in the integrand, so to discover the behaviour of $R^{(n)}$ it is only necessary to study the integral, as it will be the dominant term.

Consider the denominator, D , of the integrand. As $x \rightarrow 0$ the denominator tends to 1, and its derivative to c , which for all cases under consideration is

positive. Hence the denominator is positive between 0 and the pole, denoted x_0 . Let the numerator be denoted N . Then

$$\frac{D}{(1+cx)} = 1 + cx + Nx^2. \quad (4.35)$$

For $x = x_0 - \epsilon$, where ϵ is a small, positive number, $\frac{D}{(1+cx)} \gtrsim 0$ since $1 + cx$ is also positive. This means that $1 + cx + Nx^2 \gtrsim 0$ as well, hence $0 > N > -(1 + cx)/x^2$. So the numerator is negative in some region just before the pole. Now let c_{n-1} be such that the pole is at $a + \delta$, where δ is a small, positive number, and hence the pole is just outside the region of integration. The bulk of the integral will come from near the pole where the integrand is negative. As $|c_{n-1}|$ increases, i.e. δ tends to zero, the value of the integral tends to negative infinity. Therefore, as $c_{n-1} \rightarrow -\infty$, $r_{n-1} \rightarrow (-\infty)^{n-1}$, so

$$\text{as } c_{n-1} \rightarrow -\infty \quad R^{(n)} \rightarrow \begin{cases} +\infty & \text{if } n \text{ is odd} \\ -\infty & \text{if } n \text{ is even.} \end{cases} \quad (4.36)$$

To discover the behaviour of $R^{(n)}$ as $c_{n-1} \rightarrow +\infty$ with all other parameters fixed, a knowledge of the behaviour of the above integral is again important. If a change of variables from x to $u = c_{n-1}^{\frac{1}{n-1}}x$ is made, the integral becomes

$$I = c_{n-1}^{\frac{1}{n-1}} \int_0^{ac_{n-1}^{\frac{1}{n-1}}} du \frac{c_2 c_{n-1}^{-\frac{2}{n-1}} + c_3 c_{n-1}^{-\frac{3}{n-1}} u + \dots + u^{n-3}}{\left(1 + c c_{n-1}^{-\frac{1}{n-1}} u\right) \left(1 + c c_{n-1}^{-\frac{1}{n-1}} u + \dots + u^{n-1}\right)}. \quad (4.37)$$

If the limit as $c_{n-1} \rightarrow +\infty$ of $I c_{n-1}^{-\frac{1}{n-1}}$ is taken, the result is an integral which can be done analytically,

$$\begin{aligned} \lim_{c_{n-1} \rightarrow +\infty} \left(\frac{I}{c_{n-1}^{\frac{1}{n-1}}} \right) &= \int_0^\infty du \frac{u^{n-3}}{1 + u^{n-1}} \\ &= \frac{\pi}{(n-1) \sin\left(\frac{(n-2)\pi}{n-1}\right)} \\ &\rightarrow 1 \quad \text{as } n \rightarrow \infty. \end{aligned} \quad (4.38)$$

Hence, using (4.25), r_{n-1} goes as

$$r_{n-1} \sim c_{n-1} \left[\left(\frac{\pi}{(n-1) \sin \left(\frac{(n-2)\pi}{n-1} \right)} \right)^{n-1} - \frac{1}{n-2} \right] \quad (4.39)$$

$\rightarrow +\infty$ as $c_{n-1} \rightarrow +\infty$,

since the coefficient of c_{n-1} is always positive. Hence

$$R^{(n)} \rightarrow +\infty \quad \text{as } c_{n-1} \rightarrow +\infty. \quad (4.40)$$

For c_{n-2} , the second highest β -function coefficient at order n , again the dominant contribution is from r_{n-1} . To see this an analysis similar to the above may be carried out to find the dependence of τ_n on c_{n-2} as $c_{n-2} \rightarrow +\infty$. The change of variables is this time $u = c_{n-2}^{\frac{1}{n-2}} x$, but otherwise the procedure is unchanged. The limit as $c_{n-2} \rightarrow +\infty$ of $I c_{n-2}^{-\frac{1}{n-2}}$ is now

$$\begin{aligned} \lim_{c_{n-2} \rightarrow +\infty} \frac{I}{c_{n-2}^{\frac{1}{n-2}}} &= \int_0^\infty du \frac{u^{n-4}}{1+u^{n-2}} \\ &= \frac{\pi}{(n-2) \sin \left(\frac{(n-3)\pi}{n-2} \right)} \\ &\rightarrow 1 \quad \text{as } n \rightarrow \infty, \end{aligned} \quad (4.41)$$

and hence τ depends on c_{n-2} via

$$\tau_n \sim \frac{\pi}{(n-2) \sin \left(\frac{(n-3)\pi}{n-2} \right)} c_{n-2}^{\frac{1}{n-2}}. \quad (4.42)$$

Now consider (4.25),

$$r_{n-1} \sim \tau^{n-1} - 2\tau \frac{c_{n-2}}{n-3} \sim O \left(c_{n-2}^{\frac{n-1}{n-2}} \right), \quad (4.43)$$

whereas

$$r_{n-2} \sim \tau^{n-2} - \frac{c_{n-2}}{n-3} \sim O(c_{n-2}). \quad (4.44)$$

So c_{n-2} occurs with a larger power in r_{n-1} than in r_{n-2} , and hence is the

dominant contribution with coefficient

$$\left(\frac{\pi}{(n-2) \sin\left(\frac{(n-3)\pi}{n-2}\right)} \right)^{n-1} - \frac{2\pi}{(n-3)(n-2) \sin\left(\frac{(n-3)\pi}{n-2}\right)} > 1. \quad (4.45)$$

So again r_{n-1} , and hence $R^{(n)}$, tend to positive infinity as $c_{n-2} \rightarrow +\infty$ for all n . The argument for $c_{n-2} \rightarrow -\infty$ is identical to that for $c_{n-1} \rightarrow -\infty$.

$$R^{(n)} \rightarrow 0 \quad \text{as } a \rightarrow 0$$

$$R^{(n)} \rightarrow +\infty \quad \text{as } a \rightarrow \infty \quad \begin{array}{l} \text{if the integral in the integrated } \beta\text{-function} \\ \text{is finite, and greater than } c_{n-1}/n - 2 \\ \text{or if } n \text{ is odd with a pole in the integrand.} \end{array}$$

$$\text{as } c_{n-1} \rightarrow +\infty \quad \text{for fixed } a, c_2, \dots, c_{n-2}.$$

$$\text{as } c_{n-1} \rightarrow -\infty \quad \text{for fixed } a, c_2, \dots, c_{n-2} \text{ and } n \text{ odd.}$$

$$\text{as } c_{n-2} \rightarrow +\infty \quad \text{for fixed } a, c_2, \dots, c_{n-3}, c_{n-1}.$$

$$\text{as } c_{n-2} \rightarrow -\infty \quad \text{for fixed } a, c_2, \dots, c_{n-3}, c_{n-1} \text{ and } n \text{ odd.}$$

$$R^{(n)} \rightarrow -\infty \quad \text{as } a \rightarrow \infty \quad \begin{array}{l} \text{if the integral in the integrated } \beta\text{-function} \\ \text{is finite, and less than } c_{n-1}/n - 2 \\ \text{or if } n \text{ is even with a pole in the integrand.} \end{array}$$

$$\text{as } c_{n-1} \rightarrow -\infty \quad \text{for fixed } a, c_2, \dots, c_{n-2} \text{ and } n \text{ even.}$$

$$\text{as } c_{n-2} \rightarrow -\infty \quad \text{for fixed } a, c_2, \dots, c_{n-3}, c_{n-1} \text{ and } n \text{ even.}$$

Table 4.1 The set of limits of $R^{(n)}$ and the conditions under which it has each limit.

In even orders for fixed a , $R^{(n)} \propto c_{n-1}(c_{n-2})$, hence by continuity $R^{(n)}$ can take any value between $-\infty$ and ∞ . In odd orders for fixed a , $R^{(n)} \rightarrow +\infty$ as $c_{n-1}(c_{n-2}) \rightarrow \pm\infty$. Hence it is bounded below. However, by allowing a to vary as well, it can be seen that $0 \leq R^{(n)} \leq +\infty$. Therefore, given a free choice of scheme for $n \geq 3$, a scheme can be found such that $R^{(n)}$ has any desired value between zero and infinity. So any positive limit to $R^{(n)}$ as $n \rightarrow \infty$ is possible. Note that the case for $n = 2$ is special because $R^{(2)}$ depends only on a , so, as

shown above, $R^{(2)}$ will have a maximum value, unlike any other approximant. The asymptotic behaviour of $R^{(n)}$ is summarized in table 4.1.

4.4 Possible Limits of the EC and PW Schemes

In his paper [18], Maxwell argues that, if it exists, the limit of the perturbative approximants for both the EC scheme, and the PW approximation to PMS, is most likely to be zero. Due to the complexity of PMS its behaviour can not be studied in higher orders, see chapter 5, and therefore no definite statement about the PMS limit is possible at present. Therefore the PW approximation must be used. Whether this is a good approximation in higher orders will be discussed at the end.

As so often in the previous section, the integrated truncated β -function, (3.11),

$$\begin{aligned} \tau_n = & \frac{1}{a^{(n)}} + c \ln \left(\frac{ca^{(n)}}{1 + ca^{(n)}} \right) \\ & + \int_0^{a^{(n)}} dx \frac{(c_2 + c_3x + \dots + c_{n-1}x^{n-3})}{(1 + cx)(1 + cx + c_2x^2 + \dots + c_{n-1}x^{n-1})}, \end{aligned} \quad (4.46)$$

is the key to the discussion. Although the degree of divergence of the perturbation series may be process dependent, the only assumption made in this discussion is that the β -function, in both EC and PW schemes, has zero radius of convergence. That is, for EC $\hat{\rho}(a)$ as defined by (3.18), has zero radius of convergence. In the PW approximation, while the β -function coefficients have some n dependence, as can be seen from (3.38), in the limit as $n \rightarrow \infty$ they yield simple, finite expressions involving the scheme invariants. Hence the PW β -function is closely related to $\hat{\rho}(a)$, and if $\hat{\rho}(a)$ is a divergent series, the PW β -function will also be divergent.

For the first case, let there be no positive zeros of $\hat{\beta}^{(n)}(x) = x^2(1 + cx + c_2x^2 + \dots + c_{n-1}x^{n-1})$ for any n , apart from the double one at $x = 0$. The integrated β -function can then be written in the form

$$\tau_n = c + \int_0^{\frac{1}{c}} dx \left(\frac{1}{x^2} - \frac{c}{x} - \frac{1}{\hat{\beta}^{(n)}(x)} \right) - \int_{\frac{1}{c}}^{a^{(n)}} \frac{dx}{\hat{\beta}^{(n)}(x)}. \quad (4.47)$$

Although it appears that there is a pole at $x = 0$ in each of the terms in the first

integral, the terms conspire to cancel it, leaving a residue of $c_2 - c^2$ at the origin. Due to the assumption of zero radius of convergence, as $n \rightarrow \infty$ $-1/\hat{\beta}^{(n)}(x)$ becomes vanishingly small outside a shrinking interval $[0, \epsilon]$. So the pole at $x = 0$ is cancelled ever closer to the origin as $n \rightarrow \infty$. This means that there will be a positive peak at $x \sim \epsilon$ which grows indefinitely as $n \rightarrow \infty$. For larger x the integrand behaves as $1/x^2 - c/x$. Thus the integral will diverge to positive infinity at least as fast as

$$\int_{\epsilon}^{\frac{1}{c}} dx \left(\frac{1}{x^2} - \frac{c}{x} \right) \quad \epsilon \rightarrow 0. \quad (4.48)$$

The remaining integral in (4.47) vanishes as $n \rightarrow \infty$ if $a^{(n)} > 1/c$, and is positive if $0 < a^{(n)} < 1/c$. So unless $\tau_n \rightarrow \infty$ as $n \rightarrow \infty$, (4.47) will cease to have a solution for a positive couplant. However, both EC and PW have finite τ_n , with the EC τ_n fixed at ρ_0 . For PW, see (3.37),

$$\begin{aligned} \tau_n &= \rho_0 + \frac{c}{2} \left(\frac{n-3}{n-1} \right) \\ &\xrightarrow{n \rightarrow \infty} \rho_0 + \frac{c}{2}. \end{aligned} \quad (4.49)$$

So if there are no positive zeros in $\hat{\beta}^{(n)}(x)$, the couplant and hence any perturbation series in the PW and EC schemes will eventually become undefined.

Now let $\hat{\beta}^{(n)}(x)$ have positive, real zeros, and let the zero nearest the origin be at $x = x_n$. As $a^{(n)} \rightarrow 0^+$ the right hand side of (4.46) diverges to $+\infty$. As has been shown in the previous section, as $a^{(n)} \rightarrow x_n^-$, the integral diverges to $-\infty$. Hence for any real τ_n there is a solution $a^{(n)}(\tau_n)$ such that $0 < a^{(n)}(\tau_n) < x_n$. So $a^{(n)}(\tau_n)$ is bounded by the zero nearest the origin.

The behaviour as $n \rightarrow \infty$ of the zero nearest the origin now becomes important. If zeros occur only in alternate orders then eventually in the order in which zeros do not occur (4.46) will cease to have a solution for the reasons given in the previous discussion. Series calculated in the EC and PW schemes again become undefined. So for a finite limit to occur, zeros must occur in every order.

While it is possible to construct examples where the zeros have no limit, or are fixed at a given value, this behaviour is rather contrived. It seems more likely that the β -function coefficients have some given n behaviour, as has been

shown for ϕ^4 theory, see §2.10. In this case, let the sequence of zeros, x_n , tend to a fixed limit \bar{x} . So $\hat{\beta}^{(n)}(x_n) = 0$, and $\lim_{n \rightarrow \infty} \hat{\beta}^{(n)}(x_n) = \hat{\beta}(\bar{x}) = 0$. Then

$$\begin{aligned}\hat{\beta}^{(n+2)}(x_n) &= x_n^2(c_n x^n + c_{n+1} x^{n+1}) \\ &= x_n^{n+2} c_{n+1} \left(\frac{c_n}{c_{n+1}} + x_n \right) \\ &\rightarrow 0 \quad \text{as } x_n \rightarrow \bar{x}.\end{aligned}\tag{4.50}$$

So either $\bar{x} = 0$ or $\lim_{n \rightarrow \infty} c_n/c_{n+1}$. However, as it has been assumed that the β -function coefficients show some n dependence, and moreover that they grow rapidly with n , like $n!$ for example, as $\hat{\beta}(x)$ has zero radius of convergence, it is most likely that

$$\lim_{n \rightarrow \infty} \frac{c_n}{c_{n+1}} = 0.\tag{4.51}$$

Therefore the most probable limit of the zeros is $\bar{x} = 0$. It is immediately apparent that, under these circumstances, the limit for the EC scheme is zero, since $0 < a^{(n)} < x_n$ and $x_n \rightarrow 0$ as $n \rightarrow \infty$. Since $R^{(n)} = a^{(n)}$ in EC, $R^{(n)} \rightarrow 0$.

For the PW scheme the approximant can be written

$$\begin{aligned}R^{(n)}(\text{PW}) &= \left(1 + \frac{2}{n-1}\right) \int_0^a dx \left(1 + cx + c_2^{\text{PW}} x^2 + \dots + c_{n-1}^{\text{PW}} x^{n-1}\right) \\ &\quad - \frac{2}{n-1} a \left(1 + ca + c_2^{\text{PW}} a^2 + \dots + c_{n-1}^{\text{PW}} a^{n-1}\right).\end{aligned}\tag{4.52}$$

For large n , using the fact that $0 < a < x_n$, $R^{(n)}$ is bounded above and below:

$$0 < R^{(n)}(\text{PW}) < \int_0^{x_n} dx \left(1 + cx + c_2^{\text{PW}} x^2 + \dots + c_{n-1}^{\text{PW}} x^{n-1}\right).\tag{4.53}$$

This integral is well defined, as x_n is the first zero of the integrand, so the range of integration lies inside the region of apparent convergence. Thus, as $n \rightarrow \infty$ and $x_n \rightarrow 0$, $R^{(n)}(\text{PW}) \rightarrow 0$.

So, if a limit exists for a series calculated in the EC or PW schemes, assuming, as is likely, a divergent n dependence of the EC and PW β -function coefficients, the limit will be 0. For this to occur zeros of the β -function must occur in both odd and even orders. If there are no zeros at all, or zeros only in alternate orders, then eventually the couplant becomes undefined, and $R^{(n)}(\text{EC})$ and $R^{(n)}(\text{PW})$ have no limit.

As explained in chapter 3, deriving the PW scheme involves expanding $1/\hat{\beta}^{(n)}(x)$ as a power series in x , which is valid only for $(cx + c_2x^2 + \dots + c_{n-1}x^{n-1}) < 1$, see (3.9). For the case where $x_n \rightarrow 0$ as $n \rightarrow \infty$, the range of integration is in the region of validity of this expansion, and so it might be expected that PW should be a good approximation to PMS. However, the complexity of full PMS prevents a proper proof of this.

In the above, zero radius of convergence of $\hat{\rho}$ was assumed. If this is not so, the scheme dependence problem is much less severe, and the EC and PW approximants will converge.

By using (3.29), all possible combinations of convergent and divergent scheme invariants, β -functions and perturbation series may be found. Table 4.2 shows that the EC β -function, whose coefficients are the invariants, ρ_i , may be convergent although both the β -function and the perturbation series in the scheme specified by the β -function, are divergent. This would imply that the divergent behaviour of the perturbation series coefficients in some RS, is directly related to that of the β -function coefficients in that scheme.

$\rho(a)$	$R(a)$	$\beta(a)$
C	C	C
C	D	D
D	D	D
D	D	C
D	C	D

Table 4.2 The combinations of convergent, C, and divergent, D, scheme invariant series, β -function and perturbation series allowed by (3.29).

Kataev and Vardiashvili [22], working in ϕ^4 theory and using the MS scheme, have calculated to five loops the perturbative expansion of a “physical” quantity which was constructed to resemble $R_{e^+e^-}$ – the R ratio in e^+e^- annihilation. The MS β -function in ϕ^4 theory is known to exhibit alternating factorial behaviour, see §2.10. The series coefficients calculated by Kataev and Vardiashvili also show signs of divergent behaviour, and the scheme invariants for this process show

signs of growing as fast as the other coefficients, implying that in ϕ^4 theory and the MS scheme, the DDD line of the above table is favoured.

4.5 Restriction to “Finite” Schemes

In §4.3 it was shown that a sequence of renormalization schemes can be chosen such that the limit of the perturbative approximants has any desired value. It could be that this rather undesirable state of affairs may arise from the way n^{th} order perturbation theory is defined. The definition, given in §3.2, which is the conventional definition [4], truncates the β -function at the same order as the perturbation series. Hence at each order the equation defining the couplant, a , gains another term, in some sense changing the definition of the couplant order by order. It would seem more satisfactory if the couplant had the same definition in all orders. This can be achieved by choosing the β -function to be a convergent series. A scheme such as this will be referred to as a “finite” scheme because the series may be truncated at a suitable finite order with a known, minimal error, instead of an unknown, and potentially infinite, error. In these finite schemes, the complete, integrated β -function is used to define the couplant in each order. Note that this is not the same as a fixed scheme since τ_n is allowed to change. In a fixed scheme τ is the same for all orders, but at each order a new β -function coefficient is introduced. Really a class of finite schemes can be used – related by the same β -function coefficients but differing in their renormalization points, τ_n . Hence there is only one potentially divergent series, the perturbation series, to be considered, not two.

For the sake of simplicity, the first case to be studied is the extreme example where all the β -function coefficients from $n = 2$ upwards are set to zero, i.e. $c_2 = c_3 = \dots = 0$. Such “zero schemes”, ZS, were first introduced by 't Hooft in a discussion on the Borel summation properties of QCD Green's functions [23]. The integrated β -function equation becomes in all orders

$$\tau = \frac{1}{a} + c \ln \left(\frac{ca}{1 + ca} \right), \quad (4.54)$$

a definition which normally only applies for $n = 2$. Since it is not known how to calculate in this scheme from first principles, the scheme invariants must be found from the β -function and series coefficients of some calculationally convenient

scheme such as $\overline{\text{MS}}$. From the scheme invariants the series coefficients in the ZS can then be found, see §3.3.

Using the set of ZS means that the perturbative approximants depend on τ_n only. So for all possible sequences τ_1, τ_2, \dots , the set of possible limits

$$R_{lim} = \lim_{n \rightarrow \infty} R^{(n)}(\tau_n) \quad \{\tau_n\}, \quad (4.55)$$

can be discussed. For simplicity the first β -function coefficient, c , will be set to zero. In QCD this corresponds to eight-and-a-bit flavours – an unreasonable number from a physical point of view. However, the conclusions for the case with c set to zero are qualitatively equivalent to the case where c is non-zero although the details differ slightly.

This problem was first discussed by Maxwell [18] for a restricted class of alternating factorial series based on the aforementioned toy model discussed by Stevenson [21]. A more general discussion has recently been given by Burdick and Chyla [24], and their discussion will here be extended and clarified.

From (3.33) the dependence of the r_k on τ in the ZS can be found by setting all the higher β -function coefficients to zero, i.e. $c_k = 0$, $k \geq 2$;

$$\frac{\partial r_k}{\partial \tau} = k r_{k-1} + c(k-1) r_{k-2}. \quad (4.56)$$

Setting c equal to zero as well yields a recurrence relation which is easily solved to give r_k as a power series in τ ,

$$r_k(\tau) = \sum_{l=0}^k (\tau - \tau_0)^l r_{k-l}(\tau_0) \binom{k}{l}, \quad (4.57)$$

where the binomial coefficient $\binom{k}{l}$ has the usual definition $k!/l!(k-l)!$. Here τ_0 is some completely arbitrary reference scheme, but for calculational convenience it is chosen to be zero. So (4.57) can be written

$$r_k(\tau_n) = \tau_n^k \sum_{l=0}^k \binom{k}{l} \frac{r_l(0)}{\tau_n^l}. \quad (4.58)$$

Substituting this into the expression for the perturbative approximant, $R^{(n)}$,

yields

$$\begin{aligned}
 R^{(n)}(\tau_n) &= \sum_{k=0}^{n-1} r_k(\tau_n) a^{k+1}(\tau_n) \\
 &= \sum_{l=0}^{n-1} \frac{r_l(0)}{\tau_n^{l+1}} \sum_{k=l}^{n-1} \binom{k}{l},
 \end{aligned} \tag{4.59}$$

since $\tau_n = 1/a$ by (4.54). Using the relation between binomial coefficients

$$\sum_{k=l}^{n-1} \binom{k}{l} = \binom{n}{l+1}, \tag{4.60}$$

the expression for $R^{(n)}(\tau_n)$ becomes

$$\begin{aligned}
 R^{(n)}(\tau_n) &= \sum_{l=0}^{n-1} \frac{r_l(0)}{\tau_n^{l+1}} \binom{n}{l+1} \\
 &= \sum_{l=0}^{n-1} \frac{r_l(0)}{(l+1)!} \left(\frac{n}{\tau_n}\right)^{l+1} \left(\frac{n!}{(n-l-1)!n^{l+1}}\right).
 \end{aligned} \tag{4.61}$$

As $n \rightarrow \infty$ for fixed l , the final factor tends to one. By setting it to one, the limit as n tends to infinity of the series of approximants can be expressed as

$$\begin{aligned}
 R_{lim} &= \lim_{n \rightarrow \infty} R^{(n)}(\tau_n) \\
 &= \lim_{n \rightarrow \infty} \int_0^{\frac{n}{\tau_n}} du \sum_{l=0}^{n-1} \frac{r_l(0)}{l!} u^l.
 \end{aligned} \tag{4.62}$$

Clearly R_{lim} depends on two things: a) the radius of convergence of the series in the integrand which tends to the Borel transform evaluated at $\tau = 0$, as $n \rightarrow \infty$, and b) the sequence $\{\tau_n\}$, as this determines the upper limit of integration. Note that the Borel transform, see §2.10, of any perturbation series is defined to be

$$F_B(u, \tau) \equiv \sum_{l=0}^{\infty} \frac{r_l(\tau)}{l!} u^l. \tag{4.63}$$

Let $\tau_n \sim n^\alpha$. If $\alpha > 1$ then the upper limit of the integral in (4.62) tends to zero as $n \rightarrow \infty$ and so must R_{lim} provided that the series in the integrand has non-zero radius of convergence.

Now let the series in the integrand, and hence the Borel transform, have infinite radius of convergence. If $\alpha = 1$ the upper limit is constant and a finite limit differing from the Borel sum only in the upper limit of integration is the result. For $\alpha < 1$, the Borel sum itself may result, depending on the original perturbation series, R . If R has finite radius of convergence then its Borel transform automatically has infinite radius of convergence, and any α such that $0 \leq \alpha < 1$ will yield the Borel sum. That is, a fixed τ (and hence a fixed scheme) can produce a finite limit provided $a(\tau)$ lies inside the radius of convergence of the original perturbation series. However, the Borel summation was unnecessary as conventional methods would have produced the same result.

On the other hand the original series may have zero radius of convergence and still yield a Borel transform with infinite radius of convergence, such as the series with coefficients $r_k(0) = (-1)^k (qk)!$, with $q < 1$. In this case the choice of α is more restricted; $q \leq \alpha < 1$ will yield the full Borel sum. Again $\alpha = 1$ yields a truncated Borel sum. For $\alpha < q$ the sequence of approximants, $R^{(n)}(\tau_n)$, diverges, and R_{lim} does not exist.

The other interesting case is where R has zero radius of convergence and the associated Borel transform has only finite radius of convergence. In this case for $\alpha < 1$ as the upper limit tends to infinity, the integral diverges since it passes beyond the radius of convergence of the integrand. Hence R_{lim} does not exist for $\alpha < 1$. Therefore for a non-trivial limit to exist, α must be 1, and τ_n grow as χn , where χ is some positive number, and from (4.62) and (4.63) it can be seen that

$$R_{lim} = \int_0^{\frac{1}{\chi}} du F_B(u, 0). \quad (4.64)$$

The differential recurrence relation for the $r_k(\tau)$ with $c = 0$, see (4.56), can be used to show that for two general reference schemes, parameterized by τ_1 and τ_2 , the Borel transforms of the series in these schemes are related by

$$F_B(u, \tau_1) = e^{u(\tau_1 - \tau_2)} F_B(u, \tau_2). \quad (4.65)$$

Choosing $\tau_1 = 0$ yields

$$F_B(u, 0) = e^{-u\tau} F_B(u, \tau). \quad (4.66)$$

Hence, using the fact that $\tau = 1/a$, the more immediately recognizable, albeit

truncated, form of the Borel sum is arrived at:

$$R_{lim} = \int_0^{\frac{1}{\chi}} du e^{-u/a(\tau)} F_B(u, \tau). \quad (4.67)$$

Note that τ is completely arbitrary. $\tau = 0$ was used for convenience in the initial section of the derivation, but it is not special in any other way. Any τ could have been chosen for the reference scheme.

R_{lim} differs from the full Borel sum, R_B , only in the upper limit of integration, which yields a term invisible in perturbation theory, hence R_{lim} and R_B are perturbatively equivalent. Writing $1/a = \tau \sim \ln(Q/\Lambda)$, see (3.4), it can be shown that

$$\begin{aligned} R_{lim} - R_B &= O\left(e^{\frac{-1}{\chi a}}\right) \\ &\sim Q^{-\gamma}. \end{aligned} \quad (4.68)$$

So in QCD the difference will vanish asymptotically in Q as $Q \rightarrow \infty$ – that is, it is a non-perturbative effect. For QED, the difference is Q^γ , which vanishes as $Q \rightarrow 0$.

The remaining case is if the original perturbation series is so divergent that even its Borel transform has zero radius of convergence. The only way a finite limit may be achieved is if the upper limit of integration, n/τ_n , tends to zero as n tends to infinity. That is, $\tau_n \sim \chi n^\alpha$ with $\alpha > 1$. For fixed n , as χ tends to infinity, $R^{(n)}(\tau_n)$ tends to zero, hence, if it exists, the finite limit must be zero.

So in the class of zero schemes, a perturbatively unique limit may exist. It is equal, up to non-perturbative terms invisible in perturbation theory, to the Borel sum of the series. If the ZS series is not Borel summable then if R_{lim} exists it will be zero. By using only those schemes in which the couplant is well defined, perturbation series may yield a unique result when the renormalization group is used to sum them. It is the renormalization group which imposes the condition of Borel summability – it is not a mathematical device imposed externally.

4.6 $\widetilde{\text{PMS}}$

The above section argued that for a finite, non-zero R_{lim} to exist, the renormalization point, τ_n , must grow as χn if the perturbation series is divergent

and its Borel transform has finite radius of convergence. The question arises of how, when calculating a specific example, the renormalization point should be chosen at each order to achieve a convergent sequence of approximants. The choice $\tau_n = \chi n$ could be made for some χ , but the limit only exists if $1/\chi$ is sufficiently small, the allowed values of χ depending on the radius of convergence of the Borel transform, which presumably is not known *a priori*. If the PMS philosophy is to be believed, then τ_n should be chosen so as to make $R^{(n)}$ as insensitive to τ_n as possible. The effect of this scheme choice was first discussed by Stevenson [21] for an alternating factorial example, $r_n(\tau_0) = (-1)^n n!$, with τ_0 chosen to be 4.

Taking $c = 0$, so the series coefficients are

$$r_{n-1}(\tau) = \sum_{k=0}^{n-1} (\tau - \tau_0)^k \binom{n-1}{k} r_{n-1-k}(\tau_0). \quad (4.69)$$

The renormalization point at each order is found by solving the ‘‘PMS’’ condition

$$\left. \frac{dR^{(n)}}{d\tau} \right|_{\tau=\bar{\tau}_n} = 0. \quad (4.70)$$

From (3.35a), setting all the β -function coefficients to zero, $c_i = 0, i \geq 1$, this reduces to

$$r_{n-1}(\bar{\tau}_n) = 0. \quad (4.71)$$

For the more realistic case where c is non-zero, (3.35a) becomes

$$(1 + c\bar{a}) r_{n-1}(\bar{\tau}_n) + c \frac{n-1}{n} r_{n-2}(\bar{\tau}_n) = 0. \quad (4.72)$$

where \bar{a} is the couplant found from $\bar{\tau}_n$ via (4.54). Since it is based on PMS, this way of choosing the renormalization point in the class of ZS will be referred to as $\widetilde{\text{PMS}}$. It is not full PMS, as only the renormalization point is allowed to vary from order to order while the β -function coefficients remain fixed.

Substituting for the $r_{n-1-k}(\tau_0)$ in (4.69) yields

$$r_{n-1}(\tau) = (-1)^n (n-1)! \sum_{k=0}^{n-1} (-1)^k \frac{(\tau - \tau_0)^k}{k!}. \quad (4.73)$$

Stevenson showed that for this example

$$\bar{\tau}_n \sim \chi_0 n + \frac{1}{2} \frac{\chi_0}{1 + \chi_0} \ln(n) + O(1), \quad (4.74)$$

where $\chi_0 = 0.278$ is the solution of $\chi_0 = \exp(-(1 + \chi_0))$. This proof will not be presented here. Instead, a more general proof will be given. For convenience a shifted τ , $\tau_s = \tau - \tau_0$, will be used, but this does not affect the result.

For a more general form of $r_n(\tau_0)$, such as $r_n(\tau_0) = (-1)^n f(n)n!$, (4.73) becomes

$$r_{n-1}(\tau) = (-1)^{n-1} (n-1)! \sum_{k=0}^{n-1} \frac{(-\tau_s)^k}{k!} f(n-1-k). \quad (4.75)$$

The sum can be considered to be the first n terms of a Taylor series expansion of some function, $g_n(\tau_s)$, about zero, in which case $(-1)^k f(n-1-k)$ is the k^{th} derivative of g_n evaluated at zero, i.e.

$$g_n^{(k)}(0) = (-1)^k f(n-1-k). \quad (4.76)$$

Now consider the Lagrange form of the remainder of the truncated Taylor series expansion of $g_n(\tau_s)$:

$$g_n(\tau_s) = \sum_{k=0}^{n-1} \frac{(-\tau_s)^k}{k!} f(n-1-k) + \frac{\tau_s^n}{n!} g_n^{(n)}(\theta_n \tau_s), \quad (4.77)$$

where $0 \leq \theta_n \leq 1$, and (4.76) has been used. The PMS condition, $r_{n-1}(\bar{\tau}_s) = 0$, requires that the sum in (4.77) be zero. Whether this occurs for all n , or for

even or odd n only, depends on the choice of f . The $\widetilde{\text{PMS}}$ condition means that

$$g_n(\bar{\tau}_s) = \frac{\bar{\tau}_s^n}{n!} g_n^{(n)}(\theta_n \bar{\tau}_s), \quad (4.78)$$

or, on rearranging,

$$\frac{g_n(\bar{\tau}_s)}{g_n^{(n)}(\theta_n \bar{\tau}_s)} = \frac{\bar{\tau}_s^n}{n!}. \quad (4.79)$$

Multiplying both sides by $g_n^{(n)}(0) = (-1)^n f(-1)$ gives

$$g_n(\bar{\tau}_s) \frac{(-1)^n f(-1)}{g_n^{(n)}(\theta_n \bar{\tau}_s)} = \frac{(-\bar{\tau}_s)^n}{n!} f(-1). \quad (4.80)$$

Now the sum in (4.77), which is zero, can be added to the right hand side, yielding

$$g_n(\bar{\tau}_s) \frac{(-1)^n f(-1)}{g_n^{(n)}(\theta_n \bar{\tau}_s)} = \sum_{k=0}^n \frac{(-\bar{\tau}_s)^k}{k!} f(n-1-k). \quad (4.81)$$

As $n \rightarrow \infty$ the right hand side tends to $g_\infty(\bar{\tau}_s)$, and hence

$$g_n^{(n)}(\theta_n \bar{\tau}_s) \rightarrow (-1)^n f(-1). \quad (4.82)$$

However, $g_n^{(n)}(0) = (-1)^n f(-1)$ for all n , even and odd, so, since $\bar{\tau}_s \rightarrow \infty$, either $\theta_n \rightarrow 0$ or $g_n^{(n)}(\infty) = (-1)^n f(-1)$. This latter solution is somewhat unlikely, and it is the $\theta_n \rightarrow 0$ solution that is of interest here.

For functions of the form $g_n(x) = h_n(x) e^{-x}$, (4.79) becomes, as $n \rightarrow \infty$,

$$\frac{h_n(\bar{\tau}_s) e^{-\bar{\tau}_s}}{(-1)^n f(-1)} \sim \frac{\bar{\tau}_s^n}{n!} \quad (4.83a)$$

$$\sim \frac{\bar{\tau}_s^n}{n^{n+\frac{1}{2}} e^{-n} \sqrt{2\pi}}, \quad (4.83b)$$

where Stirling's approximation to $n!$ has been used. Rearranging, using $\bar{\tau}_s \sim \chi n$, and taking n^{th} roots yields

$$\exp(-(\chi+1)) \sim \chi \left(\frac{(-1)^n f(-1)}{h_n(\chi n) \sqrt{2\pi n}} \right)^{\frac{1}{n}}. \quad (4.84)$$

For this to yield $e^{-(\chi+1)} = \chi$ as required, the factor multiplying χ on the right hand side must tend to 1 as $n \rightarrow \infty$.

For clarity, consider a few examples which have been studied numerically, see later. The first is the Stevenson example where $f(n) = 1$ for all n . So $f(-1) = 1$ and $h_n(\tau_s) = 1$ for all n and τ_s . The first requirement is that $r_{n-1}(\tau_s) = 0$ has a solution. This is true for even n as can be seen from the fact that

$$\sum_{k=0}^{n-1} \frac{(-\tau_s)^k}{k!} \rightarrow \begin{cases} 1 & \text{as } \tau_s \rightarrow 0 \\ -\infty & \text{as } \tau_s \rightarrow \infty. \end{cases} \quad (4.85)$$

so by the Intermediate Value Theorem there must exist a $\bar{\tau}_s$ such that $r_{n-1}(\bar{\tau}_s) = 0$. The situation for odd n must be considered separately, see later. The other condition is satisfied since

$$\left(\frac{(-1)^n f(-1)}{h_n(\chi n) \sqrt{2\pi n}} \right)^{\frac{1}{n}} = \left(\frac{1}{\sqrt{2\pi n}} \right)^{\frac{1}{n}} \quad (4.86)$$

tends to 1 as $n \rightarrow \infty$. Hence $\chi \rightarrow \chi_0$.

If $f(n) = \psi^n$, then by scaling τ_s by $1/\psi$ this reduces to the Stevenson case, and so $\bar{\tau}_s \sim \psi \chi_0 n$.

For $f(n) = n^2$, $f(-1) = 1$, $h_n(\tau_s) = (n-1-\tau_s)^2 - \tau_s$, which yields

$$\sum_{k=0}^{n-1} \frac{(-\tau_s)^k}{k!} (n-1-k)^2 \rightarrow \begin{cases} (n-1)^2 > 0 & \text{as } \tau_s \rightarrow 0 \\ -\infty & \text{as } \tau_s \rightarrow \infty. \end{cases} \quad (4.87)$$

So again the Intermediate Value Theorem can be used to show that the $\widetilde{\text{PMS}}$ condition has a solution for even n . Also

$$\left(\frac{(-1)^n f(-1)}{h_n(\chi n) \sqrt{2\pi n}} \right)^{\frac{1}{n}} = \left(\frac{1}{\sqrt{2\pi n} \left((n-1-\chi n)^2 - \chi n \right)} \right)^{\frac{1}{n}}, \quad (4.88)$$

which again has limit 1 as $n \rightarrow \infty$.

It is also possible to find the coefficient of the $\ln(n)$ term as well by substituting $\bar{\tau}_s \sim \chi_0 n + \kappa \ln(n)$ into (4.83b):

$$\begin{aligned} \exp(-(\chi_0 + 1)) \exp\left(\frac{\kappa \ln(n)}{n}\right) &= \left(\chi_0 + \frac{\kappa \ln(n)}{n}\right) \left(1 - \frac{\ln(n)}{2n} + \dots\right) \\ \exp(-(\chi_0 + 1)) \left(1 - \frac{\kappa \ln(n)}{n} + \dots\right) &= \chi_0 + \left(\kappa - \frac{1}{2}\chi_0\right) \frac{\ln(n)}{n} + \dots \end{aligned} \quad (4.89)$$

The first term on each side yields $e^{-(\chi_0+1)} = \chi_0$. Equating the coefficients of

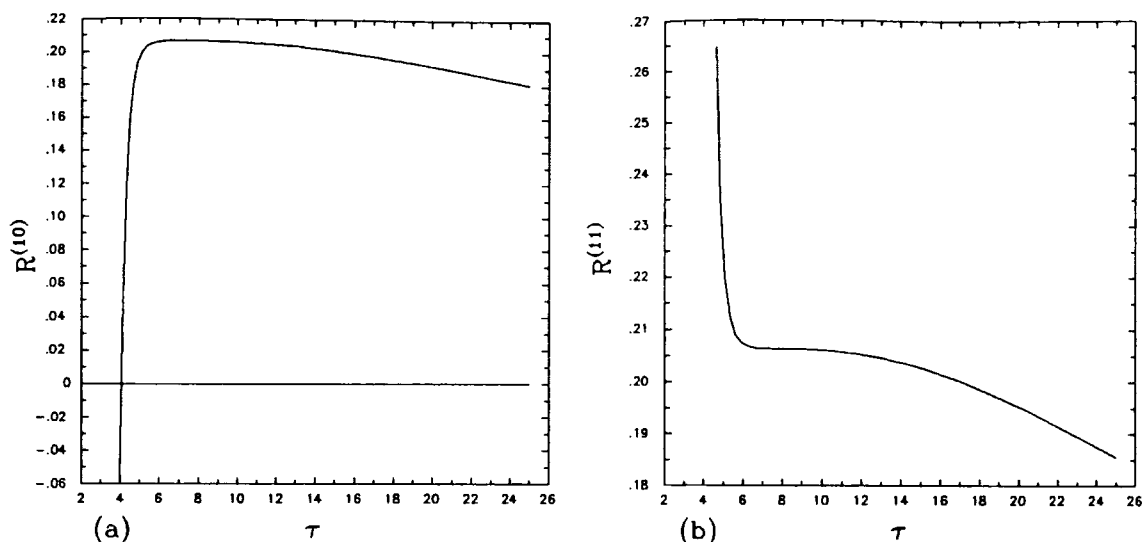

Figure 4.2 $R^{(n)}$, for n even, will have the shape shown in figure (a), while for n odd, $R^{(n)}$ will have the shape given in figure (b).

$\ln(n)/n$ yields

$$\kappa = \frac{1}{2} \left(\frac{\chi_0}{1 + \chi_0} \right), \quad (4.90)$$

as Stevenson found. So

$$\bar{\tau}_n = \bar{\tau}_s + \tau_0 = \chi_0 n + \kappa \ln(n) + O(1). \quad (4.91)$$

Figures 4.4 – 4.6 show the numerical results for various choices of $f(n)$. In each case $\bar{\tau}_n$ is plotted as a function of n . This appears to be a straight line, but in fact the slope is very gradually changing, tending to $\sim \chi_0$ or $\sim \psi\chi_0$ depending on $f(n)$, supporting the above claims.

4.7 The $\widetilde{\text{PMS}}$ Limit Considered Graphically

By considering the case of a divergent, but Borel summable, series in a class of ZSs from a graphical point of view, it is possible to see how the finite limit (4.67) arises. Stevenson's example is used to give concreteness to the discussion.

As shown in §4.3, as $a \rightarrow 0$, $\tau \rightarrow \infty$ and $R^{(n)}(\tau) \rightarrow 0$. As $a \rightarrow \infty$, $\tau \rightarrow 0$ and $R^{(n)}(\tau) \rightarrow \pm\infty$. Given these limits, and the fact that both $R^{(n)}$ and its first derivative with respect to τ are positive, only the two general forms shown

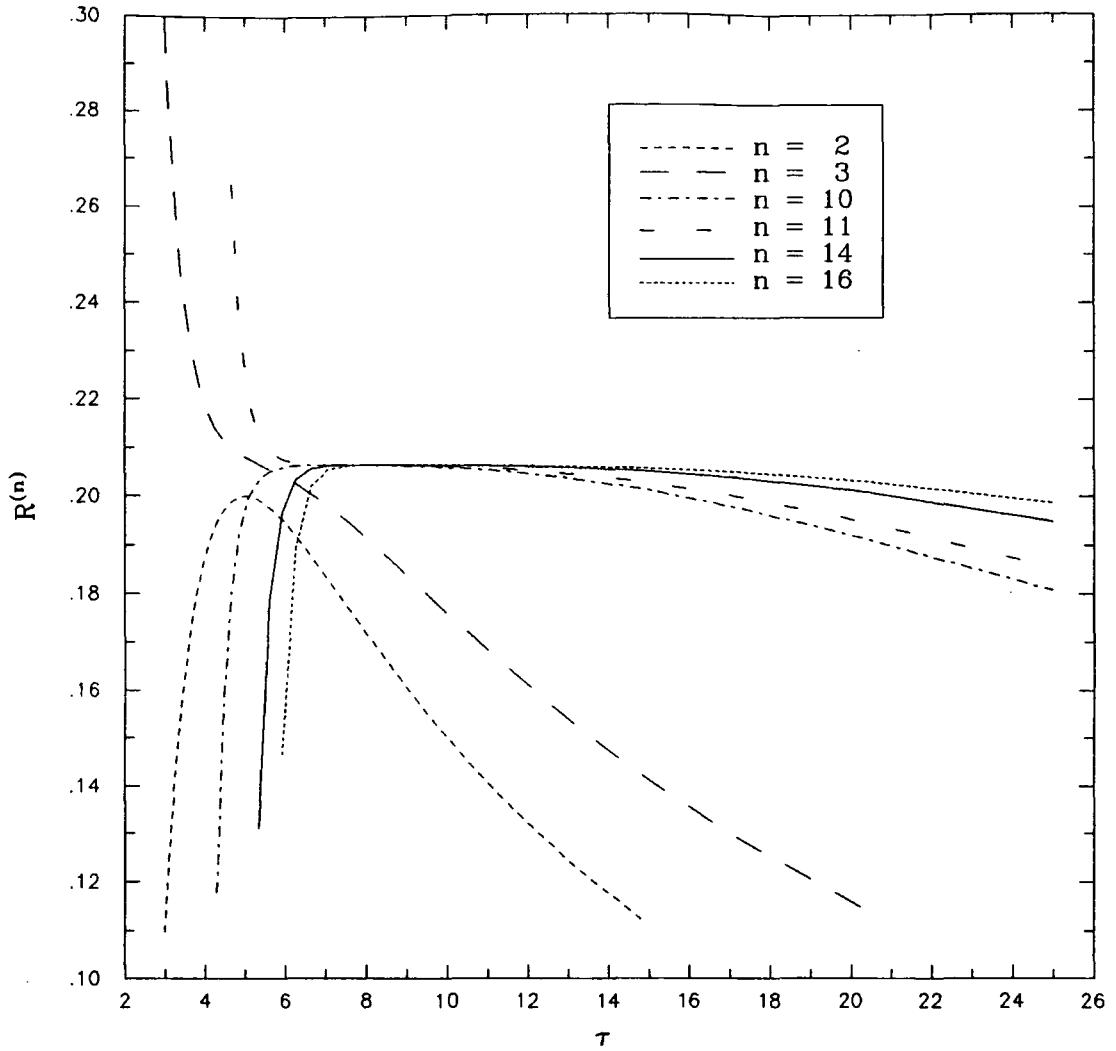

Figure 4.3 $R^{(n)}$ vs τ for six values of n , showing the plateau region around $\bar{\tau}_n$ moving off to large τ , and growing in the process.

in figure 4.2 are possible for $n \geq 3$. The $n = 2$ case is given in 4.1, and while slightly different, does not alter the discussion.

In even orders in the alternating factorial example, a plateau region exists around the stationary point at $\tau = \bar{\tau}_n$, the $\widetilde{\text{PMS}}$ renormalization point. In odd orders, where the shape of $R^{(n)}$ is as shown in figure 4.2b, there is no stationary point of inflection. That is,

$$\frac{dR^{(n)}}{d\tau} = 0 \quad (4.92)$$

has no solution, so $\bar{\tau}_n$ is taken as the τ which minimizes $dR^{(n)}/d\tau$. Doing so does not qualitatively change the following discussion, as a plateau region still occurs in these orders. Figure 4.3 shows the curves for $R^{(n)}(\tau)$, $n = 2, 3, 10, 11, 14, 16$,

for the alternating factorial case with $\tau_0 = 4$.

The $\widetilde{\text{PMS}}$ limit is found from (4.67) and (4.91) to be

$$R(\widetilde{\text{PMS}}) = \int_0^{\frac{1}{\chi_0}} du \frac{e^{-\frac{u}{a_0}}}{(1+u)}, \quad (4.93)$$

since $\lim_{n \rightarrow \infty} n/\bar{\tau}_n = 1/\chi_0$, and the Borel transform is, see (2.108),

$$F_B(u, \tau_0) = 1 - u + u^2 - \dots \quad (4.94)$$

a_0 is the couplant that corresponds to τ_0 , i.e. for $c = 0$ $\tau_0 = 1/a_0$. This Borel transform has radius of convergence 1, yet the upper limit of integration for $R(\widetilde{\text{PMS}})$ is $1/\chi_0 \sim 3.60$. The final factor in (4.61) which was set to 1, acts in such a way that $R^{(n)}$ converges outside the strict radius of convergence of the Borel transform. In fact, $R(\widetilde{\text{PMS}})$ is the limit of the even orders. In odd orders, since $\bar{\tau}_n$ only minimizes the derivative of $R^{(n)}$, the limit can be shown to be [21]

$$R(\widetilde{\text{PMS}})^{(n \text{ odd})} = R(\widetilde{\text{PMS}})^{(n \text{ even})} + \frac{\exp\left(-\frac{1}{\chi a_0}\right)}{(1+\chi)^2}, \quad (4.95)$$

a small correction, of order 10^{-7} for $\chi = \chi_0$ and $a_0 = 1/\tau_0 = 0.25$ for the alternating factorial case. By allowing complex $\bar{\tau}_n$, a solution to (4.92) can be found in both orders, and this correction terms vanishes, as does the imaginary part of $\bar{\tau}_n$, n odd.

From figure 4.3 it can be seen that the plateau region of $R^{(n)}$ grows with n , actually like $\ln(n)$ [21], and moves towards large τ as n increases. This reflects the fact that $\bar{\tau}_n$ grows as $\chi_0 n$. If a scheme is chosen that keeps τ fixed, the plateau region about $\bar{\tau}_n$ moves away from this τ , and eventually τ is in a region where the successive orders produce oscillating, divergent behaviour. This also happens to any sequence of τ 's that grow more slowly than n . At the other extreme, if τ grows faster than n , the result is overdamped to 0. So only sequences of τ 's which grow as χn will have a finite limit. Since $\bar{\tau}_n$ is chosen such that the derivative of $R^{(n)}$ is zero, the shape of $R^{(n)}$ is such that in even orders $R^{(n)}(\widetilde{\text{PMS}})$ is the maximum possible value, hence $R(\widetilde{\text{PMS}})$ is the largest

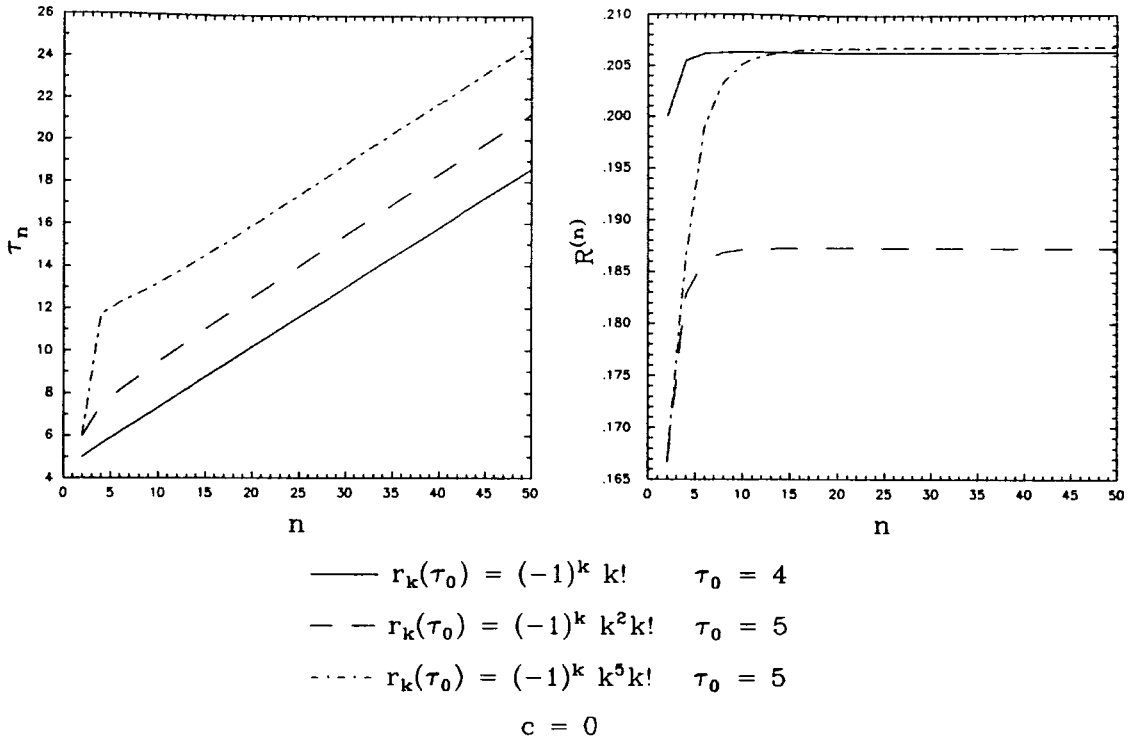

Figure 4.4 The $\widetilde{\text{PMS}}$ renormalization point, $\bar{\tau}_n$, and $R^{(n)}(\widetilde{\text{PMS}})$ are shown for $n = 2, \dots, 50$, for three different functions, $f(n)$, in $r_n(\tau_0)$ for $c = 0$. Notice that $R^{(n)}$ converges rapidly to a value equal to the truncated Borel sum, and $\bar{\tau}_n$ appears to grow linearly with n with slope converging to χ_0 , as expected of these $f(n)$.

limit obtainable. So the range of possible finite, perturbatively equivalent limits in the class of ZS's is

$$0 \leq R_{lim} \leq R(\widetilde{\text{PMS}}). \quad (4.96)$$

Since, as has been shown, for a more general case, i.e. $r_n(\tau_0) = (-1)^n f(n)n!$, $\bar{\tau}_n \sim \chi n$, the above discussion holds for any divergent perturbation series that has a Borel transform with a finite radius of convergence. In the numerical examples, 4.4–4.6, it can be seen that $\bar{\tau}_n$ grows linearly with n , and the sequence of approximants, $R^{(n)}$, approach a finite limit. This limit is numerically equal to the truncated Borel sum, where the upper limit of integration, $1/\chi$, is given by the rate of growth of $\bar{\tau}_n$,

$$R(\widetilde{\text{PMS}}) = \int_0^{\frac{1}{\chi}} du e^{-u/a_0} F_B(u, \tau_0), \quad (4.97)$$

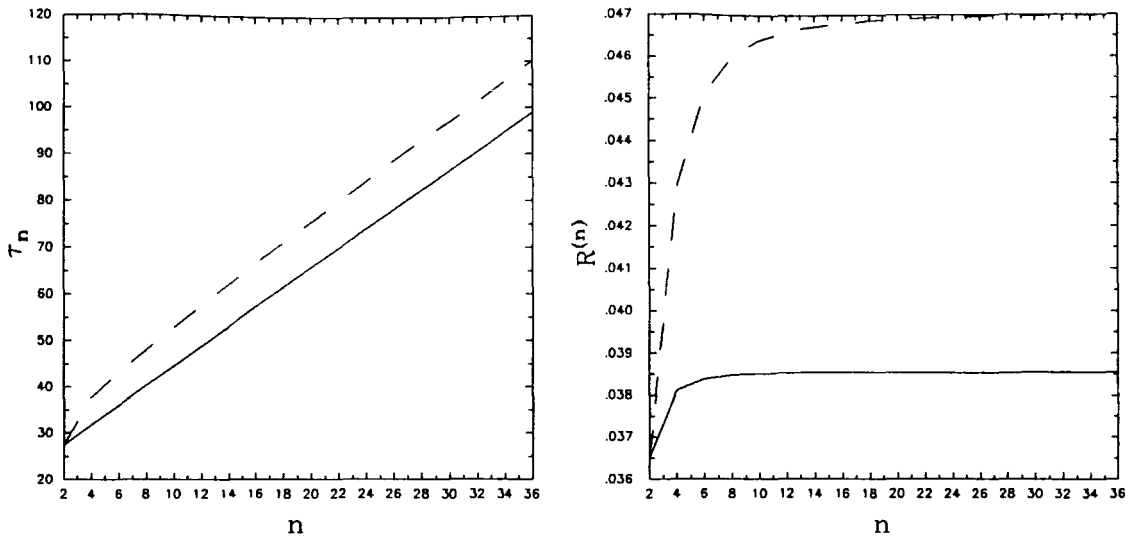

$$\begin{aligned}
 & \text{—} \quad r_k(\tau_0) = (-1)^k \exp(2k) k! \quad \tau_0 = 20 \\
 & \text{--} \quad r_k(\tau_0) = (-1)^k k^2 \exp(2k) k! \quad \tau_0 = 20 \\
 & \quad \quad \quad c = 0
 \end{aligned}$$

Figure 4.5 The $\widetilde{\text{PMS}}$ renormalization point, $\bar{\tau}_n$, and $R^{(n)}(\widetilde{\text{PMS}})$ are shown for $n = 2, \dots, 36$, for two different functions, $f(n)$, in $r_n(\tau_0)$ for $c = 0$. Again $R^{(n)}$ converges rapidly to a value equal to the truncated Borel sum. $\bar{\tau}_n$ appears to grow linearly with n with slope converging to $e^2 \chi_0$ as expected of these $f(n)$. To show this for $f(n) = \exp(2n)n^2$ it is only necessary to scale τ_s by e^{-2} in the proof for $f(n) = n^2$.

see table 4.3.

$f(n)$	R_{lim}	truncated Borel sum
1	0.206345	0.206346
n^2	0.1873	0.187309
n^5	0.206855	0.206858
$\exp(2n)$	0.038546	0.038550
$n^2 \exp(2n)$	0.04698	0.047032

Table 4.3 The limit the numerical examples are converging to and the truncated Borel sum for these examples, χ chosen to be that chosen by the rate of growth of the $\widetilde{\text{PMS}}$ renormalization point, for $c = 0$.

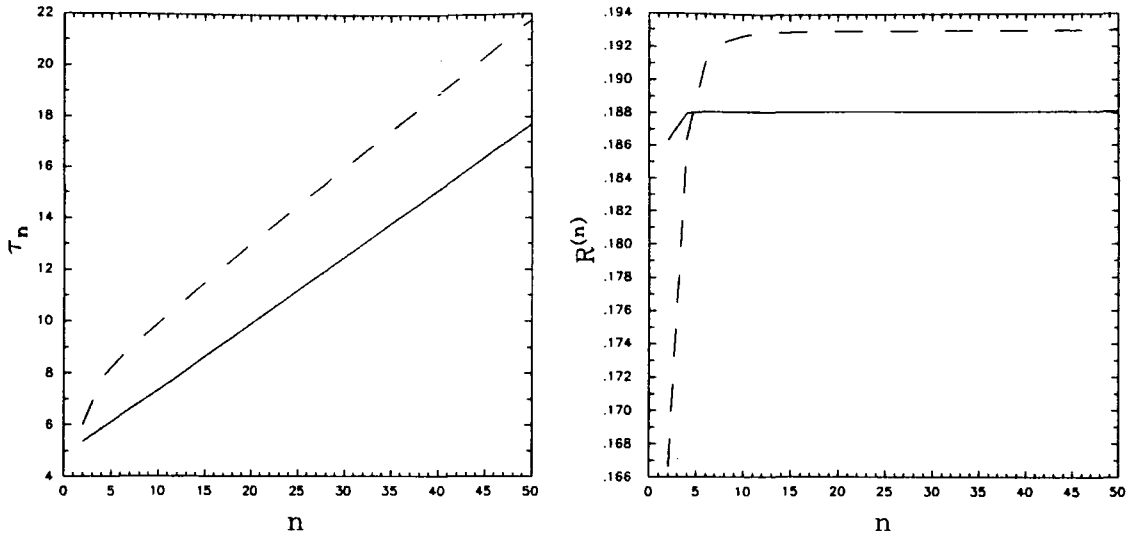

$$\begin{aligned}
 \text{—} \quad r_k(\tau_0) &= (-1)^k k^{5/2} k! & \tau_0 &= 5 \\
 \text{--} \quad r_k(\tau_0) &= (-1)^k \exp(-\sqrt{k}) k! & \tau_0 &= 5 \\
 c &= 0
 \end{aligned}$$

Figure 4.6 The $\widetilde{\text{PMS}}$ renormalization point, $\bar{\tau}_n$, and $R^{(n)}(\widetilde{\text{PMS}})$ are shown for $n = 2, \dots, 50$, for two different functions, $f(n)$, in $r_n(\tau_0)$ for $c = 0$. $R^{(n)}$ converges rapidly to a value equal to the truncated Borel sum for the case where $f(n) = \exp(-\sqrt{n})$. For the other case the Borel transform is not known. $\bar{\tau}_n$ appears to grow linearly with n with slope apparently converging slowly to χ_0 , although this as yet can not be proven.

A particularly elegant example for a convergent series is to use a geometric progression for the $r_n(\tau_0)$, with common ratio η . For this case $r_n(\tau)$ is

$$\begin{aligned}
 r_n(\tau) &= \sum_{k=0}^n \binom{n}{k} (\tau - \tau_0)^k \eta^{n-k} \\
 &= (\tau - \tau_0 + \eta)^n,
 \end{aligned} \tag{4.98}$$

so the $\widetilde{\text{PMS}}$ condition, $r_{n-1} = 0$ always has the same solution, $\bar{\tau}_n = \tau_0 - \eta$. Hence, $n/\bar{\tau}_n \rightarrow \infty$ as $n \rightarrow \infty$, and the full Borel sum results. $R(\widetilde{\text{PMS}})$, equal to the Borel sum in this case, is, not surprisingly, just the conventional sum of the series.

In figure 4.7 the results are given for the divergent series $r_n(\tau_0) = (-1)^n (n!)^2$, whose Borel transform has zero radius of convergence, and $\bar{\tau}_n \sim \ln(n!) \sim$

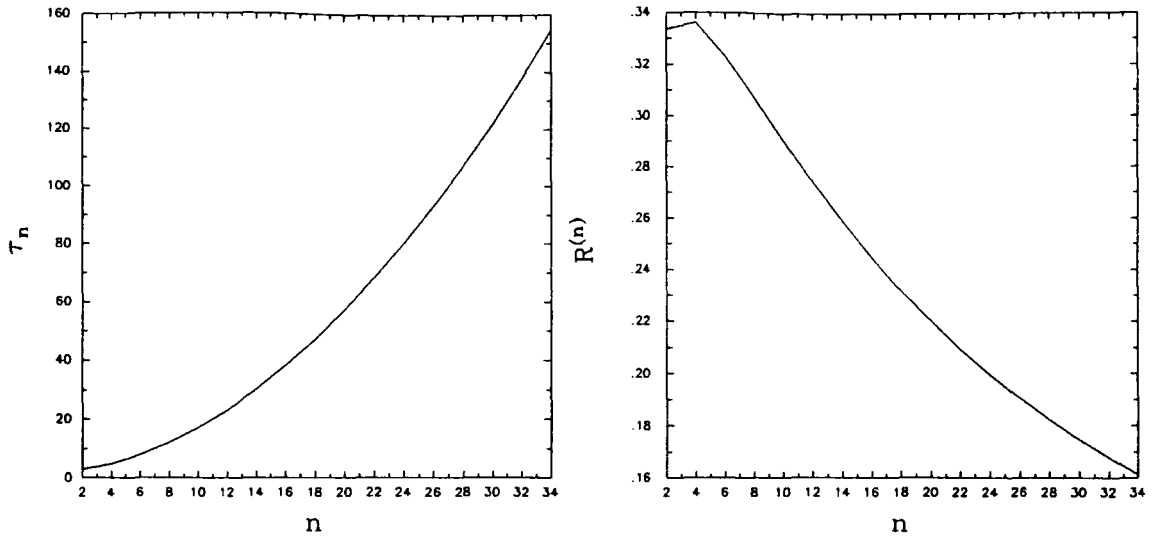

Figure 4.7 The $\widetilde{\text{PMS}}$ renormalization point, $\bar{\tau}_n$, and $R^{(n)}(\widetilde{\text{PMS}})$ are shown for $n = 2, \dots, 34$ for $c = 0$, for a series which is so divergent that even its Borel transform has zero radius of convergence, $r_n(\tau_0) = (-1)^n (n!)^2$, with $\tau_0 = 2$. $R^{(n)}(\widetilde{\text{PMS}})$ appears to be tending to zero, and $\bar{\tau}_n$ is obviously growing faster than n .

$n \ln(n) - n$ [25], and hence grows faster than n , as can be seen from the figure. The upper limit of integration for the truncated Borel sum is zero, hence $R(\widetilde{\text{PMS}}) = 0$, which appears to be supported by the numerical results.

4.8 The Case for Non-Zero c

The above results, obtained under the simplifying condition that $c = 0$, corresponding to a non-integer number of flavours, can be extended to the more realistic case where an integer number of flavours is chosen, and hence c is non-zero. For example, with five flavours in QCD $c = 1.26$.

The series coefficients now obey (4.56)

$$\frac{\partial r_k}{\partial \tau} = k r_{k-1} + c(k-1) r_{k-2}. \quad (4.99)$$

The solution for the series coefficients when $c = 0$, see (4.57), can be generalized to

$$r_k(\tau) = \sum_{m=0}^k (\tau - \tau_0)^m \sum_{j=0}^{\min(m, k-m)} c^j r_{k-m-j}(\tau_0) \nu_{kmj}. \quad (4.100)$$

The constants ν_{kmj} obey the following recurrence relation:

$$(m+1)\nu_{km+1j} = k\nu_{k-1mj} + (k-1)\nu_{k-2mj-1}, \quad (4.101)$$

with $r_0(\tau_0) \equiv 1$, $\nu_{k1-1} \equiv 0$, and $\nu_{km0} = \binom{k}{m}$. This can be split into two parts, with one part having the same structure as (4.58) since $\nu_{km0} = \binom{k}{m}$:

$$\begin{aligned} r_k(\tau) &= \sum_{m=0}^k \binom{k}{m} (\tau - \tau_0)^m r_{k-m}(\tau_0) \\ &\quad + \sum_{m=1}^{k-1} (\tau - \tau_0)^m \sum_{j=1}^{\min(m, k-m)} c^j r_{k-m-j}(\tau_0) \nu_{kmj}. \end{aligned} \quad (4.102)$$

The integrated β -function is the full integrated β -function for the class of ZS, see (3.5),

$$\tau = \frac{1}{a} + cL(a), \quad (4.103)$$

where $L(a) = \ln(ca/(1+ca))$. So the analogue to (4.58) is

$$\begin{aligned} r_k(\tau) &= \sum_{m=0}^k \left(\frac{1}{a} + cL(a)\right)^m r_{k-m}(0) \binom{k}{m} \\ &\quad + \sum_{m=1}^{k-1} \left(\frac{1}{a} + cL(a)\right)^m \sum_{j=1}^{\min(m, k-m)} c^j r_{k-m-j}(0) \nu_{kmj} \\ &= \sum_{m=0}^k \left(\frac{1}{a}\right)^m r_{k-m}(0) \binom{k}{m} + r_k^c(\tau) \\ &\equiv r_k^0(\tau) + r_k^c(\tau), \end{aligned} \quad (4.104)$$

where again $\tau_0 = 0$ has been chosen for calculational convenience. Now the first term, $r_k^0(\tau)$ has no c dependence at all, except through the couplant, a , and $r_k^c(\tau)$ has all the more explicit c dependence. Using this, the corresponding equation to (4.59) is

$$\begin{aligned} R^{(n)}(\tau) &= \sum_{k=0}^{n-1} r_k(\tau) a^{k+1}(\tau) \\ &= \sum_{m=0}^{n-1} r_m(0) a^{m+1} \sum_{k=m}^{n-1} \binom{k}{m} + R^{c(n)}(\tau), \end{aligned} \quad (4.105)$$

where $R^{c(n)}(\tau)$ contains the contributions from $r_k^c(\tau)$. Apart from the dependence of a on c through (4.103), all the c dependence comes from $R^{c(n)}(\tau)$. As

all its terms contain at least one factor of c , as $c \rightarrow 0$, $R^{c(n)}(\tau) \rightarrow 0$, and $R^{(n)}$ is merely the expression in (4.59).

Following the argument in §4.5 from (4.59) to (4.62) for the first term in (4.105), the limit of the series as $n \rightarrow \infty$ can be written

$$\begin{aligned} R_{lim} &= \lim_{n \rightarrow \infty} R^{(n)}(\tau_n) \\ &= \lim_{n \rightarrow \infty} \int_0^{na(\tau_n)} du \sum_{k=0}^{n-1} \frac{r_k(0)}{k!} u^k + R_{lim}^c, \end{aligned} \quad (4.106)$$

where $R_{lim}^c = \lim_{n \rightarrow \infty} R^{c(n)}(\tau_n)$.

If the Borel transform has finite radius of convergence, and $a(\tau_n) \sim 1/\chi n$, corresponding to $\tau_n \sim \chi n$ above, then the conjecture is, as before, see (4.64),

$$R_{lim} = \int_0^{\frac{1}{\chi}} du F_B(u, 0), \quad (4.107)$$

with $R_{lim}^c = 0$.

To motivate this, consider the full Borel transform, see (4.63) and (4.104),

$$\begin{aligned} F_B(u, \tau) &= \sum_{k=0}^{\infty} \frac{u^k}{k!} r_k(\tau) \\ &= \sum_{k=0}^{\infty} \frac{u^k}{k!} \left(\sum_{m=0}^k \left(\frac{1}{a} \right)^m r_{k-m}(0) \binom{k}{m} \right. \\ &\quad + \sum_{m=0}^k \sum_{i=0}^{m-1} \left(\frac{1}{a} \right)^i (cL(a))^{m-i} \binom{m}{i} \binom{k}{m} r_{k-m}(0) \\ &\quad \left. + \sum_{m=1}^{k-m} (\tau)^m \sum_{j=1}^{\min(m, k-m)} c^j r_{k-m-j}(0) \nu_{kmj} \right). \end{aligned} \quad (4.108)$$

As discussed above, the first term has no c dependence except through $1/a$ and (4.103). Therefore, $F_B(u, \tau)$ can be written as the sum of a virtually c independent part, denoted by a superscript 0, which is just the first term above, and a piece which contains all the explicit c dependence – the sum of the second

and third terms above – denoted by a superscript c :

$$F_B(u, \tau) = F_B^0(u, \tau) + F_B^c(u, \tau), \quad (4.109)$$

where

$$\begin{aligned} F_B^0(u, \tau) &= \sum_{k=0}^{\infty} \frac{r_k^0(\tau)}{k!} u^k \\ F_B^c(u, \tau) &= \sum_{k=0}^{\infty} \frac{r_k^c(\tau)}{k!} u^k. \end{aligned} \quad (4.110).$$

Now at $\tau = 0$, the third term in (4.108) vanishes, as each term has a factor of τ^m , $m > 0$. As $\tau \rightarrow 0$, $a \rightarrow \infty$ so $L(a) \rightarrow 0$, as does $1/a$. As all terms in the second term contain either $L(a)^m$ or $(1/a)^i L(a)^{m-i}$, this term must vanish as well. Hence all terms which contribute to $F_B^c(u, 0)$ are zero, so it must be zero. The only terms which survive in the first group of terms are those where $m = 0$, leaving

$$\begin{aligned} F_B(u, 0) &= \sum_{k=0}^{\infty} \frac{u^k}{k!} r_k(0) \\ &= F_B^0(u, 0). \end{aligned} \quad (4.111)$$

This comes about because at $\tau = 0$, $r_k^0(0) = r_k(0)$ and $r_k^c(0) = 0$.

Consider now the τ dependence of the full Borel sum of the series, R_B , and that of the Borel sum of $F_B^0(u, \tau)$, denoted R_B^0 . It can be shown that

$$\frac{\partial F_B(u, \tau)}{\partial \tau} = u F_B(u, \tau) + c \int_0^u dv v F_B(v, \tau), \quad (4.112)$$

so that

$$\begin{aligned} \frac{\partial R_B}{\partial \tau} &= \frac{\partial}{\partial \tau} \int_0^{\infty} du e^{-\frac{u}{a}} F_B(u, \tau) \\ &= \int_0^{\infty} du e^{-\frac{u}{a}} \left(\frac{\partial F_B(u, \tau)}{\partial \tau} - u(1 + ca) F_B(u, \tau) \right), \end{aligned} \quad (4.113)$$

where R_B is the Borel sum. Substituting for $\partial F_B(u, \tau)/\partial \tau$ from above, and integrating by parts yields the fact that the full Borel sum is a scheme invariant.

However, replacing the upper limit of integration by $1/\chi$, and repeating the above procedure, does not yield zero but

$$\frac{\partial R_B}{\partial \tau} = -cae^{-\frac{1}{\chi a}} \int_0^{\frac{1}{\chi}} dv v F_B(v, \tau), \quad (4.114)$$

a term which vanishes if the upper limit of integration is ∞ , not $1/\chi$.

The case for $F_B^0(u, \tau)$ is subtly different in that

$$\frac{\partial F_B^0(u, \tau)}{\partial \tau} = u(1 + ca)F_B^0(u, \tau), \quad (4.115)$$

which is all that is required to make

$$\int_0^{\frac{1}{\chi}} du e^{-\frac{u}{a}} F_B^0(u, \tau), \quad (4.116)$$

independent of τ regardless of the upper limit of integration. So both the full and truncated Borel sums of $F_B^0(u, \tau)$ are scheme invariants. Furthermore, or rather, because of this, it can be shown that

$$F_B^0(u, 0) = e^{-\frac{u}{a}} F_B^0(u, \tau), \quad (4.117)$$

an equivalent statement to (4.66). Hence

$$\int_0^{\frac{1}{\chi}} du F_B^0(u, 0) = \int_0^{\frac{1}{\chi}} du e^{-\frac{u}{a}} F_B^0(u, \tau). \quad (4.118)$$

The fact that the full Borel sum and the Borel sum of $F_B^0(u, \tau)$ are both scheme invariants means that the Borel sum of $F_B^c(u, \tau)$ is also τ independent. Since $F_B^c(u, 0) = 0$, it implies that

$$R_B^c = \int_0^{\infty} du e^{-\frac{u}{a}} F_B^c(u, \tau) = 0 \quad \forall \tau. \quad (4.119)$$

This implies that

$$R_B = R_B^0 = \int_0^{\infty} du e^{-\frac{u}{a}} F_B^0(u, \tau) \quad \forall \tau. \quad (4.120)$$

Consider the full sum, split into two components:

$$R = \sum_{k=0}^{\infty} a^{k+1}(\tau) r_k^0(\tau) + \sum_{k=0}^{\infty} a^{k+1}(\tau) r_k^c(\tau). \quad (4.121)$$

If R is convergent then the Borel sum yields the conventional sum of the series. The above result means that the contribution arising from $r_k^c(\tau)$ can be

completely ignored, and the full sum is just given by

$$R = \sum_{k=0}^{\infty} a^{k+1}(\tau) r_k^0(\tau). \quad (4.122)$$

That is, the “0” component alone yields the full sum, $R_B = R_B^0$. Hence $R_{lim}^c = 0$.

For the divergent case which has a Borel transform with finite radius of convergence, and in which $a(\tau_n) \sim 1/\chi n$, the contribution from the “0” component is

$$\begin{aligned} R_{lim} &= \int_0^{\frac{1}{\chi}} du F_B(u, 0) \\ &= \int_0^{\frac{1}{\chi}} du e^{-\frac{u}{a(\tau)}} F_B^0(u, \tau). \end{aligned} \quad (4.123)$$

The conjecture made here is that, for this case too, the c component also vanishes; i.e. $R_{lim}^c = 0$ again. Since R_{lim}^c must be represented by an expression which is perturbatively equivalent to the $r_k^c(\tau)$ component of the series, i.e. a power series expansion of R_{lim}^c must yield the second term in (4.121), with possible perturbatively invisible terms needed to recover R_{lim}^c exactly, it can be written

$$R_{lim}^c = \int_0^{\text{upper limit}} du e^{-\frac{u}{a(\tau)}} F_B^c(u, \tau), \quad (4.124)$$

for some, as yet unknown, upper limit of integration. Only two limits yield a τ independent expression; infinity and zero. In the first case R_{lim}^c is just the Borel sum, R_B^c , which has been shown to be zero, (4.120). With zero as the upper limit, R_{lim}^c is trivially zero.

To test the conjecture, $r_k(\tau_0)$ has been taken to be

$$r_k(\tau_0 = 4) = (-1)^k k!, \quad (4.125)$$

with $c = 1.26$. $R^{(n)}(\widetilde{\text{PMS}})$, $R^{0(n)}(\widetilde{\text{PMS}})$ and $R^{c(n)}(\widetilde{\text{PMS}})$ have been plotted as functions of n in figure 4.8. This indeed shows that $R^{c(n)}(\widetilde{\text{PMS}})$ is approaching zero from above, and $R^{0(n)}(\widetilde{\text{PMS}})$ is approaching $R^{(n)}(\widetilde{\text{PMS}})$ from below. However, $R^{0(n)}(\widetilde{\text{PMS}})$ is converging very slowly, much more so than the sum of $R^{0(n)}(\widetilde{\text{PMS}})$ and $R^{c(n)}(\widetilde{\text{PMS}})$. A detailed analysis of $R^{c(n)}$ would be necessary to understand the compensatory mechanism between the two components, but this has not been attempted.

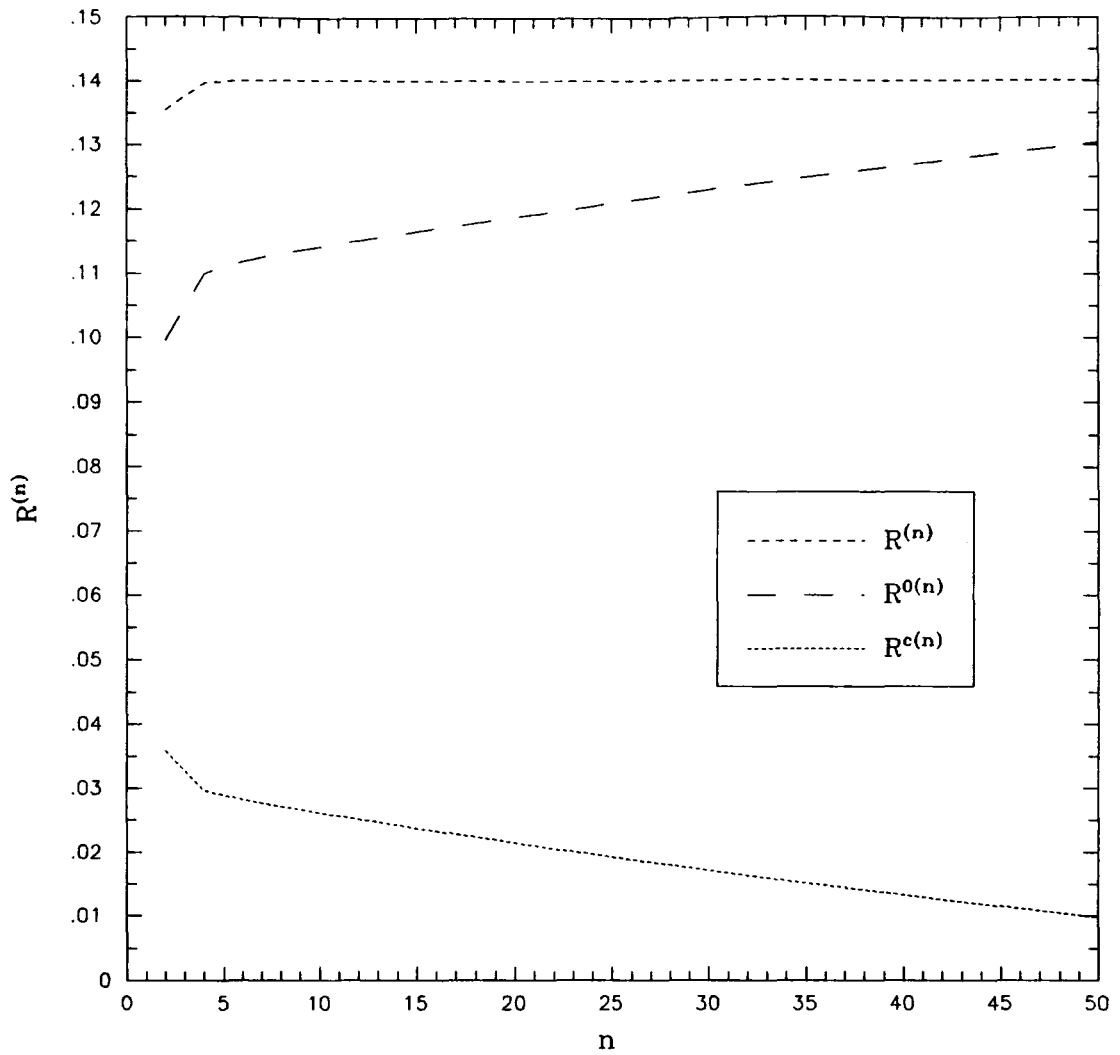

Figure 4.8 $R^{(n)}(\widetilde{\text{PMS}})$, $R^{0(n)}(\widetilde{\text{PMS}})$ and $R^{c(n)}(\widetilde{\text{PMS}})$ are shown for $n = 2, \dots, 50$ for the alternating factorial example, with $\tau_0 = 4$ and for $c = 1.26$, showing that $R^{0(n)}(\widetilde{\text{PMS}})$ tends to $R^{(n)}(\widetilde{\text{PMS}})$ as $n \rightarrow \infty$, and $R^{c(n)}(\widetilde{\text{PMS}})$ tends to 0.

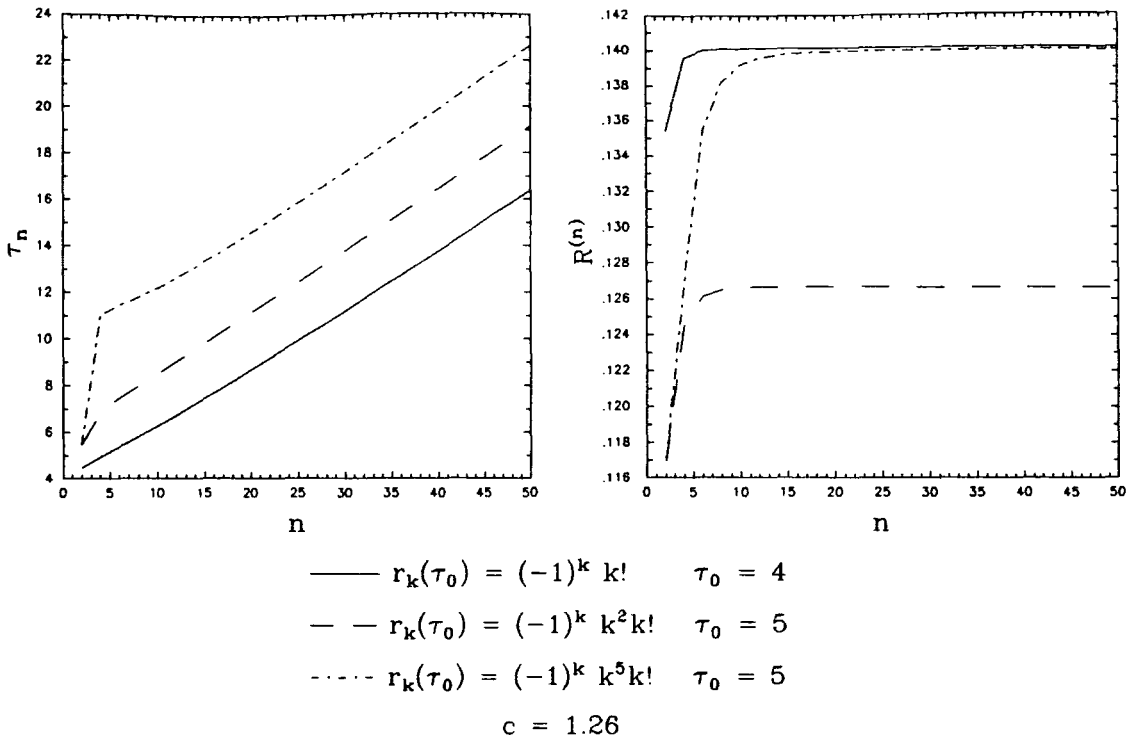

Figure 4.9 The $\widetilde{\text{PMS}}$ renormalization point, $\bar{\tau}_n$, and $R^{(n)}(\widetilde{\text{PMS}})$ are shown for $n = 2, \dots, 50$, for three different functions, $f(n)$, in $r_n(\tau_0)$ for $c = 1.26$. Notice that $R^{(n)}$ converges rapidly to a value equal to the truncated Borel sum, and $\bar{\tau}_n$ appears to grow linearly with n with slope converging to χ_0 .

$f(n)$	R_{lim}	truncated Borel sum
1	0.140127	0.140128
n^2	0.126679	0.126679
n^5	0.139969	0.139970
$\exp(2n)$	0.033499	0.033502
$n^2 \exp(2n)$	0.03943	0.039458

Table 4.4 The limit the numerical examples are converging to and the truncated Borel sum for these examples, χ chosen to be that chosen by the rate of growth of the $\widetilde{\text{PMS}}$ renormalization point, for $c = 1.26$.

As in the $c = 0$ case, for a series whose Borel sum has zero radius of convergence, the conclusion is that the only possible limit is zero.

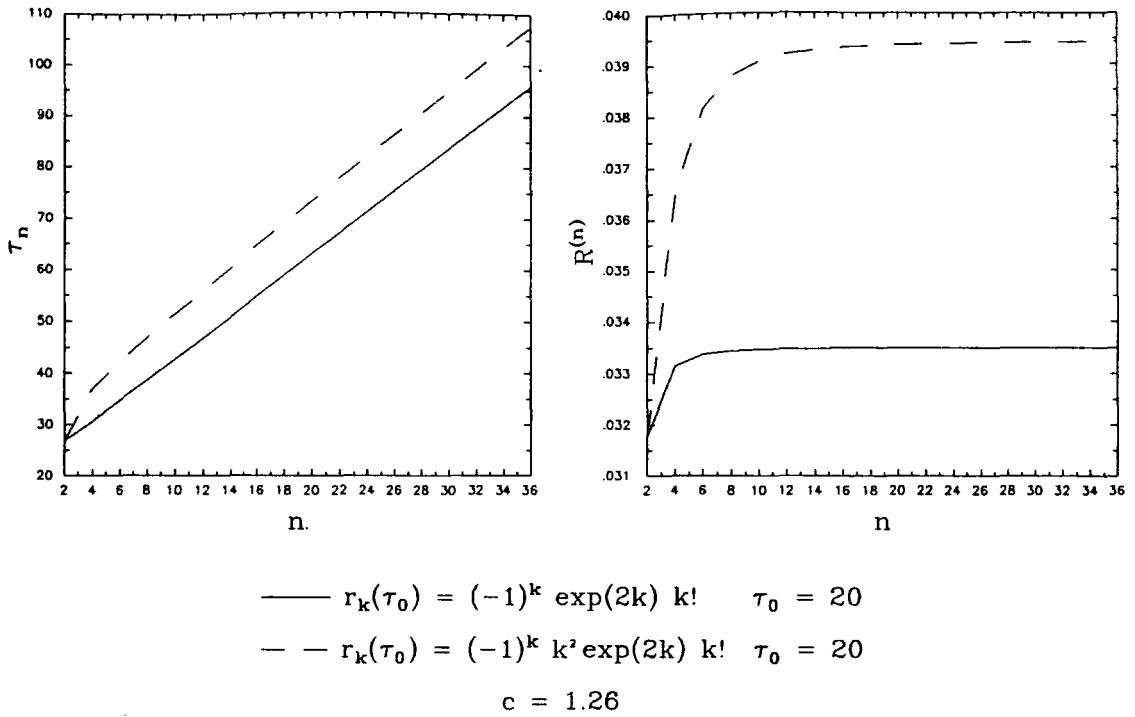

Figure 4.10 The $\widetilde{\text{PMS}}$ renormalization point, $\bar{\tau}_n$, and $R^{(n)}(\widetilde{\text{PMS}})$ are shown for $n = 2, \dots, 36$, for two different functions, $f(n)$, in $r_n(\tau_0)$ for $c = 1.26$. Again $R^{(n)}$ converges rapidly to a value equal to the truncated Borel sum. $\bar{\tau}_n$ appears to grow linearly with n , with slope converging to $e^2 \chi_0$.

Figures 4.9 – 4.13 give the $c \neq 0$ analogues of 4.4 – 4.7. Again $\widetilde{\text{PMS}}$ was used to choose the renormalization point, $\bar{\tau}_n$, but now $c = 1.26$. For figures 4.9 – 4.11 $\bar{\tau}_n$ grows almost linearly with n , with the slopes again tending to χ_0 or $\psi\chi_0$, depending on $f(n)$, see §4.6. $R^{(n)}(\widetilde{\text{PMS}})$ converges rapidly for each of these examples to a value close to the truncated Borel sum of the series, see table 4.4. For a series whose coefficients at τ_0 form a geometric progression, and hence is convergent, again $R^{(n)}(\widetilde{\text{PMS}})$ yields the conventional sum of the series and $\bar{\tau}_n$ tends to a constant value, see 4.12. This is not the case in 4.13, where $\bar{\tau}_n$ is clearly growing faster than n , and $R^{(n)}(\widetilde{\text{PMS}})$ is tending to zero, as predicted.

4.9 Finite Schemes

Until now the special case of zero schemes, ZS, where all the higher β -function coefficients are zero, has been discussed. However, the above formalism

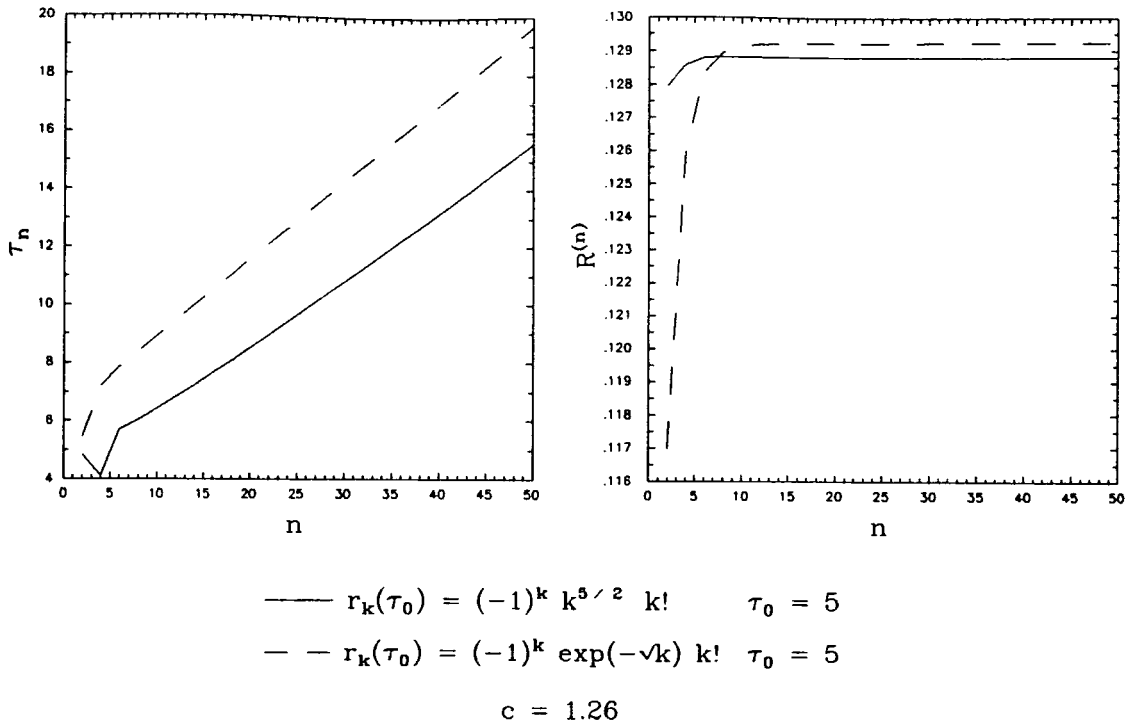

Figure 4.11 The $\widetilde{\text{PMS}}$ renormalization point, $\bar{\tau}_n$, and $R^{(n)}(\widetilde{\text{PMS}})$ are shown for $n = 2, \dots, 50$, for two different functions, $f(n)$, in $r_n(\tau_0)$ for $c = 1.26$. $R^{(n)}$ converges rapidly to a value equal to the truncated Borel sum for the case where $f(n) = \exp(-\sqrt{n})$. For the other case the Borel transform is not known. $\bar{\tau}_n$ appears to grow linearly with n , with slope apparently converging slowly to χ_0 , although this as yet can not be proven.

generalizes in a simple fashion to the case of finite schemes, where c_2, \dots, c_k are possibly non-zero.

As in (4.104), the series coefficients can be divided into two pieces, $r_k^0(\tau)$ as given in (4.104), and a piece containing all the other, explicitly c and c_j , $2 \leq j \leq k$, dependent terms, denoted $r_k^{c_j}(\tau)$ for ease of notation. The Borel transform can be split as well into $F_B^0(u, \tau) + F_B^{c_j}(u, \tau)$, such that $F_B(u, 0) = F_B^0(u, 0)$, see (4.108) – (4.111). Given that the full Borel sum is scheme invariant, the same conclusions will follow, in particular

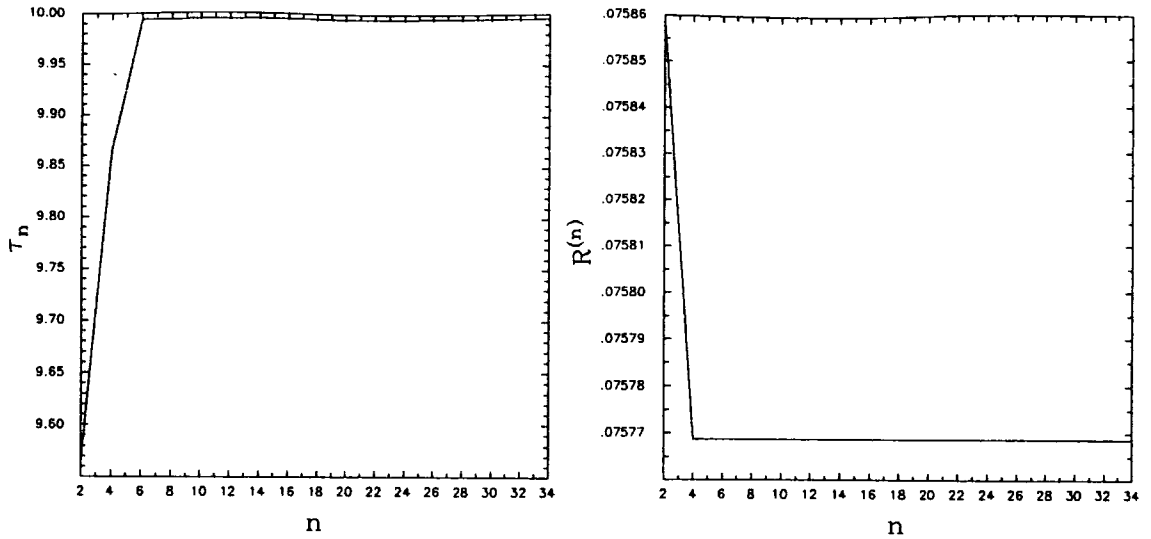

Figure 4.12 The $\widetilde{\text{PMS}}$ renormalization point, $\bar{\tau}_n$, and $R^{(n)}(\widetilde{\text{PMS}})$ are shown for $n = 2, \dots, 50$ for $c = 1.26$, for a series whose coefficients at τ_0 for a geometric progression, $r_n(10) = (-e^{-2})$. $\bar{\tau}_n$ converges rapidly, and $R^{(n)}$ converges to the full Borel sum.

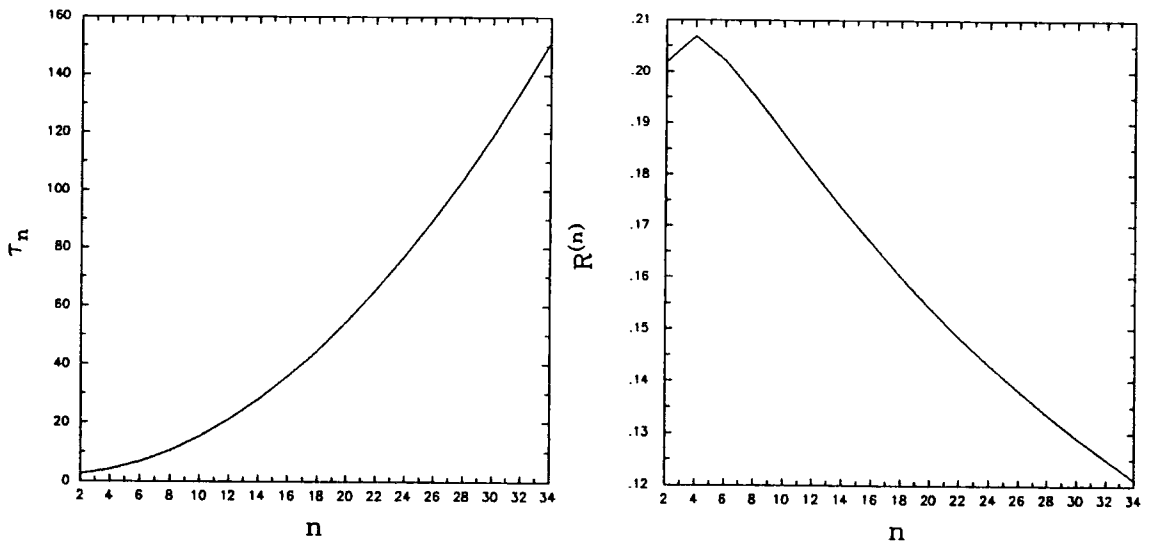

Figure 4.13 The $\widetilde{\text{PMS}}$ renormalization point, $\bar{\tau}_n$, and $R^{(n)}(\widetilde{\text{PMS}})$ are shown for $n = 2, \dots, 34$ for $c = 1.26$, for a series which is so divergent that even its Borel transform has zero radius of convergence, $r_n(\tau_0) = (-1)^n (n!)^2$. $R^{(n)}(\widetilde{\text{PMS}})$ appears to be tending to zero, and $\bar{\tau}_n$ is obviously growing faster than n .

$$\begin{aligned}
R_{lim} &= \int_0^{\frac{1}{x}} du F_B(u, 0) \\
&= \int_0^{\frac{1}{x}} du F_B^0(u, 0) \\
&= \int_0^{\frac{1}{x}} du e^{-\frac{u}{a}} F_B^0(u, \tau).
\end{aligned} \tag{4.126}$$

Again this assumes that $R_{lim}^{c_j} = 0$. R_{lim} and R_B are perturbatively equivalent for the same reasons given at the end of §4.5.

All the other conclusions go through unchanged, including the argument that if the series is so divergent that its Borel transform has zero radius of convergence, the only possible limit is zero. So once again Borel summability is a necessary condition for the existence of a finite limit that is at least perturbatively unique.

4.10 The Behaviour of Perturbation Series at High Orders

If the renormalization group is to successfully sum perturbation series, they must be Borel summable in some fixed finite scheme. Hence the high order behaviour must be considered to find out whether this is the case. For QED and QCD Stevenson argues [21] that there is actually no evidence that the series are divergent at all. It is even possible that they might be convergent, obviating the necessity for Borel summation or optimizing schemes. The flaws in the conventional arguments are exposed by the following considerations, which are a brief summary of those given by Stevenson.

The full result for a physical quantity calculated in a renormalizable field theory is the sum of the perturbation series expansion and various terms which represent the non-perturbative effects, for example higher twist terms in electroproduction and instantons. Hence, it is presumed that the full quantity can be written

$$\begin{aligned}
R &= a(1 + r_1 a + r_2 a^2 + \dots) \\
&\quad + e^{-\frac{1}{a}}(1 + A_1 a + A_2 a^2 + \dots) \\
&\quad + e^{-\frac{2}{a}}(1 + B_1 a + B_2 a^2 + \dots) + \dots
\end{aligned} \tag{4.127}$$

where the first series is the one considered throughout this thesis. These non-perturbative terms render the full result non-analytic at $a = 0$. In §2.10 Dyson's

argument on the non-analyticity at $a = 0$ is outlined. In this discussion an implicit assumption is made, that this non-analyticity comes from the perturbation theory contribution to R . If this were the case then the perturbative expansion would have zero radius of convergence. However, the non-analytic behaviour may be due to the non-perturbative terms, in which case no conclusions can be made about the nature of the perturbation expansion. This allows for the possibility that it is convergent.

Similar objections can be made about 't Hooft's arguments on QCD Green's functions [26]. He showed that Watson's theorem fails, see e.g.[54], so the full Green's functions can not be reconstructed by Borel summation. However, since the presence of $e^{-\frac{1}{a}}$ terms would prevent a perturbative expansion from being the whole answer, such a failure may indicate the presence of such terms. Because

$$e^{-\frac{1}{a}} = \int_0^{\infty} du e^{-\frac{u}{a}} \delta(1-u), \quad (4.128)$$

instantons and other non-perturbative effects which give rise to terms of this form, will contribute singularities in the Borel transform of the form $\delta(1-u)$ and its derivatives. These singularities should not necessarily be taken to indicate that the perturbative expansion is hopelessly divergent as 't Hooft concludes.

While Stevenson's arguments seem justified as far as they go, there are singularities in the Borel transform of perturbative origin, named renormalons, [27]. These non-integrable singularities can not be dismissed as above, as they contribute, not δ -functions, but perturbatively generated branch points to the Borel transform, i.e.

$$F_B^{\text{renormalons}} = \frac{\xi}{(u-u_i)^{\lambda_i}}. \quad (4.129)$$

In principle, the positions of the renormalons, u_i , and their positive exponents, λ_i , are calculable in QCD. Ultra-violet renormalons, those which arise from arbitrarily large momenta in the diagrams which contribute to R , are not a problem, as they lie outside the region of integration, being on the negative real axis. On the other hand, infra-red renormalons, those which come from arbitrarily small momenta, lie on the positive real axis. These constitute a problem, as they render the perturbative Borel sum undefined.

If, apart from these singularities, the perturbation series is Borel summable, the set of renormalization group sums, characterized by χ , will be

$$R_{lim} = \int_0^{\frac{1}{\chi}} du e^{-\frac{u}{a}} \left(F_B(u, \tau) + \frac{\xi}{(u - u_i)^{\lambda_i}} + \dots \right). \quad (4.130)$$

Obviously, if $1/\chi < u_i$, R_{lim} is still finite, but will contain additional contributions from the renormalons. Mueller [27] claims that these contributions can be removed order by order in perturbation theory.

4.11 Discussion and Summary

Given the diverse nature of the above arguments, it may clarify the situation to summarize the above discussion and weave the separate strands together to form a more coherent picture.

Due to the renormalization group, a physical quantity, R , does not have a perturbative expansion in a unique, fixed coupling constant, but one which depends on the renormalization scheme employed. At each order any scheme, S_n , desired can be chosen to calculate the approximant, $R^{(n)}(S_n)$, where the scheme is specified by choosing the $n - 1$ parameters $\tau_n, c_2, \dots, c_{n-1}$. Choosing only $n - 1$ parameters means that the β -function is truncated at n^{th} order, and through it the couplant at this order is defined, $a^{(n)} = a^{(n)}(\tau_n, c_2, \dots, c_{n-1})$. Hence the definition of the couplant changes order by order.

By studying the surface of $R^{(n)}(\tau_n, c_2, \dots, c_{n-1})$, §4.3, it was shown that for $n > 2$, $R^{(n)}$ ranged from zero to infinity. Only $R^{(2)}$ is bounded above. So $R^{(n)}$ can take any positive value, and the limit of the sequence of approximants, $R_{lim} = \lim_{n \rightarrow \infty} R^{(n)}(S_n)$, is completely arbitrary, regardless of the form of the perturbation series in a fixed scheme. Hence, without additional information or restriction on the choice of RS, perturbation theory has no predictive power.

In §4.4 two choices of RS were considered, the EC and the PW schemes. It was shown that the most likely limit for these schemes, if one exists, is zero, which requires that the truncated β -function has zeros in every order such that the position of the zero closest to the origin tends to the origin as $n \rightarrow \infty$. If the truncated β -function did not have zeros in each order, eventually it ceased to

have a solution, since τ_n is fixed for these schemes. So the couplant, and hence the approximant, become undefined.

By allowing only “finite schemes”, in which only a finite number of β -function coefficients are non-zero, or in which the β -function is convergent, and allowing τ_n to vary, it is assured that the couplant will always be well defined, and the problem that plagues the EC and PW schemes does not occur. The zero schemes, ZS, with all the higher β -function coefficients set to zero, are the most extreme examples of finite schemes. This class of schemes has a single parameter, τ_n . §4.5 showed that only if the perturbation series in some fixed scheme is Borel summable could a finite, perturbatively unique limit exist. Disregarding a few subtleties, it was shown that, (4.67),

$$R_{lim} = \int_0^{\frac{1}{\chi}} du e^{-u/a(\tau)} F_B(u, \tau), \quad (4.131)$$

with τ_n of the ZS chosen such that $\lim_{n \rightarrow \infty} \tau_n/n = \chi$, where χ is a constant. The difference between the $R_{lim}(1/\chi)$, and between R_{lim} and the full Borel sum is due to the different upper limits of integration. Hence the differences are proportional to the perturbatively invisible term e^{-1/χ^a} , which vanishes as the couplant vanishes – the region in which perturbation theory is most reliable. It is in this sense that the obtainable sum is unique, in contrast to the case where no restriction is placed on the RS and the limit was completely arbitrary.

Note that if the perturbation series is convergent then, in the above discussion, τ_n can be chosen to be a constant, and the full Borel sum results. This just yields the conventional sum of the series.

It seems, therefore, that, if sensibly interpreted, renormalization group improved perturbation series for physical quantities have a unique sum. It is the renormalization group which demands series which are Borel summable in a fixed scheme.

While giving the assurance that there is a unique sum, the above discussion does not indicate how to choose the scheme when actually doing a calculation. Simply choosing a value for χ and letting $\tau_n = \chi n$ would not necessarily work, since if χ is too small the τ_n may not track the plateau region discussed in §4.7, but eventually fall in the region where the $R^{(n)}$ exhibit divergent, oscillatory

behaviour. χ must be larger than some minimum value which depends on the details of the series, and is as yet uncalculable, for the sum to exist. Hence “optimization”, as it is called, can be used to find a sequence of τ_n so that the sequence of approximants converges.

For $c = 0$, the optimization method $\widetilde{\text{PMS}}$, the application of PMS to the ZS, chooses $\tau_n = \bar{\tau}_n$ so that the approximant is minimally sensitive to the renormalization point, was considered in §4.6. For Borel summable series this results in a renormalization point which, at least at large n , grows as χn , where χ again depends on the details of the series. This indeed tends to a limit $R(\widetilde{\text{PMS}})$. §4.7 showed graphically why $R(\widetilde{\text{PMS}})$ can be considered to be the maximum limit obtainable. The discussion was extended and generalized to the case of non-zero c , and other finite schemes, notwithstanding various unproved assumptions.

From table 4.2 it can be seen that for a finite scheme, that is, one with $\hat{\beta}(a)$ convergent, $\hat{\rho}(a)$ and $R(a)$ are both either convergent or divergent. If $\hat{\rho}(a)$ is divergent then it is likely that if the EC and PW schemes have a finite limit, it will be zero. A finite scheme, on the other hand, may still yield a limit if the divergent perturbation series, $R(a)$, is Borel summable. If $\hat{\rho}(a)$ is convergent, then EC, PW and the finite scheme should all yield the conventional sum of the series.

The behaviour of full PMS, in which all the β -function coefficients are chosen at each order along with renormalization point to minimize the sensitivity of the approximant to the RS, is an interesting question. As will be described in chapter 5, attempts to investigate it numerically failed. It is possible that PMS and the PW approximation differ in high orders. In particular the PMS β -function coefficients, c_k^{PMS} , may, in the $n \rightarrow \infty$ limit, constitute a convergent β -function, in which case PMS will be equivalent to $\widetilde{\text{PMS}}$ in that particular finite scheme.

5 Technology

5.1 Introduction

Once a calculation has been done for a physical quantity in a particular scheme and the β -function coefficients are known in the same scheme to the same order, the scheme invariants may be found. From these, for any other scheme in which the β -function coefficients are known, the series coefficients for that quantity may now be found – or the β -function coefficients if the series coefficients are known – and the quantity may be calculated in this new scheme to the same order. This chapter deals with the implementation of this process on a computer – the way the reversion coefficients were calculated and used to find the scheme invariants. The methods of obtaining the results in the EC, PW, $\widetilde{\text{PMS}}$ and PMS schemes from the scheme invariants will be discussed.

5.2 The Reversion Coefficients

The first step in obtaining the scheme invariants is to evaluate the reversion coefficients, the multinomials of the series coefficients (3.25);

$$K_n = \sum \frac{(n+1)(n+2)\dots(n+s)}{p!q!\dots} (-1)^{s+1} r_i^p r_j^q \dots, \quad (5.1)$$

where the number of series coefficients in each term of the expansion is determined by the constraints

$$pi + qj + \dots = n - 1 \quad (5.2a)$$

$$n \geq i > j > \dots \geq 0, \quad (5.2b)$$

and s is defined by

$$s + 1 \equiv p + q + \dots \quad (5.3)$$

As it is often necessary to find reversion coefficients for more than one scheme, and also to reverse the process and generate series coefficients from reversion coefficients, a general method of calculating them was needed. To this end, for each K_n an $(n-1) \times m$ array was created where $n-1$ is the number of columns,

and m is the number of rows. Each row in the array corresponds to one term in the expression for K_n , with the power of r_i , $i = 1, \dots, n - 1$ in that term stored in the i^{th} column. Hence these arrays are independent of the actual values of the series coefficients. The overall factor is stored in a separate array of size m .

Computing the powers and combinations of the r_i is equivalent to finding all combinations of numbers that satisfy conditions (5.2a) and (5.2b). Since patterns occur in this process, the arrays representing the K_n were computed from lowest to highest, so that lower K_i could be used in the computation of K_n . In computing K_n the highest contributing series coefficient, r_{n-1} , was considered first, then each of the others in turn. The term containing r_{n-1} is trivial – the power is always one, and the factor is always -1 . For a general term the procedure is to consider the contribution from the p^{th} power of r_i , and define a variable, *remainder*, to be

$$\textit{remainder} \equiv (n - 1) - i \times p. \quad (5.4)$$

remainder is the number needed to satisfy condition (5.2a). For example, if *remainder* = 0, (5.2a) is satisfied, and no other r_i contributes to this term. p is then put in the i^{th} column, all other entries in this row are left at zero, and the overall factor is calculated and stored. If *remainder* = 1, then the only possible factor is from r_1 with power one. So 1 is stored in column one, p in column i , and the overall factor calculated and stored. If *remainder* = $q > 0$, then several factors are possible and necessary. These correspond to all contributions to K_{q+1} which involve series coefficients r_j , $j = 1, \dots, i - 1$. Terms which contribute to K_{q+1} which involve series coefficients r_j , $j \geq i$, may not be used, to prevent violating (5.2b) which exists to prevent overcounting. If the remainder is negative, then this power, and all higher powers, of r_i do not contribute to K_n .

Starting from the highest series coefficient and working downwards, the above procedure is used for each series coefficient starting at r_i^p , $p = 1$, and working through increasing powers until $i \times p > n - 1$. The next lowest coefficient is then considered, and so on until all possible combinations have been recorded.

To construct the K_n from given r_i , it is just a matter of stepping through each of the m rows of the array. For each row, r_1 is raised to the power stored

in column 1, multiplied by r_2 raised to the power stored in column 2, etc, and finally multiplied by the overall factor. The sum of these m terms is the value of K_n for the given set of series coefficients. A similar procedure is used to find the series coefficients from the reversion coefficients.

In practice, the only way to do this is to store all these two-dimensional arrays in one large one-dimensional array. This method is incidentally the most efficient in terms of storage. This way differs from the described method in only a few “bookkeeping” aspects – the procedure outlined above is essentially the same. For example, instead of three arrays to hold $K_1 (\equiv 1)$, K_2 and K_3 , K_1 is stored as the first element of the array, the terms for K_2 are stored in positions 2-5, and those for K_3 in positions 6-14. So an extra array is needed to record the position of the initial element of K_n so that the correct section of the large array can be accessed when calculating each coefficient. So four arrays are needed in all – a large integer array storing the powers of the coefficients, a real array containing the overall factors and their respective initial position arrays. A real array is used for the overall factors as these rapidly grew too large to be representable as integers. The program to generate the K_n was checked to K_7 against the expressions given in [19].

5.3 The Scheme Invariants

Once the reversion coefficients have been calculated the scheme invariants may be found from (3.30);

$$-(n+1)K_{n+1} + \sum_{r=0}^n c_r \sum_{\sigma_i=n+2} K_{i_1} K_{i_2} \dots K_{i_{r+2}} - \sum_{i=1}^n i K_i \rho_{n+1-i} = 0, \quad (5.5)$$

where $i_k = \{1, 2, \dots, n+1\}$, $K_1 \equiv 1 \equiv c_0$, and $c_1 = c$. The notation $\sum_{\sigma_i=m}$ indicates that the sum is constrained by $i_1 + i_2 + \dots = m$. Again the most general method of generating them is required so that it is possible to reverse the process and find reversion coefficients, and hence series coefficients, in another scheme.

The last sum in (5.5) is simple to do, so it can be generated when ρ_n , or K_{n+1} is actually being evaluated. The same is true of the c_n term, as its coefficient is one. Hence it is only necessary to store the coefficients of the c_r , $r = 0, \dots, n-1$, ie $\sum_{\sigma_i=n+2} K_{i_1} K_{i_2} \dots K_{i_{r+2}}$, as they are not so trivial to generate. Since there

are at most $n + 1$ reversion coefficients plus an overall factor in any term that is stored, the array is $(n + 2) \times m$, where m is the number of terms that contribute. The first $r + 2$ columns hold the subscripts of the reversion coefficients and the $n + 2^{\text{nd}}$ column holds the factor which takes into account all permutations of these coefficients. Since patterns occur, as in the calculation of the K_n , once the arrays for low n have been calculated they can be used in calculating arrays for higher n . For historical reasons the first term, $-(n + 1)K_{n+1}$, is also stored.

For a general c_r in the expression for ρ_n or K_{n+1} , finding the coefficient is just the problem of finding all combinations of $r + 2$ numbers chosen from $\{1, 2, \dots, n + 1\}$ with repetition, such that their sum is $n + 2$. By choosing the first number, k , the problem reduces to finding all combinations of $r + 1$ chosen from $\{1, 2, \dots, k\}$ with repetition, such that their sum is $n - k + 2$. This problem has already been solved for ρ_{n-k} , so k is stored in the first column, and the relevant terms from ρ_{n-k} are stored in the next r columns. The next k is chosen and the process repeated until $k = n - r + 1$. At this point all possible combinations have been found. Take as an example, the coefficient of c_1 in ρ_5 . If $k = 1$ or 2 , there is no way of choosing two numbers from $\{1, \dots, k\}$ such that the sum of all three numbers is seven. For $k = 3$, there are two ways of choosing two numbers from $\{1, 2, 3\}$ such that the sum is seven. These two ways are the terms which form the coefficient of c_0 in the expression for ρ_2 . For $k = 4$, there is one combination which is the coefficient of c_0 in ρ_1 . If $k = n - r + 1$, corresponding to $k = 5$ in this example, the other $r + 1$ numbers must be one. So the four rows in the $7 \times m$ array for ρ_5 which are used to form the coefficient of c_1 , are

$$\begin{array}{ccccccc}
 3 & 2 & 2 & 0 & 0 & 0 & 3 \\
 3 & 3 & 1 & 0 & 0 & 0 & 3 \\
 4 & 2 & 1 & 0 & 0 & 0 & 6 \\
 5 & 1 & 1 & 0 & 0 & 0 & 3
 \end{array} \tag{5.6}$$

where the last column is the overall factor to take into consideration all permutations. These rows are used to generate the term

$$(3K_3K_2^2 + 3K_3^2K_1 + 6K_4K_2K_1 + 3K_5K_1^2) c. \tag{5.7}$$

To construct ρ_n from an array, each c_r term is constructed as in the above

example, and $c_n - \sum_{i=1}^{n-1} iK_i\rho_{n+1-i}$ is added to the sum of these terms. Constructing K_{n+1} is only slightly more tricky, as K_{n+1} occurs twice – the first term and as one of the terms in the coefficient of c_0 . This term is always of the form $2K_{n+1}$, so the overall factor of K_{n+1} is $(n-1)$. Again the c_r terms are constructed, but this time $c_n - \sum_{i=1}^n iK_i\rho_{n+1-i}$ is added to their sum. The total is then divided by $(n-1)$ to yield K_{n+1} .

As in the previous case, it proved necessary to store these two-dimensional arrays in a large one-dimensional array with a bookkeeping array to mark the first element of the “sub-arrays”. To test the routine, explicit expressions for the first eight ρ_n in terms of the series coefficients were found from Dhar’s method [16]. These were found using SMP – the Symbolic Manipulation Program – which created a FORTRAN file of the expressions for the ρ_i .

5.4 The Effective Charge Scheme

The EC scheme is particularly simple, as it requires only the scheme invariants as the β -function coefficients. These are used to solve the transcendental equation (3.11) for the couplant a , where $\tau_n = \rho_0$. A simple binary search method is used to find the solution. The right hand side is evaluated using a guess for the couplant. This value of the right hand side is compared with the known value of ρ_0 , and the couplant adjusted accordingly. This process is repeated until the difference between the value of the right hand side and ρ_0 is less than some specified tolerance. The value of the couplant that satisfies the equation is the value of the EC approximant to the physical quantity at this order.

For $\tau_2 = \frac{1}{a} + c \ln\left(\frac{ca}{1+ca}\right)$ there is always a solution, but for higher orders it is possible that a pole in the integrand occurs before a solution is found. In this case there is no solution to the integrated β -function equation, and $R^{(n)}(\text{EC})$ is undefined at this order.

5.5 The Pennington-Wrigley Approximation

Because the $r_k^{(n)}$ in this approximation depend on the $c_k^{(n)}$, it is possible to find expressions for $c_k^{(n)\text{PW}}$ in terms of ρ_j , $j = 1, \dots, k$ and the $r_i^{(n)}$, $i =$

$1, \dots, k-1$:

$$c_k^{(n)} = \frac{\rho_k}{1 + \binom{k-1}{k+1} \binom{n-1-2k}{n-1}} + f(\rho_i, r_i^{(n)}), \quad i = 1, \dots, k-1, \quad (5.8)$$

where n is the order to which the calculation is being made. Since $c_1 \equiv c$ is a scheme invariant, $r_1^{(n)}$ is known from (3.36), and so an iterative procedure can be used: $r_1^{(n)}$, c and ρ_2 are all known, so they can be used to calculate $c_2^{(n)}$, which from (3.36) immediately gives $r_2^{(n)}$. This in turn can be used to generate $c_3^{(n)}$, and so on up to $c_n^{(n)}$ and $r_n^{(n)}$. The couplant is found by solving the transcendental equation (3.11), as in the EC case, with τ_n given by (3.37). $R^{(n)}(\text{PW})$ can now be calculated. Again if a pole in the integrand in (3.11) occurs before a solution is found, then the equation has no solution for this set of β -function coefficients, and $R^{(n)}(\text{PW})$ is undefined in this order.

5.6 The $\widetilde{\text{PMS}}$ Scheme

The β -function coefficients in this scheme, with the exception of c , the scheme invariant, are all set to zero. The unknown to be found at each order is $\bar{\tau}$, the solution of

$$\left. \frac{dR^{(n)}}{d\tau} \right|_{\tau=\bar{\tau}} = 0. \quad (5.9)$$

By setting all the higher β -function coefficients, c_j , $j \geq 2$, equal to zero in (3.33), the dependence of the series coefficients on τ is found to be,

$$\frac{dr_k}{d\tau} = kr_{k-1} + c(k-1)r_{k-2}. \quad (5.10)$$

The solution of this equation can be written as a power series in τ

$$r_k = \sum_{m=0}^k \gamma_m^k (\tau - \tau_0)^m. \quad (5.11)$$

Substituting into (5.10) gives a recursive solution for the γ_m^k :

$$\begin{aligned} \gamma_m^k &= \frac{1}{m} \left(k\gamma_{m-1}^{k-1} + c(k-1)\gamma_{m-1}^{k-2} \right) & 1 < m < k \\ \gamma_k^k &= \gamma_{k-1}^{k-1} = 1. \end{aligned} \quad (5.12)$$

γ_0^k is the constant of integration from (5.10), with $r_k(\tau_0) = \gamma_0^k$. With this definition it is possible to work backwards from the scheme invariants to calculate

reversion coefficients with $c_i = 0$, $i \geq 2$, choosing $\tau_0 = 0$. The $r_i(0)$ are found from the $K_i(0)$, and (5.11) is used to find r_k for general τ .

The $\widetilde{\text{PMS}}$ condition, found from (3.35a),

$$a^{n+1} \left(r_{n-1}(1 + ca) + \frac{n-1}{n} cr_{n-2} \right) = 0, \quad (5.13)$$

can now be solved. To avoid solving a transcendental equation each time τ is changed, the above equation is solved for a , and the associated τ is found by evaluating (3.11) for this a and for $n = 2$. If (5.13) does not have a solution, the a that minimizes this condition is used. This corresponds to minimizing $\frac{dR^{(n)}}{d\tau}$, that is to finding a zero of the second derivative. If the second derivative does not have a zero, $R^{(n)}(\widetilde{\text{PMS}})$ is considered to be undefined.

5.7 The Principle of Minimal Sensitivity

The preceding schemes were straightforward in comparison with full PMS with its $n - 1$ non-linear simultaneous equations at order n . The solution of the PMS conditions (3.35) has proved to be difficult for $n > 3$. As in $\widetilde{\text{PMS}}$, the couplant was used instead of τ to avoid solving the integrated β -function equation each time one of the parameters was changed.

The initial method used the CERNLIB minimizing program MINUIT. The PW β -function coefficients and associated couplant were used as an initial guess. The series coefficients for this set of parameters were calculated, and the left hand sides of (3.35) were evaluated. MINUIT took the sum of the squares of these functions, and changed the parameters to minimize this number. This worked reasonably well up to third order, but became rapidly more unreliable as n increased. It was felt that this was partly due to the flatness of the $(n - 1)$ -dimensional surface that is $R^{(n)}(\tau, c_2, \dots, c_{n-1})$. $R^{(n)}$ appears to vary fairly rapidly with τ and c_2 , but has increasingly less dependence on the higher c_i . This is noticeable from as early as c_3 . This means that large changes in c_i result in very small changes in $R^{(n)}$, to the confusion of MINUIT. It would manage to reduce the contribution from (3.35b) for large j , to negligible amounts, but the contributions from (3.35a) and (3.35b) for small j , were still substantial, indicating that the parameters on which $R^{(n)}$ most heavily depended were nowhere near their PMS values.

A further problem was due to the singularity in the sum of the squares of (3.35), arising from a pole in the integrands of (3.35b). This occurred quite close to the solution in the orders at which this function could be investigated graphically, and presumably in all orders. Various penalty functions to keep MINUIT away from this point were tried. However, if they were strong enough to work correctly, they had the undesirable effect of shifting the position of the minimum. If they didn't affect the minimum, they weren't able to act as penalty functions. So the attempt to solve (3.35) using MINUIT was abandoned.

A second method fared even worse. The conditions (3.35a) and (3.35b), $j = 2, \dots, n - 2$, were rewritten with the c_i as the subject of the equations. For example, (3.35a) becomes

$$a^{n+1} \sum_{k=0}^{n-1} a^k \sum_{m=k}^{n-1} (m+1)r_m c_{n+k-m-1} = \sum_{k=0}^{n-1} c_k \sum_{m=n-k-1}^{n-1} (m+1)r_m a^{n+k-m-1}. \quad (5.14)$$

By assuming the coefficients are independent of the c_i , which is patently not the case, the coefficients could be written as a lower triangular matrix. Using a guess for a , the matrix was evaluated, and simple substitution produced a set of c_i . These in turn were used to find a new value for the couplant from the unused equation (3.35b), $j = n - 1$. The procedure was repeated until the change in the couplant and the β -function coefficients was smaller than some tolerance. The method was tried for $n = 3$, the lowest order possible for this method. If the solution was at the bottom of a well the method would have converged remarkably swiftly, as successive iterations followed the line of steepest descent. However, the solution is a saddle-point, which means that unless the initial guess was actually the solution, successive iterations move away from the solution at an ever increasing rate. It seemed pointless to investigate higher orders as the solution lies at a saddle point of at least two of the parameters.

For the calculation of the PMS approximants to the physical quantities, the $R_{e^+e^-}$ ratio in e^+e^- annihilation and τ decay in QCD and the anomalous magnetic moment of the electron in QED, to be discussed in chapters six and seven, a NAGLIB routine was used to minimize the sum of the squares of (3.35).

As it was only required to work to third order, where only two equations form the PMS condition, it worked well.

6 Calculations in QCD ...

6.1 Introduction

In QED, perturbation theory works very well. For example, the anomalous magnetic moment of the electron can be measured to high accuracy and theoretical predictions agree with experiment to one part in 10^7 . However, QCD perturbation theory is far less satisfactory, with more marked scheme dependence and less impressive convergence, both due in part to the fact that typical values of the QCD couplant are much larger than their QED counterparts, $\alpha_s \sim 0.2$ to $\alpha \sim 1/137$. Furthermore, the information available on higher order corrections is limited due to the sheer technical difficulty of evaluating diagrams in QCD.

Over and beyond these problems is the fact that quarks and gluons, the bare field quanta of QCD, are not the asymptotic states of the theory. Due to the nature of the QCD coupling, free quarks and gluons are not seen because they are bound into hadrons, the experimentally observed final states in strong interaction processes. It is possible to make predictions for jet production cross-sections, but these involve non-perturbative effects from the parton \rightarrow hadron transition, which must be modelled using fragmentation packages. Experimentally it is hard to define precisely what is meant by “a jet”, so such quantities can not be measured to more than 50% accuracy. So the success of lowest order QCD, since higher corrections are mostly uncalculated, is that it can describe angular distributions of jets, its predictions of cross-sections have roughly the right size, and fitted values of $\Lambda_{\overline{\text{MS}}}$ are fairly consistent between processes.

Yet another difficulty arises in proton-proton or proton-antiproton collisions. In order to say anything about the cross-sections of jets with a large component of momentum transverse to the collision axis, it is necessary to define the initial state parton distributions in the hadrons. The parton distributions factorize from the hard scattering cross-section, which is calculable in perturbative QCD, but this requires choosing a factorization scale, M , as well as having to choose the renormalization scale, μ , for the hard scattering process. This choice of M further complicates the scheme dependence problem.

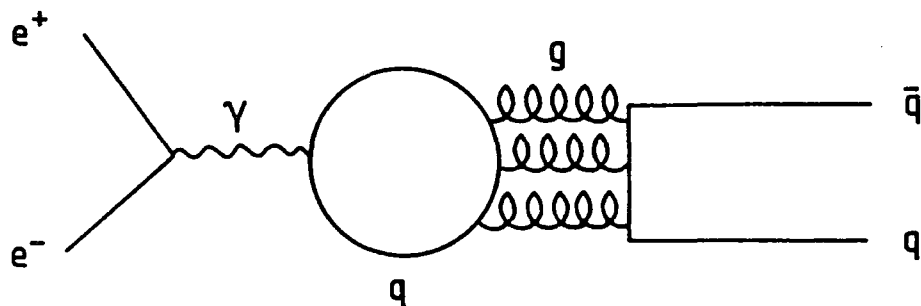

Figure 6.1 Diagrams of this type give rise to the $(\sum Q_f)^2$ term in the calculation of the coefficient of the three loop contribution to $R_{e^+e^-}$.

6.2 The $R_{e^+e^-}$ Ratio

One process, however, has long been thought the ideal testing ground of perturbative QCD, as it is free of many of the above complications. The cross-section for e^+e^- annihilation to produce hadrons, $\sigma(e^+e^- \rightarrow \text{hadrons})$, is an inclusive cross-section, removing the need to define jets. Unitarity should mean that a parton level calculation is quite adequate since the partons turn into hadrons with unit probability. The ratio, see §1.1,

$$R_{e^+e^-} = \frac{\sigma(e^+e^- \rightarrow \text{hadrons})}{\sigma(e^+e^- \rightarrow \mu^+\mu^-)}, \quad (6.1)$$

where the denominator is the zeroth order result, can be reliably measured at e^+e^- colliders. This has perturbative expansion

$$R_{e^+e^-} = N_c \sum Q_f^2 (1 + r_1 a + r_2 a^2 + \dots), \quad (6.2)$$

where N_c is the number of colours and the sum is over the square of the charges of the quark flavours. In $\overline{\text{MS}}$ for five flavours and $\mu = \sqrt{s} = 34$ GeV, the two loop coefficient is

$$\begin{aligned} r_1^{\overline{\text{MS}}} &= (1.986 - 0.115N_f) \\ &= 1.411 \quad \text{for } N_f = 5, \end{aligned} \quad (6.3)$$

where N_f is the number of flavours. From this it appeared that perturbative corrections were under control.



The attractiveness of using this as a test of perturbative QCD diminished somewhat when Gorishny, Kataev and Larin [28] announced the result of their calculation of the $O(a^3)$ correction to $R_{e^+e^-}$ – the first next-to-next-to-leading order calculation in QCD. Gorishny *et al* found the third order coefficient of $R_{e^+e^-}$ in $\overline{\text{MS}}$ to be

$$\begin{aligned} r_2^{\overline{\text{MS}}} &= (70.985 - 1.2N_f - 0.005N_f^2) - 1.679 \frac{(\sum Q_f)^2}{3 \sum Q_f^2} \\ &= 64.809 \quad \text{for } N_f = 5, \end{aligned} \tag{6.4}$$

for $\sqrt{s} = 34$ GeV. The term proportional to $(\sum Q_f)^2$ arises from diagrams that are similar to those that contribute to ϵ decay. These diagrams involve a quark loop and three exchanged gluons such that the final quark flavour is uncorrelated with that of the loop, see figure 6.1.

The calculations presented in this chapter which use this expression, were completed before an independent calculation could confirm the expression for $r_2^{\overline{\text{MS}}}$. Some of the contributions to this quantity have now been independently calculated [29] and agree with the results presented in [28], but Kataev and Vardiashvili [22] have discovered an error in the contribution of one diagram in the three-loop result for the two-point function of scalar quark currents. This has been confirmed by the original collaboration and others [30], who are currently working to remedy this error, which affects $r_2^{\overline{\text{MS}}}$ and the four-loop QED β -function coefficient among other things.

Even for the classic QED $g = 2$ calculation it is possible to find a scheme in which the series looks horribly divergent at third order, and it could be argued that such is the case here: $\overline{\text{MS}}$ is just a calculational convenience, and in other schemes the coefficient may be smaller. However, in the QED example the associated scheme invariant is small, $\rho_2 = 1.15$, but for the QCD $R_{e^+e^-}$ ratio with five flavours, $\rho_2 = 64.5$. This large number indicates perhaps, that the large $\overline{\text{MS}}$ coefficient is due, not to a bad choice of RS, but to some intrinsic malady in the perturbation series itself.

The schemes discussed in chapter 3 have been used to find the $R_{e^+e^-}$ ratio [31]. Two values of $\tilde{\Lambda}_{\overline{\text{MS}}}$, see (3.6), were used. $R_{e^+e^-}(\sqrt{s} = 34 \text{ GeV})$ was calculated, so the number of active quark flavours is five. The predictions for

second and third order approximants of the R_{e+e-} ratio in various schemes, using $\tilde{\Lambda}_{\overline{\text{MS}}} = 100$ and 500 MeV, are given in table 6.1.

$\tilde{\Lambda}_{\overline{\text{MS}}}$	n	$\overline{\text{MS}}$	EC	PMS	$\widetilde{\text{PMS}}$
100	2	0.0402	0.0404	0.0404	0.0404
	3	0.0439	0.0454	0.0453	0.0412
500	2	0.0543	0.0549	0.0550	—
	3	0.0631	0.0704	0.0694	—

Table 6.1 The approximants of \tilde{R}_{e+e-} for the given RSs at second and third order for $\tilde{\Lambda}_{\overline{\text{MS}}} = 100, 500$ MeV.

n		PW	EC
2	τ	$\rho_0 - c/2$	ρ_0
	r_1	$-c/2$	0
3	τ	ρ_0	ρ_0
	c_2	$\frac{3}{2}\rho_2$	ρ_2
	r_1	0	0
	r_2	$-\frac{1}{2}\rho_2$	0

Table 6.2 The β -function and series coefficients at second and third order, showing the similarities between the EC and PW schemes.

The $\overline{\text{MS}}$, EC and PMS methods give 10-20% corrections to the $n = 2$ result for R , with the EC and PMS results very similar, as predicted by Pennington and Wrigley [2,3]. In deriving the PMS conditions from $\partial R/\partial c_j$, see §3.4, Stevenson [4] uses the integral expression for $\beta_j^{(n)}(a) = \partial a/\partial c_j$, see (3.12b), hence keeping an infinite number of orders. In the approximation found independently by Pennington and Wrigley, PW, the series expansion (3.12c) for $\beta_j^{(n)}(a)$ is used, and the resulting expansion is truncated, keeping only one order beyond the order of perturbation theory being studied. That is, only keeping terms of order α^{n+1} in n^{th} order perturbation theory. The result of this truncation is that the series

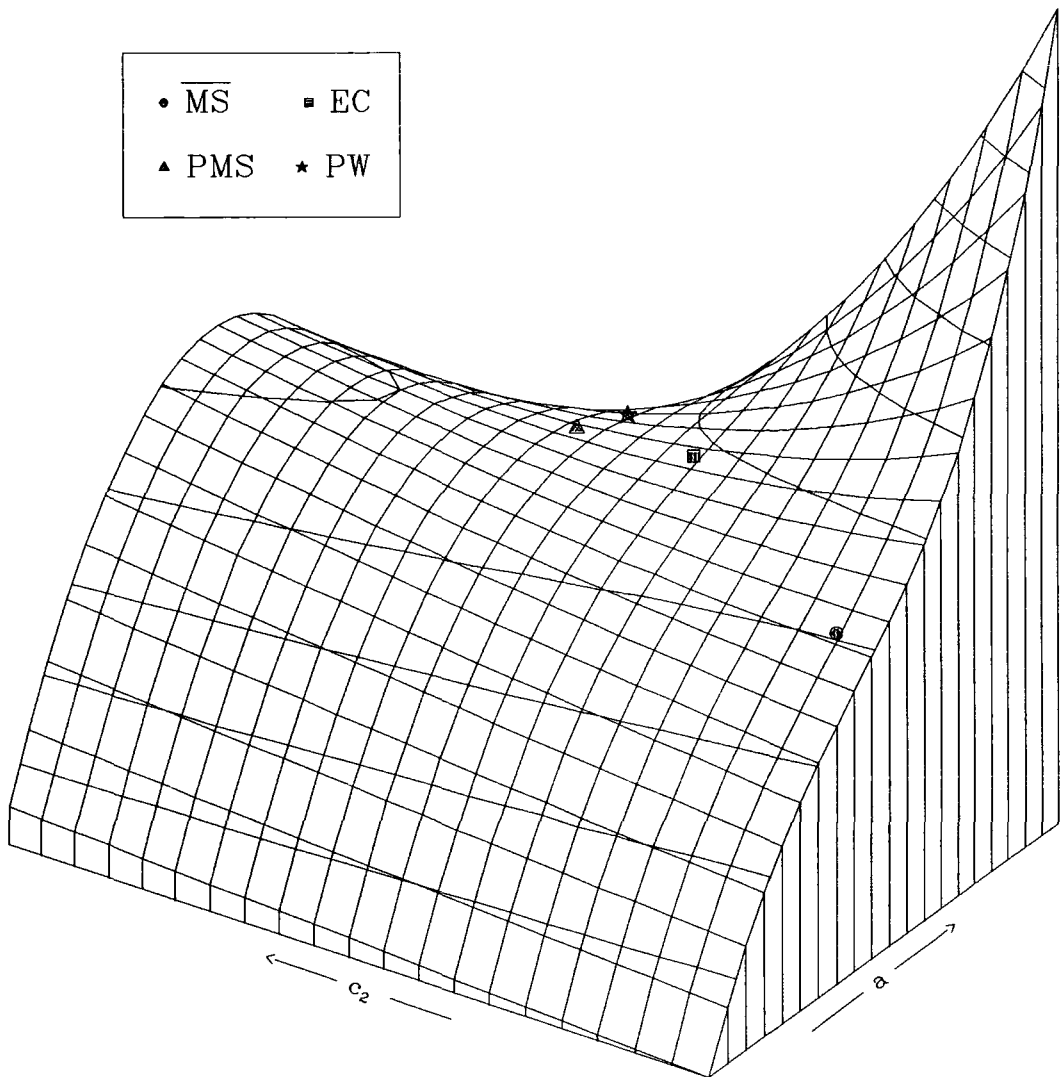

Figure 6.2 $\tilde{R}_{e^+e^-}^{(3)}$ as a function of the couplant, a , and the second β -function coefficient, c_2 with $0.02 \leq a \leq 0.07$ and $-10 \leq c_2 \leq 190$. The values predicted by PMS, EC, PW, and $\overline{\text{MS}}$ are marked. Note that there is no stationary point of inflexion along the $c_2 = 0$ line, corresponding to no solution to the PMS condition. The minimum value of $\tilde{R}_{e^+e^-}^{(3)}$ for this graph is 3.75×10^{-2} , and the maximum is 7.09×10^{-2} .

coefficients are proportional to the β -function coefficients for that order, see §3.5. As can be seen from table 6.2, if $\rho_0 \gg c$, the EC and PW, and hence the PMS, predictions will be similar.

The value for $\tilde{R}_{e^+e^-}^{(3)}(\overline{\text{PMS}})$ at $\tilde{\Lambda}_{\overline{\text{MS}}} = 100$ MeV is a smaller correction. However, for this value of $\tilde{\Lambda}_{\overline{\text{MS}}}$, $\rho_0 = 20.933$, and the $\overline{\text{PMS}}$ condition does not have a solution other than the trivial one $a = 0$. The value of the couplant used in this

calculation is the one which minimizes the $\widetilde{\text{PMS}}$ condition, ie the couplant which gives a zero in the second derivative of R with respect to a . In fact for $\rho_0 \lesssim 20$, even the second derivative has no zero, which is the case for $\tilde{\Lambda}_{\overline{\text{MS}}} = 500$ MeV. Hence there is no value for $\tilde{R}_{e^+e^-}^{(3)}(\widetilde{\text{PMS}})$ quoted in table 6.1. So $\widetilde{\text{PMS}}$ does not give a well-defined prediction for $R_{e^+e^-}$ at the energies considered here. Table 6.3 gives the couplant, the series coefficients and the β -function coefficients for each of the schemes. Figure 6.2 shows the surface of $R^{(3)}(a, c_2)$ with the PMS, EC and $\overline{\text{MS}}$ points indicated.

	n		$\overline{\text{MS}}$	EC	PMS	$\widetilde{\text{PMS}}$
$\tilde{\Lambda}_{\overline{\text{MS}}} = 100$ $\rho_0 = 20.933$	2	a	0.0381	0.0404	0.0415	0.0415
		r_1	1.411	0.	-0.5990	-0.5990
	3	a	0.0382	0.0454	0.0452	0.0301
		c_2	1.475	62.51	95.57	0.
		r_1	1.411	0.	1.363	8.120
		r_2	64.81	0.	-29.48	138.7
$\tilde{\Lambda}_{\overline{\text{MS}}} = 500$ $\rho_0 = 14.764$	2	a	0.0507	0.0549	0.0569	0.0569
		r_1	1.411	0.	-0.5882	-0.5882
	3	a	0.0509	0.0704	0.0690	-
		c_2	1.475	62.51	96.56	-
		r_1	1.411	0.	1.988	-
		r_2	64.81	0.	-27.59	-

Table 6.3 The values of the couplant, β -function coefficient, c_2 , and the series coefficients for the given RSs at second and third orders for $\tilde{\Lambda}_{\overline{\text{MS}}} = 100, 500$ MeV.

Finally, $\tilde{R}_{e^+e^-}^{(n)}$ in each scheme was fitted to data to find the corresponding value of $\Lambda_{\overline{\text{MS}}}$. Marshall has combined PEP/PETRA data to yield a value of $\alpha_s = 0.135 \pm 0.016$ [32] in the $\overline{\text{MS}}$ scheme with $\mu^2 = s = 1000 \text{ GeV}^2$. Hence $\tilde{R}_{exp} = 0.051 \pm 0.007$. The results given in table 6.4 are for the conventional definition of $\Lambda_{\overline{\text{MS}}}$, corrected from the fitted $\tilde{\Lambda}_{\overline{\text{MS}}}$ using (3.6). The $\Lambda_{\overline{\text{MS}}}$ estimate at $n = 2$ is halved by including the $O(\alpha_s^3)$ corections. There is reasonable

consistency between the schemes at each order of perturbation theory.

n	$\overline{\text{MS}}$	EC	PMS
2	+238	+226	+224
	301	288	287
	-162	-102	-153
3	+124	+87	+90
	170	137	139
	-89	-67	-69

Table 6.4 $\Lambda_{\overline{\text{MS}}}$, in MeV, found from fitting $\tilde{R}_{e^+e^-}^{(n)}$ to the Marshall value of α_s .

6.3 Speculations on the High Order Behaviour of the e^+e^- Series Coefficients

While nothing is known of the high order behaviour of the series coefficients in QCD at present, it is possible to speculate on their structure. This gives rise to the possibility of testing some of the claims made in chapter 4 about the limits of approximants calculated in various schemes. By using the first two series coefficients in the zero scheme series, found from their $\overline{\text{MS}}$ counterparts, (6.3) and (6.4), via the scheme invariants (3.21), various series can be constructed. That is, r_1^{ZS} and r_2^{ZS} can be considered to be the first two coefficients of a geometric series, or an arithmetic series, etc. For the sake of curiosity, two such series will be considered here.

The first is almost a geometric series – almost because the coefficients have a common factor, i.e.

$$r_k^{\text{ZS}} = \lambda x^k, \quad (6.5)$$

where $\tau_0 = 10.933$, $\lambda = 0.667$ and $x = -14.991$. These numbers apply for $\sqrt{s} = 34\text{GeV}$, $\tilde{\Lambda}_{\overline{\text{MS}}} = 100$ MeV and five flavours. This series can be summed to give

$$\begin{aligned} R &= a(\tau_0) \left(1 + r_1^{\text{ZS}} a(\tau_0) + r_2^{\text{ZS}} a(\tau_0) + \dots \right) \\ &= a(\tau_0) \left(1 + \frac{\lambda x a(\tau_0)}{1 - x a(\tau_0)} \right) \\ &= 0.04658. \end{aligned} \quad (6.6)$$

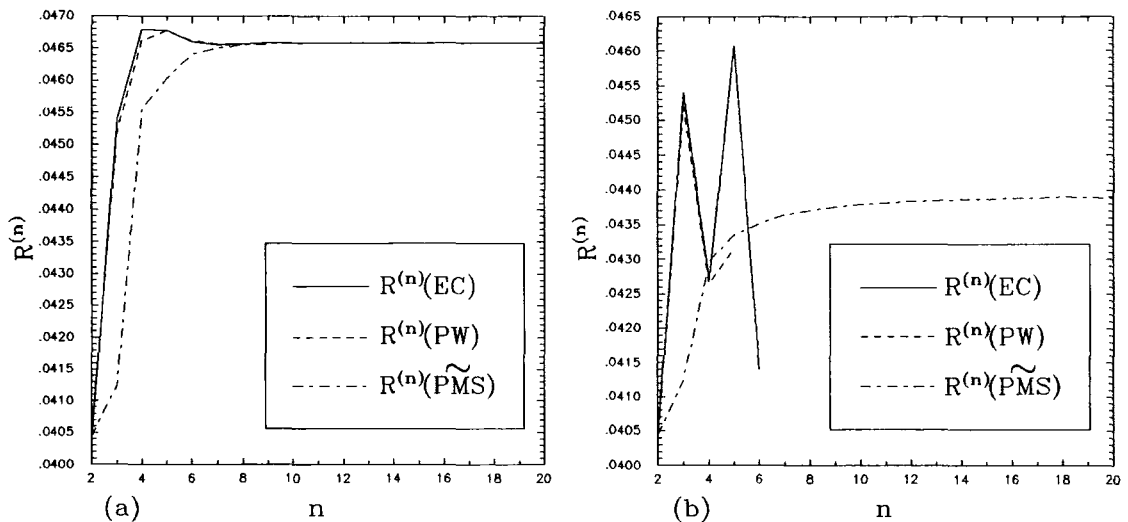

Figure 6.3 “ $\tilde{R}_{e^+e^-}$ ” as a function of n for three RS’s. Curves in figure (a) are calculated assuming the ZS series coefficients at $\tau = \tau_0$ have geometric growth, and in figure (b) it is assumed that at $\tau = \tau_0$ they grow as $(-7.301)^k k!$.

As can be seen from figure 6.3a, not surprisingly the approximants in the PW, EC and $\widetilde{\text{PMS}}$ schemes rapidly converge to the required limit.

On the other hand, assuming r_1^{ZS} and r_2^{ZS} form the first two coefficients of a series with alternating factorial growth produces more interesting results. With $\tau_0 = 13.632$ and $x = 7.301$ for $\mu = \sqrt{s} = 34\text{GeV}$, $\tilde{\Lambda}_{\overline{\text{MS}}} = 100\text{ MeV}$ and five flavours, the $r_k^{\text{ZS}}(\tau_0)$ are

$$r_k^{\text{ZS}}(\tau_0) = (-x)^k k!. \quad (6.7)$$

From figure 6.3b it can be seen that $R^{(n)}(\widetilde{\text{PMS}})$ is obviously converging, but both the EC and PW approximants oscillate for the first few orders before becoming undefined in the sixth and seventh orders respectively. At these orders, the truncated β -function equation, (3.11), no longer has a solution, supporting the argument in §4.4, although it is perhaps surprising that this occurs at such low n . For the $r_k(\tau_0)$ given above, the Borel transform is

$$F_B(u, \tau_0) = \frac{1}{1 + xu}, \quad (6.8)$$

and the truncated Borel sum is

$$\int_0^{\frac{1}{x_0}} du \frac{e^{-\frac{u}{\alpha_0}}}{1 + xu} = 0.4397, \quad (6.9)$$

again supporting claims made in §4.8.

6.4 τ Decay

For the decay of a heavy lepton it is possible to define an analogue of the R ratio of e^+e^- annihilation,

$$R_\tau \equiv \frac{\Gamma(\tau^- \rightarrow \nu_\tau + \text{hadrons})}{\Gamma(\tau^- \rightarrow \nu_\tau e^- \bar{\nu}_e)}. \quad (6.10)$$

If the numerator is approximated by decays into $d\bar{u}$ and $s\bar{u}$, the zeroth order estimate [33] is $R_\tau \simeq N_c = 3$, where N_c is the number of colours, analogous to the zeroth order result for the e^+e^- ratio: $R_{e^+e^-} = N_c \sum Q_f^2$.

Experimentally the R_τ ratio is found from the branching fraction of τ into electrons, B_e . The branching fraction of τ into muons is $0.973B_e$, and so R_τ is

$$R_\tau = \frac{1 - 1.973B_e}{B_e}. \quad (6.11)$$

B_e can be measured in two different ways: directly, and indirectly by measuring the lifetime of the τ . Direct measurements give $R_\tau = 3.71 \pm 0.13$, whilst the indirect method yields $R_\tau = 3.32 \pm 0.16$. A reliable perturbation calculation might indicate which of the two experimental values is to be believed, and it has recently been argued that this is possible, [34-36].

Contributions to R_τ come from three sources; non-perturbative and perturbative QCD, and electro-weak processes. A phase-space factor suppresses the time-like contribution to the W self-energy function, and allows a sensible operator product expansion. Electro-weak corrections are predicted to give a +2.4% effect [37], and non-perturbative QCD corrections are negative and estimated [36] to be 1-3%. Hence the dominant corrections to $R_\tau \simeq 3$ should be of perturbative QCD origin.

In general, for any heavy lepton, a ratio such as (6.10) can be defined, and can be written as an integral over the invariant masses of the hadrons which are the decay products. This in turn can be written as a contour integral in the

complex s plane

$$R = \frac{1}{i\pi} \int_C \frac{ds}{M^2} \left(1 - \frac{s}{M^2}\right)^2 \left(\left(1 + 2\frac{s}{M^2}\right) \pi_T(s) - \pi_L(s) \right), \quad (6.12)$$

where the contour, C , runs clockwise around the circle of radius $|s| = M^2$, and M is the mass of the heavy lepton. π_T and π_L are the transverse and longitudinal components of the hadronic part of the W -boson self-energy function. The $\left(1 - \frac{s}{M^2}\right)^2$ factor suppresses the time-like contribution and, providing M^2 is sufficiently large, means that a reliable approximation to π_T can be made in perturbative QCD. π_L is ignored since perturbative corrections do not contribute to the longitudinal self-energy function.

Integrating (6.12) by parts yields

$$\begin{aligned} R &= \frac{1}{2\pi i} \int_C \frac{ds}{s} \left(1 - 2\frac{s}{M^2} + 2\frac{s^3}{M^6} - \frac{s^4}{M^8}\right) s \frac{d}{ds} \pi_T(s) \\ &= \frac{1}{2\pi} \int_{-\pi}^{\pi} d\theta \left(1 + 2e^{i\theta} - 2e^{3i\theta} - e^{4i\theta}\right) s \frac{d}{ds} \pi_T \left(s = -M^2 e^{i\theta}\right). \end{aligned} \quad (6.13)$$

$s \frac{d}{ds} \pi_T$ can be found from the function $D(s)$ used in the calculation of r_2 for $R_{e^+e^-}$ by Gorishny *et al* [28] by replacing $3 \sum Q_f^2$ by $3 \sum |V_{ff'}|^2$. $V_{ff'}$ is a Kobayashi-Maskawa matrix element, and the sum is over pairs of quarks light enough to be produced by τ decay and which couple to the W -boson. The term involving $(\sum Q_f)^2$ is set to zero because the type of diagram that gives rise to these terms does not occur in τ decay. So

$$s \frac{d}{ds} \pi_T(s) = 3 \sum |V_{ff'}|^2 \left(1 + \frac{\alpha_s(-s)}{\pi} + \kappa_1 \left(\frac{\alpha_s(-s)}{\pi}\right)^2 + \kappa_2 \left(\frac{\alpha_s(-s)}{\pi}\right)^3 + \dots\right) \quad (6.14)$$

where κ_1 and κ_2 are known from the Gorishny *et al* calculation, and $\alpha_s(-s)$ is the coupling constant in $\overline{\text{MS}}$ with renormalization point $\mu^2 = -s$. Braaten then expands $\alpha_s(-s)$ about the point $\theta = 0$ on the integration contour $s = -M^2 e^{i\theta}$, $-\pi < \theta < \pi$, which results in a power series expansion in terms of $\frac{\alpha_s(M^2)}{\pi}$, whose coefficients are finite power series in θ . A different expansion point could have been chosen, yielding a different series, but the two series are related, and would ultimately yield the same results. The expansion for $\frac{\alpha_s}{\pi}$ is substituted into the expression for the logarithmic derivative of π_T (6.14), which

in turn is substituted into (6.13). The integration over θ can be performed, and the result for τ decay, in $\overline{\text{MS}}$ with $\mu = m_\tau = 1784$ MeV, and for three flavours, is

$$R_\tau(s) = 3 \left(1 + \frac{\alpha_s}{\pi} + 5.20 \left(\frac{\alpha_s}{\pi} \right)^2 + 104.0 \left(\frac{\alpha_s}{\pi} \right)^3 + \dots \right). \quad (6.15)$$

Braaten feels that, together with the corrections from nonperturbative QCD and electro-weak effects mentioned above, this is as good a way of determining α_s and $\Lambda_{\overline{\text{MS}}}$ as any other, as it is in a region where α_s is not too small, and hence R_τ is sensitive to changes in $\Lambda_{\overline{\text{MS}}}$. However, in a recent paper, Pumplin [38] claims that non-perturbative effects are larger than previously thought – so large as to make any determination of $\Lambda_{\overline{\text{MS}}}$ unreliable. He claims that Braaten, in choosing his contour of integration, neglects a contribution from a pole in $s = -\Lambda^2$, and a branch cut for $-\Lambda < s < 0$. Other non-perturbative effects come from the threshold for hadron production at $s = 4m_\pi^2$ and from resonances, in particular the $\rho(770)$, $a_1(1260)$ and π . Ignoring any of these effects, which the perturbative calculation does, would incur serious errors and undermine any confidence in its reliability.

An investigation of the scheme dependence of \tilde{R}_τ , the associated quantity defined by

$$\tilde{R}_\tau = \frac{R_\tau - N_c}{N_c}, \quad (6.16)$$

shows further that the perturbative expansion is not reliable for a lepton with a mass as low as 1800 MeV, [39].

Normally, as said before, the theoretical prediction is fitted to data and a value for $\Lambda_{\overline{\text{MS}}}$ is extracted and compared with other predictions. However, if the value of a particular perturbatively calculable physical quantity is known, then any other perturbatively calculable physical quantity can be expanded in terms of this known quantity, yielding an absolute prediction of the theory for the second quantity. It will not explicitly involve the unknown $\Lambda_{\overline{\text{MS}}}$. The known value of the first quantity determines the mass scale of the theory, and further quantities can be predicted without mass scale ambiguity. The use of the fine structure constant as the expansion parameter in QED is an example of this. For QCD, if one physical quantity, R_1 , in some RS is fitted to the data, ie $R_1^{(n)}(RS) = R_1^{exp}$, a value for $\Lambda_{\overline{\text{MS}}}$ can be found and used to calculate another

physical quantity in the same RS, $R_2^{(n)}(RS)$ at that value of R_1 . Hence, R_2 can be plotted as a function of R_1 , and the value of $\Lambda_{\overline{\text{MS}}}$ is of secondary importance. These curves are absolute predictions of the theory for a given scheme, and at the order, in which they are calculated.

$\tilde{R}_{e^+e^-}(\sqrt{s} = 34\text{GeV})$ is taken to be the known physical quantity and the dependence of \tilde{R}_τ on this quantity will be investigated. Both have expansions in the $\overline{\text{MS}}$ RS, but in this scheme the Appelquist-Carazzone decoupling theorem [40] is not realized, as the β -function is independent of the quark masses. The decoupling theorem says that if the mass of a quark is greater than the characteristic energy of the process, then it decouples from each order of perturbation theory. In the momentum subtraction scheme, MOM, the β -function depends on the quark masses and hence decoupling occurs naturally, but in the $\overline{\text{MS}}$ scheme, and related schemes, this is not the case. Since the mass of the τ is such that only the three lightest quarks are involved in its decay, some method of removing the effects of the heavier quarks on the running coupling is needed. That is, the couplant must be replaced by an effective couplant. What is happening is that the scale parameter which characterizes the five flavour theory is replaced by another scale parameter which characterizes the three flavour theory. In all other respects the two theories are equivalent.

To decouple two quarks is the same as decoupling one quark to find a four flavour theory, and then repeating the procedure to yield a theory with three flavours. So consider just decoupling one quark, that is, replacing a_{MS} in the N_f flavour theory, by a_{MS}^- , where the superscript indicates the couplant of the theory with $N_f - 1$ flavours. Bernreuther and Wetzel [41] find a series expansion for a_{MS}^- in terms of a_{MS} by using the MOM RS as an intermediate step. a_{MOM} is written as a power series in a_{MS} :

$$a_{\text{MOM}} = a_{\text{MS}} + \sum_{k=1}^{\infty} B_k \left(\frac{m_{\text{MS}}^2}{\mu^2} \right) a_{\text{MS}}^{k+1}, \quad (6.17)$$

where m_{MS} is the running mass of the quark to be decoupled, calculated in the MS scheme at scale μ . Decoupling occurs in a_{MOM} in the limit when $\mu \ll m_{\text{MS}}$, m_{MOM} , and $B_k \rightarrow B_k^\infty + O\left(\frac{\mu}{m_{\text{MS}}}\right)$. This means all terms in the B_k which vanish in the limit $\mu/m_{\text{MS}} \rightarrow 0$ can be ignored. No trace remains of the heavy

quark, so $a_{\overline{\text{MS}}}^-$ can be expanded in terms of a_{MOM} :

$$a_{\overline{\text{MS}}}^- = a_{\text{MOM}} + \sum_{k=1}^{\infty} b_k a_{\text{MOM}}^{k+1}, \quad (6.18)$$

where the b_k are constants. Substituting for a_{MOM} gives

$$a_{\overline{\text{MS}}}^- = a_{\overline{\text{MS}}} + \sum_{k=1}^{\infty} C_k^{\text{MS}} \left(\ln \frac{m_{\overline{\text{MS}}}^2}{\mu^2} \right) a_{\overline{\text{MS}}}^{k+1}. \quad (6.19)$$

Using the fact that $a_{\overline{\text{MS}}}^-$, $a_{\overline{\text{MS}}}$ and $x \equiv \ln \left(\frac{m_{\overline{\text{MS}}}^2}{\mu^2} \right)$ satisfy renormalization group equations, constraints for the C_k^{MS} are found to be polynomials in x of degree k . However, if, as in this calculation, the renormalization point is taken to be the mass of the heavy quark, ie $\mu = m_{\overline{\text{MS}}}$, then only the constant terms remain. So the first two coefficients are found to be

$$\begin{aligned} C_1^{\text{MS}} &= \frac{1}{6} \left(\gamma_E - \ln(4\pi) + \frac{1}{2} \frac{\partial}{\partial d} \text{Tr} \mathbf{1} \Big|_{d=4} \right) \\ C_2^{\text{MS}} &= C_1^{\text{MS}^2} + \frac{1}{9} C_2(A) - \frac{17}{96} C_2(F) + \frac{1}{32} \frac{\partial}{\partial d} \text{Tr} \mathbf{1} \Big|_{d=4} \left(\frac{5}{3} C_2(A) + C_2(F) \right) \\ &\quad + \frac{1}{8} (\gamma_E - \ln(4\pi)) \left(\frac{5}{3} C_2(A) - C_2(F) \right), \end{aligned} \quad (6.20)$$

where d denotes the dimension of space-time, $C_2(A) = N$ and $C_2(F) = \frac{N^2-1}{2N}$ are the Casimirs of the gauge group $SU(N)$. Since $\frac{\partial}{\partial d} \text{Tr} \mathbf{1} \Big|_{d=4}$ can be chosen to be zero [42], and $\gamma_E - \ln(4\pi)$ are the constants which are removed in $\overline{\text{MS}}$, the scheme in which the three loop coefficient, r_2 , was calculated, these reduce to

$$\begin{aligned} C_1^{\overline{\text{MS}}} &= 0 \\ C_2^{\overline{\text{MS}}} &= \frac{1}{9} C_2(A) - \frac{17}{96} C_2(F) \\ &= \frac{7}{72} \quad \text{for } N = 3. \end{aligned} \quad (6.21)$$

Hence, to third order in $a_{\overline{\text{MS}}}$, $a_{\overline{\text{MS}}}^-$ is

$$a_{\overline{\text{MS}}}^- = a_{\overline{\text{MS}}} + \frac{7}{72} a_{\overline{\text{MS}}}^3. \quad (6.22)$$

In practice $\tilde{R}_{e^+e^-}^{(n)}$ in some RS at order n was fitted to data, using the five flavour values of c , c_2 and b , and with $\mu = 34$ GeV, and a value for $\tilde{\Lambda}_{\overline{\text{MS}}}^{(5)}$ was

extracted, where the superscript denotes the number of flavours. μ was reset to the mass of the bottom quark, taken to be $m_b = 4.2$ GeV, and a value for $a_{\overline{\text{MS}}}$ was found. At second order this was taken as the new value for $a_{\overline{\text{MS}}}^{(4)}$, but at third order this value was considered to be $a_{\overline{\text{MS}}}^{(5)}$, and $a_{\overline{\text{MS}}}^{(4)}$ was found from it by substitution into (6.22). c , c_2 and b were then evaluated for four flavours, and a new value of τ , ie $\tau_{\overline{\text{MS}}}^{(4)}$ and hence $\tilde{\Lambda}_{\overline{\text{MS}}}^{(4)}$, was evaluated. Again μ was reset to the charm quark mass, $m_c = 1.25$ GeV, and the procedure repeated to find $\tilde{\Lambda}_{\overline{\text{MS}}}^{(3)}$. $\tilde{R}_\tau^{(n)}$ was then evaluated in the RS first used to find $\tilde{R}_{e^+e^-}^{(n)}$, the RSs used being $\overline{\text{MS}}$ with $\mu = \sqrt{s}$ for $\tilde{R}_{e^+e^-}$ and $\mu = m_\tau$ for \tilde{R}_τ , EC, and PMS. In principle, the RS used to evaluate $\tilde{R}_\tau^{(n)}$ (RS) could be different from the RS used in fitting $\tilde{R}_{e^+e^-}$ (RS') = $\tilde{R}_{e^+e^-}^{exp}$, i.e. EC could be used to fit $\tilde{R}_{e^+e^-}^{(n)}$ to data and PMS to evaluate $\tilde{R}_\tau^{(n)}$. However, it turns out that only the RS used to find $\tilde{R}_\tau^{(n)}$ is important. As shown in table 6.4 the $\tilde{\Lambda}_{\overline{\text{MS}}}^{(5)}$ extracted from $\tilde{R}_{e^+e^-}^{(n)}$ is rather insensitive to RSs.

N_f		$m_b = 4.0$ GeV	$m_b = 4.5$ GeV	$m_b = 5.0$ GeV
		$m_c = 0.75$ GeV	$m_c = 1.25$ GeV	$m_c = 1.75$ GeV
3	$\tilde{\Lambda}_{\overline{\text{MS}}}$	0.2992	0.3204	0.3348
	a	0.0890	0.0920	0.0941
4	$\tilde{\Lambda}_{\overline{\text{MS}}}$	0.2755	0.2788	0.2818
	a	0.0932	0.0937	0.0941

Table 6.5 The scale parameter, $\tilde{\Lambda}_{\overline{\text{MS}}}$, for three and four flavours, and the correspondig couplant at $q = m_\tau$, for three combinations of the charm and bottom masses.

The dependence of $a_{\overline{\text{MS}}}$ on the masses of the bottom and charm quarks was investigated using a range of values, but as can be seen from Figure 6.4 and table 6.5, they have little effect. The three curves in Figure 6.4 show $a_{\overline{\text{MS}}}$ as a function of momentum, q , for the three combinations of masses; i) $m_b = 5.0$ GeV, $m_c = 1.75$ GeV ii) $m_b = 4.5$ GeV, $m_c = 1.25$ GeV iii) $m_b = 4.0$ GeV, $m_c = 0.75$ GeV, with $\tilde{\Lambda}_{\overline{\text{MS}}}^{(5)} = 0.2$ GeV, as this $\tilde{\Lambda}_{\overline{\text{MS}}}$ yields the central value of the Marshall fit for $\tilde{R}_{e^+e^-}^{(3)}$ at $s = 1000\text{GeV}^2$. It is not until $q < 1.0$ GeV that significant differences appear. It may seem strange that the charm quark

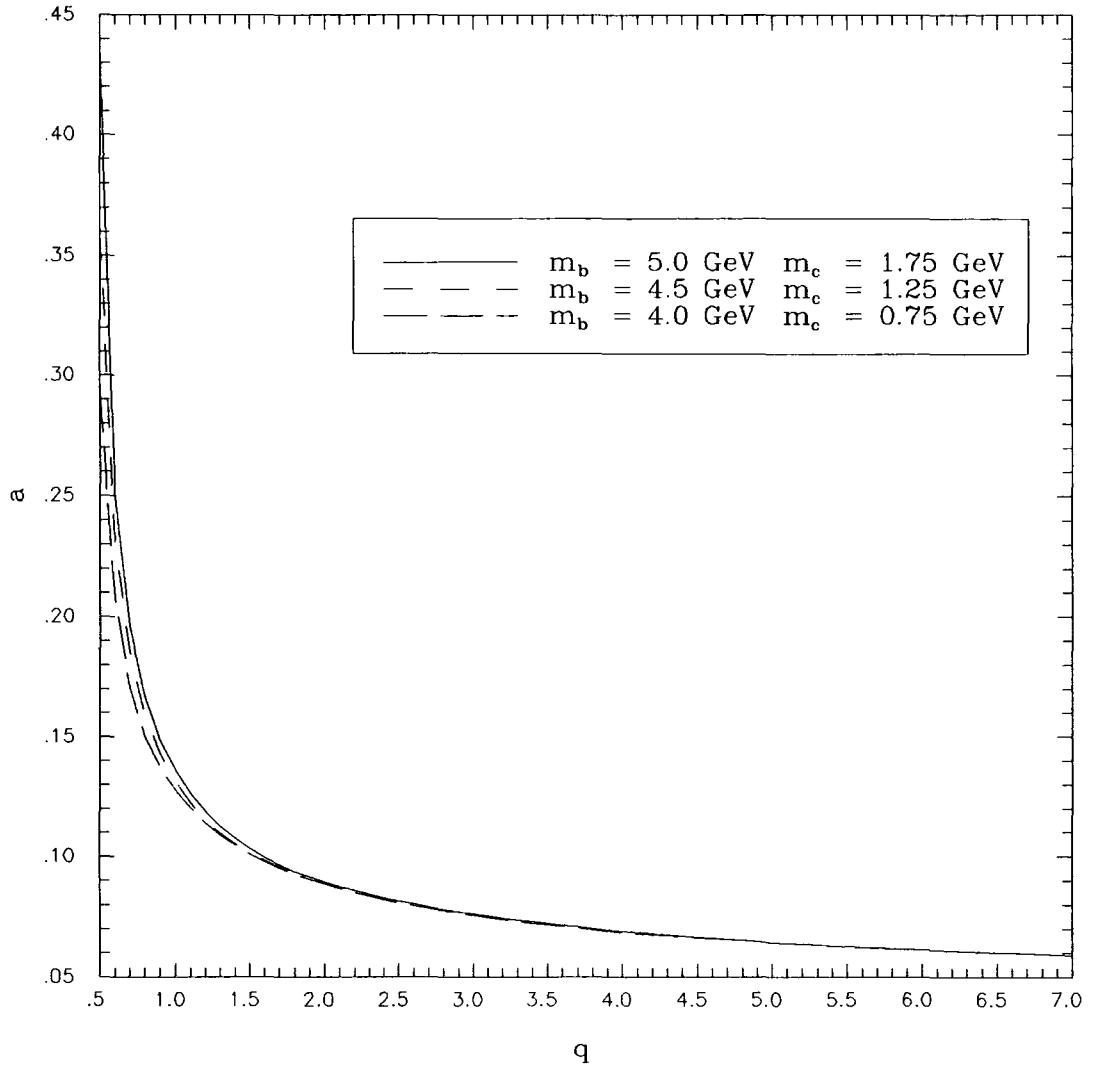

Figure 6.4 The couplant, a , as a function of momentum, q , for three combinations of the mass of the charm and bottom quarks, with $\tilde{\Lambda}_{\overline{\text{MS}}}^{(5)} = 0.2 \text{ GeV}$, as this $\tilde{\Lambda}_{\overline{\text{MS}}}$ yields the central value of the Marshall fit for $\tilde{R}_{e^+e^-}^{(3)}$ at $s = 1000 \text{ GeV}^2$.

is decoupled even though its mass is less than that of the τ . However, there exists no charmed meson with mass less than that of the τ , so this channel is not open to τ decay. Hence the charm quark is decoupled from this process. Table 6.5 shows the value of the couplant at $q = m_\tau$ for various scale parameters, showing that the exact values of the masses of the charm and bottom quarks are relatively unimportant. The bottom section shows the scale parameter and couplant for four flavours, showing that there is little difference in using three or four flavours when calculating the couplant at the mass of the τ .

The graphs of $\tilde{R}_\tau^{(2)}$ vs $\tilde{R}_{e^+e^-}^{(2)}$ and $\tilde{R}_\tau^{(3)}$ vs $\tilde{R}_{e^+e^-}^{(3)}$ are given in Figures 6.5

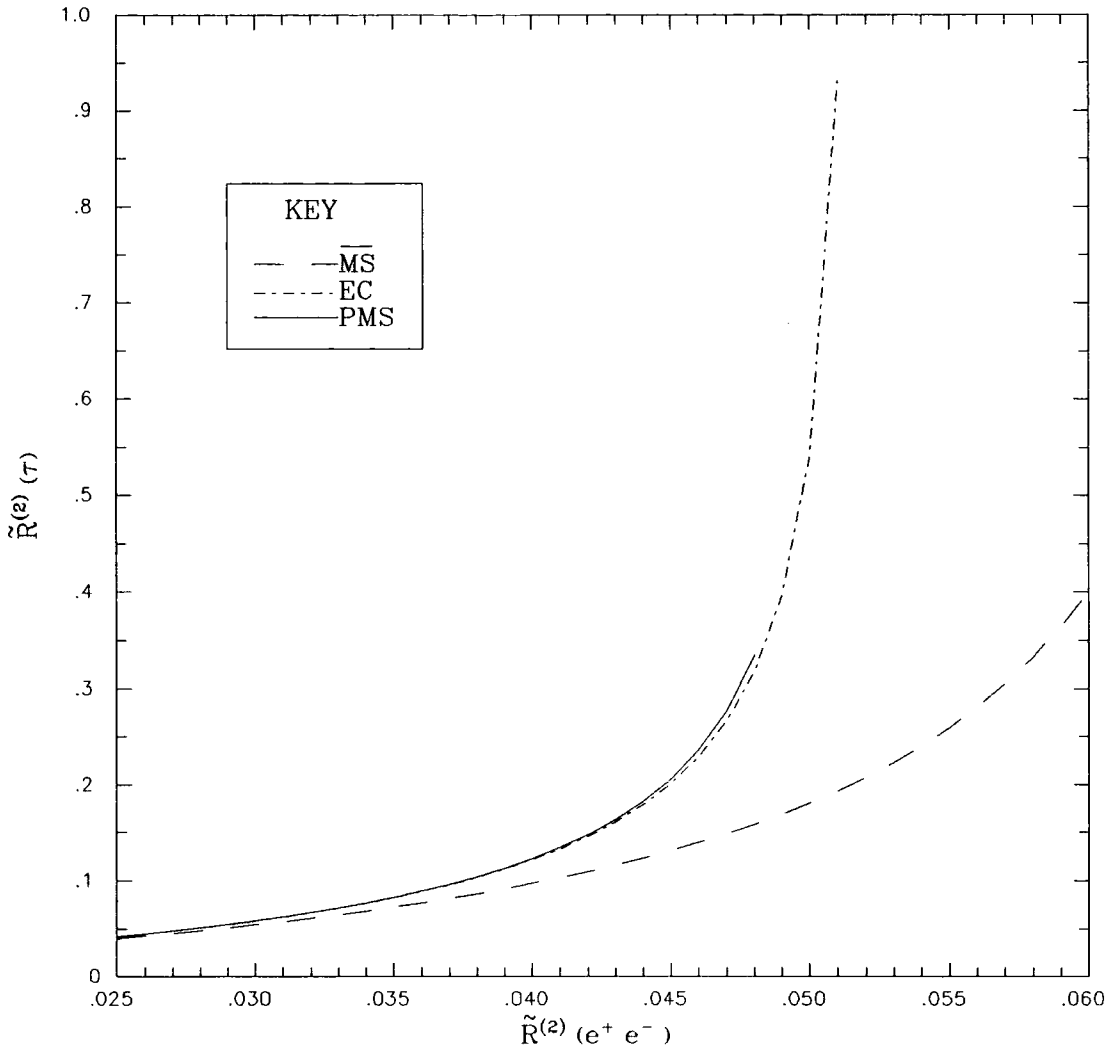

Figure 6.5 \tilde{R}_τ vs $\tilde{R}_{e^+e^-}$ at second order for three RS's.

and 6.6. The Marshall fit to e^+e^- annihilation data gives $\tilde{R}_{e^+e^-} = 0.051 \pm 0.007$ [32]. At second order the EC and PMS approximants become undefined just before the central value of the data, but at third order both approximants become undefined well below the region of interest. At second order the PMS approximant becomes undefined when $\rho_0 = 0$. At third order, as $\rho_0 \rightarrow 0$, the saddle-point defining the PMS approximant moves off to infinity, taking with it the flat region on the surface of $\tilde{R}_\tau^{(3)}$. For perturbation theory to be believable the values predicted by the various schemes should lie in a fairly flat region, and as can be seen from Figures 6.7 and 6.8, this is not the case. Figure 6.7 shows the variation of $\tilde{R}_\tau^{(2)}$ with the couplant, at $\tilde{R}_{e^+e^-}^{(2)} = 0.051$, the central value of the Marshall fit. $\tilde{R}_\tau^{(2)}(\overline{\text{MS}})$ is marked, and the couplant corresponds to choosing as the renormalization point, $\mu = m_\tau$. If other, supposedly reasonable, choices

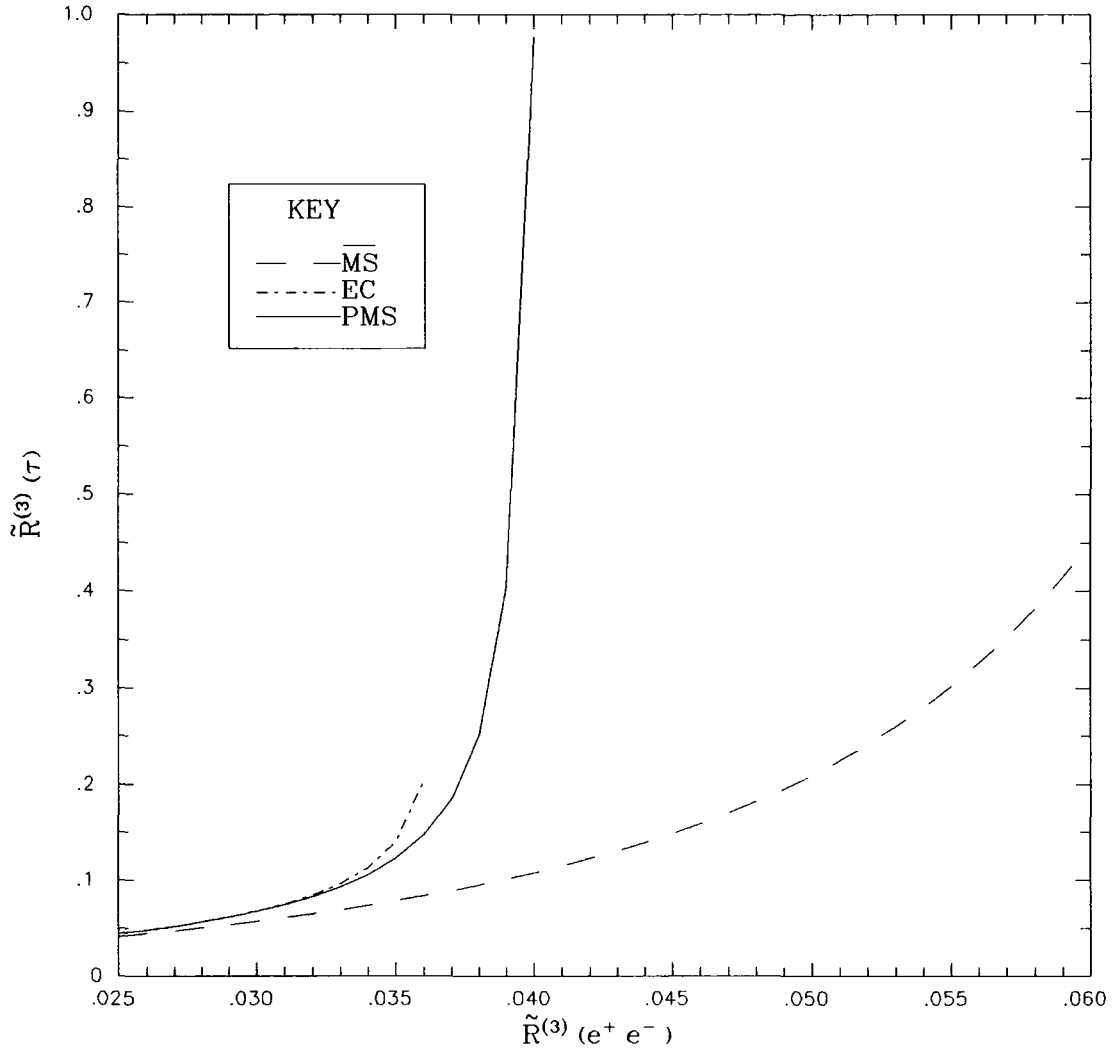

Figure 6.6 \tilde{R}_τ vs $\tilde{R}_{e^+e^-}$ at third order for three RS's.

of μ are made, such as $0.5m_\tau$ and $2m_\tau$, then a more concrete idea of the scheme dependence can be found, see table 6.6.

$\frac{\mu}{m_\tau}$	a	$\tilde{R}_\tau^{(2)}$	$R_\tau^{(2)}$
0.5	0.23	0.34	4.02
1.0	0.12	0.20	3.59
2.0	0.085	0.14	3.42

Table 6.6 The couplant, a , $\tilde{R}_\tau^{(2)}$ and $R_\tau^{(3)}$ for three values of the renormalization point, μ .

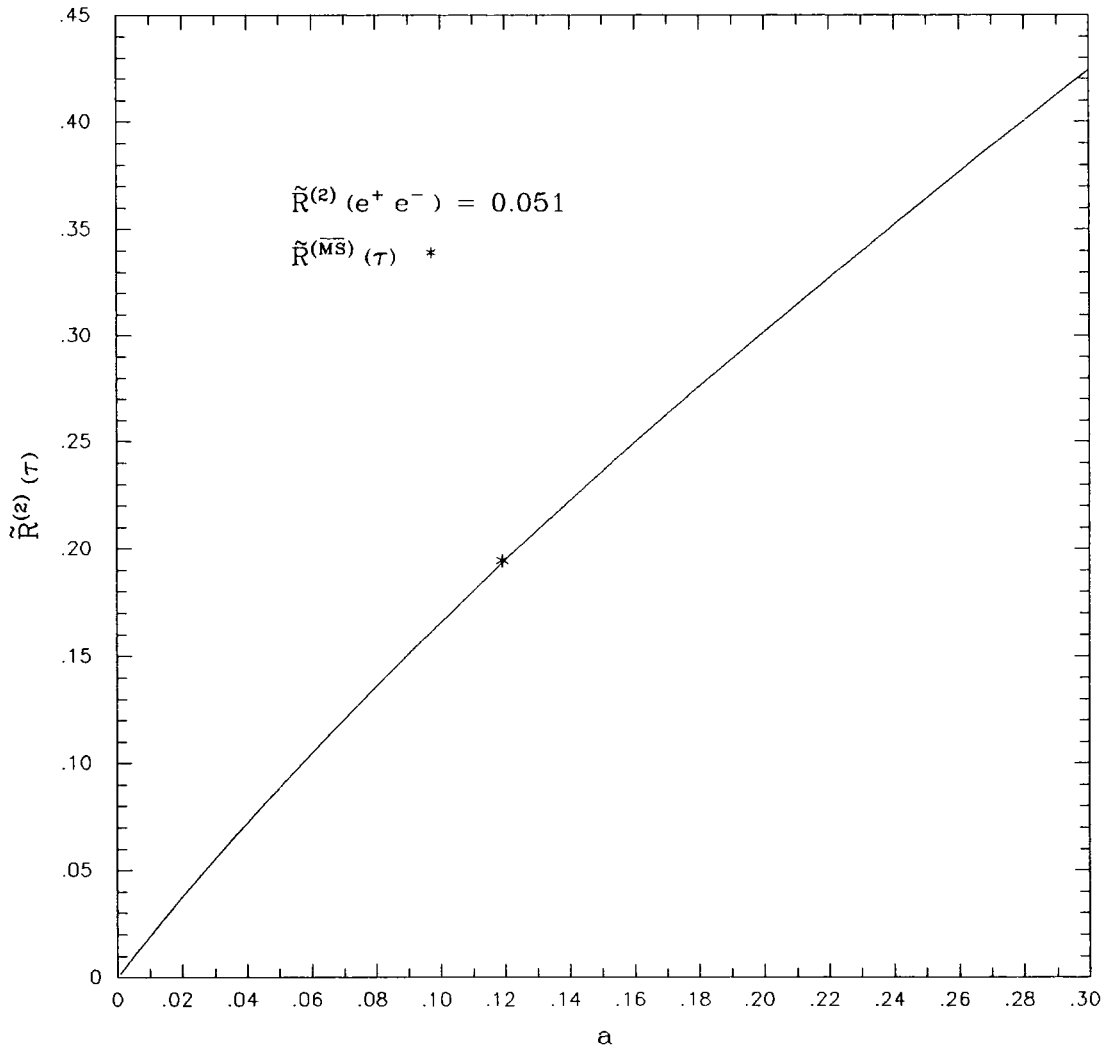

Figure 6.7 $\tilde{R}_\tau^{(2)}$ as a function of the couplant, a , at $\tilde{R}_{e^+e^-} = 0.051$, the central value of the Marshall fit. $\tilde{R}_\tau^{(2)}(\overline{\text{MS}})$ is indicated by an asterisk.

Figure 6.8 shows the surface of $\tilde{R}_\tau^{(3)}$ as a function of a and c_2 , again when $\tilde{R}_{e^+e^-}^{(3)}$ is the central value of the Marshall fit. The $\overline{\text{MS}}$ value is marked, and $\tilde{R}_\tau^{(3)}$ runs from 0.103 to 1.161, or R_τ from 3.3 to 6.483. In both cases there is a monotonic dependence on the scheme parameter, similar to a lowest order calculation.

For this process $\rho_0 = b \ln \left(m_\tau / \tilde{\Lambda}_{\overline{\text{MS}}}^{(3)} \right) - 5.20$, so for $\tilde{\Lambda}_{\overline{\text{MS}}}^{(3)} \gtrsim 560 \text{ MeV}$, $\rho_0 < 0$. If the size of ρ_0 is taken as an indication of whether the calculation is taking place in a perturbative region or not, with large ρ_0 indicating the perturbative region, then this surely shows that a perturbative expansion of R_τ is not reliable. $\rho_2 = 72$, even larger than for $R_{e^+e^-}$, also indicates that the expansion is not

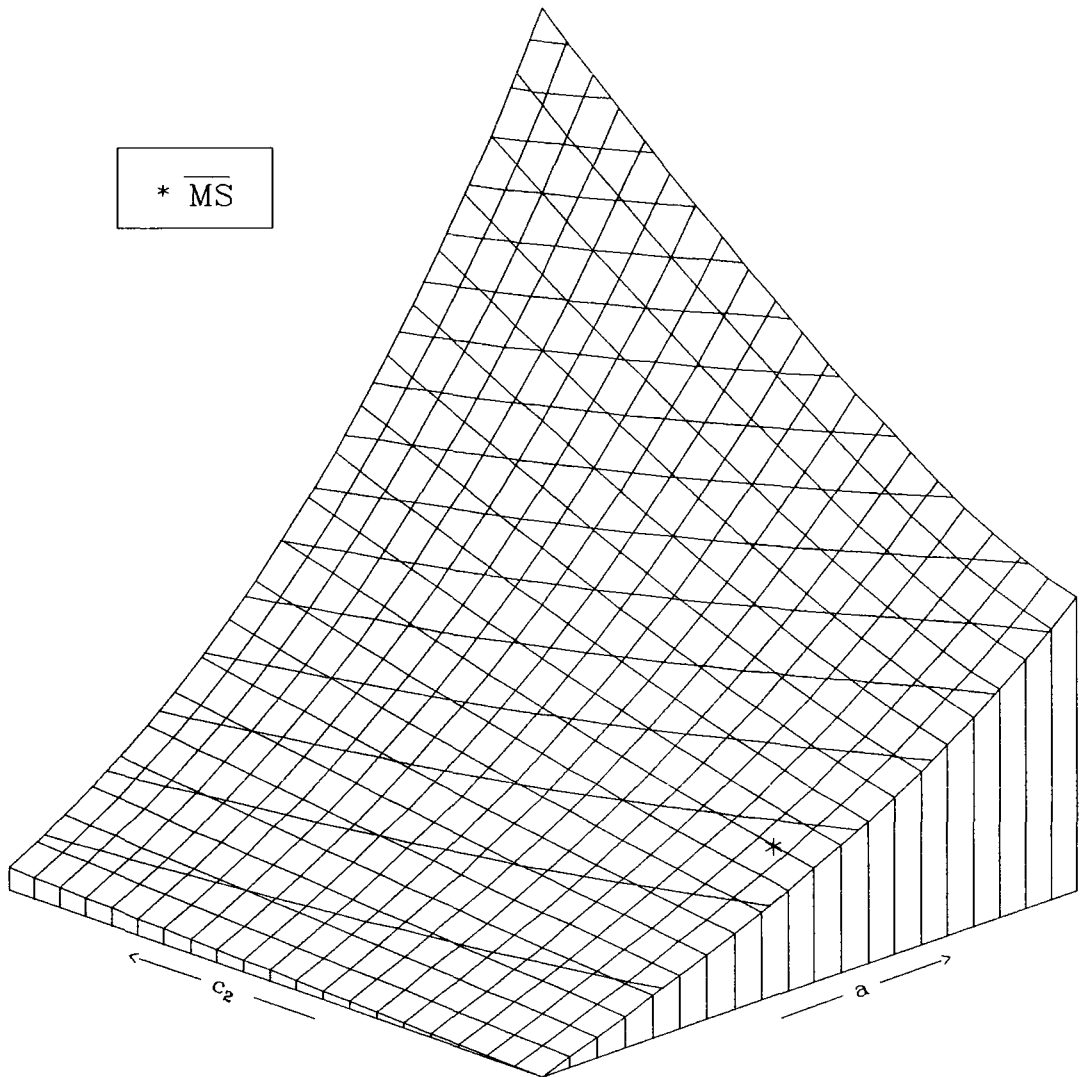

Figure 6.8 $\tilde{R}_r^{(3)}$ as a function of the couplant, a , and the second β -function coefficient, c_2 , with $0.044 \leq a \leq 0.144$ and $-10 \leq c_2 \leq 190$, at $\tilde{R}_{e+e-} = 0.051$. $\tilde{R}_r^{(3)}(\overline{\text{MS}})$ is indicated by an asterisk. The minimum value of $\tilde{R}_r^{(3)}$ for this graph is 0.103, and the maximum is 0.868.

healthy, and serves to hasten the breakdown of the PMS scheme.

For the sake of curiosity, the investigation was repeated for an hypothetical, heavier lepton, HL, of mass 10 GeV. Figures 6.9 – 6.11 show the equivalent graphs to Figures 6.5 – 6.8, and table 6.7 the equivalent to table 6.6. As can be seen, although somewhat better, even at these energies the various optimization schemes are not well behaved. Presumably the mass would have to be a great deal larger before the perturbation expansion was trustworthy.

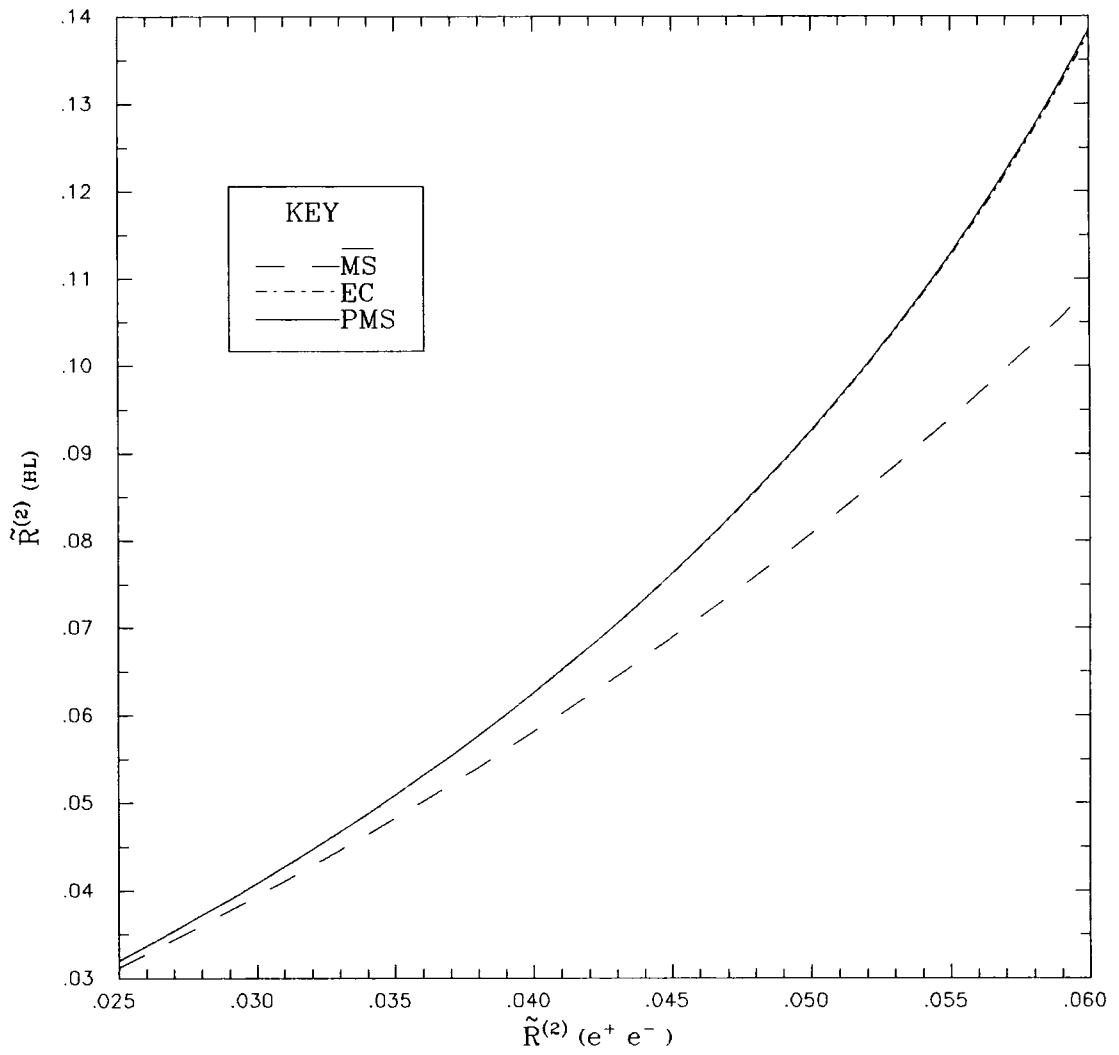

Figure 6.9 \tilde{R}_{HL} vs $\tilde{R}_{e^+e^-}$ at second order for three RS's.

$\frac{\mu}{m_\tau}$	a	$\tilde{R}_{HL}^{(2)}$
0.5	0.0768	0.0918
1.0	0.0628	0.0834
2.0	0.0529	0.0752

Table 6.7 The couplant, a and $\tilde{R}_{HL}^{(2)}$ for three values of the renormalization point, μ .

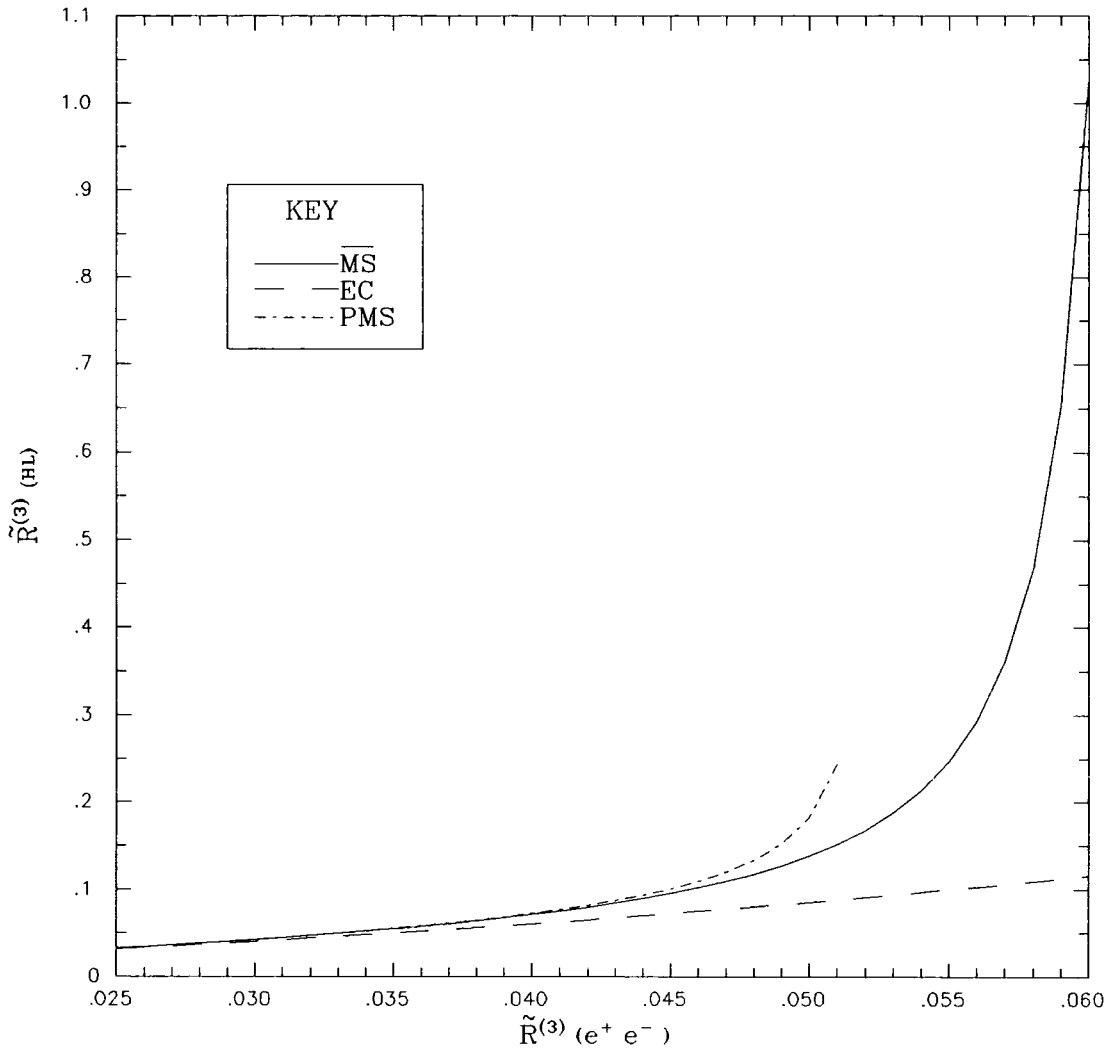

Figure 6.10 \tilde{R}_{HL} vs $\tilde{R}_{e^+e^-}$ at third order for three RS's.

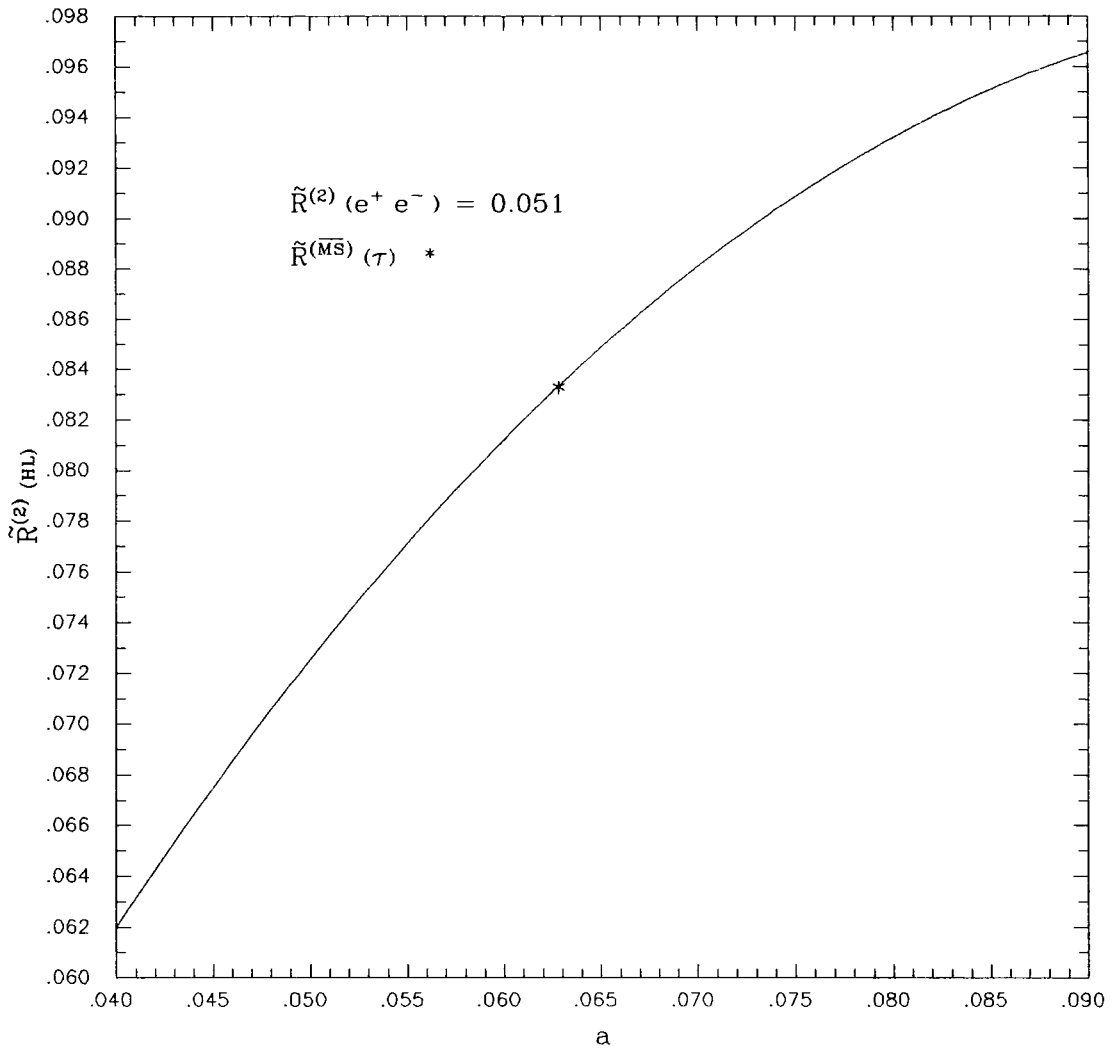

Figure 6.11 $\tilde{R}_{HL}^{(2)}$ as a function of the couplant, a , at $\tilde{R}_{e^+e^-} = 0.051$, the central value of the Marshall fit. $\tilde{R}_{HL}^{(2)\overline{MS}}$ is indicated by an asterisk.

7 ... and QED

7.1 Introduction

In contrast to QCD, perturbation theory in QED appears to be much better behaved, with a few notable exceptions, such as orthopositronium decay. The running couplant is very much smaller, and, due to the extremely large scale parameter, $\Lambda_{\text{QED}} \sim 10^{277}$ GeV, does not vary as rapidly as the running couplant in QCD. Further, the theory is not asymptotically free – the couplant grows with the momentum transfer – and so non-perturbative effects are not expected at low energies, unlike QCD where it is the low energy region in which they dominate.

The preferred scheme in QED, used almost exclusively, is the on-shell, ON, scheme. This scheme is viewed by some as the “natural” scheme in which to calculate any quantity in QED, as they consider it to be physically motivated; it is chosen to be the scheme in which the value of the couplant is the fine structure constant – a physically measurable quantity. However, as briefly mentioned in §3.1, whilst this scheme enjoys remarkable success at low energies, for high energy processes this RS may not be the best one. The fine structure constant is a low energy phenomenon, and to constrain the couplant to this value at energies a few orders of magnitude higher, effectively preventing the couplant from running, is not necessarily the right thing to do. So it makes sense to consider QED in the same light as QCD, and investigate the behaviour of various RSs, the subject of this chapter.

A similar approach will be adopted to the τ decay example, where one physical quantity is found as a function of another, the curves being absolute predictions of the theory, being only process and RS dependent. In this example the famous calculation of the anomalous magnetic moment of the electron, $g - 2$, will be investigated as a function of the fine structure constant, α_{fs} . In fact the expansion parameter used is the fine structure constant divided by π , denoted $a_{\text{fs}} = \alpha_{\text{fs}}/\pi$, but for convenience it will simply be referred to as the fine structure constant.

The scheme invariants in QED are

$$\begin{aligned}
b &= \frac{1}{6} (11C_2(A) - 4N_f T_2(F)) \\
&= -\frac{2}{3} \quad \text{for } N_f = 1 \\
c &= \frac{3}{4},
\end{aligned} \tag{7.1}$$

where the Casimirs are $C_2(A) = 0$ and $T_2(F) = 1$ for $U(1)$, the QED gauge group. b does not appear explicitly in the following discussion since it is τ that is found from the fit to data, as Λ_{QED} is too large to be a convenient parameter. c is independent of N_f because both β_0 and β_1 are linear in this variable for $U(1)$ [12].

7.2 The On-Shell Scheme

If the fine structure constant, a physical quantity, is expressed as a power series in some RS with expansion parameter $a = \frac{e^2}{4\pi^2}$, the couplant of QED,

$$a_{\text{fs}} = a(1 + r_1 a + r_2 a^2 + \dots), \tag{7.2}$$

then the on-shell scheme is the one in which the series coefficients are set to zero, $r_i = 0$. So

$$a_{\text{fs}} = a. \tag{7.3}$$

That is, the on-shell scheme has been constructed so that the value of the couplant given by the β -function in this scheme is the fine structure constant. In other words, the on-shell scheme corresponds to the above defined EC scheme for this process. This implies that the β -function coefficients are the scheme invariants for this quantity, ie

$$\rho_2 \equiv c_2^{\text{ON}} = -\frac{121}{96} \tag{7.4a}$$

$$\rho_3 \equiv c_3^{\text{ON}} \tag{7.4b}$$

etc,

where c_2^{ON} has been calculated by DeRafael and Rosner [43]. No higher β -function coefficients have yet been calculated. An independent check can be

carried out using the explicit expression for ρ_2 in terms of the series and scheme coefficients,

$$\rho_2 = c_2 + r_2 - r_1(r_1 + c), \quad (7.5)$$

see (3.21). These quantities for this process have been calculated in the MS scheme, see [44] and references therein,

$$\begin{aligned} r_{1a_{fs}}^{\text{MS}} &= -\frac{1}{3}(\ln 4\pi - \gamma_E) \\ r_{2a_{fs}}^{\text{MS}} &= -\frac{15}{16} - \frac{1}{4}(\ln 4\pi - \gamma_E) + \frac{1}{9}(\ln 4\pi - \gamma_E)^2 \\ c_{2\text{QED}}^{\text{MS}} &= -\frac{3}{32} \left(1 + \frac{22}{9}N_f \right) \\ &= -\frac{31}{96} \quad \text{for } N_f = 1 \end{aligned} \quad (7.6)$$

The $r_{ia_{fs}}^{\text{MS}}$ are found by calculating vacuum polarization diagrams, see [44] and references therein for more details. c_2^{MS} was calculated by Chetyrkin *et al* [45]. Substituting these values into the expression for ρ_2 does indeed yield $\rho_2 = c_2^{\text{ON}}$. Note that for any other process, like the anomalous magnetic moment of the electron, the on-shell scheme is not the EC scheme. The process will have its own scheme invariants which will define the EC scheme for this process.

Although the next higher order β -function coefficient has been calculated in both the MS and the momentum subtraction, MOM, schemes, a similar calculation has not yet been performed for c_3^{ON} . Nor is it possible to obtain it as the $\mu^2 \rightarrow 0$ limit of c_3^{MOM} , where μ is the renormalization point, as it is not a smooth limit. The lack of this β -function coefficient limits the discussion to third order in all schemes.

7.3 The Fine Structure Constant

In the QCD example, at second and third orders, $\tilde{R}_{e^+e^-}^{(n)}(\text{RS})$ was fitted to data and a value for $\tilde{\Lambda}_{\overline{\text{MS}}}$ was extracted and used to evaluate $\tilde{R}_r^{(n)}(\text{RS})$ to the same order. For this calculation in QED the fine structure constant plays the same rôle as $\tilde{R}_{e^+e^-}$, but as Λ_{QED} is too large to use, the associated quantity, $\tau_{\text{ON}} = b \ln \left(\frac{\mu}{\Lambda_{\text{QED}}} \right)$, is used instead.

The on-shell/EC scheme for this process has been outlined in the preceding section. The $\overline{\text{MS}}$ scheme has the same β -function coefficients as the MS scheme, and its series coefficients may be found by removing all terms involving $(\ln 4\pi - \gamma_E)$ in (7.6), so

$$\begin{aligned} r_{1a_{fs}}^{\overline{\text{MS}}} &= 0 \\ r_{2a_{fs}}^{\overline{\text{MS}}} &= -\frac{15}{16}. \end{aligned} \tag{7.7}$$

Since $r_1^{\text{ON}} = r_1^{\overline{\text{MS}}} = 0$, τ for both schemes is the same:

$$\begin{aligned} \rho_0 &\equiv \tau_{\text{ON}} \\ &= \tau_{\text{RS}} - r_1^{\text{RS}} \\ &= \tau_{\overline{\text{MS}}}. \end{aligned} \tag{7.8}$$

Hence, at second order the on-shell and $\overline{\text{MS}}$ schemes are equivalent, but the correspondence ceases for higher orders. The PMS, PW and $\widetilde{\text{PMS}}$ schemes are found as outlined in Chapter 5. Similar to the τ decay example, a value for a_{fs}^{exp} was chosen, and the scheme invariants were set using the on-shell scheme. τ_{ON} was then adjusted so that $a_{fs}^{(n)}(\text{RS}) = a_{fs}^{\text{exp}}$.

7.4 The Anomalous Magnetic Moment of the Electron

Once τ_{ON} has been found it is used to calculate the scheme invariants for the anomalous magnetic moment of the electron from the on-shell scheme. The expansion for $(g - 2)/2$ was used as this has the form given in (3.13). The results, however, are given for $a_e \equiv g - 2$ for second and third order. Whilst the β -function and series coefficients are both known to fourth order, they have been calculated in different schemes, $c_3^{\overline{\text{MS}}}$ and r_3^{ON} , so it is not possible to find the fourth order scheme invariants. If either c_3^{ON} or $r_3^{\overline{\text{MS}}}$ were known, the story would be different, and calculations to fourth order in all schemes could be carried out.

In the on-shell scheme, Kinoshita is calculating the third and fourth series coefficients [46]. $r_{0a_e}^{\text{ON}}$ and $r_{1a_e}^{\text{ON}}$ are known analytically [47], but $r_{2a_e}^{\text{ON}}$ and $r_{3a_e}^{\text{ON}}$ require numerical integration to be evaluated, which introduces errors. The

most up-to-date values are

$$\begin{aligned}
r_{0a_e}^{\text{ON}} &= \frac{1}{2} \\
r_{1a_e}^{\text{ON}} &= -0.328\,478\,965\dots \\
r_{2a_e}^{\text{ON}} &= 1.175\,62\ (56) \\
r_{3a_e}^{\text{ON}} &= -1.472\ (152)
\end{aligned}
\tag{7.9}$$

where the number in brackets at the end is the estimated accuracy, at the 90% confidence limit, of the numerical integration. Kinoshita gives the coefficients of a_e , and these values are halved to calculate $(g - 2)/2$.

τ_{ON} and the on-shell series coefficients were used to find the scheme invariants, and the other schemes followed in the manner described in Chapter 5. The known β -function coefficients in the $\overline{\text{MS}}$ scheme were used together with the scheme invariants to find the $\overline{\text{MS}}$ series coefficients in a process similar to that of $\widetilde{\text{PMS}}$.

The results are given in figures 7.1 and 7.2 for second and third orders respectively. Notice in figure 7.1 that the curves given by the $\overline{\text{MS}}$ and on-shell schemes are identical, as should be the case. $\widetilde{\text{PMS}}$ and PMS are the same in this order as well. Further, the curves for the optimized schemes are consistently lower than the on-shell scheme and are essentially identical, with the $\overline{\text{MS}}$ scheme somewhere in the middle for third order. On figure 7.2 the two crosses indicate the experimental values, with error bars, of both a_{fs} and a_e . a_{fs} is measured in two ways: from the quantum Hall effect [48], and from the Josephson frequency and the proton gyromagnetic ratio, γ'_p [49]:

$$\begin{aligned}
a_{\text{fs}}(\text{QHE}) &= 2.322\,819\,486\ (56) \times 10^{-3} \\
a_{\text{fs}}(\text{acJ and } \gamma'_p) &= 2.322\,819\,841\ (130) \times 10^{-3}.
\end{aligned}
\tag{7.10}$$

The anomalous magnetic moment of the electron is [50]

$$a_e = 1.159\,652\,188\,4\ (43) \times 10^{-3}
\tag{7.11}$$

Clearly more experimental work needs to be done to bring the errors on a_{fs} down to those on a_e .

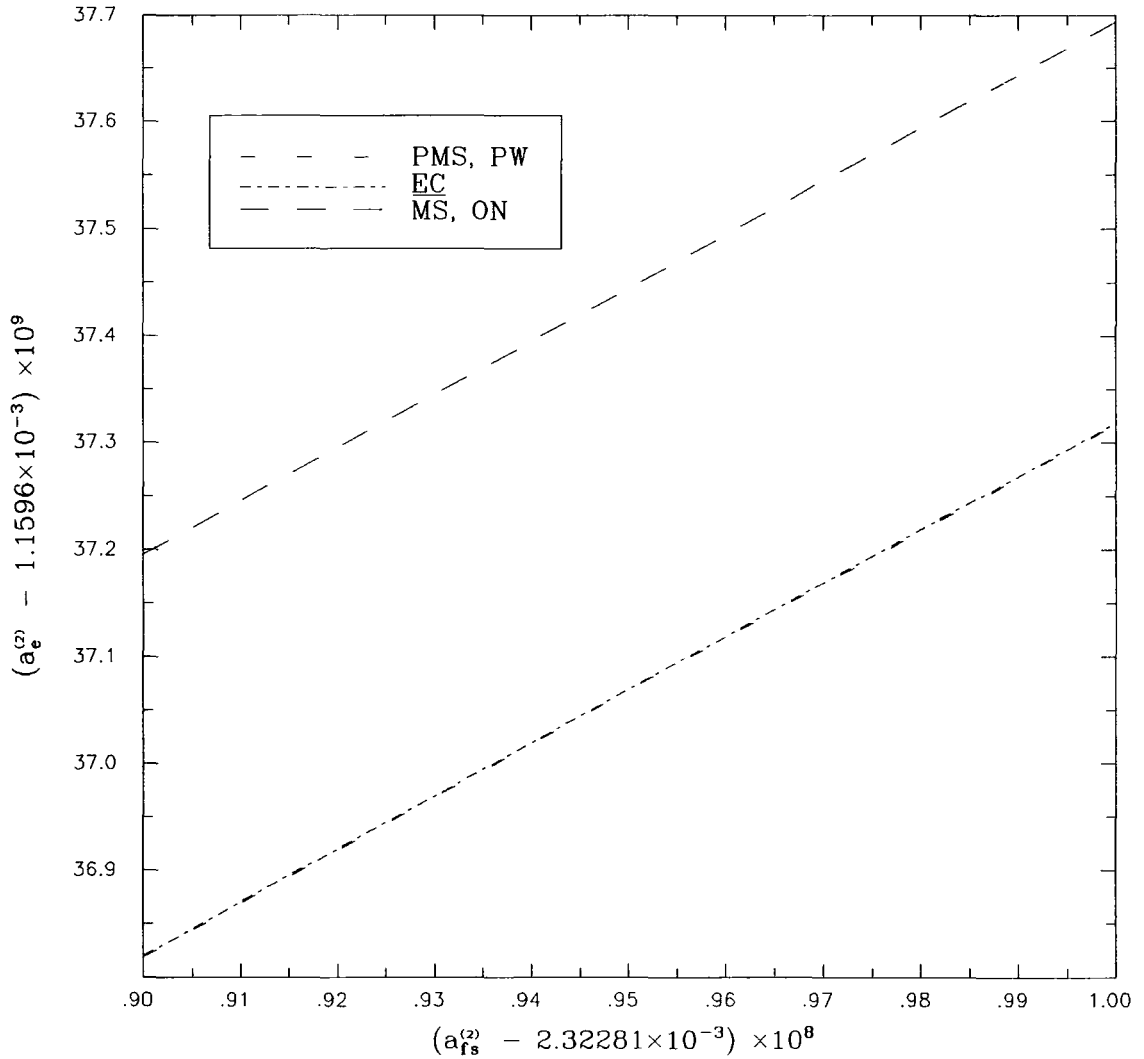

Figure 7.1 The second order approximants to the anomalous magnetic moment of the electron, $a_e^{(2)}$, for five RS's are plotted as a function of the fine structure constant, a_{fs} . Note that the \overline{MS} and ON approximants are identical as they should be at this order.

Figure 7.3 is analogous to figure 6.2 – the surface of $a_e^{(3)}$ as a function of the couplant, a , and the third order β -function coefficient, c_2 , with the predictions of the various schemes marked. Although the surface looks as steep as figure 6.2, this is merely an effect of the exaggerated scale. In figure 6.2 the value of $\tilde{R}_{e^+e^-}^{(3)}$ ranges from 3.75×10^{-2} to 7.09×10^{-2} – a factor of 2 difference, whilst in figure 7.3 the range is from $1.159\,645\,97 \times 10^{-3}$ to $1.159\,657\,96 \times 10^{-3}$ – a variation of only 0.001%. So figure 7.3 is extremely flat.

Some people believe that by optimizing the scheme, some $(n + 1)^{th}$ order effects can be included at n^{th} order. Figure 7.2 appears to support this claim

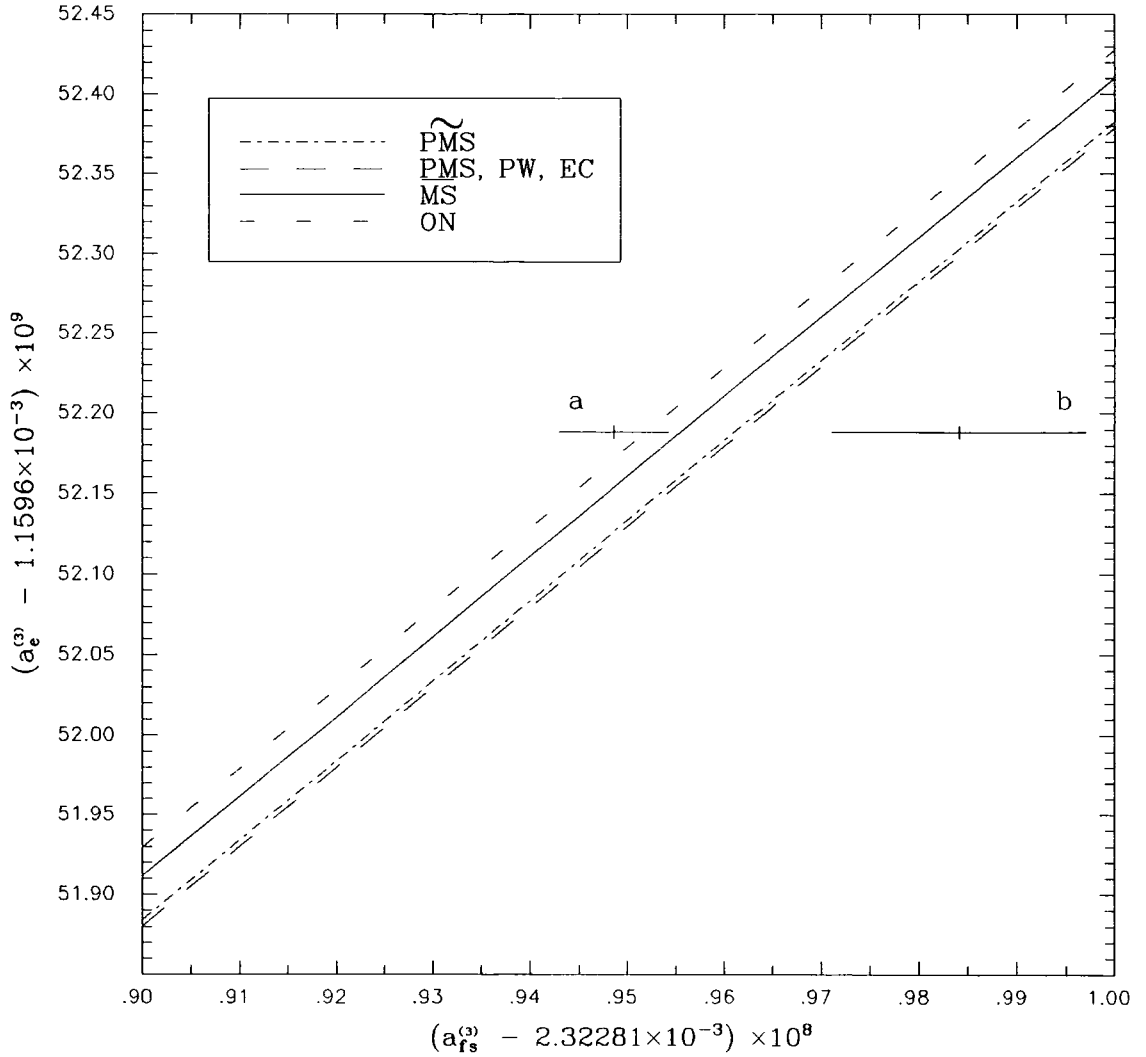

Figure 7.2 The third order approximants to the anomalous magnetic moment of the electron, $a_e^{(3)}$, for six RS's are plotted as a function of the fine structure constant, a_{fs} . Data point a is that measured from the quantum Hall effect, while data point b is measured from the Josephson frequency and the proton gyromagnetic ratio. As at second order, the optimized approximants, to this accuracy, are identical, with the exception of $\widetilde{\text{PMS}}$.

as the optimized schemes all lie together at a lower value than either the $\overline{\text{MS}}$ or on-shell values. By taking $a_e^{(3)}$ (PMS, EC) to be the value of $a_e^{(4)}$ (ON), a fit for $r_{3a_e}^{\text{ON}}$ can be made. The value obtained is $r_{3a_e}^{\text{ON}} = -1.69$ – close to the Kinoshita value of -1.472 (152). However, the same procedure, repeated at second order, produces a coefficient of the wrong sign. To repeat the procedure to estimate $r_{4a_e}^{\text{ON}}$ would require an extremely accurate knowledge of $r_{3a_e}^{\text{ON}}$, and the, as yet unknown, c_3^{ON} .

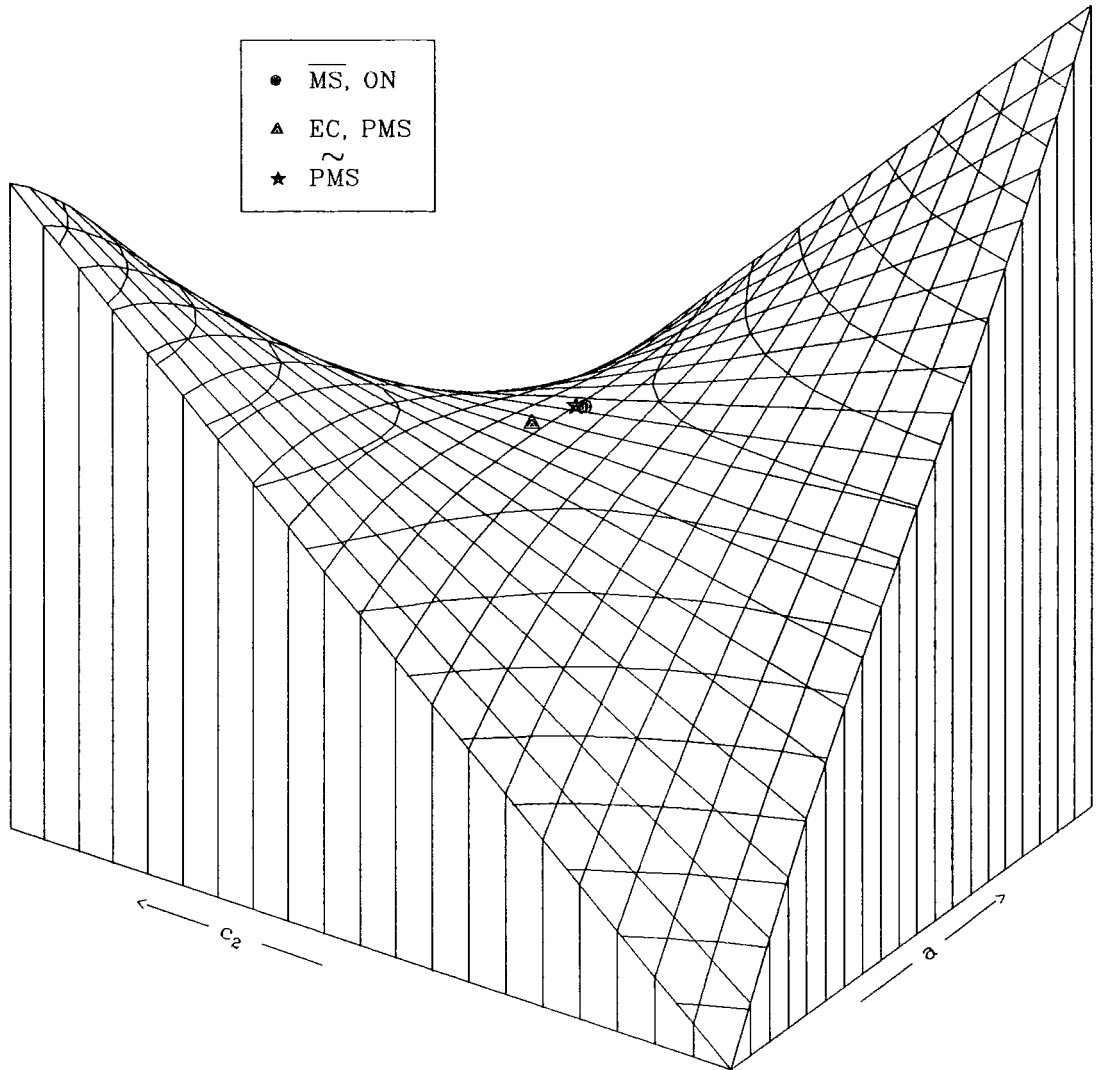

Figure 7.3 $a_e^{(3)}$ as a function of the couplant, a , and the second β -function coefficient, c_2 , with $2.3 \times 10^{-3} \leq a \leq 2.34 \times 10^{-3}$ and $-50 \leq c_2 \leq 50$. The values predicted by PMS, EC, $\overline{\text{MS}}$, ON and $\widetilde{\text{PMS}}$ are indicated. The minimum value of $a_e^{(3)}$ is $1.159\,645\,97 \times 10^{-3}$ and the maximum value is $1.159\,657\,96 \times 10^{-3}$.

7.5 Conclusion

It appears that in QED the renormalization ambiguity is far less of a problem, and perturbation theory in general is far better behaved, than in QCD. Using the couplant, a , as the expansion parameter presents fewer problems in QED than in QCD. a_{QED} is smaller and varies less rapidly as a function of the momentum transfer than its QCD counterpart. This in turn means that $O(a_{\text{QED}}^{(n)})$ corrections will be small as long as the coefficient is small, unlike QCD where terms of $O(a_{\text{QCD}}^{(n)})$ represent significant contributions.

... In QED perturbation theory appears well behaved at low orders. This is not so in QCD where confinement produces non-perturbative effects at low energies, and even at low orders, perturbation theory goes awry.

However, some problems do exist in QED. For example, the expansion for orthopositronium decay has a large second order coefficient, $r_1 = 10.266(8)$ [51]. Brodsky, Lepage and MacKenzie [52] suggest using these large coefficients as the basis for solving the scheme dependence problem. The coefficients correspond to vacuum polarization diagrams, and Brodsky *et al* propose a scheme in which the vacuum polarization diagrams don't contribute to the series coefficients, but are entirely absorbed into the couplant. However, as pointed out by Celmaster and Stevenson [53], this does not define a unique scheme, so the problem of choosing the RS is not solved.

Despite these few awkward expansions, QED is remarkably free of the problems that plague QCD, and remains the crowning achievement of gauge theories, with the $g - 2$ calculation the central jewel.

Conclusion

A major summary, presenting the conclusions on the theoretical aspect of this thesis, was given in §4.11. These were that, given a free choice of RS order by order, the resulting limit of a perturbative expansion is totally arbitrary and therefore, if a finite, perturbatively unique sum of the series is to be achieved, some restriction on the choice of RS is necessary.

Allowing only finite schemes, and in particular the zero schemes, it can be shown that only if the perturbation series in some fixed scheme is Borel summable can a finite, perturbatively unique limit exist. Apart from a few subtleties, it was shown that, (4.118),

$$R_{lim} = \int_0^{\frac{1}{\chi}} du e^{-\frac{u}{a(\tau)}} F_B^0(u, \tau),$$

where $F_B(u, \tau)$ is the Borel transform of the series in some fixed scheme. The upper limit of integration is given by the rate at which the renormalization point, τ_n , grows for large n , that is $1/\chi = \lim_{n \rightarrow \infty} n/\tau_n$.

A practical method, $\widetilde{\text{PMS}}$, for choosing the sequence of τ_n such that they yield the correct large n behaviour was discussed. This involves the application of PMS to the ZS, that is, choosing τ_n at each order so that the approximants are minimally sensitive to changes in the RS. For $c = 0$ it was shown graphically that the limit found using this method is the maximum limit obtainable. Apart from a few unproved assumptions, the discussion was generalized to the case of non-zero c and other finite schemes.

A few phenomenological examples were presented in both QED and QCD. As expected, the QED example showed little scheme dependence – a totally different situation from QCD. Even for the $\tilde{R}_{e^+e^-}$ ratio, supposedly *the* test of perturbative QCD, at third order there is a strong scheme dependence. This problem is so great for the analogous ratio, \tilde{R}_τ , defined in τ decay, that it was concluded that perturbation theory is not reliable for a lepton with mass 1800 MeV. Even for an hypothetical lepton with mass 10 GeV the problem is still severe and perturbation theory untrustworthy.

References

1. G. Grunberg, *Phys Lett.* **B95**, 70 (1980).
G. Grunberg, *Phys. Rev.* **D29**, 2315 (1984).
2. M.R. Pennington, *Phys. Rev.* **D26**, 2048 (1982).
3. J.C. Wrigley, *Phys. Rev.* **D27**, 1965 (1983).
4. P.M. Stevenson, *Phys. Rev.* **D23**, 2916 (1981).
5. D. Bailin and A. Love, in *Introduction to Gauge Field Theory* (Adam Hilger, Bristol, 1986).
6. C. Itzykson and J-B. Zuber, in *Quantum Field Theory* (McGraw-Hill, Singapore, 1985).
7. P.M. Stevenson, COO-881-144 (1980).
8. F. Dyson, *Phys. Rev.* **85**, 631 (1952).
9. L.N. Lipatov, *Sov. Phys. JETP* **45**, 216 (1977).
10. K.G. Chetyrkin, S.G. Gorishny, S.A. Larin and F.V. Tkachov, *Phys. Lett.* **B132**, 351 (1983).
11. D.I. Kazakov, *Phys. Lett.* **B133**, 406 (1983).
12. S.G. Gorishny, A.L. Kataev and S.A Larin, *Phys. Lett.* **B194**, 429 (1987).
13. E.B. Bogomolny and V.A. Fatayev, *Phys. Lett.* **B71**, 93 (1977).
14. A.J. Buras, E.G. Floratos, D.A. Ross and C.T. Sachrajda, *Nucl. Phys.* **B131**, 308 (1977).
W.A. Bardeen, A.J. Buras, D.W. Duke and T. Muta, *Phys. Rev.* **D18**, 3998 (1978).
15. E.C.G. Stueckelberg and A. Peterman, *Helv. Phys. Acta* **26**, 499 (1953).
16. A. Dhar, *Phys. Lett.* **B128**, 407 (1983).
17. W. Celmaster and R.J. Gonsalves, *Phys. Rev.* **D20**, 1420 (1979).
18. C.J. Maxwell, *Phys. Rev.* **D28**, 2037 (1983).
19. J. McMahon, *Bull. Am. Math. Soc.* **III**, 170 (1894).

20. G.D. West, LA-UR-89-3785 (1989).
21. P.M. Stevenson, *Nucl. Phys.* **B231**, 65 (1983).
22. A.L. Kataev and M.D. Vardiashvili, *Phys. Lett.* **B221**, 377 (1989).
23. G. 't Hooft, in *Deeper Pathways in High Energy Physics*, proceedings of the Orbis Scientiae, 1977, Coral Galbes, Florida, edited by A. Perlmutter and L. F. Scott (Plenum, New York, 1977); in *The Whys of Subnuclear Physics*, proceedings of the International School of Subnuclear Physics, Erice, 1977, edited by A. Zichichi (Plenum, New York, 1979).
24. C. Burdick and J. Chyla, JINR-E2-87-325 (1987).
25. C.J. Maxwell, *Phys. Lett.* **126B**, 94 (1983).
26. G. 't Hooft, *Nucl. Phys.* **B61**, 455 (1973).
27. A.H. Mueller, *Nucl. Phys.* **B250**, 327 (1985).
28. S.G. Gorishny, A.L. Kataev and S.A. Larin, *Phys. Lett.* **B212**, 238 (1988).
29. R.N. Faustov, S.G. Gorishny, A.L. Kataev, S.A. Larin and V.V. Starshenko, TIFR/TH/90-8 (1990).
30. S.G. Gorishny, A.L. Kataev, S.A. Larin and L.R. Surguladze, TIFR/TH/90-9 (1990).
31. C.J. Maxwell and J.A. Nicholls, *Phys. Lett.* **B213**, 217 (1988).
32. R. Marshall, *Z. Phys.* **C43**, 595 (1989).
33. M.L. Perl, *Annu. Rev. Nucl. Part. Sci.* **30**, 299 (1980).
34. E. Braaten, *Phys. Rev. Lett.* **60**, 1606 (1988).
35. E. Braaten, *Phys. Rev.* **D39**, 1458 (1989).
36. S. Narison and A. Pich, *Phys. Lett.* **B211**, 183 (1988).
37. W.J. Marciano and A. Sirlin, *Phys. Rev. Lett.* **61**, 1815 (1988).
38. J. Pumplin, *Phys. Rev.* **D41**, 900 (1990).
39. C.J. Maxwell and J.A. Nicholls, *Phys. Lett.* **B236**, 63 (1989).
40. T. Appelquist and J. Carazzone, *Phys. Rev.* **D11**, 2856 (1975).
41. W. Bernreuther and W. Wetzel, *Nucl. Phys.* **B197**, 228 (1983).

42. J. Collins, in *Renormalization* (Cambridge University Press, Cambridge, 1984).
43. E. DeRafael and J.L. Rosner, *Ann. Phys.* **82**, 369 (1974).
44. J. Kubo and S. Sakakibara, *Zeit. Phys.* **C14**, 345 (1982).
45. K.G. Chetyrkin, A.L. Kataev and F.V. Tkachov, *Nucl. Phys.* **B174**, 345 (1980).
46. T. Kinoshita, CERN-TH 5097/88 (1988).
47. J. Schwinger, *Phys. Rev.* **73**, 416 (1948).
 C. Sommerfield, *Phys. Rev.* **107**, 328 (1957).
 A. Petermann, *Helv. Phys. Acta* **30**, 407 (1957).
48. M.E. Cage *et al*, presented at the 1988 Conference on Precision Electromagnetic Measurements, Tsukuba, Japan, June 7-10, 1988.
49. E.R. Williams *et al*, presented at the 1988 Conference on Precision Electromagnetic Measurements, Tsukuba, Japan, June 7-10, 1988.
50. R.S. Van Dyck, Jr, P.B. Schwinberg and H.G. Dehmelt, *Phys. Rev. Lett.* **59**, 26 (1987).
51. G.P. Lepage, CLNS 80/474 (1980) A talk presented at the Seventh International Conference on Atomic Physics, Cambridge, Mass., August 1980.
52. S.J. Brodsky, G.P. Lepage and P.B. Mackenzie, *Phys. Rev.* **D28**, 228 (1983).
53. W. Celmaster and P.M. Stevenson, *Phys. Lett.* **125B**, 439 (1983).
54. W. Marciano and H. Pagels, *Phys. Rep.* **36C**, 57, (1978).
55. C.J. Maxwell, *Phys. Rev.* **D29**, 2884, (1984).

